

The logo for Port Orchard features the word "Port" in a light blue script font, positioned above the word "ORCHARD" in a bold, dark blue sans-serif font. Below the text are two wavy lines, one light blue and one green, that sweep across the width of the text.

# Port ORCHARD

Signage and  
Wayfinding  
Development  
City of Port Orchard  
Washington  
Contract No. 034-14

Submitted by  
Ambrosini Design  
1st of December 2015

## Goals of the Wayfinding / Signage System

We are pleased to present the **Port Orchard Signage / Wayfinding Design Standards Guidelines**. In developing these standards, we have pursued the following goals and objectives:

- To develop an effective wayfinding system for pedestrians, vehicles, and short-term parking users that functions as an integral part of the city's urban environment.
- To use wayfinding to express Port Orchard's unique culture, philosophy, and image as it guides visitors to key destinations.

### The wayfinding system will:

- Provide effective wayfinding for pedestrians and vehicles between major destinations throughout the city.
- Cultivate an overall **"Sense of Place"** for the community.
- Enhance and reinforce the unique experience for residents and visitors as they navigate the city.
- Enhance and reinforce the boundaries of the city with gateway and identity treatments.
- Work in conjunction with existing signage and enhance the overall wayfinding system.
- Provide all necessary information in a clear, concise, and minimal manner, while not adding to visual clutter.
- Be cost effective.
- Be programmed and designed for phased implementation.
- Allow for ease of updating and maintenance.

This manual should be used as a basic guide by city staff, consultants and fabricators engaged in the planning, design, fabrication, installation and maintenance of the sign system. The manual provides necessary drawings and details required to implement the signage/wayfinding system. Adherence to the standards in this manual will ensure consistency and a common visual language throughout the city. This manual is organized into sections: Programming, Graphic Standards, and Drawings of each sign type.

An effective signage/wayfinding system functions not as a separate entity but as an integral part of its environment. Carefully planned signs communicate essential information while also enhancing the urban environment.

As the visual introduction to the community, signs play a prominent role in defining the city's identity and boundaries. Caution and restraint must be observed in the final placement of signs. The phrase **"less is more"** is relevant in the context of signage/wayfinding for an urban system. Over signing community will create visual clutter and ultimately communicate less information to the user.

For this wayfinding design manual to function as intended, signs should be added only with a comprehensive review of the sign family and how each new sign will impact the overall system and streetscape. If this premise is followed, the signs will form a cohesive system that unites districts, provides visual continuity and enables the visitor to navigate the city with ease.

The Design Manual comprehensively details the correct use of the, typography, colors and the family of signs that comprise the wayfinding program. Feedback from the city and development staff is encouraged for successful implementation of this Wayfinding Design Manual.

Graphic references to history and community have been considered as an important visual element not only in wayfinding but also, in defining the city to the public. Sign materials and finishes have been selected for their longevity in the marine environment. A regional color family has been selected to provide a comprehensive graphic visual language for Port Orchard.

The sign system has been designed to help first time and infrequent visitors with wayfinding and to define the city's boundaries.

Arrival Signage is important to establish a **"Sense of Place"**. As a portal, Gateway Signage reinforces Port Orchard's rich history and reflects the community's future vision.

Through thoughtful use of this wayfinding design manual, signage and wayfinding will reinforce the link between the city, the community and the region.



1. LOGO: Refer to Graphic Standards Manual for complete logo guidelines



2. GRAPHIC ELEMENT: Compass Rose



3. PROJECT ARROWS: The project graphic designer will provide vector artwork for the approved arrow.



4. INTERNATIONAL SYMBOLS: The project graphic designer will provide final outlined artwork for the International Symbols.

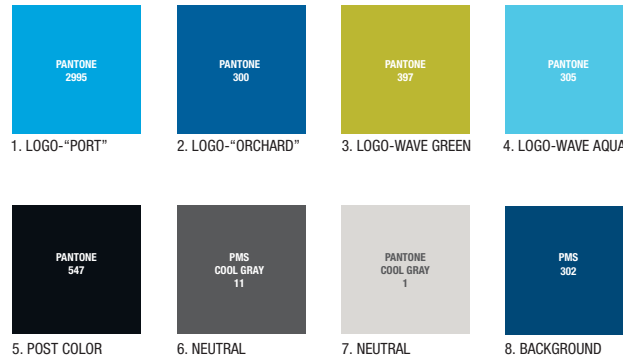

5. PRIMARY COLOR PALETTE

1234567890  
 ABCDEFGHIJKLMNOPQRSTUVWXYZ  
 abcdefghijklmnopqrstuvwxyz  
 FONT: INTERSTATE-REG. CONDENSED

0 1 2 3 4 5 6 7 8 9  
 ABCDEFGHIJKLMNOPQRSTUVWXYZ  
 abcdefghijklmnopqrstuvwxyz  
 FONT: FRANKLIN BOOK GOTHIC

1234567890  
 ABCDEFGHIJKLMNOPQRSTUVWXYZ  
 abcdefghijklmnopqrstuvwxyz  
 FONT: INTERSTATE-BOLD CONDENSED

0 1 2 3 4 5 6 7 8 9  
 ABCDEFGHIJKLMNOPQRSTUVWXYZ  
 abcdefghijklmnopqrstuvwxyz  
 FONT: FRANKLIN DEMI GOTHIC

6. PROJECT APPROVED FONTS

It is the Fabricator's responsibility to match all colors, finishes and materials specified in this document.

Please note that visual accuracy of the colors and finishes represented in this document may not be consistent with actual manufacturer's swatches and samples due to limitations of color printing technology.

The Fabricator is required to appropriate actual color swatches and material samples from the manufacturer.

If a substitute or deviation is recommended by the Fabricator, the recommendation shall be proposed in writing with a demonstration of equal or better value for consideration by the City of Port Orchard.



P1. FABRICATED PAINTED METAL LETTERS WITH STAND-OFFS



P2. FABRICATED PAINTED METAL LETTERS W/O STAND-OFFS



P3. FLAT CUT-OUT METAL LETTERS WITH STAND-OFFS

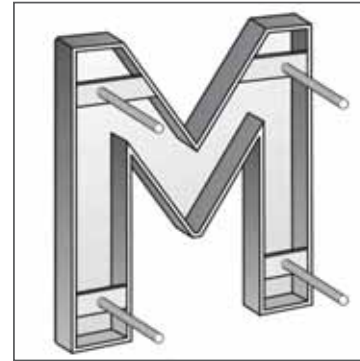

P4. STRIP MOUNTED METAL STUDS OF FABRICATED LETTER



P5. BOARD FORMED CONCRETE



P6. STAMP PATTERN IN CONCRETE - NO COLOR



P7. BOARD FORMED CONCRETE - TEXTURE



P8. STAMP PATTERN IN CONCRETE - NO COLOR



P9. WEATHERED STEEL - LANDSCAPING EDGE



P10. OCEAN GRANITE - LANDSCAPE COVER

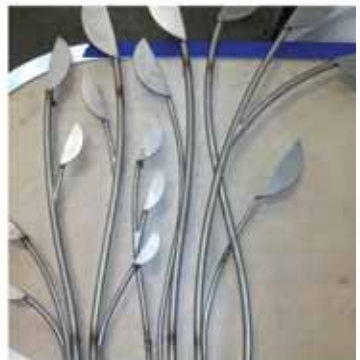

P11. METAL FORMED INTO INTERWOVEN PATTERN



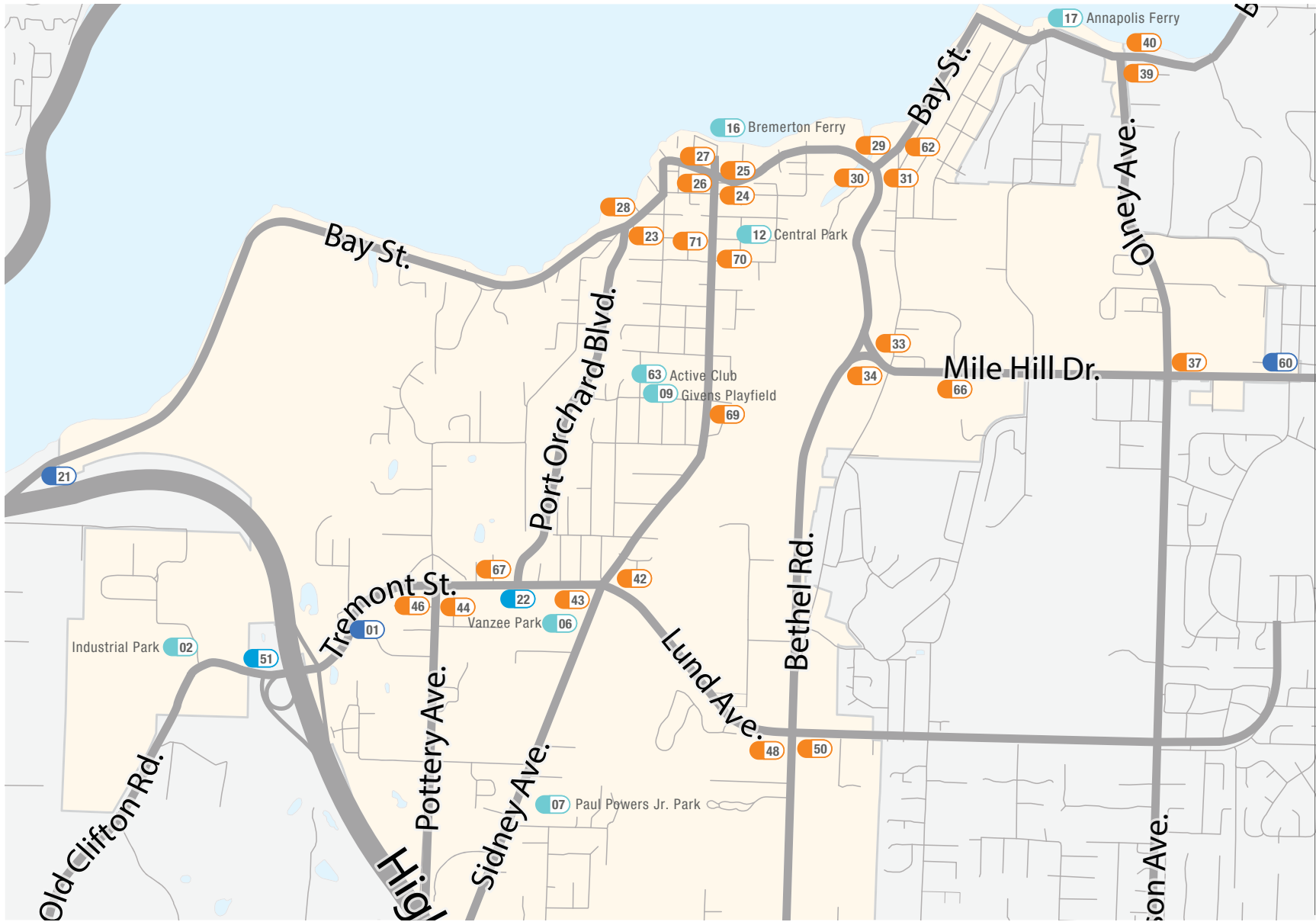

P12. EXPOSED AGGREGATE WITH PATTERN

NOTE:  
Photo examples of materials, finishes and fabrication details that pertain to the project.



LEGEND:

-  Monument Gateway Sign: G3.2 / G3.3
-  Trailblazer Primary Sign: G3.5
-  Vehicular Destination Sign: G3.4
-  Vehicular Directional Sign: G3.6

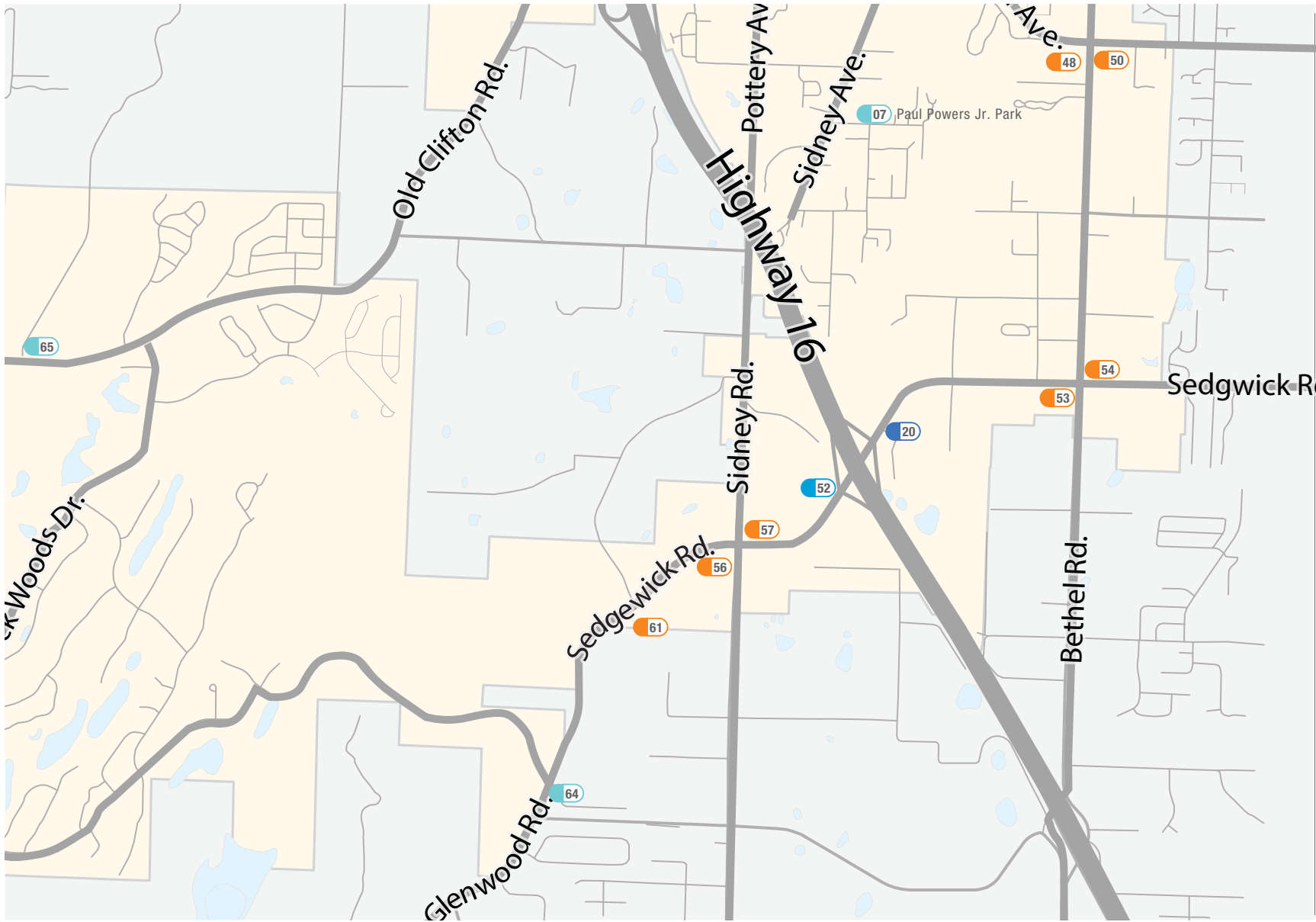





LEGEND:

-  Monument Gateway Sign:  
G3.2 / G3.3
-  Trailblazer Primary Sign:  
G3.5
-  Vehicular Destination Sign:  
G3.4
-  Vehicular Directional Sign:  
G3.6







Sign No.	Type	Message	Location	Traffic Direction
01	Monument Gateway	Welcome to Port Orchard	Roundabout at Tremont & S. Kitsap Blvd	EB
02	Destination Sign	Industrial Park	Old Clifton Rd. & Lloyd Parkway	
03				
04				
05				
06	Destination Sign	Vanee Park	Tremont St. & Sidney Ave.	
07	Destination Sign	Paul Powers Park	Sidney Ave. & Granat Rd.	
08				
09	Destination Sign	Givens Playfield	Sidney Ave. & Kendall St.	
10				
11				
12	Destination Sign	Central / Clayton Park	Dwight St. & Harrison Ave.	
13				
14				
15				
16	Destination Sign	Bremerton Foot Ferry	Right in front of the terminal	
17	Destination Sign	Annapolis Foot Ferry	Beach Dr.	
18				
19				
20	Monument Gateway	Welcome to Port Orchard	Roundabout at Sedgwick & Bravo Terr.	EB
21	Monument Gateway	Welcome to Port Orchard	Hwy. 16 & Bay St.	EB

LEGEND:

-  Monument Gateway Sign: G3.2 / G3.3
-  Trailblazer Primary Sign: G3.5
-  Vehicular Destination Sign: G3.4
-  Vehicular Directional Sign: G3.6

Sign No.	Type	Message		Location	Traffic Direction
22	Trailblazer Primary	Downtown / Waterfront Bremerton Foot Ferries City Hall / Police Kitsap County Courthouse	← ← ← ↑	Tremont St. & Port Orchard Blvd.	EB
23	Vehicular Directional	Downtown / Waterfront Bremerton Foot Ferries City Hall/Police (4th Item TBD)	→ → → ⇒	Bay St. & Port Orchard Blvd.	NB/EB
24	Vehicular Directional	Bremerton Foot Ferry Library Annapolis Foot Ferry Port Orchard High School	↑ ↑ → →	Bay St. & Sidney Ave.	NB
25	Vehicular Directional	City Hall/Police Bremerton Foot Ferry Library Kitsap County Courthouse Museum (TBD)	↑ → → ← ↕	Bay St. & Sidney Ave.	WB
26	Vehicular Directional	Bremerton Foot Ferry Library Kitsap County Courthouse South Kitsap High School	← ← → ↑	Bay St. & Sidney Ave.	EB
27	Vehicular Directional	Kitsap County Courthouse City Hall/Police Kitsap County High School Annapolis Foot Ferry	↑ → ← ←	Bay St. & Sidney Ave.	SB
28	Vehicular Directional	To SR 16 Gorst To SR 3 Bremerton To SR 16 South to Tacoma (OPTIONAL: Naval Base Kitsap)	↑ ↑ ← ↑	Bay St. & Port Orchard Blvd.	WB
29	Vehicular Directional	Downtown Bremerton Foot Ferry City Hall / Police Kitsap County Courthouse	→ → → →	Bay St. & Bethel Rd.	WB
30	Vehicular Directional	Annapolis Foot Ferry South Kitsap High School	← ←	Bay St. & Bethel Rd.	EB
31	Vehicular Directional	Downtown City Hall / Police Bremerton Foot Ferry Annapolis Foot Ferry	↑ ↑ ↑ →	Bay St. & Bethel Rd.	NB
32					





LEGEND:

-  Monument Gateway Sign:  
G3.2 / G3.3
-  Trailblazer Primary Sign:  
G3.5
-  Vehicular Destination Sign:  
G3.4
-  Vehicular Directional Sign:  
G3.6



Sign No.	Type	Message	Location	Traffic Direction
33	Vehicular Directional	Downtown / Waterfront Bremerton Foot Ferries City Hall / Police Kitsap County Courthouse	→ → → →	Mile Hill Dr. East of Bethel Roundabout WB
34	Vehicular Directional	Downtown / Waterfront Bremerton Foot Ferries City Hall / Police South Kitsap High School	↑ ↑ ↑ →	Mile Hill Dr. & Bethel Rd. NB
35				
36				
37	Vehicular Directional	Downtown Bremerton Foot Ferry Annapolis Foot Ferry City Hall / Police	↑ ↑ → ↑	Mile Hill Dr. & Oney NE EB
38				
39	Vehicular Directional	Downtown Bremerton Foot Ferries City Hall / Police Kitsap County Courthouse	← ← ← ←	Beach Dr. & Olney Ave. NB
40	Vehicular Directional	Welcome to Port Orchard		Beach Dr. & Olney Ave. WB
41				
42	Vehicular Directional	Downtown / Waterfront Bremerton Foot Ferries City Hall / Police Kitsap County Courthouse	→ → → →	Lund Ave. & Sidney Ave. WB
43	Vehicular Directional	Downtown / Waterfront Bremerton Foot Ferries City Hall / Police Kitsap County Courthouse (Library and Givens TBD)	← ← ← ← ←	Tremont St. & Sidney Ave. EB
44	Vehicular Directional	Downtown / Waterfront Bremerton Foot Ferries City Hall / Police Kitsap County Courthouse	→ → → →	Pottery Ave. & Tremont St. NB
45				





LEGEND:

-  Monument Gateway Sign:  
G3.2 / G3.3
-  Trailblazer Primary Sign:  
G3.5
-  Vehicular Destination Sign:  
G3.4
-  Vehicular Directional Sign:  
G3.6







Sign No.	Type	Message	Location	Traffic Direction
46	Vehicular Directional	Downtown / Waterfront Bremerton Foot Ferries City Hall / Kitsap County Courthouse Cedar Heights Jr. High	↑ ↑ ↑ →	Pottery Ave. & Tremont St. EB
47				
48	Vehicular Directional	Downtown / Waterfront Bremerton Foot Ferries City Hall / Police South Kitsap Regional Park	← ← ← ↑	Lund Ave. & Bethel Rd. EB
49				
50	Vehicular Directional	Downtown / Waterfront Bremerton Foot Ferries Kitsap County Courthouse South Kitsap Regional Park	↑ ↑ ← →	Bethel Rd & Lund Ave NB
51	Trailblazer Primary	Downtown / Waterfront McCormick Woods / Golf Course	→ ←	Hwy. 16 & Tremont St. NB
52	Trailblazer Primary	Downtown / Waterfront McCormick Woods / Golf Course	← →	Hwy. 16 & Glenwood Dr. SB
53	Vehicular Directional	Downtown / Waterfront Bremerton Foot Ferries City Hall / Police Kitsap County Courthouse	← ← ← ←	Sedgwick Rd. & Bethel Rd. EB
54	Vehicular Directional	Downtown / Waterfront Bremerton Foot Ferries City Hall / Police Kitsap County Courthouse	→ → → →	Sedgwick Rd. & Bethel Rd. WB
55				
56	Vehicular Directional	Downtown / Waterfront Bremerton Foot Ferries City Hall / Kitsap County Courthouse Cedar Heights Jr. High	← ← ← ←	Sedgwick Rd. & Sidney Rd. EB
57	Vehicular Directional	Downtown / Waterfront City Hall / Police Kitsap County Courthouse McCormick Woods / Golf Course	→ → → ↑	Sedgwick Rd. & Sidney Rd. WB
58				
59	Trailblazer Primary	Downtown / Waterfront Bremerton Foot Ferries City Hall / Kitsap County Courthouse McCormick Woods / Golf Course	→ → → ←	Hwy 16 NB Off Ramp at Tremont (not on map) NB

LEGEND:

-  Monument Gateway Sign:  
G3.2 / G3.3
-  Trailblazer Primary Sign:  
G3.5
-  Vehicular Destination Sign:  
G3.4
-  Vehicular Directional Sign:  
G3.6

Sign No.	Type	Message	Location	Traffic Direction
 60	Monument Gateway	Welcome to Port Orchard	Mile Hill at Eastern City Limits	WB
 61	Vehicular Directional	Welcome to Port Orchard	Glenwood	EB
 62	Vehicular Directional	South Kitsap High School →	Mitchell Ave. & Bay St.	EB
 63	Destination Sign	Active Club	Sydney Ave.	
 64	Vehicular Directional	McCormick Woods → McCormick Village Park → Golf Course → (Puget Sound Industrial Center TBD) ↑	Glenwood Rd. & McCormick Woods Dr.	WB
 65	Destination Sign	McCormick Village Park	Old Clifton Rd.	
 66	Vehicular Directional	South Kitsap High School ←	Mile Hill Dr. & Wolves St.	EB
 67	Vehicular Directional	SR-16 Tacoma / Bremerton → McCormick Woods / Golf course → McCormick Village Park → Port Orchard Industrial Park →	Port Orchard Blvd. & Tremont St.	SB
 68	Trailblazer	McCormick Woods / Golf Course ← Downtown/Waterfront → City Hall / Kitsap County Courthouse → Bremerton Foot Ferries →	NB SR - 16 Off Ramp at Sedgwick (not on map)	NB
 69	Vehicular Directional	Givens Playfield ← Port Orchard Active Club ←	Sidney Ave. & Sroufe St.	NB
 70	Vehicular Directional	Kitsap County Courthouse ←	Sidney Ave. & Division St.	NB
 71	Vehicular Directional	Kitsap County Courthouse →	Sidney Ave. & Division St.	SB

LEGEND:

-  Monument Gateway Sign: G3.2 / G3.3
-  Trailblazer Primary Sign: G3.5
-  Vehicular Destination Sign: G3.4
-  Vehicular Directional Sign: G3.6



**Monument Sign / Gateway Sign Primary**  
1/4" = 1'-0"

**Monument Sign / Gateway Sign Secondary**  
1/4" = 1'-0"

**Vehicular Trailblazer Sign / Primary**  
1/4" = 1'-0"

**Destination Sign / Large**  
1/4" = 1'-0"



**Vehicular / Pedestrian Directional / Directional**  
1/4" = 1'-0"

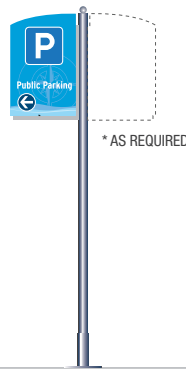

**Parking Directional / Parking ID**  
1/4" = 1'-0"  
\* AS REQUIRED

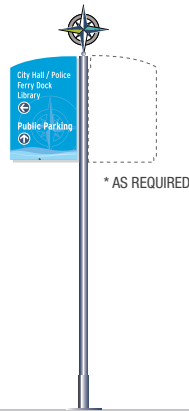

**Pedestrian Wayfinding / Directional**  
1/4" = 1'-0"  
\* AS REQUIRED



**Pedestrian Wayfinding / Infor. Kiosk**  
1/4" = 1'-0"



**Vehicular Trailblazer Sign / Secondary**  
1/4" = 1'-0"



**Destination Sign / Small**  
1/4" = 1'-0"

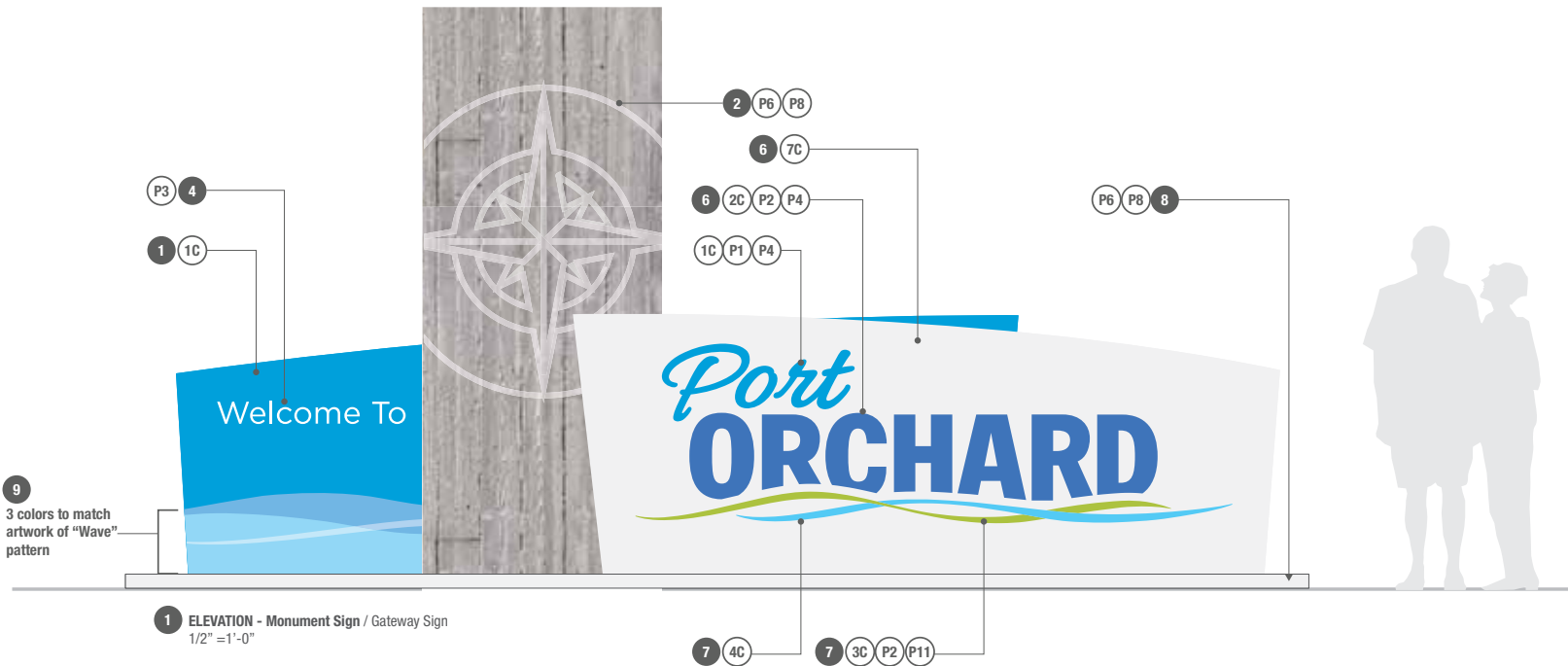

1. Alum sheet over aluminum structural frame anchored into concrete foundation. Metal gauge thickness sufficient to prevent oil canning of sign face(s).
2. Vertical board formed concrete with Compass Rose stamp pattern in concrete, front surface only.
3. 3000 psi concrete foundation
4. Flat cut out type pin mounted off sign cabinet face, paint finish.  
**Welcome to**, 1/4" thick stainless steel, alloy 316 with mounting studs.
5. Screen printed graphic logo. Designer to provide logo color and cutting templates.
6. Fabricated painted alum. letters with mounting studs, 11 gauge thickness.  
**Port**, 1.5" returns.  
**Orchard**, 3" returns.
7. Wave logo elements, 1/4" flat cut out alum., with 1/2" stand offs, paint stand offs to match wave colors.
8. Exposed aggregate flatwork with wave pattern.
9. Frisk and paint with Matthews Paint Wave pattern in 3 colors to match artwork.  
**NOTE: Wave** patterns is painted on returns and face only of back sign panel.

**OPTION 1.** Lighting: Arrowlinear LED by Cooper Lighting.

**Option 2.** Wave pattern digital printed on 3M Controlthc Graphic Film Series 180, w/ 3M Scotchcal Luster Overlaminate 8519.

- Paint Colors:**
- 1C. Pantone 2995
  - 2C. Pantone 300
  - 3C. Pantone 397
  - 4C. Pantone 305
  - 5C. Pantone 547
  - 6C. Pantone Cool Gray 1
  - 7C. Pantone Cool Gray 11
  - 8C. Pantone 302

**NOTE:**  
Fabricator is responsible for all structural engineering for maximum wind load (140 mph) and foundation compliance. All fasteners shall be 316 stainless steel. All galvanized components shall be hot dipped. All colors and graphic imagery shall receive the maximum UV protection. Cutting templates and production ready art available from designer and shall be provided upon contract award.

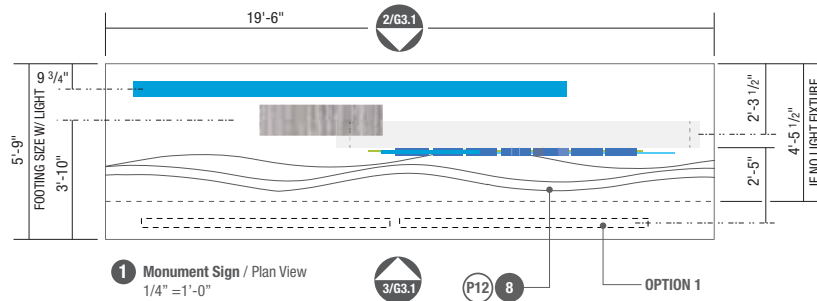

1 Monument Sign / Plan View  
1/4" = 1'-0"

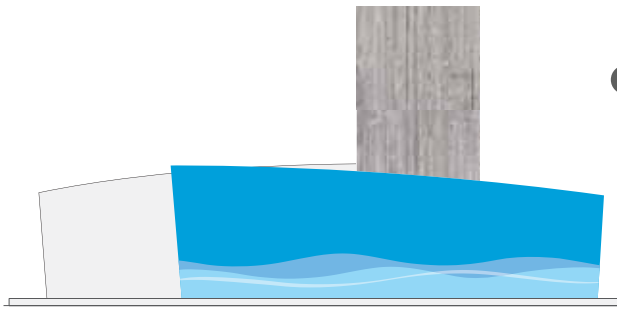

2 Monument Sign / Back Elevation  
1/4" = 1'-0"

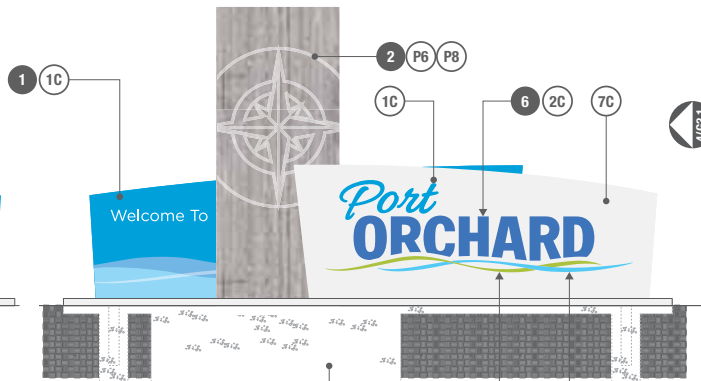

3 Monument Sign / Front Elevation  
1/4" = 1'-0"

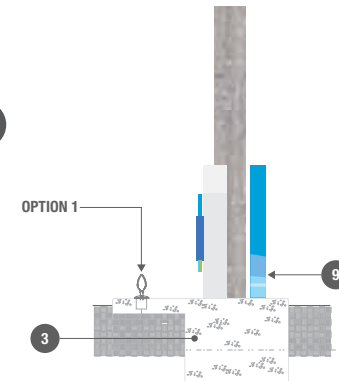

4 Monument Sign / End Elevation  
1/4" = 1'-0"

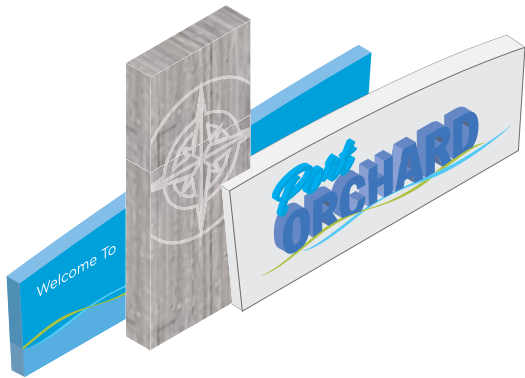

5 Monument Sign / Axonometric View  
1/4" = 1'-0"

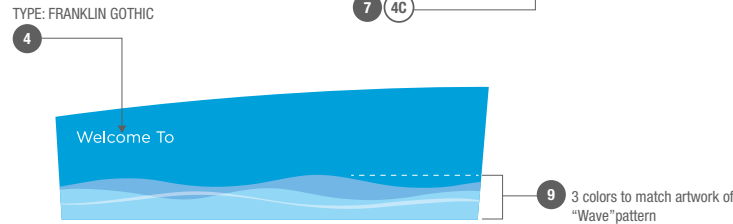

6 Monument Sign / Front Elevation Back Sign Panel  
1/4" = 1'-0"

1. Alum sheet over aluminum structural frame anchored into concrete foundation
2. Vertical board formed concrete with Compass Rose stamp pattern in concrete, front surface only.
3. 3000 psi concrete foundation, sign fabricator to provide engineering as required for footing to meet local codes, soil, wind load & sign weight.
4. Flat cut out type pin mounted off sign cabinet face, paint finish.  
**Welcome to**, 1/4" thick stainless steel, alloy 316 with mounting studs.
5. Screen printed graphic logo. Designer to provide logo color and cutting templates.
6. Fabricated painted alum. letters with mounting studs, 11 gauge thickness.  
**Port**, 1.5" returns.  
**Orchard**, 3" returns.
7. Wave logo elements, 1/4" flat cut out alum., with 1/2" stand offs, paint stand offs to match wave colors.
8. Exposed aggregate flatwork with wave pattern.
9. Frisk and paint with Matthews Paint Wave pattern in 3 colors to match artwork.  
**NOTE: Wave** patterns is painted on returns and face only of back sign panel.

**OPTION 1.** Lighting: Arrowlinear LED by Cooper Lighting.

**OPTION 2.** Wave pattern digital printed on 3M Controltac Graphic Film Series 180, w/ 3M Scotchcal Luster Overlaminate 8519.

- Paint Colors:**
- 1C. Pantone 2995
  - 2C. Pantone 300
  - 3C. Pantone 397
  - 4C. Pantone 305
  - 5C. Pantone 547
  - 6C. Pantone Cool Gray 1
  - 7C. Pantone Cool Gray 11
  - 8C. Pantone 302

**NOTE:**  
Fabricator is responsible for all structural engineering for maximum wind load (140 mph) and foundation compliance. All fasteners shall be 316 stainless steel. All galvanized components shall be hot dipped. All colors and graphic imagery shall receive the maximum UV protection. Cutting templates and production ready art available from designer and shall be provided upon contract award.



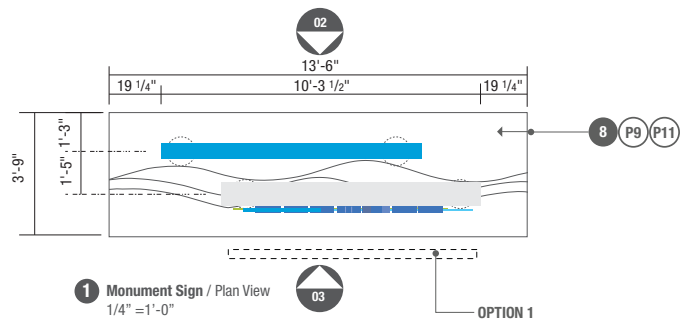

1 Monument Sign / Plan View  
1/4" = 1'-0"

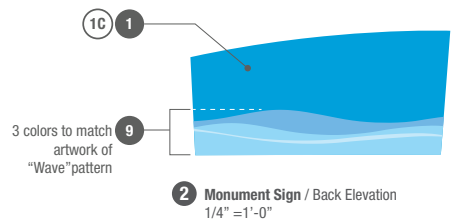

2 Monument Sign / Back Elevation  
1/4" = 1'-0"

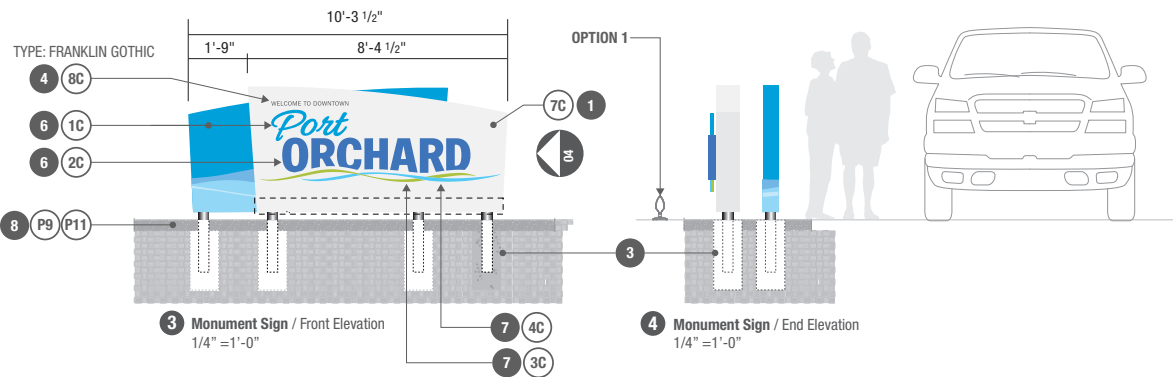

3 Monument Sign / Front Elevation  
1/4" = 1'-0"

4 Monument Sign / End Elevation  
1/4" = 1'-0"

1. Alum sheet over aluminum structural frame anchored into concrete foundation
2. Vertical board formed concrete with Compass Rose stamp pattern in concrete, front surface only.
3. 3000 psi concrete foundation. Direct burial post footing(s) to meet all local building codes & soil conditions
4. Flat cut out type pin mounted off sign cabinet face, paint finish.  
**Welcome to,** 1/4" thick stainless steel, alloy 316 with mounting studs.  
**Orchard,** 3" returns.
5. Screen printed graphic logo. Designer to provide logo color and cutting templates.
6. Fabricated painted alum. letters with mounting studs, 11 gauge thickness.  
**Port,** 1.5" returns.  
**Orchard,** 3" returns.
7. Wave logo elements, 1/4" flat cut out alum., with 1/2" stand offs, paint stand offs to match wave colors.
8. Decorative gravel, **Ocean Granite**, 3/4" or similar with 1/8" corten landscaping edge.
9. Frisk and paint with Matthews Paint Wave pattern in 3 colors to match artwork.  
**NOTE:** Wave patterns is painted on returns face and back of sign panel.

**OPTION 1.** Lighting: Arrowlinear LED by Cooper Lighting.

**OPTION 2.** Wave pattern digital printed on 3M Controlthc Graphic Film Series 180, w/ 3M Scotchcal Luster Overlaminate 8519.

- Paint Colors:**
- 1C. Pantone 2995
  - 2C. Pantone 300
  - 3C. Pantone 397
  - 4C. Pantone 305
  - 5C. Pantone 547
  - 6C. Pantone Cool Gray 1
  - 7C. Pantone Cool Gray 11
  - 8C. Pantone 302

**NOTE:**  
Fabricator is responsible for all structural engineering for maximum wind load (140 mph) and foundation compliance. All fasteners shall be 316 stainless steel. All galvanized components shall be hot dipped. All colors and graphic imagery shall receive the maximum UV protection. Cutting templates and production ready art available from designer and shall be provided upon contract award.

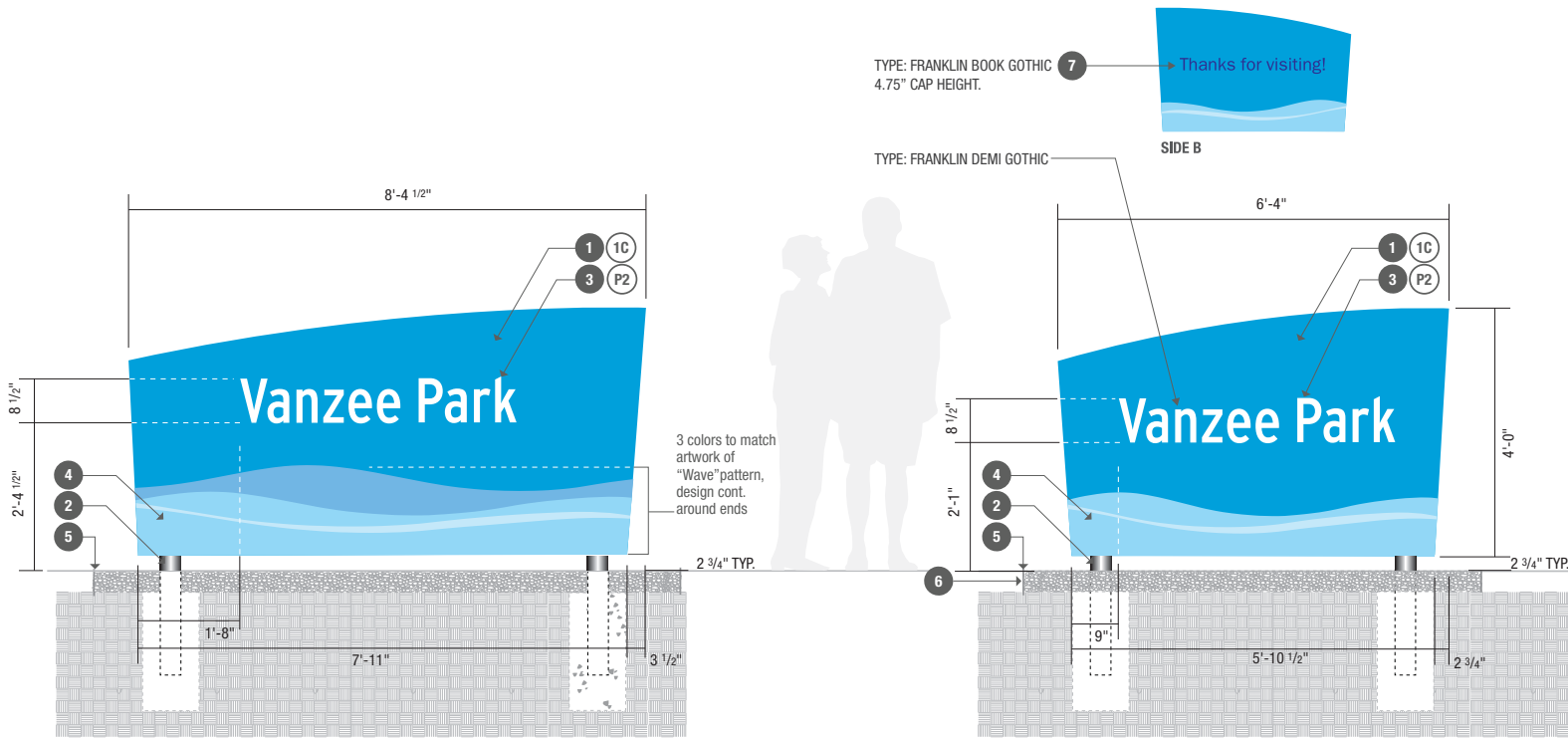

**1 ELEVATION - Destination Sign / Large**  
1/2" = 1'-0"

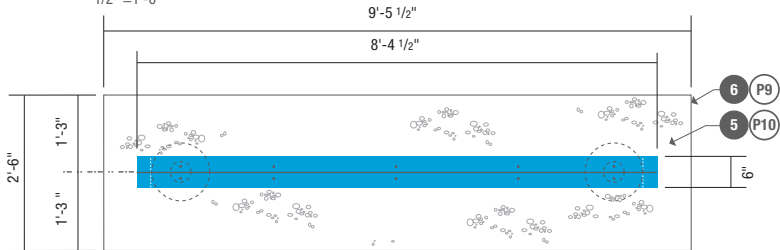

**2 PLAN - Destination Sign / Large**  
1/2" = 1'-0"

**3 ELEVATION - Destination Sign / Small**  
1/2" = 1'-0"

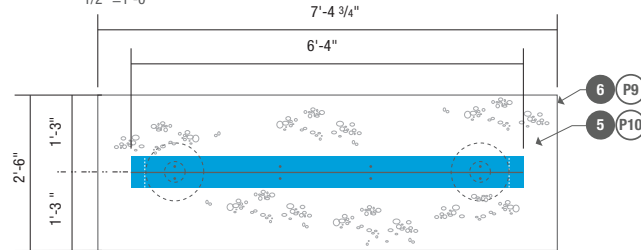

**4 PLAN - Destination Sign / Small**  
1/2" = 1'-0"

1. Alum sheet over aluminum structural frame anchored into concrete foundation
2. 3000 psi concrete foundation. Direct burial post footing(s) to meet all local building codes & soil conditions
3. Flat cut out type flush mounted to sign cabinet face and paint finish. 1/4" thick aluminum with mounting studs.
4. Screen printed graphic logo. Designer to provide logo color and cutting templates. Frisk and paint with Matthews Paint Wave pattern in 3 colors to match artwork. **NOTE: Wave patterns is painted on returns, face and back of sign panel.**
5. Decorative gravel, **Ocean Granite**, 3/4" or similar.
6. 1/8" thk. corten or weathered steel landscaping edge.
7. **3M Reflective Graphic Film: Blue 680-72** type applied to sign face.

**Option 2.** Wave pattern digital printed on **3M Controlthic Graphic Film Series 180, w/ 3M Scotchluster Overlaminate 8519.**

- Paint Colors:**
- 1C. Pantone 2995
  - 2C. Pantone 300
  - 3C. Pantone 397
  - 4C. Pantone 305
  - 5C. Pantone 547
  - 6C. Pantone Cool Gray 1
  - 7C. Pantone Cool Gray 11
  - 8C. Pantone 302

**NOTE:**  
Fabricator is responsible for all structural engineering for maximum wind load (140 mph) and foundation compliance. All fasteners shall be 316 stainless steel. All galvanized components shall be hot dipped. All colors and graphic imagery shall receive the maximum UV protection. Cutting templates and production ready art available from designer and shall be provided upon contract award.





**1 ELEVATION - Vehicular Trailblazer Sign / Primary**  
1/2" = 1'-0"

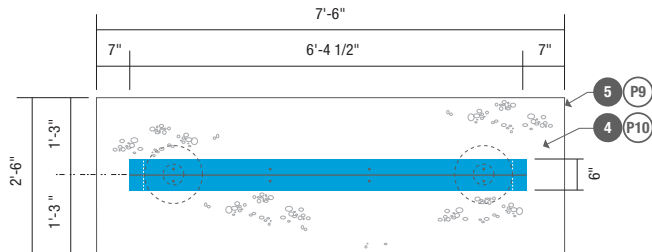

**2 PLAN - Vehicular Trailblazer Sign / Primary**  
1/2" = 1'-0"

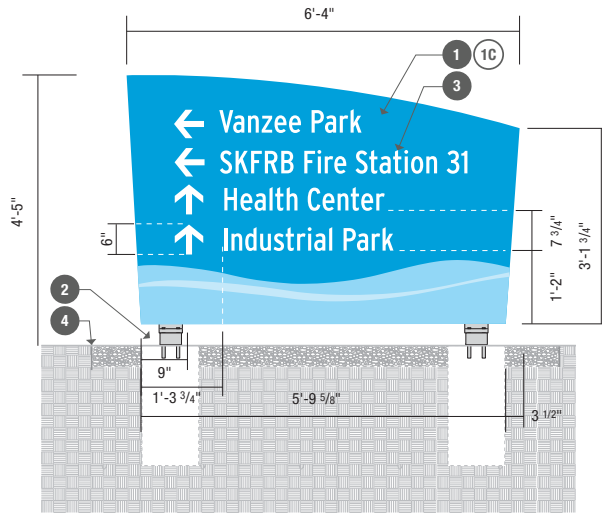

**3 ELEVATION - Vehicular Trailblazer Sign / Secondary**  
1/2" = 1'-0"

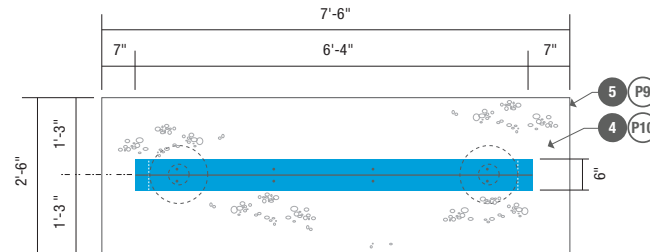

**4 PLAN - Vehicular Trailblazer Sign / Secondary**  
1/2" = 1'-0"

1. Alum sheet over aluminum structural frame anchored into concrete foundation
2. 3000 psi concrete foundation. Post footing(s) to meet all local building codes & soil conditions. RE: SHEET 3/G4.1 for base bracket detail.
3. 3M Reflective Graphic Film: White 680, or 5100 digitally printed type and graphics. **NOTE:** Wave patterns is painted on returns, face and back of sign panel.
4. Decorative gravel, Ocean Granite, 3/4" or similar.
5. 1/8" thk. corten or weathered steel landscaping edge.

**Option 2.** Wave pattern digital printed on 3M Controltac Graphic Film Series 180, w/ 3M Scotchluster Overlaminant 8519.

- Paint Colors:**
- 1C. Pantone 2995
  - 2C. Pantone 300
  - 3C. Pantone 397
  - 4C. Pantone 305
  - 5C. Pantone 547
  - 6C. Pantone Cool Gray 1
  - 7C. Pantone Cool Gray 11
  - 8C. Pantone 302

**NOTE:**  
Fabricator is responsible for all structural engineering for maximum wind load (140 mph) and foundation compliance. All fasteners shall be 316 stainless steel. All galvanized components shall be hot dipped. All colors and graphic imagery shall receive the maximum UV protection. Cutting templates and production ready art available from designer and shall be provided upon contract award.

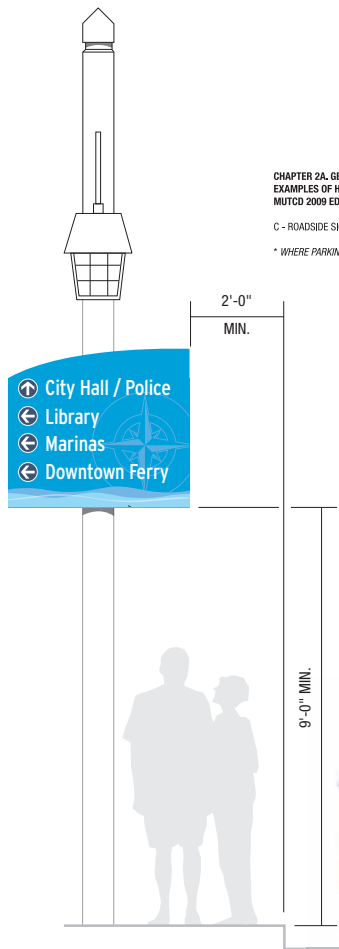

**1 ELEVATION / Vehicular Directional**  
3/8" = 1'-0"

CHAPTER 2A, GENERAL FIGURE 2A-2  
EXAMPLES OF HEIGHTS AND LATERAL LOCATIONS OF SIGN INSTALLATIONS  
MUTCD 2009 EDITION.  
C - ROADSIDE SIGN IN BUSINESS, COMMERCIAL, OR RESIDENTIAL AREA.  
\* WHERE PARKING OR PEDESTRIAN MOVEMENTS ARE LIKELY TO OCCUR.

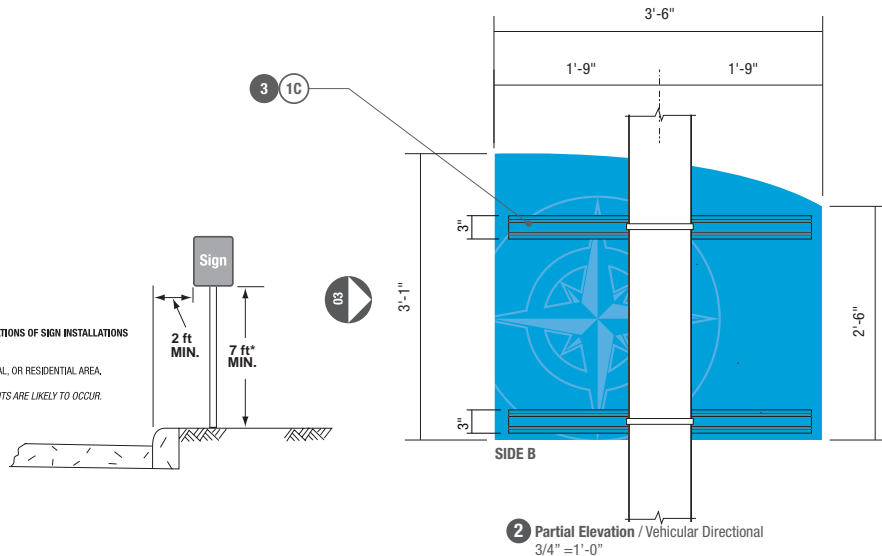

**2 Partial Elevation / Vehicular Directional**  
3/4" = 1'-0"

**3 Side Elevation / Vehicular Directional**  
3/4" = 1'-0"

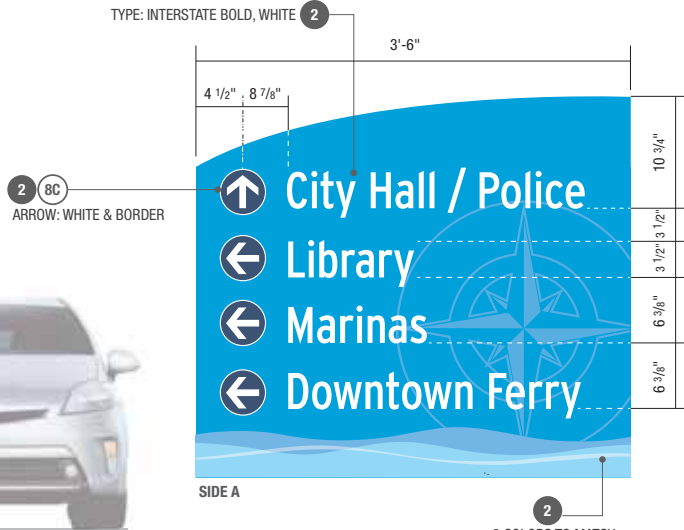

**4 Detail Panel Layout / Vehicular Directional**  
1" = 1'-0"

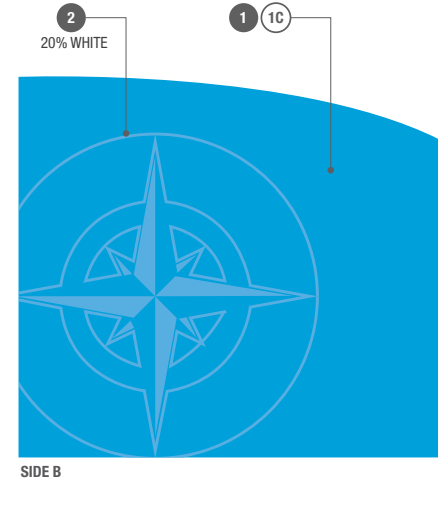

**5 Detail Panel Layout / Vehicular Directional**  
1" = 1'-0"

- 13 GA. Alum. sign panels, powdercoat base color. Provide (4) thru holes, 2 top / 2 bottom for SST pan head security head fastener.
  - 3M Reflective Graphic Film: White 680, or 5100** digitally printed and applied to sign face.
  - Hat channel 14 GA. ASTM A653 or equal hot dipped galvanized steel. Provide nylon washers between dissimilar materials.
  - Connect sign panel to Band-It Double-Flared Leg Brack-It w/ SST bolts. Use 3/4" - .030 Double Wrapping 201 SST as provided by Band-It Systems.
  - Existing street pole.
- Paint Colors:**  
**1C.** Pantone 2995  
**2C.** Pantone 300  
**3C.** Pantone 397  
**4C.** Pantone 305  
**5C.** Pantone 547  
**6C.** Pantone Cool Gray 1  
**7C.** Pantone Cool Gray 11  
**8C.** Pantone 302

**NOTE:**  
Fabricator is responsible for all structural engineering for maximum wind load (140 mph) and foundation compliance. All fasteners shall be 316 stainless steel. All galvanized components shall be hot dipped. All colors and graphic imagery shall receive the maximum UV protection. Cutting templates and production ready art available from designer and shall be provided upon contract award.





SIDE A

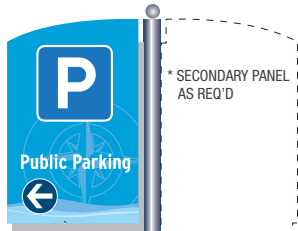

\*SECONDARY PANEL AS REQ'D

8'-0" CLR. MIN.



RE: 4/G3.10 Detail

SIDE B

1 ELEVATION - Parking Directional / Parking ID  
1/2" = 1'-0"

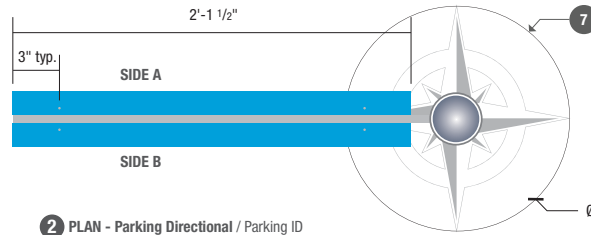

2 PLAN - Parking Directional / Parking ID  
1-1/2" = 1'-0"

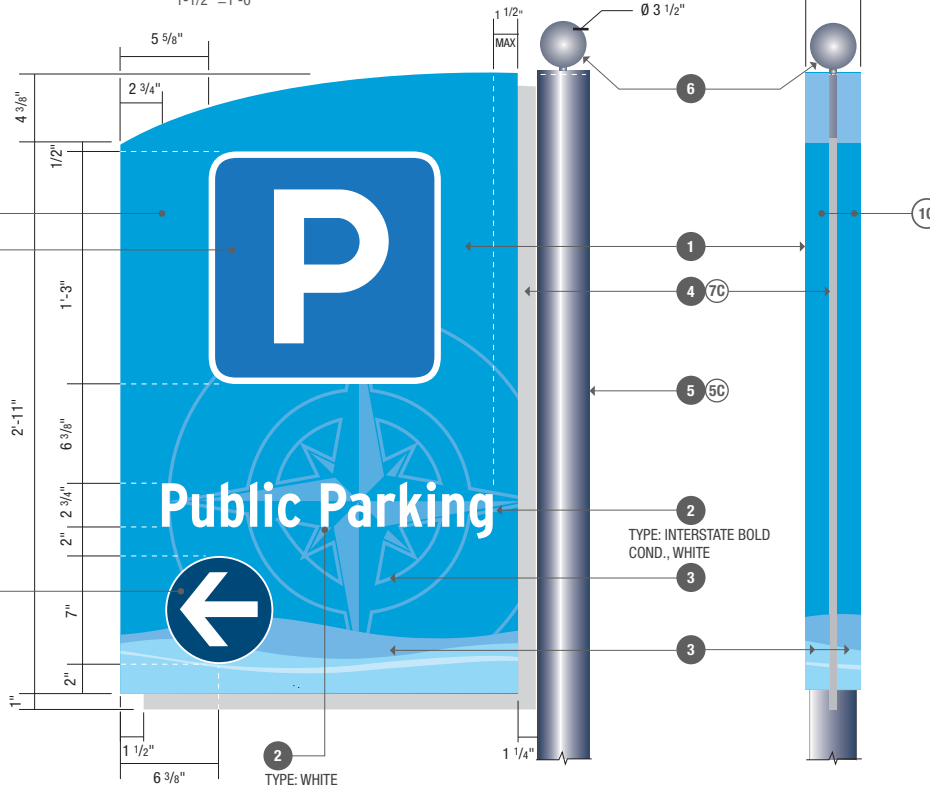

3 DETAIL - Parking Directional / Parking ID  
1-1/2" = 1'-0"

4 SIDE VIEW - Parking Directional / Parking ID  
1-1/2" = 1'-0"

1. 16 GA. Alum. pan formed sign panels with welded and ground smooth corners and radius top, powdercoat base color to match: CMYK: 76C 20Y Provide (4) thru holes, 2 top / 2 bottom for SST #8-32 pan head security head fastener.
  2. 3M Reflective Graphic Film: White 680, or 5100 type and international symbols applied to sign face.
  3. Graphic elements to be screenprinted over powdercoat base layer with epoxy inks. Refer to graphics standards sheet 6 for patterns.
  4. 3/8" Thick aluminum plate stitch weld to aluminum sign pole. Plate to have (8) 1/4" tap and threaded tabs welded to the face for mechanically attaching pan formed aluminum sign faces.
  5. 3" dia. Sched. 40 Aluminum sign pole with powdercoat finish, direct burial or break-away footing as req'd, 1/4" thick welded end cap with tap and threaded hole for 1/4-20 one end only.
  6. 3-1/2" SS sphere mechanically attached to sign pole end cap.
  7. 1/2" Thk. aluminum escutcheon plate plug welded from beneath with photoetched graphic on the face, 1/8" chamfered edge.
- Paint Colors:**  
 1C. Pantone 2995  
 2C. Pantone 300  
 3C. Pantone 397  
 4C. Pantone 305  
 5C. Pantone 547  
 6C. Pantone Cool Gray 1  
 7C. Pantone Cool Gray 11  
 8C. Pantone 302

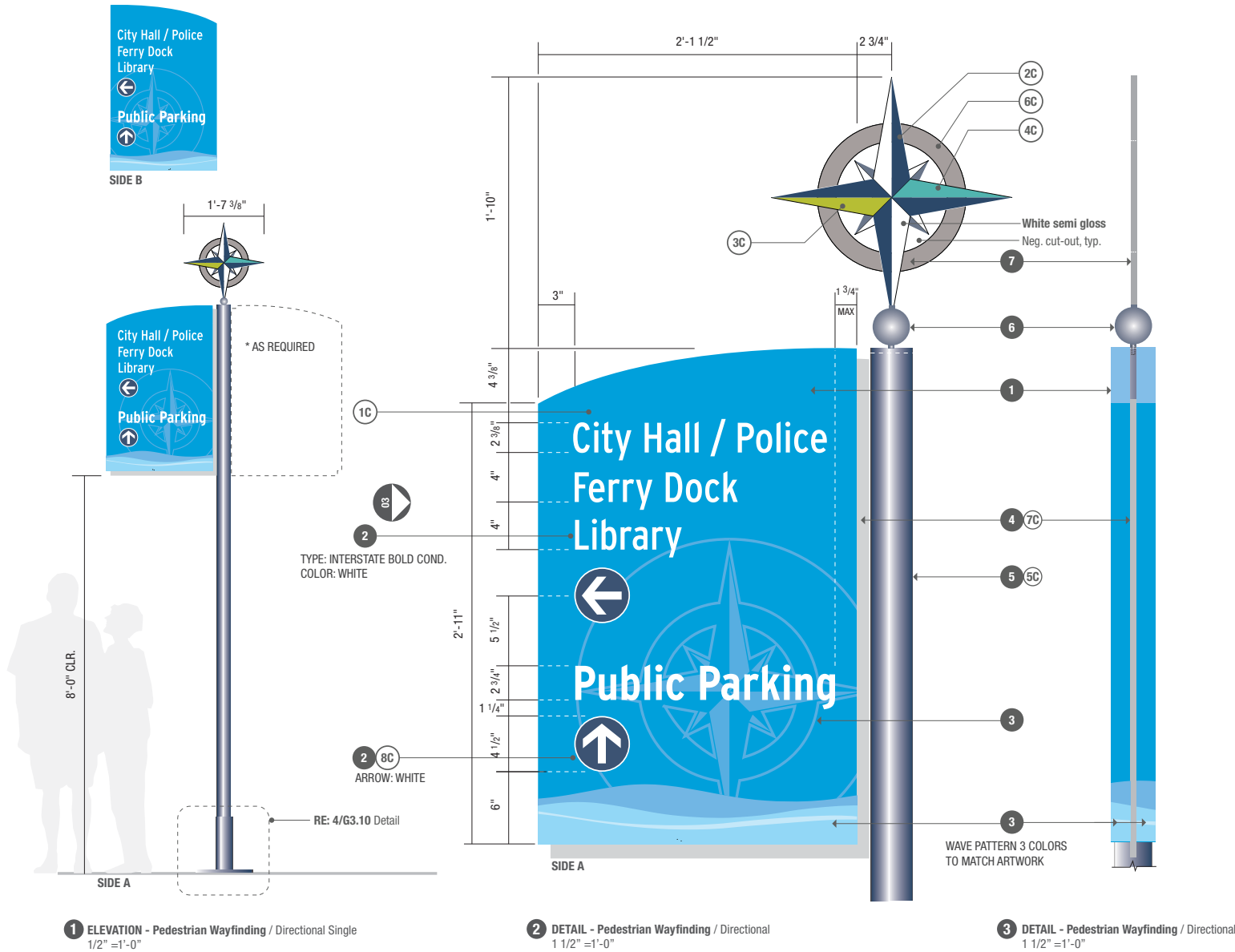

- 16 GA. Alum. pan formed sign panels with welded and ground smooth corners and radius top, powdercoat base color to match: CMYK: 76C 20Y Provide (4) thru holes, 2 top / 2 bottom for SST #8-32 pan head security head fastener.
- 3M Reflective Graphic Film: White 680, or 5100 type and international symbols applied to sign face.
- Graphical elements to be screenprinted over powdercoat base layer with epoxy inks.
- 3/8" Thick aluminum plate stitch weld to aluminum sign pole. Plate to have (8) 1/4" tap and threaded tabs welded to the face for mechanically attaching pan formed aluminum sign faces.
- 3" dia. Sched. 40 Aluminum sign pole with powdercoat finish, direct burial or break-away footing as required, 1/4" thick welded end cap with tap and threaded hole for 1/4-20 one end only.
- 3-1/2" SS sphere mechanically attached to sign pole end cap.
- 3/8" Thk. aluminum waterjet cut and paint infilled rose compass welded to 3-1/2" dia. mechanically attached sphere

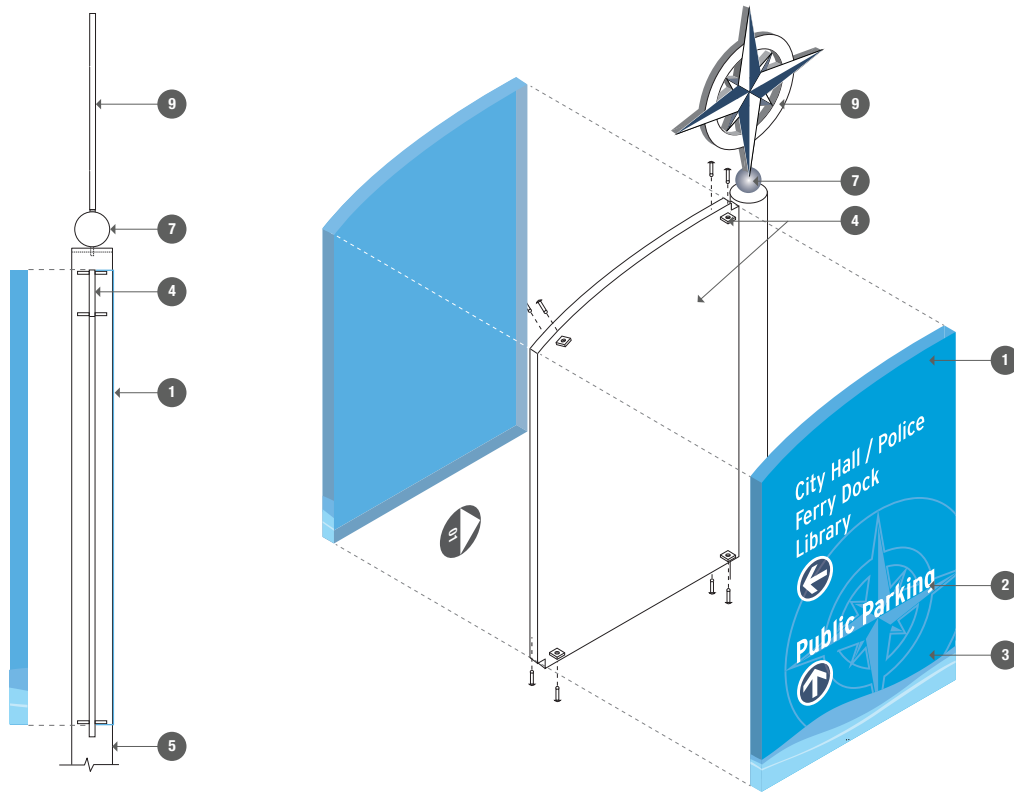

**1** End View / Pedestrian Wayfinding / Directional  
1" = 1'-0"

**2** Axonometric / Pedestrian Wayfinding / Directional  
1" = 1'-0"

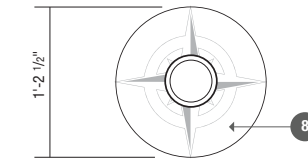

**3** Partial Plan / Pedestrian Wayfinding / Directional  
1" = 1'-0"

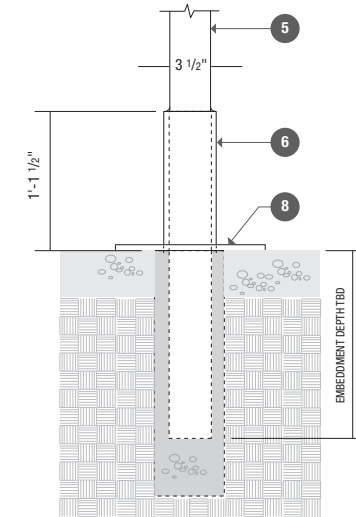

**4** Detail / Pedestrian Wayfinding / Directional  
1" = 1'-0"

1. 16 GA. Alum. pan formed sign panels with welded and ground smooth corners and radius top, powdercoat base color to match: CMYK: 76C 20Y Provide (4) thru holes, 2 top / 2 bottom for SST #8-32 pan head security head fastener.
  2. **3M Reflective Graphic Film: White 680**, or **5100** type and international symbols applied to sign face.
  3. Graphical elements to be screenprinted over powdercoat base layer with epoxy inks.
  4. 3/8" Thick aluminum plate stitch welded to aluminum sign pole. Plate to have (8) 1/4" tap and threaded tabs welded to the face for mechanically attaching pan formed aluminum sign faces.
  5. 3" dia. Sched. 40 Aluminum sign pole with powdercoat finish, direct burial footing, 1/4" thick welded end cap with tap and threaded hole for 1/4-20 one end only.
  6. 3-1/2" dia. Sched. 40 Aluminum post base sleeved over smaller diameter pole and continuous welded. Exposed edge to receive eased edge, all welds ground smooth.
- NOTE:**  
Footing is subject to WSDOT standard guidelines as noted in WSDOT Design Manual 1600.04(2)(d). If a suitable location meeting WSDOT guidelines can not be found, detail 4 is to be superceded by 1/G4.1
7. 3-1/2" Sphere mechanically attached to sign pole end cap.
  8. 1/2" Thk. aluminum escutcheon plate plug welded from beneath with photetched graphic on the face, 1/8" chamfered edge.
  9. 3/8" Thk. aluminum waterjet cut and paint infilled rose compass welded to 3-1/2" dia. mechanically attached sphere



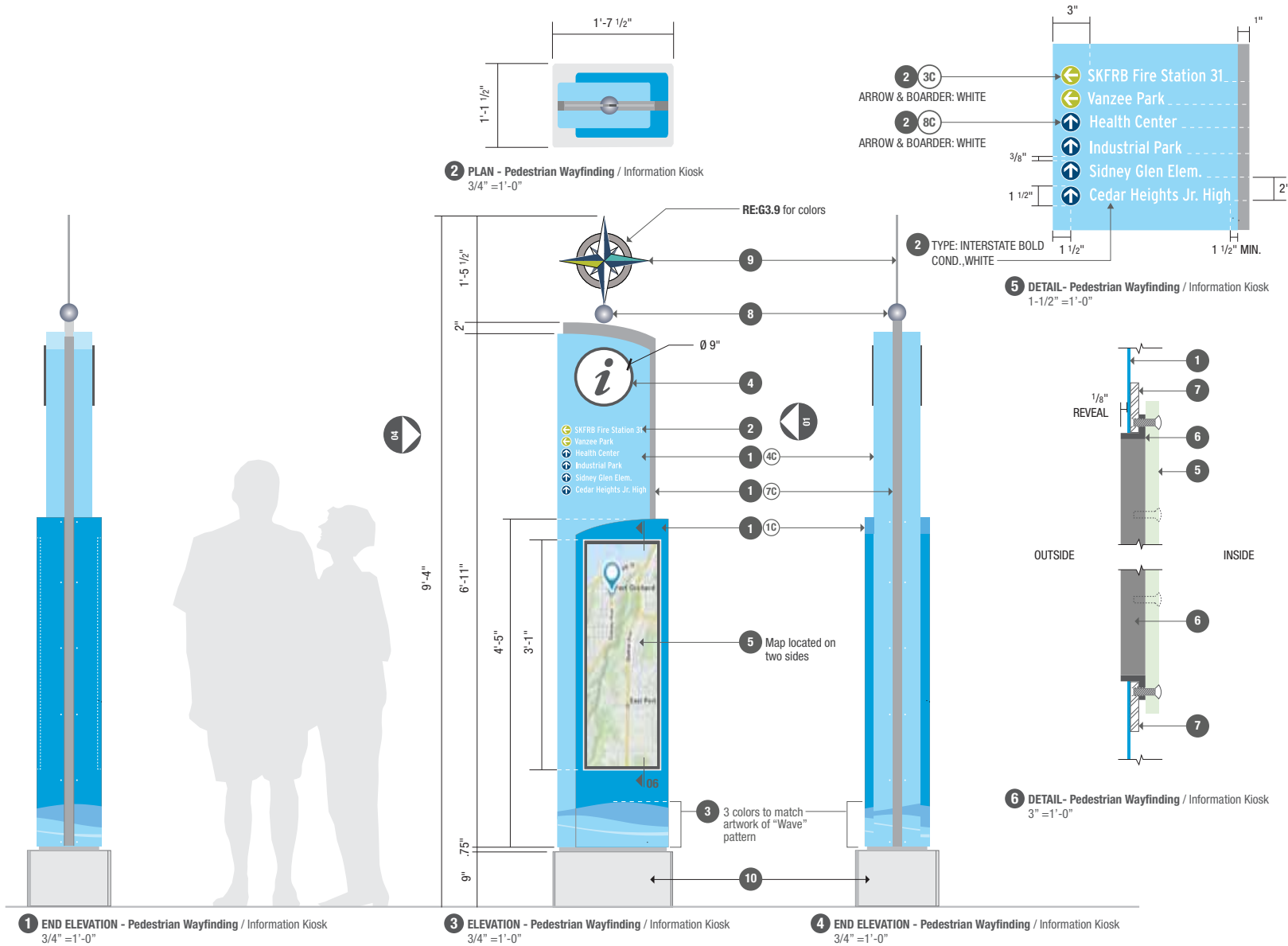

1. 16 GA. Alum. sign cabinets attached to concealed aluminum angle frame. Corners to have break formed edges when possible (3/8" outside radius at corners) Radius at top to be continuous weld and ground smooth. Refer to graphic standards page for powdercoat base colors.
  2. 3M Reflective Graphic Film: White 680, or 5100 type and international symbols applied to sign face.
  3. Frisk and paint with Matthews Paint Wave pattern in 3 colors to match artwork. **NOTE:** Wave patterns is painted on returns face and back of sign panel.
  4. 1/4" Thk. alum. plate with photo etched graphic, paint infill 2 colors. Plug weld or mechanically attach to sign face from inside cabinet.
  5. 1/4" Thk. phenolic resin sign panel mechanically attached from the backside to alum. sign cabinet
  6. 1/2" x 1/2" x 1/8" alum. sharp corner angle with tapped and threaded holes for (12) #8-32 SST CSK pan head fasteners. Powder coat finish.
  7. 1/8" x 1" alum. flat bar angle spacer welded to inside of alum. sign cabinet on all 4 sides of opening. Provides spacing for 1/8" angle reveal.
  8. 3-1/2" Sphere mechanically attached to concealed sign frame.
  9. 3/8" Thk. aluminum waterjet cut and paint infilled rose compass welded to 3-1/2" dia. mechanically attached sphere
  10. 3000 PSI concrete footing w/ 3/4" chamfered edge detail on all visible edges. Sign cabinet to mechanically attach to footing using concealed wedge anchors
- Alternate Pricing: \***
- Option A1.** Wave pattern digital printed on 3M Controltac Graphic Film Series 180, w/ 3M Scotchluster Overlaminate 8519.
- Paint Colors:**
- 1C. Pantone 2995
  - 2C. Pantone 300
  - 3C. Pantone 397
  - 4C. Pantone 305
  - 5C. Pantone 547
  - 6C. Pantone Cool Gray 1
  - 7C. Pantone Cool Gray 11
  - 8C. Pantone 302



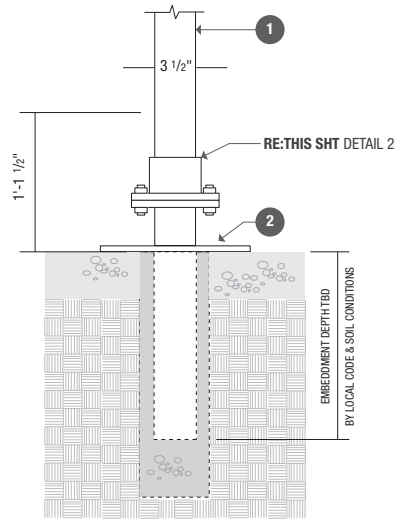

**1** BREAKAWAY - TYPE PL SIGN SUPPORT  
1" = 1'-0"

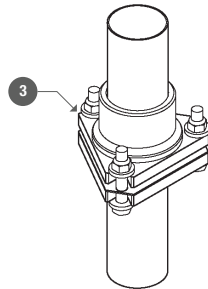

**2** BREAKAWAY - TYPE PL SUPPORT ISO  
NTS

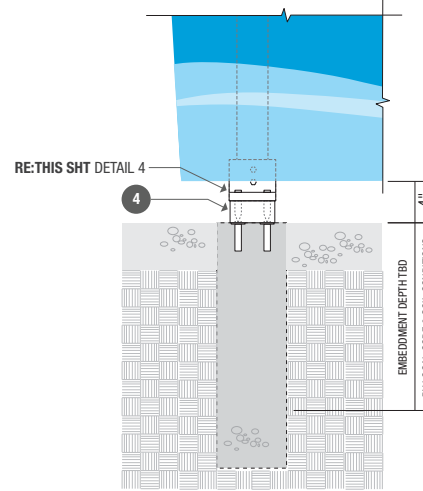

**3** BREAKAWAY - TYPE AS SIGN SUPPORT  
1" = 1'-0"

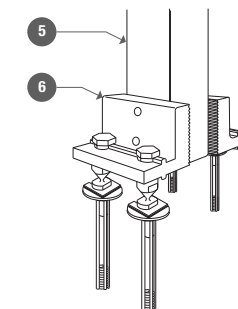

**4** BREAKAWAY - TYPE AS SIGN SUPPORT ISO  
NTS

1. 3" dia. Sched. 40 Aluminum sign pole with powdercoat finish, direct burial footing, 1/4" thick welded end cap with tap and threaded hole for 1/4-20 one end only.
2. 1/2" Thk. aluminum escutcheon plate plug welded from beneath with photoetched graphic on the face, 1/8" chamfered edge.
3. Slip plate/breakaway base assembly to comply with WSDOT Standard Plan G-24.30-01.
4. 1/16" thick aluminum Pole-Safe® Skirt (TRANSCO INDUSTRIES)
5. 3" Square Aluminum Tube.
6. Breakaway base assembly to comply with WSDOT Standard Plan G-24.60-04