

Sign Fabrication Manual

M 55-05



Washington State Department of Transportation
Maintenance and Operations - Traffic Operations Office

SUGGESTION FORM
Sign Fabrication Manual, M55-05

Please submit your suggestion by mail or e-mail to:

State Traffic Engineer - Signing
WSDOT Field Operation Support Service Center
P. O. Box 47344
Olympia, WA 98504-7344

E-mail: mowldsr@wsdot.wa.gov

Use the reverse side of this form, attach a separate sheet of paper, or send via e-mail. Clearly state your suggestion and the reasons why it would be an improvement.

Please provide the following information with your suggestion:

Date Submitted	
Your Name	
Your Organization	
Your Work Address/Mail Stop	
City and Zip Code	
Your Work Phone Number	
Sign number(s)	

We will contact you to be sure we clearly understand your suggestion, and we will keep you informed on how your suggestion will be handled.

Traffic Office Response

Attached is the outcome of our evaluation and an explanation of how we will, or why we will not, implement your suggestion.

Date of Response	
Evaluator's Name	
Evaluator's Telephone Number	
Evaluator's Signature	
Approved by: State Signing Engineer	

Americans with Disabilities Act (ADA) Information

Materials can be provided in alternative formats: large print, Braille, cassette tape, or on computer disk for people with disabilities by calling the Office of Equal Opportunity (OEO) at 360-705-7097. Persons who are deaf or hard of hearing may contact OEO through the Washington Relay Service at 7-1-1.

Title VI Notice to Public

It is the Washington State Department of Transportation's (WSDOT) policy to assure that no person shall, on the grounds of race, color, national origin or sex, as provided by Title VI of the Civil Rights Act of 1964, be excluded from participation in, be denied the benefits of, or be otherwise discriminated against under any of its federally funded programs and activities. Any person who believes his/her Title VI protection has been violated, may file a complaint with WSDOT's Office of Equal Opportunity (OEO). For Title VI complaint forms and advice, please contact OEO's Title VI Coordinator at 360-705-7098 or 509-324-6018.

To get the latest information on WSDOT administrative and engineering manuals, sign up for e-mail updates for individual manuals at: www.wsdot.wa.gov/publications/manuals

Washington State Department of Transportation
Administrative and Engineering Publications
PO Box 47304
Olympia, WA 98504-7304

Phone: 360-705-7430

E-mail: engrpubs@wsdot.wa.gov

Internet: www.wsdot.wa.gov/publications/manuals

Foreword

This edition of the Sign Fabrication Manual has been prepared to assist sign fabricators, both public and private, in maintaining a uniform appearance of official highway signs.

The highway signs illustrated herein represent the signs currently in use in Washington State. Included are the signs contained in the Federal Standard Highway Signs Book and additional signs approved for use within the state. A section has also been included, for use in conjunction with the Manual on Uniform Traffic Control Devices, to assist designers with sign layouts.

Warning signs that are utilized for temporary traffic control shall have an orange (retroreflective) background with black (non-reflective) legend, borders, and/or symbols.

In this edition, most signs are drawn without horizontal dimensioning for layouts. Fabricators are to optically center layouts to achieve a balanced sign.

Letter fonts and colors are to be in accordance with the Manual on Uniform Traffic Control Devices. Standard Color Tolerance Charts are \$60 per color chart; or \$300 for a set of 6 color charts. Contact: Hale Color Charts, Inc., 3709 Ocean View Avenue, Los Angeles, CA 90066. Telephone: 800-777-1225. On the Web at: www.halecolorcharts.com.

Updating the manual is a continuing process and revisions are issued periodically. Address orders, questions, and suggestions to the Engineering Publications Branch.

D SERIES

- D1-101 1 DESTINATION W/ARROW*
- D1-201 2 DESTINATIONS W/ARROWS*
- D1-301 3 DESTINATIONS W/ARROWS*
- D1-401 ADVANCE DESTINATION*
- D1-501 ADVANCE DESTINATION W/ROUTE MARKER*
- D1-601 MULTILANE DESTINATION W/ARROW*
- D1-602 MULTILANE DESTINATIONS W/ARROWS*
- D1-603 MULTILANE DESTINATIONS W/ARROWS*
- D1-701 DIRECTIONAL W/ROUTE MARKER*
- D1-801 APPROACH DIRECTIONAL SIGN - 2 DESTINATIONS*
- D1-901 APPROACH DIRECTIONAL SIGN - 1 DESTINATION*
- D3-101 STREET NAME SIGN*
- D3-102 CROSSROADS NAME SIGN
- D3-104 PRIVATE ROAD NAME SIGN
- D3-2 ADVANCE STREET NAME SIGN W/ARROW
- D3-2A ADVANCE STREET NAME SIGN NEXT INTERSECTION
- D3-201 CROSSROADS NAME SIGN*
- D3-301 CROSSROADS NAME SIGN*
- D3-302 CROSSROADS NAME SIGN W/CHEVRON*
- D3-401 STREET NAME SIGN W/GEORGE SHIELD*
- D4-1 URBAN PUBLIC PARKING SIGN
- D4-2 PARK & RIDE*
- D4-301 PARK & RIDE _____*
- D4-401 REST AREA PARKING*
- D5-101 REST AREA _____ MILES
- D5-102 NEXT REST AREA _____ MILES
- D5-103 REST AREA NEXT RIGHT
- D5-201 REST AREA (ARROW _____ DEGREES) (MAJOR)
- D5-202 REST AREA VISITOR INFORMATION CENTER _____ MILES
- D5-203 REST AREA VISITOR INFORMATION CENTER NEXT RIGHT
- D5-204 REST AREA VISITOR INFO CENTER (ARROW _____ DEGREES)
- D5-301 TIRED? REST AREA _____ MILES
- D5-601 REST AREA ADVANCE (MINOR)
- D5-602 _____ MILE
- D5-701 REST AREA (ARROW _____ DEGREES) (MINOR)
- D5-801 PET AREA DIRECTIONAL
- D5-901 PET AREA KEEP PETS ON LEASH
- D5-902 SYMBOL - RANGER STATION
- D5-903 SYMBOL - LIGHTHOUSE
- D5-904 SYMBOL - INFORMATION
- D5-905 SYMBOL - VIEWPOINT
- D5-906 SYMBOL - PET AREA KEEP PETS ON LEASH
- D5-907 SYMBOL - WATCHABLE WILDLIFE (BINOCULAR)
- D5-908 SYMBOL - REST ROOM
- D6-1 SCENIC AREA W/ARROW
- D6-2 SCENIC AREA ADVANCE SIGN
- D6-3 SCENIC AREA EXIT DIRECTION

* denotes variable message sign

D7-101	RECREATIONAL AREA ADVANCE SIGN
D7-201	RECREATIONAL AREA DIRECTIONAL SIGN
D7-301	MOUNTAIN PEAK - VIEW STRAIGHT AHEAD
D7-301L	MOUNTAIN PEAK - VIEW LEFT
D7-301R	MOUNTAIN PEAK - VIEW RIGHT
D7-301P	IN THE DISTANCE PLAQUE
D7-401	SYMBOL - BICYCLE TRAIL
D7-501	SYMBOL - TRAIL
D7-601	SYMBOL - BRIDLE TRAIL
D7-701	SYMBOL - GOLFING
D7-801	SYMBOL - CLIMBING
D7-901	SYMBOL - TRAIL (INTERPRETIVE PED)
D7-1000	MARINE RECREATION AREA
D7-1001	SYMBOL - BOATING
D7-1101	SYMBOL - BOAT LAUNCH
D7-1201	SYMBOL - BOAT MOORAGE
D7-1301	SYMBOL - FISHING
D7-1401	SYMBOL - SWIMMING
D7-1402	BEACH
D7-1501	SYMBOL - WATER SKIING
D7-1601	SYMBOL - CANOEING
D7-1701	SYMBOL - ROWBOATING
D7-2001	SYMBOL - SNOW SKIING
D7-2002	SYMBOL - CROSS COUNTRY SKIING
D7-2101	SYMBOL - SNOWMOBILE AREA
D7-2103	SYMBOL - WINTER SPORTS
D7-2104	SYMBOL - SNOWSHOEING
D7-2201	SYMBOL - PICNICKING
D7-2202	NO CAMPING
D7-2203	SYMBOL - PLAYGROUND
D7-2204	SYMBOL - CAMPFIRE
D7-7701	REC AREA NEXT RIGHT
D8-1	WEIGH STATION ____ MILE
D8-101	EMERGENCY CALL BOX
D8-201	WEIGH STATION RIGHT LANE
D8-202	OPEN - CLOSED PANEL
D8-301	WEIGH STATION EXIT (ARROW _____ DEGREES)
D9-1	PHONE SYMBOL (Informational)
D9-1A	SYMBOL PHONE (ARROW _____ DEGREES)
D9-1B	SYMBOL ADVANCE PHONE _____ MILE
D9-101	FOOD - PHONE - GAS - LODGING, ETC.*
D9-102	FOOD - PHONE - GAS - LODGING NEXT RIGHT*
D9-103	FOOD - GAS - LODGING NEXT RIGHT*
D9-1	PHONE SYMBOL (Recreational)
D9-3	SYMBOL - TENT CAMPING

* denotes variable message sign

D9-3A	SYMBOL - TRAILER CAMPING
D9-3B	SYMBOL - TRAILER AND TENT CAMPING
D9-4	SYMBOL - RESTROOM MEN
D9-5	SYMBOL - RESTROOM WOMEN
D9-6	SYMBOL - HANDICAPPED
D9-7	SYMBOL - RESTROOM WOMEN AND MEN
D9-8	SYMBOL - FOOD
D9-9	SYMBOL - LODGING
D9-10	SYMBOL - SHOWERS
D9-11	SYMBOL - FUEL, GASOLINE
D9-11A	SYMBOL - FUEL, COMPRESSED NATURAL GAS
D9-11B	SYMBOL - FUEL, ETHANOL
D9-1101	SYMBOL - FUEL, DIESEL
D9-12	SYMBOL - RECREATIONAL VEHICLE SANITARY STATION
D9-2	SYMBOL - HOSPITAL
D9-301	RV PARK SIGN
D9-401	ARROW SIGN
D9-501	DIRECTIONAL ARROW DETAILS (HORIZONTAL)
D9-502	DIRECTIONAL ARROW DETAILS (VERTICAL)
D9-13	SYMBOL - EMERGENCY MEDICAL SERVICES
D9-13A	HOSPITAL
D9-13B	AMBULANCE STATION
D9-13C	EMERGENCY MEDICAL CARE
D9-1301	SYMBOL - QUESTION MARK
D9-14	POLICE
D9-15	SYMBOL - LP GAS
D9-1601	NEXT SERVICES _____ MILES
D10-1	MILE _____ (SINGLE FACED)
D10-2	MILE _____ (SINGLE FACED)
D10-3	MILE _____ (SINGLE FACED)
D10-101	MILE _____ (BACK TO BACK)
D10-201	MILE _____ (BACK TO BACK)
D10-301	MILE _____ (BACK TO BACK)
D10-401	BACK EQ. PLAQUE
D10-501	SPUR ROUTE PLAQUE
D11-1	BIKE ROUTE
D12-201	CAR POOL INFO _____
D12-202	CAR POOL INFO W/SYMBOL _____
D13-1	FREE COFFEE
D13-2	CROSSOVER W/ARROW
D13-3	CROSSOVER 1/4 MILE

E SERIES

E1-1	ADVANCE GUIDE SIGN*
E1-4	DIAGRAMMATIC*
E1-5	EXIT PANEL*
E2-1	NEXT EXIT _____ MILES

* denotes variable message sign

E2-1A	NEXT EXIT _____ MILES
E3-101	DOUBLE EXIT OR NEXT RIGHT SECOND LEFT*
E4-301	NEXT RIGHT GUIDE SIGN*
E4-501	EXIT ONLY GUIDE SIGN W/ARROW*
E5-1	EXIT (ARROW _____ DEGREES)
E5-1A	EXIT GORE SIGN WITH EXIT NUMBER AND ARROW*
E5-2	EXIT ONLY
E5-2A	EXIT OPEN
E5-2B	EXIT CLOSED
E5-3	EXIT NUMBER PLAQUE FOR EXIT GORE SIGN
E5-4	ADVISORY SPEED PLAQUE FOR EXIT GORE SIGN
E6-101	EXIT DIRECTION*
E6-2	PULL THRU SIGN (OVERHEAD)*
E7-1	MILEAGE SIGN*
E8-1	INTERCHANGE SEQUENCE SIGN*
E8-2	CITY INTERCHANGE SEQUENCE*
E9-1	CITY NEXT _____ EXITS*
E11-1	EXIT ONLY PANELS
E12-101	HIGHWAY ENTRANCE
E12-201	FREEWAY ENTRANCE
E13-1	PARK AND RIDE NEXT RIGHT*
E13-2	PARK AND RIDE W/EXIT NUMBER*

G-SERIES

G20-1	ROAD WORK NEXT _____ MILES
G20-2A	END ROAD WORK
G20-4	PILOT CAR FOLLOW ME
G20-601	END LANE CLOSURE
G24-101	USE ALL LANES
G24-201	USE LEFT LANE
G24-301	USE RIGHT LANE
G24-501	FOR PROJECT INFORMATION _____
G28-101	WORK ZONE AHEAD; GIVE'EM A BRAKE
G28-201	THANK YOU – WSDOT & (CONTRACTOR'S NAME)

I SERIES

I1-1	SIGNALS SET FOR _____ MPH
I1-2	USE YOUR ASHTRAY
I1-201	SYMBOL - FOREST FIRE PREVENTION
I1-301	VEGETATION MANAGEMENT APPLICATION
I2-101	WELCOME TO WASHINGTON
I2-201	COUNTY ENTRANCE SIGN*
I2-301	CITY ENTRANCE SIGN*
I2-401	RANGE AREA WATCH OUT FOR LIVESTOCK
I2-501	LEAVING RANGE AREA
I2-601	ENTERING LIMITED ACCESS AREA
I2-701	LEAVING LIMITED ACCESS AREA

* denotes variable message sign

- I3-101 STREAM NAME SIGN*
- I3-201 SUMMIT ELEVATION SIGN*
- I4-301 LEWIS-CLARK TRAIL MARKER
- I4-401 SCENIC AND RECREATIONAL HIGHWAY MARKER
- I5-103 HERITAGE MARKER _____ MILE
- I5-104 HERITAGE MARKER W/ARROW
- I5-5 AIRPORT (SYMBOL)
- I5-6 BUS STATION (SYMBOL)
- I5-7 TRAIN STATION (SYMBOL)
- I5-801 FERRY (SYMBOL/CAR BOARDING FERRY)
- I5-801A FERRY (SYMBOL/FERRY)
- I6-101 DEPOSIT LITTER _____ MILE(S)
- I6-102 LITTER AND IT WILL HURT
- I6-201 LITTER SYMBOL SIGN
- I6-301 THROWING AWAY BURNING MATERIAL PROHIBITED
- I6-801 AUTOMOBILE LITTER ONLY
- I6-901 ADOPT-A-HIGHWAY (SMALL)
- I6-902 ADOPT-A-HIGHWAY "GROUP'S NAME (HERE)"(SMALL)
ADOPT-A-HIGHWAY "THIS AREA AVAILABLE"/PHONE NUMBER
(SMALL)
- I6-903 (SMALL)
- I6-901A ADOPT-A-HIGHWAY (LARGE)
- I6-902A ADOPT-A-HIGHWAY "GROUP'S NAME (HERE)"(LARGE)
ADOPT-A-HIGHWAY "THIS AREA AVAILABLE"/PHONE NUMBER
(LARGE)
- I6-903A (LARGE)
- I6-904 ADOPT-A-HIGHWAY LITTER CONTROL
- I6-905A ADOPT-A-HIGHWAY MEDIAN NEXT _____MILES
- I7-301 BRIDGE NUMBER
- I7-401 FIRE HYDRANT MARKER
- I7-501 TURN ON LIGHTS
- I7-601 LIGHTS ?
- I7-7 CAUTION-NO WARNING SIGNS
- I7-701 PRIMITIVE ROAD NO WARNING SIGNS
- I7-702 NEXT _____ MILES
- I7-901 HITCHHIKING PERMITTED
- I8-101 SLOW VEHICLES USE TURNOUTS NEXT _____ MILES
- I8-201 DELAY OF 5 VEHICLES ILLEGAL MUST USE TURNOUTS
- I8-301 SLOW VEHICLE TURNOUT (ARROW _____ DEGREES)
- I8-401 SLOW VEHICLE TURNOUT _____
- I8-501 SLOW VEHICLES MAY USE SHOULDER
- I8-601 END SHOULDER DRIVING
- I8-701 DAYLIGHT HOURS ONLY
- I8-702 PLEASE LIMIT YOUR STAY TO 8 HOURS NO TENTS OR CAMPS
- I8-703 NOTICE-PARKING/COMMUTERS ONLY
- I8-704 COMMERCIAL VEHICLE USE PROHIBITED
- I8-705 LEAN WATER ARROW DIRECTIONAL
- I8-706 CLEAN WATER - USE FOR FILLING DOMESTIC TANKS ONLY
- I8-708 DUMP STATION INSTRUCTIONS
- I8-709 WATER UNSAFE TO DRINK

* denotes variable message sign

I8-801	MOWING TEST AREA
I8-804	ENTERING FIRE DISTRICT NO. _____
I8-901	STATE LAW ALL VEHICLES MUST KEEP TO RIGHT EXCEPT TO PASS
I8-1001	STATE LAW-MOTORCYCLISTS MUST WEAR HELMETS
I9-101	PLAYGROUND
I20-101	REPORT DRUNK DRIVING
I20-201	PLEASE DON'T DRINK AND DRIVE
I20-203	IN MEMORY OF _____
I20-204	SPONSORED BY THE _____ FAMILY
I20-301	TRAFFIC FINES DOUBLE IN WORK ZONES
I25-101	TSUNAMI EVACUATION ROUTE
I25-102	TSUNAMI WARNING
I25-201	VOLCANO EVACUATION ROUTE
I30-101	SPEEDOMETER CHECK SECTION AHEAD
I30-301	END CHECK MILE _____
I30-301A	BEGIN CHECK MILE _____
I30-401	MILE _____
I35-101	TRAVELER INFO TUNE _____ AM TRAFFIC ADVISORY WHEN FLASHING
I35-102	TRAVELER INFO DIAL 511

L SERIES

LG-C1	GAS, FOOD, LODGING NEXT RIGHT/LEFT (CONVENTIONAL ROADS)*
LG-C2	TOURIST ACTIVITIES (CONVENTIONAL ROADS)*
LG-C3	RECREATION (CONVENTIONAL ROADS)*
LG-M1	GAS EXIT XXX, HORIZONTAL PANEL (FREEWAY)*
LG-M1A	GAS EXIT XXX, VERTICAL PANEL (FREEWAY)*
LG-M2	GAS (FREEWAY DOUBLE EXITS)*
LG-M3	FOOD EXIT XXX (FREEWAY)*
LG-M3A	FOOD EXIT XXX, VERTICAL PANEL (FREEWAY)*
LG-M4	FOOD (FREEWAY DOUBLE EXIT)*
LG-M5	LODGING EXIT XXX (FREEWAY)*
LG-M5A	LODGING EXIT XXX, VERTICAL PANEL (FREEWAY)*
LG-M6	LODGING (FREEWAY DOUBLE EXIT)*
LG-M7	RECREATION NEXT RIGHT (FREEWAY)*
LG-M8	RECREATION (FREEWAY DOUBLE EXIT)*
LG-M9	TOURIST ACTIVITIES EXIT XXX (FREEWAY)*
LG-M9A	TOURIST ACTIVITIES EXIT XXX, VERTICAL PANEL (FREEWAY)*
LG-M10	TOURIST ACTIVITIES (FREEWAY DOUBLE EXIT)*
LG-R1	GAS FOOD LODGING (RAMPS)*
LG-R2	RECREATION (RAMPS)*
LG-R3	TOURIST ACTIVITIES (RAMP)*
LG-R4	GAS, FOOD (RAMPS WITH ROUNDABOUTS)*

* denotes variable message sign

M SERIES

M1-1	INTERSTATE _____	
M1-2	INTERSTATE BUSINESS LOOP _____	
M1-3	INTERSTATE BUSINESS SPUR _____	
M1-4	U.S. _____	
M1-4A	U.S. _____ (GUIDE SIGN USE)	
M1-401	U.S. _____ (DIRECTIONAL)	
M1-601	STATE ROUTE _____	
M1-602	STATE ROUTE _____ (GUIDE SIGN USE)	
M1-7	_____ NATIONAL FOREST (FOREST SERVICE ROUTE MARKER)	
M1-701	STATE ROUTE _____ (DIRECTIONAL)	
M1-8	BIKE SYMBOL ____ (BICYCLE ROUTE MARKER)	
M1-9	_____ BIKE SYMBOL (INTERSTATE BIKE ROUTE MARKER)	
M2-1	JCT	
M2-2	JUNCTION _____	
M3-1	NORTH	
M3-1B	NORTH	
M3-2	EAST	
M3-2B	EAST	
M3-3	SOUTH	
M3-3B	SOUTH	
M3-4	WEST	
M3-4B	WEST	
M4-1	ALTERNATE PLAQUE	
M4-101	ALT PLAQUE	
M4-2	BYPASS	
M4-3	BUSINESS	
M4-4	TRUCK	
M4-5	TO	
M4-5B	TO	
M4-6	END	
M4-7	TEMPORARY	
M4-7A	TEMPORARY, BLACK ON WHITE	
M4-7B	TEMPORARY, WHITE ON BLUE	
M4-8	DETOUR	
M4-9L/R	LEFT/RIGHT DETOUR (ARROW _____ DEGREES)	
M4-9A	BICYCLE/PEDESTRIAN DETOUR	
M4-9B	PEDESTRIAN DETOUR	
M4-9C	BICYCLE DETOUR	
M4-10	L/R LEFT/RIGHT DETOUR (ARROW)	
M4-11	BEGIN	
M4-12	END	
M4-13	TO	
M4-1101	BEGIN (BICYCLE ROUTE)	
M4-1201	END (BICYCLE ROUTE)	
M4-1301	TO (BICYCLE ROUTE)	
M5-1	ADVANCE TURN ARROW 90 DEGREES	

* denotes variable message sign

M5-1B	ADVANCE TURN ARROW 90 DEGREES	
M5-2	ADVANCE TURN ARROW 45 DEGREES	
M5-2B	ADVANCE TURN ARROW 45 DEGREES	
M6-1	DIRECTIONAL ARROW 90 DEGREE	
M6-1B	DIRECTIONAL ARROW 90 DEGREE	
M6-2	DIRECTIONAL ARROW 45 DEGREES	
M6-2B	DIRECTIONAL ARROW 45 DEGREES	
M6-3	DIRECTIONAL ARROW 360 DEGREES	
M6-3B	DIRECTIONAL ARROW 360 DEGREES	
M6-4	DIRECTIONAL ARROW 2 HEADS 90 DEGREES/270 DEGREES	
M6-4B	DIRECTIONAL ARROW 2 HEADS 90 DEGREES/270 DEGREES	
M6-5	DIRECTIONAL ARROW 2 HEADS 45 DEGREES/225 DEGREES	
M6-5B	DIRECTIONAL ARROW 2 HEADS 45 DEGREES/225 DEGREES	
M6-6	DIRECTIONAL ARROW 2 HEADS 360 DEGREES/90 DEGREES	
M6-6B	DIRECTIONAL ARROW 2 HEADS 360 DEGREES/90 DEGREES	
M6-7	DIRECTIONAL ARROW 2 HEADS 360 DEGREES/45 DEGREES	
M6-7B	DIRECTIONAL ARROW 2 HEADS 360 DEGREES/45 DEGREES	
M7-1	BICYCLE DIRECTIONAL ARROW 90 DEGREES	
M7-2	BICYCLE DIRECTIONAL ARROW 360 DEGREES	
M7-3	BICYCLE DIRECTIONAL ARROW 2 HEADS 45 DEGREES/225 DEGREES	
M7-4	BICYCLE DIRECTIONAL ARROW 45 DEGREES	
M7-5	BICYCLE DIRECTIONAL ARROW 2 HEADS 90 DEGREES/270 DEGREES	
M7-6	BICYCLE DIRECTIONAL ARROW 2 HEADS 360 DEGREES/90 DEGREES	
M7-7	BICYCLE DIRECTIONAL ARROW 2 HEADS 360 DEGREES/45 DEGREES	
M8-101	ROUTE MARKER ASSEMBLY W/ARROW*	
M8-201	ROUTE MARKER ASSEMBLY W/ARROWS*	
M8-301	ROUTE MARKER ASSEMBLY W/ARROWS*	
M8-401	ROUTE MARKER ASSEMBLY W/TWO SHIELDS*	

P SERIES

P-1	BEGINNING OF PROJECT
P-2	END OF PROJECT
P-3	STOCKPILE
P-4	PIT SITE
P-5	STOCK PILE _____ MILES
P-6	PIT SIZE/MILES*

R SERIES

R1-1	STOP	
R1-2	YIELD	
R1-2A	TO ONCOMING TRAFFIC	
R1-3	4-WAY*	
R1-4	ALL WAY	
R1-5L&R	YIELD HERE TO PEDESTRIANS	
R1-6A	IN-STREET PEDESTRIAN CROSSING	
R2-1	SPEED LIMIT _____	
R2-2	TRUCKS _____	

* denotes variable message sign

R2-3	NIGHT _____	
R2-4	MINIMUM SPEED _____	
R2-4A	SPEED LIMIT _____ MINIMUM _____	
R2-501	_____ MPH	
R3-1	NO RIGHT TURN SYMBOL	
R3-2	NO LEFT TURN SYMBOL	
R3-3	NO TURNS	
R3-4	NO U TURN SYMBOL	
R3-5	LEFT ONLY ARROW	
R3-5A	DOUBLE (LEFT ARROW) ONLY	
R3-501	(ARROW 360 DEGREES) STRAIGHT ONLY	
R3-6	LEFT TURN, STRAIGHT ARROWS	
R3-7L	LEFT LANE MUST TURN LEFT	
R3-7R	RIGHT LANE MUST TURN RIGHT	
R3-701	RIGHT LANE MUST EXIT	
R3-702	RIGHT TURN PERMITTED WITHOUT STOPPING	
R3-703	USE RIGHT LANE TO EXIT	
R3-8	(LEFT ARROW) ONLY (LEFT STRAIGHT ARROWS) (LEFT ARROW) ONLY (LEFT STRAIGHT ARROWS) (RIGHT ARROW)	
R3-8A	ONLY	
R3-801	(LEFT ARROW) ONLY (STRAIGHT ARROW) ONLY	
R3-802	(LEFT ARROW) ONLY (LEFT RIGHT ARROWS)	
R3-9A	(TWO WAY LEFT TURN)ONLY (OVERHEAD MOUNTED)	
R3-9B	CENTER LANE (TWO WAY LEFT TURN) ONLY (POST MOUNTED)	
R3-10	RESTRICTED LANE AHEAD	
R3-102	LEFT LANE RESTRICTION 1/4 MI. AHEAD	
R3-103	LEFT LANE RESTRICTION AHEAD	
R3-11	_____ BUSES AND CAR POOLS ONLY _____	
R3-1102L	LT LANE (BUS & _____ CARPOOL SYMBOLS) ONLY ____ AM - ____ PM MOTORCYCLES OK	
R3-1102R	RT LANE (BUS & _____ CARPOOL SYMBOLS) ONLY ____ AM - ____ PM MOTORCYCLES OK	
R3-1103L	LEFT LANE (BUS & _____ CARPOOL SYMBOLS) ONLY, MOTORCYCLES OK	
R3-1103R	RIGHT LANE (BUS & _____ CARPOOL SYMBOLS) ONLY, MOTORCYCLES OK	
R3-1104L	LEFT LANE (BUS & _____ PERSON CARPOOL SYMBOLS) ARROW	
R3-1104R	RIGHT LANE (BUS & _____ PERSON CARPOOL SYMBOLS) ARROW	
R3-12	RESTRICTED LANE ENDS	
R3-1201	LEFT LANE RESTRICTION ENDS	
R3-1202	LEFT LANE RESTRICTION ENDS 1/4 MI.	
R3-1203	RESTRICTED LANE EXIT ONLY	
R3-1204	LEFT LANE OPEN TO ALL TRAFFIC	
R3-13	RESTRICTED LANE AHEAD	
R3-14	BUSES AND _____ PERSON CAR POOLS ONLY _____ ARROW 180 _____	

* denotes variable message sign

R3-1401	(BUS & ____ PERSON CARPOOL SYMBOLS) ONLY ARROW 180 (BUS & ____ PERSON CARPOOL SYMBOLS) ____ AM - ____ PM ONLY	
R3-1402	ARROW 180	
R3-15	RESTRICTED LANE ENDS	
R3-1502	TRANSIT LANE ENDS	
R3-1503	TRANSIT LANE ENDS ____ MILES	
R3-17	(BIKE SYMBOL) ONLY	
R3-17A	LEFT (BIKE SYMBOL) RIGHT (PARKING ALLOWED SYMBOL) ONLY	
R3-17B	AHEAD	
R3-17C	ENDS	
R3-18	COMBINED U-TURN & LEFT TURN PROHIBITION	
R3-2001	RIGHT LANE BUSES ONLY	
R3-2002	TRANSIT (BUS SYMBOL) ONLY	
R3-2003	TRANSIT ONLY ARROW 315	
R3-2004	RIGHT LANE TRANSIT ONLY EXCEPT RIGHT TURNS RIGHT LANE (BUS & ____ PERSON CARPOOL SYMBOL) EXCEPT	
R3-2005	RIGHT TURNS	
R4-1	DO NOT PASS	
R4-2	PASS WITH CARE	
R4-3	SLOWER TRAFFIC KEEP RIGHT	
R4-301	KEEP RIGHT EXCEPT TO PASS VEHICLES WITH TRAILERS OR OVER 10,000 LBS PROHIBITED IN LEFT	
R4-302	LANE	
R4-302A	TRUCKS OVER 10,000 LBS USE RIGHT ____ LANES ONLY VEHICLES WITH TRAILERS OR OVER 10,000 LBS USE	
R4-302B	RIGHT ____ LANES ONLY	
R4-4	BEGIN RIGHT TURN LANE-YIELD TO BIKES	
R4-5	TRUCKS USE RIGHT LANE	
R4-6	TRUCK LANE ____ FEET	
R4-601	PASSING LANE _____ MILES	
R4-602	NEXT PASSING LANE _____ MILES	
R4-604	USE OF COMPRESSION BRAKES PROHIBITED	
R4-605	UNMUFFLED COMPRESSION BRAKES PROHIBITED	
R4-7	KEEP RIGHT SYMBOL	
R4-7A	KEEP RIGHT HORIZONTAL ARROW	
R4-7B	KEEP RIGHT 30 DEGREE ARROW	
R4-8	KEEP LEFT SYMBOL	
R4-9	STAY IN LANE	
R4-901	NO PASSING ON BRIDGE	
R4-10	RUNAWAY VEHICLES ONLY	
R5-1	DO NOT ENTER	
R5-1A	WRONG WAY	
R5-1B	BICYCLES WRONG WAY	
R5-2	NO TRUCKS SYMBOL	
R5-3	NO MOTOR VEHICLES	
R5-4	COMMERCIAL VEHICLES EXCLUDED	
R5-5	VEHICLES WITH LUGS PROHIBITED	

* denotes variable message sign

R5-6	NO BICYCLES SYMBOL
R5-601	BICYCLES MUST EXIT
R5-602	BICYCLES AND MOTORIZED FOOT SCOOTERS MUST EXIT ____ MILE
R5-10A	PEDS, BICYCLES, MOTOR-DRIVEN CYCLES PROHIBITED
R5-10B	PEDESTRIANS AND BICYCLES PROHIBITED
R5-10C	PEDESTRIANS PROHIBITED
R5-1001	PEDESTRIANS, HITCHHIKERS, PROHIBITED
R5-1002	PEDESTRIANS, HITCHHIKERS, BICYCLES PROHIBITED
R5-1003	BICYCLES AND MOTORIZED FOOT SCOOTERS PROHIBITED PEDESTRIANS, HITCHHIKERS, BICYCLES, AND MOTORIZED
R3-1004	FOOT SCOOTERS PROHIBITED
R5-1201	MOTORCYCLES ONLY
R5-1301	COMPACT CARS ONLY
R6-1 L	ONE WAY (LEFT)
R6-1 R	ONE WAY (RIGHT)
R6-2 L	ONE WAY (LEFT)
R6-2 R	ONE WAY (RIGHT)
R6-3	DIVIDED HIGHWAY
R6-3A	DIVIDED HIGHWAY
R7-1	NO PARKING ANYTIME (ARROW)
R7-101	NO PARKING ANYTIME
R7-102	NO PARKING ANYTIME (DOUBLE HEADED ARROW)
R7-107	NO PARKING BUS STOP (ARROW)
R7-107A	NO PARKING BUS STOP SYMBOL WITH TRANSIT LOGO
R7-108	RESTRICTED PARKING XXXX TO XXXX *
R7-2	NO PARKING XXXX TO XXXX *
R7-2A	NO PARKING SYMBOL (TIME) TO (TIME)*
R7-201	TOW-AWAY ZONE
R7-201A	TOW-AWAY ZONE SYMBOL
R7-202	NO PARKING (TIME) TO (TIME)*
R7-203	EMERGENCY SNOW ROUTE, NO PARKING IF OVER TWO INCHES
R7-3	NO PARKING EXCEPT SUNDAYS AND HOLIDAYS (ARROW)
R7-301	NO PARKING EXCEPT SUNDAYS
R7-4	NO STANDING ANYTIME _____ ARROW
R7-401	NO STOPPING OR STANDING W / ARROW
R7-402	NO STOPPING OR STANDING
R7-5	ONE HOUR PARKING (TIME) TO (TIME)*
R7-6	NO PARKING LOADING ZONE (DOUBLE ARROW)
R7-601	NO PARKING LOADING ZONE
R7-7	NO PARKING BUS STOP _____ ARROW
R7-701	NO PARKING BUS STOP
R7-801	RESERVED PARKING (DISABLED LOGO)
R7-801A	VAN ACCESSIBLE
R7-801P	STATE DISABLED PARKING PERMIT REQUIRED
R7-9	NO PARKING BIKE LANE
R7-9A	NO PARKING SYMBOL BIKE LANE
R7-10801	15 MINUTE PARKING*

* denotes variable message sign

R7-10802	PARALLEL PARKING ONLY
R8-1	NO PARKING ON PAVEMENT
R8-2	NO PARKING EXCEPT ON SHOULDER
R8-3	NO PARKING
R8-3A	NO PARKING SYMBOL
R8-3AP	EXCEPTION PLAQUE*
R8-3C	ON PAVEMENT
R8-3D	ON BRIDGE
R8-301	NO PARKING BEYOND THIS POINT
R8-4	EMERGENCY PARKING ONLY
R8-5	NO STOPPING ON PAVEMENT
R8-6	NO STOPPING EXCEPT ON SHOULDERS
R8-7	EMERGENCY STOPPING ONLY
R8-8	NO STOPPING ON TRACKS
R8-9	TRACKS OUT OF SERVICE
R8-1201	48 HOURS MAXIMUM PARKING
R9-1	WALK ON LEFT FACING TRAFFIC
R9-2	CROSS ONLY AT CROSSWALKS
R9-3	NO PEDESTRIAN CROSSING
R9-3A	NO PEDESTRIAN CROSSING SYMBOL
R9-3BL	USE CROSSWALK (ARROW LEFT)
R9-3BR	USE CROSSWALK (ARROW RIGHT)
R9-3C	RIDE WITH TRAFFIC
R9-4	NO HITCHHIKING
R9-4A	NO HITCHHIKING SYMBOL
R9-5	BIKE (SYMBOL) USE PEDESTRIAN SIGNAL
R9-6	BIKE (SYMBOL) YIELD TO PEDS
R9-7	KEEP LEFT/RIGHT (PED & BIKE SYMBOLS)*
R9-8	PEDESTRIAN CROSSWALK
R9-9	SIDEWALK CLOSED
R9-10	SIDEWALK CLOSED (DOUBLE HEADED ARROW) USE OTHER SIDE
R9-11	SIDEWALK CLOSED AHEAD (SINGLE HEAD ARROW) CROSS HERE
R9-11A	SIDEWALK CLOSED (SINGLE HEAD ARROW) CROSS HERE
R10-1	CROSS ON GREEN LIGHT ONLY
R10-2	CROSS ON WALK SIGNAL ONLY
R10-2A	CROSS ON WALK SIGNAL ONLY WITH MAN SYMBOL
R10-3	PUSH BUTTON FOR GREEN LIGHT
R10-3A	TO CROSS STREET PUSH BUTTON - WAIT FOR GREEN LIGHT
R10-4	PUSH BUTTON FOR WALK SIGNAL
R10-4A	TO CROSS STREET PUSH BUTTON WAIT FOR WALK SIGNAL
R10-4001	PUSH BUTTON FOR WALK SIGNAL-DIRECTIONAL ARROW LEFT
R10-4002	PUSH BUTTON FOR WALK SIGNAL-DIRECTIONAL ARROW RIGHT
R10-5	LEFT ON ARROW ONLY
R10-6L	STOP HERE ON RED DIRECTIONAL ARROW
R10-6R	STOP HERE ON RED DIRECTIONAL ARROW
R10-6A	STOP HERE ON RED CURVED ARROW

* denotes variable message sign

R10-601L&R	STOP HERE ON RED DIRECTIONAL ARROW 1 CAR PER GREEN	
R10-7	DO NOT BLOCK INTERSECTION	
R10-701	ONE VEHICLE IN MEDIAN AT A TIME	
R10-8	USE LANE WITH GREEN ARROW	
R10-10L	LEFT TURN SIGNAL	
R10-10R	RIGHT TURN SIGNAL	
R10-11	NO TURN ON RED BALL	
R10-11A	NO TURN ON RED	
R10-11B	NO TURN ON RED	
R10-11C	(NO RIGHT TURN SYMBOL) ON RED	
R10-11D	(NO LEFT TURN SYMBOL) ON RED	
R10-12	LEFT TURN YIELD ON GREEN BALL	
R10-1201	LEFT TURN MUST YIELD	
R10-13	EMERGENCY SIGNAL	
R10-1401	TWO CARS PER GREEN	
R10-1402	1 CAR PER GREEN THIS LANE	
R10-1403	1 CAR PER GREEN EACH LANE	
R10-1404	ONE CAR PER GREEN	
R10-1405	ONE CAR PER GREEN EACH LANE	
R10-15	TURNING TRAFFIC MUST YIELD TO PEDESTRIANS	
R10-16	U-TURN YIELD TO RIGHT TURN	
R10-17A	RIGHT ON RED ARROW AFTER STOP	
R10-18	TRAFFIC LAWS PHOTO ENFORCED	
R10-19	PHOTO ENFORCED	
R10-20A	MON-FRI ___ AM ___ PM	
R10-20B	SUNDAY ___ AM	
R10-21	LEFT TURN SIGNAL - YIELD ON GREEN BALL	
R10-22	TO REQUEST GREEN WAIT ON BICYCLIST SYMBOL	
R11-1	KEEP OFF MEDIAN	
R11-2	ROAD CLOSED	
R11-201	RAMP CLOSED	
R11-3	ROAD CLOSED _____ MILES AHEAD LOCAL TRAFFIC ONLY	
R11-3A	BRIDGE OUT _____ MILES AHEAD LOCAL TRAFFIC ONLY	
R11-3(MOD.)	MILITARY ROAD CLOSED _____ MILES AHEAD LOCAL TRAFFIC ONLY	
R11-4	ROAD CLOSED TO THRU TRAFFIC	
R11-501	DO NOT DRIVE ON SHOULDER	
R11-1501	RAMP WILL BE CLOSED _____ EXIT WILL BE CLOSED _____	
R12-1	WEIGHT LIMIT ___ TONS	
R12-2	AXLE WEIGHT LIMIT _____ TONS	
R12-3	NO TRUCKS OVER _____ LBS. EMPTY WEIGHT	
R12-4	WEIGHT LIMIT _____ TONS PER AXLE _____ TONS GROSS	
R12-5	WEIGHT LIMIT TRUCK SYMBOLS W/WEIGHT*	
R12-501	WEIGHT RESTRICTIONS IN FORCE	
R12-502	EMERGENCY RESTRICTIONS IN FORCE	
R12-503	EMERGENCY RESTRICTIONS _____ MILES AHEAD ON HWY	
R12-1001	_____ ALL TRUCKS STOP BEFORE MOVING ON BRIDGE	

* denotes variable message sign

- R12-1101 ONE TRUCK AT A TIME ON BRIDGE
- R13-1 ALL TRUCKS COMMERCIAL VEHICLES NEXT RIGHT
- R13-201 TRUCKS OVER 10, 000 GVWR STOP AT SCALES WHEN OPEN
- R13-301 TRUCKS STOP AT SCALES/WEIGH STATION CLOSED
- R13-302 TRUCKS OVER 10,000 GVWR STOP AT SCALES/WEIGH STATION CLOSED
- R13-401 LIVESTOCK INSPECTION REQUIRED STOP AT WEIGH STATION
- R14-1 TRUCK ROUTE
- R14-2 HC SYMBOL
- R14-3 HC PROHIBITED SYMBOL
- R14-4 TRUCK SYMBOL
- R14-5 TRUCK PROHIBITED SYMBOL
- R15-1 R/R CROSSING(CROSS BUCK)
- R15-2 _____ TRACKS
- R15-3 EXEMPT
- R16-101 USE RIGHT SHOULDER TO INSTALL CHAINS
- R16-102 USE RIGHT SHOULDER TO REMOVE CHAINS
- R16-203 NOV 1 TO APR 1/EXCEPT ALL-WHEEL DRIVE
- R16-2100 ALL VEHICLES CARRY CHAINS
- R16-2101 VEHICLES OVER 10,000 GVWR CHAINS REQUIRED
- R16-2102 ALL VEHICLES CHAINS REQUIRED
- R16-2103 TRACTION ADVISORY OVERSIZED VEHICLES PROHIBITED
- R16-301 CHAIN ENFORCEMENT ENDS HERE
- R16-501 VEHICLES OVER 10,000 LBS GROSS MUST USE CHAINS
- R16-501A VEHICLES OVER 10,000 GVW USE CHAINS WHEN TRAC. TIRES REQ.
- R16-601 CHAIN-UP PARKING ONLY
- R16-701 CHAIN-OFF PARKING ONLY
- R17-101 KEEP OFF WET PAINT
- R17-2 NO TRESPASSING
- R18-101 NO FISHING FROM BRIDGE
- R18-201 DO NOT ROLL ROCKS ENDANGERS PEOPLE BELOW
- R18-301 NO DUMPING ALLOWED

S SERIES

- S1-1 SCHOOL ADVANCE SIGN
- S3-1 SCHOOL BUS STOP AHEAD
- S3-201 SCHOOL BUS TURNAROUND
- S4-1 _____ TO _____
- S4-2 WHEN CHILDREN ARE PRESENT
- S4-3 SCHOOL
- S4-4 WHEN FLASHING
- S4-5 & 5A SCHOOL DAYS ____AM - ____PM or (5A) ____AM - ____AM & ____PM - ____PM
- S4-501 WHEN FLAGGED
- S5-1 SCHOOL SPEED LIMIT 20 WHEN FLASHING
- S5-101 SCHOOL SPEED LIMIT 20 WHEN CHILDREN ARE PRESENT
- S5-2 END SCHOOL ZONE

W SERIES

W1-1L	LEFT TURN
W1-1R	RIGHT TURN
W1-2L	CURVE LEFT
W1-2R	CURVE RIGHT
W1-3L	REVERSE TURN LEFT
W1-3R	REVERSE TURN RIGHT
W1-4L	REVERSE CURVE LEFT
W1-4R	REVERSE CURVE RIGHT
W1-4BR	2 CURVE RIGHT ARROWS
W1-4CR	3 CURVE RIGHT ARROWS
W1-5L	WINDING ROAD LEFT
W1-5R	WINDING ROAD RIGHT
W1-6	LARGE ARROW _____
W1-7	LARGE ARROW (2-HEADS)
W1-8	CHEVRON ALIGNMENT SIGN
W1-901L	180 DEGREE CURVE LEFT
W1-901R	180 DEGREE CURVE RIGHT
W1-101L/R	HORIZONTAL ALIGNMENT
W1-15	270 DEGREE LOOP
W2-1	CROSS ROAD SYMBOL
W2-2	SIDE ROAD SYMBOL
W2-3	SIDE ROAD SYMBOL 45 DEGREES
W2-4	T (SYMBOL)
W2-401	ARROW (315 DEGREES)
W2-5	Y (SYMBOL)
W2-6	ROUNDAABOUT AHEAD (SYMBOL)
W2-6P	ROUNDAABOUT AHEAD PLAQUE
W2-601	LEFT TURNS AHEAD
W3-1	STOP AHEAD
W3-1A	STOP AHEAD (SYMBOL)
W3-2A	YIELD AHEAD (SYMBOL)
W3-3	SIGNAL AHEAD (SYMBOL)
W3-401	EMERGENCY SIGNAL AHEAD
W3-5	SPEED LIMIT REDUCTION AHEAD
W3-501	RAMP METERING AHEAD WHEN FLASHING
W4-1L	MERGING FROM LEFT
W4-1R	MERGING FROM RIGHT
W4-2L	PAVEMENT WIDTH TRANSITION LEFT
W4-2R	PAVEMENT WIDTH TRANSITION RIGHT
W4-3L	ADDED LANE SYMBOL LEFT
W4-3R	ADDED LANE SYMBOL RIGHT
W4-4P	CROSS TRAFFIC DOES NOT STOP
W4-5	ENTERING ROADWAY MERGE
W4-6	ENTERING ROADWAY ADDED LANE
W5-1	ROAD NARROWS
W5-2	NARROW BRIDGE
W5-3	ONE LANE BRIDGE
W5-4	BIKEWAY NARROWS
W6-1	DIVIDED HIGHWAY

W6-2	DIVIDED HIGHWAY ENDS
W6-3	TWO WAY TRAFFIC (SYMBOL)
W6-401	FREEWAY ENDS _____ MILE
W7-1	HILL SYMBOL
W7-101	HILL
W7-2B	TRUCKS USE LOWER GEAR
W7-3	_____ % GRADE
W7-3A	NEXT _____ MILES
W7-3B	_____ % GRADE _____ MILES
W7-4	RUNAWAY TRUCK RAMP _____ MILE
W7-4A	RUNAWAY TRUCK RAMP ARROW _____ DEGREES
W7-4B	TRUCK ESCAPE RAMP
W7-4C,D,&E	TRUCK ESCAPE RAMP PLAQUES, SAND, GRAVEL, & PAVED
W7-5	HILL (BICYCLE SYMBOL)
W8-1	BUMP
W8-2	DIP
W8-3	PAVEMENT ENDS
W8-4	SOFT SHOULDER
W8-5	SLIPPERY WHEN WET SYMBOL
W8-6	TRUCK CROSSING
W8-7	LOOSE GRAVEL
W8-8	ROUGH ROAD
W8-10	SLIPPERY WHEN WET (BICYCLE SYMBOL)
W8-11	UNEVEN LANES
W8-12	NO CENTER STRIPE
W8-1501	WATER OVER ROADWAY
W8-1601	WATCH FOR ICE
W8-1701	ROCKS
W8-1801	NO SHOULDER
W8-1901	SLIDE AREA
W8-2001	GROOVED PAVEMENT
W8-2101	GRATED BRIDGE DECK
W8-2201	PAVEMENT RUTS
W9-1L	LEFT LANE ENDS
W9-1R	RIGHT LANE ENDS
W9-2L	LANE ENDS MERGE LEFT
W9-2R	LANE ENDS MERGE RIGHT
W10-1	RAILROAD ADVANCE SIGN
W10-101	EXEMPT PLAQUE
W10-1A	EXEMPT PLAQUE
W10-101P	BICYCLES USE CAUTION PLAQUE
W10-2	CROSSROADS RAILROAD SIGN
W10-3	SIDE ROAD RAILROAD SIGN _____
W10-4	T SYMBOL RAILROAD SIGN
W10-9	NO TRAIN HORN
W10-10	NO SIGNAL
W10-11A	_____ FEET BETWEEN TRACKS AND HIGHWAY
W10-12	SKEWED CROSSING
W10-13	NO GATES OR LIGHTS
W11A-301	CROSSWALK (OVERHEAD)

W11A-501	PEDESTRIANS/BICYCLES
W11-1	BICYCLE CROSSING
W11-2	ADVANCE PEDESTRIAN CROSSING
W11-3	DEER CROSSING
W11-4	CATTLE CROSSING
W11-5	FARM MACHINERY
W11-6	SNOWMOBILE CROSSING
W11-7	EQUESTRIAN CROSSING
W11-8	FIRE STATION
W11-9	HANDICAPPED CROSSING
W11-10	TRUCK CROSSING (SYMBOL)
W11-101	BIKES ON ROAD
W11-12P	EMERGENCY SIGNAL AHEAD
W11-1301	CEMETERY ENTRANCE
W12-1	DOUBLE ARROW
W12-2	LOW CLEARANCE SYMBOL _____ FT _____ INCH
W12-301	LOW CLEARANCE _____ FT _____ INCH
W12-302	L/R LOW CLEARANCE MARKER LT./RT.*
W12-401L	LATERAL CLEARANCE MARKER (LEFT)
W12-401R	LATERAL CLEARANCE MARKER (RIGHT)
W12-501	IMPACT ATTENUATOR MARKING
W12-502	IMPACT ATTENUATOR MARKING
W13-1	_____ MPH
W13-2	EXIT _____ MPH
W13-3	RAMP _____ MPH
W13-4	ON RAMP
W13-401	FOR _____ MI.
W13-501	_____ MILES
W14-1	DEAD END
W14-1P	DEAD END WITH ARROW
W14-2	NO OUTLET
W14-2P	NO OUTLET WITH ARROW
W14-3	NO PASSING ZONE
W14-501	TUNNEL
W14-601	SLOW MOVING VEHICLE
W14-701	LOW FLYING AIRCRAFT
W14-801	SEVERE SIDE WIND AHEAD
W14-901	SLOW MOVING VEHICLE (SYMBOL)
W14-1001	DRAW BRIDGE
W14-1002	DRAW BRIDGE AHEAD
W14-1101	TRANSIT STOP AHEAD (SYMBOL)
W14-1601	MOUNTAIN PASS AHEAD DRIVE CAREFULLY
W14-2202	CONGESTED AREA
W14-2203	CONGESTION AHEAD
W15-1	PLAYGROUND (SYMBOL)
W15-201	FIRE STATION AHEAD
W15-301	HOSPITAL

* denotes variable message sign

W16-101	END OF ROAD MARKER (REFL)
W16-102	END OF ROAD MARKER (NON-REFL)
W16-5PL	SUPPLEMENTAL ARROW 90 PLAQUE (LEFT)
W16-5PR	SUPPLEMENTAL ARROW 270 PLAQUE (RIGHT)
W16-6PL	ADVANCE SUPPLEMENTAL ARROW 90 PLAQUE (LEFT)
W16-6PR	ADVANCE SUPPLEMENTAL ARROW 270 PLAQUE (RIGHT)
W16-7L	DIAGONAL DOWNWARD ARROW 135 PLAQUE (LEFT)
W16-7R	DIAGONAL DOWNWARD ARROW 215 PLAQUE (RIGHT)
W16-9P	AHEAD
W16-10	PHOTO ENFORCED
W17-1	SPEED HUMP
W20-1	ROAD WORK AHEAD
W20-2	DETOUR AHEAD
W20-3	ROAD/STREET/RAMP CLOSED AHEAD*
W20-301	SHOULDER CLOSED
W20-303	RIGHT SHOULDER CLOSED
W20-4	ONE LANE ROAD AHEAD
W20-5	RIGHT/LEFT LANE CLOSED AHEAD*
W20-501	RIGHT TWO LANES CLOSED AHEAD
W20-7A	FLAGGER (SYMBOL)
W20-7B	BE PREPARED TO STOP
W20-901	TRAFFIC REVISION AHEAD
W20-902	NEW SIGNAL AHEAD
W20-903	SIGNAL REVISION AHEAD
W21-1A	WORK CREW (SYMBOL)
W21-2	FRESH OIL/TAR
W21-3	ROAD MACHINERY AHEAD
W21-30	TRUCKS ENTERING HIGHWAY
W21-30A	TRUCKS LEAVING HIGHWAY
W21-5	SHOULDER WORK
W21-6	SURVEY CREW
W21-701	SHOULDER DROP-OFF
W21-801	ABRUPT LANE EDGE
W21-901	BRIDGE REPAIR AHEAD
W21-1001	BRIDGE PAINTING AHEAD
W21-1201	FLAGGER'S PADDLE
W21-1202	HANDLE AND STAFF FOR FLAG PADDLE
W21-1601	FLYING ROCK
W21-1701	MOTORCYCLES USE EXTREME CAUTION
W22-1	BLASTING ZONE AHEAD
W22-2	TURN OFF 2-WAY RADIO AND CELLULAR PHONES
W22-3	END BLASTING ZONE
W24-101	TRAFFIC SURVEY AHEAD

* denotes variable message sign

APPENDICES

Appendix A Sign Sizing, Layout, and Spacing	
Appendix B Guide Sign Arrows	
Appendix C Letter Spacing for Upper and Lower Case	
Appendix D Graphics Templates	
Appendix E Express Lane Gate Arm	

W21-801	ABRUPT LANE EDGE
W4-3L	ADDED LANE SYMBOL LEFT
W4-3R	ADDED LANE SYMBOL RIGHT
I6-901A	ADOPT-A-HIGHWAY (LARGE)
I6-901	ADOPT-A-HIGHWAY (SMALL)
I6-902	ADOPT-A-HIGHWAY "GROUP'S NAME (HERE)"(SMALL)
I6-903A	ADOPT-A-HIGHWAY "THIS AREA AVAILABLE"/PHONE NUMBER (LARGE)
I6-903	ADOPT-A-HIGHWAY "THIS AREA AVAILABLE"/PHONE NUMBER (SMALL)
I6-902A	ADOPT-A-HIGHWAY "GROUP'S NAME (HERE)"(LARGE)
I6-904	ADOPT-A-HIGHWAY LITTER CONTROL
I6-905A	ADOPT-A-HIGHWAY MEDIAN NEXT _____MILES
D1-501	ADVANCE DESTINATION W/ROUTE MARKER*
D1-401	ADVANCE DESTINATION*
E1-1	ADVANCE GUIDE SIGN*
W11-2	ADVANCE PEDESTRIAN CROSSING
D3-2A	ADVANCE STREET NAME SIGN NEXT INTERSECTION
D3-2	ADVANCE STREET NAME SIGN W/ARROW
W16-6PR	ADVANCE SUPPLEMENTAL ARROW 270 PLAQUE (RIGHT)
W16-6PL	ADVANCE SUPPLEMENTAL ARROW 90 PLAQUE (LEFT)
M5-2	ADVANCE TURN ARROW 45 DEGREES
M5-2B	ADVANCE TURN ARROW 45 DEGREES
M5-1	ADVANCE TURN ARROW 90 DEGREES
M5-1B	ADVANCE TURN ARROW 90 DEGREES
E5-4	ADVISORY SPEED PLAQUE FOR EXIT GORE SIGN
R3-17B	AHEAD
W16-9P	AHEAD
I5-5	AIRPORT (SYMBOL)
R13-1	ALL TRUCKS COMMERCIAL VEHICLES NEXT RIGHT
R12-1001	ALL TRUCKS STOP BEFORE MOVING ON BRIDGE
R16-2100	ALL VEHICLES CARRY CHAINS
R16-2102	ALL VEHICLES CHAINS REQUIRED
R1-4	ALL WAY
M4-101	ALT PLAQUE
M4-1	ALTERNATE PLAQUE
D9-13B	AMBULANCE STATION
D1-901	APPROACH DIRECTIONAL SIGN - 1 DESTINATION*
D1-801	APPROACH DIRECTIONAL SIGN - 2 DESTINATIONS*
W2-401	ARROW (315 DEGREES)
R3-501	(ARROW 360 DEGREES) STRAIGHT ONLY
D9-401	ARROW SIGN
I6-801	AUTOMOBILE LITTER ONLY
R12-2	AXLE WEIGHT LIMIT _____ TONS
D10-401	BACK EQ. PLAQUE
W20-7B	BE PREPARED TO STOP
D7-1402	BEACH
M4-11	BEGIN
M4-1101	BEGIN (BICYCLE ROUTE)
I30-301A	BEGIN CHECK MILE _____

* denotes variable message sign

R4-4	BEGIN RIGHT TURN LANE-YIELD TO BIKES
P-1	BEGINNING OF PROJECT
W11-1	BICYCLE CROSSING
M4-9C	BICYCLE DETOUR
M7-7	BICYCLE DIRECTIONAL ARROW 2 HEADS 360 DEGREES/45 DEGREES
M7-6	BICYCLE DIRECTIONAL ARROW 2 HEADS 360 DEGREES/90 DEGREES
M7-3	BICYCLE DIRECTIONAL ARROW 2 HEADS 45 DEGREES/225 DEGREES
M7-5	BICYCLE DIRECTIONAL ARROW 2 HEADS 90 DEGREES/270 DEGREES
M7-2	BICYCLE DIRECTIONAL ARROW 360 DEGREES
M7-4	BICYCLE DIRECTIONAL ARROW 45 DEGREES
M7-1	BICYCLE DIRECTIONAL ARROW 90 DEGREES
M4-9A	BICYCLE/PEDESTRIAN DETOUR
R5-602	BICYCLES AND MOTORIZED FOOT SCOOTERS MUST EXIT ____ MILE
R5-1003	BICYCLES AND MOTORIZED FOOT SCOOTERS PROHIBITED
R5-601	BICYCLES MUST EXIT
W10-101P	BICYCLES USE CAUTION PLAQUE
R5-1B	BICYCLES WRONG WAY
M1-9	____ BIKE SYMBOL (INTERSTATE BIKE ROUTE MARKER)
R9-5	BIKE (SYMBOL) USE PEDESTRIAN SIGNAL
R9-6	BIKE (SYMBOL) YIELD TO PEDS
D11-1	BIKE ROUTE
M1-8	BIKE SYMBOL ____ (BICYCLE ROUTE MARKER)
W11-101	BIKES ON ROAD
W5-4	BIKEWAY NARROWS
W22-1	BLASTING ZONE AHEAD
I7-301	BRIDGE NUMBER
R11-3A	BRIDGE OUT ____ MILES AHEAD LOCAL TRAFFIC ONLY
W21-1001	BRIDGE PAINTING AHEAD
W21-901	BRIDGE REPAIR AHEAD
W8-1	BUMP
I5-6	BUS STATION (SYMBOL)
R3-11	____ BUSES AND CAR POOLS ONLY _____ (BUS & ____ PERSON CARPOOL SYMBOLS) ____ AM - ____ PM ONLY
R3-1402	ARROW 180
R3-1401	(BUS & ____ PERSON CARPOOL SYMBOLS) ONLY ARROW 180
R3-14	BUSES AND ____ PERSON CAR POOLS ONLY ____ ARROW 180 ____
M4-3	BUSINESS
M4-2	BYPASS
D12-201	CAR POOL INFO _____
D12-202	CAR POOL INFO W/SYMBOL _____
W11-4	CATTLE CROSSING
I7-7	CAUTION-NO WARNING SIGNS
W11-1301	CEMETERY ENTRANCE
R3-9B	CENTER LANE (TWO WAY LEFT TURN) ONLY (POST MOUNTED)
R16-301	CHAIN ENFORCEMENT ENDS HERE
R16-701	CHAIN-OFF PARKING ONLY
R16-601	CHAIN-UP PARKING ONLY

W1-8	CHEVRON ALIGNMENT SIGN
I2-301	CITY ENTRANCE SIGN*
E8-2	CITY INTERCHANGE SEQUENCE*
E9-1	CITY NEXT _____ EXITS*
I8-706	CLEAN WATER - USE FOR FILLING DOMESTIC TANKS ONLY
R3-18	COMBINED U-TURN & LEFT TURN PROHIBITION
I8-704	COMMERCIAL VEHICLE USE PROHIBITED
R5-4	COMMERCIAL VEHICLES EXCLUDED
R5-1301	COMPACT CARS ONLY
W14-2202	CONGESTED AREA
W14-2203	CONGESTION AHEAD
I2-201	COUNTY ENTRANCE SIGN*
R10-1	CROSS ON GREEN LIGHT ONLY
R10-2	CROSS ON WALK SIGNAL ONLY
R10-2A	CROSS ON WALK SIGNAL ONLY WITH MAN SYMBOL
R9-2	CROSS ONLY AT CROSSWALKS
W2-1	CROSS ROAD SYMBOL
W4-4P	CROSS TRAFFIC DOES NOT STOP
D13-3	CROSSOVER 1/4 MILE
D13-2	CROSSOVER W/ARROW
D3-102	CROSSROADS NAME SIGN
D3-302	CROSSROADS NAME SIGN W/CHEVRON*
D3-201	CROSSROADS NAME SIGN*
D3-301	CROSSROADS NAME SIGN*
W10-2	CROSSROADS RAILROAD SIGN
W11A-301	CROSSWALK (OVERHEAD)
W1-2L	CURVE LEFT
W1-2R	CURVE RIGHT
I8-701	DAYLIGHT HOURS ONLY
W14-1	DEAD END
W14-1P	DEAD END WITH ARROW
W11-3	DEER CROSSING
I8-201	DELAY OF 5 VEHICLES ILLEGAL MUST USE TURNOUTS
I6-101	DEPOSIT LITTER _____ MILE(S)
M4-8	DETOUR
W20-2	DETOUR AHEAD
W16-7L	DIAGONAL DOWNWARD ARROW 135 PLAQUE (LEFT)
W16-7R	DIAGONAL DOWNWARD ARROW 215 PLAQUE (RIGHT)
E1-4	DIAGRAMMATIC*
W8-2	DIP
M6-7	DIRECTIONAL ARROW 2 HEADS 360 DEGREES/45 DEGREES
M6-7B	DIRECTIONAL ARROW 2 HEADS 360 DEGREES/45 DEGREES
M6-6	DIRECTIONAL ARROW 2 HEADS 360 DEGREES/90 DEGREES
M6-6B	DIRECTIONAL ARROW 2 HEADS 360 DEGREES/90 DEGREES
M6-5	DIRECTIONAL ARROW 2 HEADS 45 DEGREES/225 DEGREES
M6-5B	DIRECTIONAL ARROW 2 HEADS 45 DEGREES/225 DEGREES
M6-4	DIRECTIONAL ARROW 2 HEADS 90 DEGREES/270 DEGREES

* denotes variable message sign

M6-4B	DIRECTIONAL ARROW 2 HEADS 90 DEGREES/270 DEGREES
M6-3	DIRECTIONAL ARROW 360 DEGREES
M6-3B	DIRECTIONAL ARROW 360 DEGREES
M6-2	DIRECTIONAL ARROW 45 DEGREES
M6-2B	DIRECTIONAL ARROW 45 DEGREES
M6-1	DIRECTIONAL ARROW 90 DEGREE
M6-1B	DIRECTIONAL ARROW 90 DEGREE
D9-501	DIRECTIONAL ARROW DETAILS (HORIZONTAL)
D9-502	DIRECTIONAL ARROW DETAILS (VERTICAL)
D1-701	DIRECTIONAL W/ROUTE MARKER*
R6-3	DIVIDED HIGHWAY
R6-3A	DIVIDED HIGHWAY
W6-1	DIVIDED HIGHWAY
W6-2	DIVIDED HIGHWAY ENDS
R10-7	DO NOT BLOCK INTERSECTION
R11-501	DO NOT DRIVE ON SHOULDER
R5-1	DO NOT ENTER
R4-1	DO NOT PASS
R18-201	DO NOT ROLL ROCKS ENDANGERS PEOPLE BELOW
R3-5A	DOUBLE (LEFT ARROW) ONLY
W12-1	DOUBLE ARROW
E3-101	DOUBLE EXIT OR NEXT RIGHT SECOND LEFT*
W14-1001	DRAW BRIDGE
W14-1002	DRAW BRIDGE AHEAD
I8-708	DUMP STATION INSTRUCTIONS
M3-2	EAST
M3-2B	EAST
D8-101	EMERGENCY CALL BOX
D9-13C	EMERGENCY MEDICAL CARE
R8-4	EMERGENCY PARKING ONLY
R12-503	EMERGENCY RESTRICTIONS _____ MILES AHEAD ON HWY _____
R12-502	EMERGENCY RESTRICTIONS IN FORCE
R10-13	EMERGENCY SIGNAL
W3-401	EMERGENCY SIGNAL AHEAD
W11-12P	EMERGENCY SIGNAL AHEAD
R7-203	EMERGENCY SNOW ROUTE, NO PARKING IF OVER TWO INCHES
R8-7	EMERGENCY STOPPING ONLY
M4-6	END
M4-12	END
M4-1201	END (BICYCLE ROUTE)
W22-3	END BLASTING ZONE
I30-301	END CHECK MILE _____
G20-601	END LANE CLOSURE
P-2	END OF PROJECT
W16-102	END OF ROAD MARKER (NON-REFL)
W16-101	END OF ROAD MARKER (REFL)
G20-2A	END ROAD WORK

* denotes variable message sign

S5-2	END SCHOOL ZONE
I8-601	END SHOULDER DRIVING
R3-17C	ENDS
I8-804	ENTERING FIRE DISTRICT NO. _____
I2-601	ENTERING LIMITED ACCESS AREA
W4-6	ENTERING ROADWAY ADDED LANE
W4-5	ENTERING ROADWAY MERGE
W11-7	EQUESTRIAN CROSSING
R8-3AP	EXCEPTION PLAQUE*
R15-3	EXEMPT
W10-101	EXEMPT PLAQUE
E5-1	EXIT (ARROW DEGREES)
W13-2	EXIT _____ MPH
E5-2B	EXIT CLOSED
E6-101	EXIT DIRECTION*
E5-1A	EXIT GORE SIGN WITH EXIT NUMBER AND ARROW*
E5-3	EXIT NUMBER PLAQUE FOR EXIT GORE SIGN
E5-2	EXIT ONLY
E4-501	EXIT ONLY GUIDE SIGN W/ARROW*
E11-1	EXIT ONLY PANELS
E5-2A	EXIT OPEN
E1-5	EXIT PANEL*
W11-5	FARM MACHINERY
W10-11A	_____ FEET BETWEEN TRACKS AND HIGHWAY
I5-801	FERRY (SYMBOL/CAR BOARDING FERRY)
I5-801A	FERRY (SYMBOL/FERRY)
R7-10801	15 MINUTE PARKING*
I7-401	FIRE HYDRANT MARKER
W11-8	FIRE STATION
W15-201	FIRE STATION AHEAD
W20-7A	FLAGGER (SYMBOL)
W21-1201	FLAGGER'S PADDLE
W21-1601	FLYING ROCK
D9-103	FOOD - GAS - LODGING NEXT RIGHT*
D9-102	FOOD - PHONE - GAS - LODGING NEXT RIGHT*
D9-101	FOOD - PHONE - GAS - LODGING, ETC.*
LG-M4	FOOD (FREEWAY DOUBLE EXIT)*
LG-M3	FOOD EXIT XXX (FREEWAY)*
LG-M3A	FOOD EXIT XXX, VERTICAL PANEL (FREEWAY)*
W13-401	FOR _____ MI.
G24-501	FOR PROJECT INFORMATION _____
R8-1201	48 HOURS MAXIMUM PARKING
R1-3	4-WAY*
D13-1	FREE COFFEE
W6-401	FREEWAY ENDS _____ MILE
E12-201	FREEWAY ENTRANCE
W21-2	FRESH OIL/TAR

* denotes variable message sign

LG-M2	GAS (FREEWAY DOUBLE EXITS)*
LG-M1	GAS EXIT XXX, HORIZONTAL PANEL (FREEWAY)*
LG-M1A	GAS EXIT XXX, VERTICAL PANEL (FREEWAY)*
LG-R1	GAS FOOD LODGING (RAMPS)*
LG-R4	GAS, FOOD (RAMPS WITH ROUNDABOUTS)*
LG-CI	GAS, FOOD, LODGING NEXT RIGHT/LEFT (CONVENTIONAL ROADS)*
W8-2101	GRATED BRIDGE DECK
W8-2001	GROOVED PAVEMENT
W11-9	HANDICAPPED CROSSING
W21-1202	HANDLE AND STAFF FOR FLAG PADDLE
R14-3	HC PROHIBITED SYMBOL
R14-2	HC SYMBOL
I5-103	HERITAGE MARKER _____ MILE
I5-104	HERITAGE MARKER W/ARROW
E12-101	HIGHWAY ENTRANCE
W7-101	HILL
W7-5	HILL (BICYCLE SYMBOL)
W7-1	HILL SYMBOL
I7-901	HITCHHIKING PERMITTED
W1-10IL/R	HORIZONTAL ALIGNMENT
W15-301	HOSPITAL
D9-13A	HOSPITAL
W12-501	IMPACT ATTENUATOR MARKING
W12-502	IMPACT ATTENUATOR MARKING
I20-203	IN MEMORY OF _____
D7-301P	IN THE DISTANCE PLAQUE
R1-6A	IN-STREET PEDESTRIAN CROSSING
E8-1	INTERCHANGE SEQUENCE SIGN*
M1-1	INTERSTATE _____
M1-2	INTERSTATE BUSINESS LOOP _____
M1-3	INTERSTATE BUSINESS SPUR _____
M2-1	JCT
M2-2	JUNCTION _____
R4-8	KEEP LEFT SYMBOL
R9-7	KEEP LEFT/RIGHT (PED & BIKE SYMBOLS)*
R11-1	KEEP OFF MEDIAN
R17-101	KEEP OFF WET PAINT
R4-7B	KEEP RIGHT 30 DEGREE ARROW
R4-301	KEEP RIGHT EXCEPT TO PASS
R4-7A	KEEP RIGHT HORIZONTAL ARROW
R4-7	KEEP RIGHT SYMBOL
M4-10	L/R LEFT/RIGHT DETOUR (ARROW)
W12-302	L/R LOW CLEARANCE MARKER LT./RT.*
W9-2L	LANE ENDS MERGE LEFT
W9-2R	LANE ENDS MERGE RIGHT
W1-7	LARGE ARROW (2-HEADS)
W1-6	LARGE ARROW _____

* denotes variable message sign

W12-401L	LATERAL CLEARANCE MARKER (LEFT)
W12-401R	LATERAL CLEARANCE MARKER (RIGHT)
I8-705	LEAN WATER ARROW DIRECTIONAL
I2-701	LEAVING LIMITED ACCESS AREA
I2-501	LEAVING RANGE AREA
R3-802	(LEFT ARROW) ONLY (LEFT RIGHT ARROWS)
R3-8	(LEFT ARROW) ONLY (LEFT STRAIGHT ARROWS)
R3-8A	(LEFT ARROW) ONLY (LEFT STRAIGHT ARROWS) (RIGHT ARROW) ONLY
R3-801	(LEFT ARROW) ONLY (STRAIGHT ARROW) ONLY
R3-17A	LEFT (BIKE SYMBOL) RIGHT (PARKING ALLOWED SYMBOL) ONLY
R3-1104L	LEFT LANE (BUS & ____ PERSON CARPOOL SYMBOLS) ARROW
R3-1103L	LEFT LANE (BUS & ____ CARPOOL SYMBOLS) ONLY, MOTORCYCLES OK
W9-1L	LEFT LANE ENDS
R3-7L	LEFT LANE MUST TURN LEFT
R3-1204	LEFT LANE OPEN TO ALL TRAFFIC
R3-102	LEFT LANE RESTRICTION 1/4 MI. AHEAD
R3-103	LEFT LANE RESTRICTION AHEAD
R3-1201	LEFT LANE RESTRICTION ENDS
R3-1202	LEFT LANE RESTRICTION ENDS 1/4 MI.
R10-5	LEFT ON ARROW ONLY
R3-5	LEFT ONLY ARROW
W1-1L	LEFT TURN
R10-1201	LEFT TURN MUST YIELD
R10-10L	LEFT TURN SIGNAL
R10-21	LEFT TURN SIGNAL - YIELD ON GREEN BALL
R10-12	LEFT TURN YIELD ON GREEN BALL
R3-6	LEFT TURN, STRAIGHT ARROWS
W2-601	LEFT TURNS AHEAD
M4-9L/R	LEFT/RIGHT DETOUR (ARROW _____ DEGREES)
I4-301	LEWIS-CLARK TRAIL MARKER
I7-601	LIGHTS ?
I6-102	LITTER AND IT WILL HURT
I6-201	LITTER SYMBOL SIGN
R13-401	LIVESTOCK INSPECTION REQUIRED STOP AT WEIGH STATION
LG-M6	LODGING (FREEWAY DOUBLE EXIT)*
LG-M5	LODGING EXIT XXX (FREEWAY)*
LG-M5A	LODGING EXIT XXX, VERTICAL PANEL (FREEWAY)*
W8-7	LOOSE GRAVEL
W12-301	LOW CLEARANCE _____ FT _____ INCH
W12-2	LOW CLEARANCE SYMBOL _____ FT _____ INCH
W14-701	LOW FLYING AIRCRAFT
R3-1102L	LT LANE (BUS & ____ CARPOOL SYMBOLS) ONLY ____ AM - ____ PM
D7-1000	MOTORCYCLES OK
D7-1000	MARINE RECREATION AREA
W4-1L	MERGING FROM LEFT
W4-1R	MERGING FROM RIGHT
D5-602	_____ MILE

* denotes variable message sign

D10-101	MILE _____ (BACK TO BACK)
D10-201	MILE _____ (BACK TO BACK)
D10-301	MILE _____ (BACK TO BACK)
D10-1	MILE _____ (SINGLE FACED)
D10-2	MILE _____ (SINGLE FACED)
D10-3	MILE _____ (SINGLE FACED)
I30-401	MILE _____
W13-501	_____ MILES
R2-501	_____ MPH
W13-1	_____ MPH
E7-1	MILEAGE SIGN*
R11-3(MOD.)	MILITARY ROAD CLOSED _____ MILES AHEAD LOCAL TRAFFIC ONLY
R2-4	MINIMUM SPEED _____
R10-20A	MON-FRI ___ AM ___ PM
R5-1201	MOTORCYCLES ONLY
W21-1701	MOTORCYCLES USE EXTREME CAUTION
W14-1601	MOUNTAIN PASS AHEAD DRIVE CAREFULLY
D7-301L	MOUNTAIN PEAK - VIEW LEFT
D7-301R	MOUNTAIN PEAK - VIEW RIGHT
D7-301	MOUNTAIN PEAK - VIEW STRAIGHT AHEAD
I8-801	MOWING TEST AREA
D1-601	MULTILANE DESTINATION W/ARROW*
D1-602	MULTILANE DESTINATIONS W/ARROWS*
D1-603	MULTILANE DESTINATIONS W/ARROWS*
W5-2	NARROW BRIDGE
M1-7	_____ NATIONAL FOREST (FOREST SERVICE ROUTE MARKER)
W20-902	NEW SIGNAL AHEAD
W7-3A	NEXT ___ MILES
I7-702	NEXT _____ MILES
E2-1	NEXT EXIT _____ MILES
E2-1A	NEXT EXIT _____ MILES
R4-602	NEXT PASSING LANE _____ MILES
D5-102	NEXT REST AREA ___ MILES
E4-301	NEXT RIGHT GUIDE SIGN*
D9-1601	NEXT SERVICES _____ MILES
R2-3	NIGHT _____
R5-6	NO BICYCLES SYMBOL
D7-2202	NO CAMPING
W8-12	NO CENTER STRIPE
R18-301	NO DUMPING ALLOWED
R18-101	NO FISHING FROM BRIDGE
W10-13	NO GATES OR LIGHTS
R9-4	NO HITCHHIKING
R9-4A	NO HITCHHIKING SYMBOL
R3-2	NO LEFT TURN SYMBOL
R10-11D	(NO LEFT TURN SYMBOL) ON RED

* denotes variable message sign

R5-3	NO MOTOR VEHICLES
W14-2	NO OUTLET
W14-2P	NO OUTLET WITH ARROW
R8-3	NO PARKING
R7-202	NO PARKING (TIME) TO (TIME)*
R7-101	NO PARKING ANYTIME
R7-1	NO PARKING ANYTIME (ARROW)
R7-102	NO PARKING ANYTIME (DOUBLE HEADED ARROW)
R8-301	NO PARKING BEYOND THIS POINT
R7-9	NO PARKING BIKE LANE
R7-701	NO PARKING BUS STOP
R7-107	NO PARKING BUS STOP (ARROW)
R7-7	NO PARKING BUS STOP _____ ARROW
R7-107A	NO PARKING BUS STOP SYMBOL WITH TRANSIT LOGO
R8-2	NO PARKING EXCEPT ON SHOULDER
R7-301	NO PARKING EXCEPT SUNDAYS
R7-3	NO PARKING EXCEPT SUNDAYS AND HOLIDAYS (ARROW)
R7-601	NO PARKING LOADING ZONE
R7-6	NO PARKING LOADING ZONE (DOUBLE ARROW)
R8-1	NO PARKING ON PAVEMENT
R8-3A	NO PARKING SYMBOL
R7-2A	NO PARKING SYMBOL (TIME) TO (TIME)*
R7-9A	NO PARKING SYMBOL BIKE LANE
R7-2	NO PARKING XXXX TO XXXX *
R4-901	NO PASSING ON BRIDGE
W14-3	NO PASSING ZONE
R9-3	NO PEDESTRIAN CROSSING
R9-3A	NO PEDESTRIAN CROSSING SYMBOL
R3-1	NO RIGHT TURN SYMBOL
R10-11C	(NO RIGHT TURN SYMBOL) ON RED
W8-1801	NO SHOULDER
W10-10	NO SIGNAL
R7-4	NO STANDING ANYTIME _____ ARROW
R8-6	NO STOPPING EXCEPT ON SHOULDERS
R8-5	NO STOPPING ON PAVEMENT
R8-8	NO STOPPING ON TRACKS
R7-402	NO STOPPING OR STANDING
R7-401	NO STOPPING OR STANDING W / ARROW
W10-9	NO TRAIN HORN
R17-2	NO TRESPASSING
R12-3	NO TRUCKS OVER _____ LBS. EMPTY WEIGHT
R5-2	NO TRUCKS SYMBOL
R10-11A	NO TURN ON RED
R10-11B	NO TURN ON RED
R10-11	NO TURN ON RED BALL
R3-3	NO TURNS
R3-4	NO U TURN SYMBOL

* denotes variable message sign

M3-1	NORTH
M3-1B	NORTH
I8-703	NOTICE-PARKING/COMMUTERS ONLY
R16-203	NOV 1 TO APR 1/EXCEPT ALL-WHEEL DRIVE
R8-3D	ON BRIDGE
R8-3C	ON PAVEMENT
W13-4	ON RAMP
R10-1404	ONE CAR PER GREEN
R10-1403	1 CAR PER GREEN EACH LANE
R10-1405	ONE CAR PER GREEN EACH LANE
R10-1402	1 CAR PER GREEN THIS LANE
D1-101	1 DESTINATION W/ARROW*
R7-5	ONE HOUR PARKING (TIME) TO (TIME)*
W1-901L	180 DEGREE CURVE LEFT
W1-901R	180 DEGREE CURVE RIGHT
W5-3	ONE LANE BRIDGE
W20-4	ONE LANE ROAD AHEAD
R12-1101	ONE TRUCK AT A TIME ON BRIDGE
R10-701	ONE VEHICLE IN MEDIAN AT A TIME
R6-1 L	ONE WAY (LEFT)
R6-2 L	ONE WAY (LEFT)
R6-1 R	ONE WAY (RIGHT)
R6-2 R	ONE WAY (RIGHT)
D8-202	OPEN - CLOSED PANEL
R7-10802	PARALLEL PARKING ONLY
D4-301	PARK & RIDE _____*
D4-2	PARK & RIDE*
E13-1	PARK AND RIDE NEXT RIGHT*
E13-2	PARK AND RIDE W/EXIT NUMBER*
R4-2	PASS WITH CARE
R4-601	PASSING LANE _____ MILES
W8-3	PAVEMENT ENDS
W8-2201	PAVEMENT RUTS
W4-2L	PAVEMENT WIDTH TRANSITION LEFT
W4-2R	PAVEMENT WIDTH TRANSITION RIGHT
R9-8	PEDESTRIAN CROSSWALK
M4-9B	PEDESTRIAN DETOUR
R5-10B	PEDESTRIANS AND BICYCLES PROHIBITED
R5-10C	PEDESTRIANS PROHIBITED
R5-1002	PEDESTRIANS, HITCHHIKERS, BICYCLES PROHIBITED
	PEDESTRIANS, HITCHHIKERS, BICYCLES, AND MOTORIZED FOOT
R3-1004	SCOOTERS PROHIBITED
R5-1001	PEDESTRIANS, HITCHHIKERS, PROHIBITED
W11A-501	PEDESTRIANS/BICYCLES
R5-10A	PEDS, BICYCLES, MOTOR-DRIVEN CYCLES PROHIBITED
W7-3	_____ % GRADE
W7-3B	_____ % GRADE _____ MILES

* denotes variable message sign

D5-801	PET AREA DIRECTIONAL
D5-901	PET AREA KEEP PETS ON LEASH
D9-1	PHONE SYMBOL (Informational)
D9-1	PHONE SYMBOL (Recreational)
R10-19	PHOTO ENFORCED
W16-10	PHOTO ENFORCED
G20-4	PILOT CAR FOLLOW ME
P-4	PIT SITE
P-6	PIT SIZE/MILES*
I9-101	PLAYGROUND
W15-1	PLAYGROUND (SYMBOL)
I20-201	PLEASE DON'T DRINK AND DRIVE
I8-702	PLEASE LIMIT YOUR STAY TO 8 HOURS NO TENTS OR CAMPS
D9-14	POLICE
I7-701	PRIMITIVE ROAD NO WARNING SIGNS
D3-104	PRIVATE ROAD NAME SIGN
E6-2	PULL THRU SIGN (OVERHEAD)*
R10-3	PUSH BUTTON FOR GREEN LIGHT
R10-4	PUSH BUTTON FOR WALK SIGNAL
R10-4001	PUSH BUTTON FOR WALK SIGNAL-DIRECTIONAL ARROW LEFT
R10-4002	PUSH BUTTON FOR WALK SIGNAL-DIRECTIONAL ARROW RIGHT
R15-1	R/R CROSSING(CROSS BUCK)
W10-1	RAILROAD ADVANCE SIGN
W13-3	RAMP _____ MPH
R11-201	RAMP CLOSED
W3-501	RAMP METERING AHEAD WHEN FLASHING
R11-1501	RAMP WILL BE CLOSED _____ EXIT WILL BE CLOSED _____
I2-401	RANGE AREA WATCH OUT FOR LIVESTOCK
D7-7701	REC AREA NEXT RIGHT
LG-C3	RECREATION (CONVENTIONAL ROADS)*
LG-M8	RECREATION (FREEWAY DOUBLE EXIT)*
LG-R2	RECREATION (RAMPS)*
LG-M7	RECREATION NEXT RIGHT (FREEWAY)*
D7-101	RECREATIONAL AREA ADVANCE SIGN
D7-201	RECREATIONAL AREA DIRECTIONAL SIGN
I20-101	REPORT DRUNK DRIVING
R7-801	RESERVED PARKING (DISABLED LOGO)
D5-201	REST AREA (ARROW _____ DEGREES) (MAJOR)
D5-701	REST AREA (ARROW _____ DEGREES) (MINOR)
D5-101	REST AREA _____ MILES
D5-601	REST AREA ADVANCE (MINOR)
D5-103	REST AREA NEXT RIGHT
D4-401	REST AREA PARKING*
D5-204	REST AREA VISITOR INFO CENTER (ARROW _____ DEGREES)
D5-202	REST AREA VISITOR INFORMATION CENTER _____ MILES
D5-203	REST AREA VISITOR INFORMATION CENTER NEXT RIGHT
R3-10	RESTRICTED LANE AHEAD

* denotes variable message sign

R3-13	RESTRICTED LANE AHEAD
R3-12	RESTRICTED LANE ENDS
R3-15	RESTRICTED LANE ENDS
R3-1203	RESTRICTED LANE EXIT ONLY
R7-108	RESTRICTED PARKING XXXX TO XXXXX *
W1-4L	REVERSE CURVE LEFT
W1-4R	REVERSE CURVE RIGHT
W1-3L	REVERSE TURN LEFT
W1-3R	REVERSE TURN RIGHT
R9-3C	RIDE WITH TRAFFIC
R3-17	RIGHT LANE (BIKE SYMBOL) ONLY
R3-1103R	RIGHT LANE (BUS & ____ CARPOOL SYMBOLS) ONLY, MOTORCYCLES OK
	RIGHT LANE (BUS & ____ PERSON CARPOOL SYMBOL) EXCEPT RIGHT
R3-2005	URNS
R3-1104R	RIGHT LANE (BUS & ____ PERSON CARPOOL SYMBOLS) ARROW
R3-2001	RIGHT LANE BUSES ONLY
W9-1R	RIGHT LANE ENDS
R3-701	RIGHT LANE MUST EXIT
R3-7R	RIGHT LANE MUST TURN RIGHT
R3-2004	RIGHT LANE TRANSIT ONLY EXCEPT RIGHT TURNS
R10-17A	RIGHT ON RED ARROW AFTER STOP
W20-303	RIGHT SHOULDER CLOSED
W1-1R	RIGHT TURN
R3-702	RIGHT TURN PERMITTED WITHOUT STOPPING
R10-10R	RIGHT TURN SIGNAL
W20-501	RIGHT TWO LANES CLOSED AHEAD
W20-5	RIGHT/LEFT LANE CLOSED AHEAD*
R11-2	ROAD CLOSED
R11-3	ROAD CLOSED _____ MILES AHEAD LOCAL TRAFFIC ONLY
R11-4	ROAD CLOSED TO THRU TRAFFIC
W21-3	ROAD MACHINERY AHEAD
W5-1	ROAD NARROWS
W20-1	ROAD WORK AHEAD
G20-1	ROAD WORK NEXT _____ MILES
W20-3	ROAD/STREET/RAMP CLOSED AHEAD*
W8-1701	ROCKS
W8-8	ROUGH ROAD
W2-6	ROUNDAABOUT AHEAD (SYMBOL)
W2-6P	ROUNDAABOUT AHEAD PLAQUE
M8-101	ROUTE MARKER ASSEMBLY W/ARROW*
M8-201	ROUTE MARKER ASSEMBLY W/ARROWS*
M8-301	ROUTE MARKER ASSEMBLY W/ARROWS*
M8-401	ROUTE MARKER ASSEMBLY W/TWO SHIELDS*
R3-1102R	RT LANE (BUS & ____ CARPOOL SYMBOLS) ONLY ____ AM - ____ PM
	MOTORCYCLES OK
W7-4	RUNAWAY TRUCK RAMP _____ MILE
W7-4A	RUNAWAY TRUCK RAMP ARROW _____ DEGREES
R4-10	RUNAWAY VEHICLES ONLY

* denotes variable message sign

D9-301	RV PARK SIGN
I4-401	SCENIC AND RECREATIONAL HIGHWAY MARKER
D6-2	SCENIC AREA ADVANCE SIGN
D6-3	SCENIC AREA EXIT DIRECTION
D6-1	SCENIC AREA W/ARROW
S4-3	SCHOOL
S1-1	SCHOOL ADVANCE SIGN
S3-1	SCHOOL BUS STOP AHEAD
S3-201	SCHOOL BUS TURNAROUND
	SCHOOL DAYS ____AM - ____PM or (5A) ____AM - ____AM & ____PM -
S4-5 & 5A	____PM
S5-101	SCHOOL SPEED LIMIT 20 WHEN CHILDREN ARE PRESENT
S5-1	SCHOOL SPEED LIMIT 20 WHEN FLASHING
W14-801	SEVERE SIDE WIND AHEAD
W20-301	SHOULDER CLOSED
W21-701	SHOULDER DROP-OFF
W21-5	SHOULDER WORK
W10-3	SIDE ROAD RAILROAD SIGN _____
W2-2	SIDE ROAD SYMBOL
W2-3	SIDE ROAD SYMBOL 45 DEGREES
R9-9	SIDEWALK CLOSED
R9-10	SIDEWALK CLOSED (DOUBLE HEADED ARROW) USE OTHER SIDE
R9-11A	SIDEWALK CLOSED (SINGLE HEAD ARROW) CROSS HERE
R9-11	SIDEWALK CLOSED AHEAD (SINGLE HEAD ARROW) CROSS HERE
W3-3	SIGNAL AHEAD (SYMBOL)
W20-903	SIGNAL REVISION AHEAD
I1-1	SIGNALS SET FOR ____ MPH
W10-12	SKewed CROSSING
W8-1901	SLIDE AREA
W8-10	SLIPPERY WHEN WET (BICYCLE SYMBOL)
W8-5	SLIPPERY WHEN WET SYMBOL
W14-601	SLOW MOVING VEHICLE
W14-901	SLOW MOVING VEHICLE (SYMBOL)
I8-301	SLOW VEHICLE TURNOUT (ARROW _____ DEGREES)
I8-401	SLOW VEHICLE TURNOUT _____
I8-501	SLOW VEHICLES MAY USE SHOULDER
I8-101	SLOW VEHICLES USE TURNOUTS NEXT _____ MILES
R4-3	SLOWER TRAFFIC KEEP RIGHT
W11-6	SNOWMOBILE CROSSING
W8-4	SOFT SHOULDER
M3-3	SOUTH
M3-3B	SOUTH
W17-1	SPEED HUMP
R2-1	SPEED LIMIT _____
R2-4A	SPEED LIMIT _____ MINIMUM _____
W3-5	SPEED LIMIT REDUCTION AHEAD
I30-101	SPEEDOMETER CHECK SECTION AHEAD
I20-204	SPONSORED BY THE _____ FAMILY
D10-501	SPUR ROUTE PLAQUE

R7-801P	STATE DISABLED PARKING PERMIT REQUIRED
I8-901	STATE LAW ALL VEHICLES MUST KEEP TO RIGHT EXCEPT TO PASS
I8-1001	STATE LAW-MOTORCYCLISTS MUST WEAR HELMETS
M1-601	STATE ROUTE _____
M1-701	STATE ROUTE _____ (DIRECTIONAL)
M1-602	STATE ROUTE _____ (GUIDE SIGN USE)
R4-9	STAY IN LANE
P-5	STOCK PILE _____ MILES
P-3	STOCKPILE
R1-1	STOP
W3-1	STOP AHEAD
W3-1A	STOP AHEAD (SYMBOL)
R10-6A	STOP HERE ON RED CURVED ARROW
R10-6L	STOP HERE ON RED DIRECTIONAL ARROW
R10-6R	STOP HERE ON RED DIRECTIONAL ARROW
R10-601L&R	STOP HERE ON RED DIRECTIONAL ARROW 1 CAR PER GREEN
I3-101	STREAM NAME SIGN*
D3-401	STREET NAME SIGN W/GEORGE SHIELD*
D3-101	STREET NAME SIGN*
I3-201	SUMMIT ELEVATION SIGN*
R10-20B	SUNDAY _____ AM
W16-5PR	SUPPLEMENTAL ARROW 270 PLAQUE (RIGHT)
W16-5PL	SUPPLEMENTAL ARROW 90 PLAQUE (LEFT)
W21-6	SURVEY CREW
D7-401	SYMBOL - BICYCLE TRAIL
D7-1101	SYMBOL - BOAT LAUNCH
D7-1201	SYMBOL - BOAT MOORAGE
D7-1001	SYMBOL - BOATING
D7-601	SYMBOL - BRIDLE TRAIL
D7-2204	SYMBOL - CAMPFIRE
D7-1601	SYMBOL - CANOEING
D7-801	SYMBOL - CLIMBING
D9-13	SYMBOL - EMERGENCY MEDICAL SERVICES
D7-1301	SYMBOL - FISHING
D9-8	SYMBOL - FOOD
I1-201	SYMBOL - FOREST FIRE PREVENTION
D9-11A	SYMBOL - FUEL, COMPRESSED NATURAL GAS
D9-1101	SYMBOL - FUEL, DIESEL
D9-11B	SYMBOL - FUEL, ETHANOL
D9-11	SYMBOL - FUEL, GASOLINE
D7-701	SYMBOL - GOLFING
D9-6	SYMBOL - HANDICAPPED
D9-2	SYMBOL - HOSPITAL
D5-904	SYMBOL - INFORMATION
D5-903	SYMBOL - LIGHTHOUSE
D9-9	SYMBOL - LODGING
D9-15	SYMBOL - LP GAS
D5-906	SYMBOL - PET AREA KEEP PETS ON LEASH

* denotes variable message sign

D7-2201	SYMBOL – PICNICKING
D7-2203	SYMBOL - PLAYGROUND
D9-1301	SYMBOL - QUESTION MARK
D5-902	SYMBOL - RANGER STATION
D9-12	SYMBOL - RECREATIONAL VEHICLE SANITARY STATION
D5-908	SYMBOL - REST ROOM
D9-4	SYMBOL - RESTROOM MEN
D9-5	SYMBOL - RESTROOM WOMEN
D9-7	SYMBOL - RESTROOM WOMEN AND MEN
D7-1701	SYMBOL - ROWBOATING
D9-10	SYMBOL - SHOWERS
D7-2001	SYMBOL - SNOW SKIING
D7-2101	SYMBOL - SNOWMOBILE AREA
D7-2104	SYMBOL - SNOWSHOEING
D7-1401	SYMBOL - SWIMMING
D9-3	SYMBOL - TENT CAMPING
D7-501	SYMBOL - TRAIL
D7-901	SYMBOL - TRAIL (INTERPRETIVE PED)
D9-3B	SYMBOL - TRAILER AND TENT CAMPING
D9-3A	SYMBOL - TRAILER CAMPING
D5-905	SYMBOL - VIEWPOINT
D5-907	SYMBOL - WATCHABLE WILDLIFE (BINCOULAR)
D7-1501	SYMBOL - WATER SKIING
D9-1B	SYMBOL ADVANCE PHONE _____ MILE
D7-2002	SYMBOL- CROSS COUNTRY SKIING
D9-1A	SYMBOL PHONE (ARROW _____ DEGREES)
D7-2103	SYMBOL- WINTER SPORTS
W2-4	T (SYMBOL)
W10-4	T SYMBOL RAILROAD SIGN
M4-7	TEMPORARY
M4-7A	TEMPORARY, BLACK ON WHITE
M4-7B	TEMPORARY, WHITE ON BLUE
G28-201	THANK YOU – WSDOT & (CONTRACTOR’S NAME)
D1-301	3 DESTINATIONS W/ARROWS*
I6-301	THROWING AWAY BURNING MATERIAL PROHIBITED
D5-301	TIRED? REST AREA _____MILES
M4-5	TO
M4-5B	TO
M4-13	TO
S4-1	_____ TO _____
M4-1301	TO (BICYCLE ROUTE)
R10-3A	TO CROSS STREET PUSH BUTTON - WAIT FOR GREEN LIGHT
R10-4A	TO CROSS STREET PUSH BUTTON WAIT FOR WALK SIGNAL
R1-2A	TO ONCOMING TRAFFIC
R10-22	TO REQUEST GREEN WAIT ON BICYCLIST SYMBOL
LG-C2	TOURIST ACTIVITIES (CONVENTIONAL ROADS)*
LG-M10	TOURIST ACTIVITIES (FREEWAY DOUBLE EXIT)*

* denotes variable message sign

LG-R3	TOURIST ACTIVITIES (RAMP)*
LG-M9	TOURIST ACTIVITIES EXIT XXX (FREEWAY)*
LG-M9A	TOURIST ACTIVITIES EXIT XXX, VERTICAL PANEL (FREEWAY)*
R7-201	TOW-AWAY ZONE
R7-201A	TOW-AWAY ZONE SYMBOL
R15-2	_____ TRACKS
R8-9	TRACKS OUT OF SERVICE
R16-2103	TRACTION ADVISORY OVERSIZED VEHICLES PROHIBITED
I20-301	TRAFFIC FINES DOUBLE IN WORK ZONES
R10-18	TRAFFIC LAWS PHOTO ENFORCED
W20-901	TRAFFIC REVISION AHEAD
W24-101	TRAFFIC SURVEY AHEAD
I5-7	TRAIN STATION (SYMBOL)
R3-2002	TRANSIT (BUS SYMBOL) ONLY
R3-1502	TRANSIT LANE ENDS
R3-1503	TRANSIT LANE ENDS _____ MILES
R3-2003	TRANSIT ONLY ARROW 315
W14-1101	TRANSIT STOP AHEAD (SYMBOL)
I35-102	TRAVELER INFO DIAL 511
I35-101	TRAVELER INFO TUNE _____ AM TRAFFIC ADVISORY WHEN FLASHING
M4-4	TRUCK
W8-6	TRUCK CROSSING
W11-10	TRUCK CROSSING (SYMBOL)
W7-4B	TRUCK ESCAPE RAMP
W7-	
4C,D,&E	TRUCK ESCAPE RAMP PLAQUES, SAND, GRAVEL, & PAVED
R4-6	TRUCK LANE _____ FEET
R14-5	TRUCK PROHIBITED SYMBOL
R14-1	TRUCK ROUTE
R14-4	TRUCK SYMBOL
R2-2	TRUCKS _____
W21-30	TRUCKS ENTERING HIGHWAY
W21-30A	TRUCKS LEAVING HIGHWAY
R13-201	TRUCKS OVER 10, 000 GVWR STOP AT SCALES WHEN OPEN
R13-302	TRUCKS OVER 10,000 GVWR STOP AT SCALES/WEIGH STATION CLOSED
R4-302A	TRUCKS OVER 10,000 LBS USE RIGHT _____ LANES ONLY
R13-301	TRUCKS STOP AT SCALES/WEIGH STATION CLOSED
W7-2B	TRUCKS USE LOWER GEAR
R4-5	TRUCKS USE RIGHT LANE
I25-101	TSUNAMI EVACUATION ROUTE
I25-102	TSUNAMI WARNING
W14-501	TUNNEL
W22-2	TURN OFF 2-WAY RADIO AND CELLULAR PHONES
I7-501	TURN ON LIGHTS
R10-15	TURNING TRAFFIC MUST YIELD TO PEDESTRIANS
R10-1401	TWO CARS PER GREEN
W1-4BR	2 CURVE RIGHT ARROWS

* denotes variable message sign

D1-201	2 DESTINATIONS W/ARROWS*
W1-15	270 DEGREE LOOP
W1-4CR	3 CURVE RIGHT ARROWS
R3-9A	(TWO WAY LEFT TURN)ONLY (OVERHEAD MOUNTED)
W6-3	TWO WAY TRAFFIC (SYMBOL)
M1-4	U.S. _____
M1-4A	U.S. _____ (GUIDE SIGN USE)
M1-401	U.S. _____ (DIRECTIONAL)
W8-11	UNEVEN LANES
R4-605	UNMUFFLED COMPRESSION BRAKES PROHIBITED
D4-1	URBAN PUBLIC PARKING SIGN
G24-101	USE ALL LANES
R9-3BL	USE CROSSWALK (ARROW LEFT)
R9-3BR	USE CROSSWALK (ARROW RIGHT)
R10-8	USE LANE WITH GREEN ARROW
G24-201	USE LEFT LANE
R4-604	USE OF COMPRESSION BRAKES PROHIBITED
G24-301	USE RIGHT LANE
R3-703	USE RIGHT LANE TO EXIT
R16-101	USE RIGHT SHOULDER TO INSTALL CHAINS
R16-102	USE RIGHT SHOULDER TO REMOVE CHAINS
I1-2	USE YOUR ASHTRAY
R10-16	U-TURN YIELD TO RIGHT TURN
R7-801A	VAN ACCESSIBLE
I1-301	VEGETATION MANAGEMENT APPLICATION
R16-501A	VEHICLES OVER 10,000 GVW USE CHAINS WHEN TRAC. TIRES REQ.
R16-2101	VEHICLES OVER 10,000 GVWR CHAINS REQUIRED
R16-501	VEHICLES OVER 10,000 LBS GROSS MUST USE CHAINS
R5-5	VEHICLES WITH LUGS PROHIBITED
R4-302	VEHICLES WITH TRAILERS OR OVER 10,000 LBS PROHIBITED IN LEFT LANE VEHICLES WITH TRAILERS OR OVER 10,000 LBS USE RIGHT ____ LANES
R4-302B	ONLY
I25-201	VOLCANO EVACUATION ROUTE
R9-1	WALK ON LEFT FACING TRAFFIC
W8-1601	WATCH FOR ICE
W8-1501	WATER OVER ROADWAY
I8-709	WATER UNSAFE TO DRINK
D8-1	WEIGH STATION ____ MILE
D8-301	WEIGH STATION EXIT (ARROW _____ DEGREES)
D8-201	WEIGH STATION RIGHT LANE
R12-1	WEIGHT LIMIT ____ TONS
R12-4	WEIGHT LIMIT _____ TONS PER AXLE _____ TONS GROSS
R12-5	WEIGHT LIMIT TRUCK SYMBOLS W/WEIGHT*
R12-501	WEIGHT RESTRICTIONS IN FORCE
I2-101	WELCOME TO WASHINGTON
M3-4	WEST
M3-4B	WEST

* denotes variable message sign

S4-2	WHEN CHILDREN ARE PRESENT
S4-501	WHEN FLAGGED
S4-4	WHEN FLASHING
W1-5L	WINDING ROAD LEFT
W1-5R	WINDING ROAD RIGHT
W21-1A	WORK CREW (SYMBOL)
G28-101	WORK ZONE AHEAD; GIVE'EM A BRAKE
R5-1A	WRONG WAY
W2-5	Y (SYMBOL)
R1-2	YIELD
W3-2A	YIELD AHEAD (SYMBOL)
R1-5L&R	YIELD HERE TO PEDESTRIANS

APPENDICES

- Appendix A Sign Sizing, Layout, and Spacing
- Appendix B Guide Sign Arrows
- Appendix C Letter Spacing for Upper and Lower Case
- Appendix D Graphics Templates
- Appendix E Express Lane Gate Arm

D1-101 & D1-201 & D1-301

10/97

D1-101

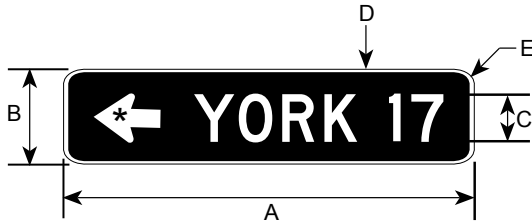

D1-201

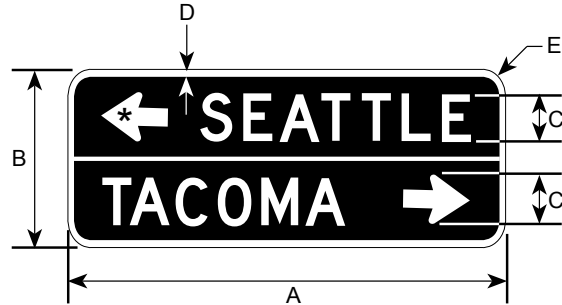

D1-301

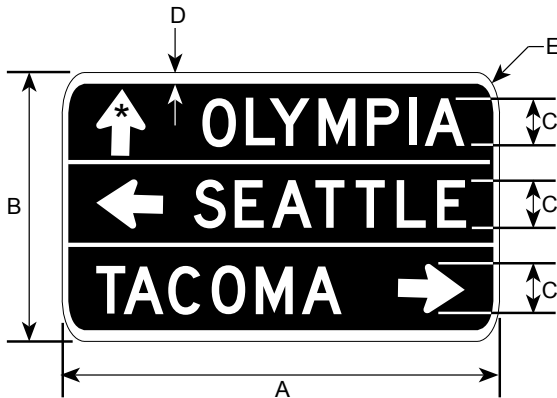

* SEE APPENDIX FOR STANDARD DETAILS

SERIES D LETTERS ARE STANDARD.
SERIES C MAY BE USED AS A MINIMUM.

DELETE SEPARATION BORDER WHEN
DESTINATIONS ARE IN SAME DIRECTIONS.

DIMENSIONS (MILLIMETERS)						
SIGN CODE	MESSAGE LINES	A	B	C	D	E
D1-101	1	VAR	300	150D	19	38
D1-201	2	VAR	600	150D	19	38
D1-301	3	VAR	900	150D	19	38

DIMENSIONS (INCHES)						
SIGN CODE	MESSAGE LINES	A	B	C	D	E
D1-101	1	VAR	12	6D	3/4	1 1/2
D1-201	2	VAR	24	6D	3/4	1 1/2
D1-301	3	VAR	36	6D	3/4	1 1/2

COLORS

LEGEND — WHITE (REFL)
BACKGROUND — GREEN (REFL)

D1-401 & D1-501

4/03

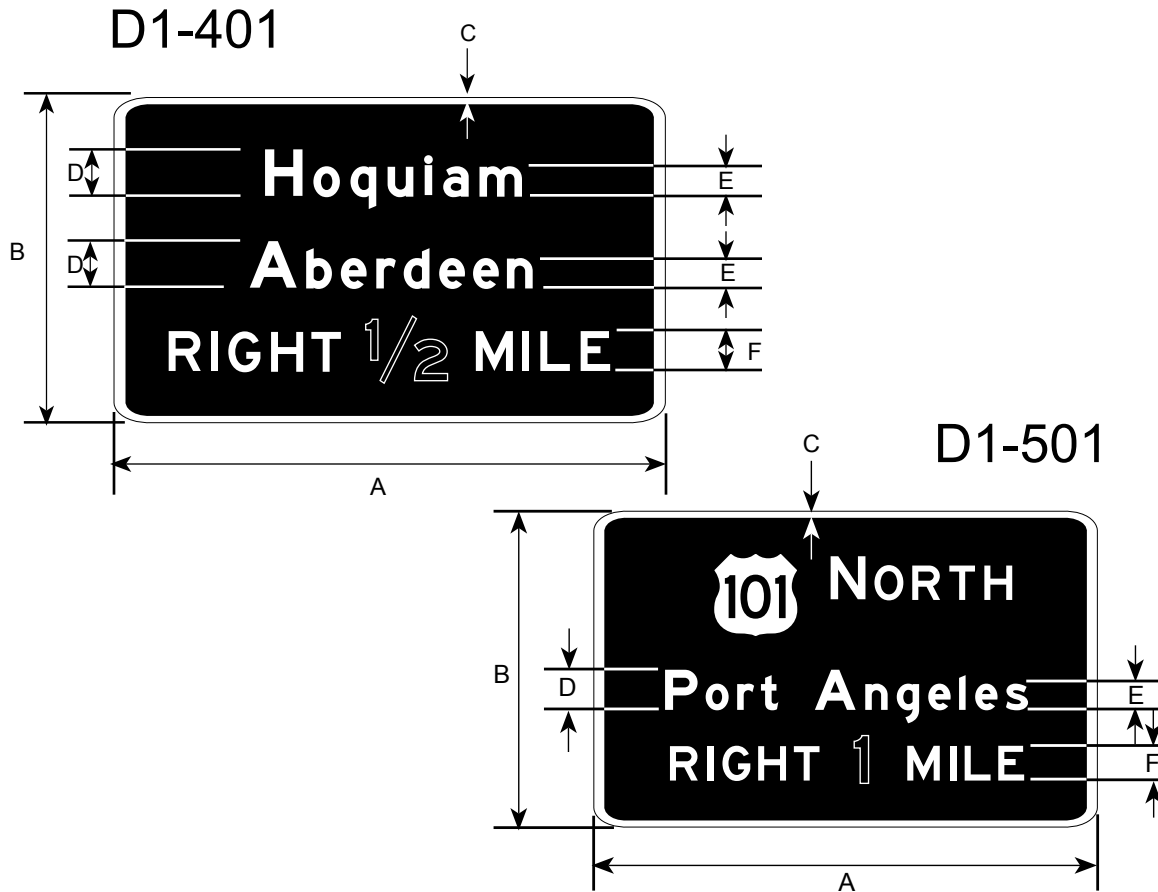

DIMENSIONS (MILLIMETERS)										
SIZE CODE	A	B	C	D	E	F	FRACTION SIZE	SHIELD SIZE	CARDINAL DIRECTION	NUMBER SIZE
A	VAR	VAR	38	200EM	150EM	150E	150E	450	200E/150E	200E
B	VAR	VAR	38	265EM	200EM	200E	200E	600	250E/200E	250E
C	VAR	VAR	50	333EM	250EM	250E	250E	900	300E/250E	300E
D	VAR	VAR	50	400EM	300EM	300E	300E	900	375E/300E	375E

DIMENSIONS (INCHES)										
SIZE CODE	A	B	C	D	E	F	FRACTION SIZE	SHIELD SIZE	CARDINAL DIRECTION	NUMBER SIZE
A	VAR	VAR	1 1/2	8EM	6EM	6E	6E	18	8E/6E	8E
B	VAR	VAR	1 1/2	10.6EM	8EM	8E	8E	24	10E/8E	10E
C	VAR	VAR	2	13.3EM	10EM	10E	10E	36	12E/10E	12E
D	VAR	VAR	2	16EM	12EM	12E	12E	36	15E/12E	15E

COLORS
 LEGEND — WHITE (REFL)
 BACKGROUND — GREEN (REFL)

D1-601 & D1-602 & D1-603

1/06

D1-601



D1-602



D1-603



* SEE APPENDIX FOR STANDARD ARROW DETAILS

DIMENSIONS (MILLIMETERS)			
SIZE CODE	LETTER SIZE		BORDER WIDTH
	U.C.	L.C.	
A	200	150	38
B	265	200	38
C	333	250	50
D	400	300	50

DIMENSIONS (INCHES)			
SIZE CODE	LETTER SIZE		BORDER WIDTH
	U.C.	L.C.	
A	8	6	1 1/2
B	10.6	8	1 1/2
C	13.3	10	2
D	16	12	2

COLORS

LEGEND — WHITE (REFL)
 BACKGROUND — GREEN (REFL)
 BACKGROUND — BROWN (REFL)
 (Brown, National or State Parks Only)

D1-701

5/06



* SEE APPENDIX FOR STANDARD ARROW DETAILS

DIMENSIONS (MILLIMETERS)						
SIZE CODE	A	B	C	D	E	F
A	200EM	450	38	200E/150E	150EM	1 OR 2
B	265EM	600	38	250E/200E	200EM	3 OR 4
C	333EM	900	50	300E/250E	250EM	3 OR 4
D	400EM	900	50	375E/300E	300EM	5 OR 6

DIMENSIONS (INCHES)						
SIZE CODE	A	B	C	D	E	F
A	8EM	18	1 1/2	8E/6E	6EM	1 OR 2
B	10.6EM	24	1 1/2	10E/8E	8EM	3 OR 4
C	13.3EM	36	2	12E/10E	10EM	3 OR 4
D	16EM	36	2	15E/12E	12EM	5 OR 6

WHITE ON BROWN MAY BE SPECIFIED ON THE PLANS FOR RECREATIONAL SIGNING. HOWEVER, BROWN SHALL NOT BE USED WITH A NUMBERED HIGHWAY ROUTE DESIGNATION ON THE SIGN.

COLORS

LEGEND — WHITE (REFL)
BACKGROUND — GREEN (REFL)

D1-801 & D1-901

12/05

D1-801



D1-901



* SEE APPENDIX FOR STANDARD ARROW DETAILS

DIMENSIONS (MILLIMETERS)								
SIZE CODE	LETTER SIZE		CARDINAL DIRECTION	SHIELD SIZE	VERTICAL DIMENSION		BORDER WIDTH	ARROW SIZE
	U.C.	L.C.			D1-801	D1-901		
A	200	150	200E/150E	450	2400	1200	38	1
B	265	200	250E/200E	600	3000	1500	50	3

DIMENSIONS (INCHES)								
SIZE CODE	LETTER SIZE		CARDINAL DIRECTION	SHIELD SIZE	VERTICAL DIMENSION		BORDER WIDTH	ARROW SIZE
	U.C.	L.C.			D1-801	D1-901		
A	8	6	8E/6E	18	96	48	1 1/2	1
B	10.6	8	10E/8E	24	120	60	2	3

COLORS

LEGEND — WHITE (REFL)
BACKGROUND — GREEN (REFL)

D3-101

10/97



DIMENSIONS (MILLIMETERS)					
A	B	C	D	E	F
VA	200	16	75D	100D	38
VA	300	22	100D	150D	56
VA	400	31	150D	200D	75

DIMENSIONS (INCHES)					
A	B	C	D	E	F
VA	8	5/8	3D	4D	1 1/2
VA	12	7/8	4D	6D	2 1/4
VA	16	1 1/4	6D	8D	3

COLORS

LEGEND — WHITE (REFL)
BACKGROUND — GREEN (REFL)

D3-102

12/05



DIMENSIONS (MILLIMETERS)			
A	B	C	D
VAR	150	100D	50D
VAR	225	150C	100C
VAR	300	200C	150C

DIMENSIONS (INCHES)			
A	B	C	D
VAR	6	4D	2D
VAR	9	6C	4C
VAR	12	8C	6C

COLORS

LEGEND — WHITE (REFL)
BACKGROUND — GREEN (REFL)

D3-103

10/00

DOUBLE FACED STREET NAME SIGN



NOTE: 4" MOUNTING AREA IS GREEN REFLECTIVE SHEETING

DIMENSIONS (MILLIMETERS)				
A	B	C	D	E
VAR	400	19	150D	38

DIMENSIONS (INCHES)				
A	B	C	D	E
VAR	16	3/4	6D	1 1/2

COLORS

LEGEND — WHITE (REFL)
BACKGROUND — GREEN (REFL)

D3-104

12/05

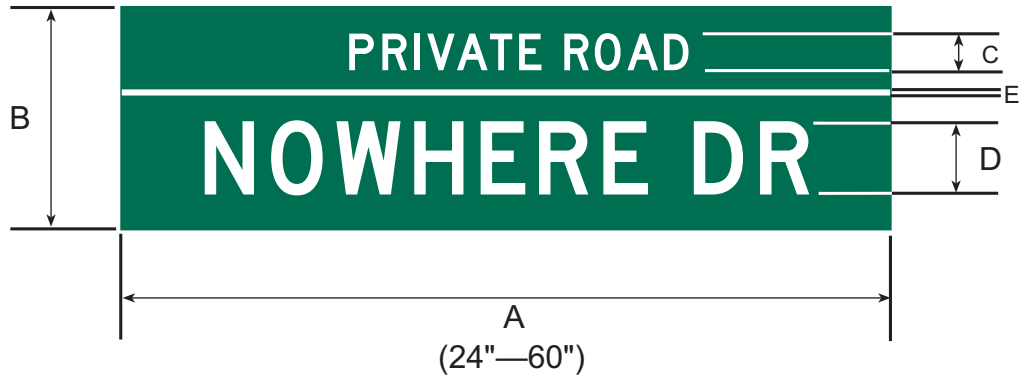

DIMENSIONS (MILLIMETERS)				
A	B	C	D	E
VAR	300	50D	150C	16

DIMENSIONS (INCHES)				
A	B	C	D	E
VAR	12	2D	6C*	5/8

* 6C PREFERRED, 6B ALLOWED IF NECESSARY

COLORS

LEGEND, SEPARATION BAR—WHITE (REFL)

BACKGROUND—GREEN (REFL)

D3-2

1/06

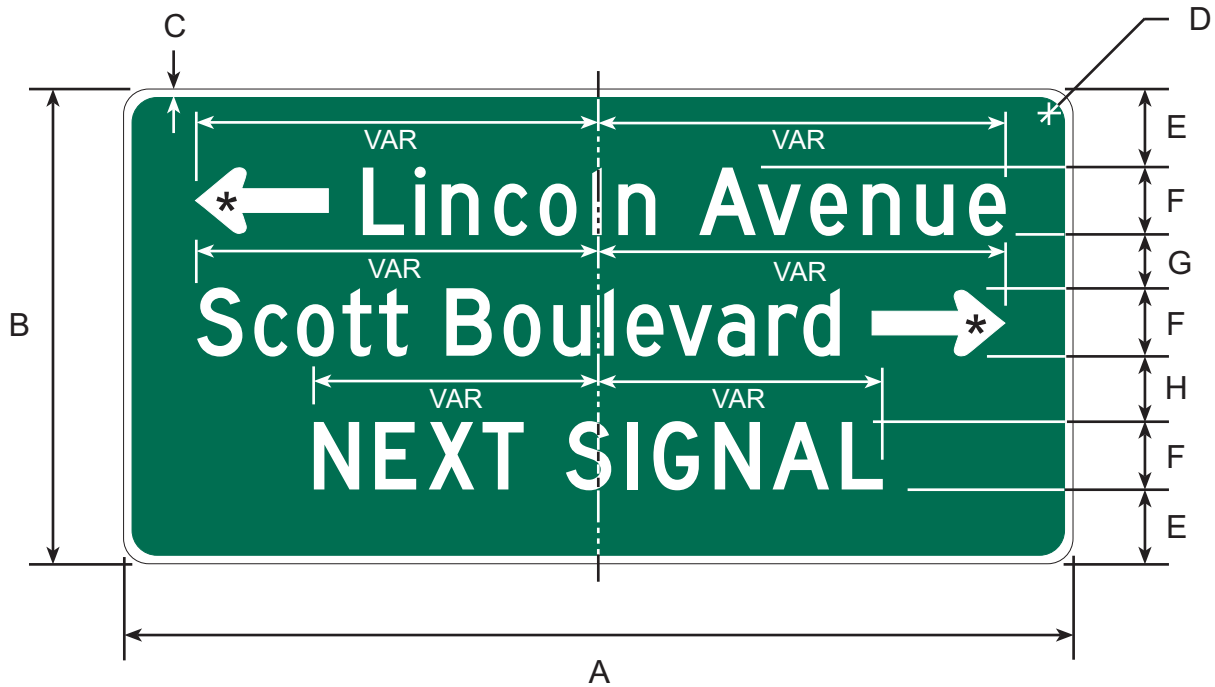

* SEE APPENDIX FOR STANDARD ARROW DETAILS

DIMENSIONS (MILLIMETERS)							
A	B	C	D	E	F	G	H
VAR	1050	19	56	175	150D	100	150
VAR	1350	25	75	163	150D	100	113

DIMENSIONS (INCHES)							
A	B	C	D	E	F	G	H
VAR	42	3/4	2 1/4	7	6D	4	6
VAR	54	1	3	6 1/2	6D	4	4 1/2

COLORS

LEGEND - WHITE (REFL)
BACKGROUND - GREEN (REFL)

D3-2A

1/06

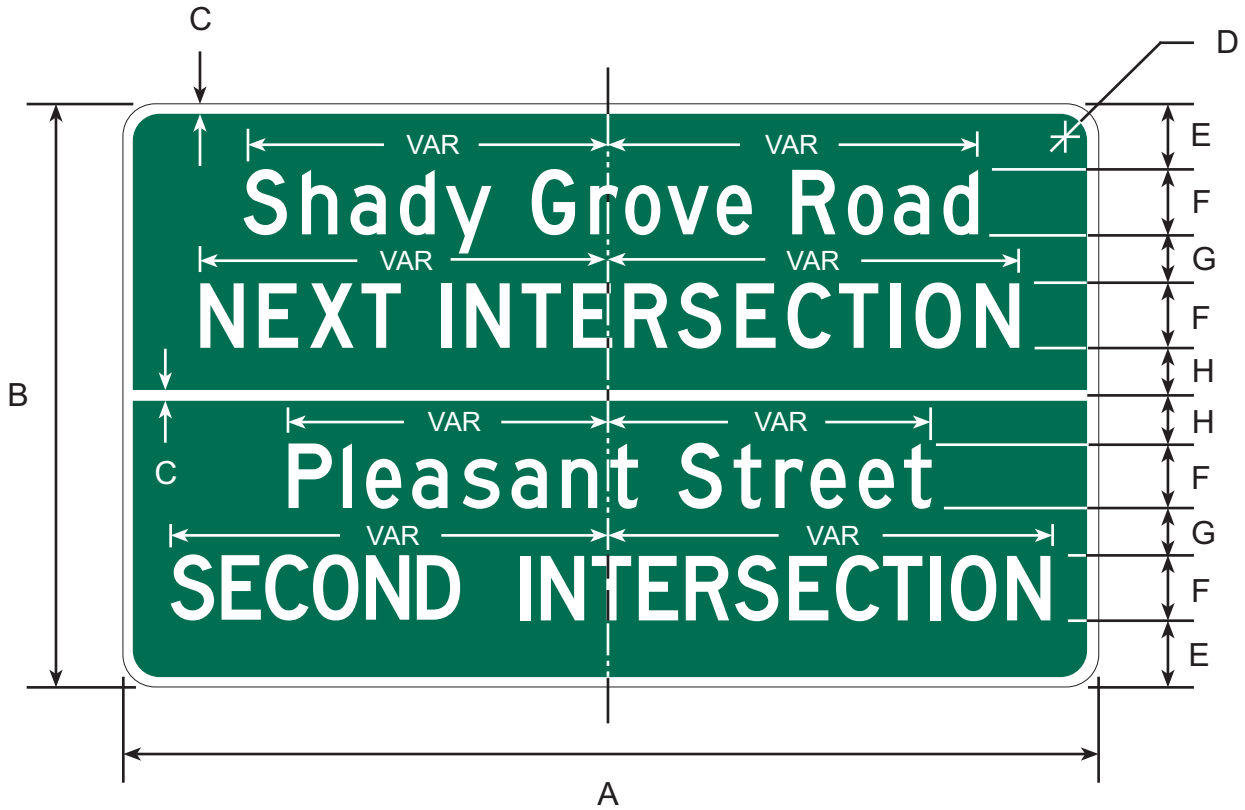

DIMENSIONS (MILLIMETERS)							
A	B	C	D	E	F	G	H
VAR	1350	25	75	150	150D	113	113

DIMENSIONS (INCHES)							
A	B	C	D	E	F	G	H
VAR	54	1	3	6	6D	4 1/2	4 1/2

COLORS

LEGEND - WHITE (REFL)
BACKGROUND - GREEN (REFL)

D3-201

12/05



NOTE: SERIES C LETTERS MAY BE USED WHEN SPECIFIED ON THE PLANS

DIMENSIONS (MILLIMETERS)		
A	B	C
VAR	150	100D
VAR	225	125D
VAR	300	150D
VAR	400	200D

DIMENSIONS (INCHES)		
A	B	C
VAR	6	4D
VAR	9	5D
VAR	12	6D
VAR	16	8D

COLORS

LEGEND — BLACK (NON-REFL)
BACKGROUND — YELLOW (REFL)

D3-301

12/05



DIMENSIONS (MILLIMETERS)				
A	B	C	D	E
VAR	300	19	150D	38
VAR	400	19	200D	38

DIMENSIONS (INCHES)				
A	B	C	D	E
VAR	12	3/4	6D	1 1/2
VAR	16	3/4	8D	1 1/2

COLORS

LEGEND — WHITE (REFL)
 BACKGROUND — GREEN (REFL)

D3-302

12/05



DIMENSIONS (MILLIMETERS)							
	A	B	C	D	E	F	G
1 LINE	VAR	300	19	150D	38	45°	150
1 LINE	VAR	400	19	200D	38	45°	200
2 LINES	VAR	600	19	150D	38	45°	200
2 LINES	VAR	750	19	200D	38	45°	200

DIMENSIONS (INCHES)							
	A	B	C	D	E	F	G
1 LINE	VAR	12	3/4	6D	1 1/2	45°	6
1 LINE	VAR	16	3/4	8D	1 1/2	45°	8
2 LINES	VAR	24	3/4	6D	1 1/2	45°	8
2 LINES	VAR	30	3/4	8D	1 1/2	45°	8

COLORS

LEGEND — WHITE (REFL)
 BACKGROUND — GREEN (REFL)

D3-401

12/05



DIMENSIONS (MILLIMETERS)								
A	B	C	D	SHIELD SIZE	NUM. SIZE & SERIES			E
					1 DIGIT	2 DIGITS	3 DIGITS	
VAR	300	22	150D	181 X 200	150C	125C	100C	56
VAR	450	31	200D	272 X 300	125C	75C	63C	75

DIMENSIONS (INCHES)								
A	B	C	D	SHIELD SIZE	NUM. SIZE & SERIES			E
					1 DIGIT	2 DIGITS	3 DIGITS	
VAR	12	7/8	6D	7 1/4 X 8	6C	5C	4C	2 1/4
VAR	18	1 1/4	8D	10 7/8 X 12	5C	3C	2 1/2C	3

COLORS

- LEGEND - WHITE (REFL)
- SHIELD NUMBERS - BLACK (NON-REFL)
- BACKGROUND - GREEN (REFL)

D4-1

10/97



* SEE APPENDIX FOR STANDARD ARROW DETAILS

DIMENSIONS (MILLIMETERS)											
A	B	C	D	E	F	G	H	J	K	L	M
750	600	9	16	375E	113	75E	253	63	225	38	181

DIMENSIONS (INCHES)											
A	B	C	D	E	F	G	H	J	K	L	M
30	24	3/8	5/8	15E	4 1/2	3E	10 1/8	2 1/2	9	1 1/2	7 1/4

COLORS

LEGEND - GREEN (NON REFL)
 BACKGROUND - WHITE (REFL)

D4-2

10/97

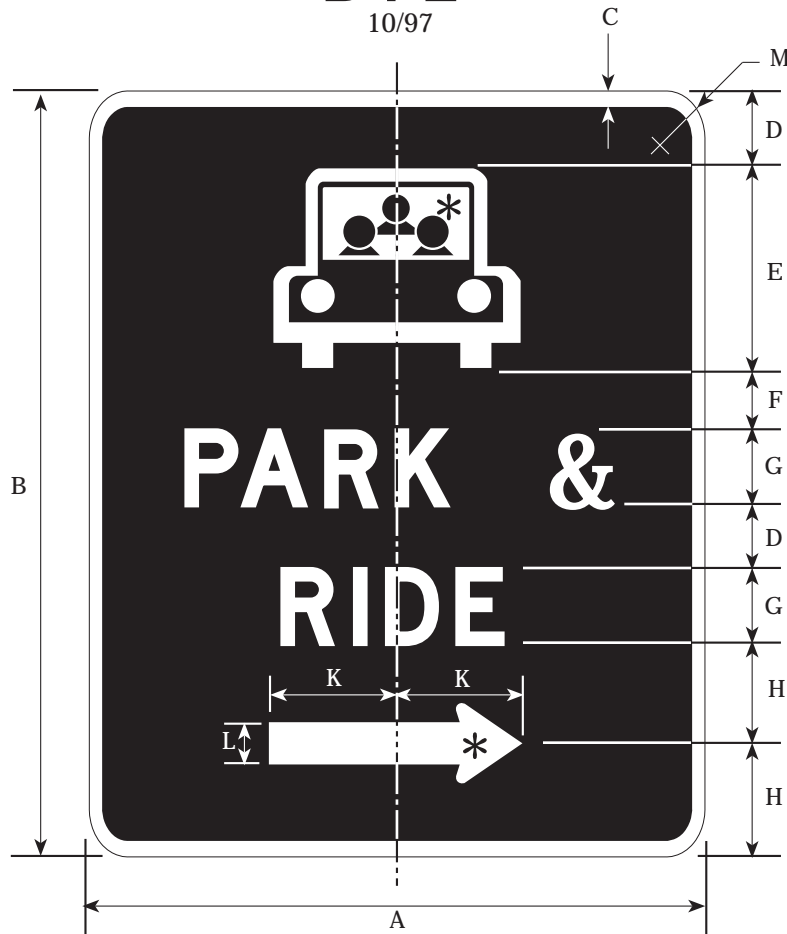

* SEE APPENDIX FOR SYMBOL DESIGN AND STANDARD ARROW DETAILS
CENTER CAR SYMBOL IF NO TRANSIT SYMBOL IS USED

DIMENSIONS (MILLIMETERS)										
A	B	C	D	E	F	G	H	K	L	M
600	750	16	50	200	75	75D	113	150	28	38
750	900	19	75	225	75	100D	125	175	38	47
900	1200	22	100	275	75	150D	175	225	56	56

DIMENSIONS (INCHES)										
A	B	C	D	E	F	G	H	K	L	M
24	30	5/8	2	8	3	3D	4 1/2	6	1 1/8	1 1/2
30	36	3/4	3	9	3	4D	5	7	1 1/2	1 7/8
36	48	7/8	4	11	3	6D	7	9	2 1/4	2 1/4

COLORS

LEGEND, ARROW, & BORDER - WHITE (REFL.)

SYMBOL - WHITE & GREEN (REFL.)

BACKGROUND - GREEN (REFL.)

D4-301

10/97

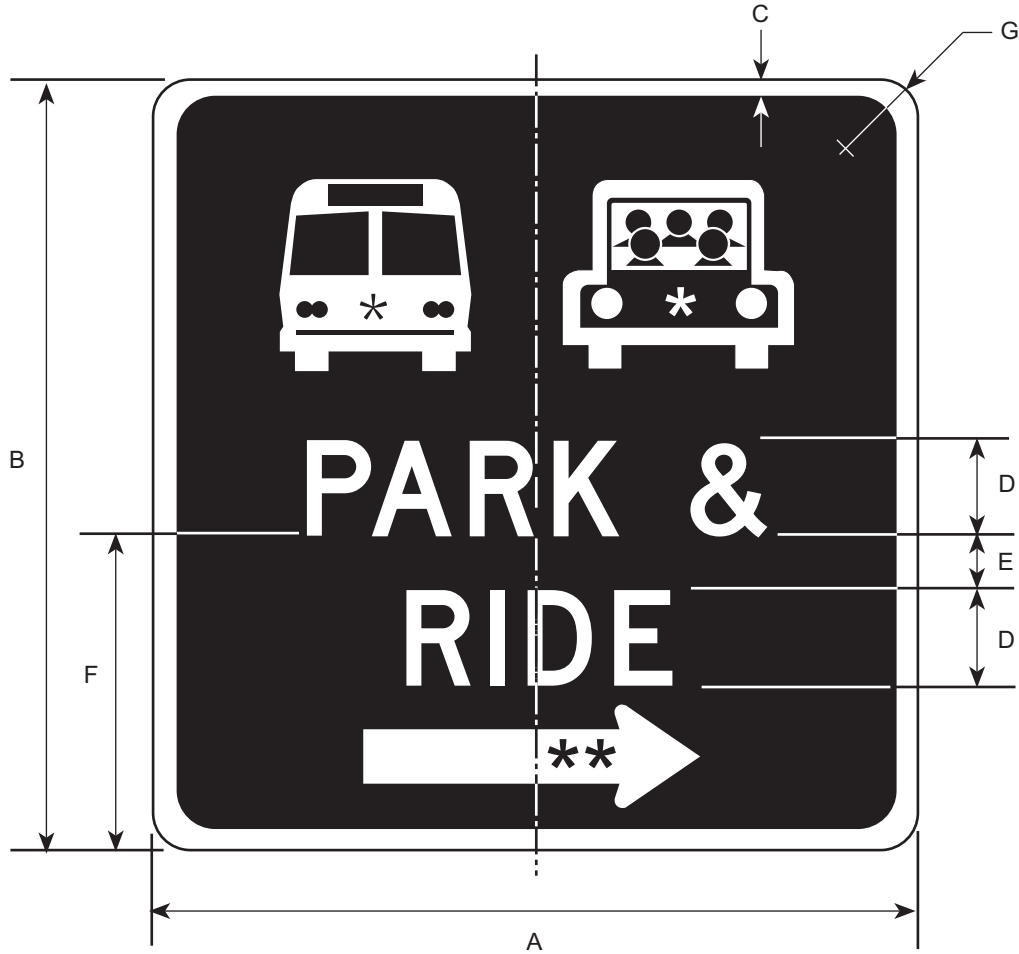

* SEE APPENDIX FOR SYMBOL DESIGN

** SEE APPENDIX FOR ARROW DETAILS

DIMENSIONS (MILLIMETERS)						
A	B	C	D	E	F	G
600	600	16	75D	50	300	38

DIMENSIONS (INCHES)						
A	B	C	D	E	F	G
24	24	5/8	3D	2	12	1 1/2

COLORS

LEGEND — WHITE (REFL)
 BACKGROUND — GREEN (REFL)

D4-401

12/05



* SEE APPENDIX FOR STANDARD ARROW DETAILS

DIMENSIONS (MILLIMETERS)					
A	B	C	ARROW	D	E
1500	1200	19	#2	150D	75
2400	1800	38	#4	200D	225

DIMENSIONS (INCHES)					
A	B	C	ARROW	D	E
60	48	3/4	#2	6D	3
96	72	1 1/2	#4	8D	9

COLORS

LEGEND — WHITE (REFL)
BACKGROUND — GREEN (REFL)

D5-101

10/97



DIMENSIONS (MILLIMETERS)							
A	B	C	D	E	F	G	FRACTION SIZE
2400	900	38	200E	250	138	100	150
3000	1200	50	250E	300	200	150	200
3600	1500	50	300E	375	263	150	250

DIMENSIONS (INCHES)							
A	B	C	D	E	F	G	FRACTION SIZE
96	36	1 1/2	8E	10	5 1/2	4	6
120	48	2	10E	12	8	6	8
144	60	2	12E	15	10 1/2	6	10

COLORS

LEGEND - WHITE (REFL)
 BACKGROUND - BLUE (REFL)

D5-102

6/03



DIMENSIONS (MILLIMETERS)					
A	B	C	D	E	F
2400	600	19	150E	88	75
3000	900	38	200E	113	100

DIMENSIONS (INCHES)					
A	B	C	D	E	F
96	24	3/4	6E	3 1/2	3
120	36	1 1/2	8E	5 1/2	4

COLORS

LEGEND - WHITE (REFL)
BACKGROUND - BLUE (REFL)

D5-103

10/97

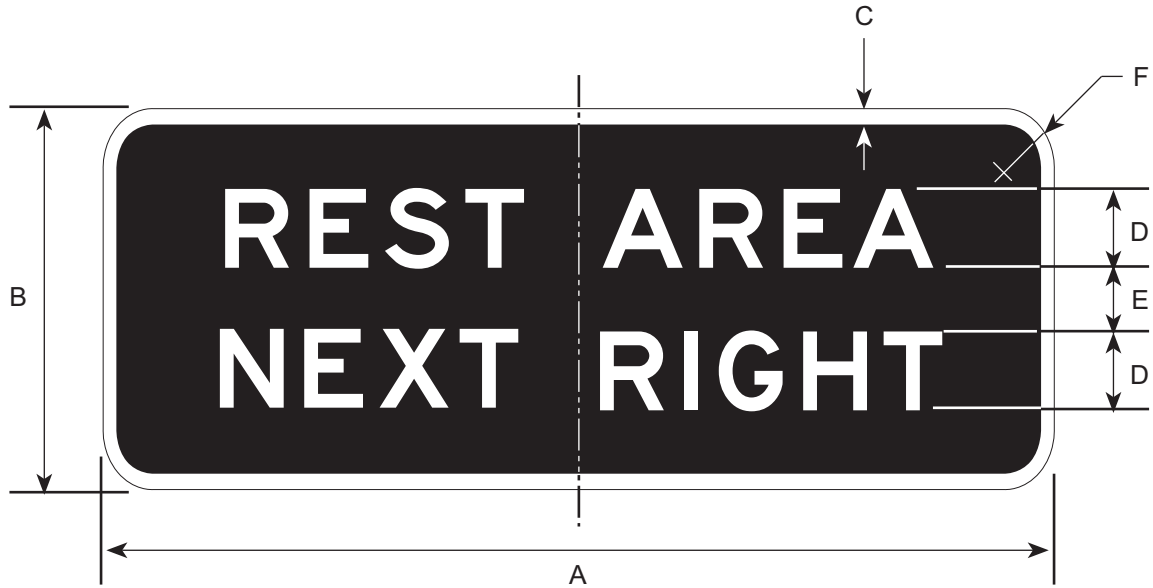

DIMENSIONS (MILLIMETERS)					
A	B	C	D	E	F
2400	900	38	200E	138	100
3000	1200	50	250E	200	150
3600	1500	50	300E	263	150

DIMENSIONS (INCHES)					
A	B	C	D	E	F
96	36	1 1/2	8E	5 1/2	4
120	48	2	10E	8	6
144	60	2	12E	10 1/2	6

COLORS

LEGEND — WHITE (REFL)
 BACKGROUND — BLUE (REFL)

D5-201

12/05

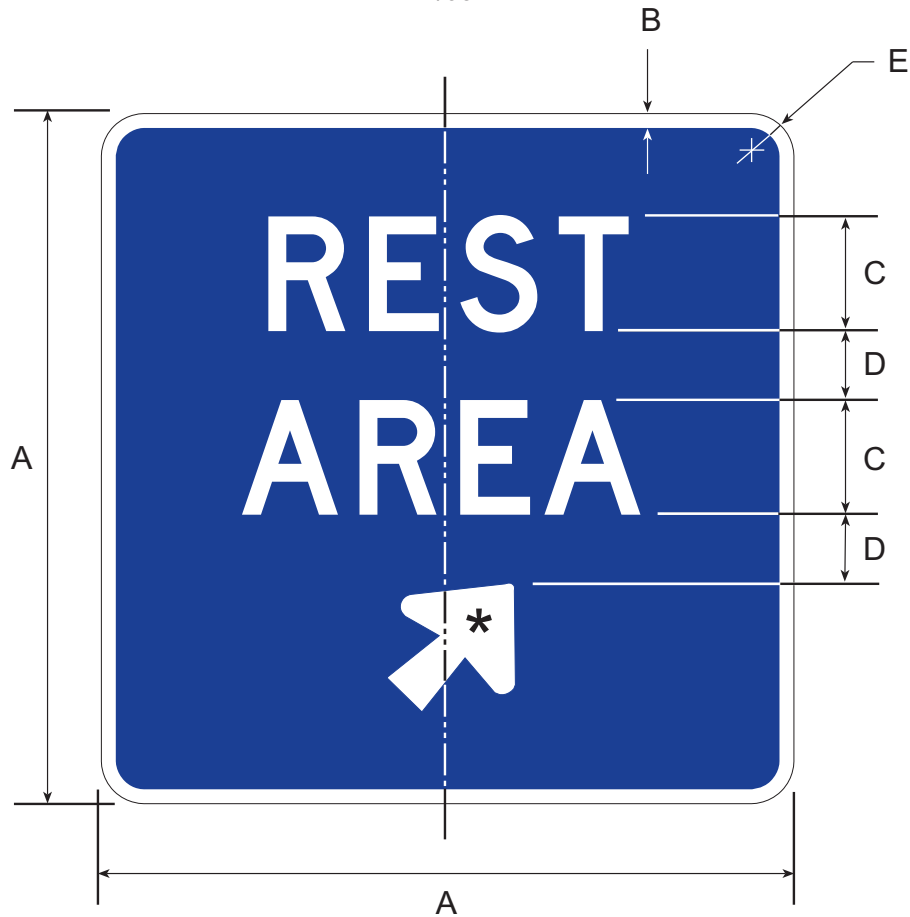

* SEE APPENDIX FOR STANDARD ARROW DETAILS

DIMENSIONS (MILLIMETERS)					
A	B	C	D	E	ARROW SIZE
1200	38	200D	100	100	1
1500	50	250D	125	150	3
1800	50	300D	150	150	5

DIMENSIONS (INCHES)					
A	B	C	D	E	ARROW SIZE
48	1 1/2	8D	4	4	1
60	2	10D	5	6	3
72	2	12D	6	6	5

COLORS

LEGEND — WHITE (REFL)
 BACKGROUND — BLUE (REFL)

D5-202

10/97



DIMENSIONS (MILLIMETERS)								
A	B	C	D	E	F	G	H	J
3600	2550	50	300D	225	200	250	375E(M)	250

DIMENSIONS (INCHES)								
A	B	C	D	E	F	G	H	J
144	102	2	12D	9	8	10	15E(M)	10

COLORS

LEGEND - WHITE (REFL)
BACKGROUND - BLUE (REFL)

D5-203

8/98



EXIT DIRECTION REST AREA - VISITOR
INFORMATION CENTER SIGN (ALTERNATE)

DIMENSIONS (MILLIMETERS)							
A	B	C	D	E	F	G	H
3600	2550	50	300D	225	200	250	250

DIMENSIONS (INCHES)							
A	B	C	D	E	F	G	H
144	102	2	12D	9	8	10	10

COLORS

LEGEND - WHITE (REFL)
BACKGROUND - BLUE (REFL)

D5-204

12/05

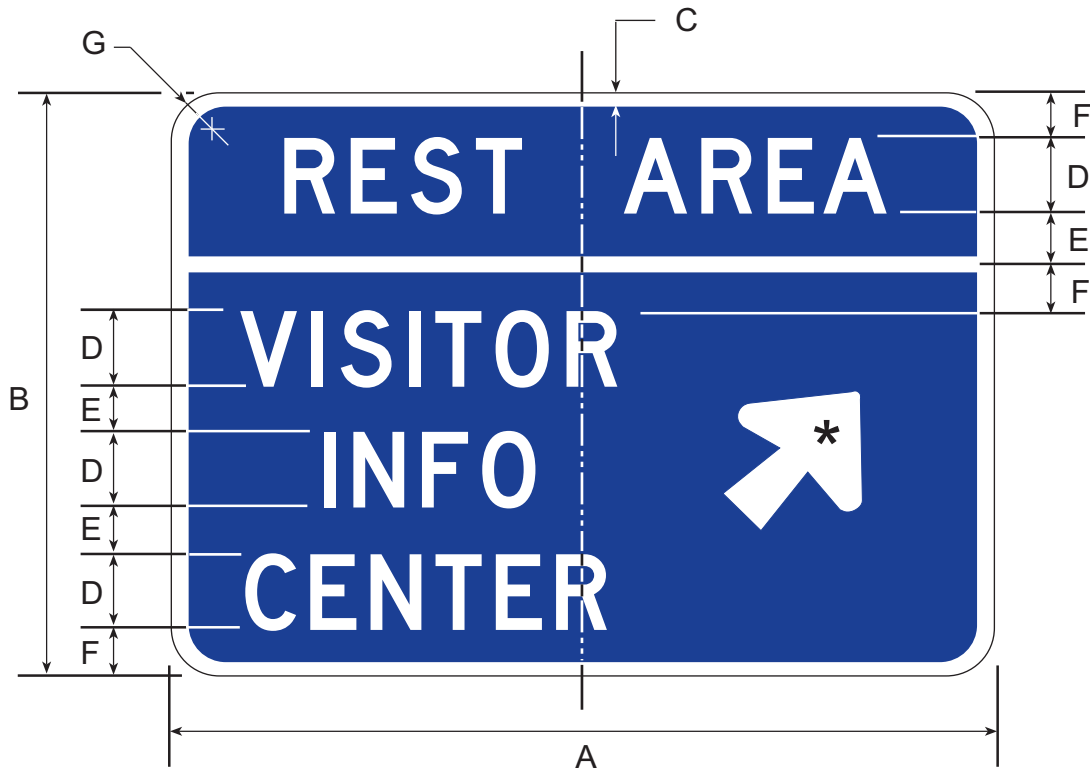

* SEE APPENDIX FOR STANDARD ARROW DETAILS

DIMENSIONS (MILLIMETERS)							
A	B	C	D	E	F	G	ARROW SIZE
3000	2550	50	300D	200	250	250	4

DIMENSIONS (INCHES)							
A	B	C	D	E	F	G	ARROW SIZE
120	102	2	12D	8	10	10	4

COLORS

SYMBOL, LEGEND — WHITE (REFL)
 BACKGROUND — BLUE (REFL)

D5-301

10/97

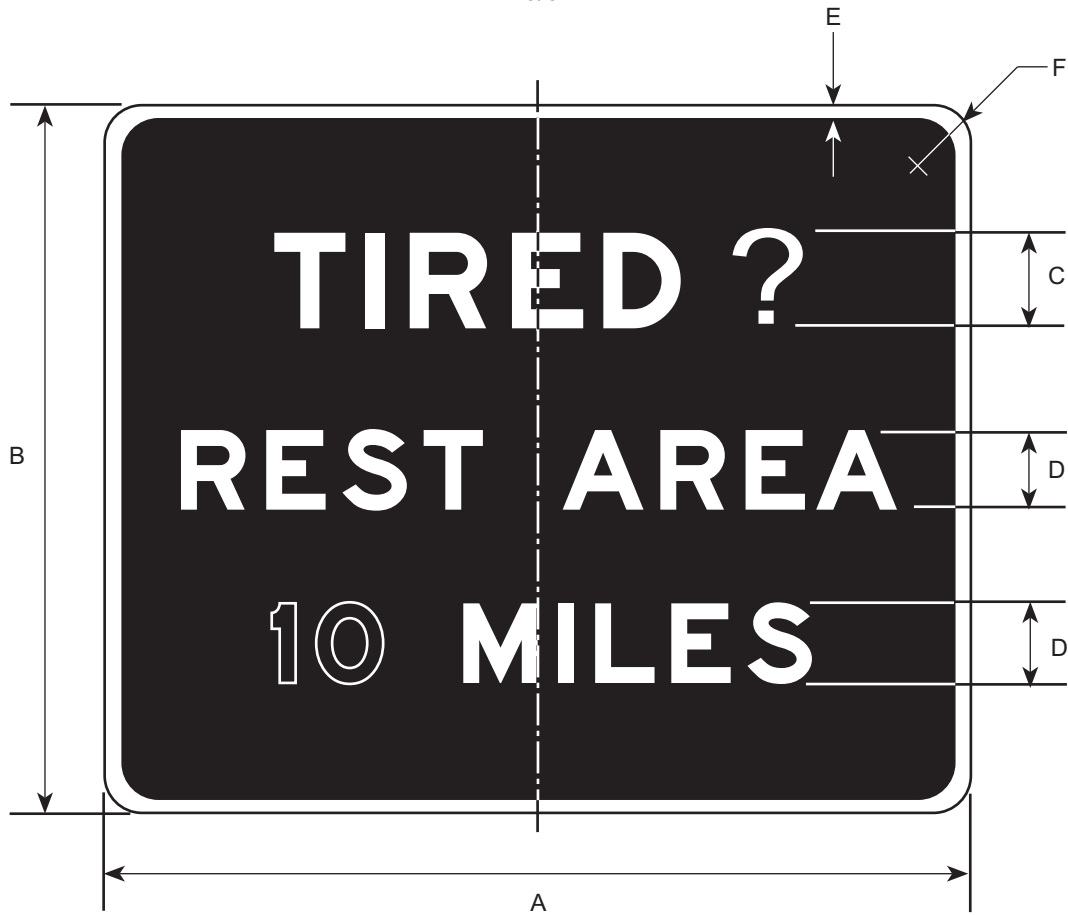

DIMENSIONS (MILLIMETERS)					
A	B	C	D	E	F
2700	1800	300E	250E	50	225

DIMENSIONS (INCHES)					
A	B	C	D	E	F
108	72	12E	10E	2	9

COLORS

LEGEND— WHITE (REFL)
BACKGROUND— BLUE (REFL)

D5-601

10/97



DIMENSIONS (MILLIMETERS)					
A	B	C	D	E	F
900	750	16	100D	75	75
1200	1000	25	150D	125	100

DIMENSIONS (INCHES)					
A	B	C	D	E	F
36	30	5/8	4D	3	3
48	40	1	6D	5	4

COLORS

LEGEND - WHITE (REFL)
 BACKGROUND - BLUE (REFL)

D5-602

10/97

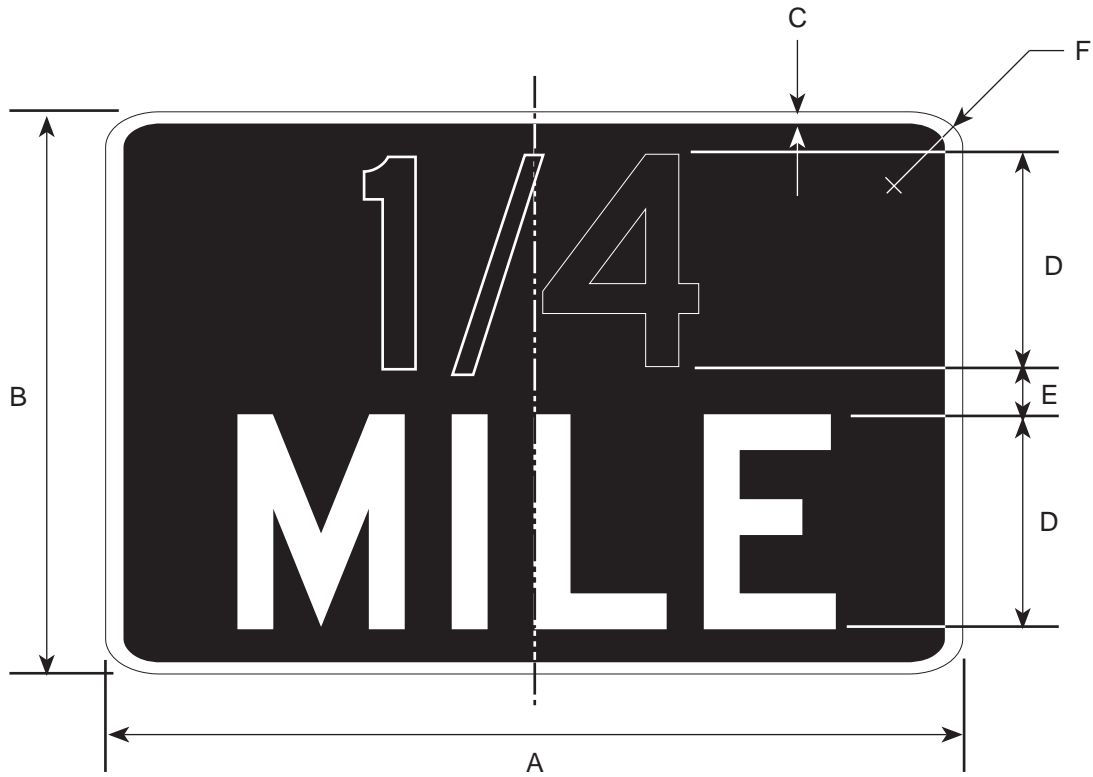

DIMENSIONS (MILLIMETERS)					
A	B	C	D	E	F
450	300	9	100D	25	38
600	450	13	150D	38	38

DIMENSIONS (INCHES)					
A	B	C	D	E	F
18	12	3/8	4D	1	1 1/2
24	18	1/2	6D	1 1/2	1 1/2

COLORS

LEGEND - WHITE (REFL)
 BACKGROUND - BLUE (REFL)

D5-701

10/97

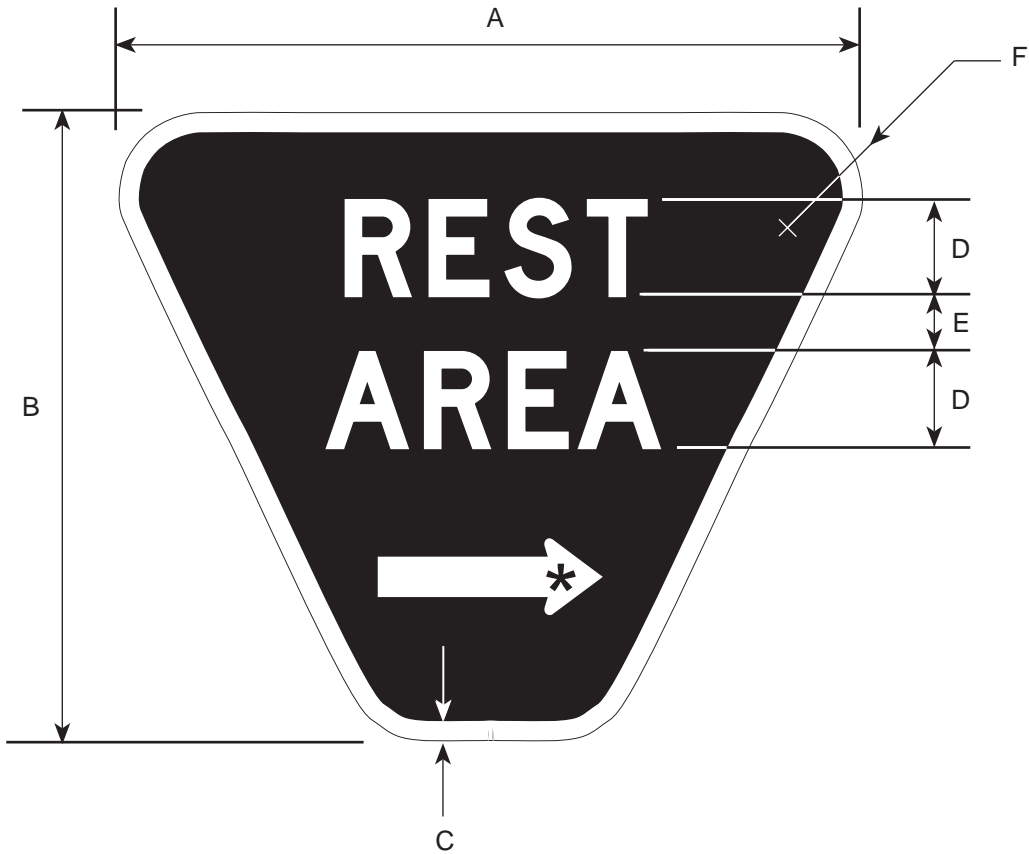

* SEE APPENDIX FOR STANDARD ARROW DETAILS

DIMENSIONS (MILLIMETERS)						
A	B	C	D	E	F	ARROW SIZE
900	750	16	100D	75	75	200x100
1200	1000	25	150D	125	100	225x150

DIMENSIONS (INCHES)						
A	B	C	D	E	F	ARROW SIZE
36	30	5/8	4D	3	3	8x4
48	40	1	6D	5	4	9x6

COLORS

LEGEND - WHITE (REFL)
BACKGROUND - BLUE (REFL)

D5-801

10/97



DIMENSIONS (MILLIMETERS)					
A	B	C	D	E	F
750	150	9	75D	150	19

DIMENSIONS (INCHES)					
A	B	C	D	E	F
30	6	3/8	3D	6	3/4

COLORS

LEGEND - WHITE (REFL)
BACKGROUND - BROWN (REFL)

D5-901

10/97

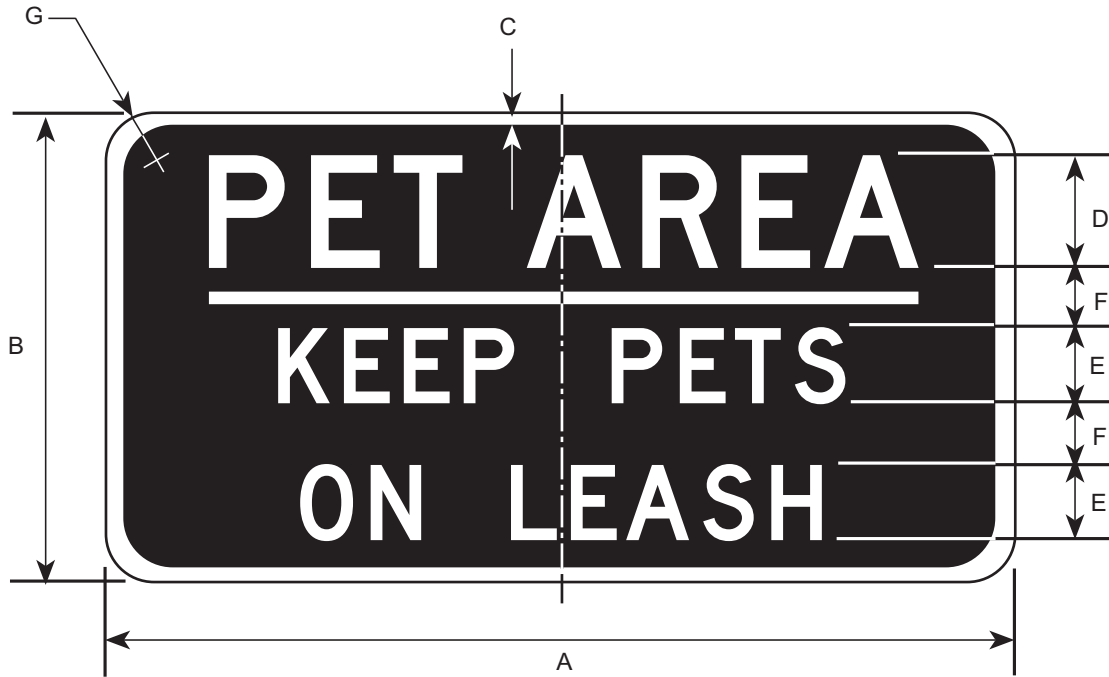

DIMENSIONS (MILLIMETERS)						
A	B	C	D	E	F	G
600	300	13	75D	50D	25	38

DIMENSIONS (INCHES)						
A	B	C	D	E	F	G
24	12	1/2	3D	2D	1	1 1/2

COLORS

LEGEND — WHITE (REFL)
 BACKGROUND — BROWN (REFL)

RECREATIONAL FACILITY SYMBOL SIGNS

6/06

D5 SERIES

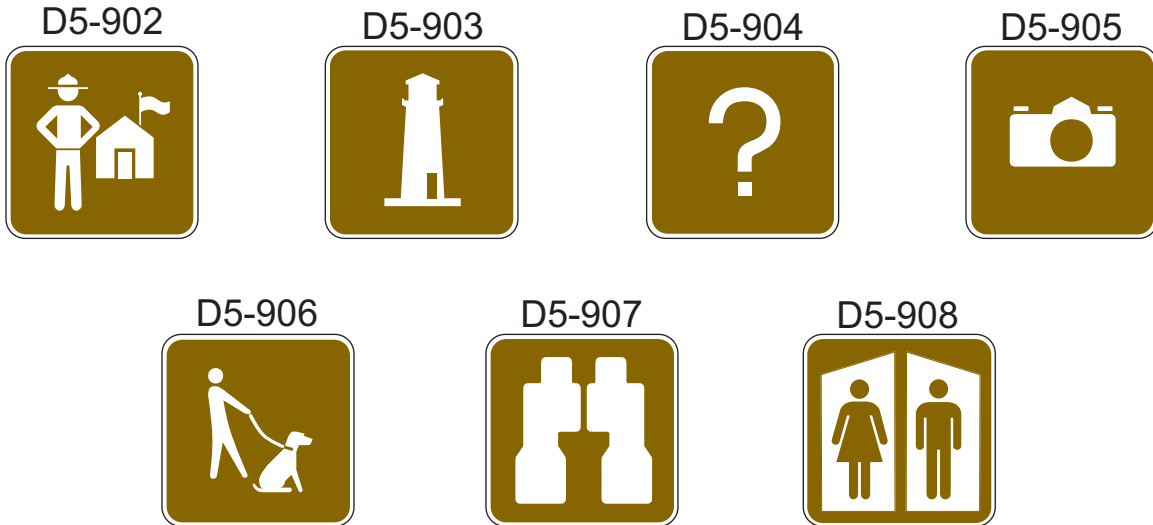

D7 SERIES



Note: All signs are 600 millimeters x 600 millimeters (24 inches x 24 inches), with a 13 millimeter (1/2 inch) border and a 38 millimeter (1 1/2 inch) corner radius

COLORS

SYMBOL — WHITE (REFL)
BACKGROUND — BROWN (REFL)

D6-1

12/05

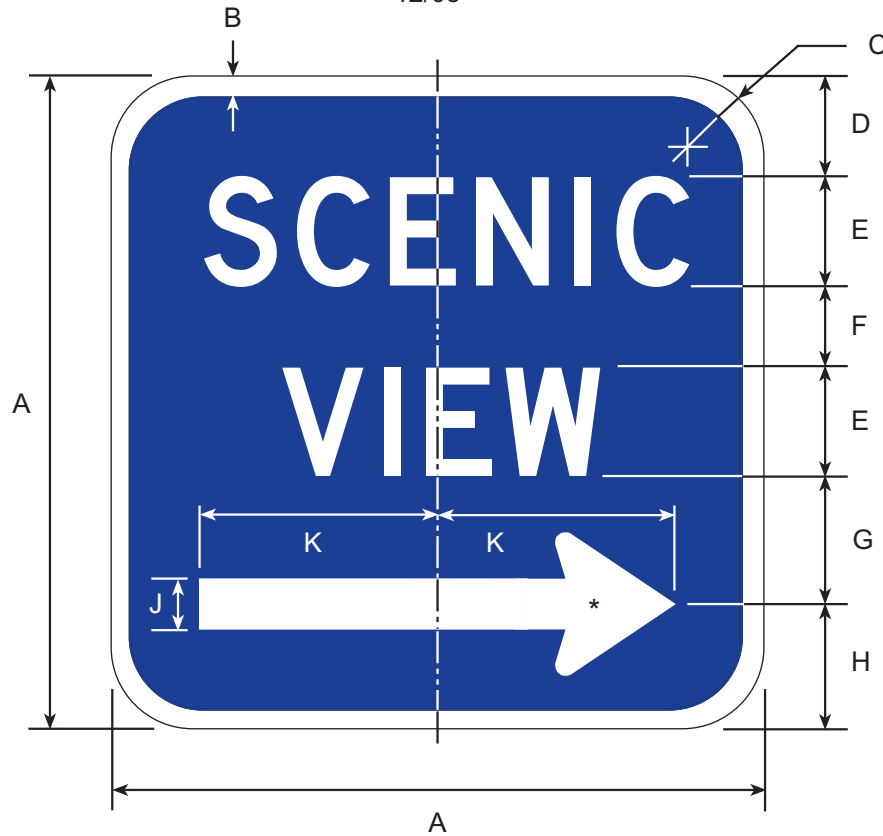

* SEE APPENDIX FOR ARROW DETAILS

DIMENSIONS (MILLIMETERS)									
A	B	C	D	E	F	G	H	J	K
900	25	100	125	150D	110	175	190	69	338
1200	38	150	175	200D	150	225	250	88	450
1500	50	150	200	250D	195	300	305	113	563
1800	50	200	250	300D	225	360	365	138	675

DIMENSIONS (INCHES)									
A	B	C	D	E	F	G	H	J	K
36	1	4	5	6D	4 1/2	7	7 1/2	2 3/4	13 1/2
48	1 1/2	6	7	8D	6	9	10	3 1/2	18
60	2	6	8	10D	7 3/4	12	12 1/4	4 1/2	22 1/2
72	2	8	10	12D	9	14	15	5 1/2	27

COLORS

LEGEND & ARROW - WHITE (REFL)
 BACKGROUND - BLUE (REFL)

D6-2

12/05

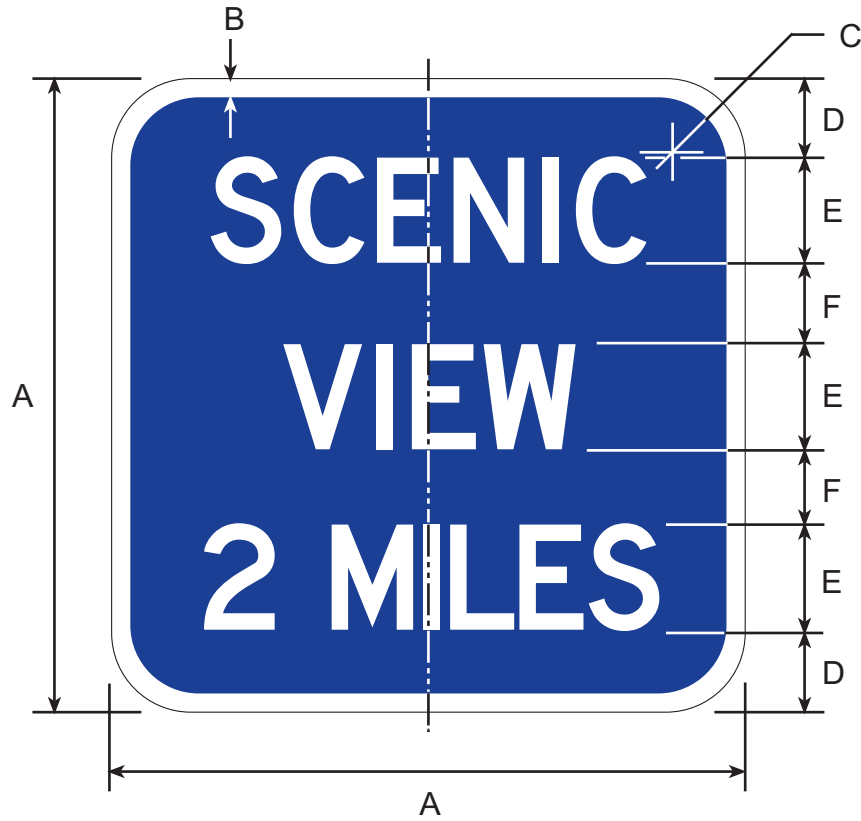

DIMENSIONS (MILLIMETERS)					
A	B	C	D	E	F
900	25	100	125	150D	100
1200	38	150	150	200D	150
1500	50	150	185	250D	190
1800	50	200	250	300D	200

DIMENSIONS (INCHES)					
A	B	C	D	E	F
36	1	4	5	6D	4
48	1 1/2	6	6	8D	6
60	2	6	7 1/2	10D	7 1/2
72	2	8	10	12D	8

COLORS

LEGEND - WHITE (REFL)
 BACKGROUND - BLUE (REFL)

D6-3

12/05

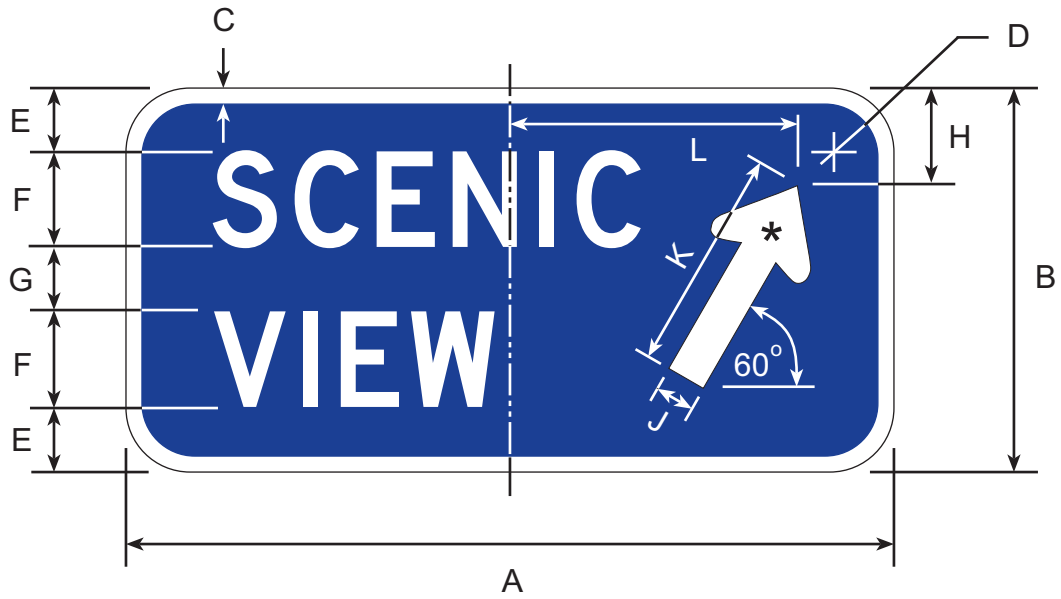

* SEE APPENDIX FOR ARROW DETAILS

DIMENSIONS (MILLIMETERS)										
A	B	C	D	E	F	G	H	J	K	L
1200	600	25	100	100	150D	100	150	69	350	500
1500	900	38	150	175	200D	150	200	88	500	600
1800	1200	50	150	250	250D	200	250	113	675	700
2400	1350	50	200	250	300D	250	300	138	775	950

DIMENSIONS (INCHES)										
A	B	C	D	E	F	G	H	J	K	L
48	24	1	4	4	6D	4	6	2 3/4	14	18
60	36	1 1/2	6	7	8D	6	8	3 1/2	20	24
72	48	2	6	10	10D	8	10	4 1/2	27	28
96	54	2	8	10	12D	10	12	5 1/2	31	38

COLORS

LEGEND & ARROW - WHITE (REFL)
 BACKGROUND - BLUE (REFL)

D7-101

10/97



NOTE: ANGLE OF SLOPE IS $52\frac{1}{2}^{\circ}$ FROM HORIZONTAL

DIMENSIONS (MILLIMETERS)					
A	B	C	D	E	F
VAR	VAR	19	150D	VAR	75
VAR	VAR	38	200D	VAR	150

DIMENSIONS (INCHES)					
A	B	C	D	E	F
VAR	VAR	3/4	6D	VAR	3
VAR	VAR	1 1/2	8D	VAR	6

COLORS

LEGEND - WHITE (REFL)

BACKGROUND - BROWN (REFL)

D7-201

10/97

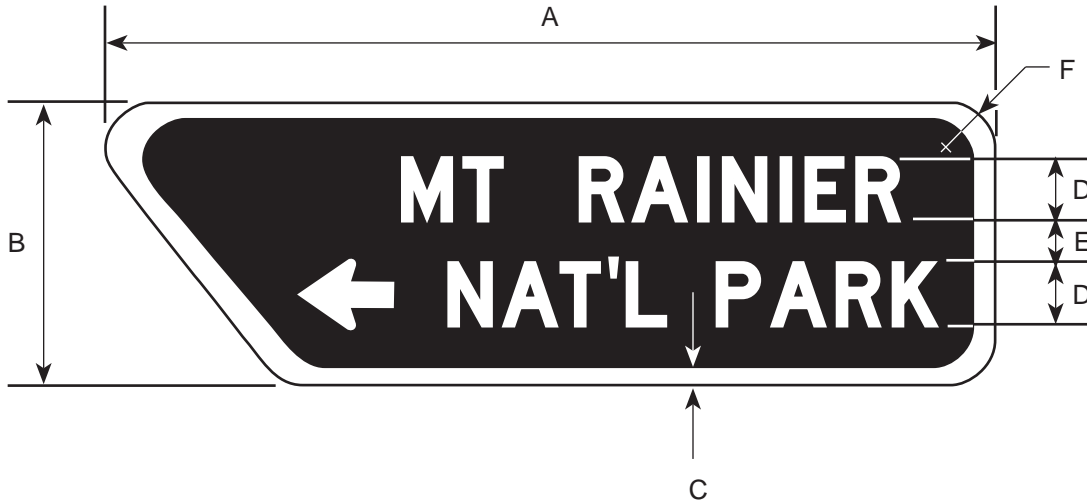

* See appendix for standard arrow details

NOTE: ANGLE OF SLOPE IS $52\ 1/2^{\circ}$ FROM HORIZONTAL
DIMENSIONS TYPICAL OF BOTH SIGNS

DIMENSIONS (MILLIMETERS)					
A	B	C	D	E	F
VAR	VAR	19	150D	VAR	75
VAR	VAR	38	200D	VAR	150

DIMENSIONS (INCHES)					
A	B	C	D	E	F
VAR	VAR	3/4	6D	VAR	3
VAR	VAR	1 1/2	8D	VAR	6

COLORS

LEGEND - WHITE (REFL)
BACKGROUND - BROWN (REFL)

D7-301, D7-301L & D7-301R

10/97

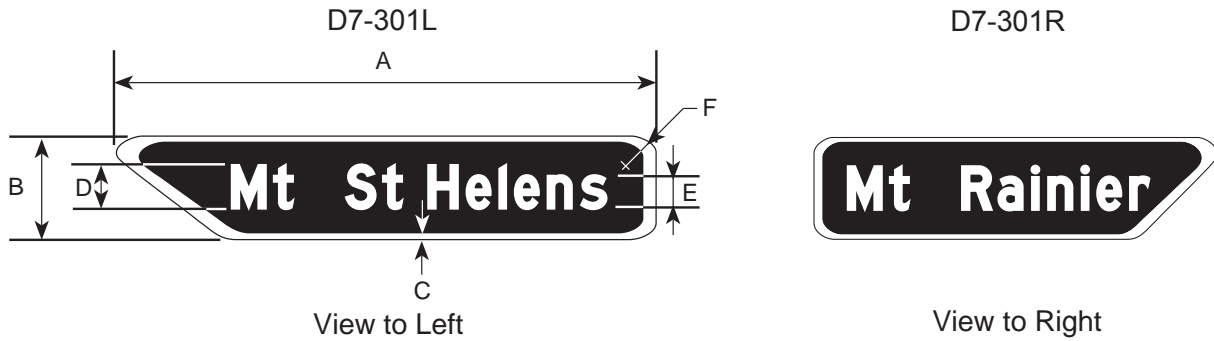

D7-301



View Straight Ahead

NOTE: ANGLE OF SLOPE IS $52\frac{1}{2}^{\circ}$ FROM HORIZONTAL
DIMENSIONS TYPICAL OF ALL VIEW SIGNS

DIMENSIONS (MILLIMETERS)					
A	B	C	D	E	F
VAR	300	19	150	113	38

DIMENSIONS (INCHES)					
A	B	C	D	E	F
VAR	12	3/4	6	4 1/2	1 1/2

COLORS

LEGEND - WHITE (REFL)
BACKGROUND - BROWN (REFL)

D7-301P

10/97

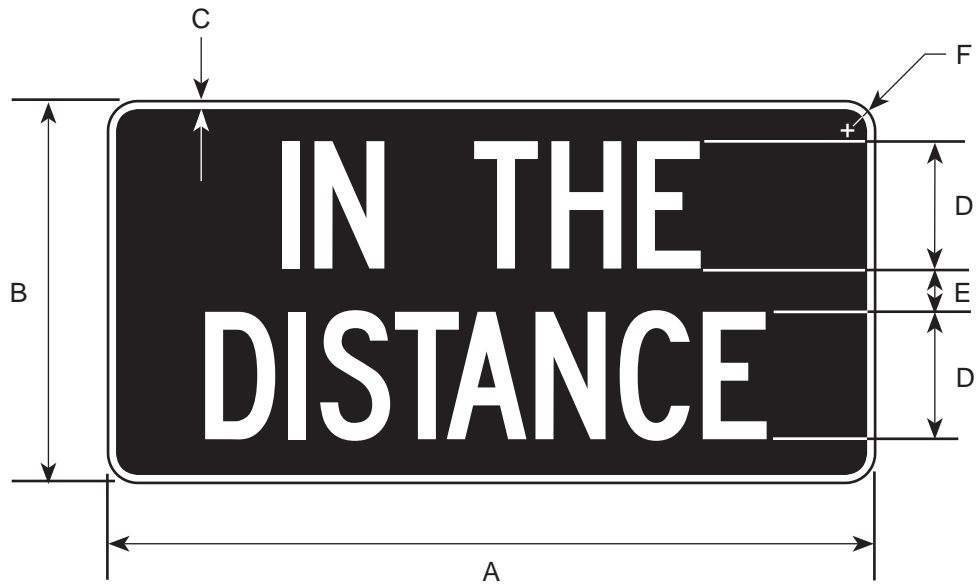

DIMENSIONS (MILLIMETERS)					
A	B	C	D	E	F
600	300	19	100C	31	38

DIMENSIONS (INCHES)					
A	B	C	D	E	F
24	12	3/4	4C	1 1/4	1 1/2

COLORS

LEGEND - WHITE (REFL)
 BACKGROUND - BROWN (REFL)

RECREATIONAL FACILITY SYMBOL SIGNS

6/06

D7 SERIES (CONT'D)



RECREATIONAL FACILITY LEGEND SIGNS



Note: All signs are 600 millimeters x 600 millimeters (24 inches x 24 inches), with a 13 millimeter (1/2 inch) border and a 38 millimeter (1 1/2 inch) corner radius

COLORS

SYMBOL & LEGEND — WHITE (REFL)
BACKGROUND — BROWN

D7-7701

10/97

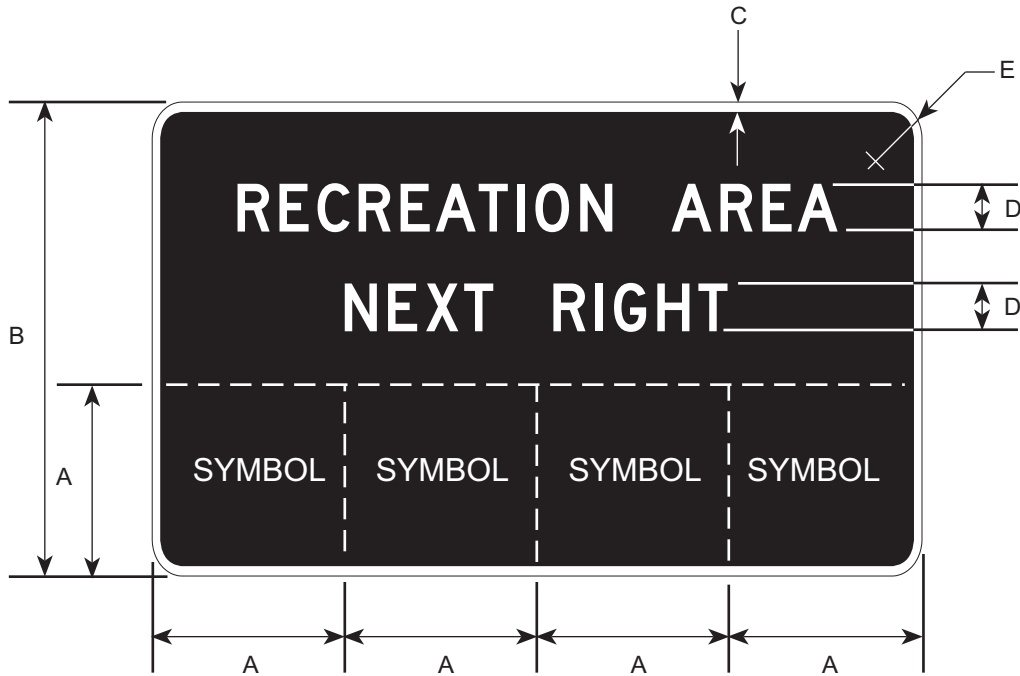

DIMENSIONS (MILLIMETERS)				
A	B	C	D	E
600	1500	16	150D	188

DIMENSIONS (INCHES)				
A	B	C	D	E
24	60	5/8	6D	7 1/2

COLORS

LEGEND - WHITE (REFL)
 BACKGROUND - BROWN (REFL)

D8-1

10/97



DIMENSIONS (MILLIMETERS)							
A	B	C	D	E	F	G	H
1500	1200	38	150	200E	150E	150	75
1950	1500	50	200	250E	200E	175	100
2400	1800	50	225	300E	250E	225	125

DIMENSIONS (INCHES)							
A	B	C	D	E	F	G	H
60	48	1 1/2	6	8E	6E	6	3
78	60	2	8	10E	8E	7	4
96	72	2	9	12E	10E	9	5

COLORS

LEGEND - WHITE (REFL)
 BACKGROUND - GREEN (REFL)

D8-101

10/97

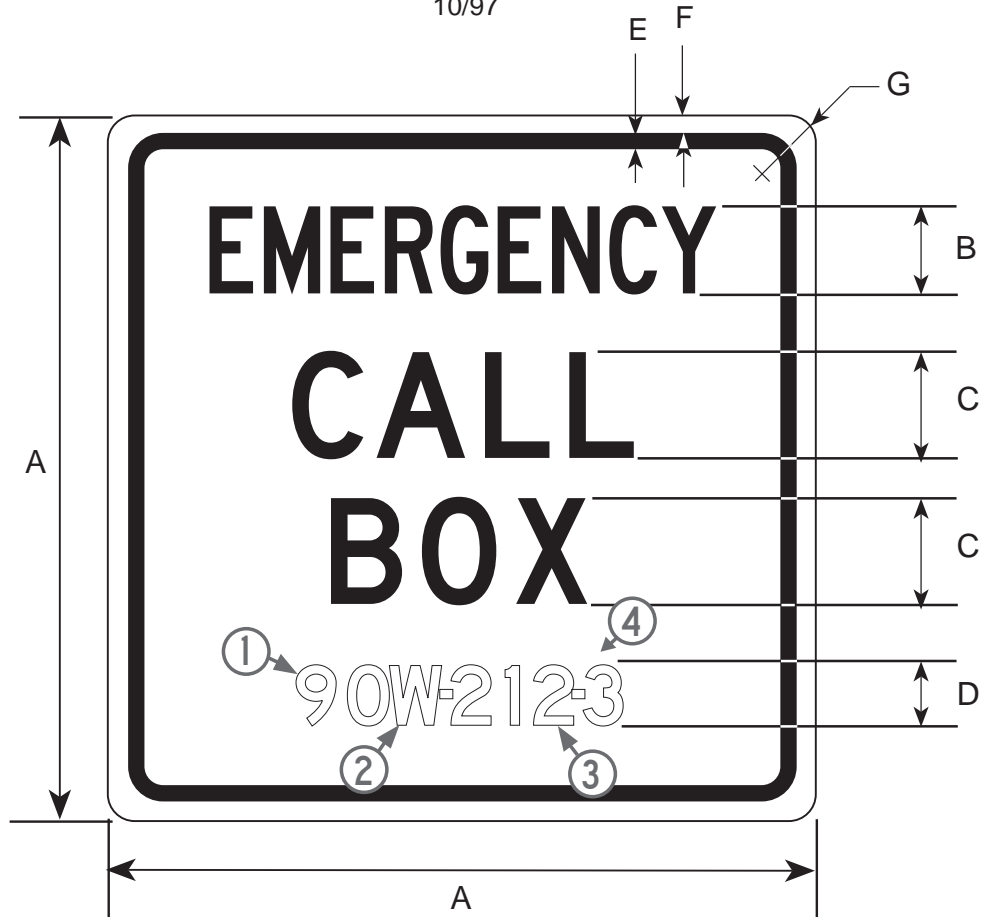

DIMENSIONS (MILLIMETERS)						
A	B	C	D	E	F	G
750	100	150	75	16	22	47

DIMENSIONS (INCHES)						
A	B	C	D	E	F	G
30	4C	6E	3C	5/8	7/8	1 7/8

- ① ROUTE NUMBER
- ② LANE DIRECTION. OTHER DESIGNATION MAY BE NEEDED.
EXAMPLES: X; EXPRESS LANES, M; MEDIAN, R; RAMP.
- ③ MILE POST
- ④ THE NUMBER OF THE CALL BOX WITHIN THE MILEPOST,
FOR LOCATIONS WHERE THERE IS MORE THAN ONE CALL BOX PER MILE.

COLORS

LEGEND, BORDER - BLUE(REFL)

BACKGROUND - WHITE (REFL)

D8-201

10/97

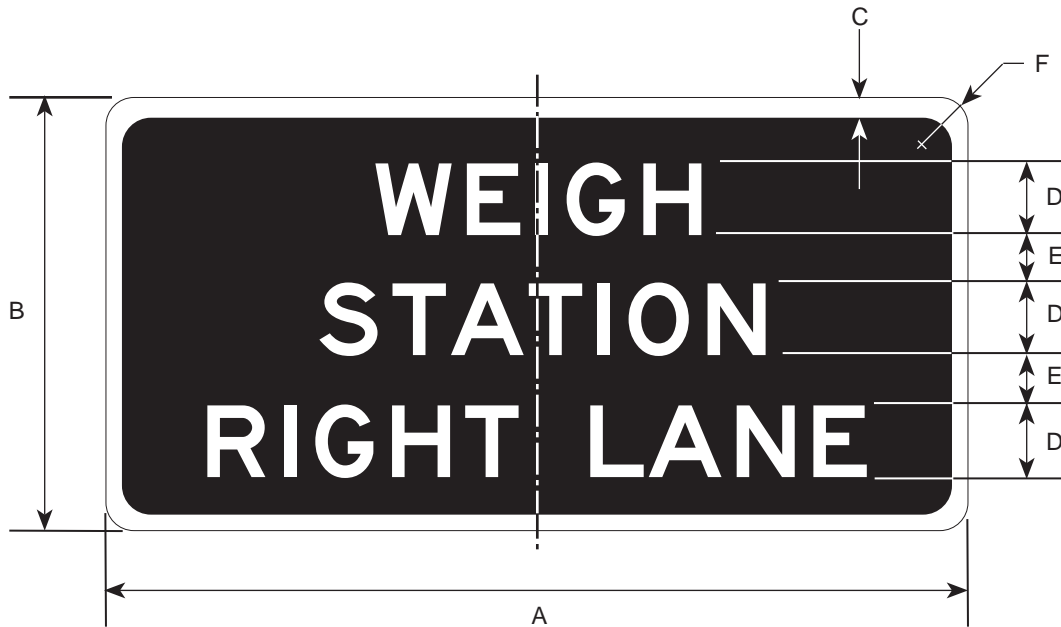

DIMENSIONS (MILLIMETERS)					
A	B	C	D	E	F
1800	900	38	150D	100	100
2700	1500	50	250D	175	150

DIMENSIONS (INCHES)					
A	B	C	D	E	F
72	36	1 1/2	6D	4	4
108	60	2	10D	7	6

COLORS

LEGEND - WHITE (REFL)
BACKGROUND - GREEN (REFL)

D8-202

10/97

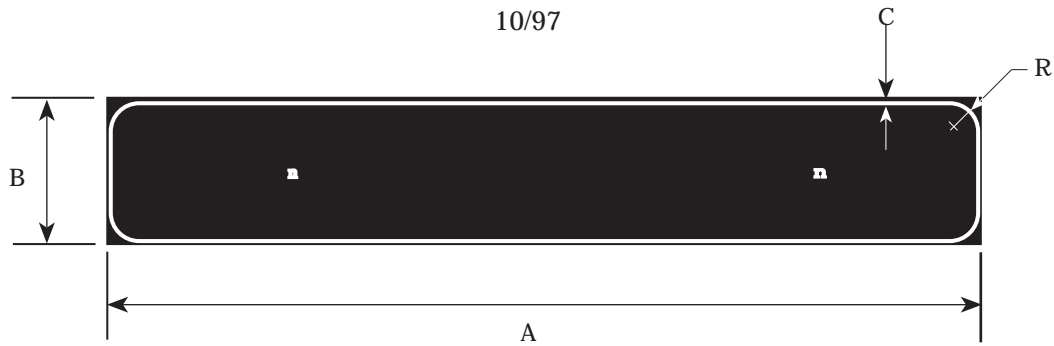

DIMENSIONS (MILLIMETERS)			
A	B	C	R
1800	300	38	100
2700	600	50	150

DIMENSIONS (INCHES)			
A	B	C	R
72	12	1 1/2	4
108	24	2	6

FRONT



DIMENSIONS (MILLIMETERS)		
E	F	G
1050	200	150E
1650	300	250E

BACK



DIMENSIONS (INCHES)		
E	F	G
42	8	6E
66	12	10E

THE OPEN-CLOSED PLAQUE MAY BE ATTACHED BY MEANS OF TWO STAINLESS STEEL 1/4" BOLTS 1/2" LONG AND WING NUTS. THE BOLT SHALL BE SECURED TO THE MAIN SIGN PANEL BY LOCKNUTS.

COLORS

LEGEND - WHITE (REFL)
BACKGROUND - GREEN (REFL)

D8-301

12/05

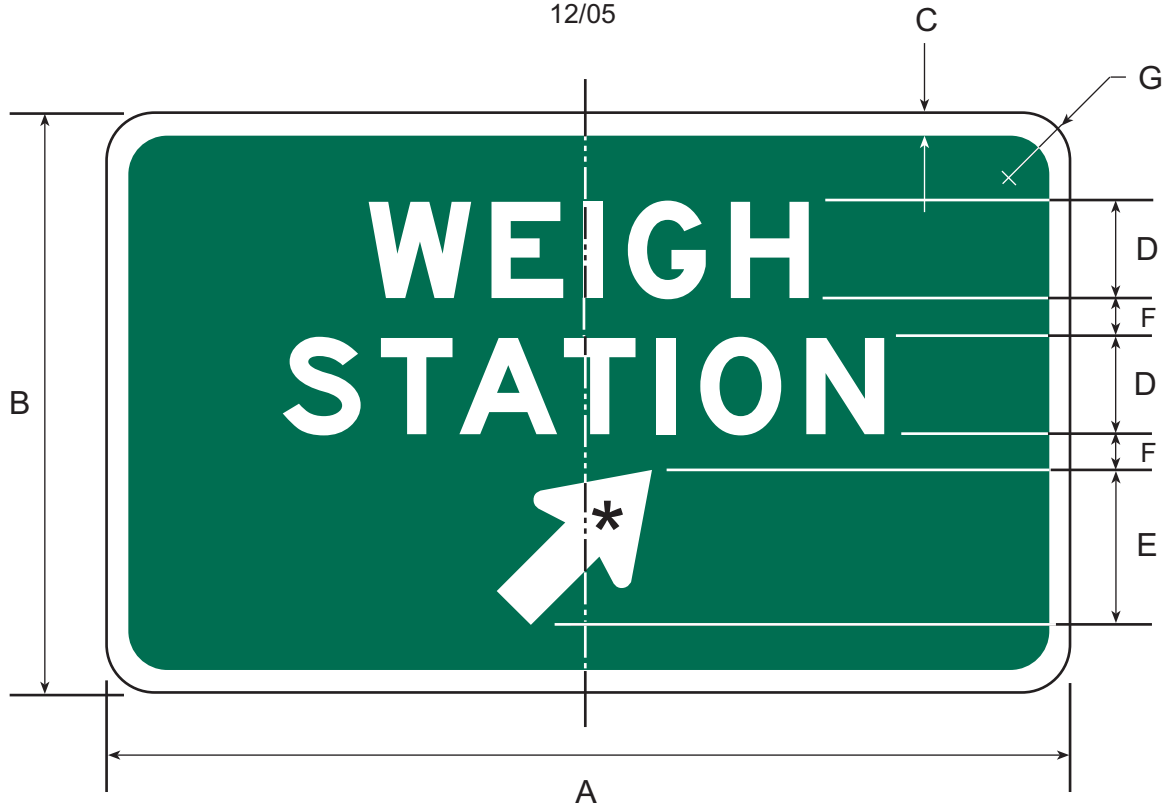

* SEE APPENDIX FOR STANDARD ARROW DETAILS

DIMENSIONS (MILLIMETERS)						
A	B	C	D	E	F	G
1200	1050	38	150E	NO.1	100	100
1500	1350	38	200E	NO.2	150	125
2100	1800	50	250E	NO.2	200	150

DIMENSIONS (INCHES)						
A	B	C	D	E	F	G
48	42	1 1/2	6E	NO.1	4	4
60	54	1 1/2	8E	NO.2	6	5
84	72	2	10E	NO.2	8	6

COLORS

LEGEND — WHITE (REFL)
 BACKGROUND — GREEN (REFL)

MOTORIST SERVICE & RECREATIONAL FACILITY SYMBOL SIGNS

6/00

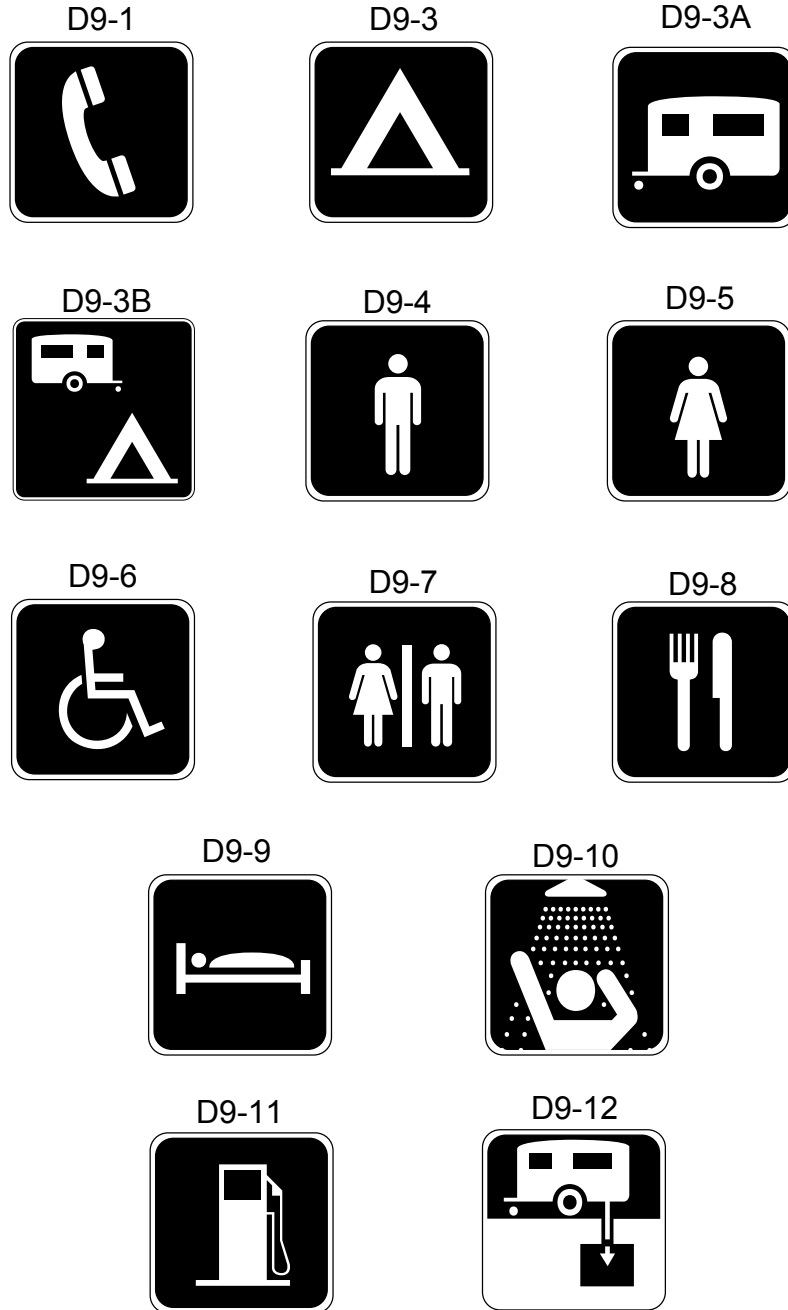

ALL SIGNS ARE 600 X 600mm. (24 X 24in)

NOTE: DESIGNERS SPECIFY MOTORIST SERVICE OR RECREATIONAL

COLORS

SYMBOL — WHITE (REFL)

MOTORIST SERVICE: BACKGROUND — BLUE (REFL)

RECREATIONAL: BACKGROUND — BROWN (REFL)

D9-1

10/97

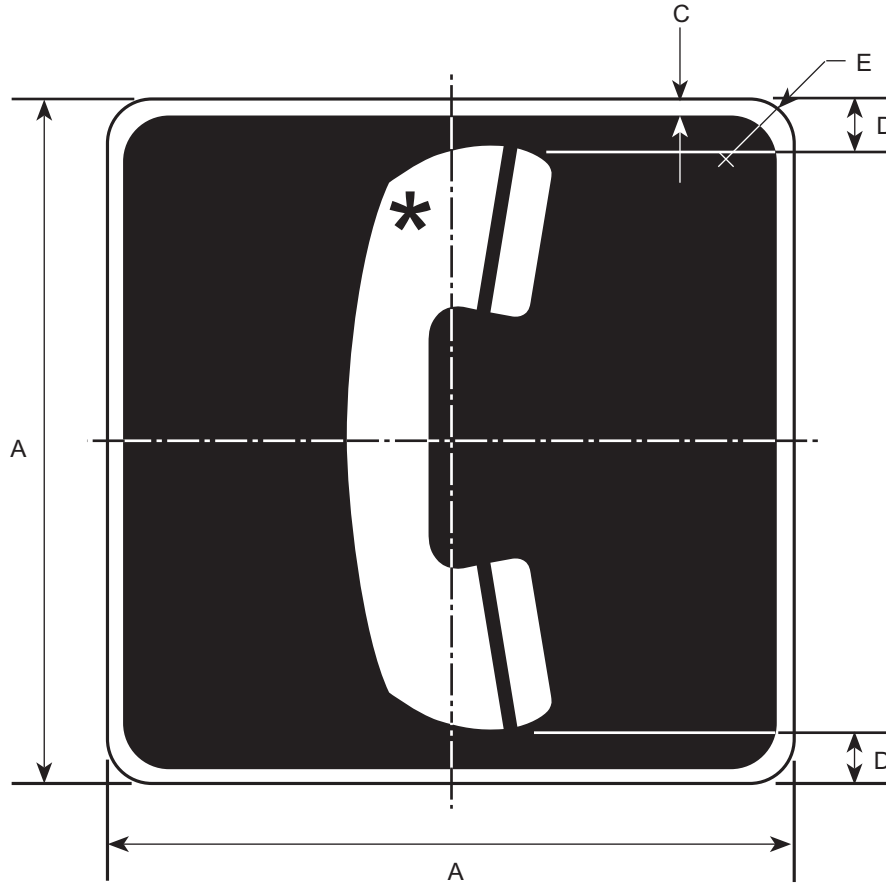

* SEE APPENDIX FOR SYMBOL DESIGN

DIMENSIONS (MILLIMETERS)			
A	C	D	E
450	13	25	38
600	13	38	38
750	19	50	47

DIMENSIONS (INCHES)			
A	C	D	E
18	1/2	1	1 1/2
24	1/2	1 1/2	1 1/2
30	3/4	2	1 7/8

COLORS

LEGEND — WHITE (REFL)
BACKGROUND — BLUE

D9-1A

10/97

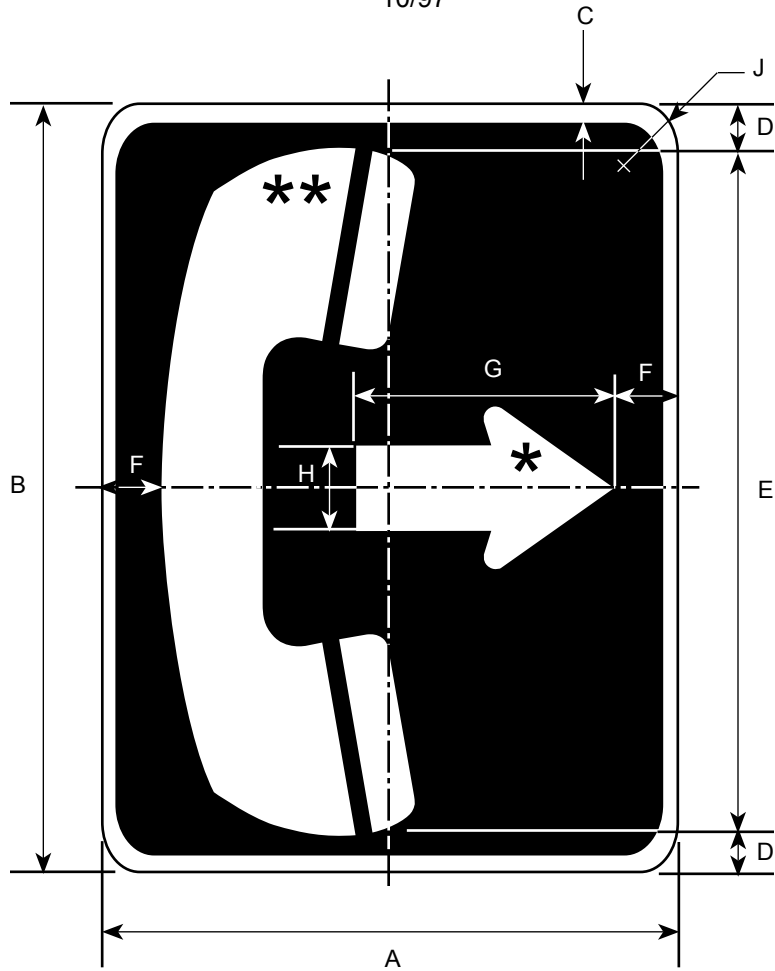

- * SEE APPENDIX FOR STANDARD ARROW DETAILS
- ** SEE APPENDIX FOR SYMBOL DESIGN

DIMENSIONS (MILLIMETERS)								
A	B	C	D	E	F	G	H	J
450	600	13	38	525	44	263	66	38
600	750	16	50	650	63	263	66	38
750	900	19	63	775	75	331	81	47

DIMENSIONS (INCHES)								
A	B	C	D	E	F	G	H	J
18	24	1/2	1 1/2	21	1 1/4	8 1/2	2	1 1/2
24	30	5/8	2	26	2 1/2	10 1/2	2 5/8	1 1/2
30	36	3/4	2 1/2	31	3	13 1/4	3 1/4	1 7/8

COLORS

LEGEND — WHITE (REFL)
BACKGROUND — BLUE

D9-1B

10/97

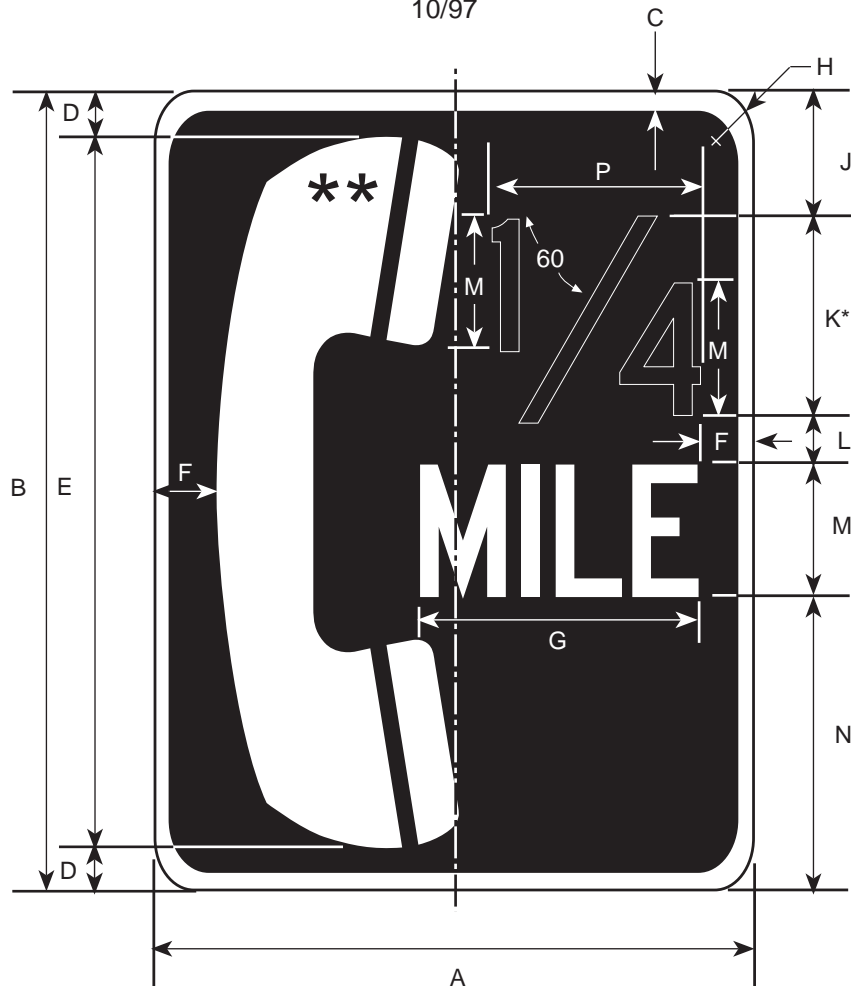

* OPTICALLY SPACE NUMERAL(S) ABOVE 'MILE'
 ** SEE APPENDIX FOR SYMBOL DESIGN

DIMENSIONS (MILLIMETERS)													
A	B	C	D	E	F	G	H	J	K	L	M	N	P
450	600	13	38	525	25	238	38	94	150	38	100	219	200
600	750	16	50	650	38	297	38	11	188	50	125	275	250
750	900	19	63	775	50	356	47	125	225	63	150	338	300

DIMENSIONS (INCHES)													
A	B	C	D	E	F	G	H	J	K	L	M	N	P
18	24	1/2	1 1/2	21	1	9 1/2	1 1/2	3 3/4	6	1 1/2	4C	8 3/4	8
24	30	5/8	2	26	1 1/2	11 7/8	1 1/2	4 1/2	7 1/2	2	5C	1	10
30	36	3/4	2 1/2	31	2	14 1/4	1 7/8	5	9	2 1/2	6C	13 1/2	12

COLORS

LEGEND - WHITE (REFL)
 BACKGROUND - BLUE (REFL)

D9-101, D9-102 & D9-103

10/97

D9-101



D9-102



D9-103



INDICATE MESSAGE REQUIRED IF DIFFERENT THAN THOSE SHOWN

DIMENSIONS (MILLIMETERS)				
LETTER SIZE	SIGN SIZE			BORDER WIDTH
	D9-101	D9-102	D9-103	
200E	3000 X 2100	3000 X 1200	2400 X 1200	38
250E	3600 X 2700	3600 X 1500	3000 X 1500	50

DIMENSIONS (INCHES)				
LETTER SIZE	SIGN SIZE			BORDER WIDTH
	D9-101	D9-102	D9-103	
8E	120 X 84	120 X 48	96 X 48	1 1/2
10E	144 X 108	144 X 60	120 X 60	2

COLORS

LEGEND - WHITE (REFL.)
BACKGROUND - BLUE (REFL.)

D9-1101

11/97

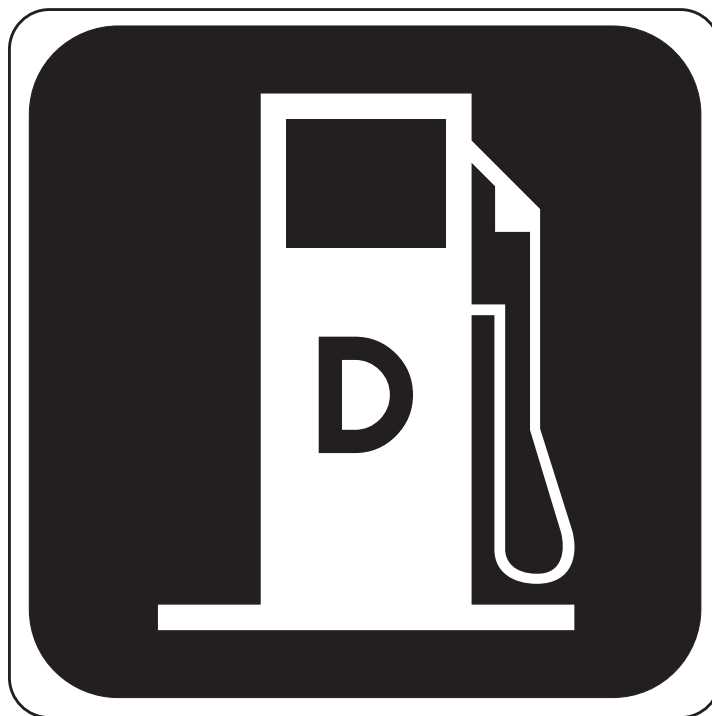

SIGN DIMENSIONS ARE 600 X 600mm. (24 X 24in)

COLORS

SYMBOL - WHITE (REFL)
BACKGROUND - BLUE (REFL)

D9-2

4/98

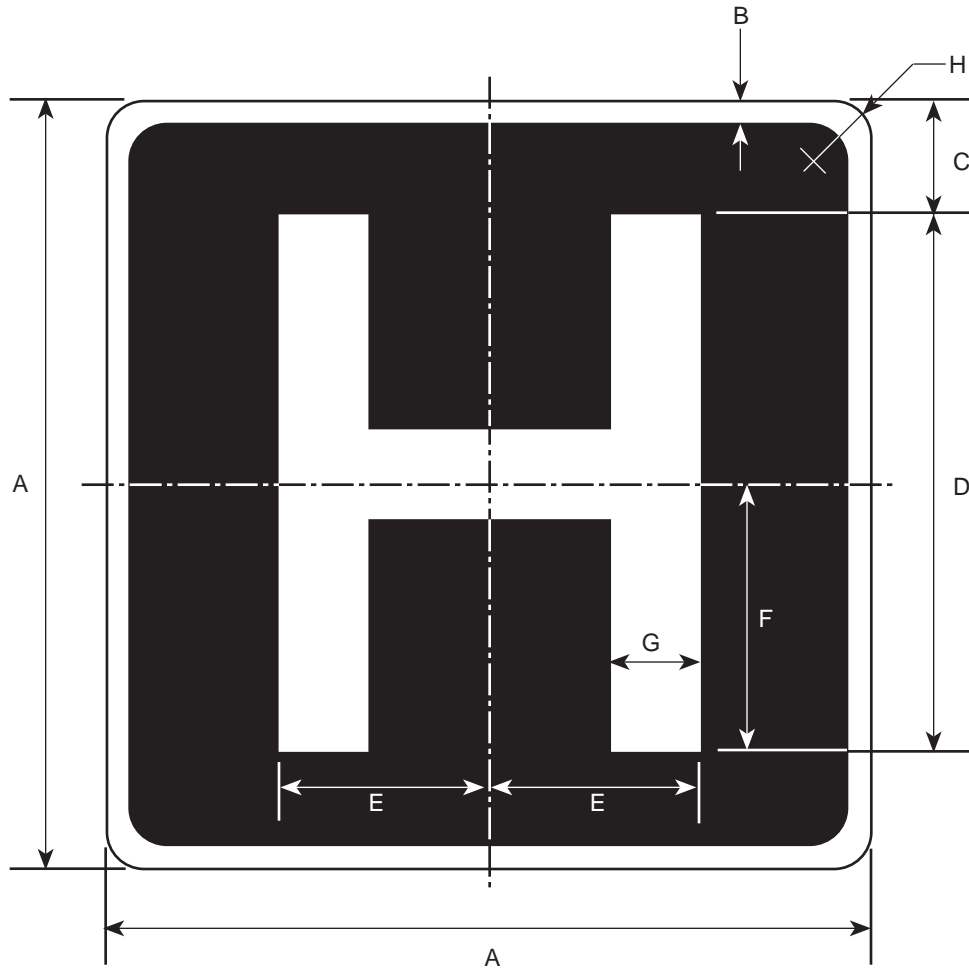

DIMENSIONS (MILLIMETERS)							
A	B	C	D	E	F	G	H
600	13	100	400	159	200	81	38
750	19	125	500	200	250	100	47

DIMENSIONS (INCHES)							
A	B	C	D	E	F	G	H
24	1/2	4	16	6 3/8	8	3 1/4	1 1/2
30	3/4	5	20	8	10	4	1 7/8

COLORS

LEGEND - WHITE (REFL)
BACKGROUND - BLUE (REFL)

D9-301

11/97

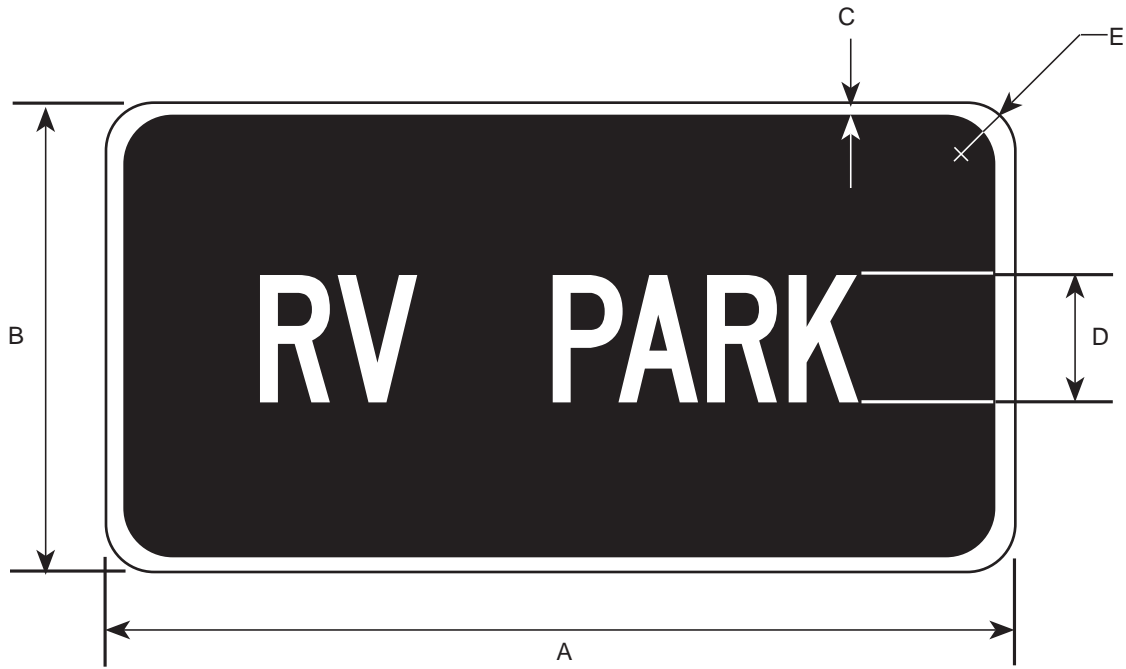

DIMENSIONS (MILLIMETERS)				
A	B	C	D	E
600	300	13	100C	38

DIMENSIONS (INCHES)				
A	B	C	D	E
24	12	1/2	4C	1 1/2

COLORS

LEGEND - WHITE (REFL)
BACKGROUND - BLUE (REFL) OR BROWN (REFL)

D9-401

6/03

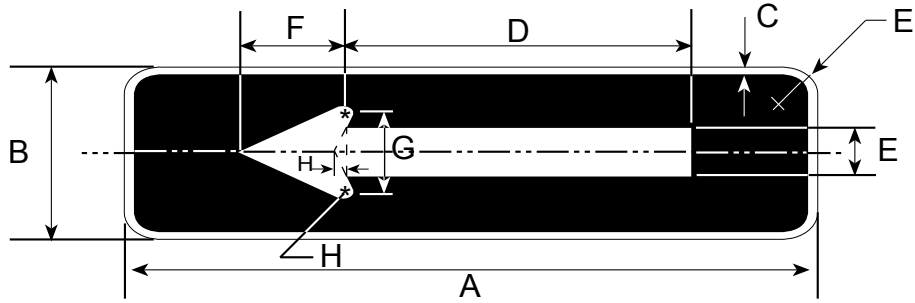

DIMENSIONS (MILLIMETERS)							
A	B	C	D	E	F	G	H
600	150	13	300	38	75	88	6

DIMENSIONS (INCHES)							
A	B	C	D	E	F	G	H
24	6	1/2	12	1 1/2	3	3 1/2	1/4

COLORS
 LEGEND - WHITE (REFL)
 BACKGROUND - BLUE, GREEN, OR BROWN (REFL)

D9-501

11/97

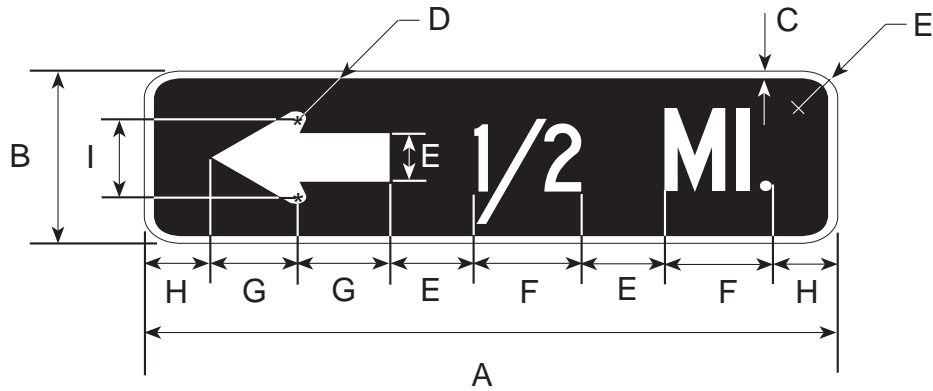

NOTE: USE 4 1/100mm SERIES C FOR CAP,
4 1/100mm SERIES C NUMERALS OR
3 1/75mm SERIES C FRACTION.

DIMENSIONS (MILLIMETERS)								
A	B	C	D	E	F	G	H	I
600	150	13	188	38	125	75	50	87 1/2

DIMENSIONS (INCHES)								
A	B	C	D	E	F	G	H	I
24	6	1/2	1/4	1 1/2	5	3	2	3 1/2

COLORS

LEGEND - WHITE (REFL)
BACKGROUND - BLUE OR BROWN (REFL)

D9-502

11/97

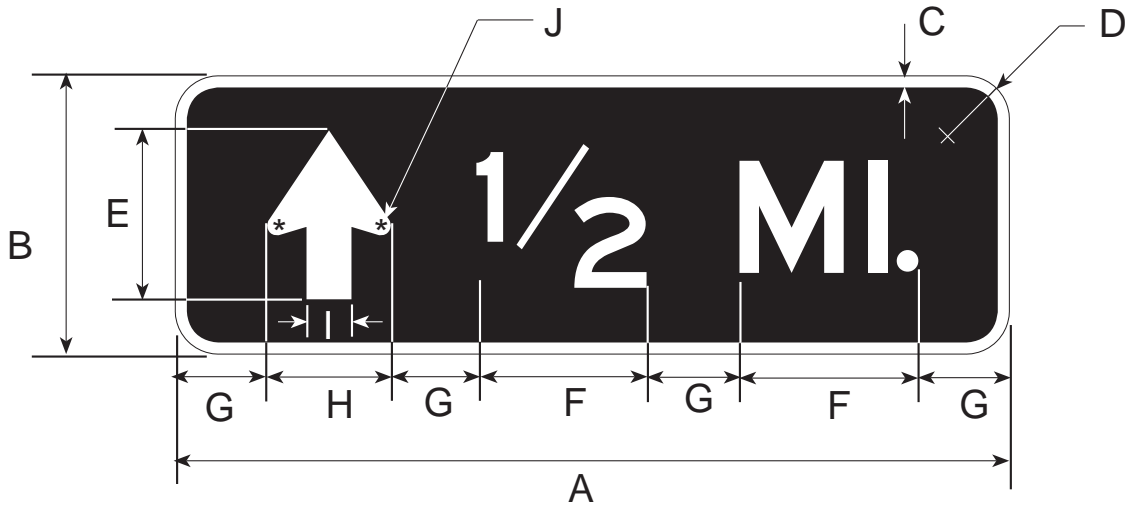

NOTE: USE 4" / 100 mm SERIES C FOR CAPS,
4" / 100 mm SERIES C NUMERALS OR
3" / 75 mm SERIES C FRACTION.

DIMENSIONS (MILLIMETERS)									
A	B	C	D	E	F	G	H	I	J
600	225	9	38	150	125	63	100	38	6

DIMENSIONS (INCHES)									
A	B	C	D	E	F	G	H	I	J
24	9	3/8	1 1/2	6	5	2 1/2	4	1 1/2	1/4

COLORS

LEGEND - WHITE (REFL)
BACKGROUND - BLUE OR BROWN (REFL)

D9-11A

1/06

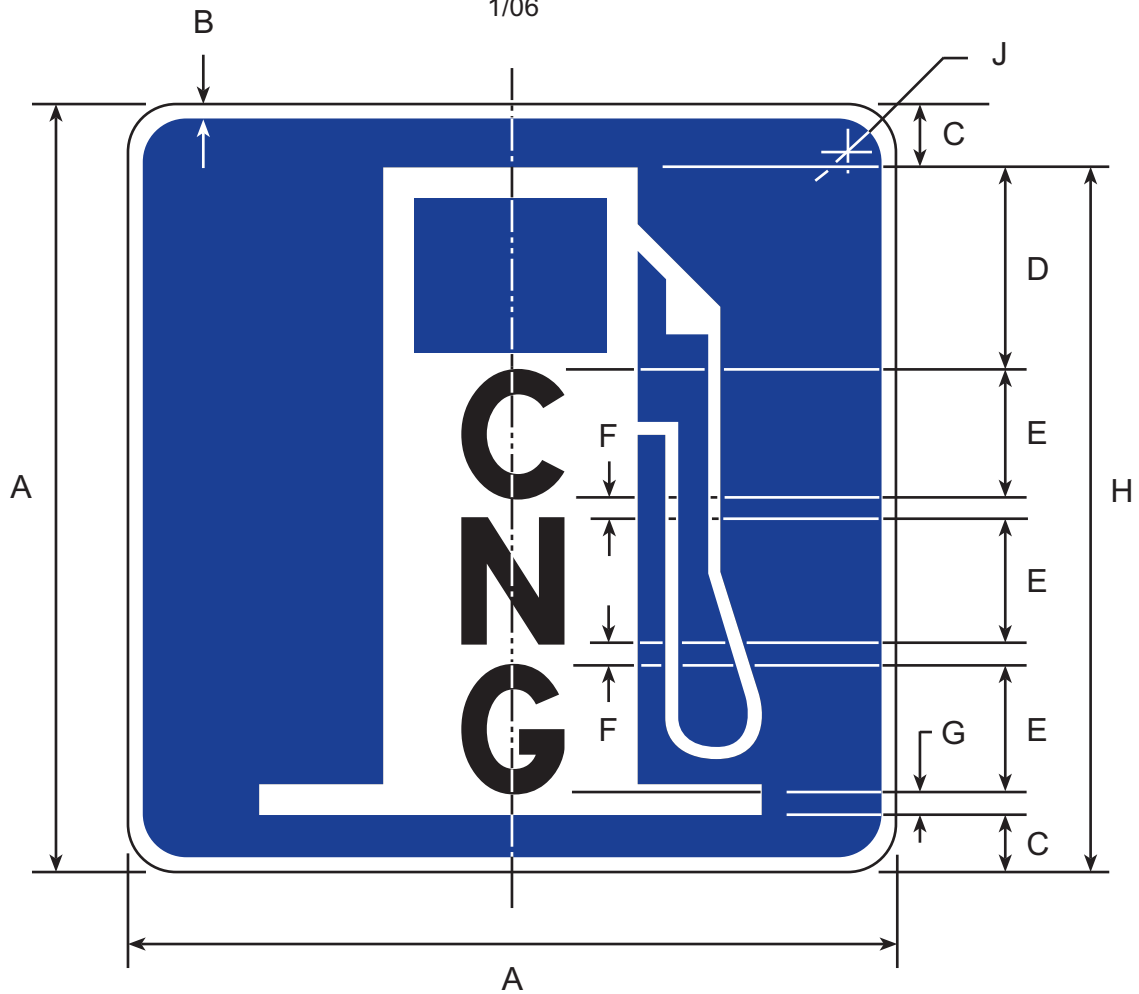

DIMENSIONS (MILLIMETERS)								
A	B	C	D	E	F	G	H	J
450	13	37.5	113	75EM	13	13	375	38
600	13	50	150	100EM	16	18	500	38
750	19	62.5	191	125EM	17	25	625	47

DIMENSIONS (INCHES)								
A	B	C	D	E	F	G	H	J
18	1/2	1 1/2	4 1/2	3EM	1/2	1/2	15	1 1/2
24	1/2	2	6	4EM	5/8	3/4	20	1 1/2
30	3/4	2 1/2	7 5/8	5EM	11/16	1	25	1 7/8

COLORS

LEGEND & BACKGROUND - BLUE (REFL)
 SYMBOL - WHITE (REFL)

D9-11B

1/06

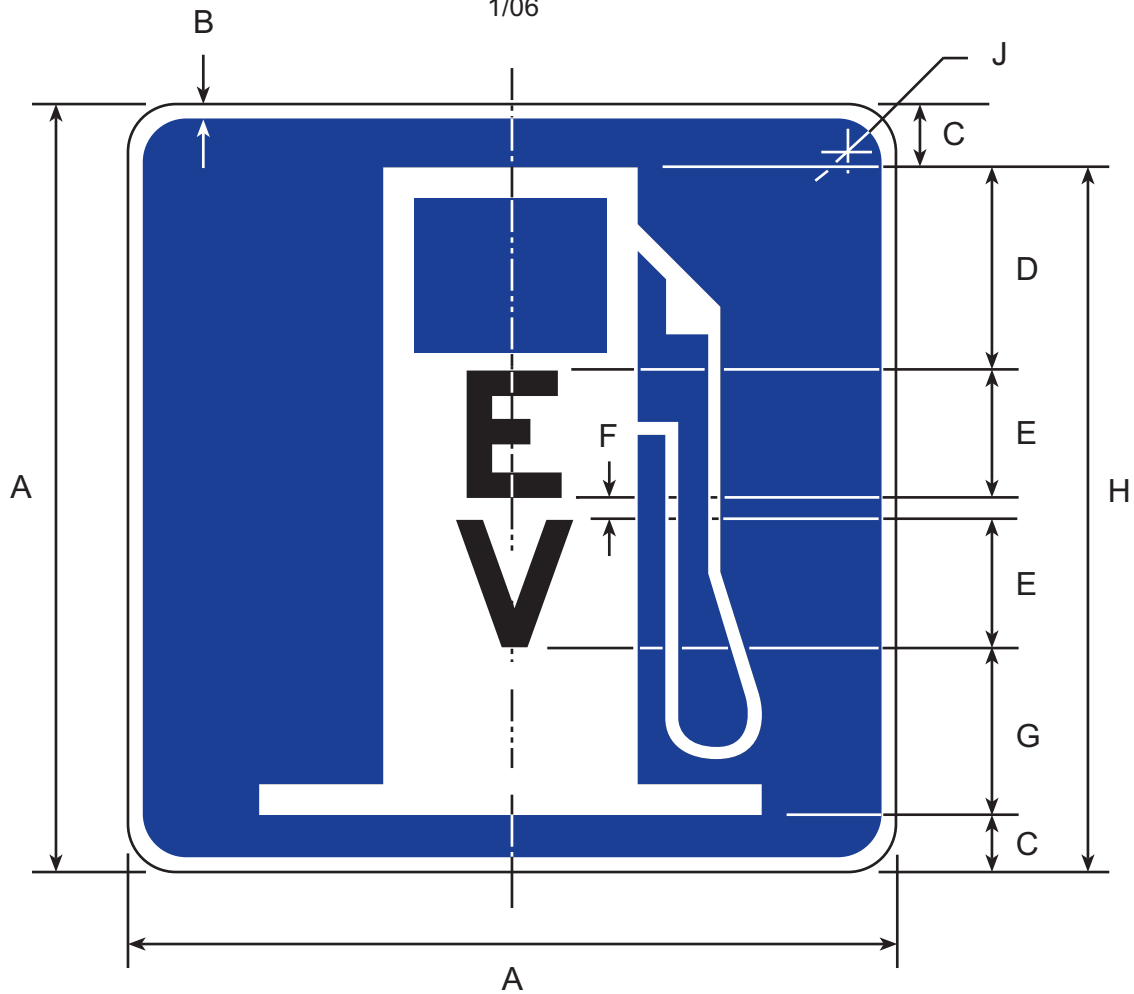

DIMENSIONS (MILLIMETERS)								
A	B	C	D	E	F	G	H	J
450	13	37.5	113	75EM	13	99	375	38
600	13	50	150	100EM	16	137	500	38
750	19	62.5	191	125EM	17	167	625	47

DIMENSIONS (INCHES)								
A	B	C	D	E	F	G	H	J
18	1/2	1 1/2	4 1/2	3EM	1/2	4	15	1 1/2
24	1/2	2	6	4EM	5/8	5 3/8	20	1 1/2
30	3/4	2 1/2	7 1/2	5EM	3/4	6 3/4	25	1 7/8

COLORS

LEGEND & BACKGROUND - BLUE (REFL)
 SYMBOL - WHITE (REFL)

D9-13

11/97



SIGN DIMENSIONS ARE 600 X 600mm. (24 X 24in)

COLORS

SYMBOL - WHITE (REFL)
BACKGROUND - BLUE (REFL)

D9-13A

12/05

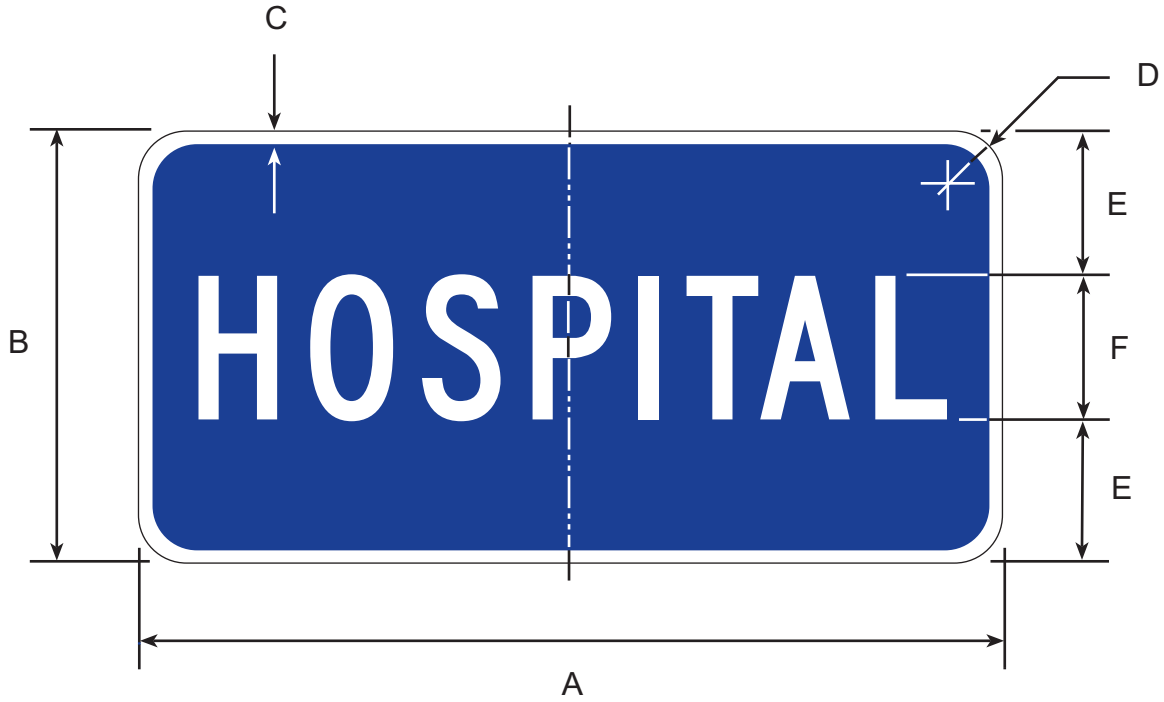

DIMENSIONS (MILLIMETERS)					
A	B	C	D	E	F
600	300	13	38	100	100C

DIMENSIONS (INCHES)					
A	B	C	D	E	F
24	12	1/2	1 1/2	4	4C

COLORS

LEGEND - WHITE (REFL)
 BACKGROUND - BLUE (REFL)

D9-13B

12/05

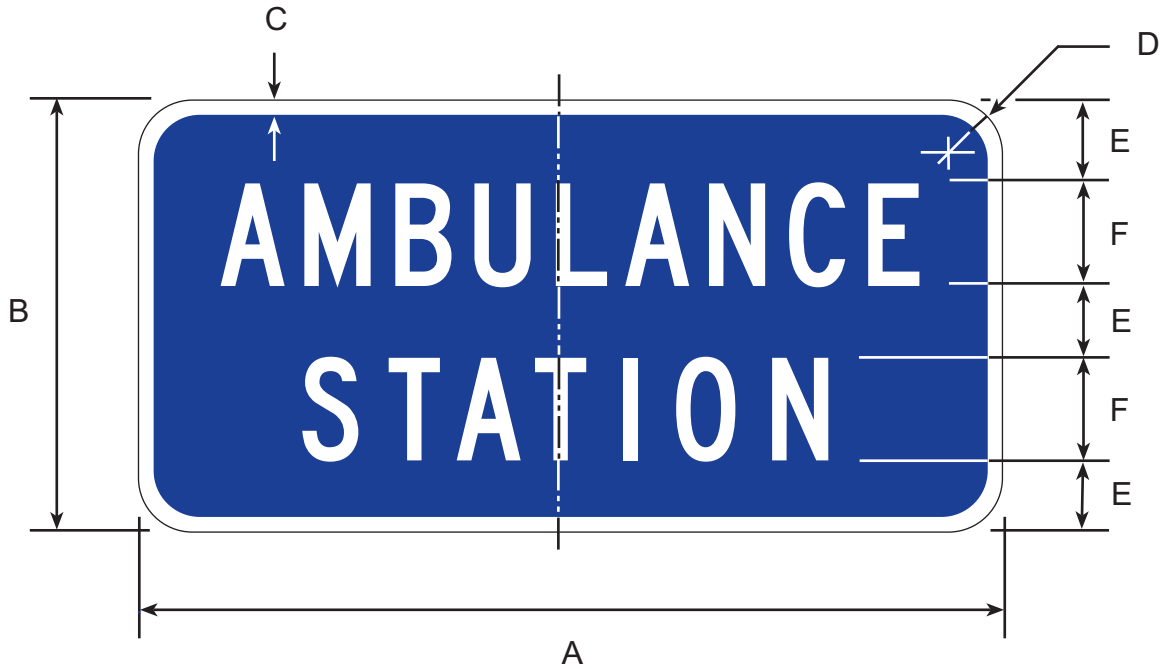

DIMENSIONS (MILLIMETERS)					
A	B	C	D	E	F
600	300	13	38	50	75C

DIMENSIONS (INCHES)					
A	B	C	D	E	F
24	12	1/2	1 1/2	2	3C

COLORS

LEGEND - WHITE (REFL)
BACKGROUND - BLUE (REFL)

D9-13C

12/05

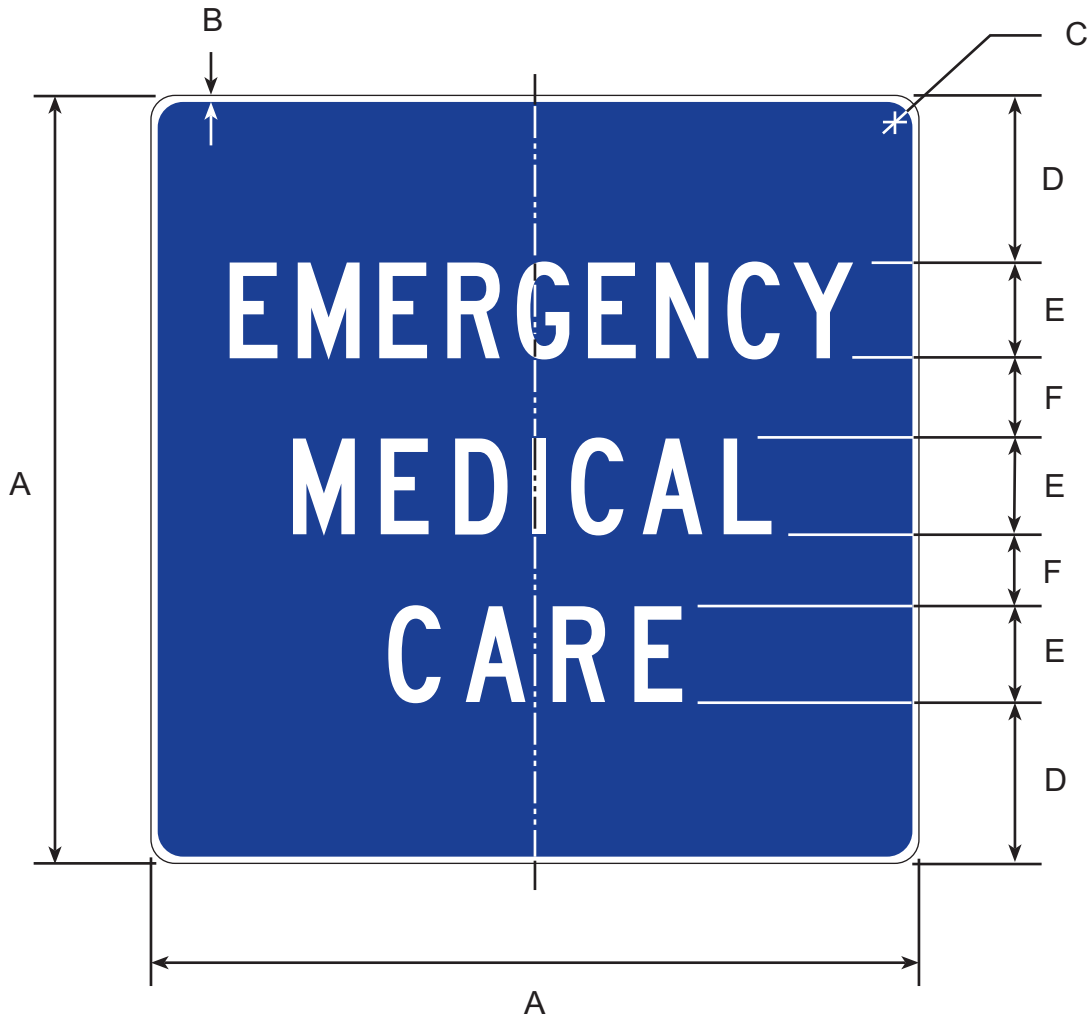

DIMENSIONS (MILLIMETERS)					
A	B	C	D	E	F
600	13	38	115	75C	72.5

DIMENSIONS (INCHES)					
A	B	C	D	E	F
24	1/2	1 1/2	4 3/4	3C	2 3/4

COLORS

LEGEND - WHITE (REFL)
BACKGROUND - BLUE (REFL)

D9-1301

11/97

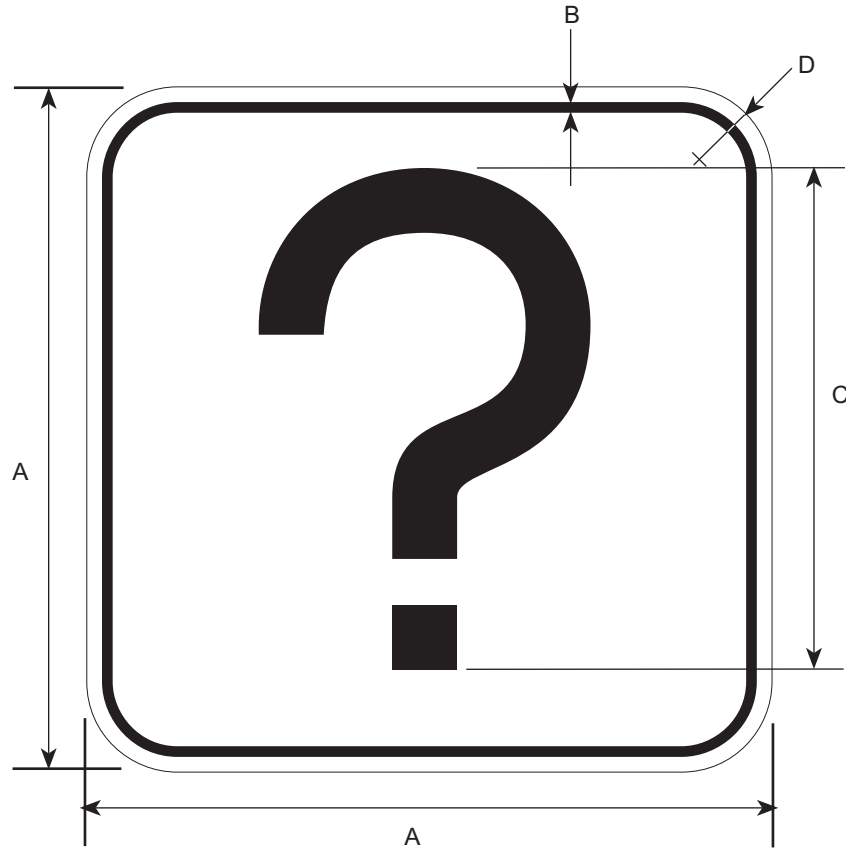

DIMENSIONS (MILLIMETERS)			
A	B	C	D
600	13	450	38

DIMENSIONS (INCHES)			
A	B	C	D
24	1/2	18	1 1/2

COLORS

LEGEND - WHITE (REFL.)
BACKGROUND - BLUE (REFL.)

D9-14

12/05

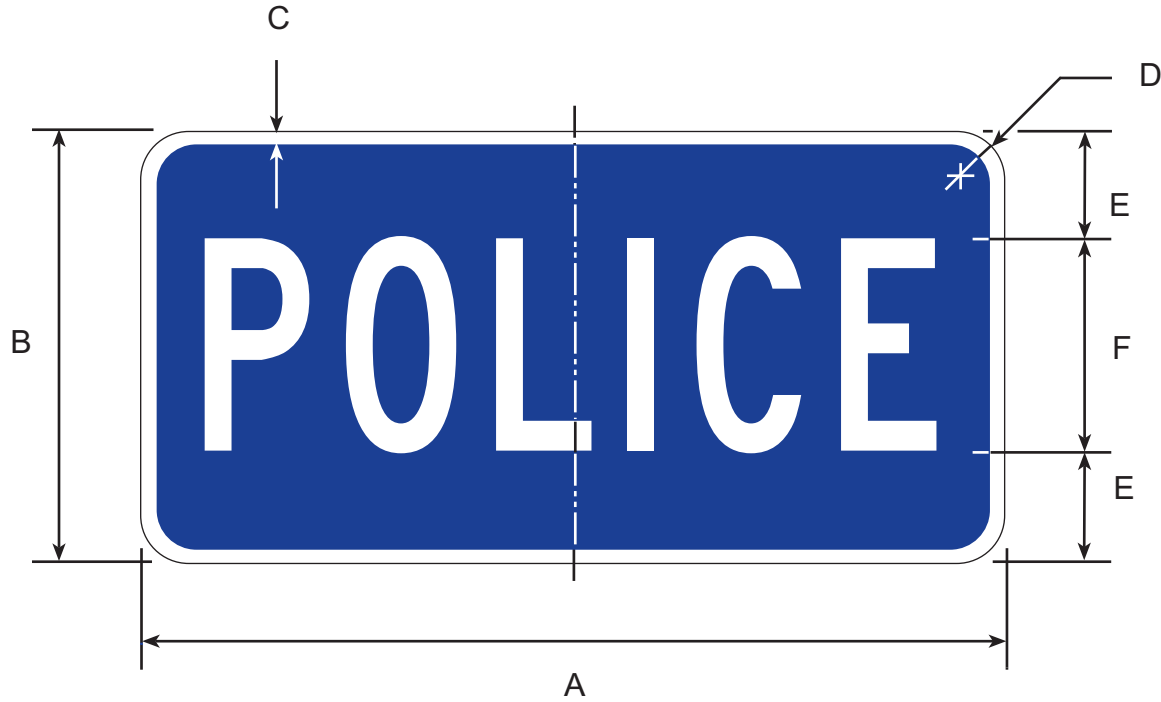

DIMENSIONS (MILLIMETERS)					
A	B	C	D	E	F
600	300	13	38	75	150C
750	450	13	38	125	200C

DIMENSIONS (INCHES)					
A	B	C	D	E	F
24	12	1/2	1 1/2	3	6C
30	18	1/2	1 1/2	5	8C

COLORS

LEGEND - WHITE (REFL)
 BACKGROUND - BLUE (REFL)

D9-15

11/97

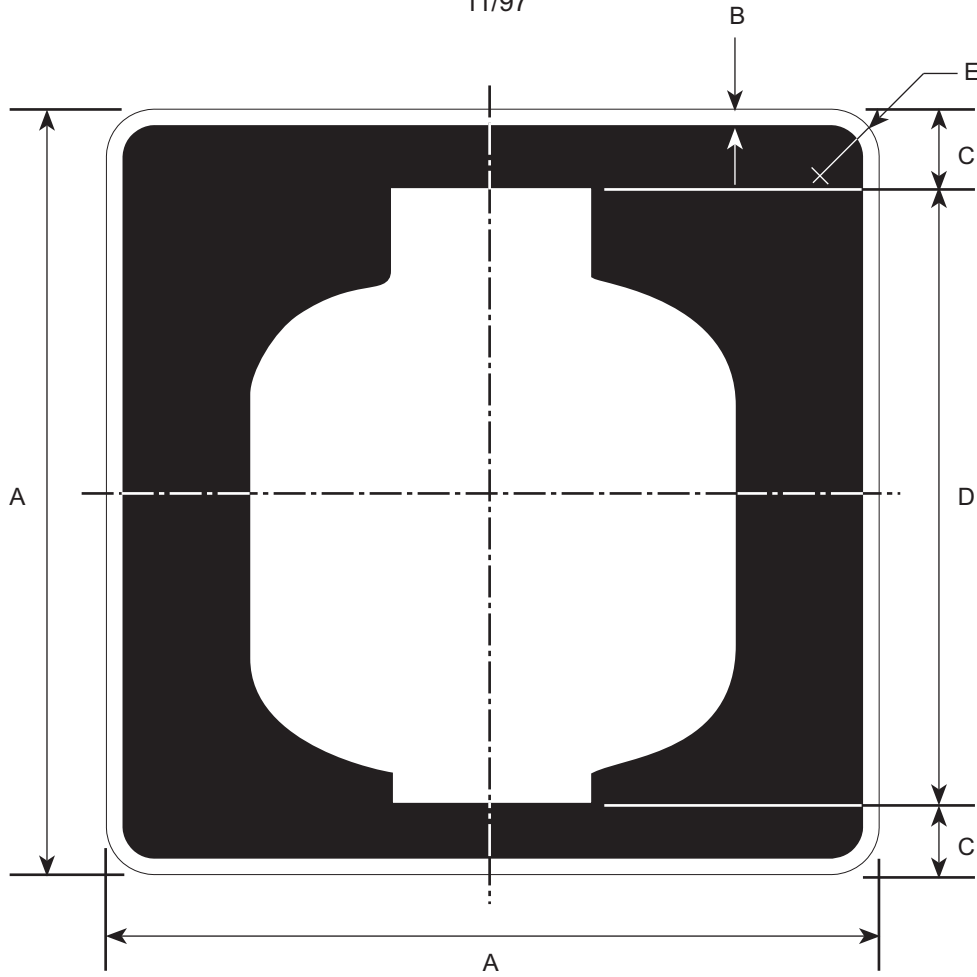

DIMENSIONS (MILLIMETERS)				
A	B	C	D	E
450	13	38	375	38
600	13	50	500	38
750	19	63	625	47

DIMENSIONS (INCHES)				
A	B	C	D	E
18	1/2	1 1/2	15	1 1/2
24	1/2	2	20	1 1/2
30	3/4	2 1/2	25	1 7/8

COLORS

SYMBOL - WHITE (REFL)
 BACKGROUND - BLUE (REFL)

D9-1601

1/06

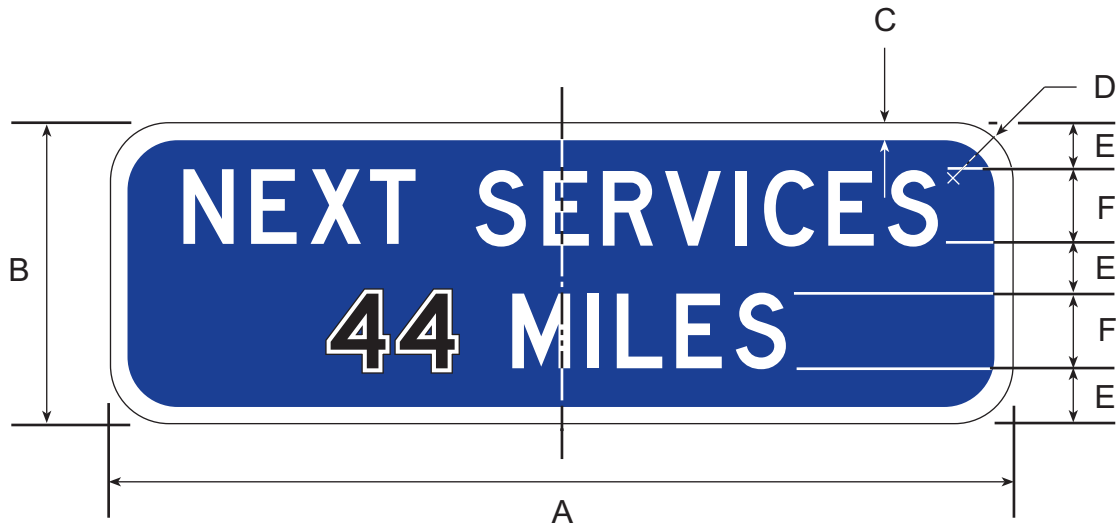

DIMENSIONS (MILLIMETERS)					
A	B	C	D	E	F
1800	600	38	100	100	150D
2400	900	38	150	165	200D

DIMENSIONS (INCHES)					
A	B	C	D	E	F
72	24	1 1/2	4	4	6D
96	36	1 1/2	6	6 1/2	8D

COLORS

LEGEND - WHITE (REFL.)
 BACKGROUND - BLUE (REFL.)

D10-1, D10-2 & D10-3

10/97

SINGLE FACED SIGNS



SIGN	DIMENSIONS (MILLIMETERS)					
	SIGN SIZE	LETTER SIZE AND SERIES	NUM. SIZE AND SERIES	BORDER WIDTH	CORNER RADIUS	HOLE CTRS.
D10-1	250 X 450	100B	150D	13	25	375
	300 X 600	100C	250D	19	38	525
D10-2	250 X 675	100B	150D	13	25	600
	300 X 900	100C	250D	19	38	825
D10-3	250 X 900	100B	150D	13	25	825
	300 X 1200	100C	250D	19	38	110

SIGN	DIMENSIONS (INCHES)					
	SIGN SIZE	LETTER SIZE AND SERIES	NUM. SIZE AND SERIES	BORDER WIDTH	CORNER RADIUS	HOLE CTRS.
D10-1	10 X 18	4B	6D	1/2	1	15
	12 X 24	4C	10D	3/4	1 1/2	21
D10-2	10 X 27	4B	6D	1/2	1	24
	12 X 36	4C	10D	3/4	1 1/2	33
D10-3	10 X 36	4B	6D	1/2	1	33
	12 X 48	4C	10D	3/4	1 1/2	44

COLORS

LEGEND - WHITE (REFL.)
BACKGROUND - GREEN (REFL.)

D10-101, 201, 301

4/06

DOUBLE FACED SIGNS

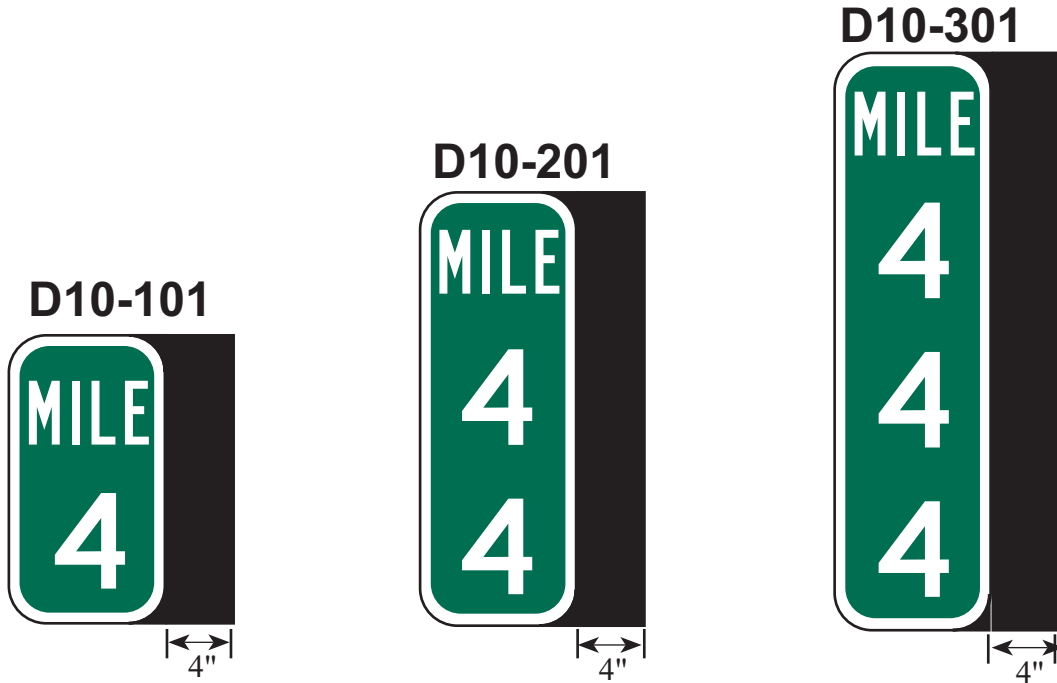

SIGN	DIMENSIONS (MILLIMETERS)					
	SIGN SIZE	LETTER SIZE AND SERIES	NUM. SIZE AND SERIES	BORDER WIDTH	CORNER RADIUS	HOLE CTRS.
D10-101	350 X 450	100B	150D	13	25	375
D10-201	350 X 675	100B	150D	13	25	600
D10-301	350 X 900	100B	150D	13	25	825

SIGN	DIMENSIONS (INCHES)					
	SIGN SIZE	LETTER SIZE AND SERIES	NUM. SIZE AND SERIES	BORDER WIDTH	CORNER RADIUS	HOLE CTRS.
D10-101	14 X 18	4B	6D	1/2	1	15
D10-201	14 X 27	4B	6D	1/2	1	24
D10-301	14 X 36	4B	6D	1/2	1	33

COLORS

LEGEND - WHITE (REFL.)
BACKGROUND - GREEN (REFL.)

D10-401 & D10-501

10/97

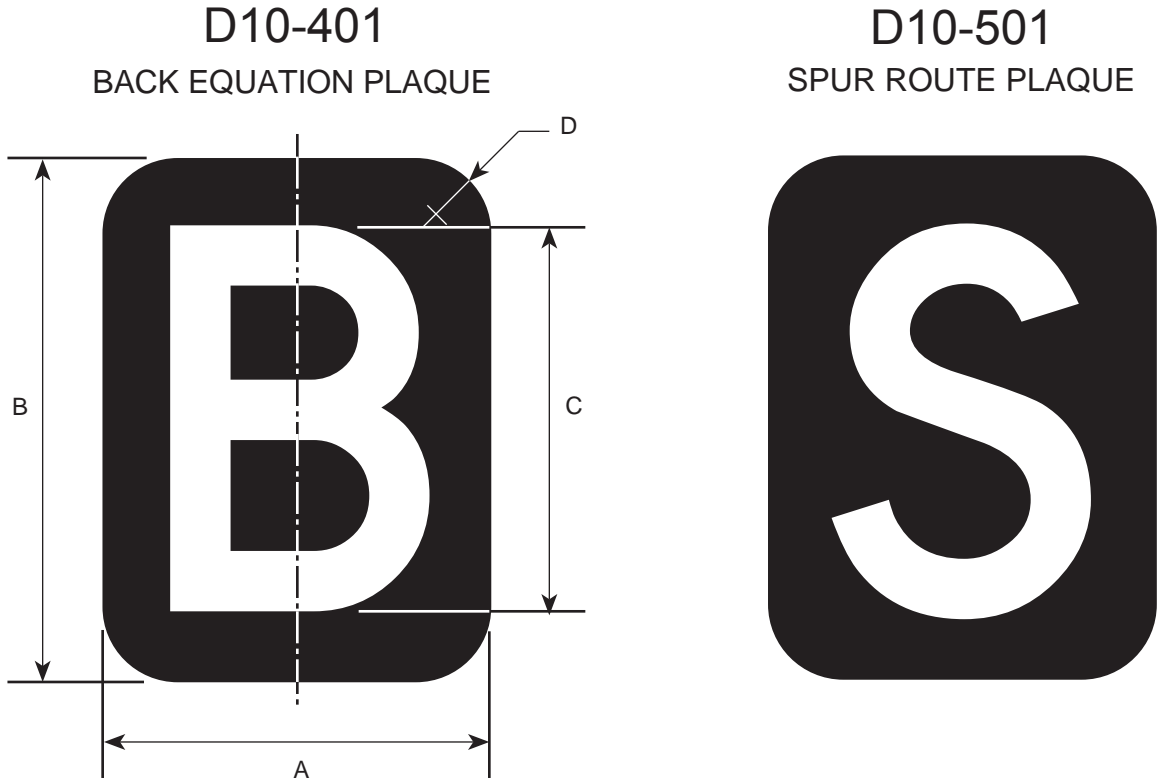

DIMENSIONS (MILLIMETERS)				
A	B	C	D	HOLE CTRS.
150	200	150D	25	175

DIMENSIONS (INCHES)				
A	B	C	D	HOLE CTRS.
6	8	6D	1	7

COLORS

LEGEND - WHITE (REFL.)
BACKGROUND - GREEN (REFL.)

D11-1

10/97



* SEE APPENDIX FOR SYMBOL DESIGN

DIMENSIONS (MILLIMETERS)									
A	B	C	D	E	F	G	H	J	K
600	450	13	38	175	88	75C	138	238	38
750	600	16	47	219	109	100C	172	313	38

DIMENSIONS (INCHES)									
A	B	C	D	E	F	G	H	J	K
24	18	1/2	1 1/2	7	3 1/2	3C	5 1/2	9 1/2	1 1/2
30	24	5/8	1 7/8	8 3/4	4 3/8	4C	6 7/8	12 1/2	1 1/2

COLORS

LEGEND - WHITE (REFL.)
BACKGROUND - GREEN

D12-201

10/97



NOTE: TELEPHONE NUMBER AS NOTED ON THE PLANS.

DIMENSIONS (MILLIMETERS)						
A	B	C	D	E	F	HOLE CTRS.
1200	750	19	100E	106	56	600
1500	1200	25	150E	150	75	750
1800	1350	38	200E	175	100	1050

DIMENSIONS (INCHES)						
A	B	C	D	E	F	HOLE CTRS.
48	30	3/4	4E	4 1/4	2 1/4	24
60	48	1	6E	6	3	30
72	54	1 1/2	8E	7	4	42

COLORS

LEGEND - WHITE (REFL.)
BACKGROUND - BLUE (REFL.)

D12-202

10/97

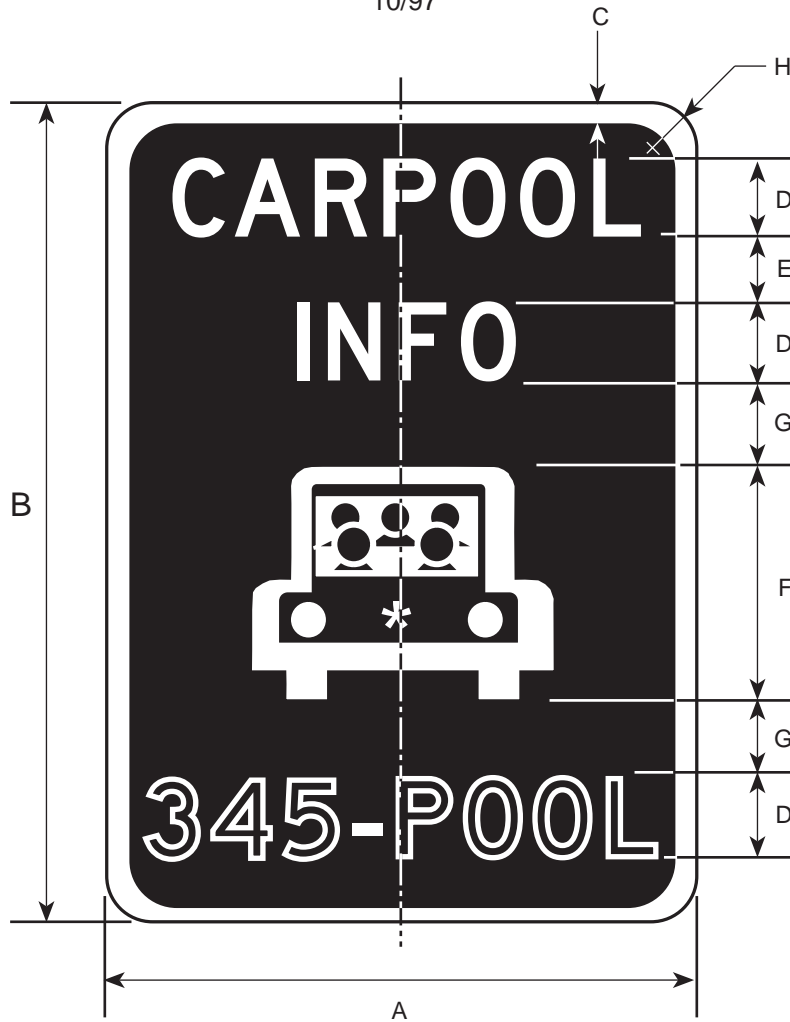

* SEE APPENDIX FOR SYMBOL DESIGN

NOTE: TELEPHONE NUMBER AS NOTED ON THE PLANS.

DIMENSIONS (MILLIMETERS)								
A	B	C	D	E	F	G	H	HOLE CTRS.
750	1200	19	100D	75	300	100	11	750

DIMENSIONS (INCHES)								
A	B	C	D	E	F	G	H	HOLE CTRS.
30	48	3/4	4D	3	12	4	4 1/2	30

COLORS

LEGEND - WHITE (REFL.)
 BACKGROUND - BLUE (REFL.)

D13-1

1/06



1 1/16" x 36" 1/2" x 0.45" PIANO
HINGE COVERED TO MATCH SIGN

DIMENSIONS (MILLIMETERS)						
A	B	C	D	E	F	G
900	750	9	125	200C	100	38

DIMENSIONS (INCHES)						
A	B	C	D	E	F	G
36	30	3/8	5	8C	4	1 1/2

COLORS

LEGEND - WHITE (REFL.)
BACKGROUND - BLUE (REFL.)

D13-2

1/06

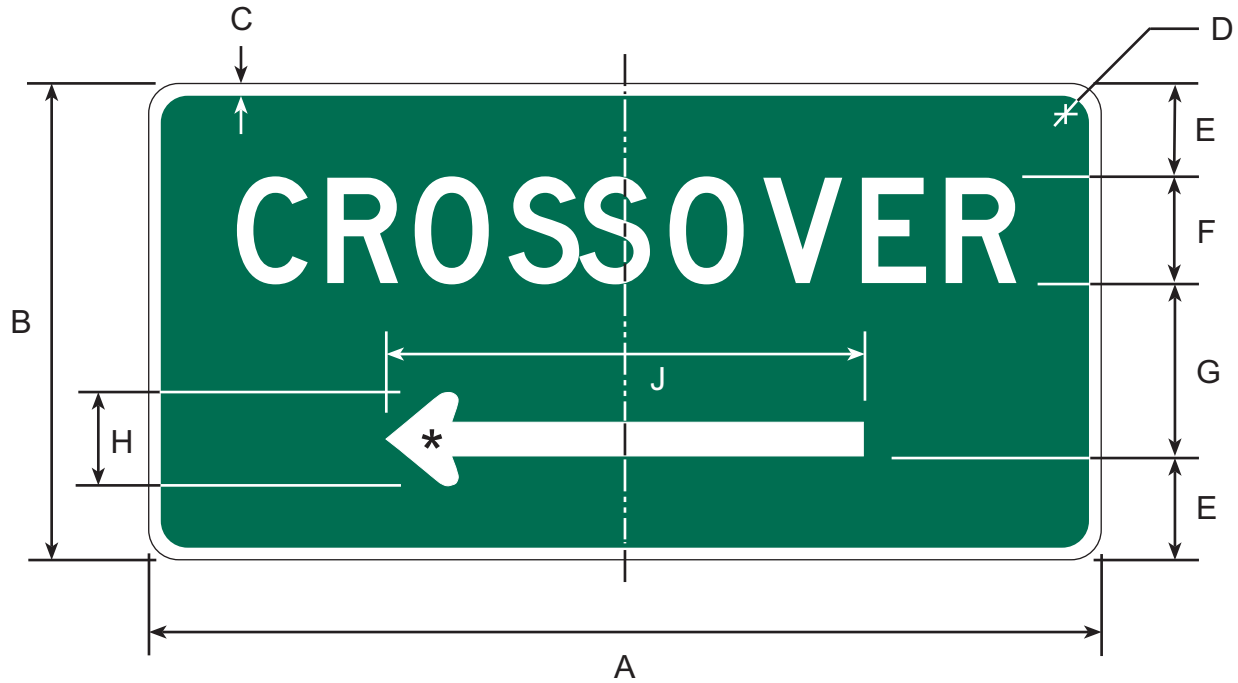

* SEE APPENDIX FOR ARROW DETAILS

DIMENSIONS (MILLIMETERS)								
A	B	C	D	E	F	G	H	J
1500	750	19	47	150	150D	300	150	750
1800	900	25	50	175	200D	350	200	900

DIMENSIONS (INCHES)								
A	B	C	D	E	F	G	H	J
60	30	3/4	1 7/8	6	6D	12	6	30
72	36	1	2	7	8D	14	8	36

COLORS

LEGEND - WHITE (REFL)
BACKGROUND - GREEN (REFL)

D13-3

12/05

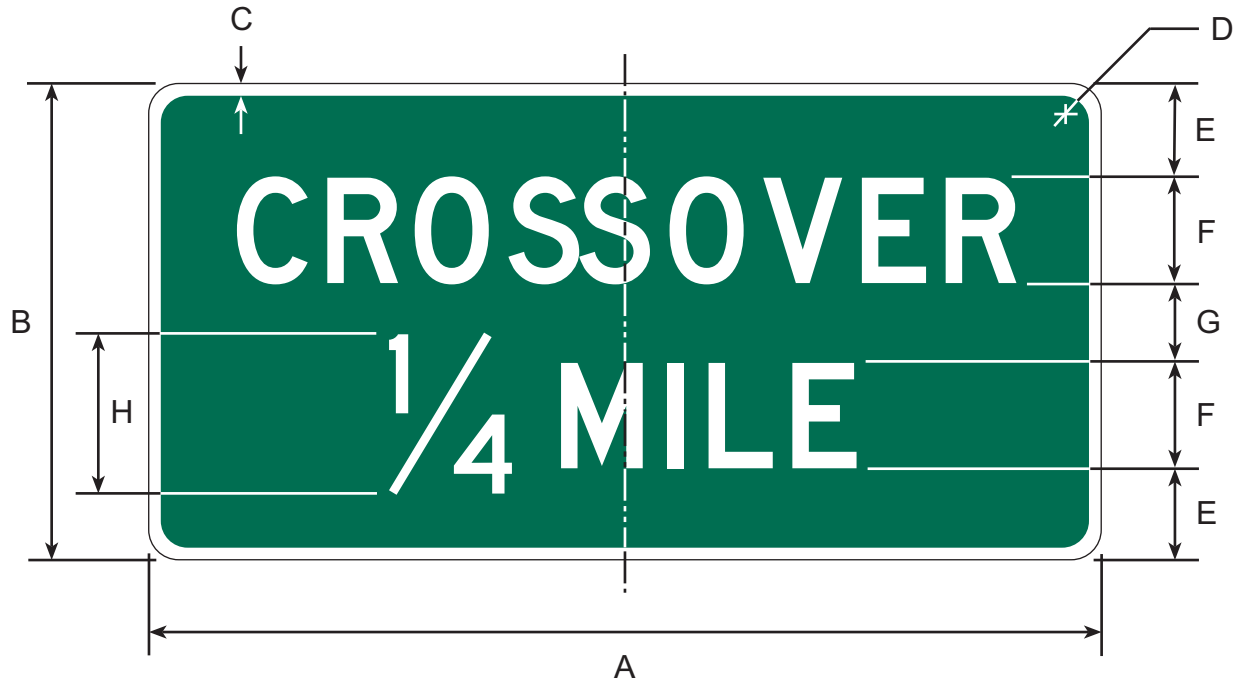

DIMENSIONS (MILLIMETERS)							
A	B	C	D	E	F	G	H
1500	750	19	47	150	150D	150	225
1800	900	25	50	175	200D	150	300

DIMENSIONS (INCHES)							
A	B	C	D	E	F	G	H
60	30	3/4	1 7/8	6	6D	6	9
72	36	1	2	7	8D	6	12

COLORS

LEGEND - WHITE (REFL)
 BACKGROUND - GREEN (REFL)

E1-1

1/06

ADVANCE GUIDE SIGNS



SIZE CODE	DIMENSIONS (MILLIMETERS)									
	EXIT PANEL			ROUTE MARKER	CARDINAL DIRECTION	PLACE NAME	ACTION MESSAGE			BORDER WIDTH
	WORD	NUM.	LETTER				NUM.	FRACT.	WORD	
B	200E	300E	300E	600	250E/200E	265/200	250E	200E	200E	38
C	250E	375E	375E	900	300E/250E	332/250	300E	250E	250E	50
D	300E	450E	450E	900	375E/300E	400/300	375E	300E	300E	50
E	300E	450E	450E	900	375E/300E	400/300	375E	300E	300E	50

SIZE CODE	DIMENSIONS (INCHES)									
	EXIT PANEL			ROUTE MARKER	CARDINAL DIRECTION	PLACE NAME	ACTION MESSAGE			BORDER WIDTH
	WORD	NUM.	LETTER				NUM.	FRACT.	WORD	
B	8E	12E	12E	24	10E/8E	10.6/8	10E	8E	8E	1 1/2
C	10E	15E	15E	36	12E/10E	13.3/10	12E	10E	10E	2
D	10E	15E	15E	36	15E/12E	16/12	15E	12E	12E	2
E	12E	18E	18E	36	15E/12E	16/12	15E	12E	12E	2

COLORS

LEGEND — WHITE (REFL)
BACKGROUND — GREEN (REFL)

E1-4

8/03

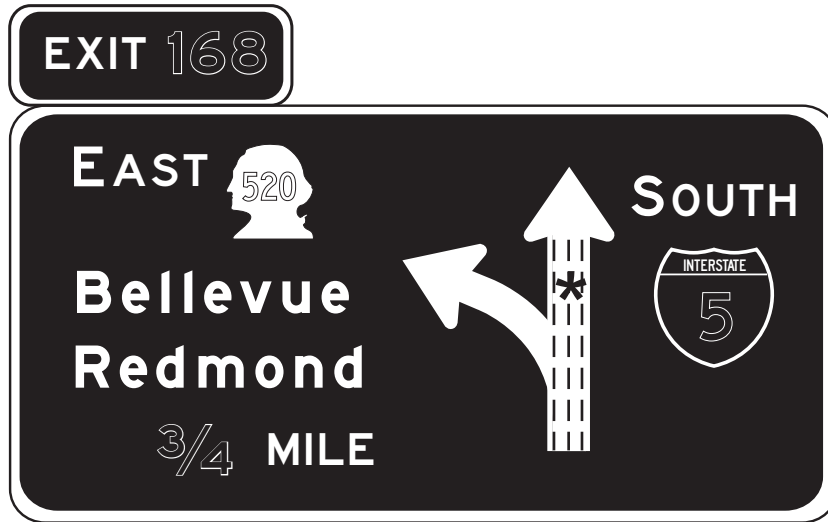

NOTE: SEE APPENDIX FOR TYPICAL ARROW DETAILS. SEE PLANS FOR SPECIFIC ARROW DETAILS.

* LANE STRIPE BLACK

SIZE CODE	DIMENSIONS (MILLIMETERS)				
	ROUTE MARKER	CARD. DIR.	PLACE NAME	ARROW DIMEN.	BORDER WIDTH
B	600	250E/200E	265/200	SEE PLANS	37.5
C	900	300E/250E	332/250		50
D	900	375E/300E	400/300		50

SIZE CODE	DIMENSIONS (INCHES)				
	ROUTE MARKER	CARDINAL DIRECTION	PLACE NAME	ARROW DIMEN.	BORDER WIDTH
B	24	10E/8E	10.6/8	SEE PLANS	1 1/2
C	36	12E/10E	13.3/10		2
D	36	15E/12E	16/12		2

GRAPHIC COMPONENT

Lane Width
 Lane Lines
 Space between Lane Lines
 Arrowheads
 Stem Height (to upper point of departure-minimum)
 Space between arrowheads and route shield and
 between route shield and cardinal direction

SIZE

5' (125 mm)
 1" x 6" (25 x 150 mm)
 6" (150 mm)
 Standard "up" Arrow
 30" (750 mm)
 12" (300 mm)

COLORS

LEGEND - WHITE (REFL)
 BACKGROUND - GREEN (REFL)

E1-5

11/97



NOTE: WHITE ON BROWN MAY BE SPECIFIED ON THE PLANS FOR RECREATION SIGNING. SIZE CODE SHOULD BE USED FOR OVERHEAD INSTALLATIONS.

SIZE CODE	DIMENSIONS (MILLIMETERS)					
	A	B	C	D	E	F
B	VA	450	38	300E	200E	VAR
D	VA	600	50	375E	250E	VAR
E	VA	750	50	400E	300E	VAR

SIZE CODE	DIMENSIONS (INCHES)					
	A	B	C	D	E	F
B	VAR	18	1 1/2	12E	8E	VAR
D	VAR	24	2	15E	10E	VAR
E	VAR	30	2	18E	12E	VAR

COLORS

LEGEND - WHITE (REFL)
BACKGROUND - GREEN (REFL)

E2-1

11/97

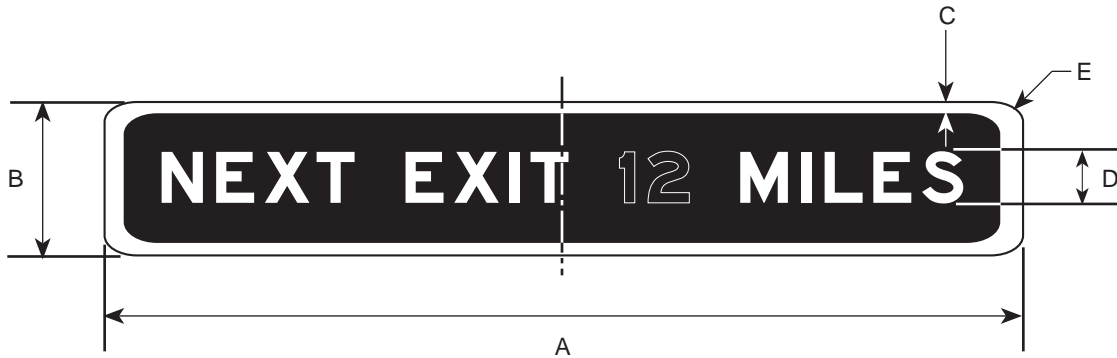

NOTE: WHITE ON BROWN MAY BE SPECIFIED ON THE PLANS FOR RECREATION SIGNING. SIZE CODE "E" SHOULD BE USED FOR OVERHEAD INSTALLATION.

SIZE CODE	DIMENSIONS (MILLIMETERS)				
	A	B	C	D	E
A	3600	600	38	200E	100
B	4500	750	50	250E	150

SIZE CODE	DIMENSIONS (INCHES)				
	A	B	C	D	E
A	144	24	1 1/2	8E	4
B	180	30	2	10E	6

COLORS

LEGEND - WHITE (REFL)
BACKGROUND - GREEN (REFL)

E2-1A

11/97



NOTE: WHITE ON BROWN MAY BE SPECIFIED ON THE PLANS FOR RECREATION SIGNING. SIZE CODE "E" SHOULD BE USED FOR OVERHEAD INSTALLATION.

SIZE CODE	DIMENSIONS (MILLIMETERS)					
	A	B	C	D	E	F
A	2100	900	38	200E	138	100
B	2700	1200	50	250E	200	150

SIZE CODE	DIMENSIONS (INCHES)					
	A	B	C	D	E	F
A	84	36	1 1/2	8E	5 1/2	4
B	108	48	2	10E	8	6

COLORS

LEGEND — WHITE (REFL)
BACKGROUND — GREEN (REFL)

E3-101

1/06



OPTIONAL

SIZE CODE	DIMENSIONS (MILLIMETERS)		
	PLACE NAME	ACTION MESS.	BORDER WIDTH
B	265/200	200E	38
C	325/250	250	50

SIZE CODE	DIMENSIONS (INCHES)		
	PLACE NAME	ACTION MESS.	BORDER WIDTH
B	10.6/8	8E	1 1/2
C	13/10	10E	2

COLORS

LEGEND — WHITE (REFL)
BACKGROUND — GREEN (REFL)

E4-301

4/03



SIZE CODE	DIMENSIONS (MILLIMETERS)							
	WORD	EXIT NUM.	LETTER	ROUTE MARKER	CARDINAL DIRECTION	PLACE NAME	ACTION MESS.	BORDER WIDTH
B	200E	300E	300E	600	250E/200E	265/200	200E	38
C	250E	375E	375E	900	300E/250E	332/250	250E	50
D	250E	375E	375E	900	375E/300E	400/300	300E	50
E	300E	450E	450E	900	375E/300E	400/300	300E	50

SIZE CODE	DIMENSIONS (INCHES)							
	WORD	EXIT NUM.	LETTER	ROUTE MARKER	CARDINAL DIRECTION	PLACE NAME	ACTION MESS.	BORDER WIDTH
B	8E	12E	12E	24	10E/8E	10.6/8	8E	1 1/2
C	10E	15E	15E	36	12E/10E	13.3/10	10E	2
D	10E	15E	15E	36	15E/12E	16/12	12E	2
E	12E	18E	18E	36	15E/12E	16/12	12E	2

COLORS

LEGEND — WHITE (REFL)
BACKGROUND — GREEN (REFL)

E4-501

1/06



THE EXIT ONLY PORTION SHALL BE NON-REFLECTIVE BLACK MESSAGE ON A REFLECTIVE YELLOW BACKGROUND. THE BORDER SHALL BE BLACK FOR THE YELLOW REFLECTIVE BACKGROUND PORTION OF THE SIGN AND WHITE FOR THE GREEN REFLECTIVE BACKGROUND PORTION OF THE SIGN. THE WHITE AND BLACK BORDER SHALL MATCH EVENLY.

SEE E11-I FOR PANEL DETAILS WHEN REVISING EXISTING GUIDE SIGN INSTALLATIONS.

* WHEN USED

** SEE APPENDIX FOR STANDARD ARROW DETAILS

SIZE CODE	DIMENSIONS (MILLIMETERS)								
	* EXIT PANEL			ROUTE MARKER	CARDINAL DIRECTION	PLACE NAME	ARROW SIZE	"EXIT ONLY"	BORDER WIDTH
	WORD	NUM.	LETTER						
B	250E	375E	375E	600	250E/200E	265/200	NO.7	200E	38
C	300E	450E	450E	900	300E/250E	332/250	NO.8	250E	50
E	300E	450E	450E	900	375E/300E	400/300	NO.8	300E	50

SIZE CODE	DIMENSIONS (INCHES)								
	* EXIT PANEL			ROUTE MARKER	CARDINAL DIRECTION	PLACE NAME	ARROW SIZE	"EXIT ONLY"	BORDER WIDTH
	WORD	NUM.	LETTER						
B	10E	15E	15E	24	10E/8E	10.6/8	NO.7	8E	1 1/2
C	12E	18E	18E	36	12E/10E	13.3/10	NO.8	10E	2
E	12E	18E	18E	36	15E/12E	16/12	NO.8	12E	2

COLORS

LEGEND — WHITE (REFL)
BACKGROUND — GREEN (REFL)

E5-1

10/03

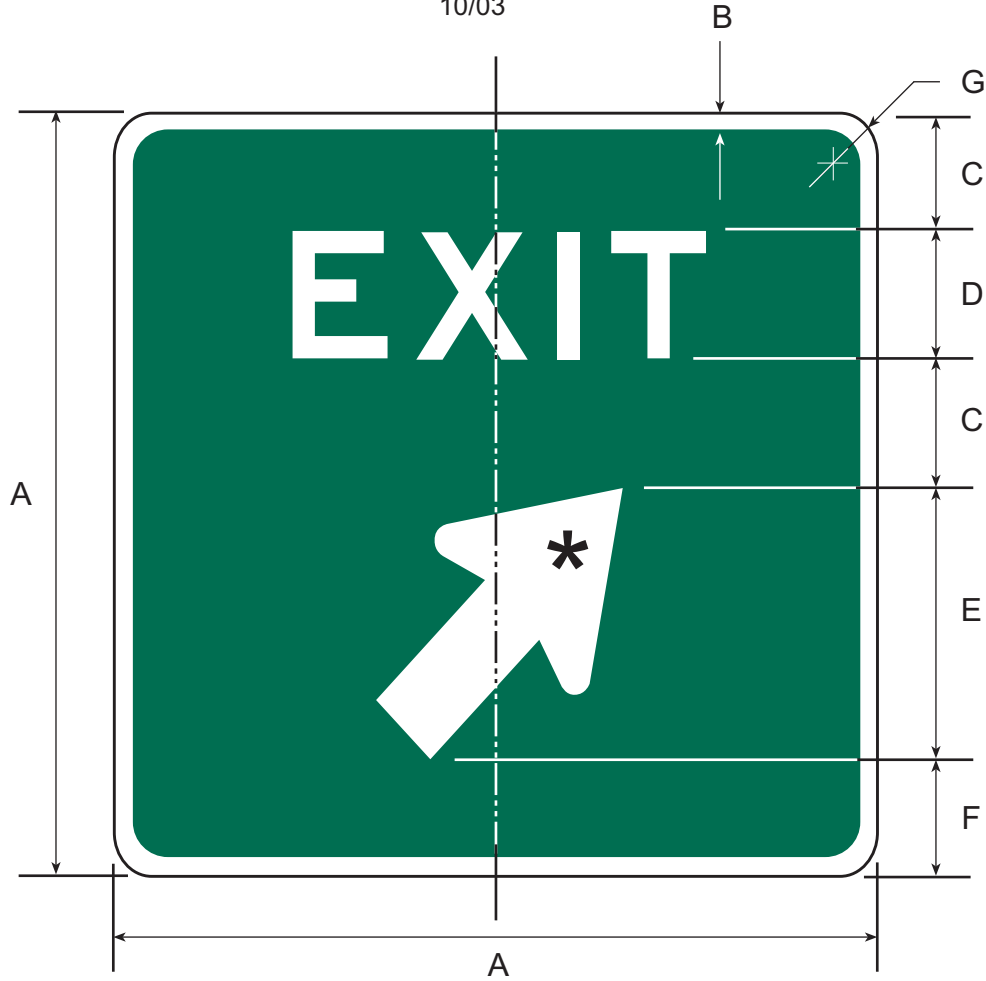

* SEE APPENDIX FOR STANDARD ARROW DETAILS

SIGN	DIMENSIONS (MILLIMETERS)							
	A	B	C	D	ARROW SIZE	E	F	G
A	1200	38	200	250E	NO.3	409	141	100
B	1500	50	250	300E	NO.4	591	109	150

SIGN	DIMENSIONS (INCHES)							
	A	B	C	D	ARROW SIZE	E	F	G
A	48	1 1/2	8	10E	NO.3	16 3/8	5 5/8	4
B	60	2	10	12E	NO.4	23 5/8	4 3/8	6

COLORS

LEGEND— WHITE (REFL)
BACKGROUND— GREEN (REFL)

E5-1A

1/06



* SEE APPENDIX FOR STANDARD ARROW DETAILS

SIGN	DIMENSIONS (MILLIMETERS)										
	A	B	C	D	E	F	G	ARROW SIZE	H	J	K
A	1200	38	200	250E	300E	250	369	NO.2	200	150	100
B	VAR	50	250	250E	375E	325	506	NO.5	250	188	150

SIGN	DIMENSIONS (INCHES)										
	A	B	C	D	E	F	G	ARROW SIZE	H	J	K
A	48	1 1/2	8	10E	12E	10	14 3/4	NO.2	8	6	4
B	VAR	2	10	12E	15E	13	20 1/4	NO.5	10	7 1/2	6

COLORS

LEGEND— WHITE (REFL)
BACKGROUND— GREEN (REFL)

E5-2

6/03

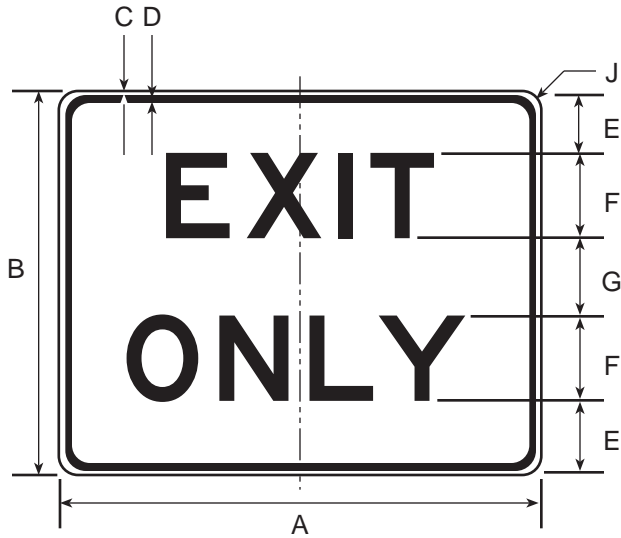

E5-2A

6/03



E5-2B

6/03



DIMENSIONS (MILLIMETERS)								
A	B	C	D	E	F	G	H	J
1200	900	19	31	150	200E	175	200D	75

DIMENSIONS (INCHES)								
A	B	C	D	E	F	G	H	J
48	36	3/4	1 1/4	6	8E	7	8D	3

COLORS
 LEGEND - BLACK
 BACKGROUND - ORANGE (REFL)

E5-3

1/06

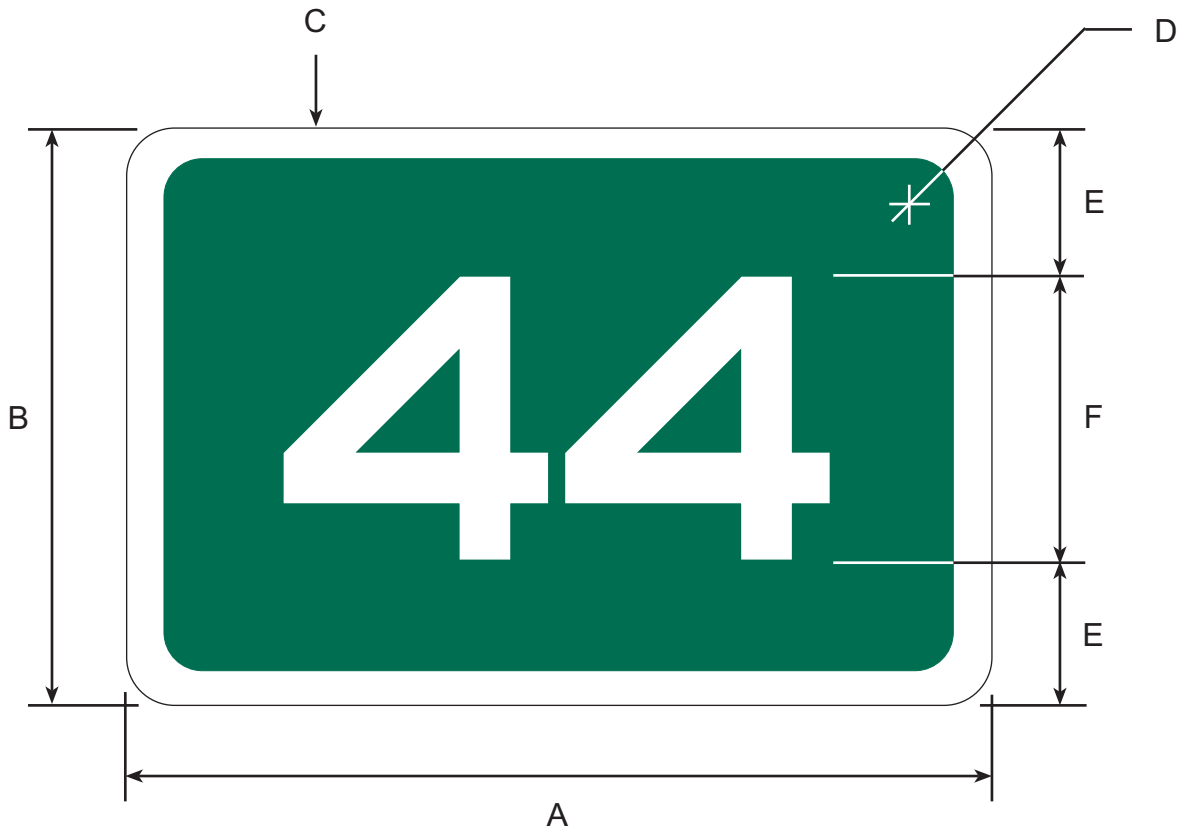

DIMENSIONS (MILLIMETERS)					
A	B	C	D	E	F
VAR	600	38	75	150	300E
VAR	600	38	75	113	375E

DIMENSIONS (INCHES)					
A	B	C	D	E	F
VAR	24	1 1/2	3	6	12E
VAR	24	1 1/2	3	4 1/2	15E

COLORS

LEGEND - WHITE (REFL)
 BACKGROUND - GREEN (REFL)

E5-4

1/06

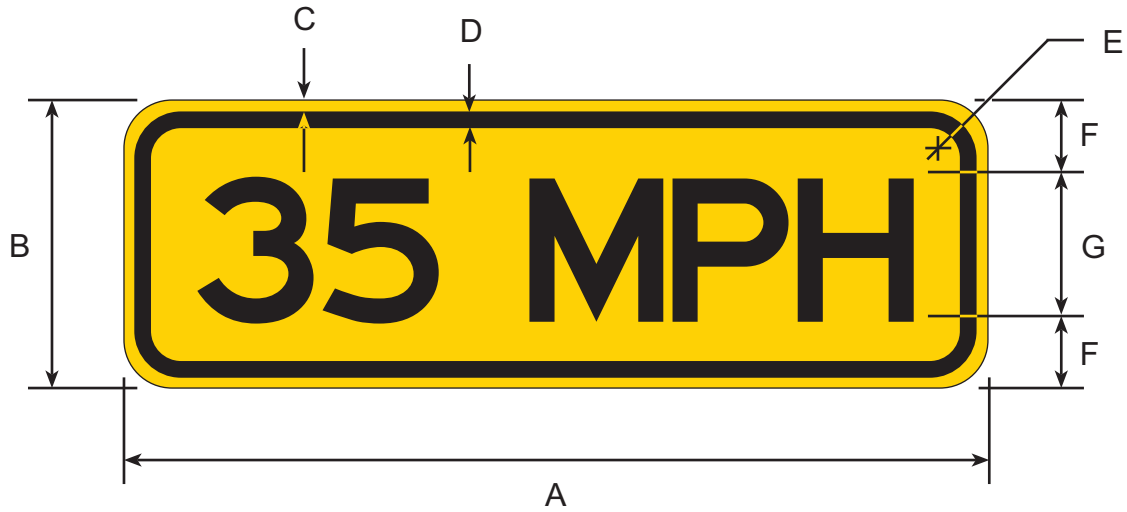

DIMENSIONS (MILLIMETERS)						
A	B	C	D	E	F	G
1800	600	25	31	75	150	300E

DIMENSIONS (INCHES)						
A	B	C	D	E	F	G
72	24	1	1 1/4	3	6	12E

COLORS

LEGEND - BLACK (NON-REFL)
 BACKGROUND - YELLOW (REFL)

E6-101

1/06



* SEE APPENDIX FOR STANDARD ARROW DETAILS

SIZE CODE	DIMENSIONS (MILLIMETERS)										
	EXIT PANEL			ROUTE MARKER	CARDINAL DIRECTION	PLACE NAME	ACTION MESSAGE			BORDER WIDTH	ARROW SIZE
	WORD	NUM	LETTER				NUM.	FRACT.	WORD		
B	200E	300E	300E	600	250E/200E	265/200	200E	250E	200E	37.5	3 OR 4
C	250E	375E	375E	900	300E/250E	332/250	300E	250E	250E	50	3 OR 4
D	250E	375E	375E	900	300E/250E	400/300	375E	300E	300E	50	5 OR 6
E	300E	450E	450E	900	375E/300E	400/300	375E	300E	300E	50	5 OR 6

SIZE CODE	DIMENSIONS (INCHES)										
	EXIT PANEL			ROUTE MARKER	CARDINAL DIRECTION	PLACE NAME	ACTION MESSAGE			BORDER WIDTH	ARROW SIZE
	WORD	NUM	LETTER				NUM.	FRACT.	WORD		
B	8E	12E	12E	24	10E/8E	10.6/8	10 E	8 E	8 E	1 1/2	3 OR 4
C	10E	15E	15E	36	12E/10E	13.3/10	12 E	10 E	10 E	2	3 OR 4
D	10E	15E	15E	36	15E/12E	16/12	15 E	12 E	12 E	2	5 OR 6
E	12E	18E	18E	36	15E/12E	16/12	15 E	12 E	12 E	2	5 OR 6

COLORS

LEGEND— WHITE (REFL)
BACKGROUND— GREEN (REFL)

E6-2

1/06



*** SEE APPENDIX FOR STANDARD ARROW DETAILS WITH OR WITHOUT DOWN ARROW

SIZE CODE	DIMENSIONS (MILLIMETERS)				
	ROUTE MARKER	CARDINAL DIRECTION	PLACE NAME	ARROW DIMEN.	BORDER WIDTH
B	600	250E/200E	265/200	NO. 7	38
C	900	300E/250E	332/250	NO. 8	50
D	900	375E/300E	400/300	NO. 8	50

SIZE CODE	DIMENSIONS (INCHES)				
	ROUTE MARKER	CARDINAL DIRECTION	PLACE NAME	ARROW DIMEN.	BORDER WIDTH
B	24	10E/8E	10.6/8	NO. 7	1 1/2
C	36	12E/10E	13.3/10	NO. 8	2
D	36	15E/12E	16/12	NO. 8	2

COLORS

LEGEND — WHITE (REFL)
BACKGROUND — GREEN (REFL)

E7-1

1/06



NOTE: USE 18" SHIELD WITH SIZE CODE A & B. USE 24" SHIELD WITH SIZE C. ADD 6" TO VERTICAL DIMENSION FOR EACH SHIELD USED.

SIZE CODE	DIMENSIONS (MILLIMETERS)								
	LETTER SIZE		VERT. DIMENSION			BORDER WIDTH	CORNER RADIUS		
	PLACE	NUM.	1 LINE	2 LINE	3 LINE		1 LINE	2 LINE	3 LINE
A	200/150	200	600	900	1200	38	75	150	150
B	265/200	265	750	1200	1650	38	75	150	225
C	332/250	332	900	1500	2100	50	150	225	300

SIZE CODE	DIMENSIONS (INCHES)								
	LETTER SIZE		VERT. DIMENSION			BORDER WIDTH	CORNER RADIUS		
	PLACE	NUM.	1 LINE	2 LINE	3 LINE		1 LINE	2 LINE	3 LINE
A	8/6	8	24	36	48	1 1/2	3	6	6
B	10.6/8	10.6	30	48	66	1 1/2	3	6	9
C	13.3/10	13.3	36	60	84	2	6	9	12

COLORS

LEGEND — WHITE (REFL)
BACKGROUND — GREEN (REFL)

E8-1

1/06



NOTE: SIZE CODE B IS INTENDED FOR USE ON EXPRESSWAYS

SIZE CODE	DIMENSIONS (MILLIMETERS)							
	LETTER SIZE			VERT. DIMENSION		BORDER WIDTH	CORNER RADIUS	
	PLACE	NUM.	FRACT	2 LINE	3 LINE		2 LINE	3 LINE
B	265/200	265	200	1200	1650	38	150	225
C	332/250	332	250	1500	2100	50	225	300

SIZE CODE	DIMENSIONS (INCHES)							
	LETTER SIZE			VERT. DIMENSION		BORDER WIDTH	CORNER RADIUS	
	PLACE	NUM.	FRACT	2 LINE	3 LINE		2 LINE	3 LINE
B	10.6/8	10.6	8	48	66	1 1/2	6	9
C	13.3/10	13.3	10	60	84	2	9	12

COLORS

LEGEND — WHITE (REFL)
BACKGROUND — GREEN (REFL)

E8-2

1/06

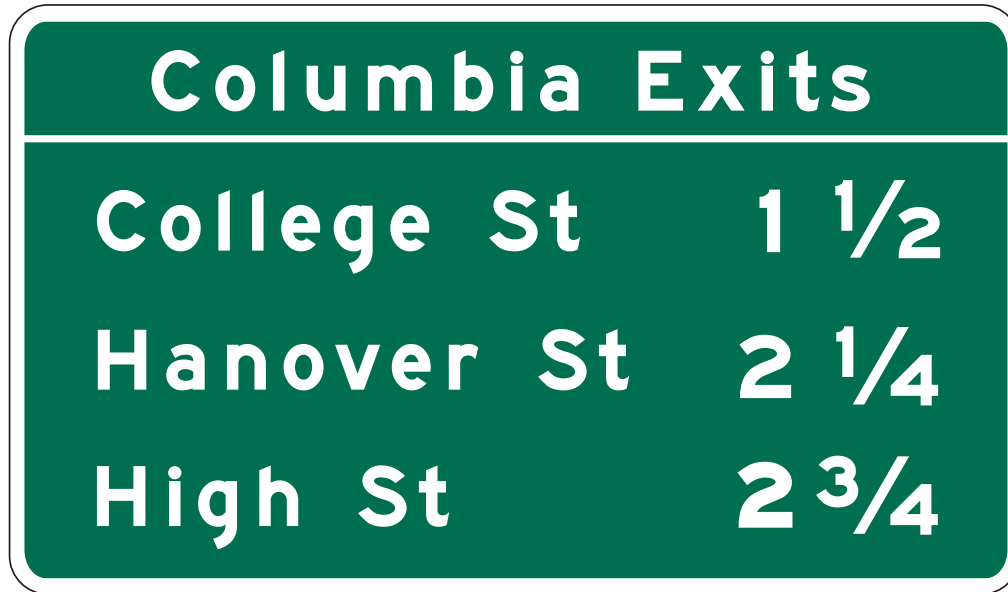

SIZE CODE B IS INTENDED FOR USE ON EXPRESSWAYS

SIZE CODE	DIMENSIONS (MILLIMETERS)							
	LETTER SIZE			VERT. DIMENSION		BORDER WIDTH	CORNER RADIUS	
	PLACE	NUM.	FRACT	3 LINE	4 LINE		2 LINE	3 LINE
B	265/200	265	200	1650	2100	38	150	300
C	332/250	332	250	2100	2700	50	225	300

SIZE CODE	DIMENSIONS (INCHES)							
	LETTER SIZE			VERT. DIMENSION		BORDER WIDTH	CORNER RADIUS	
	PLACE	NUM.	FRACT	3 LINE	4 LINE		3 LINE	4 LINE
B	10.6/8	10.6	8	66	84	1 1/2	6	12
C	13.3/10	13.3	10	84	108	2	9	12

COLORS

LEGEND — WHITE (REFL)
BACKGROUND — GREEN (REFL)

E9-1

1/06



SIZE CODE	DIMENSIONS (MILLIMETERS)							
	A	B	C	D	E	F	G	H
B	VA	1200	38	265	200	200E	237	150
C	VA	1500	50	332	250	250E	300	225

SIZE CODE	DIMENSIONS (INCHES)							
	A	B	C	D	E	F	G	H
B	VA	48	1 1/2	10.6	8	8E	9 1/2	6
C	VA	60	2	13.3	10	10E	12	9

COLORS

LEGEND — WHITE (REFL)
 BACKGROUND — GREEN (REFL)

E11-1

1/06

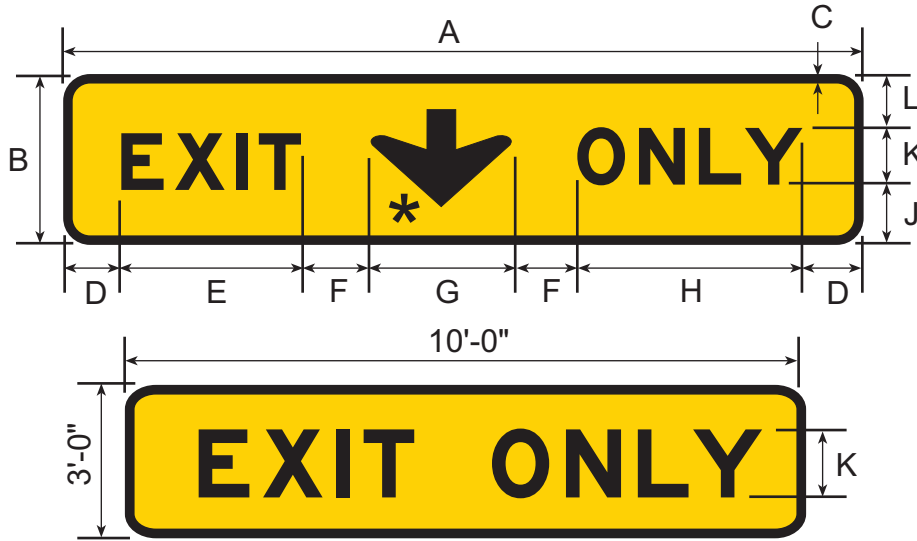

E11-1A

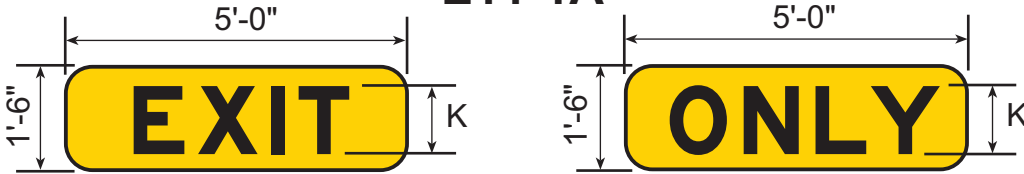

E11-1B

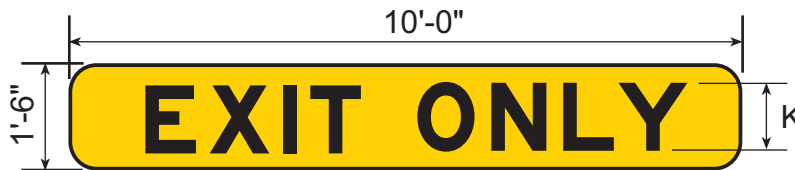

* SEE APPENDIX FOR STANDARD ARROW DETAILS

SIZE CODE	DIMENSIONS (MILLIMETERS)											ARROW NO.
	A	B	C	D	E	F	G	H	J	K	L	
VAR	4200	900	50	300	975	300	800	1225	350	300E	250	8

SIZE CODE	DIMENSIONS (INCHES)											ARROW NO.
	A	B	C	D	E	F	G	H	J	K	L	
VAR	168	36	2	12	39	12	32	49	14	12E	10	8

COLORS

LEGEND — BLACK (NON-REFL)
BACKGROUND — YELLOW (REFL)

E12-101

11/97



E12-201



NOTE: DIMENSIONS TYPICAL BOTH SIGNS

SIGN	DIMENSIONS (MILLIMETERS)					
	A	B	C	D	E	F
STD.	900	600	13	150C	88	56

SIGN	DIMENSIONS (INCHES)					
	A	B	C	D	E	F
STD.	36	24	1/2	6C	3 1/2	2 1/4

COLORS

LEGEND — WHITE (REFL)
BACKGROUND — GREEN (REFL.)

E13-1

11/97

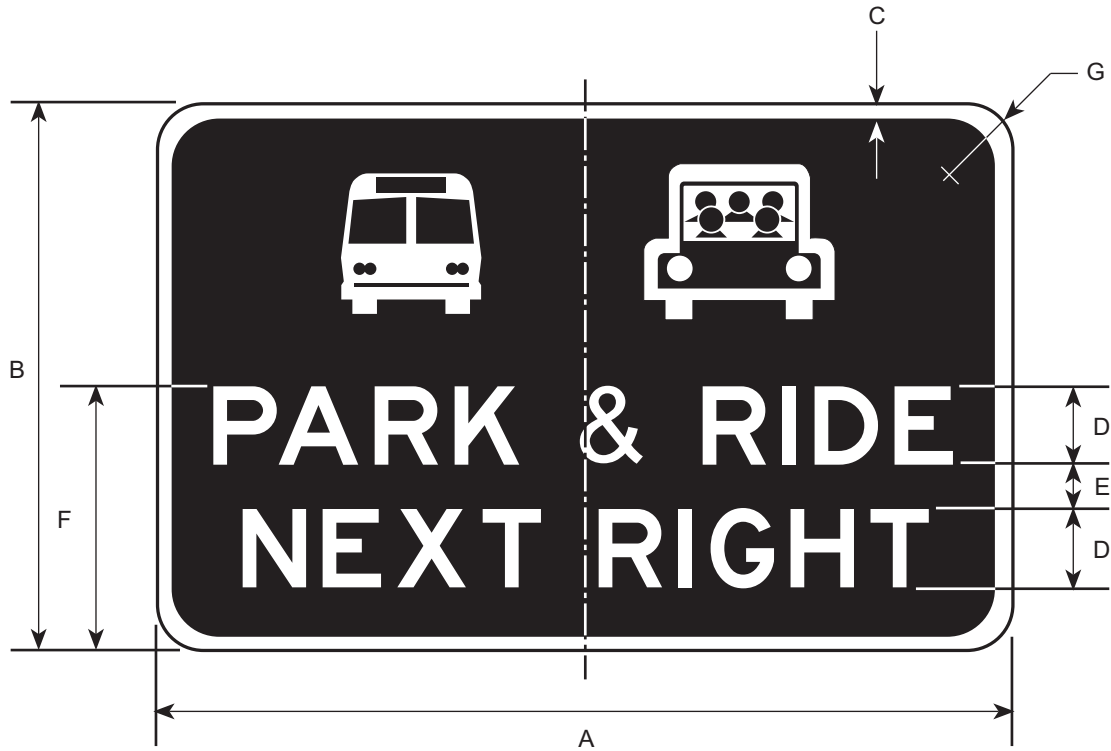

SIGN	DIMENSIONS (MILLIMETERS)						
	A	B	C	D	E	F	G
STD.	2100	1200	31	200E	138	700	75

SIGN	DIMENSIONS (INCHES)						
	A	B	C	D	E	F	G
STD.	84	48	1 1/4	8E	5 1/2	28	3

SEE PLANS FOR REQUIRED BUS AND CARPOOL SYMBOLS

BUS AND CARPOOL SIGNS ARE OPTIONAL. IF USED INDEPENDENTLY, SYMBOL WILL BE PLACED ON THE UPPER LEFT OF SIGN.

COLORS

LEGEND — WHITE (REFL)
BACKGROUND — GREEN (REFL.)

E13-2

1/06

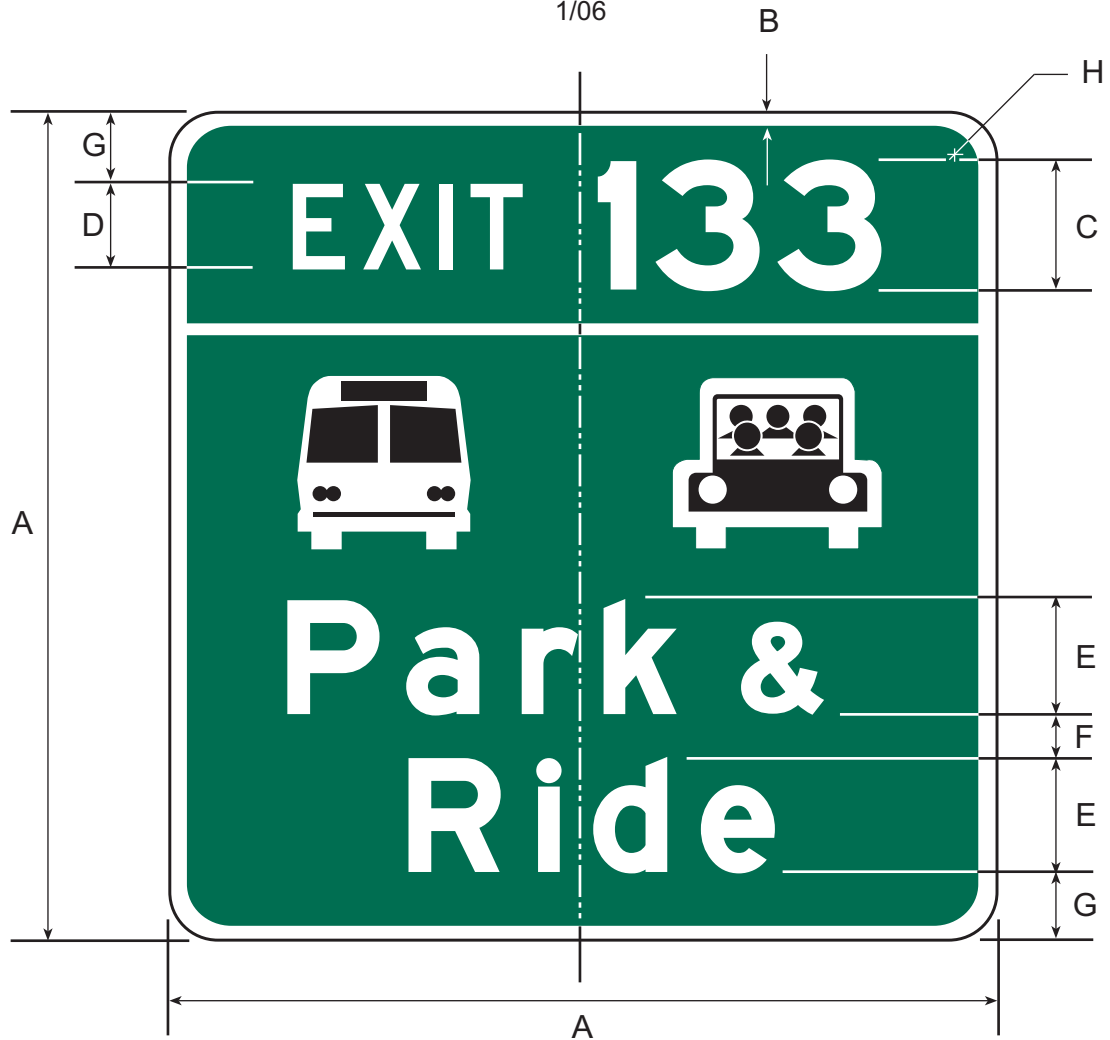

DIMENSIONS (MILLIMETERS)							
A	B	C	D	E	F	G	H
2400	38	375E	250E	333/250E(M)	200	250	100

DIMENSIONS (INCHES)							
A	B	C	D	E	F	G	H
96	1 1/2	15E	10E	13.3/10E(M)	8	10	4

SEE PLANS FOR REQUIRED BUS AND CARPOOL SYMBOLS
 BUS AND CARPOOL SIGNS ARE OPTIONAL. IF USED INDEPENDENTLY,
 PLACE SYMBOL ON THE UPPER LEFT OF SIGN.

COLORS

LEGEND— WHITE (REFL)
 BACKGROUND— GREEN (REFL)

G20-1

11/97

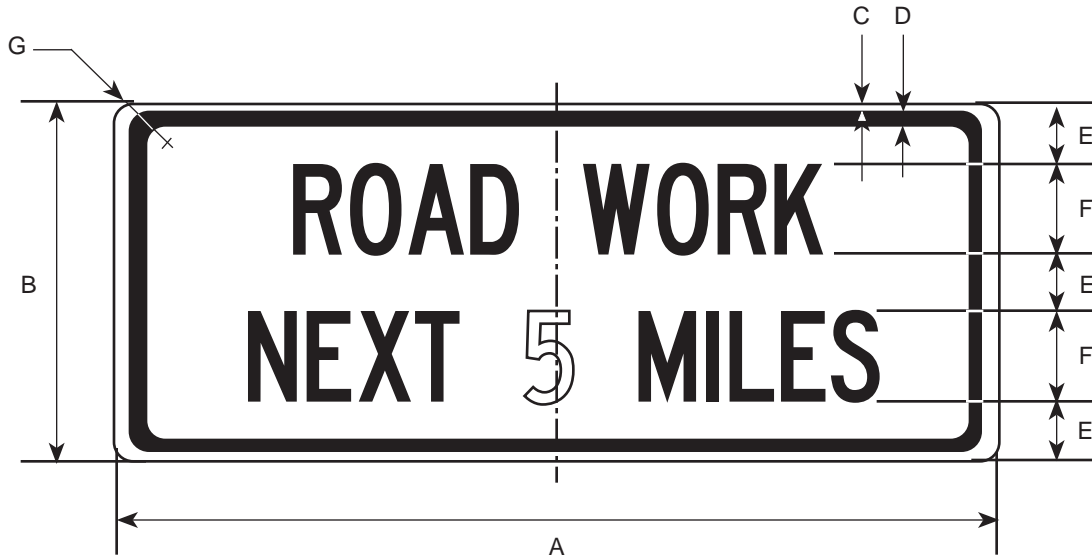

DIMENSIONS (MILLIMETERS)						
A	B	C	D	E	F	G
1500	600	16	22	100	150C	75

DIMENSIONS (INCHES)						
A	B	C	D	E	F	G
60	24	5/8	7/8	4	6C	3

COLORS

LEGEND - BLACK (NON-REFL)
 BACKGROUND - ORANGE (REFL)

G20-2A & G20-4

11/97

G20-2A

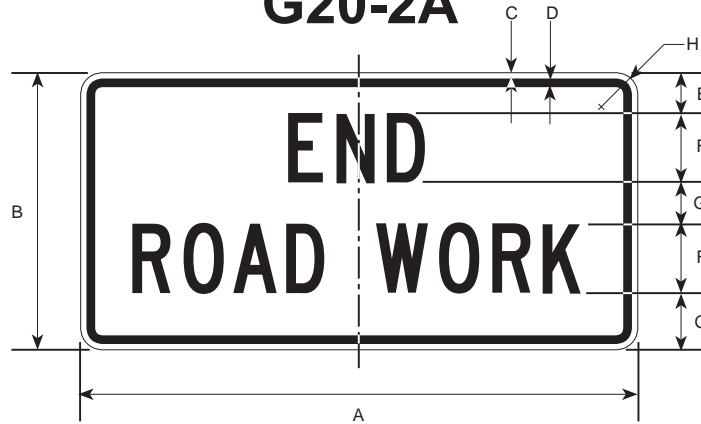

DIMENSIONS (MILLIMETERS)							
A	B	C	D	E	F	G	H
1200	600	9	16	75	150C	11	38

DIMENSIONS (INCHES)							
A	B	C	D	E	F	G	H
48	24	3/8	5/8	3	6C	4 1/2	1 1/2

G20-4

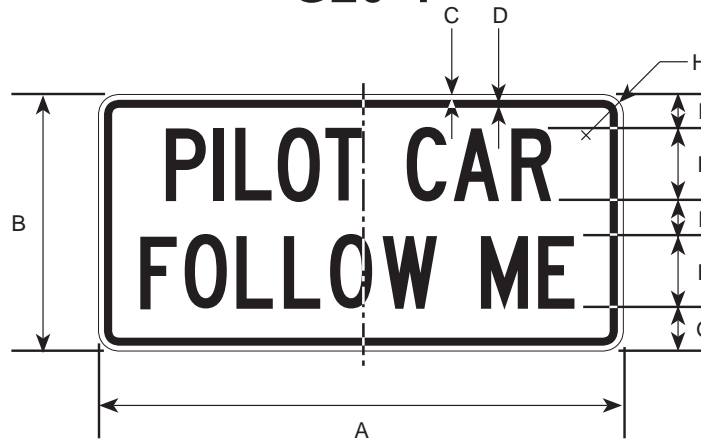

DIMENSIONS (MILLIMETERS)							
A	B	C	D	E	F	G	H
900	450	9	16	66	125C	69	38

DIMENSIONS (INCHES)							
A	B	C	D	E	F	G	H
36	18	3/8	5/8	2 5/8	5C	2 3/4	1 1/2

COLORS

LEGEND - BLACK (NON-REFL)
BACKGROUND - ORANGE

G20-601

11/97

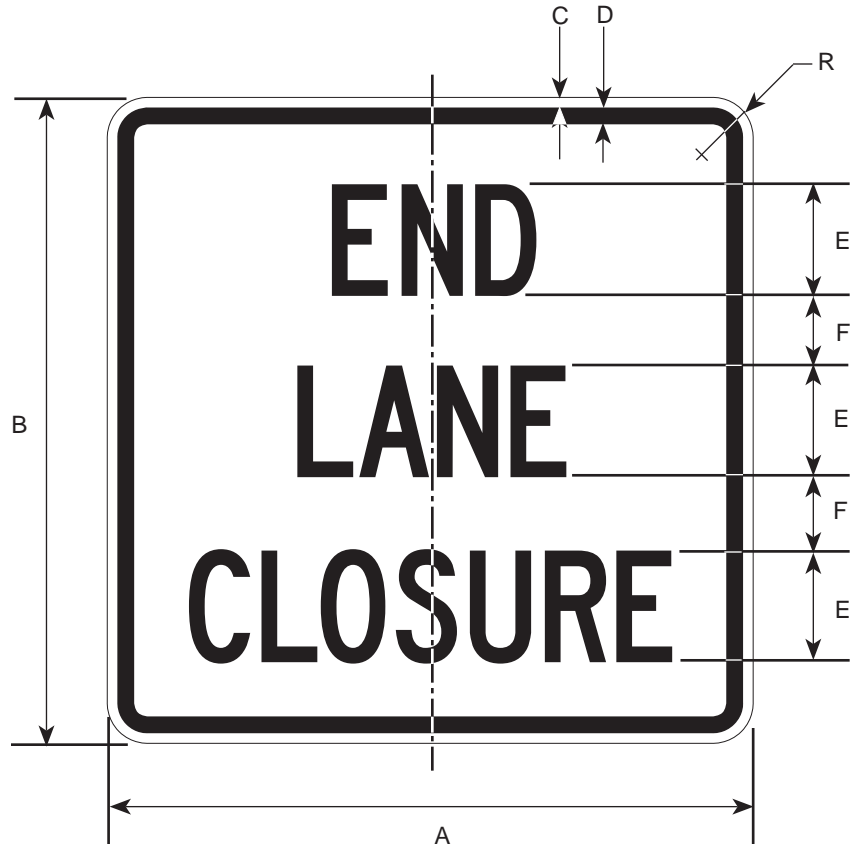

DIMENSIONS (MILLIMETERS)						
A	B	C	D	E	F	R
750	750	13	19	125C	88	47

DIMENSIONS (INCHES)						
A	B	C	D	E	F	R
30	30	1/2	3/4	5C	3 1/2	1 7/8

COLORS

LEGEND - BLACK (NON-REFL.)
BACKGROUND - ORANGE (REFL.)

G24-101

11/97

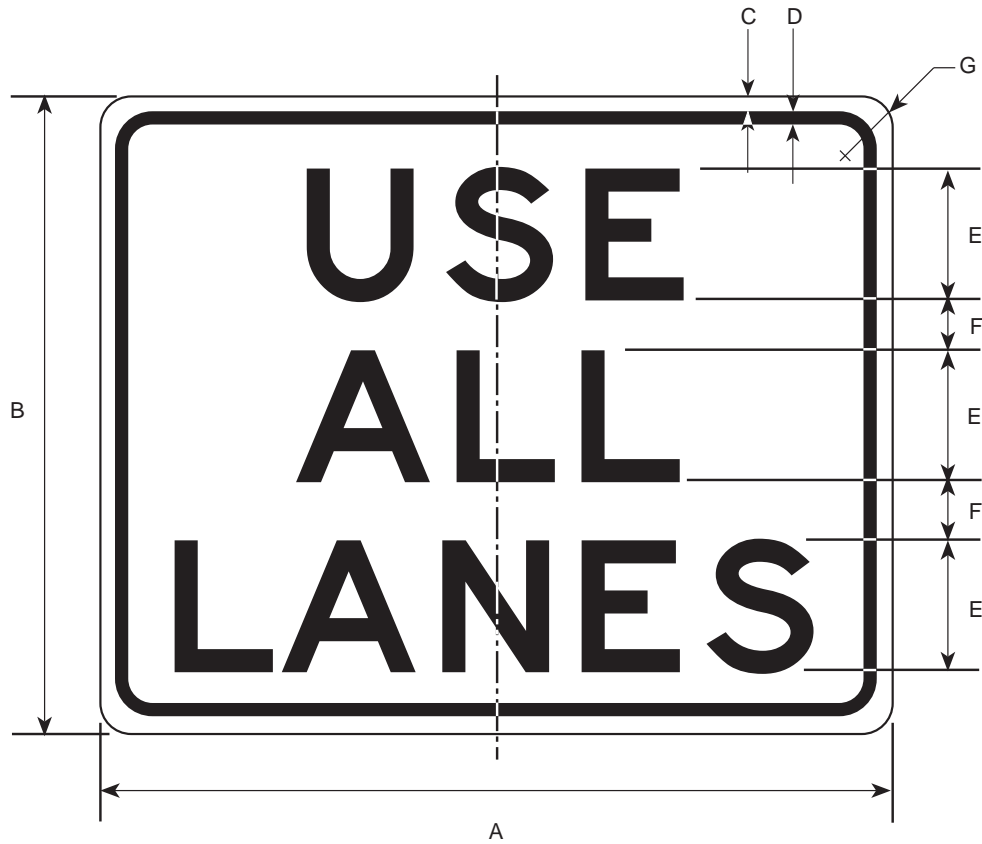

DIMENSIONS (MILLIMETERS)						
A	B	C	D	E	F	G
750	600	9	16	125E	47	38
1200	900	16	22	175E	75	56

DIMENSIONS (INCHES)						
A	B	C	D	E	F	G
30	24	3/8	5/8	5E	1 3/4	1 1/2
48	36	5/8	7/8	7E	3	2 1/4

COLORS

LEGEND - BLACK (NON-REFL)
BACKGROUND - ORANGE (REFL)

G24-201

11/97

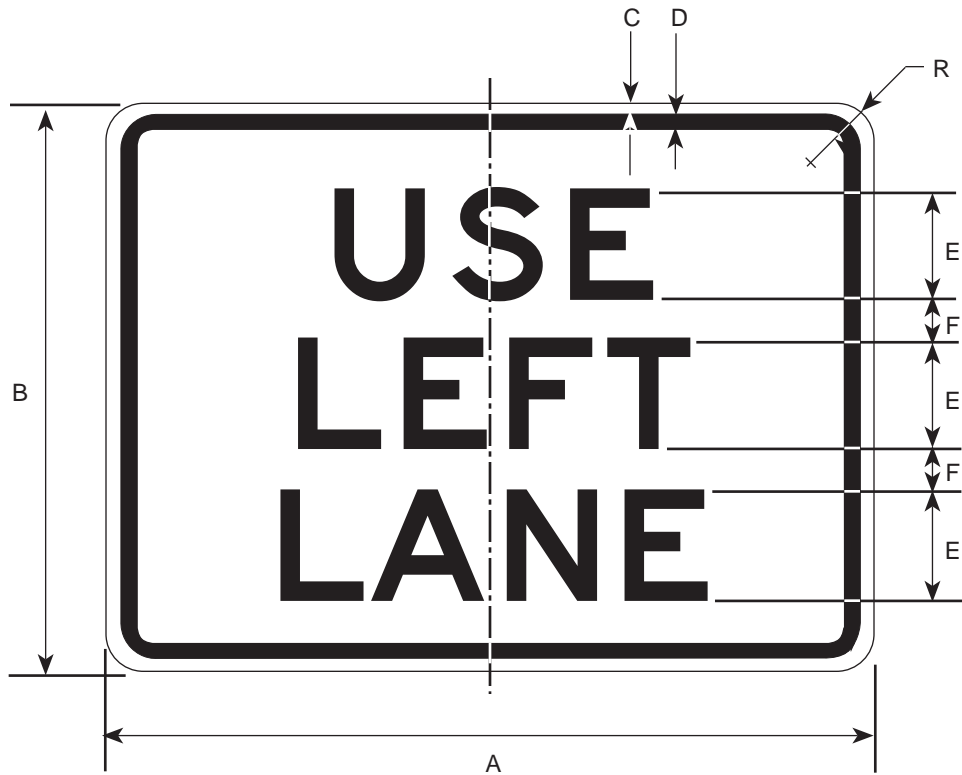

DIMENSIONS (MILLIMETERS)						
A	B	C	D	E	F	R
750	600	9	16	125E	47	38
1200	900	16	22	175E	75	56

DIMENSIONS (INCHES)						
A	B	C	D	E	F	R
30	24	3/8	5/8	5-E	1 3/4	1 1/2
48	36	5/8	7/8	7-E	3	2 1/4

COLORS

LEGEND - BLACK (NON-REFL.)
 BACKGROUND - ORANGE (REFL.)

G24-301

11/97

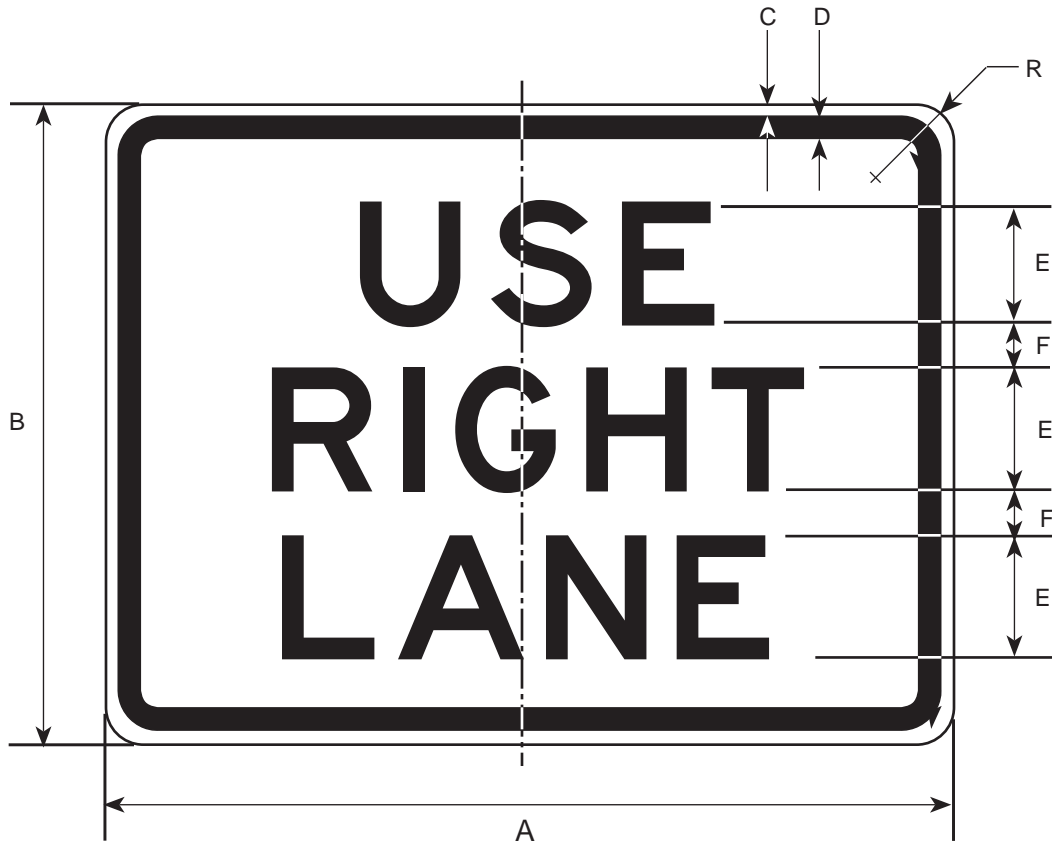

DIMENSIONS (MILLIMETERS)						
A	B	C	D	E	F	R
750	600	9	16	125E	47	38
1200	900	16	22	175E	75	56

DIMENSIONS (INCHES)						
A	B	C	D	E	F	R
30	24	3/8	5/8	5-E	1 3/4	1 1/2
48	36	5/8	7/8	7-E	3	2 1/4

COLORS

LEGEND - BLACK (NON-REFL.)
 BACKGROUND - ORANGE (REFL.)

G24-501

6/00



DIMENSIONS (MILLIMETERS)						
A	B	C	D	E	F	G
1200	900	16	22	150D	100D	56

DIMENSIONS (INCHES)						
A	B	C	D	E	F	G
48	36	5/8	7/8	6D	4D	2 1/4

COLORS

LEGEND - BLACK (NON-REFL)
 BACKGROUND - ORANGE (REFL)

G28-101

12/98

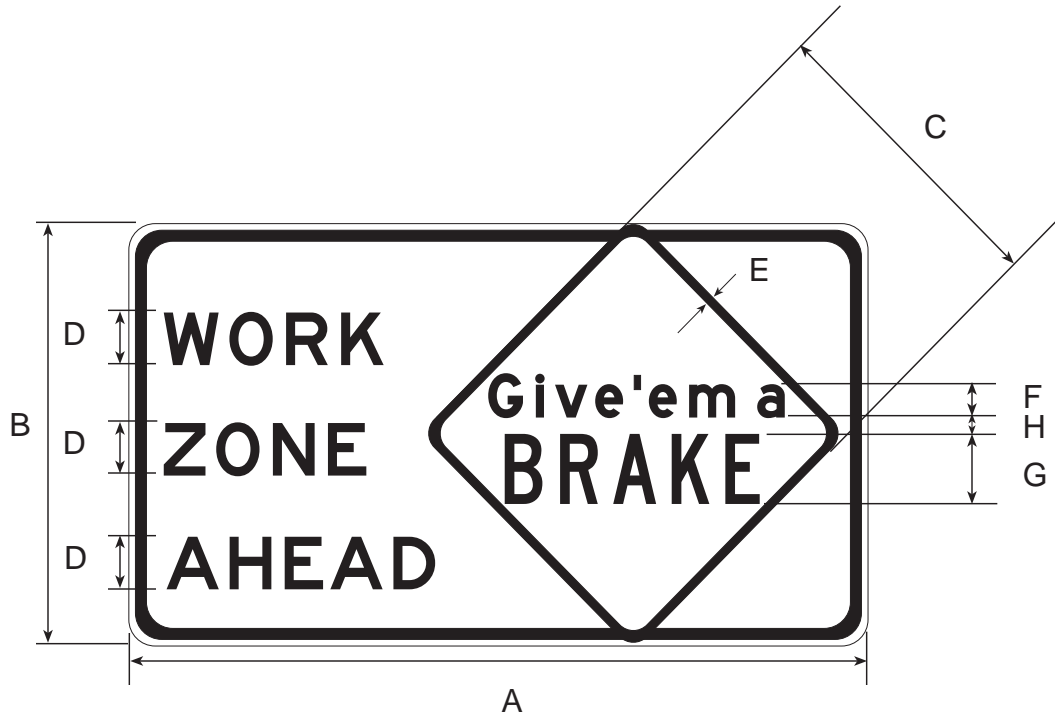

DIMENSIONS (MILLIMETERS)							
A	B	C	D	E	F	G	H
2100	1200	850	150E	22	125/94	200C	50

DIMENSIONS (INCHES)							
A	B	C	D	E	F	G	H
84	48	34	6E	7/8	5/3.75	8C	2

COLORS

LEGEND - BLACK (NON-REFL.)

BACKGROUND - ORANGE (REFL.)

G28-201

5/06

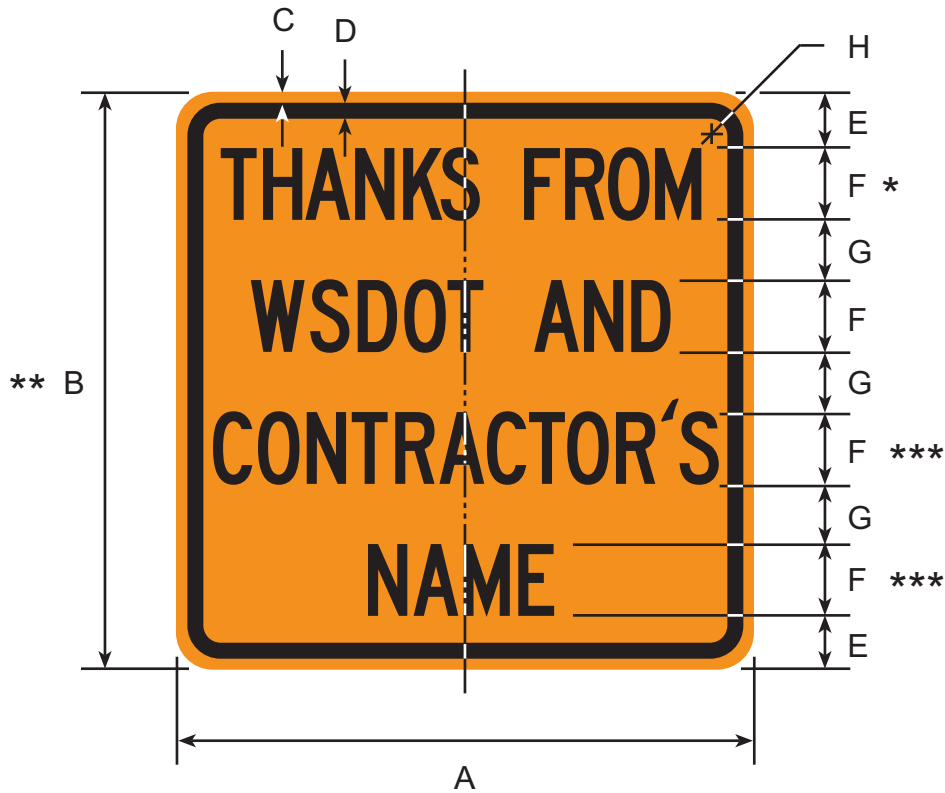

* - REDUCE SPACING 30%

** - IF CONTRACTOR'S NAME ONLY REQUIRES ONE LINE OF COPY REDUCE DIMENSION B TO 900mm (36")

*** - MAXIMUM OF TEN LETTER CHARACTERS PER LINE, IF CONTRACTOR'S NAME EXCEEDS TEN CHARACTERS PER LINE REDUCE LETTER SIZE TO 125C (5C)

DIMENSIONS (MILLIMETERS)							
A	B	C	D	E	F	G	H
1200	1200	19	150C	113	150	125	75

DIMENSIONS (INCHES)							
A	B	C	D	E	F	G	H
48	48	3/4	6C	4 1/2	150	5	3

COLORS

LEGEND & BORDER - BLACK (NON-REFL)
BACKGROUND - ORANGE (REFL)

I1-1

11/97

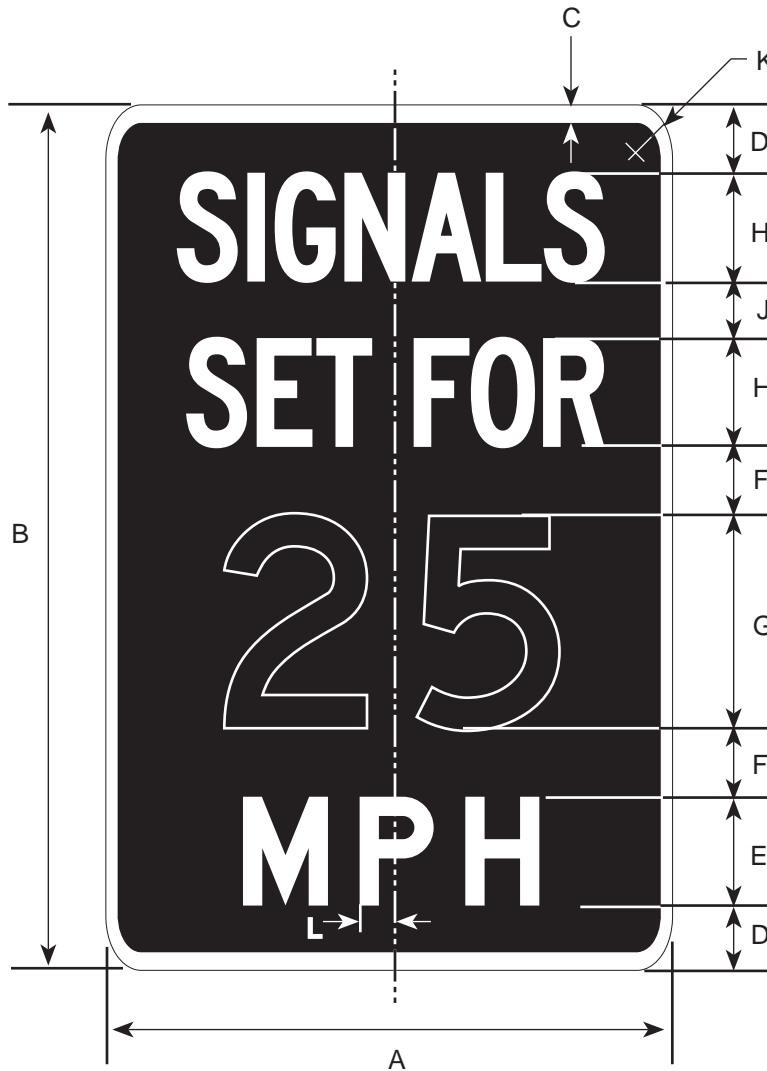

DIMENSIONS (MILLIMETERS)										
A	B	C	D	E	F	G	H	J	K	L
300	450	13	50	50D	35	100D	50C	31	38	13

DIMENSIONS (INCHES)										
A	B	C	D	E	F	G	H	J	K	L
12	18	1/2	2	2D	1 3/8	4D	2C	1 1/4	1 1/2	1/2

COLORS

LEGEND - WHITE (REFL)
 BACKGROUND - GREEN (REFL)

I1-2

11/97

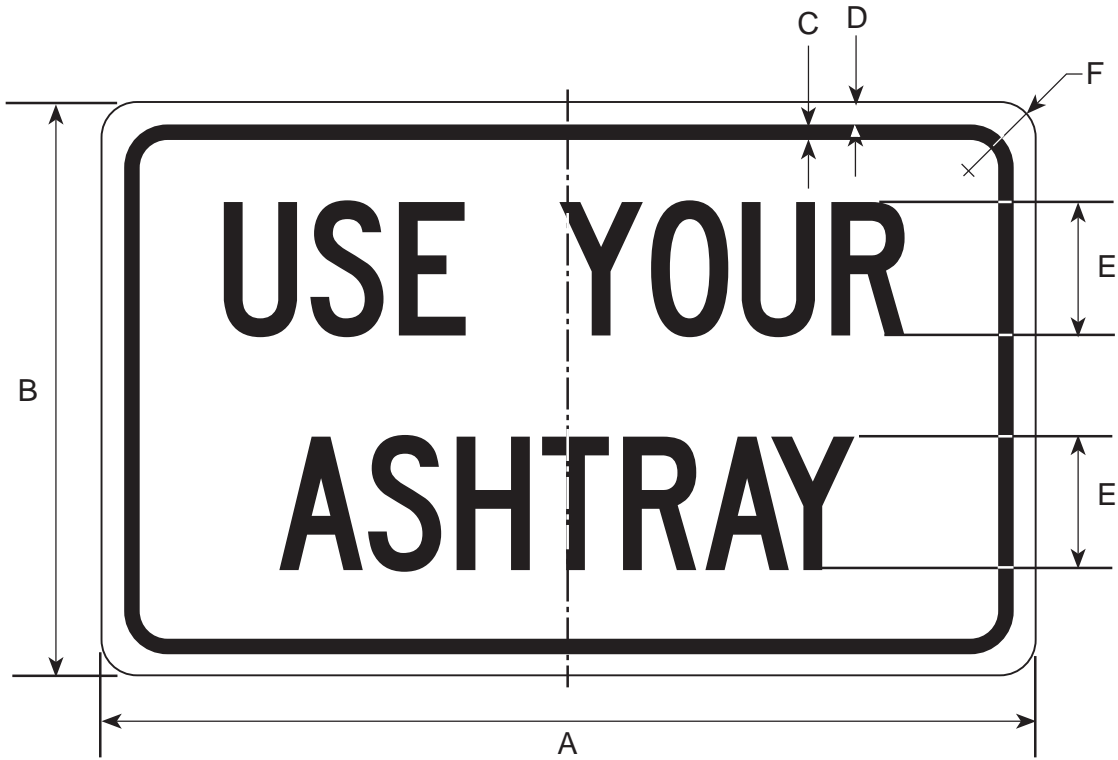

DIMENSIONS (MILLIMETERS)					
A	B	C	D	E	F
750	450	16	22	100C	47

DIMENSIONS (INCHES)					
A	B	C	D	E	F
30	18	5/8	7/8	4C	1 7/8

COLORS

LEGEND - GREEN (REFL)

BACKGROUND - WHITE (REFL)

I1-201

11/97



DIMENSIONS (MILLIMETERS)				
A	B	C	D	E
750	62	16	22	47

DIMENSIONS (INCHES)				
A	B	C	D	E
30	2 1/2	5/8	7/8	1 7/8

COLORS

- CIRCLE— RED (REFL)
- BORDER—GREEN (REFL)
- BACKGROUND—WHITE (REFL)
- TREE—GREEN (REFL)
- FLAME— ORANGE (REFL)
- TREE TRUNK— BROWN (REFL)

I1-301

11/97

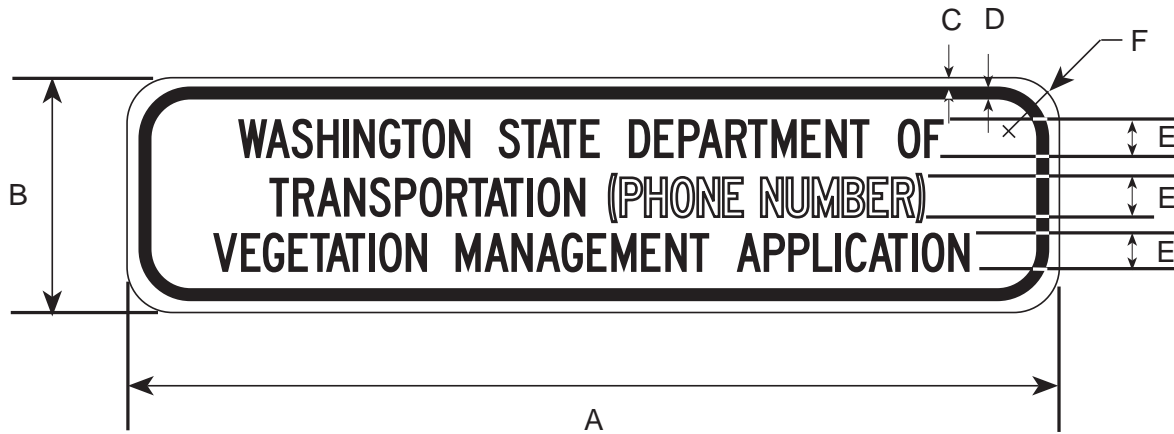

DIMENSIONS (MILLIMETERS)					
A	B	C	D	E	F
1200	300	9	16	50C	38

DIMENSIONS (INCHES)					
A	B	C	D	E	F
48	12	3/8	5/8	2C	1 1/2

COLORS

LEGEND - BLACK (NON-REFL)
BACKGROUND - ORANGE (REFL)

I2-101

11/97



DIMENSIONS (MILLIMETERS)					
A	B	C	D	E	F
1800	1200	162E	250	175E	75

DIMENSIONS (INCHES)					
A	B	C	D	E	F
72	48	6 1/2E	10	7E	3

COLORS

SYMBOL - WHITE (REFL)

LEGEND - BLACK (NON-REFL)

BACKGROUND - GREEN (REFL)

WASHINGTON SCRIPT - GREEN (REFL)

I2-201

11/97



SIZE CODE	DIMENSIONS (MILLIMETERS)								
	A	B	C	D	E	F	G	H	J
A	VA	750	25	100D	113	150 UC	75	125	100
B	VA	1200	38	150D	150 LC	200 UC	150	200	150

SIZE CODE	DIMENSIONS (INCHES)								
	A	B	C	D	E	F	G	H	J
A	VA	30	1	4D	4 1/2 LC	6 UC	3	5	4
B	VA	48	1 1/2	6D	6 LC	8 UC	6	8	6

COLORS

LEGEND - WHITE (REFL)
BACKGROUND - GREEN (REFL)

I2-301

11/97

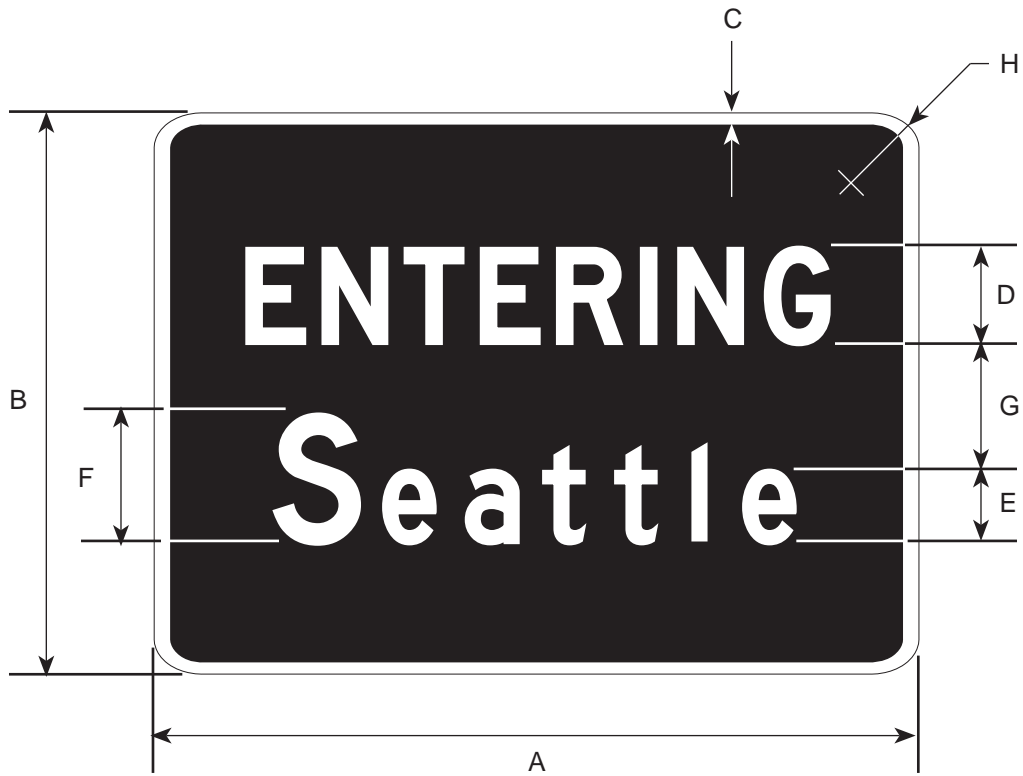

DIMENSIONS (MILLIMETERS)								
CODE	A	B	C	D	E	F	G	H
A	VAR	600	25	100D	113LC	150UC	113	100
B	VAR	900	38	150D	150LC	200UC	175	150

DIMENSIONS (INCHES)								
CODE	A	B	C	D	E	F	G	H
A	VAR	24	1	4D	4 1/2LC	6UC	4 1/2	4
B	VAR	36	1 1/2	6D	6LC	8UC	7	6

COLORS

LEGEND - WHITE (REFL)
 BACKGROUND - GREEN (REFL)

I2-401

11/97

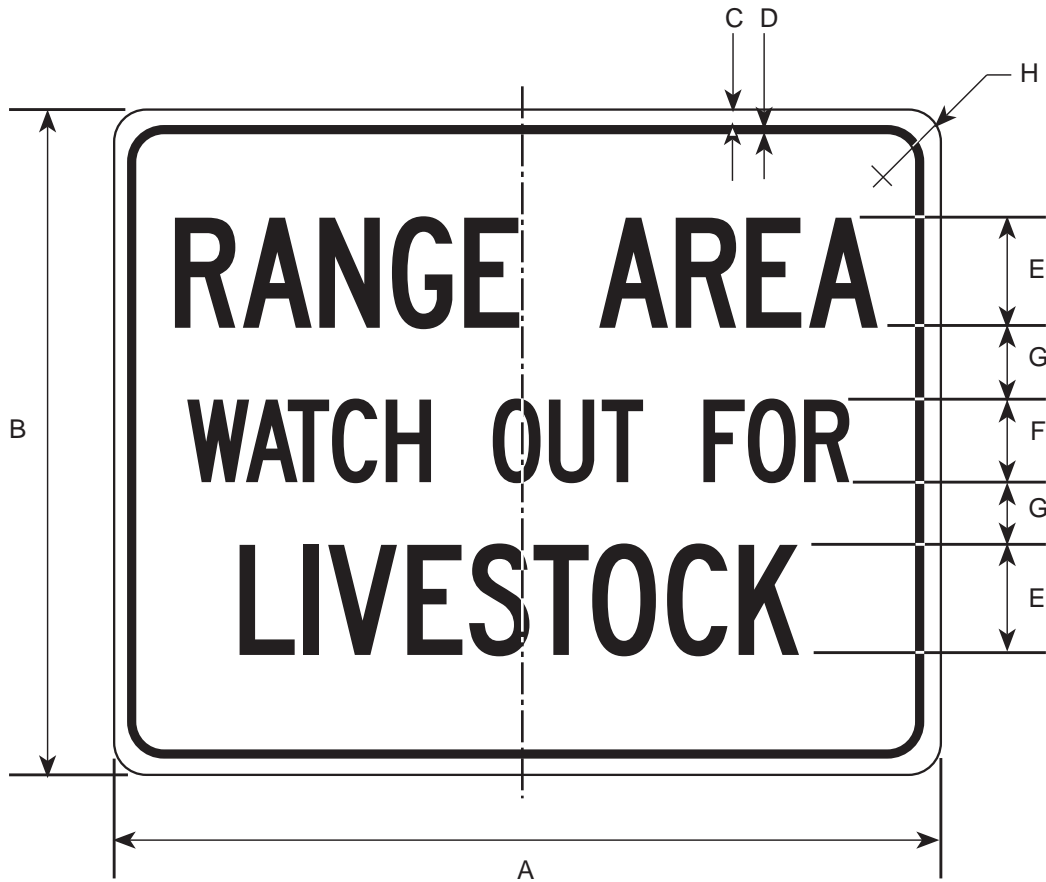

DIMENSIONS (MILLIMETERS)							
A	B	C	D	E	F	G	H
750	600	10	16	100C	75C	63	38

DIMENSIONS (INCHES)							
A	B	C	D	E	F	G	H
30	24	3/8	5/8	4C	3C	2 1/2	1 1/2

COLORS

LEGEND - BLACK (NON-REFL)

BACKGROUND - WHITE (REFL)

I2-501

11/97

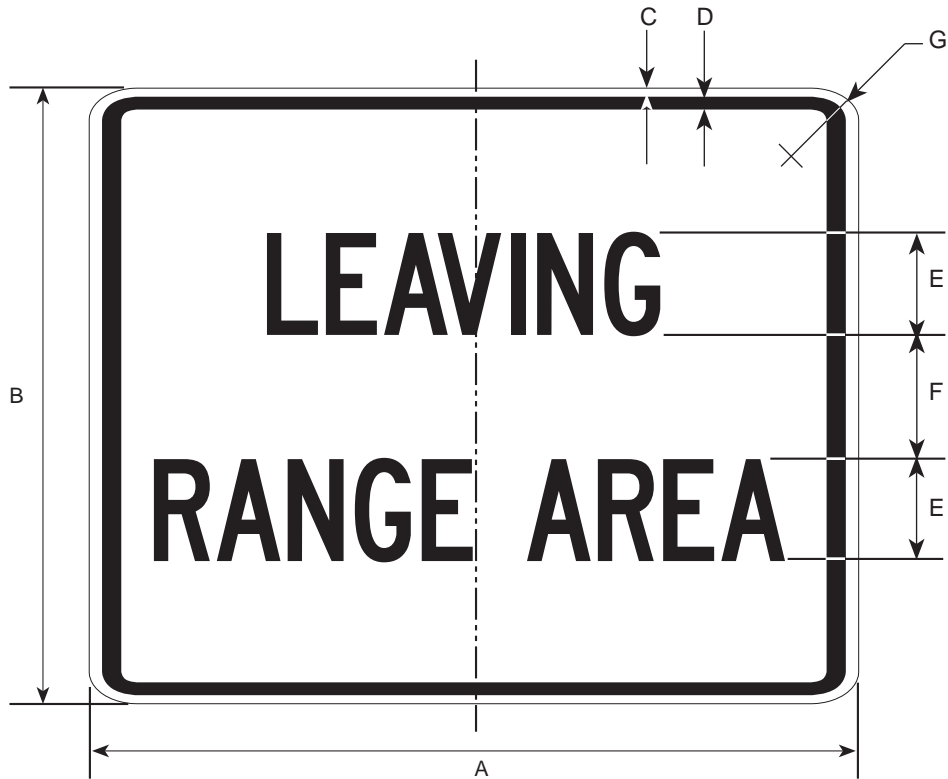

DIMENSIONS (MILLIMETERS)						
A	B	C	D	E	F	G
750	600	10	16	100C	100	38

DIMENSIONS (INCHES)						
A	B	C	D	E	F	G
30	24	3/8	5/8	4C	4	1 1/2

COLORS

LEGEND - BLACK (NON-REFL)

BACKGROUND - WHITE (REFL)

I2-601

11/97

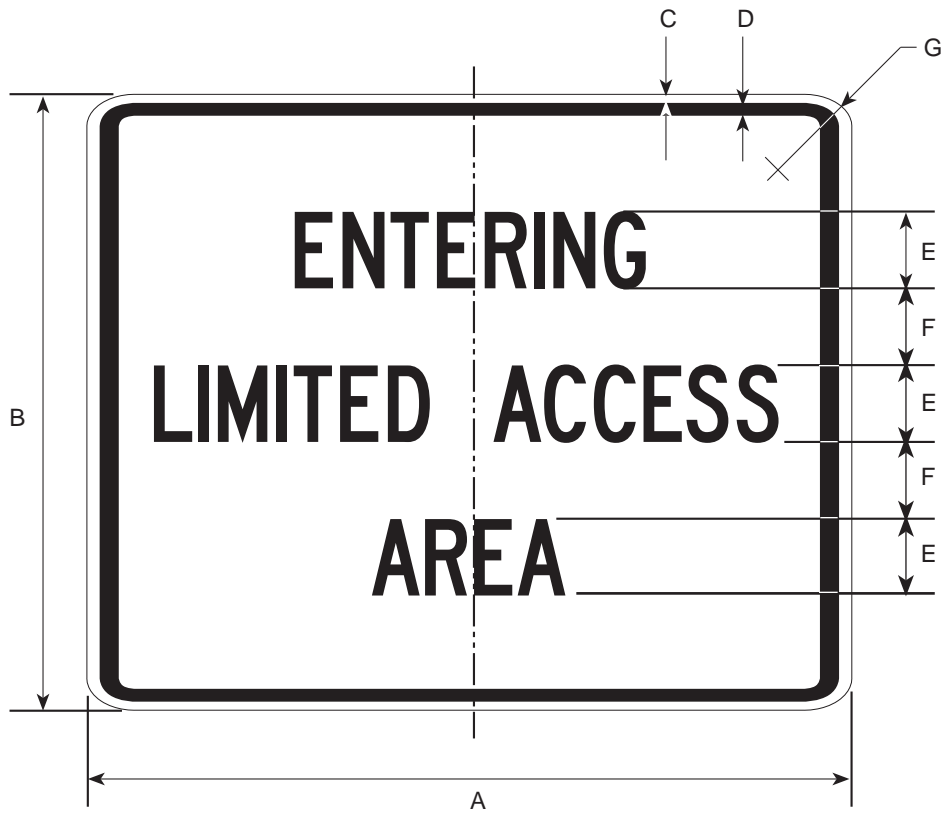

DIMENSIONS (MILLIMETERS)						
A	B	C	D	E	F	G
750	600	10	16	75C	81	38

DIMENSIONS (INCHES)						
A	B	C	D	E	F	G
30	24	3/8	5/8	3C	3 1/4	1 1/2

COLORS
LEGEND - BLACK (NON-REFL)
BACKGROUND - WHITE (REFL)

I2-701

11/97

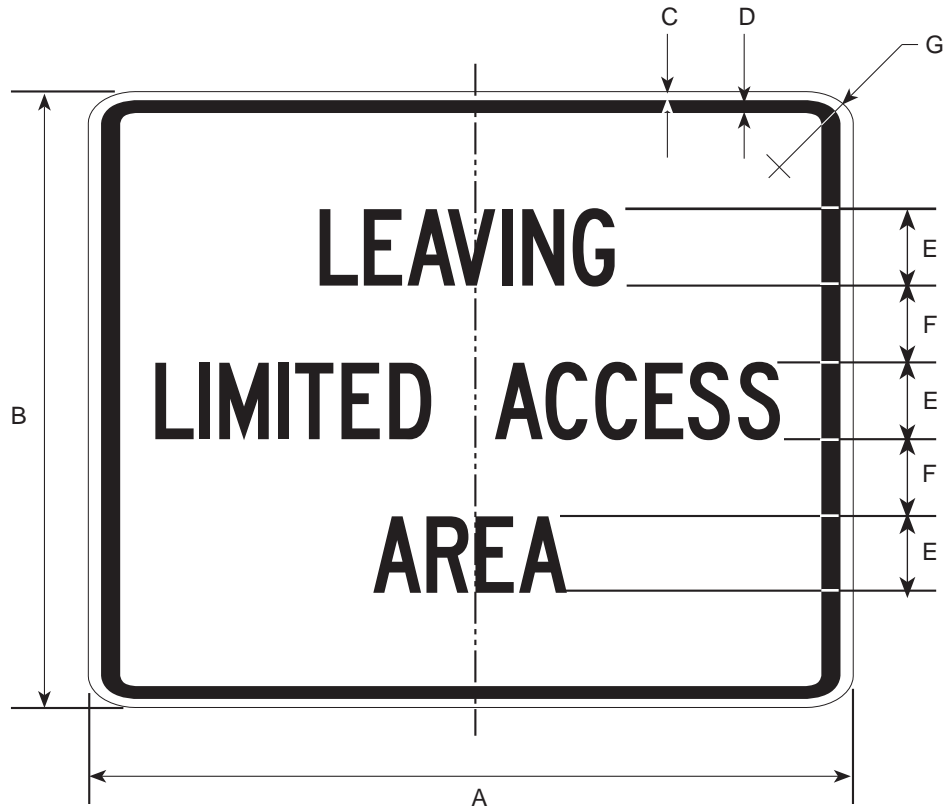

DIMENSIONS (MILLIMETERS)						
A	B	C	D	E	F	G
750	600	10	16	75C	81	38

DIMENSIONS (INCHES)						
A	B	C	D	E	F	G
30	24	3/8	5/8	3C	3 1/4	1 1/2

COLORS

LEGEND - BLACK (NON-REFL)
BACKGROUND - WHITE (REFL)

I3-101

11/97

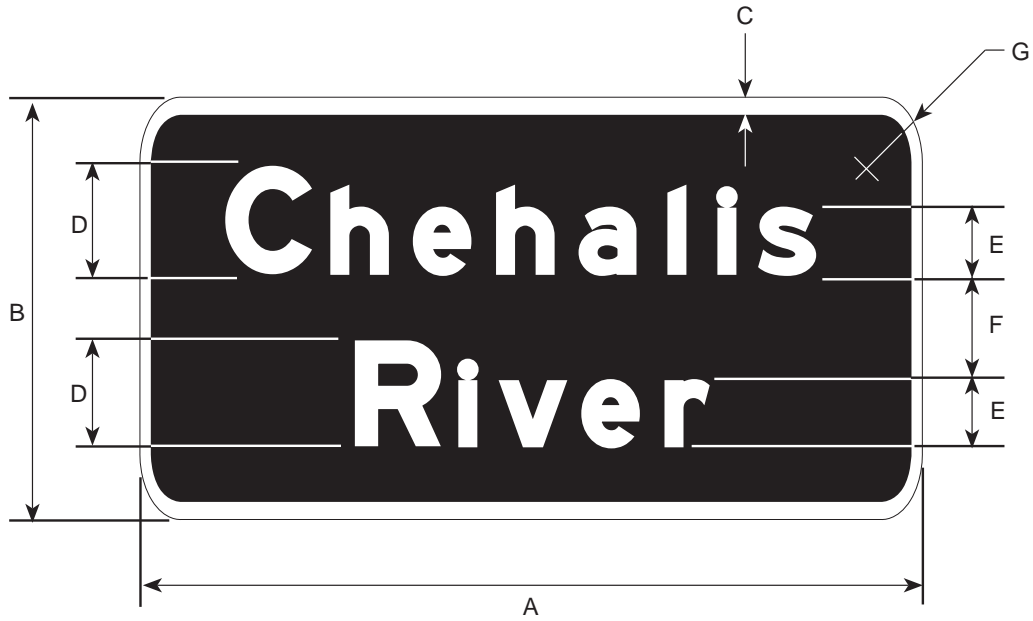

DIMENSIONS (MILLIMETERS)							
CODE	A	B	C	D	E	F	G
A	VAR	600	19	150UC	113LC	100	75
B	VAR	900	38	200UC	150LC	150	113

DIMENSIONS (INCHES)							
CODE	A	B	C	D	E	F	G
A	VAR	24	3/4	6UC	4 1/2LC	4	3
B	VAR	36	1 1/2	8UC	6LC	6	4.5

COLORS

LEGEND - WHITE (REFL)
 BACKGROUND - GREEN (REFL)

I3-201

11/97

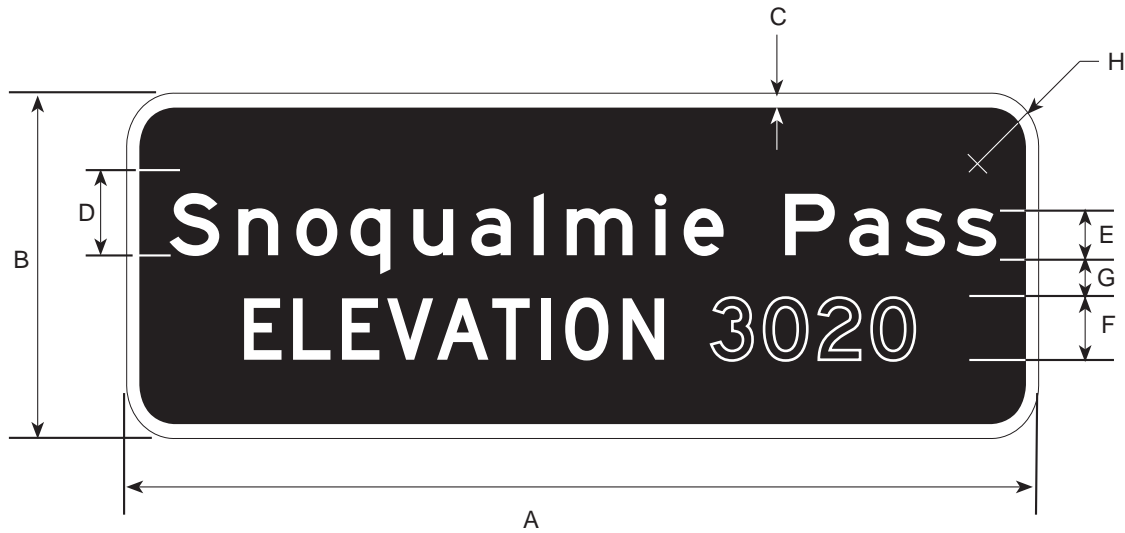

DIMENSIONS (MILLIMETERS)								
CODE	A	B	C	D	E	F	G	H
A	VAR	600	19	150UC	113LC	125D	100	75
B	VAR	900	38	200UC	150LC	150D	150	150

DIMENSIONS (INCHES)								
CODE	A	B	C	D	E	F	G	H
A	VAR	24	3/4	6UC	4 1/2LC	5D	4	3
B	VAR	36	1 1/2	8UC	6LC	6D	6	6

COLORS

LEGEND - WHITE (REFL)
BACKGROUND - GREEN (REFL)

I4-301

11/97



DIMENSIONS (MILLIMETERS)				
A	B	C	D	SYMBOL SIZE
600	750	15.62	37.5	CONTACT ST. ENG.

DIMENSIONS (INCHES)				
A	B	C	D	SYMBOL SIZE
24	30	5/8	1 1/2	CONTACT ST. ENG.

COLORS

LEGEND - BROWN (REFL)
 BACKGROUND - WHITE (REFL)

I4-401

11/97

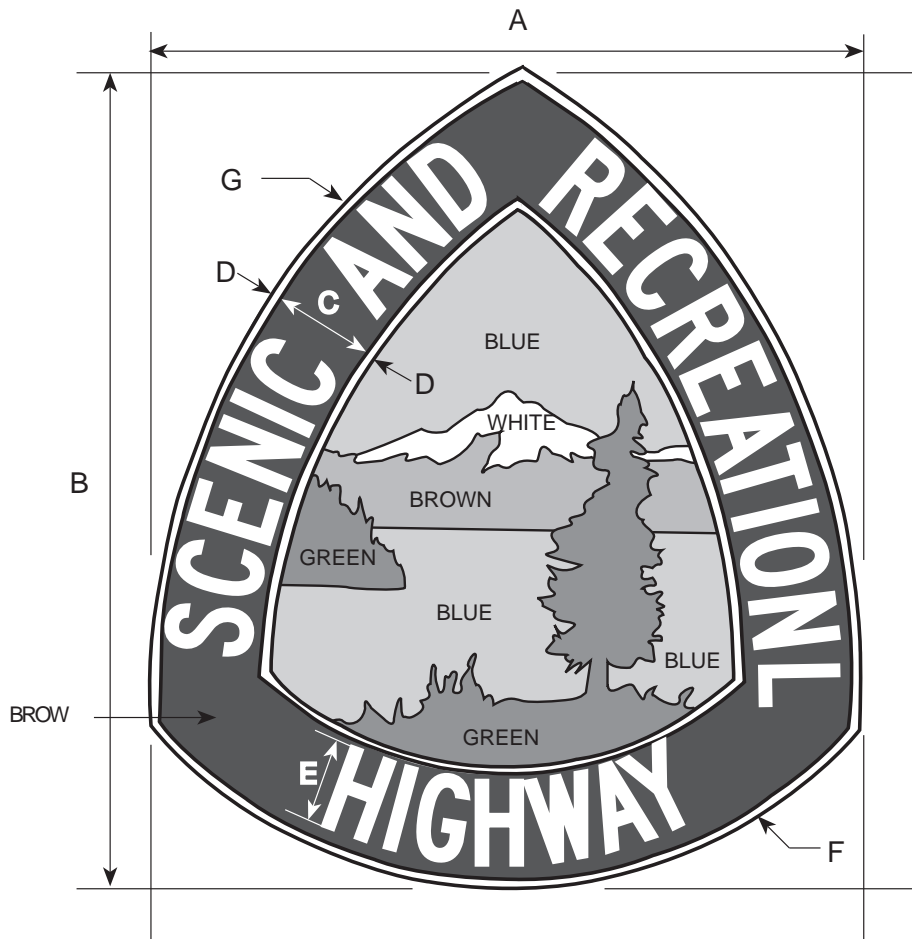

DIMENSIONS						
A	B	C	D	E	F	G
900	1050	137.5	12.5	100C	600	900

DIMENSIONS						
A	B	C	D	E	F	G
36	42	5 1/2	1/2	4C	24	36

COLOR

LEGEND - WHITE LETTERS, COLOR AS NOTED

BACKGROUND - FULLY REFLECTORIZED

I5-103

11/97



DIMENSIONS (MILLIMETERS)					
A	B	C	D	E	F
1200	900	16	22	150D	56

DIMENSIONS (INCHES)					
A	B	C	D	E	F
48	36	5/8	7/8	6D	2 1/4

COLORS

LEGEND - WHITE (REFL)
 BACKGROUND - BROWN (REFL)

I5-104

11/97



DIMENSIONS (MILLIMETERS)						
A	B	C	D	E	F	ARROW SIZE
1200	900	16	22	150D	56	225 X 150

DIMENSIONS (INCHES)						
A	B	C	D	E	F	ARROW SIZE
48	36	5/8	7/8	6D	2 1/4	9 X 6

COLORS

LEGEND - WHITE (REFL)
BACKGROUND - BROWN (REFL)

I5-5

11/97

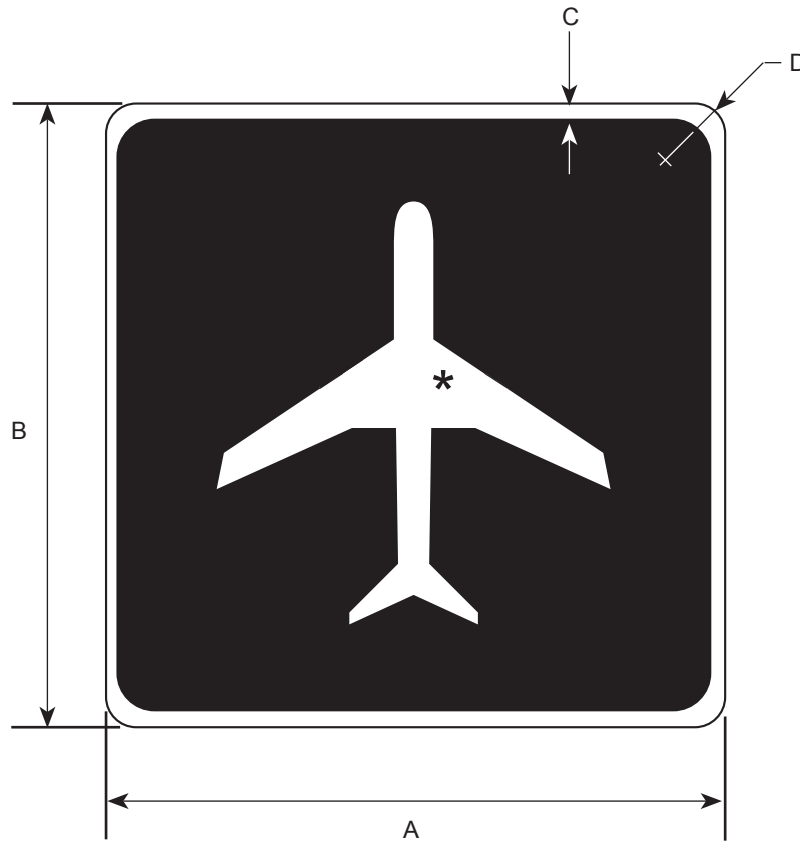

* SEE APPENDIX FOR SYMBOL DESIGN

DIMENSIONS (MILLIMETERS)			
A	B	C	D
600	600	13	38
750	750	19	47

DIMENSIONS (INCHES)			
A	B	C	D
24	24	1/2	1 1/2
30	30	3/4	1 7/8

COLORS

LEGENDó WHITE (REFL)
BACKGROUNDó GREEN (REFL)

15-6

10/03

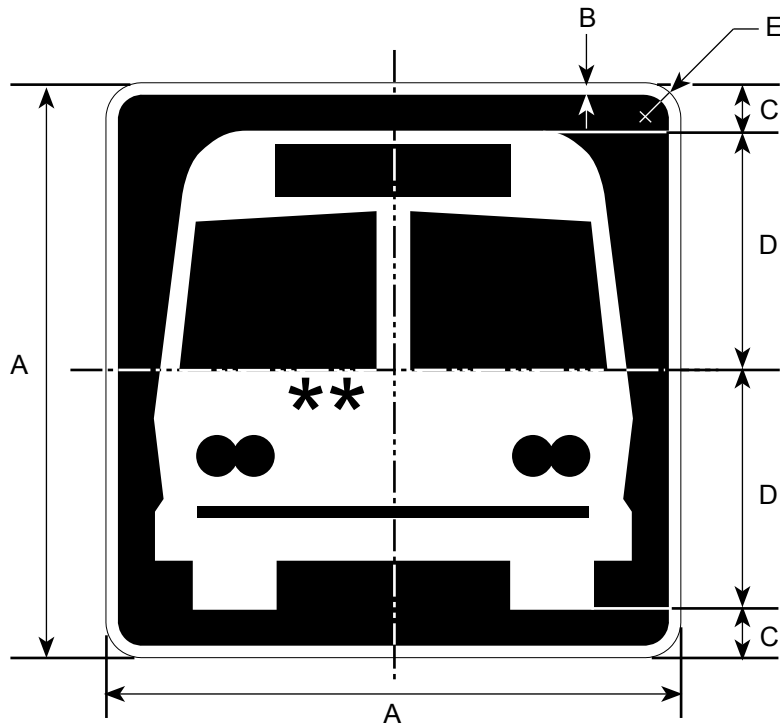

** See appendix for symbol design

DIMENSIONS (MILLIMETERS)				
A	B	C	D	E
600	13	75	225	38
750	19	94	281	47

DIMENSIONS (INCHES)				
A	B	C	D	E
24	1/2	3	9	1 1/2
30	3/4	3 3/4	11 1/4	1 7/8

COLORS

LEGEND — WHITE (REFL)

BACKGROUND — GREEN

15-7

11/97

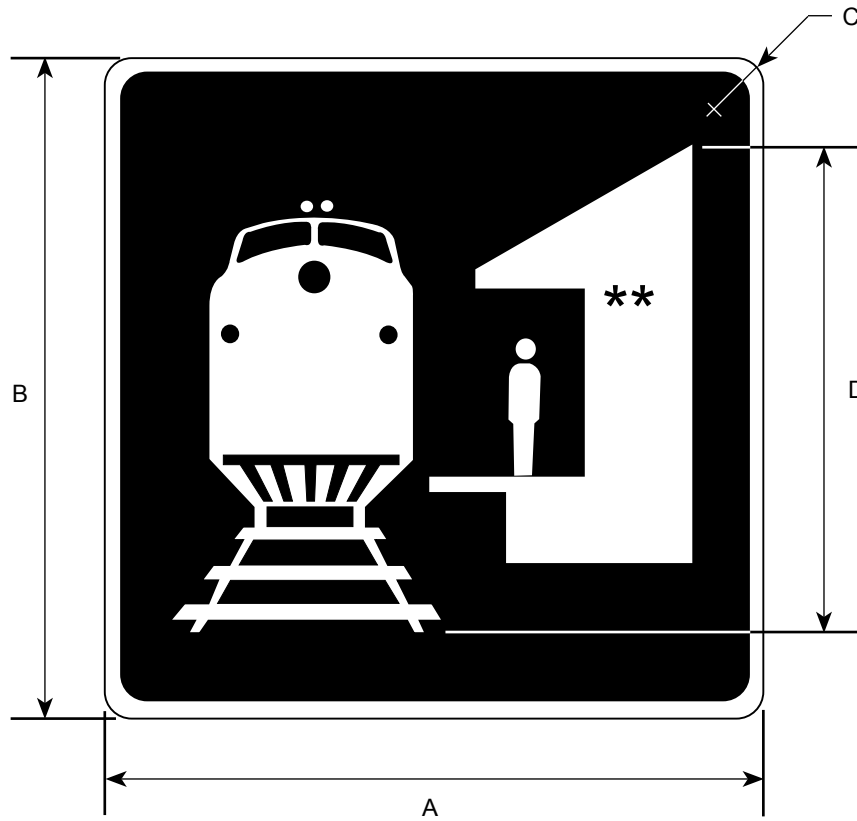

* SEE APPENDIX FOR SYMBOL DESIGN

DIMENSIONS (MILLIMETERS)			
A	B	C	D
600	600	38	450
750	750	47	563

DIMENSIONS (INCHES)			
A	B	C	D
24	24	1 1/2	18
30	30	1 7/8	22 1/2

COLORS
 LEGEND—WHITE (REFL)
 BACKGROUND— GREEN (REFL)

I5-801

11/97

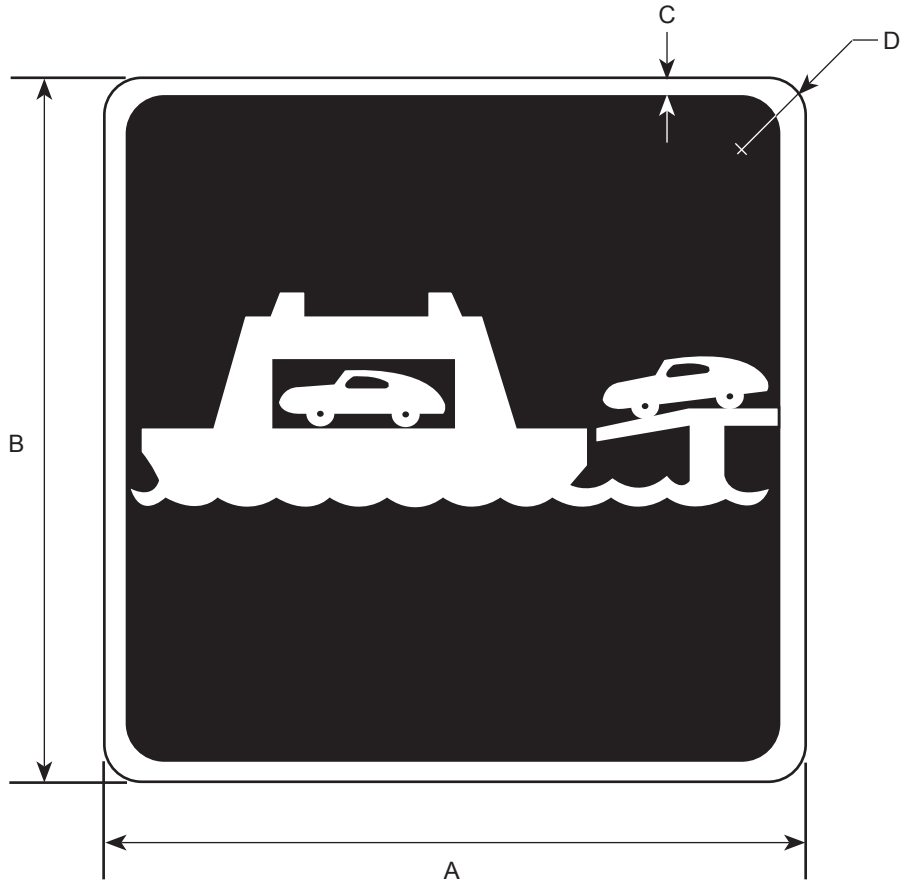

DIMENSIONS (MILLIMETERS)				
A	B	C	SYMBOL SIZE	D
600	600	13	CONTACT STATE ENG.	38
750	750	19		47

DIMENSIONS (INCHES)				
A	B	C	SYMBOL SIZE	D
24	24	1/2	CONTACT STATE ENG.	1 1/2
30	30	3/4		1 7/8

COLORS

LEGENDó WHITE (REFL)
BACKGROUNDó GREEN (REFL)

I5-801A

11/97

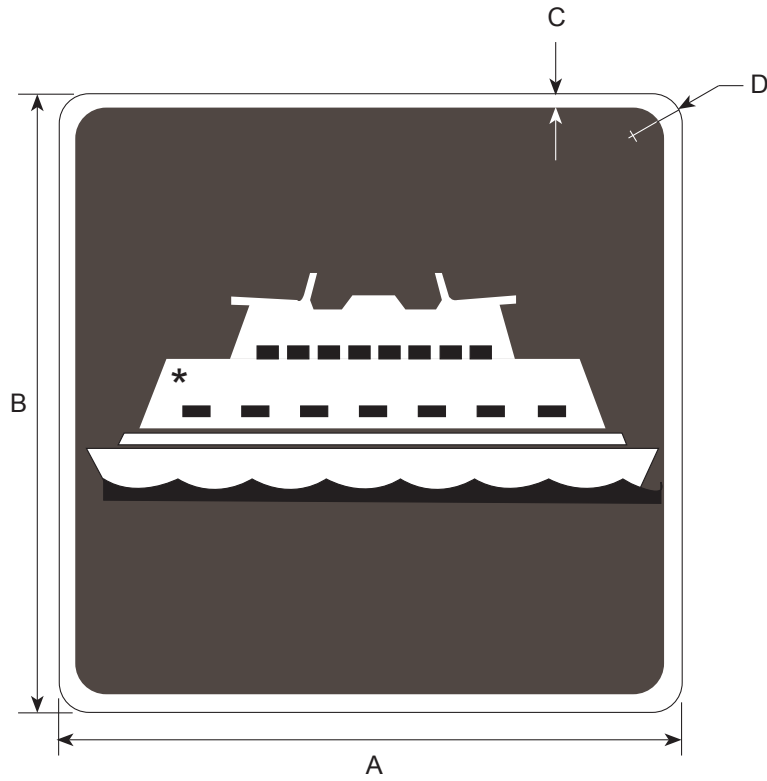

* SEE APPENDIX FOR SYMBOL DESIGN

SIG	DIMENSIONS			
	A	B	C	D
A	600	600	12.5	37.5
B	750	750	18.75	46.87

SIG	DIMENSIONS			
	A	B	C	D
A	24	24	1/2	1 1/2
B	30	30	3/4	1 7/8

COLOR
LEGEND- WHITE
BACKGROUND-GREEN

I6-101

11/97



* SEE APPENDIX FOR SYMBOL DESIGN

DIMENSIONS (MILLIMETERS)						
A	B	C	D	E	F	G
1500	900	22	25	150D	88	75

DIMENSIONS (INCHES)						
A	B	C	D	E	F	G
60	36	7/8	1	6D	3 1/2	3

COLORS

LEGEND - BLACK (NON-REFL)

BACKGROUND - WHITE (REFL)

SYMBOL - BLUE (REFL)

I6-102

12/01



DIMENSIONS (MILLIMETERS)							
A	B	C	D	E	F	G	H
900	750	13	19	100C	75C	75	47
1200	900	16	22	125D	100C	100	56
1500	900	19	31	150D	125C	100	100
1800	1200	19	38	200D	150C	150	150

DIMENSIONS (INCHES)							
A	B	C	D	E	F	G	H
36	30	1/2	3/4	4C	3C	3	17/8
48	36	5/8	7/8	5D	4C	4	21/4
60	36	3/4	11/4	6D	5C	4	4
72	48	3/4	11/2	8D	6C	6	6

COLORS

TOP

TEXT - BLACK (NON-REFL)
 BORDER - BLUE (REFL)
 BACKGROUND - WHITE (REFL)

BOTTOM

TEXT - WHITE (REFL)
 BORDER - BLUE (REFL)
 BACKGROUND - BLUE (REFL)

I6-201

11/97

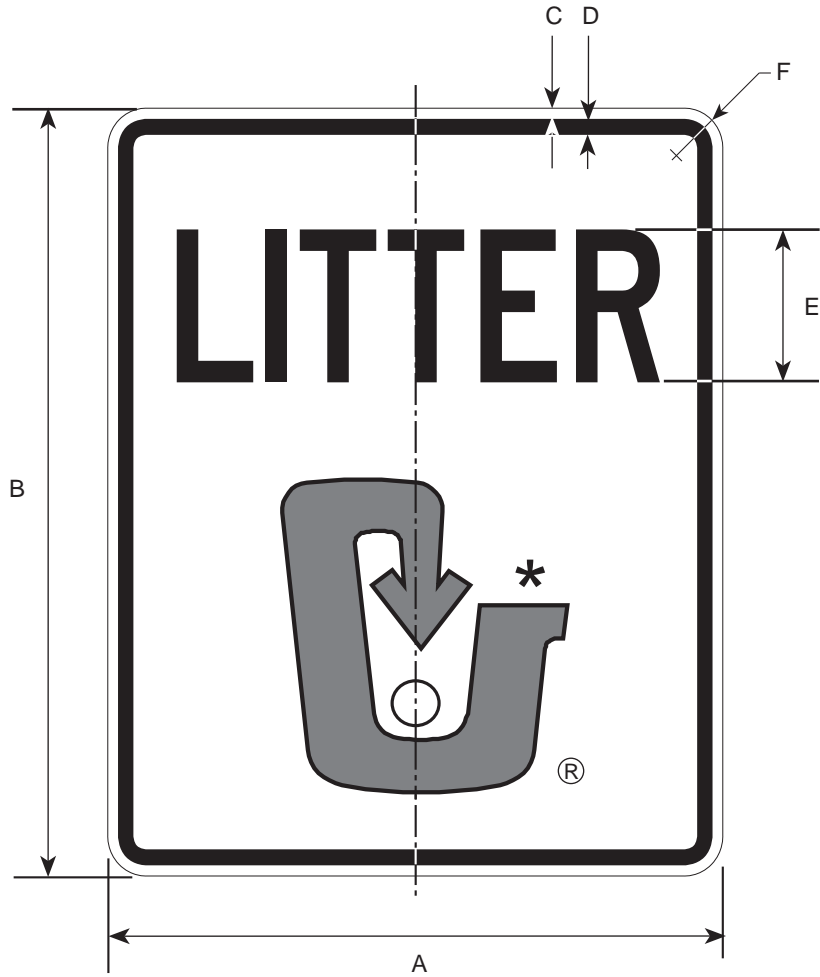

* SEE APPENDIX FOR SYMBOL DESIGN

DIMENSIONS (MILLIMETERS)					
A	B	C	D	E	F
600	750	3/8	5/8	150	38

DIMENSIONS (INCHES)					
A	B	C	D	E	F
24	30	3/8	5/8	6C	1 1/2

COLORS

LEGEND - BLACK (NON-REFL)
 BACKGROUND - WHITE (REFL)
 SYMBOL - BLUE (REFL)

I6-301

11/97

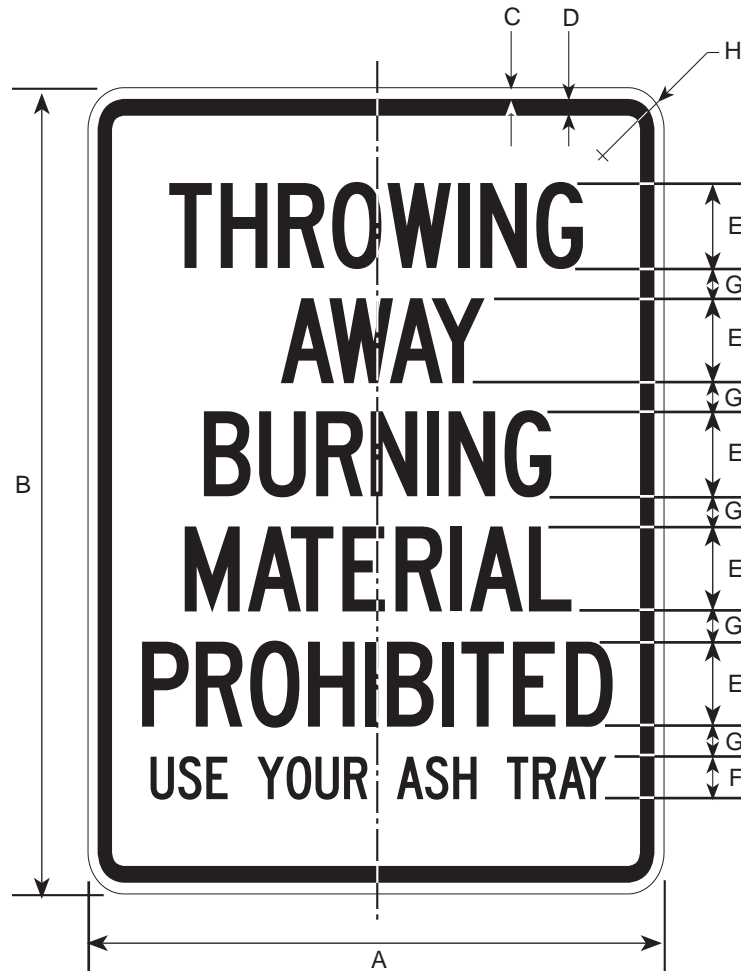

DIMENSIONS (MILLIMETERS)							
A	B	C	D	E	F	G	H
750	1200	16	22	100C	50C	50	47

DIMENSIONS (INCHES)							
A	B	C	D	E	F	G	H
30	48	5/8	7/8	4C	2C	2	1 7/8

COLORS

LEGEND - BLACK (NON-REFL)
BACKGROUND - WHITE (REFL)

I6-801

11/97



* SEE APPENDIX FOR SYMBOL DESIGN

DIMENSIONS (MILLIMETERS)								
A	B	C	D	E	F	G	H	J
750	600	9	16	3B	50	50	100	38

DIMENSIONS (INCHES)								
A	B	C	D	E	F	G	H	J
30	24	3/8	5/8	3B	2C	2	4	1 1/2

COLORS

LEGEND - BLACK (NON-REFL)
 BACKGROUND - WHITE (REFL)
 SYMBOL - BLUE (REFL)

I6-901

1/01

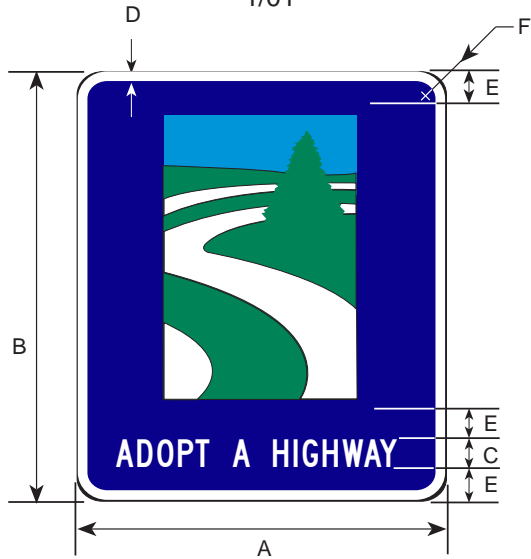

DIMENSIONS (MILLIMETERS)					
A	B	C	D	E	F
750	900	50C	12.5	50	37.5

DIMENSIONS (INCHES)					
A	B	C	D	E	F
30	36	2C	1/2	2	1 1/2

LOGO SIZE: 21" wide by 28" tall
 LOGO COLORS
 SKY - PANTONE 306
 TREE & LANDSCAPE - PANTONE 341
 ROADWAY - WHITE

I6-903



DIMENSIONS (MILLIMETERS)				
A	B	C	D	E
750	300	50C	100C	12.5

DIMENSIONS (INCHES)				
A	B	C	D	E
30	12	2C	4C	1/2

I6-902

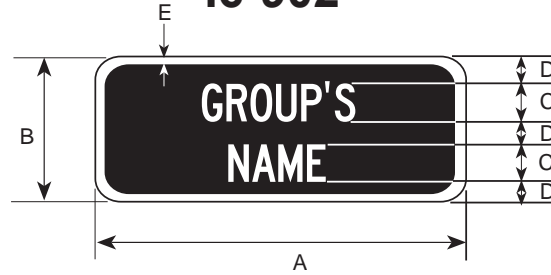

DIMENSIONS (MILLIMETERS)				
A	B	C	D	E
750	300	75C	50	12.5

DIMENSIONS (INCHES)				
A	B	C	D	E
30	12	3C	2	1/2

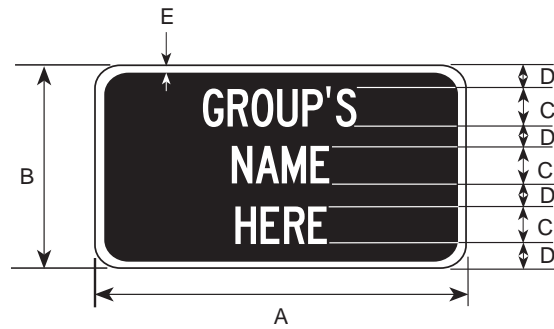

13 SPACES PER LINE

DIMENSIONS (MILLIMETERS)				
A	B	C	D	E
750	450	75C	56.25	12.5

DIMENSIONS (INCHES)				
A	B	C	D	E
30	18	3C	2.25	1/2

COLORS

LEGEND - WHITE (REFL)
 BACKGROUND - BLUE (REFL)

I6-901A

1/01



LOGO SIZE: 21" WIDE X 32" TALL
 LOGO COLORS
 SKY - PANTONE 306
 TREE & LANDSCAPE - PANTONE 341
 ROADWAY - WHITE

DIMENSIONS (MILLIMETERS)							
A	B	C	D	E	F	G	H
1200	900	19	56	100C	100	525	800

DIMENSIONS (INCHES)							
A	B	C	D	E	F	G	H
48	36	3/4	2 1/4	4C	4	21	32

COLORS

LEGEND - WHITE (REFL)
 BACKGROUND - BLUE (REFL)

I6-902A

11/97

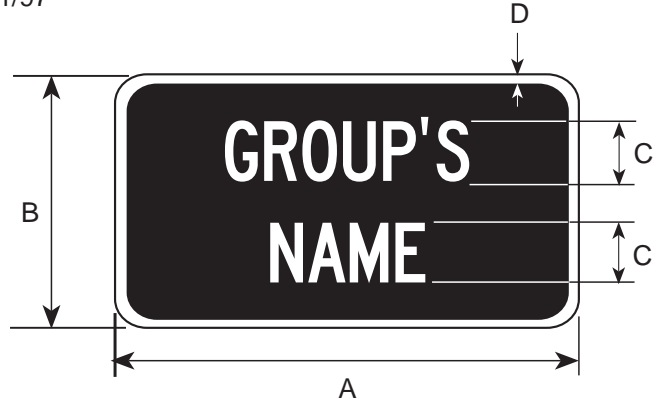
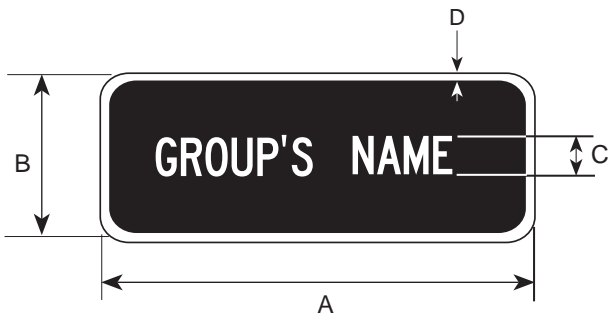

DIMENSIONS (MILLIMETERS)			
A	B	C	D
1200	300	100C	13

DIMENSIONS (MILLIMETERS)			
A	B	C	D
1200	450	100C	13

DIMENSIONS (INCHES)			
A	B	C	D
48	12	4C	1/2

DIMENSIONS (INCHES)			
A	B	C	D
48	18	4C	1/2

20 SPACES PER LINE

I6-903A

11/97

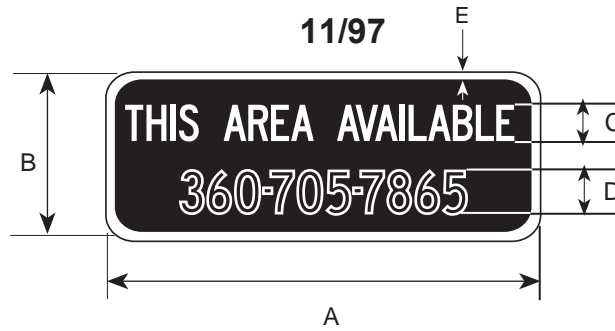

DIMENSIONS (MILLIMETERS)				
A	B	C	D	E
1200	300	75C	100C	13

DIMENSIONS (INCHES)				
A	B	C	D	E
48	12	3C	4C	1/2

COLORS

LEGEND - WHITE (REFL)
BACKGROUND - BLUE (REFL)

I6-904

11/97

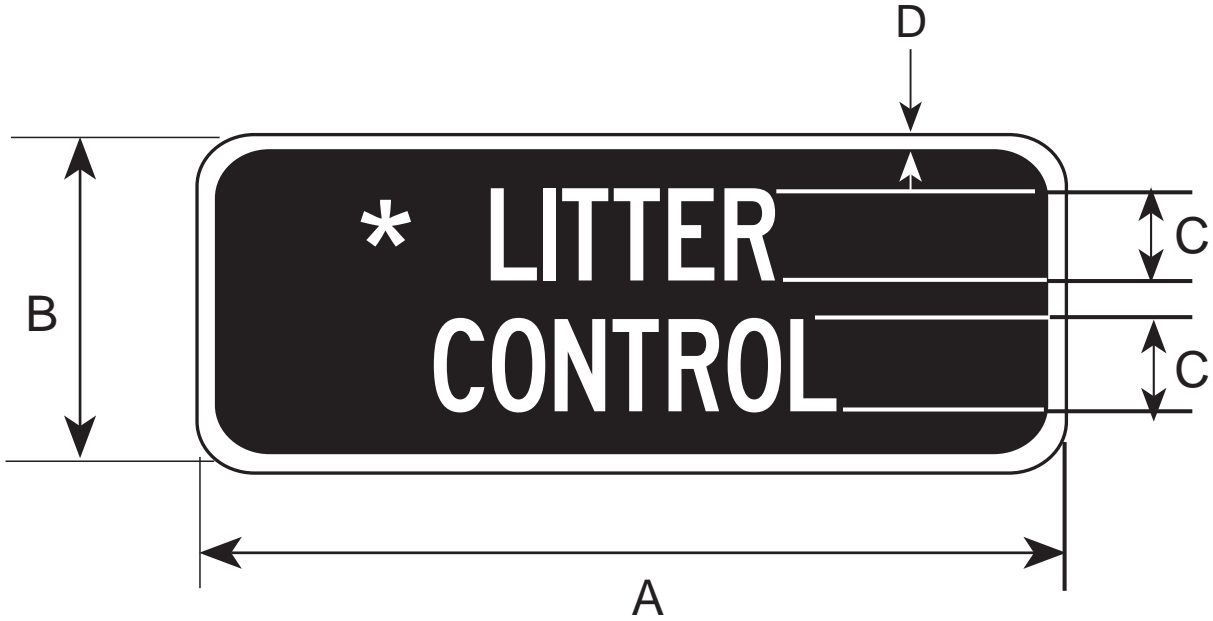

* MAYBE SUBSTITUTED TO READ:
WILDFLOWERS, TREEPLANTING,
OR AS SPECIFIED

DIMENSIONS (MILLIMETERS)			
A	B	C	D
750	300	75C	13

DIMENSIONS (INCHES)			
A	B	C	D
30	12	3C	1/2

COLORS

LEGEND - WHITE (REFL)
BACKGROUND - BLUE (REFL)

I6-905A

11/97

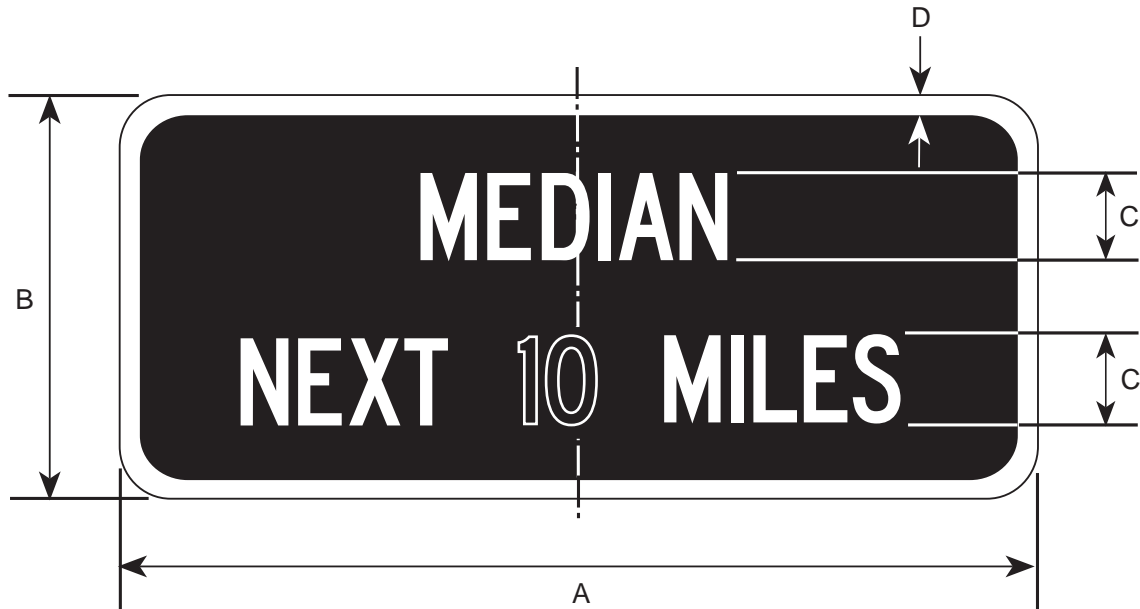

DIMENSIONS (MILLIMETERS)			
A	B	C	D
1200	450	100C	13

DIMENSIONS (INCHES)			
A	B	C	D
48	18	4C	1/2

COLORS

LEGEND - WHITE (REFL)
BACKGROUND - BLUE (REFL)

17-301

11/97

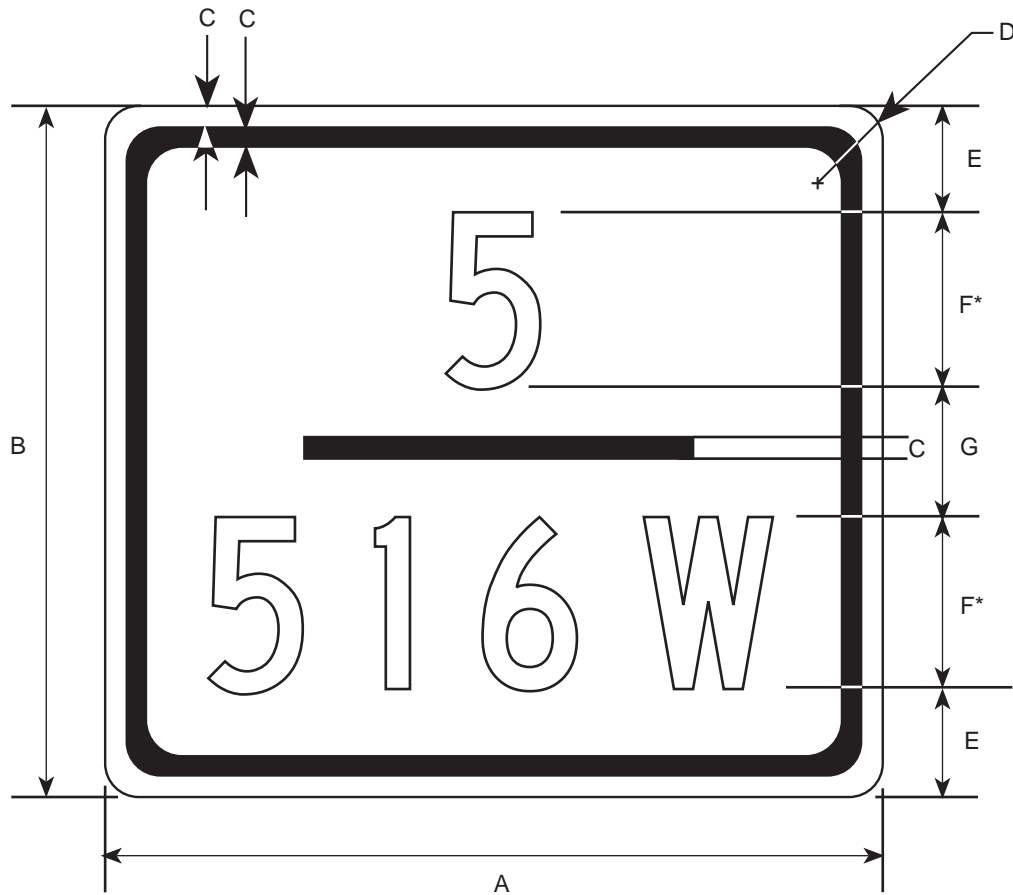

DIMENSIONS (MILLIMETERS)						
A	B	C	D	E	F	G
225	200	6	38	31	50C	38

DIMENSIONS (INCHES)						
A	B	C	D	E	F	G
9	8	1/4	1 1/2	1 1/4	2C	1 1/2

COLORS

LEGEND - BLACK (NON-REFL)
BACKGROUND - WHITE (REFL)

I7-401

11/97

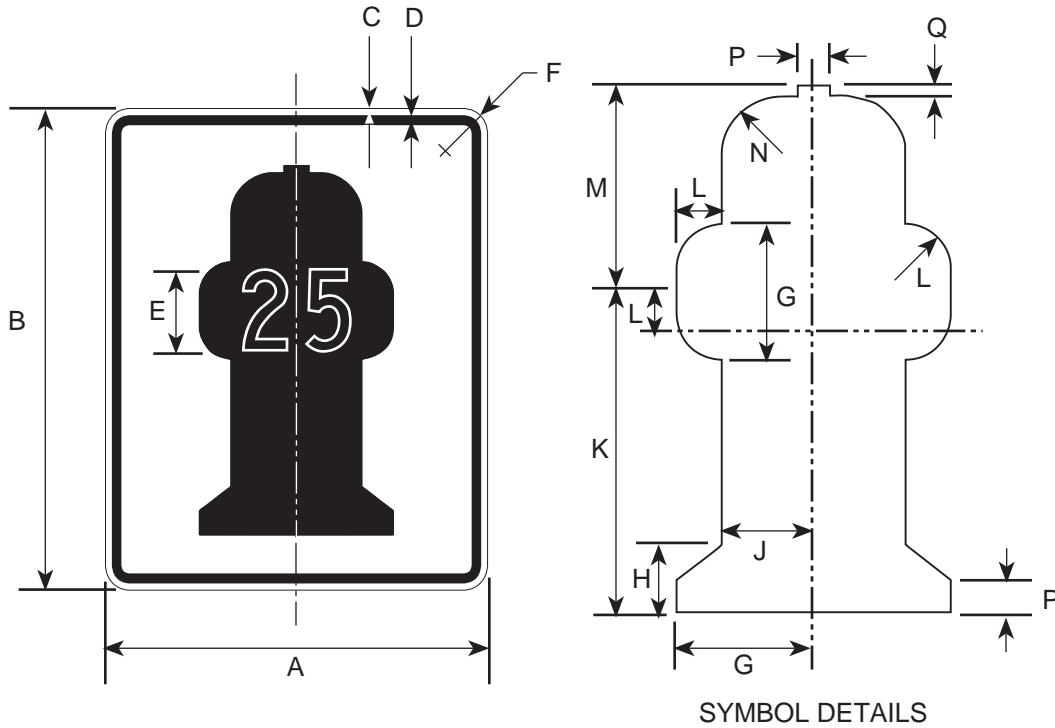

DIMENSIONS (MILLIMETERS)															
A	B	C	D	E	F	G	H	J	K	L	M	N	P	Q	
600	750	10	16	125C	31	150	75	100	325	50	225	63	31	13	

DIMENSIONS (INCHES)															
A	B	C	D	E	F	G	H	J	K	L	M	N	P	Q	
24	30	3/8	5/8	5C	1 1/2	6	3	4	13	2	9	2 1/2	1 1/2	1/2	

COLORS

SYMBOL - RED (REFL)
 BACKGROUND - WHITE (REFL)

I7-501

11/97

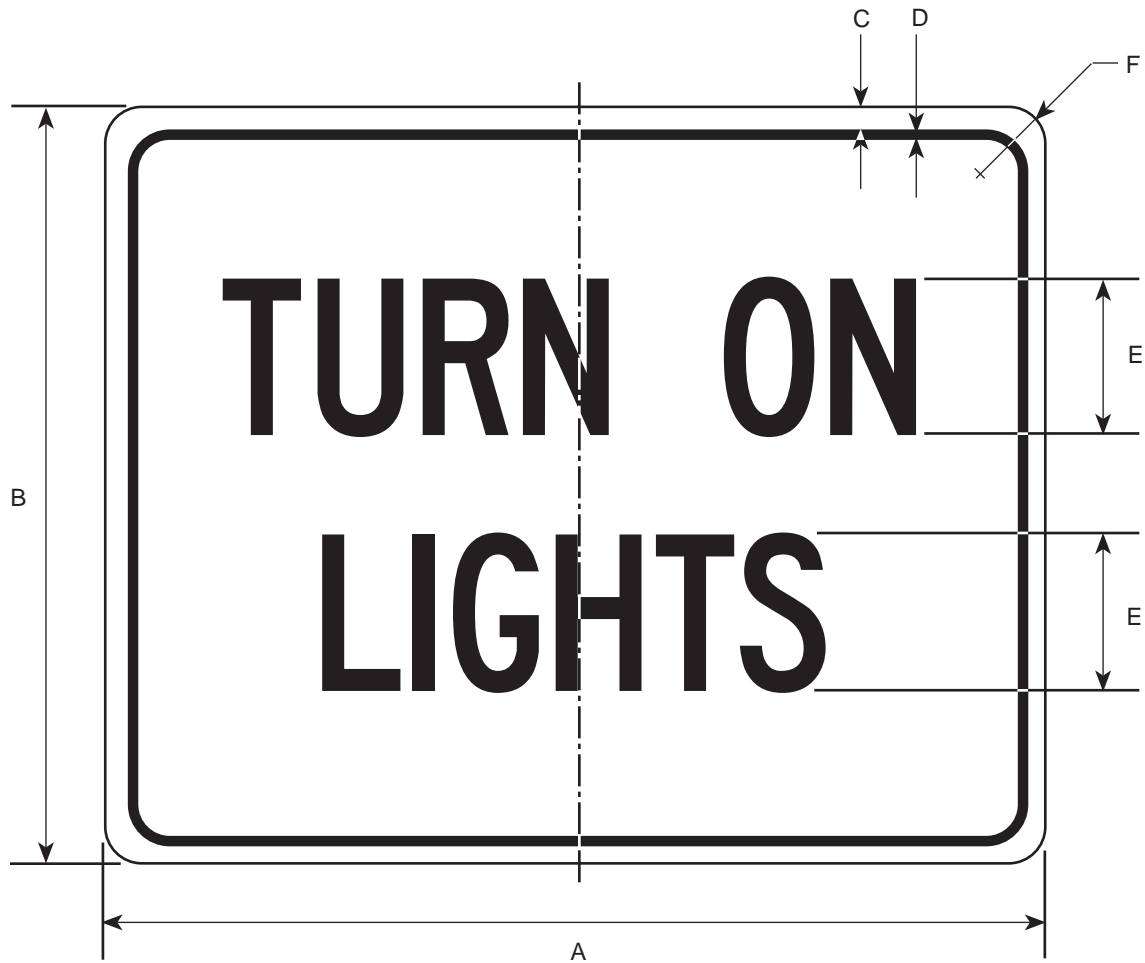

DIMENSIONS (MILLIMETERS)					
A	B	C	D	E	F
750	600	16	9	125C	38

DIMENSIONS (INCHES)					
A	B	C	D	E	F
30	24	5/8	3/8	5C	1 1/2

COLORS

LEGEND - BLACK (NON-REFL)

BACKGROUND - WHITE (NON-REFL)

I7-601

11/97

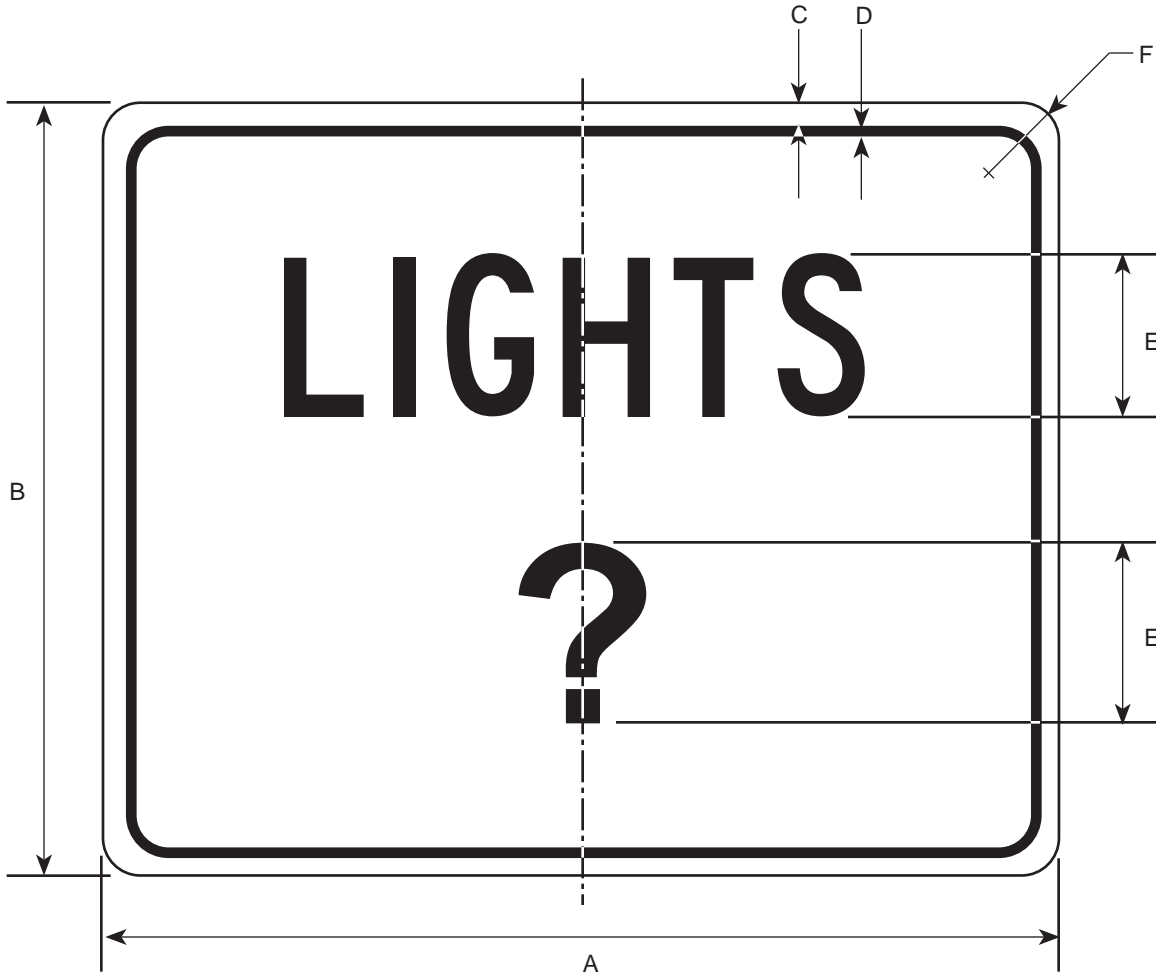

DIMENSIONS (MILLIMETERS)					
A	B	C	D	E	F
750	600	16	9	125C	38

DIMENSIONS (INCHES)					
A	B	C	D	E	F
30	24	5/8	3/8	5C	1 1/2

COLORS

LEGEND - BLACK (NON-REFL)

BACKGROUND - WHITE (NON-REFL)

I7-7

11/97

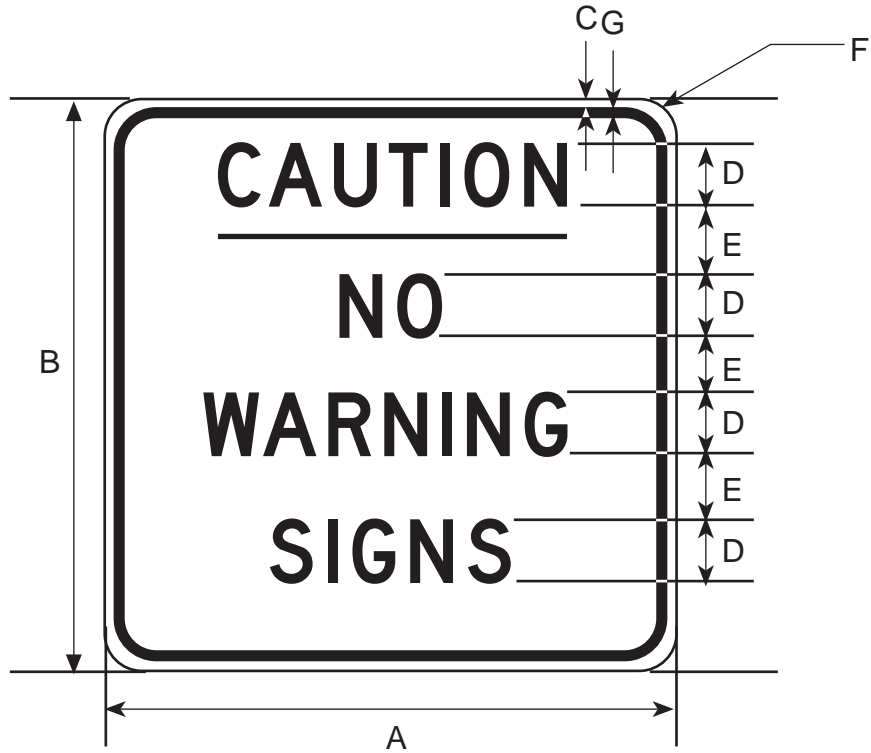

DIMENSIONS (MILLIMETERS)						
A	B	C	D	E	F	G
900	900	9	100D	106	56	16

DIMENSIONS (MILLIMETERS)						
A	B	C	D	E	F	G
36	36	3/8	4D	4.25	2 1/4	5/8

COLOR

LEGEND - BLACK (NON-REFL)
BACKGROUND - WHITE (REFL)

I7-701

11/97



DIMENSIONS (MILLIMETERS)						
A	B	C	D	E	F	G
750	900	13	19	100D	75	47

DIMENSIONS (INCHES)						
A	B	C	D	E	F	G
30	36	1/2	3/4	4D	3	1 7/8

COLORS

LEGEND - BLACK (NON-REFL)
BACKGROUND - WHITE (REFL)

I7-702

11/97

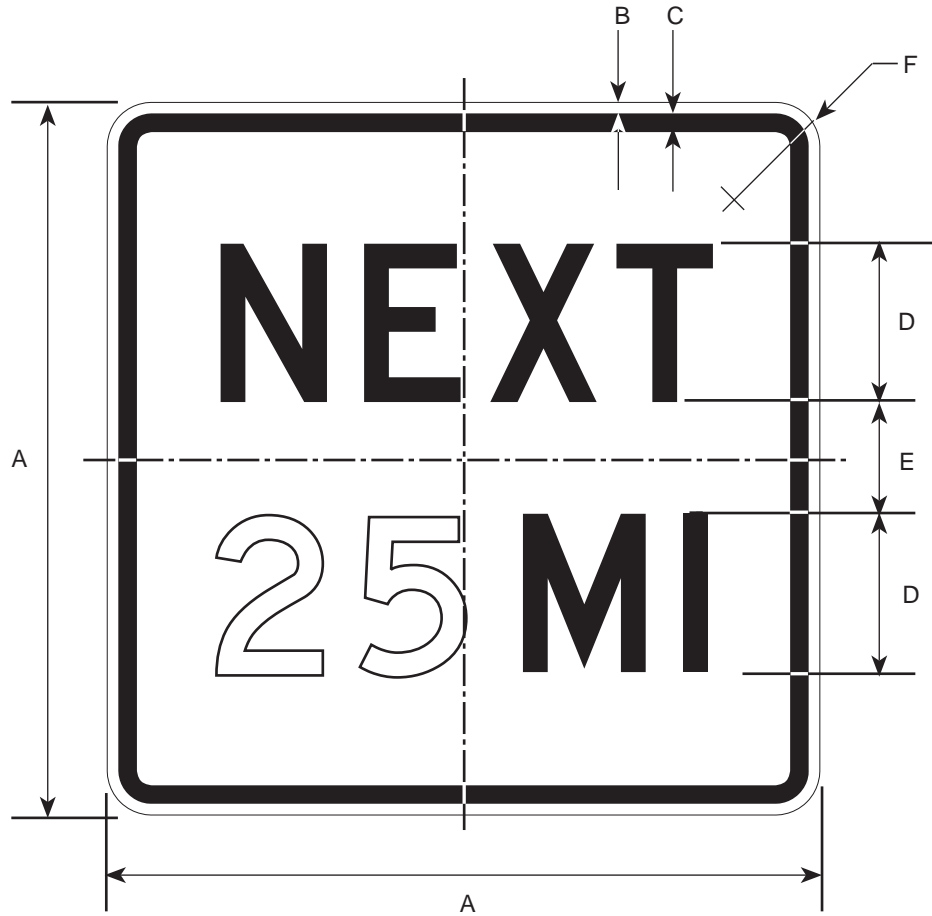

DIMENSIONS (MILLIMETERS)					
A	B	C	D	E	F
450	10	13	100D	75	38

DIMENSIONS (INCHES)					
A	B	C	D	E	F
18	3/8	1/2	4D	3	1 1/2

COLORS

LEGEND - BLACK (NON-REFL)
BACKGROUND - WHITE (REFL)

I7-901

11/97



DIMENSIONS (MILLIMETERS)						
A	B	C	D	E	F	G
900	450	10	16	100C	88	47

DIMENSIONS (INCHES)						
A	B	C	D	E	F	G
36	18	3/8	5/8	4C	3 1/2	1 7/8

COLORS

LEGEND - BLACK (NON-REFL)
BACKGROUND - WHITE (NON-REFL)

I8-101

11/97

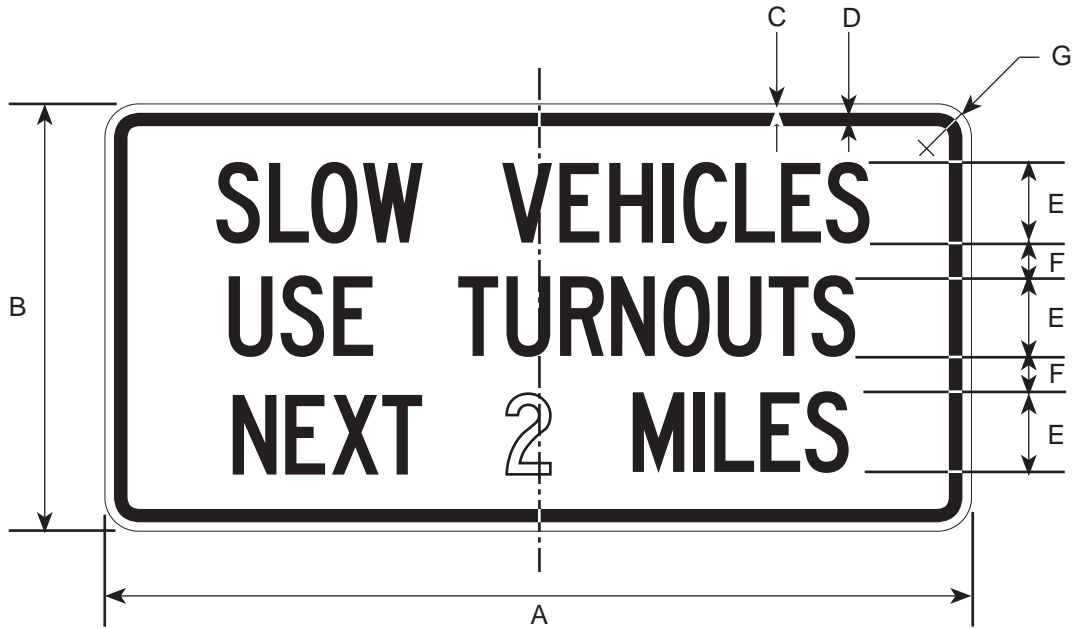

DIMENSIONS (MILLIMETERS)						
A	B	C	D	E	F	G
1800	900	19	31	150C	100	100

DIMENSIONS (INCHES)						
A	B	C	D	E	F	G
72	36	3/4	1 1/4	6C	4	4

COLORS

LEGEND - BLACK (NON-REFL)
BACKGROUND - WHITE (REFL)

I8-201

11/97

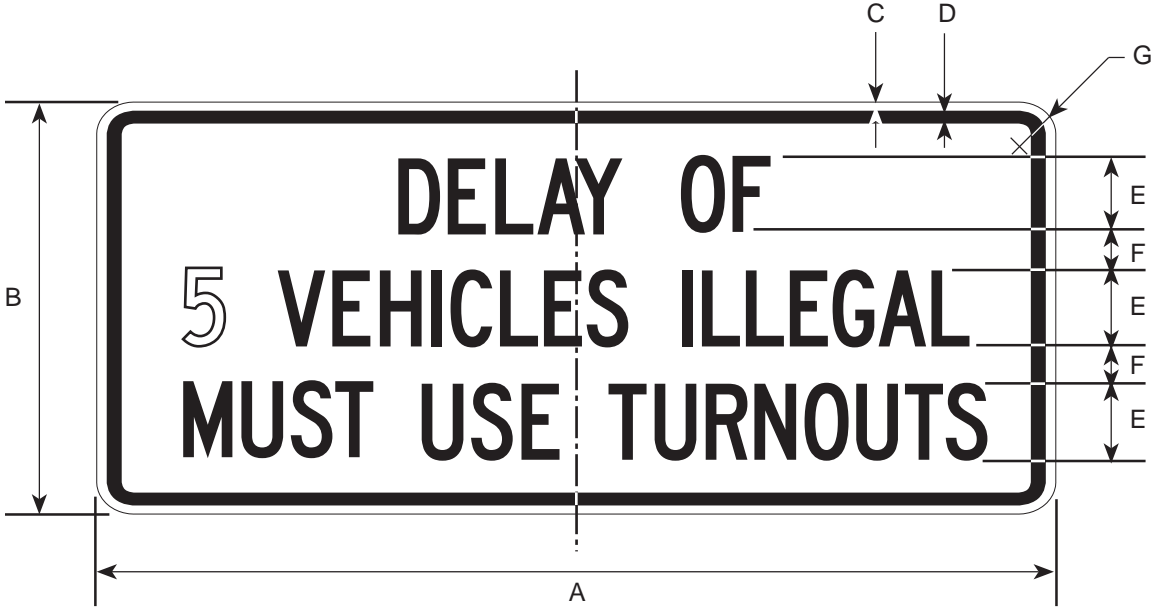

DIMENSIONS (MILLIMETERS)						
A	B	C	D	E	F	G
2100	900	19	31	150C	100	100

DIMENSIONS (INCHES)						
A	B	C	D	E	F	G
84	36	3/4	1 1/4	6C	4	4

COLORS

LEGEND - BLACK (NON-REFL)
 BACKGROUND - WHITE (REFL)

I8-301

1/06

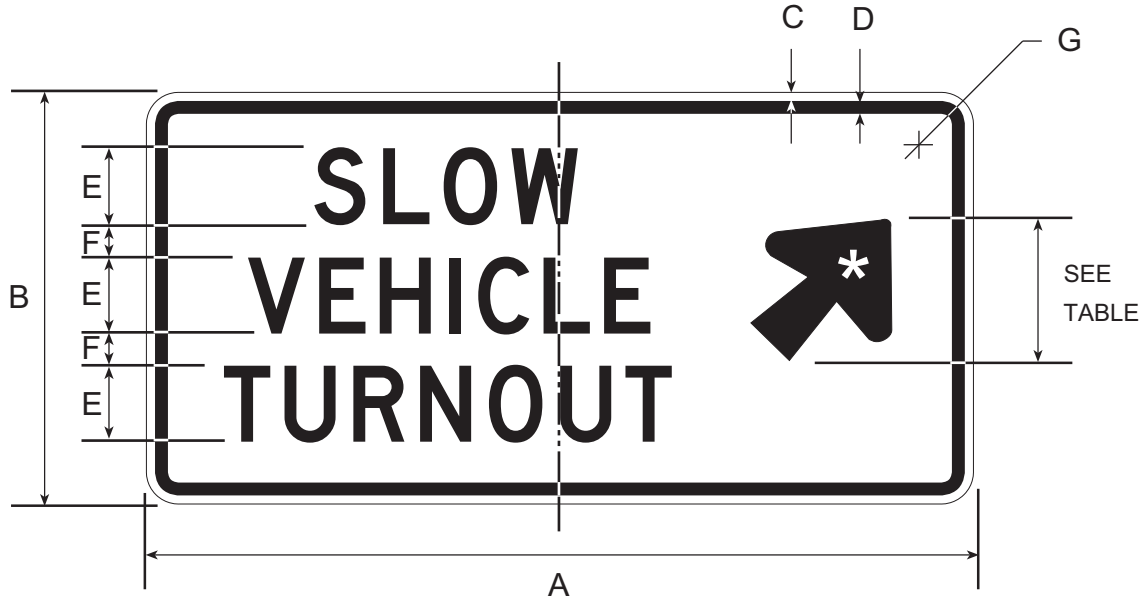

* SEE APPENDIX FOR ARROW DETAILS

DIMENSIONS (MILLIMETERS)							
A	B	C	D	E	F	ARROW SIZE	G
1800	900	19	31	150D	100	NO. 1	100

DIMENSIONS (INCHES)							
A	B	C	D	E	F	ARROW SIZE	G
72	36	3/4	1 1/4	6D	4	NO. 1	4

COLORS

LEGEND — BLACK (NON-REFL)
 BACKGROUND — WHITE (REFL)

I8-401

11/97

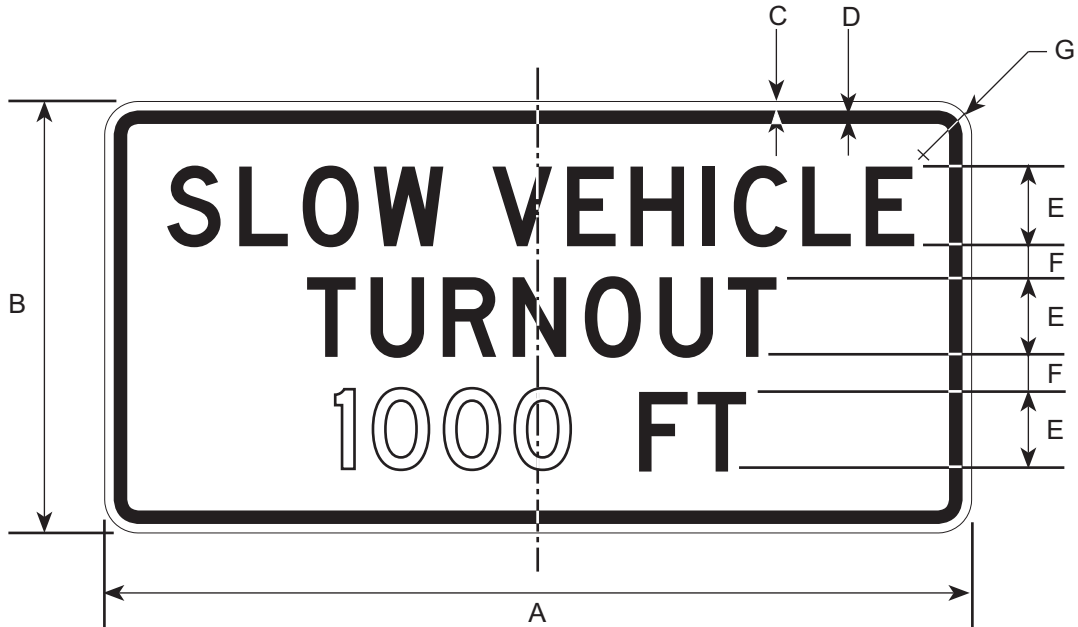

DIMENSIONS (MILLIMETERS)						
A	B	C	D	E	F	G
1800	900	19	31	150D	100	100

DIMENSIONS (INCHES)						
A	B	C	D	E	F	G
72	36	3/4	1 1/4	6D	4	4

COLORS

LEGEND — BLACK (NON-REFL)
 BACKGROUND — WHITE (REFL)

I8-501

11/97

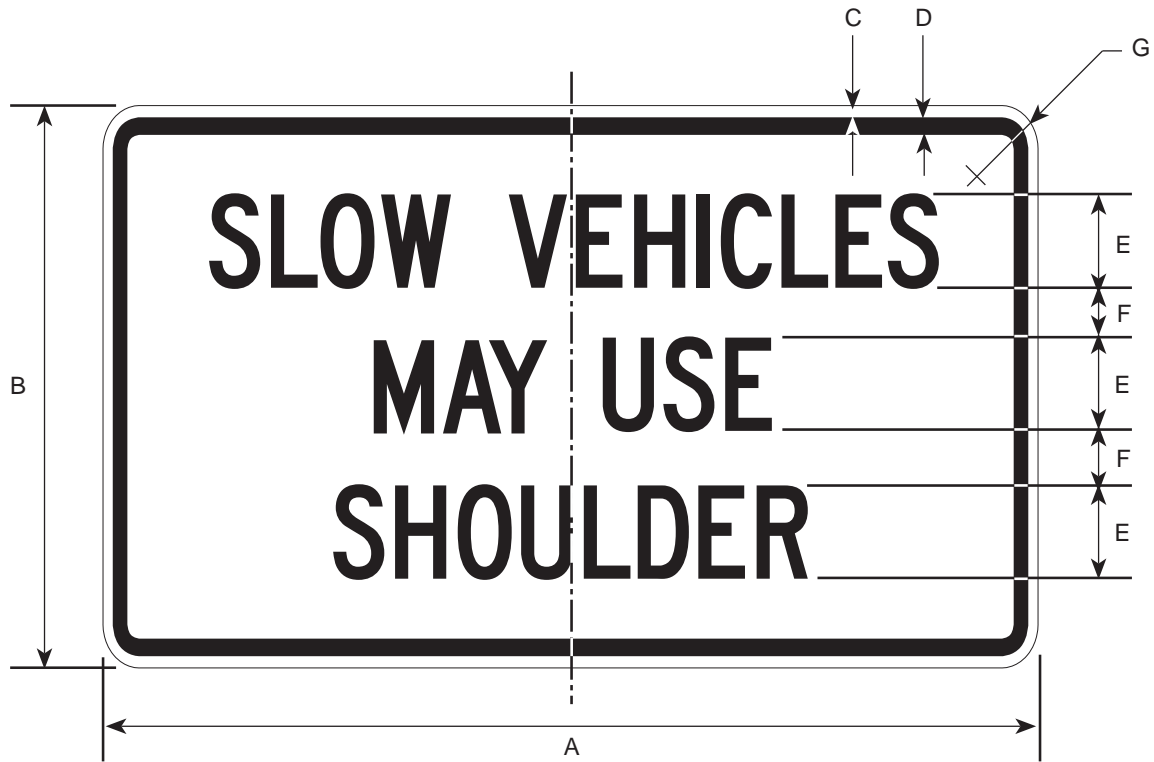

DIMENSIONS (MILLIMETERS)						
A	B	C	D	E	F	G
1500	900	13	19	150C	100	100
2100	1200	19	31	200C	150	150

DIMENSIONS (INCHES)						
A	B	C	D	E	F	G
60	36	1/2	3/4	6C	4	4
84	48	3/4	1 1/4	8C	6	6

COLORS

LEGEND - BLACK (NON-REFL)
BACKGROUND - WHITE (REFL)

I8-601

11/97

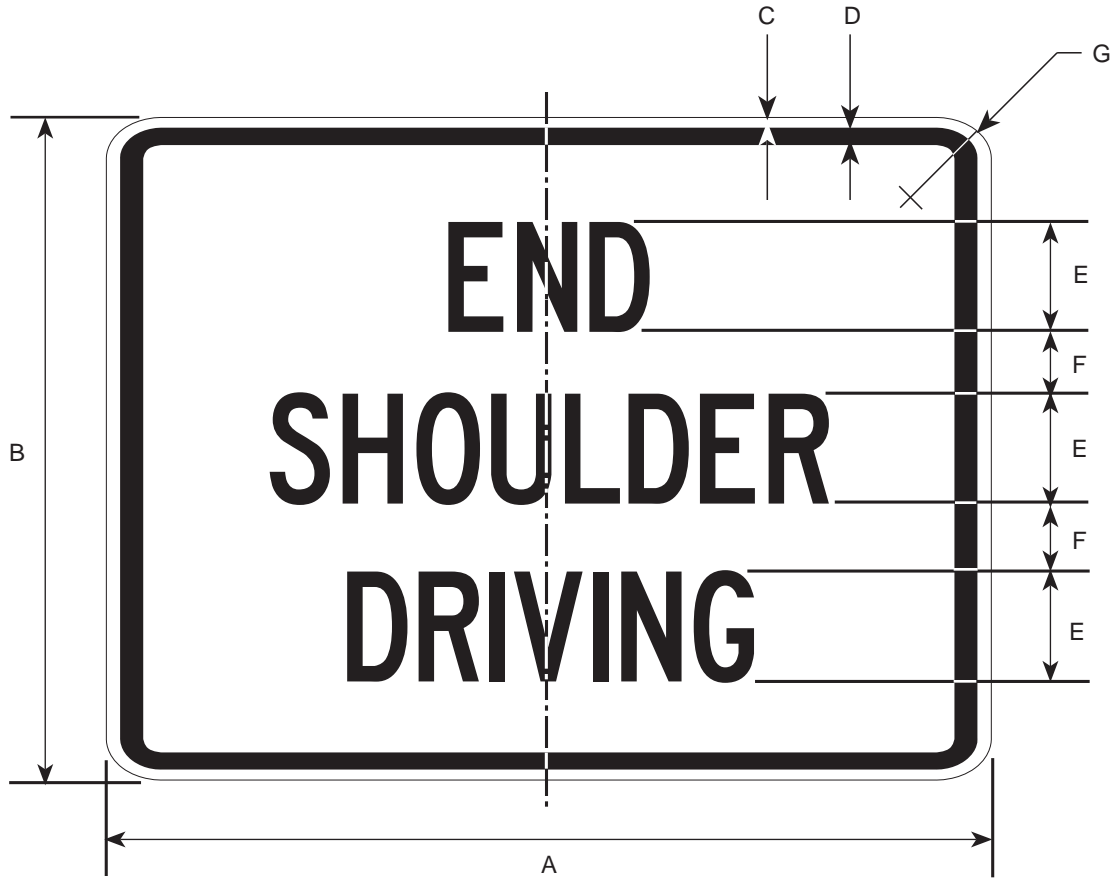

DIMENSIONS (MILLIMETERS)						
A	B	C	D	E	F	G
1200	900	16	22	150C	100	56
1500	1200	19	31	200C	150	75

DIMENSIONS (INCHES)						
A	B	C	D	E	F	G
48	36	5/8	7/8	6C	4	2 1/4
60	48	3/4	1 1/4	8C	6	3

COLORS

LEGEND - BLACK (NON-REFL)
BACKGROUND - WHITE (REFL)

I8-701

11/97



DIMENSIONS (MILLIMETERS)						
A	B	C	D	E	F	G
750	300	10	16	75C	31	38
1050	600	13	19	125C	100	47
1500	900	16	22	175C	150	56

DIMENSIONS (INCHES)						
A	B	C	D	E	F	G
30	12	3/8	5/8	3C	1 1/2	1 1/2
42	24	1/2	3/4	5C	4	1 7/8
60	36	5/8	7/8	7C	6	2 1/4

COLORS

LEGEND - BLACK (NON-REFL)

BACKGROUND - WHITE (REFL)

I8-702

11/97

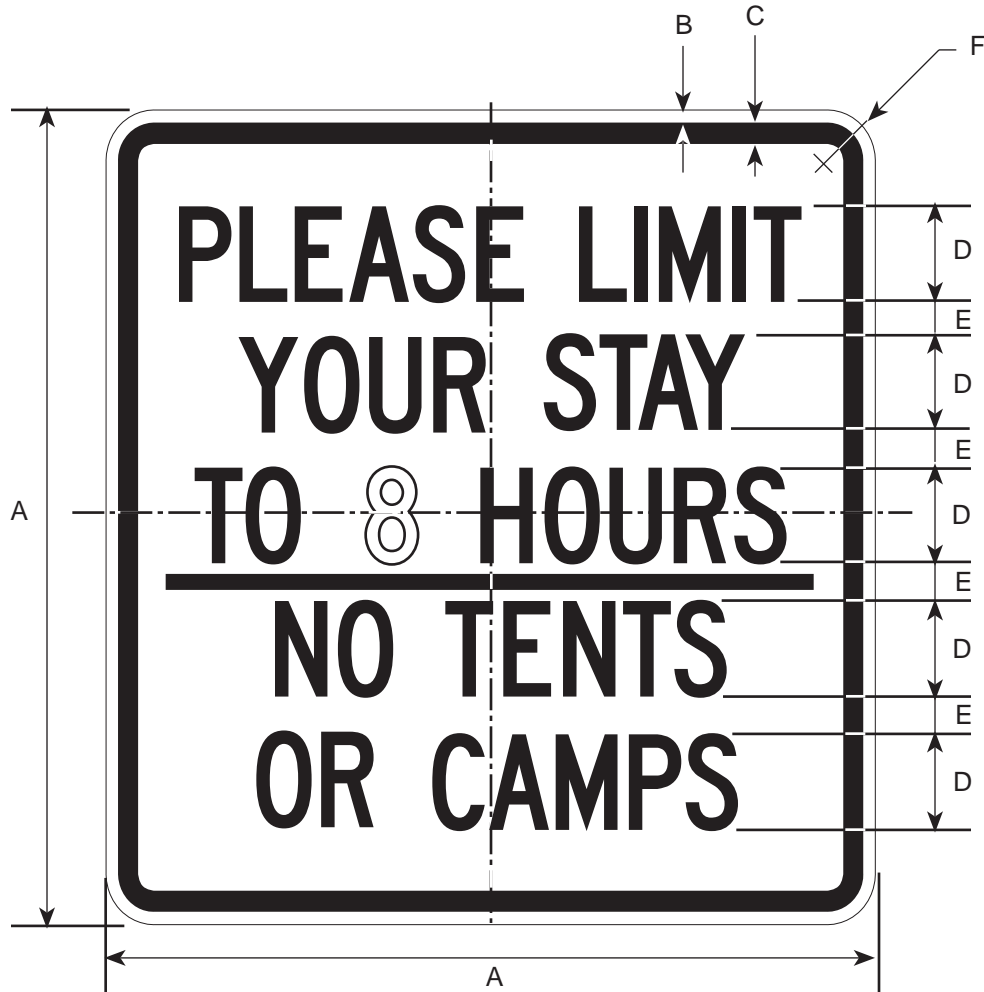

DIMENSIONS (MILLIMETERS)					
A	B	C	D	E	F
900	10	16	100C	50	56

DIMENSIONS (INCHES)					
A	B	C	D	E	F
36	3/8	5/8	4C	2	2 1/4

COLORS

LEGEND - BLACK (NON-REFL)
BACKGROUND - WHITE (REFL)

18-703

6/00

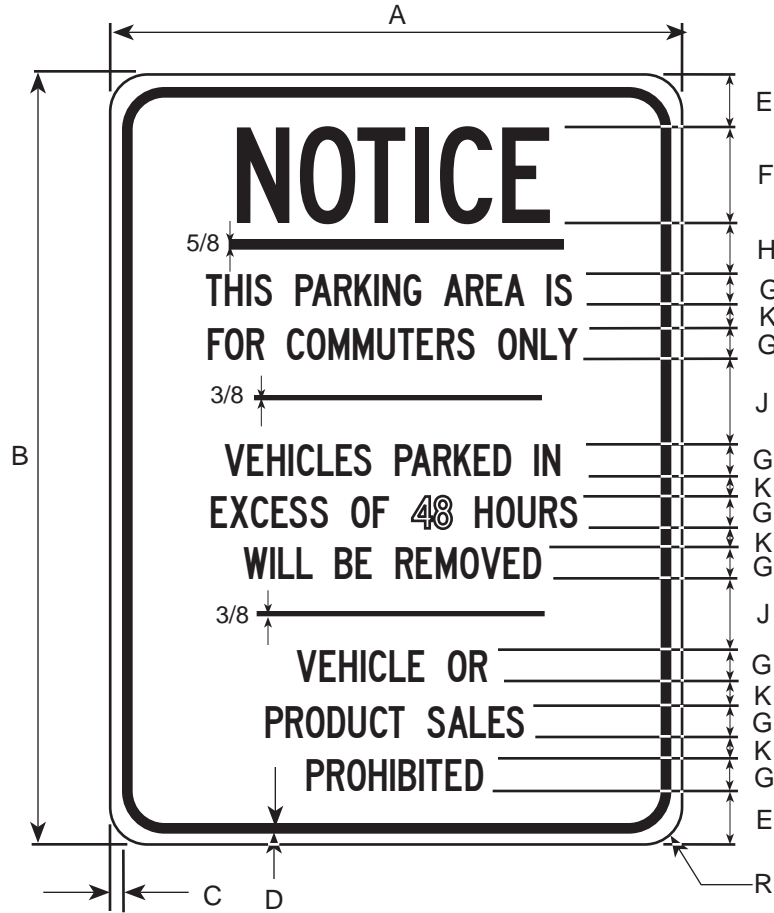

DIMENSIONS (MILLIMETERS)										
A	B	C	D	E	F	G	H	J	K	R
450	600	9	16	63	75C	25C	30	37	19	38

DIMENSIONS (INCHES)										
A	B	C	D	E	F	G	H	J	K	R
18	24	3/8	5/8	2 1/2	3C	1C	1 1/4	1 1/2	3/4	1 1/2

COLORS

LEGEND - BLACK (NON-REFL.)
 BACKGROUND - WHITE (REFL.)

I8-704

11/97



DIMENSIONS (MILLIMETERS)					
A	B	C	D	E	F
450	300	13	6	50C	38

DIMENSIONS (MILLIMETERS)					
A	B	C	D	E	F
18	12	1/2	1/4	2C	1 1/2

COLORS

LEGEND - BLACK (NON-REFL)

BACKGROUND - WHITE (REFL)

18-705

6/00

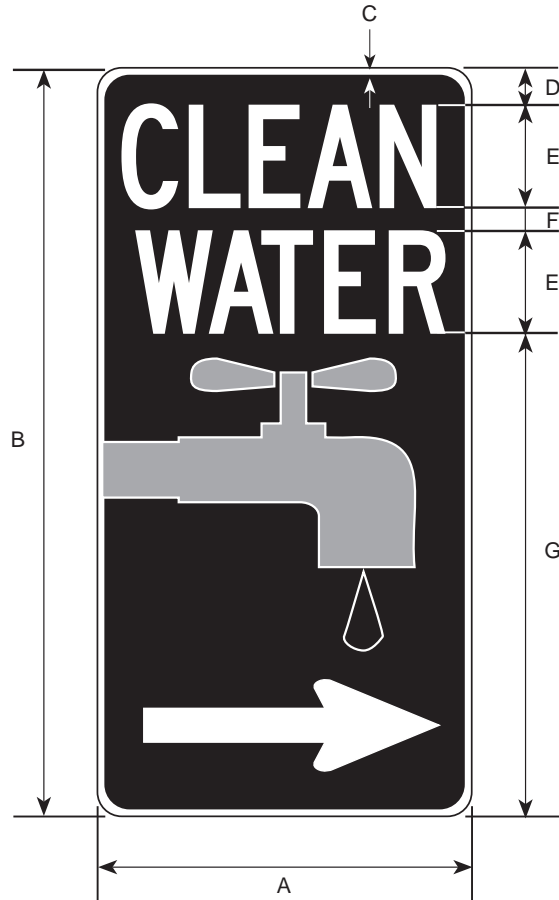

* SEE APPENDIX FOR STANDARD ARROW AND FAUCET DETAILS

DIMENSIONS (MILLIMETERS)						
A	B	C	D	E	F	G
150	300	6	20	50C	13	167
300	600	9	43	50E	13	444

DIMENSIONS (INCHES)						
A	B	C	D	E	F	G
6	12	1/4	7/8	2C	1/2	6 5/8
12	24	3/8	1 3/4	2E	1/2	17 3/4

COLORS

LEGEND - WHITE (NON-REFL)

BACKGROUND - BLUE (REFL)

18-706

11/97

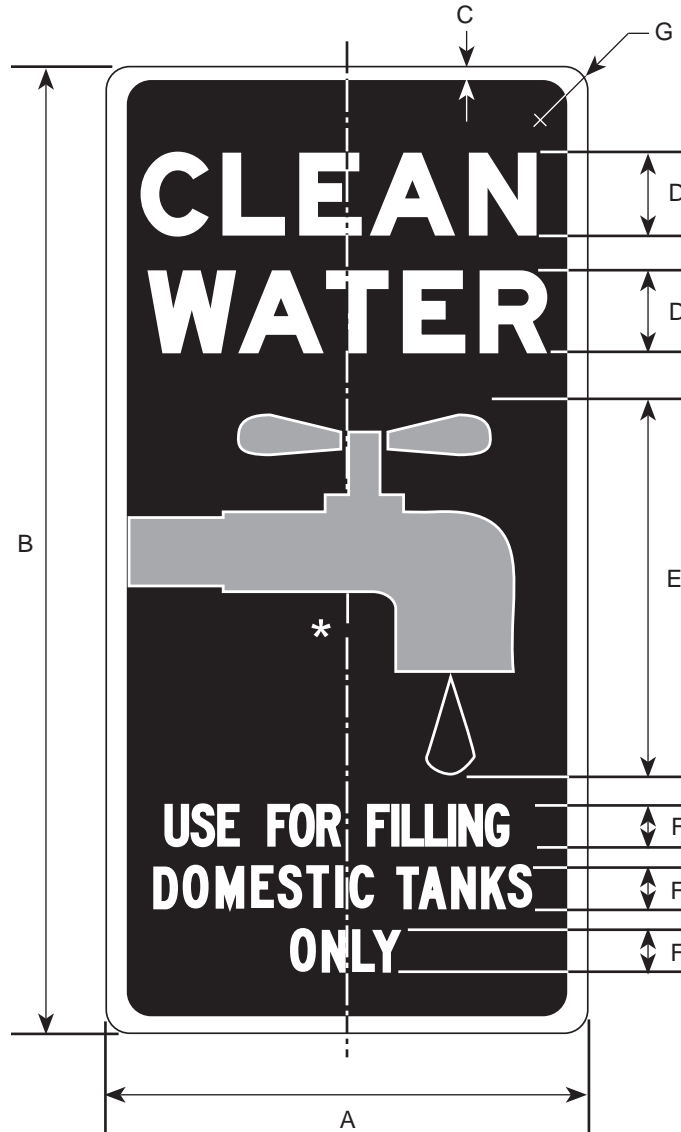

* SEE APPENDIX FOR STANDARD FAUCET DETAILS

DIMENSIONS (MILLIMETERS)						
A	B	C	D	E	F	G
300	600	9	50E	250	25C	38

DIMENSIONS (INCHES)						
A	B	C	D	E	F	G
12	24	3/8	2E	10	1C	1 1/2

COLORS

LEGEND - WHITE (NON-REFL)

BACKGROUND - BLUE (REFL)

18-708

2/06

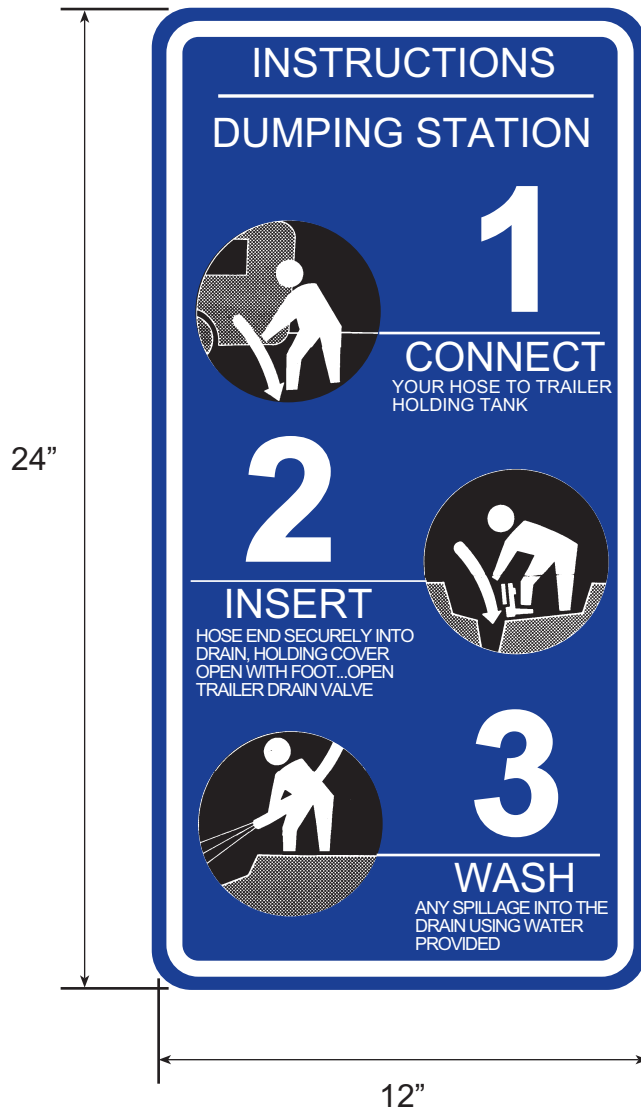

NOTE: CONTACT STATE SIGN SHOP FOR DETAILS

COLORS

LEGEND - WHITE (REFL)
BACKGROUND - BLUE (REFL)

18-709

11/97

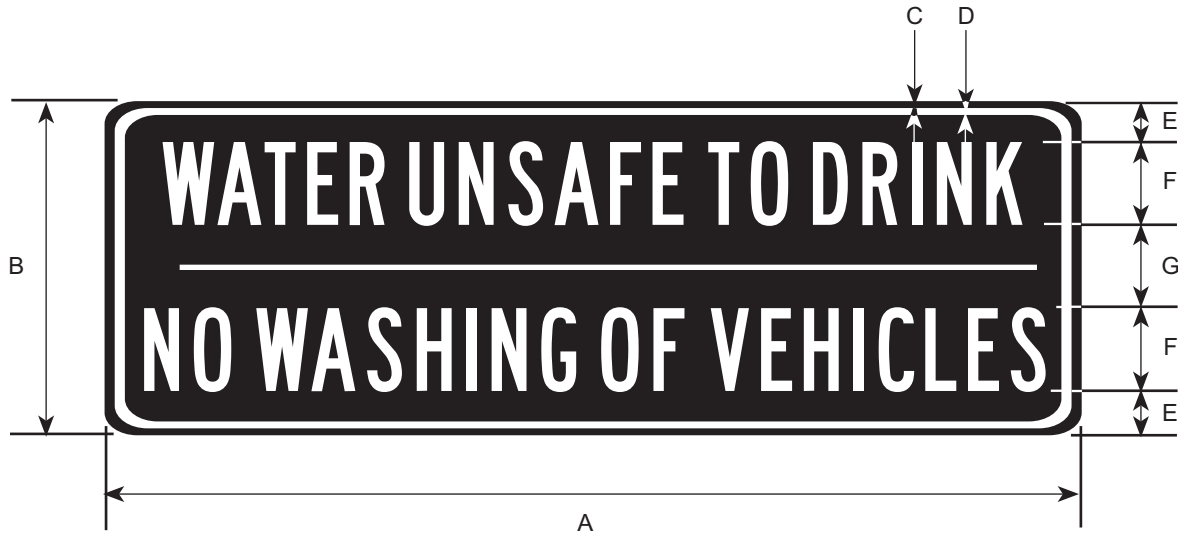

DIMENSIONS (MILLIMETERS)						
A	B	C	D	E	F	G
300	150	6	6	25	25C	50

DIMENSIONS (INCHES)						
A	B	C	D	E	F	G
12	6	1/4	1/4	1	1C	2

COLORS

LEGEND — WHITE (REFL)
BACKGROUND — BLUE (REFL)

I8-801

11/97

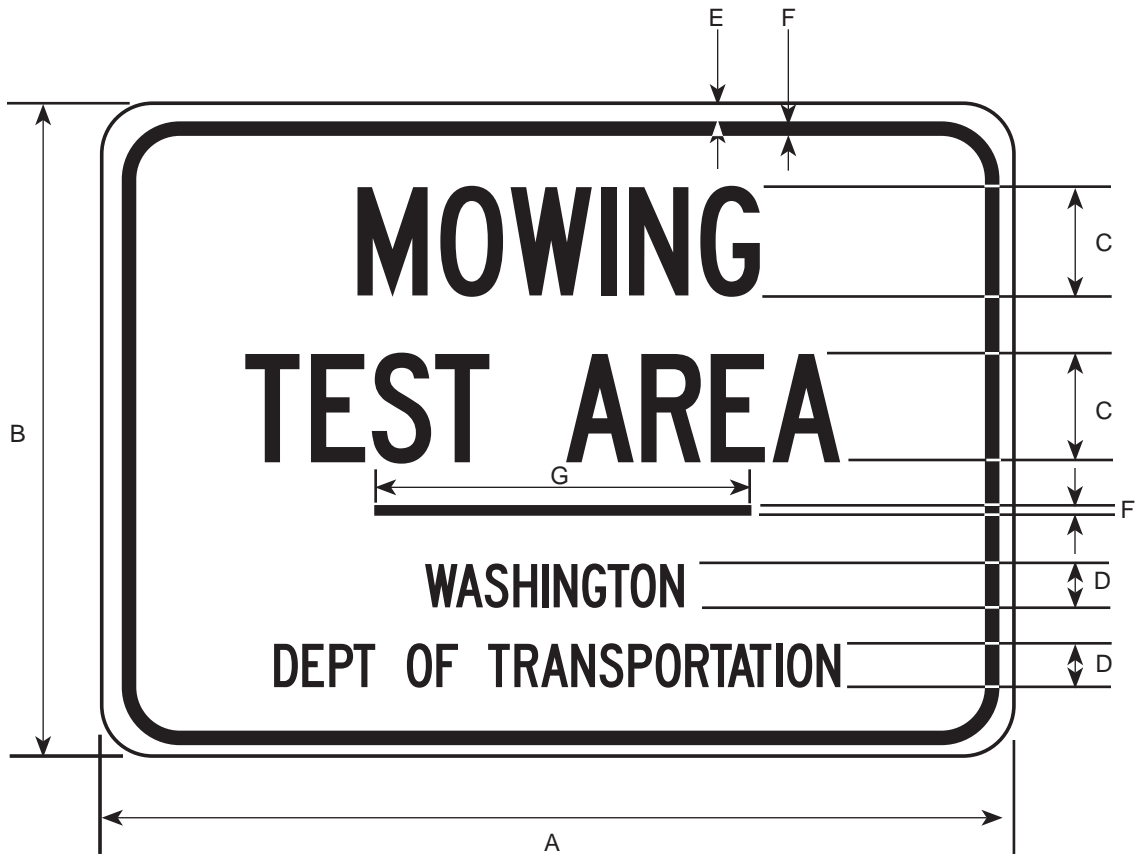

DIMENSIONS (MILLIMETERS)						
A	B	C	D	E	F	G
900	750	125C	50C	19	38	400

DIMENSIONS (INCHES)						
A	B	C	D	E	F	G
36	30	5C	2C	3/4	1 1/2	16

COLORS

LEGEND - BLACK (NON-REFL)

BACKGROUND - WHITE (REFL)

18-804

3/97



DIMENSIONS (MILLIMETERS)				
A	B	C	D	E
600	750	9	100C	100

DIMENSIONS (INCHES)				
A	B	C	D	E
24	30	3/8	4C	4

COLORS

LEGEND - WHITE (REFL)
BACKGROUND - BLUE (REFL)

18-901

2/98

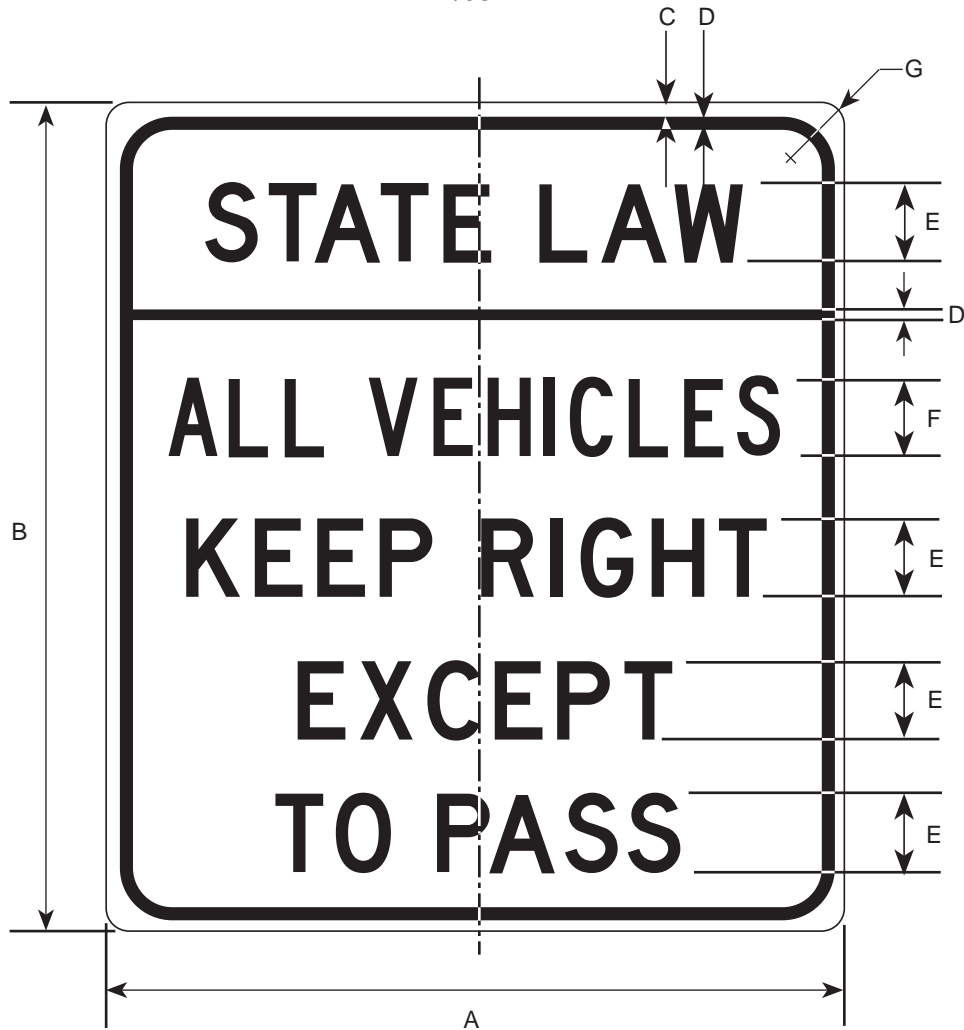

DIMENSIONS (MILLIMETERS)						
A	B	C	D	E	F	G
1800	2100	19	31	200D	200C	38

DIMENSIONS (INCHES)						
A	B	C	D	E	F	G
72	84	3/4	1 1/4	8D	8C	1 1/2

COLORS

LEGEND - BLACK (NON-REFL)
 BACKGROUND - WHITE (REFL)

I8-1001

11/97



DIMENSIONS (MILLIMETERS)								
A	B	C	D	E	F	G	H	J
900	1200	16	22	150E	150C	100B	150B	100

DIMENSIONS (INCHES)								
A	B	C	D	E	F	G	H	J
36	48	5/8	7/8	6E	6C	4B	6B	4

COLORS

LEGEND - BLACK (NON-REFL)
 BACKGROUND - WHITE (REFL)

I9-101

11/97

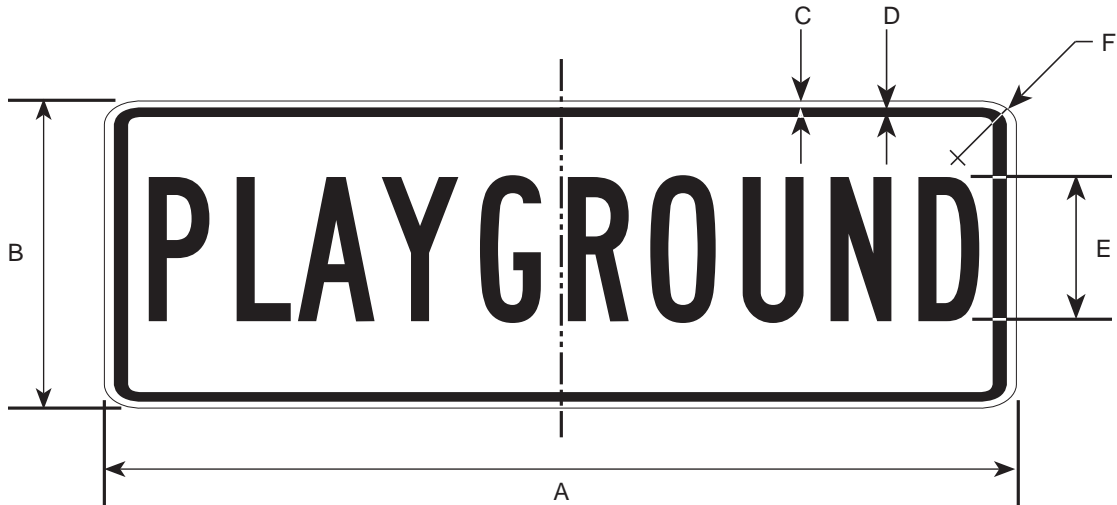

DIMENSIONS (MILLIMETERS)					
A	B	C	D	E	F
600	200	10	16	100B	31

DIMENSIONS (INCHES)					
A	B	C	D	E	F
24	8	3/8	5/8	4B	1 1/2

COLORS

LEGEND - BLACK (NON-REFL)
BACKGROUND - YELLOW (REFL)

I20-201

11/97

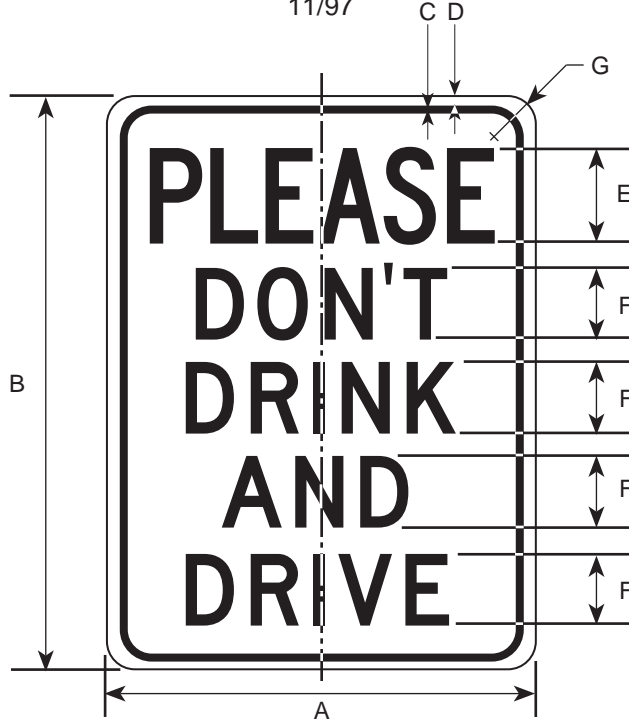

I20-203



I20-204



* ALL MEASUREMENTS NOT LISTED ON I20-203 & 204 SAME AS CORRESPONDING MEASUREMENTS ON I20-201.

DIMENSIONS (MILLIMETERS)									
A	B	C	D	E	F	G	H	J	K
900	1200	16	22	200C	150D	100	300	50C	75C
1200	1500	16	22	250C	200D	125	300	75C	100C

DIMENSIONS (INCHES)									
A	B	C	D	E	F	G	H	J	K
36	48	7/8	5/8	8C	6D	4	12	2C	3C
48	60	7/8	5/8	10C	8D	5	12	3C	4C

COLORS

LEGEND - BLACK (NON-REFL)

BACKGROUND - WHITE (REFL)

I20-301

11/97



* SPACING REDUCED ON LINES NOTED

DIMENSIONS (MILLIMETERS)								
A	B	C	D	E	F	G	H	J
1200	1500	22	16	250D	150C	175D	100E	100

DIMENSIONS (INCHES)								
A	B	C	D	E	F	G	H	J
48	60	7/8	5/8	10D	6C	7D	4E	4

COLORS

LEGEND - BLACK (NON-REFL)
BACKGROUND - WHITE (REFL)

I25-101

2/06

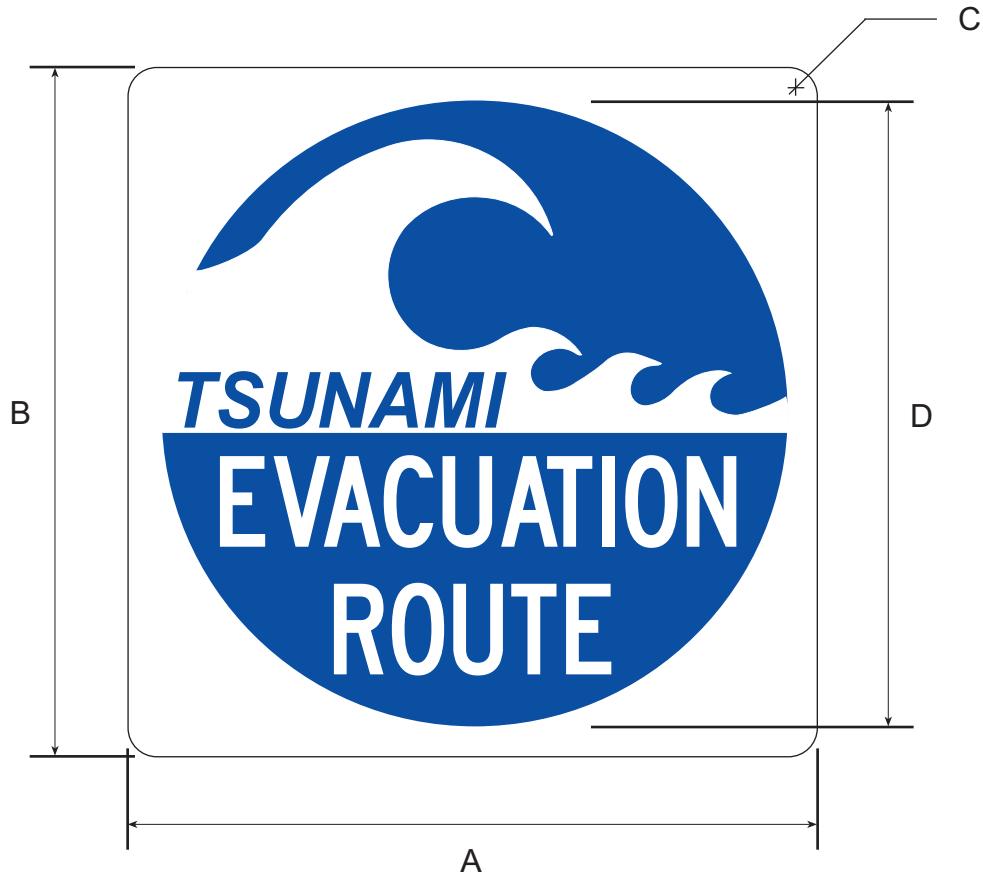

DIMENSIONS (MM)			
A	B	C	D
600	600	38	550

DIMENSIONS (INCHES)			
A	B	C	D
24	24	1 1/2	22

NOTE: CONTACT STATE SIGN SHOP FOR DETAILS

COLORS

LEGEND — WHITE (REFL)
 BACKGROUND — BLUE (REFL) & WHITE (REFL)

I25-102

6/00

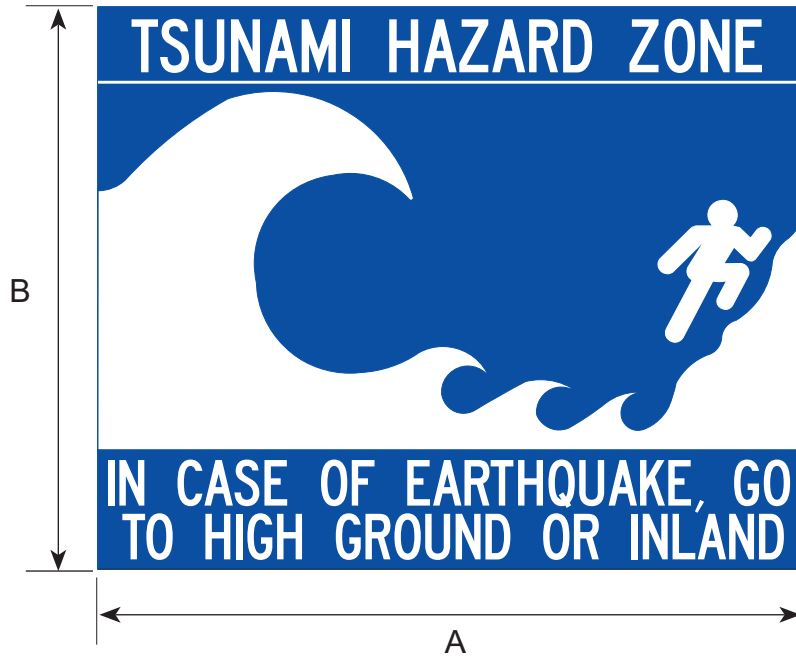

DIMENSIONS (MILLIMETERS)	
A	B
750	600

DIMENSIONS (INCHES)	
A	B
30	24

NOTE: CONTACT STATE SIGN SHOP FOR DETAILS

COLORS

LEGEND — WHITE (REFL)
BACKGROUND — BLUE (REFL)

I25-201

1/06



DIMENSIONS (MM)			
A	B	C	D
600	600	38	550

DIMENSIONS (INCHES)			
A	B	C	D
24	24	1 1/2	22

NOTE: CONTACT STATE SIGN SHOP FOR DETAILS

COLORS

LEGEND — WHITE (REFL)
BACKGROUND — BLUE (REFL)

I30-101

11/97

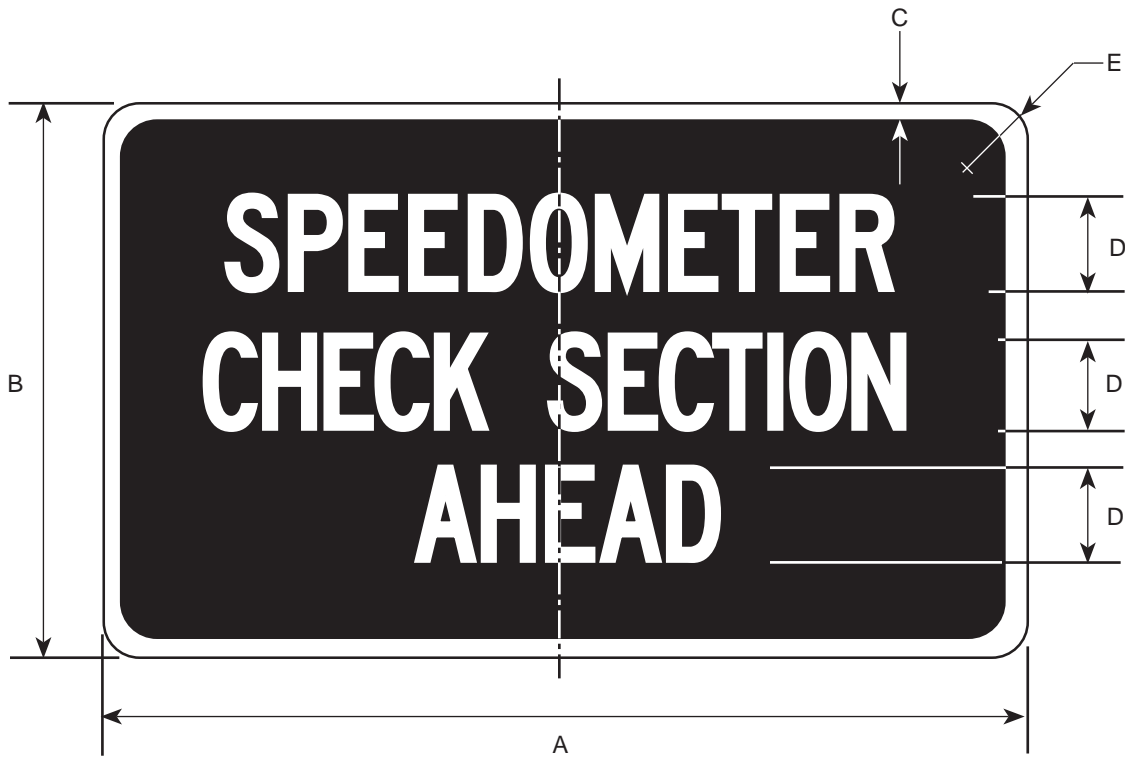

DIMENSIONS (MILLIMETERS)				
A	B	C	D	E
1500	900	50	150C	100

DIMENSIONS (INCHES)				
A	B	C	D	E
60	36	2	6C	4

COLORS

LEGEND - WHITE (NON-REFL)
BACKGROUND - BLACK (NON-REFL)

I30-301 & I30-301A

11/97

I30-301

I30-301A

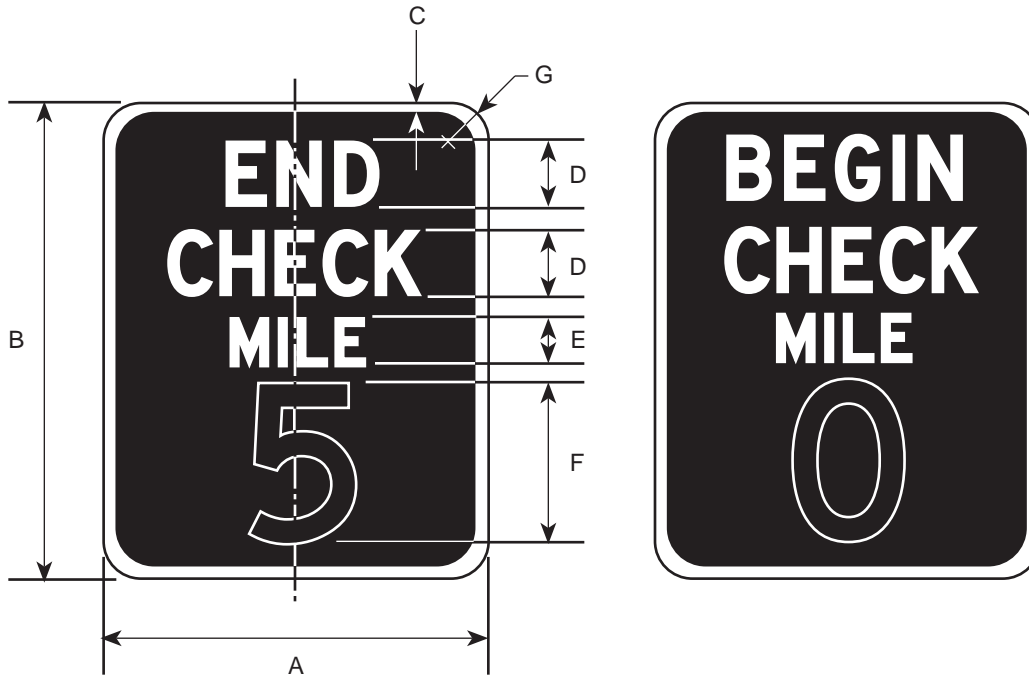

DIMENSIONS (MILLIMETERS)						
A	B	C	D	E	F	G
600	750	13	100D	75D	250D	38

DIMENSIONS (INCHES)						
A	B	C	D	E	F	G
24	30	1/2	4D	3D	10D	1 1/2

COLORS

LEGEND - WHITE (NON-REFL)
 BACKGROUND - BLACK (NON-REFL)

I30-401

11/97

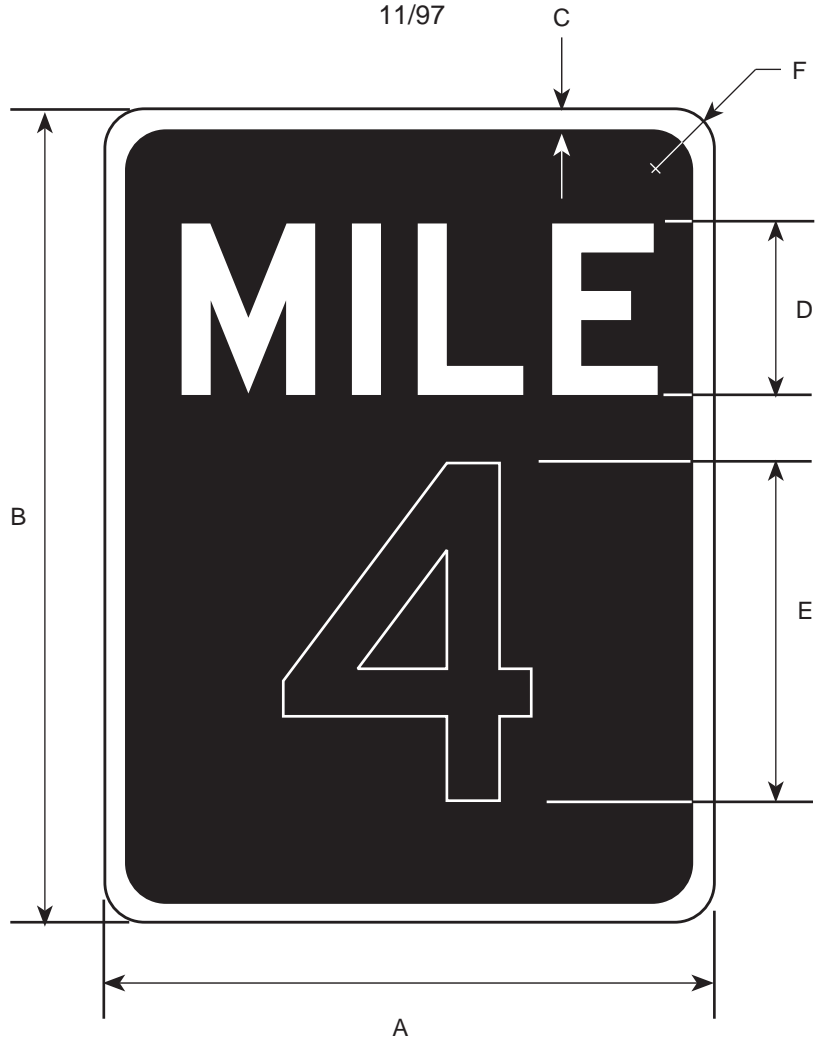

DIMENSIONS (MILLIMETERS)					
A	B	C	D	E	F
450	600	13	125D	250D	38

DIMENSIONS (INCHES)					
A	B	C	D	E	F
18	24	1/2	5D	10D	1 1/2

COLORS

LEGEND - WHITE (NON-REFL)
 BACKGROUND - BLACK (NON-REFL)

I35-101

2/06

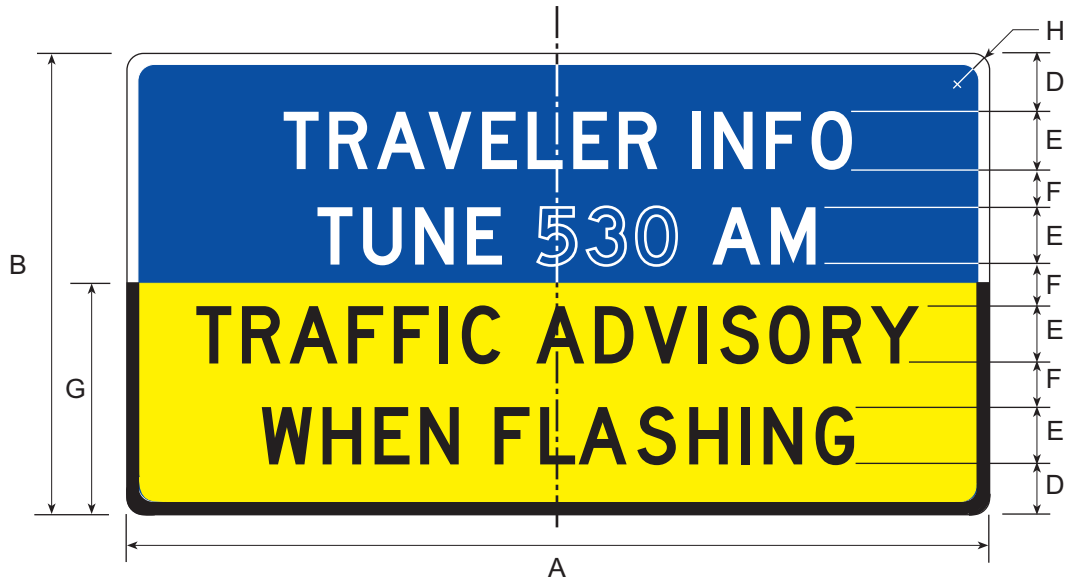

DIMENSIONS (MILLIMETERS)							
A	B	C	D	E	F	G	H
2400	1200	25	150	150D	100	600	150
3000	1800	38	200	200D	150	900	225
3900	2100	38	250	250D	200	1050	263
4500	2400	50	300	300D	200	1200	300

DIMENSIONS (INCHES)							
A	B	C	D	E	F	G	H
96	48	1	6	6D	4	24	6
120	72	1 1/2	8	8D	6	36	9
156	84	1 1/2	10	10D	8	42	10 1/2
180	96	2	12	12D	8	48	12

COLORS

TOP
 LEGEND - WHITE (REFL)
 BACKGROUND - BLUE (REFL)

BOTTOM
 LEGEND - BLACK (NON-REFL)
 BACKGROUND - YELLOW (REFL)

I35-102

8/03



DIMENSIONS (MILLIMETERS)								
A	B	C	D	E	F	G	H	J
1500	900	25	150	150D	300	525	225	100

DIMENSIONS (INCHES)								
A	B	C	D	E	F	G	H	J
60	36	1	6	6D	12	21	9	4

COLORS

LEGEND - WHITE (REFL)
BACKGROUND - BLUE (REFL)

LG-C1

6/00

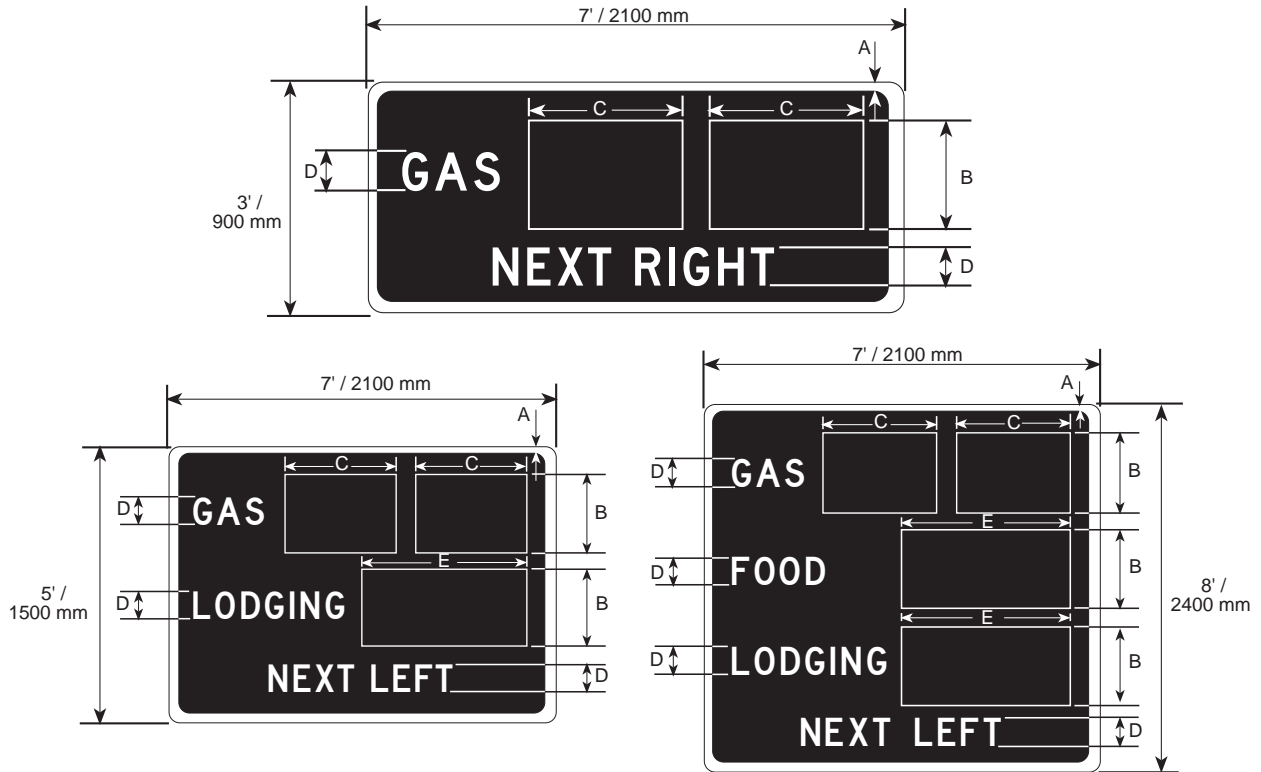

MINIMUM OF 3" BETWEEN BUSINESS SIGNS

DIMENSIONS (MILLIMETERS)				
A	B	C	D	E
25	450	600	150D	900

DIMENSIONS (INCHES)				
A	B	C	D	E
1	18	24	6D	36

TYPICAL SIGN (GAS, FOOD, LODGING) LAYOUTS FOR CONVENTIONAL ROADS.

GAS, FOOD, AND LODGING BACKGROUNDS SHALL BE BLUE REFLECTIVE SHEETING. LEGEND SHALL BE WHITE REFLECTIVE SHEETING.

LG-C2

6/00

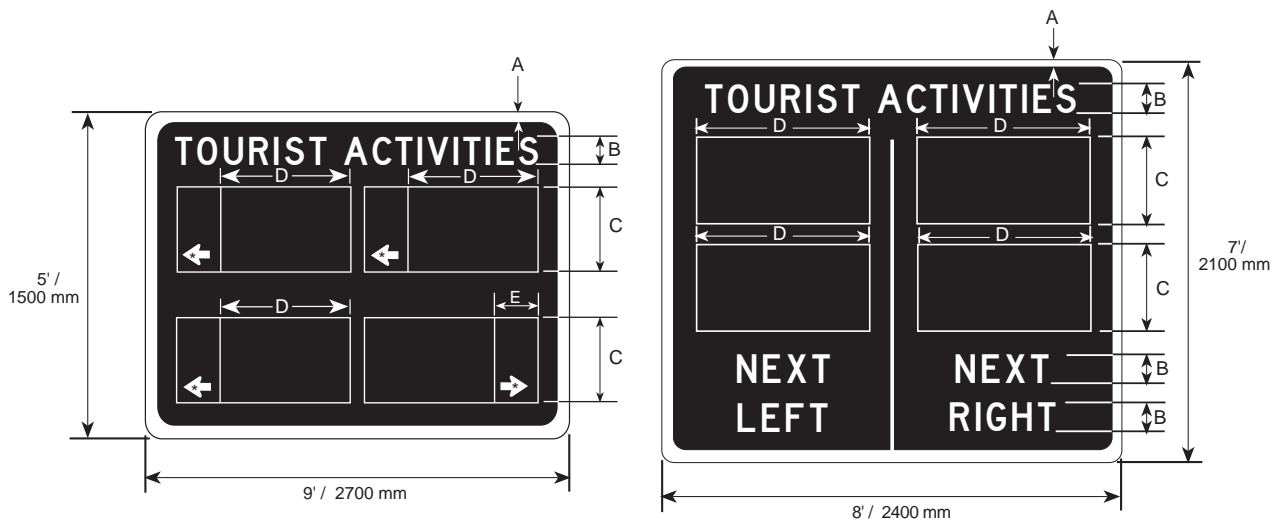
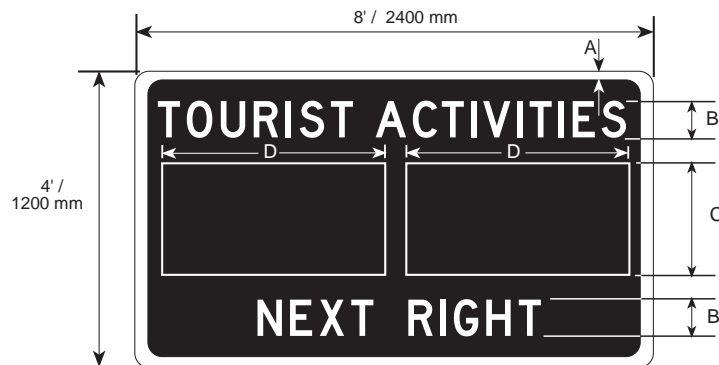

* ARROWS ARE STANDARD 6" X 9"
MINIMUM OF 3" BETWEEN BUSINESS SIGNS

DIMENSIONS (MILLIMETERS)				
A	B	C	D	E
25	150D	450	900	300

DIMENSIONS (INCHES)				
A	B	C	D	E
1	6D	18	36	12

TYPICAL SIGN (TOURIST ACTIVITIES) LAYOUTS FOR CONVENTIONAL ROADS.

TOURIST ACTIVITIES BACKGROUNDS SHALL BE BLUE REFLECTIVE SHEETING. LEGEND SHALL BE WHITE REFLECTIVE SHEETING.

LG-C3

6/00

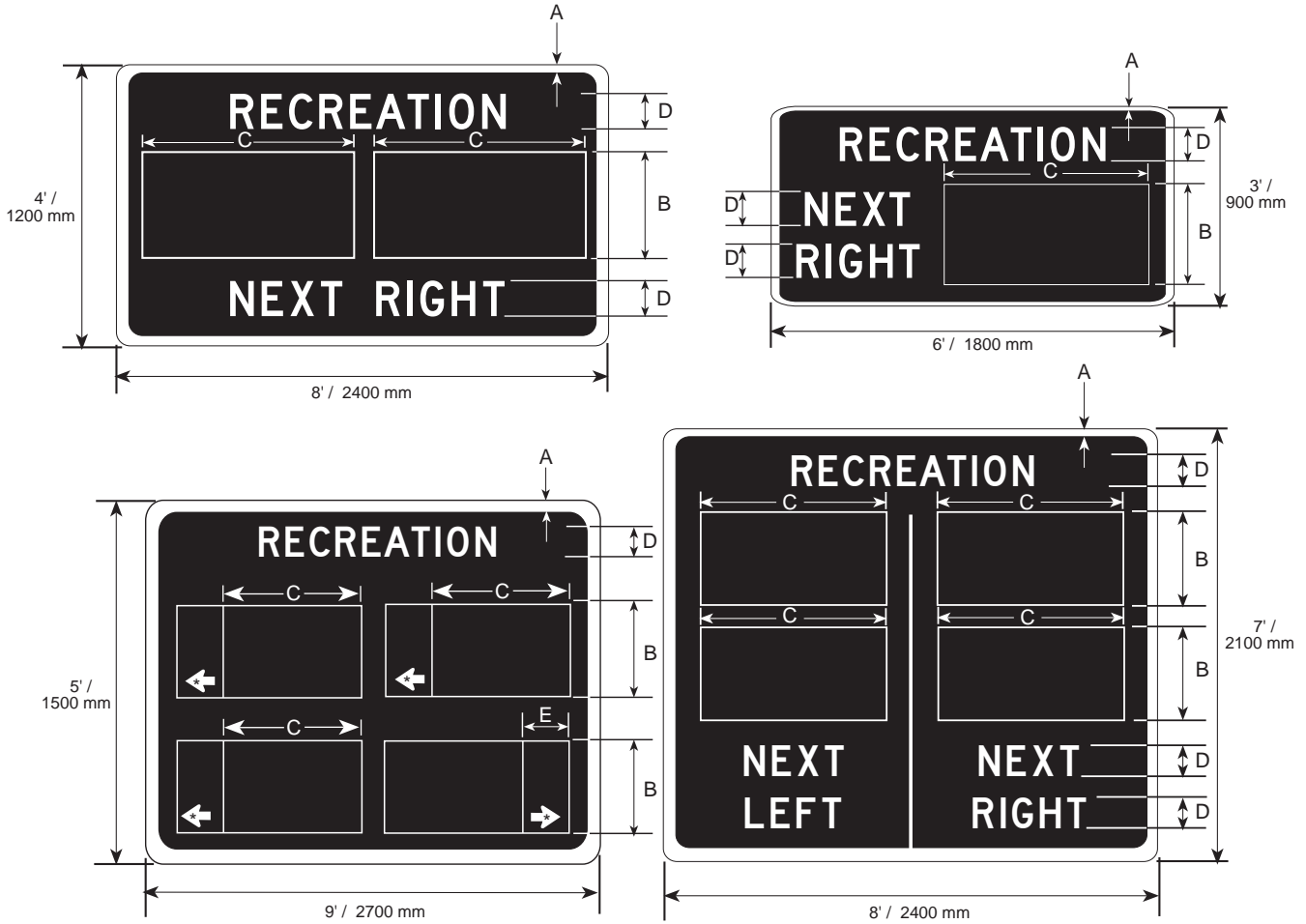

* ARROWS ARE STANDARD 6" X 9".
MINIMUM OF 3" BETWEEN BUSINESS SIGNS

DIMENSIONS (MILLIMETERS)				
A	B	C	D	E
25	450	900	150D	300

DIMENSIONS (INCHES)				
A	B	C	D	E
1	18	36	6D	12

TYPICAL SIGN (RECREATION) LAYOUTS FOR CONVENTIONAL ROADS.

RECREATION SIGN BACKGROUNDS SHALL BE BROWN REFLECTIVE SHEETING. LEGEND SHALL BE WHITE REFLECTIVE SHEETING.

LG-M1

5/06

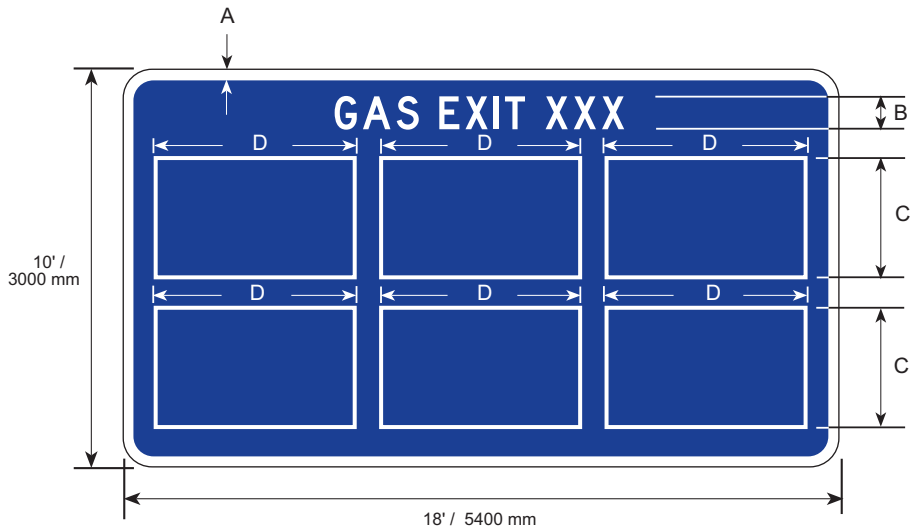
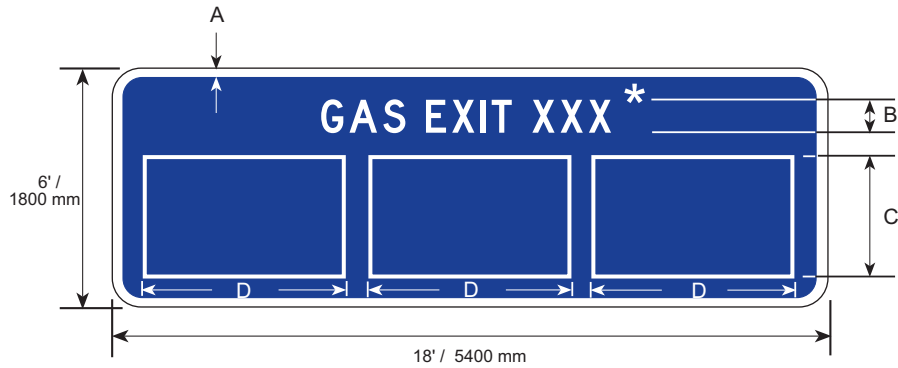

* FOR INTERCHANGES WITHOUT EXIT NUMBERS, USE "NEXT RIGHT"

DIMENSIONS (MILLIMETERS)			
A	B	C	D
38	250D	900	1500

DIMENSIONS (INCHES)			
A	B	C	D
1 1/2	10D	36	60

TYPICAL SIGN (GAS) LAYOUTS FOR FREEWAY OR EXPRESSWAY MAINLINE

COLORS

GAS BACKGROUNDS SHALL BE BLUE REFLECTIVE SHEETING
 LEGEND SHALL BE WHITE REFLECTIVE SHEETING

LG-M1A

5/06

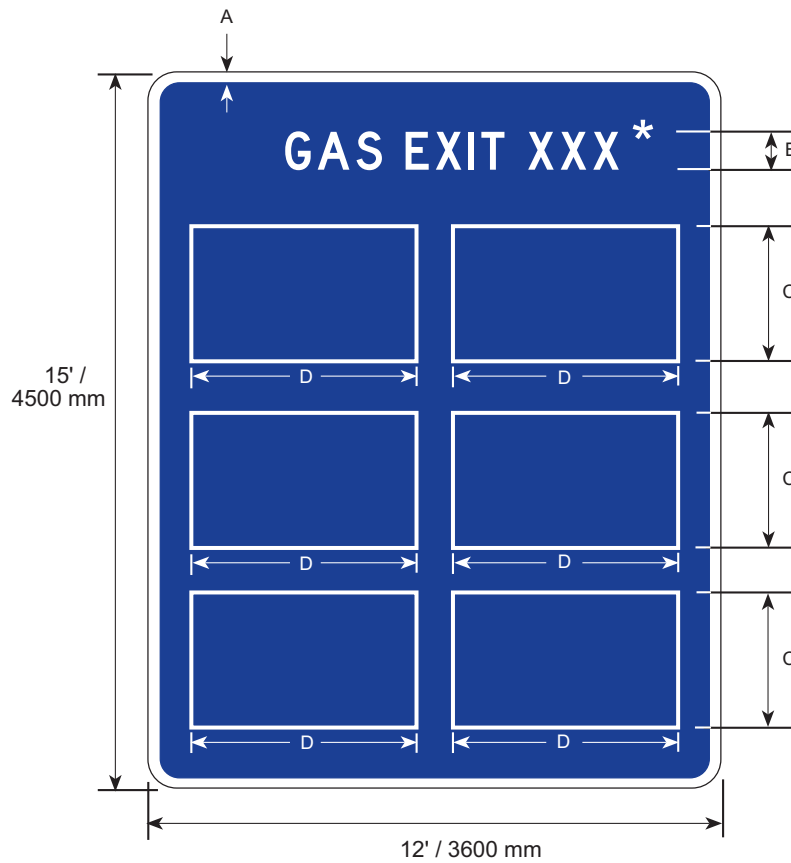

* FOR INTERCHANGES WITHOUT EXIT NUMBERS USE "NEXT RIGHT"

DIMENSIONS (MILLIMETERS)			
A	B	C	D
38	250D	900	1500

DIMENSIONS (INCHES)			
A	B	C	D
1 1/2	10D	36	60

TYPICAL SIGN (GAS) LAYOUTS FOR FREEWAY OR EXPRESSWAY MAINLINE

COLORS

GAS BACKGROUNDS SHALL BE BLUE REFLECTIVE SHEETING
 LEGEND SHALL BE WHITE REFLECTIVE SHEETING

LG-M2

11/97

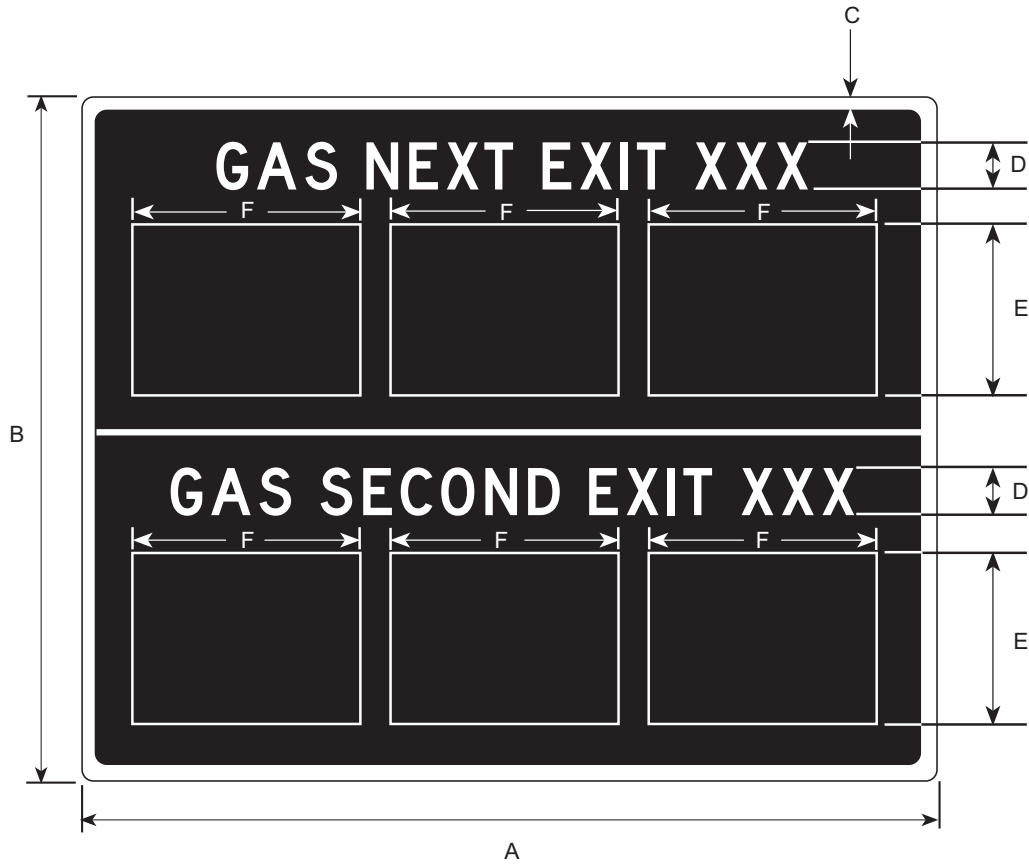

MINIMUM OF 3" BETWEEN BUSINESS SIGNS

DIMENSIONS (MILLIMETERS)					
A	B	C	D	E	F
4500	3600	38	250D	900	1200

DIMENSIONS (INCHES)					
A	B	C	D	E	F
180	144	1 1/2	10D	36	48

TYPICAL SIGN (GAS) LAYOUT FOR FREEWAY OR EXPRESSWAY MAINLINE

GAS BACKGROUND SHALL BE BLUE REFLECTIVE SHEETING. LEGEND SHALL BE WHITE REFLECTIVE SHEETING.

LG-M3

5/06

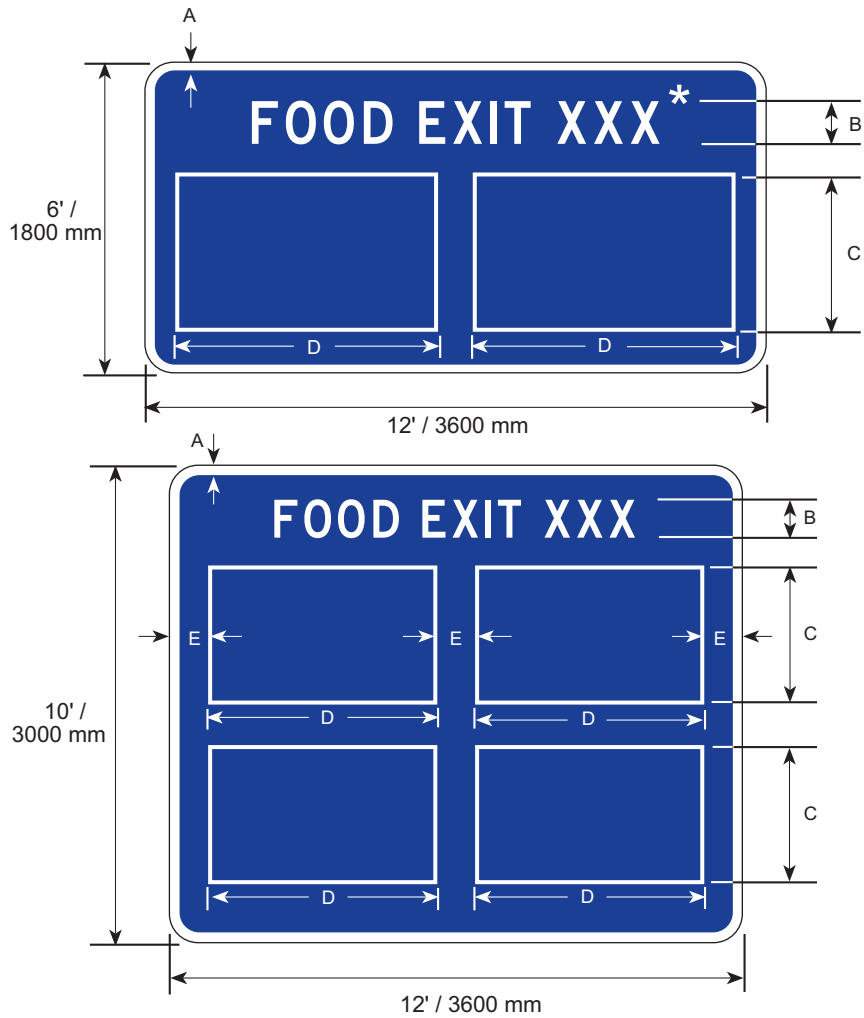

* FOR INTERCHANGES WITHOUT EXIT NUMBERS, USE "NEXT RIGHT"

DIMENSIONS (MILLIMETERS)				
A	B	C	D	E
38	250D	900	1500	200

DIMENSIONS (INCHES)				
A	B	C	D	E
1 1/2	10D	36	60	8

TYPICAL SIGN (FOOD) LAYOUTS FOR FREEWAY OR EXPRESSWAY MAINLINE

COLORS

FOOD BACKGROUNDS SHALL BE BLUE REFLECTIVE SHEETING
 LEGEND SHALL BE WHITE REFLECTIVE SHEETING

LG-M3A

5/06

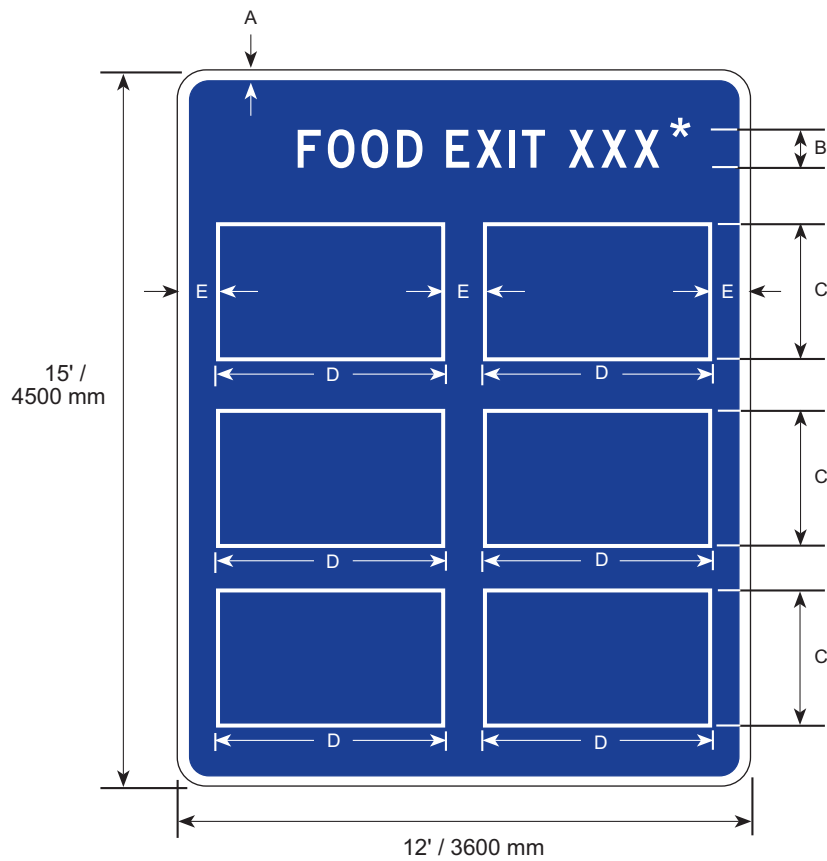

* FOR INTERCHANGES WITHOUT EXIT NUMBERS USE "NEXT RIGHT"

DIMENSIONS (MILLIMETERS)				
A	B	C	D	E
38	250D	900	1500	200

DIMENSIONS (INCHES)				
A	B	C	D	E
1 1/2	10D	36	60	8

TYPICAL SIGN (FOOD) LAYOUTS FOR FREEWAY OR EXPRESSWAY MAINLINE

COLORS

FOOD BACKGROUNDS SHALL BE BLUE REFLECTIVE SHEETING
 LEGEND SHALL BE WHITE REFLECTIVE SHEETING

LG-M4

11/97

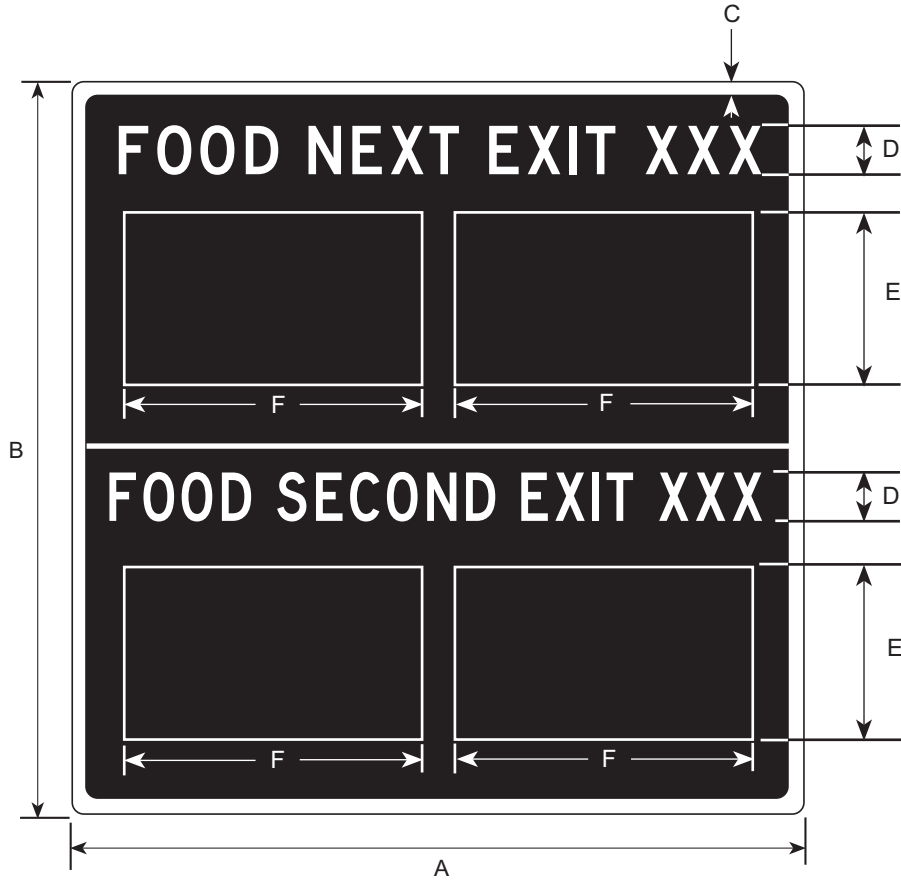

MINIMUM OF 3" BETWEEN BUSINESS SIGNS

DIMENSIONS (MILLIMETERS)					
A	B	C	D	E	F
4200	3600	38	250D	900	1500

DIMENSIONS (INCHES)					
A	B	C	D	E	F
168	144	1 1/2	10D	36	60

TYPICAL SIGN (FOOD) LAYOUT FOR FREEWAY AND EXPRESSWAY MAINLINE.

FOOD BACKGROUNDS SHALL BE BLUE REFLECTIVE SHEETING. LEGEND SHALL BE WHITE REFLECTIVE SHEETING.

LG-M5

5/06

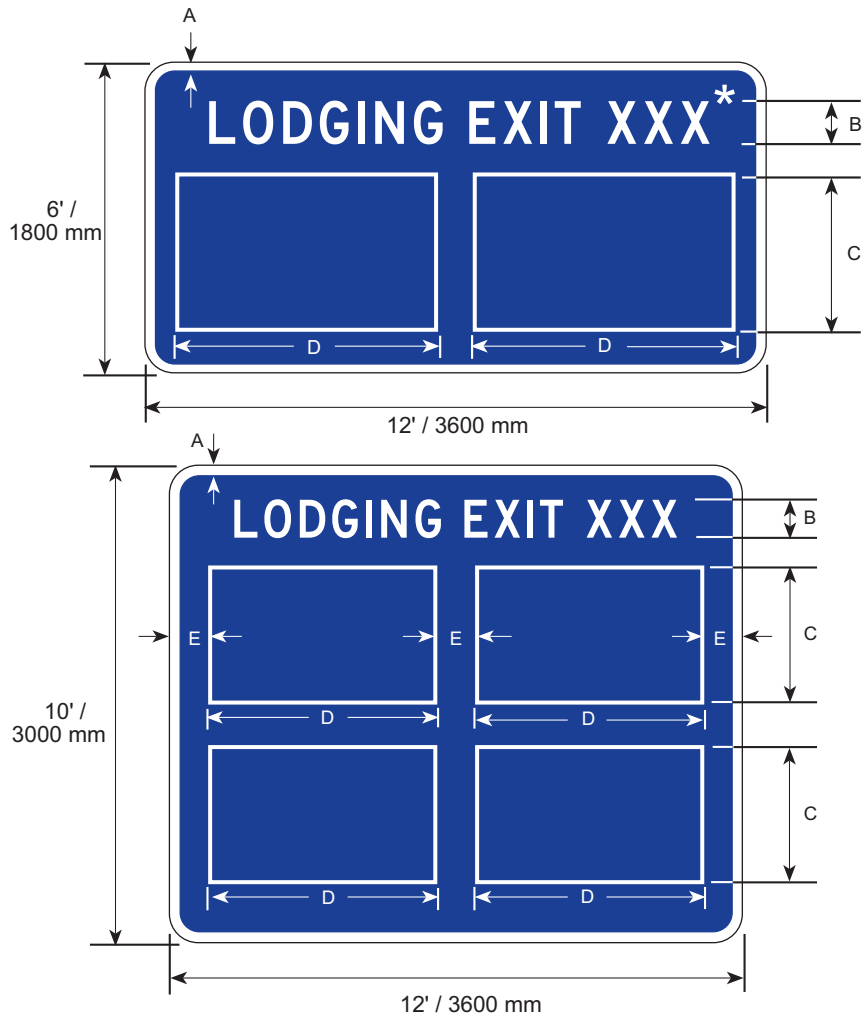

* FOR INTERCHANGES WITHOUT EXIT NUMBERS, USE "NEXT RIGHT"

DIMENSIONS (MILLIMETERS)				
A	B	C	D	E
38	250D	900	1500	200

DIMENSIONS (INCHES)				
A	B	C	D	E
1 1/2	10D	36	60	8

TYPICAL SIGN (LODGING) LAYOUTS FOR FREEWAY OR EXPRESSWAY MAINLINE

COLORS

FOOD BACKGROUNDS SHALL BE BLUE REFLECTIVE SHEETING
 LEGEND SHALL BE WHITE REFLECTIVE SHEETING

LG-M5A

5/06

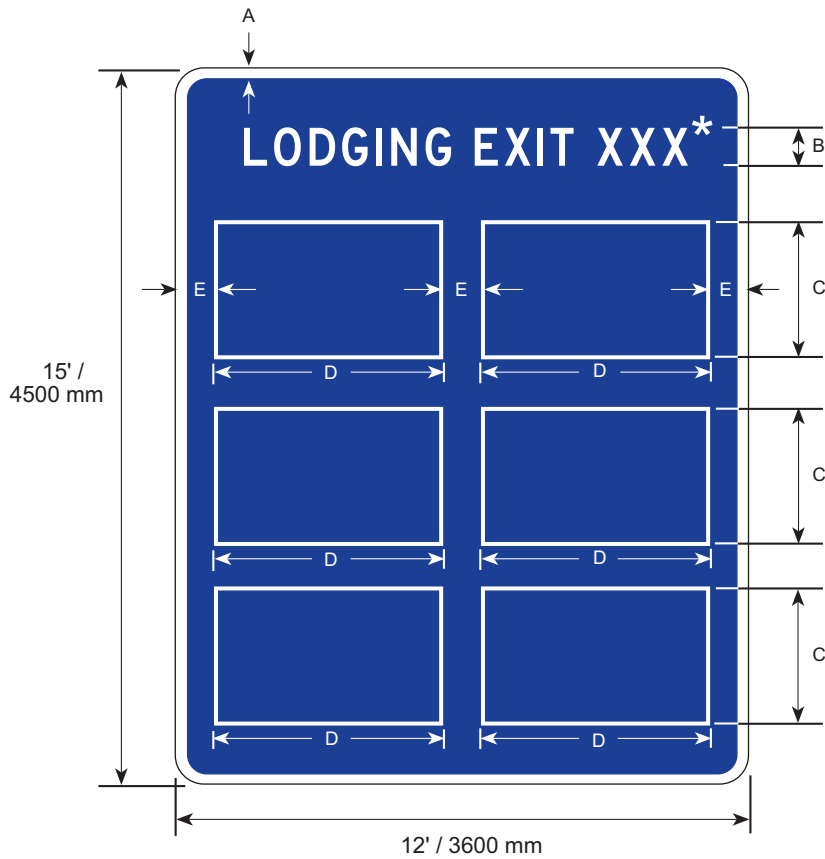

* FOR INTERCHANGES WITHOUT EXIT NUMBERS USE "NEXT RIGHT"

DIMENSIONS (MILLIMETERS)				
A	B	C	D	E
38	250D	900	1500	200

DIMENSIONS (INCHES)				
A	B	C	D	E
1 1/2	10D	36	60	8

TYPICAL SIGN (LODGING) LAYOUTS FOR FREEWAY OR EXPRESSWAY MAINLINE

COLORS

FOOD BACKGROUNDS SHALL BE BLUE REFLECTIVE SHEETING
 LEGEND SHALL BE WHITE REFLECTIVE SHEETING

LG-M6

11/97

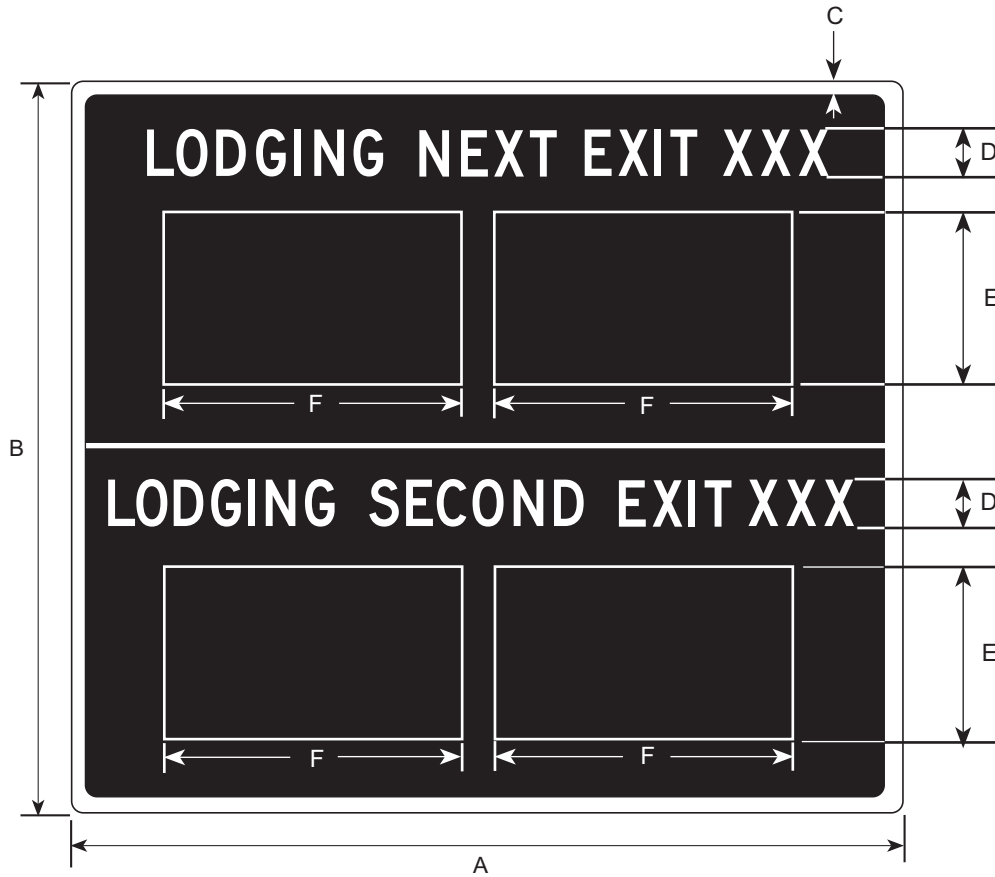

MINIMUM OF 3" BETWEEN BUSINESS SIGNS

DIMENSIONS (MILLIMETERS)					
A	B	C	D	E	F
5100	3600	38	250D	900	1500

DIMENSIONS (INCHES)					
A	B	C	D	E	F
204	144	1 1/2	10D	36	60

TYPICAL SIGN (LODGING) LAYOUT FOR FREEWAY OR EXPRESSWAY MAINLINE.

LODGING BACKGROUNDS SHALL BE BLUE REFLECTIVE SHEETING.
LEGEND SHALL BE WHITE REFLECTIVE SHEETING.

LG-M7

6/00

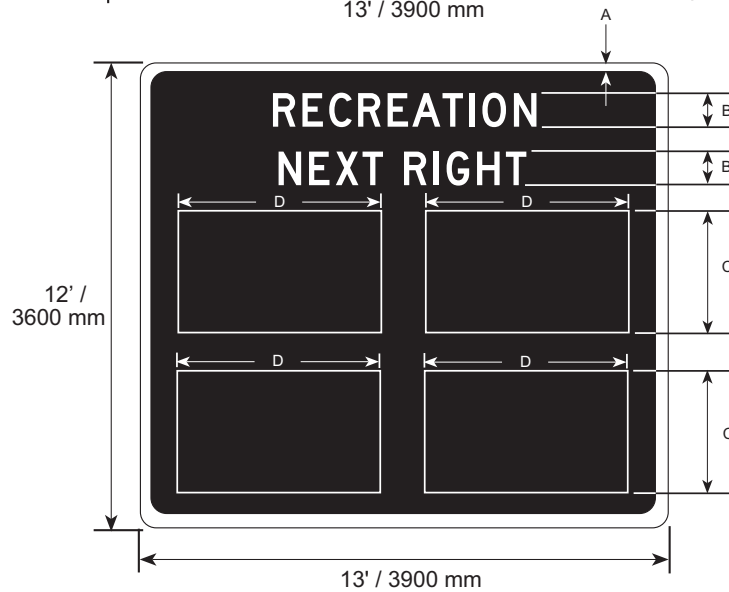
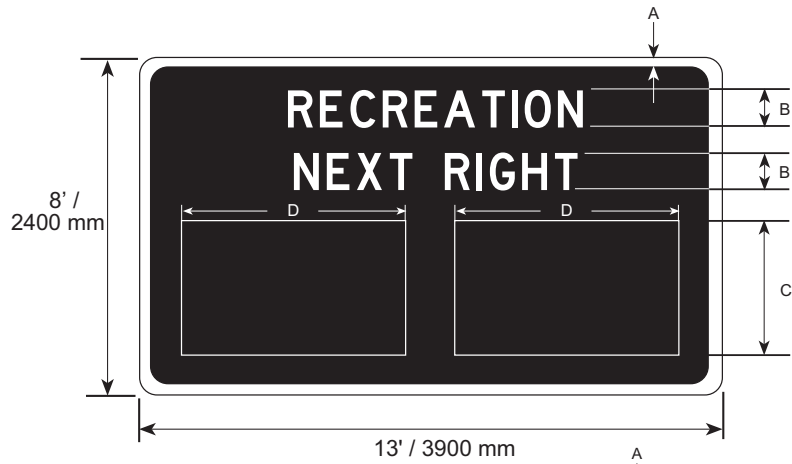

MINIMUM OF 3" BETWEEN BUSINESS SIGNS

DIMENSIONS (MILLIMETERS)			
A	B	C	D
38	250D	900	1500

DIMENSIONS (INCHES)			
A	B	C	D
1 1/2	10D	36	60

RECREATION BACKGROUNDS SHALL BE BROWN REFLECTIVE SHEETING.
LEGEND SHALL BE WHITE REFLECTIVE SHEETING.

LG-M8

11/97

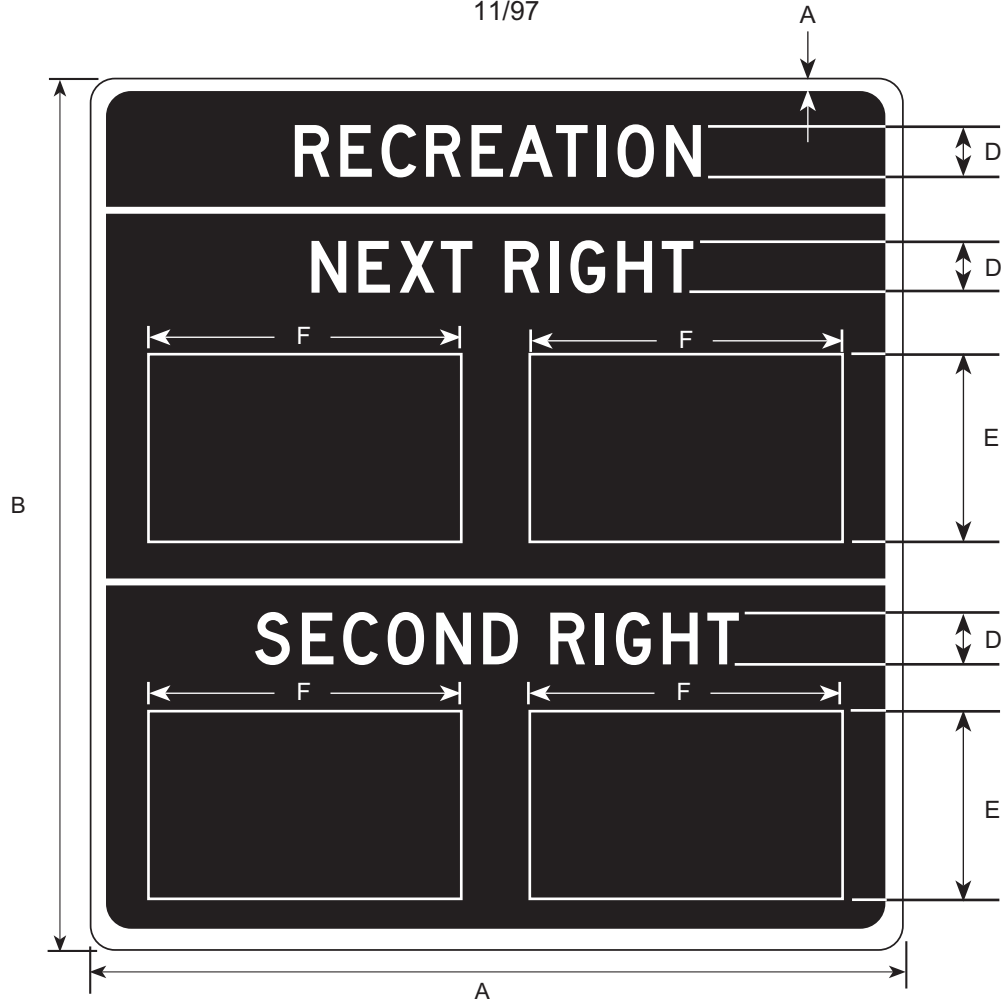

MINIMUM OF 3" BETWEEN BUSINESS SIGNS

DIMENSIONS (MILLIMETERS)					
A	B	C	D	E	F
3900	4200	38	250D	900	1500

DIMENSIONS (INCHES)					
A	B	C	D	E	F
156	168	1 1/2	10D	36	60

RECREATION BACKGROUNDS SHALL BE BROWN REFLECTIVE SHEETING.
 LEGEND SHALL BE WHITE REFLECTIVE SHEETING.

LG-M9

506

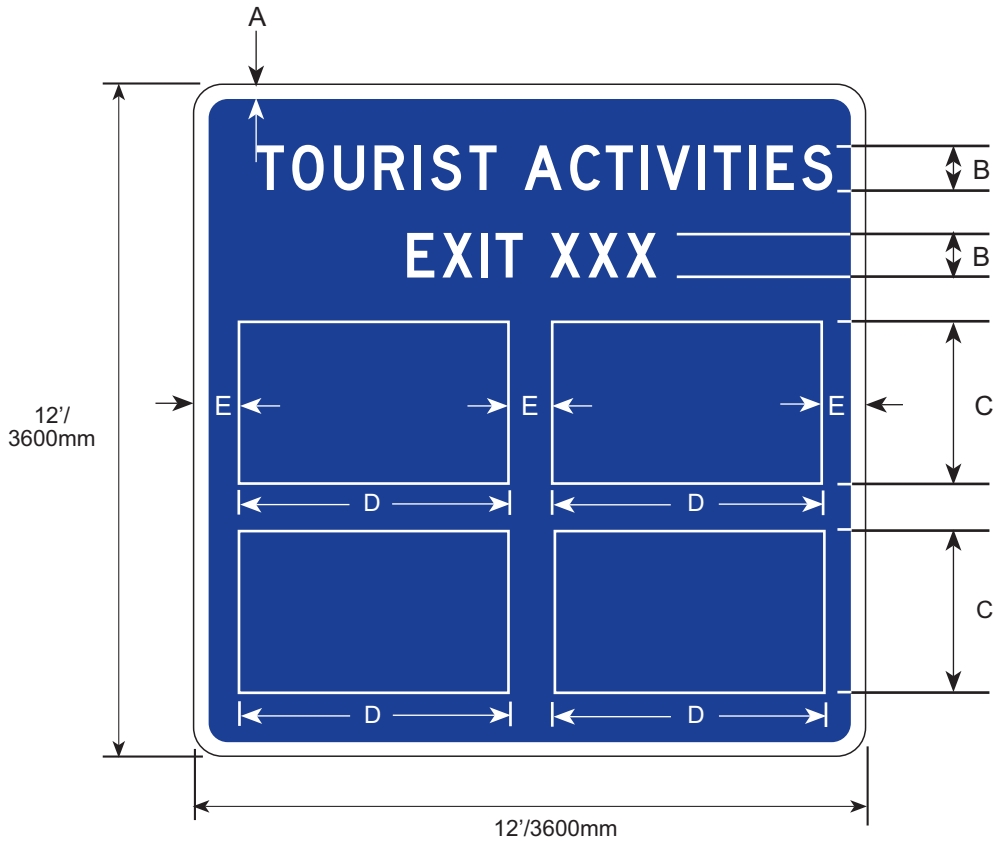

FOR INTERCHANGES WITHOUT EXIT NUMBERS, USE "NEXT RIGHT"

DIMENSIONS (MILLIMETERS)				
A	B	C	D	E
38	250D	900	1500	200

DIMENSIONS (INCHES)				
A	B	C	D	E
1 1/2	10D	36	60	8

TYPICAL SIGN (TOURIST ACTIVITIES) LAYOUT FOR FREEWAY OR EXPRESSWAY MAINLINE

COLORS

TOURIST ACTIVITIES BACKGROUNDS SHALL BE BLUE REFLECTIVE SHEETING
LEGEND SHALL BE WHITE REFLECTIVE SHEETING.

LG-M9A

5/06

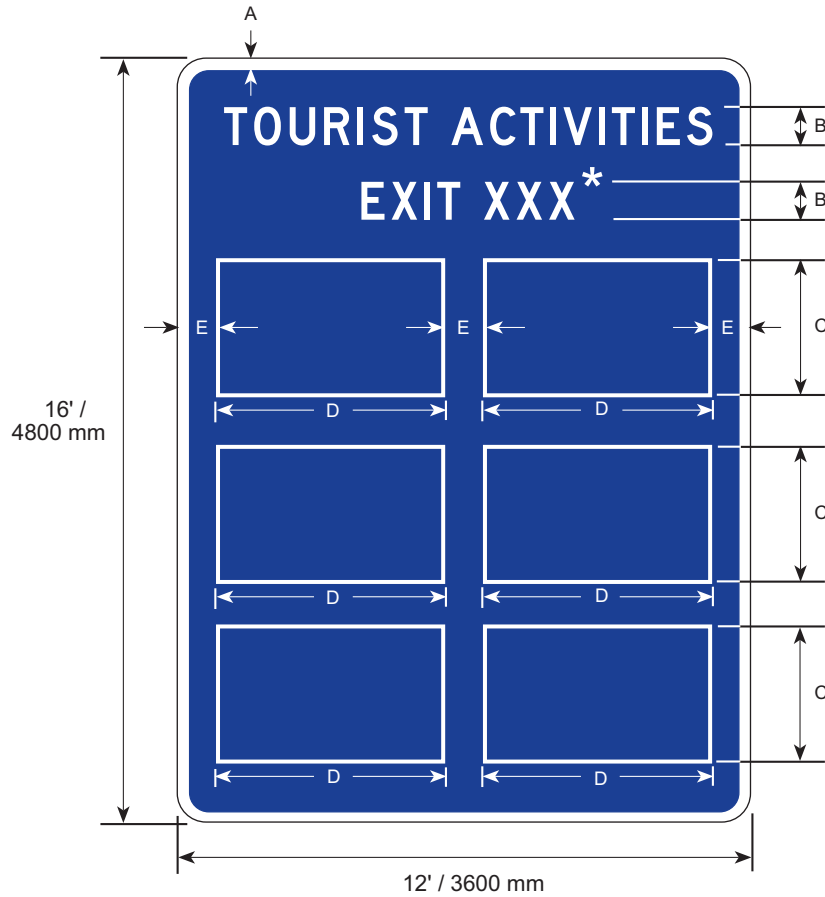

* FOR INTERCHANGES WITHOUT EXIT NUMBERS USE "NEXT RIGHT"

DIMENSIONS (MILLIMETERS)				
A	B	C	D	E
38	250D	900	1500	200

DIMENSIONS (INCHES)				
A	B	C	D	E
1 1/2	10D	36	60	8

TYPICAL SIGN (TOURIST ACTIVITIES) LAYOUTS FOR
FREEWAY OR EXPRESSWAY MAINLINE

COLORS

FOOD BACKGROUNDS SHALL BE BLUE REFLECTIVE SHEETING
LEGEND SHALL BE WHITE REFLECTIVE SHEETING

LG-M10

11/97

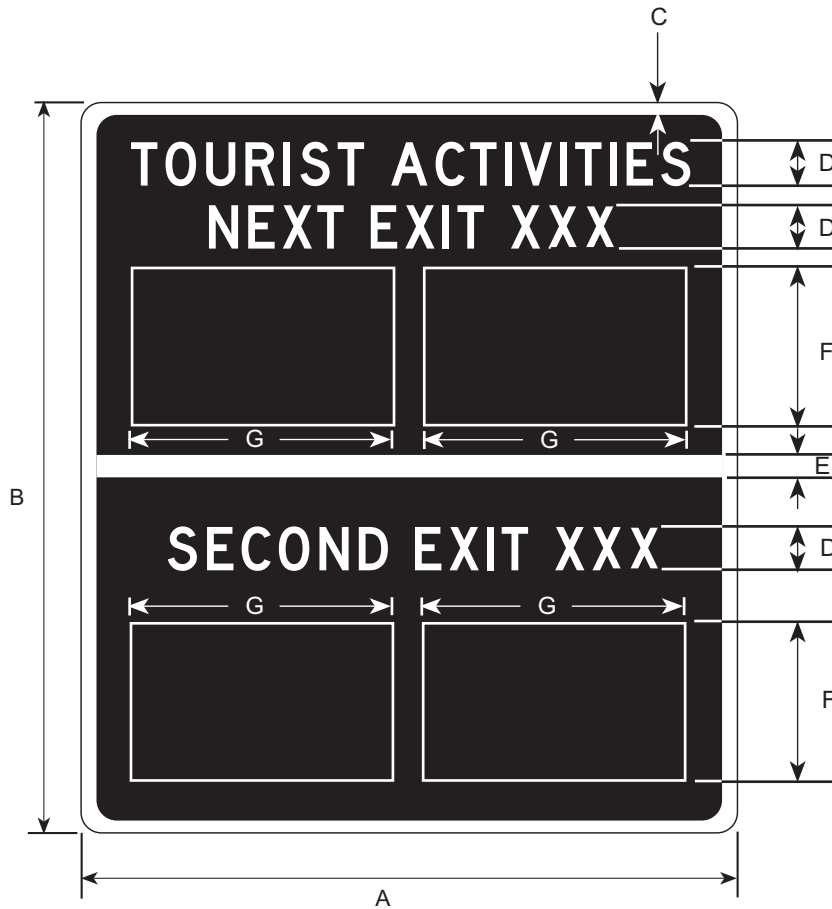

MINIMUM OF 3" BETWEEN BUSINESS SIGNS

DIMENSIONS (MILLIMETERS)						
A	B	C	D	E	F	G
3900	4200	38	250D	50	900	1500

DIMENSIONS (INCHES)						
A	B	C	D	E	F	G
156	168	1 1/2	10D	2	36	60

TYPICAL SIGN (TOURIST ACTIVITIES) LAYOUT FOR FREEWAY AND EXPRESSWAY MAINLINE.

TOURIST ACTIVITIES BACKGROUNDS SHALL BE BLUE REFLECTIVE SHEETING. LEGEND SHALL BE WHITE REFLECTIVE SHEETING.

LG-R1

5/06

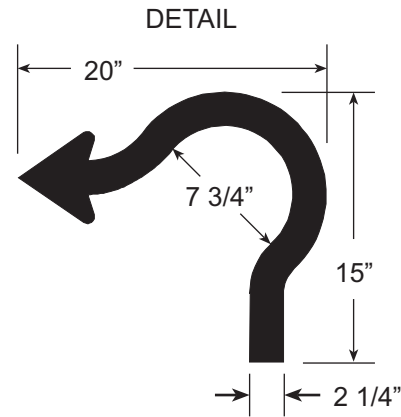
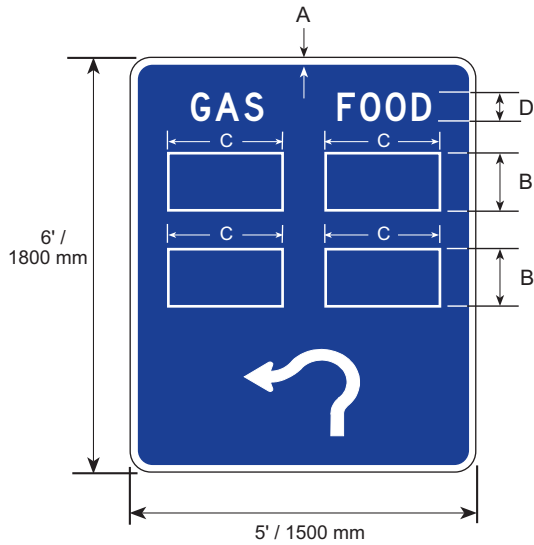
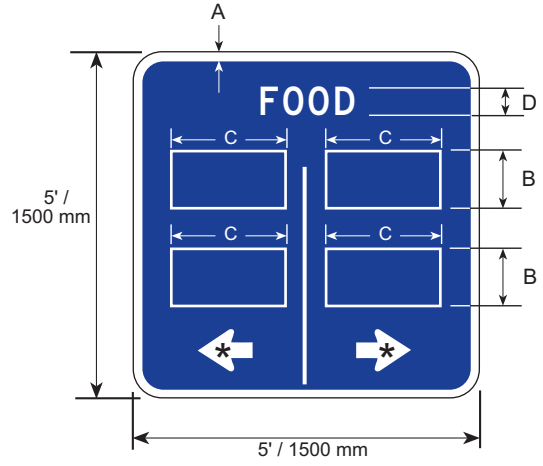
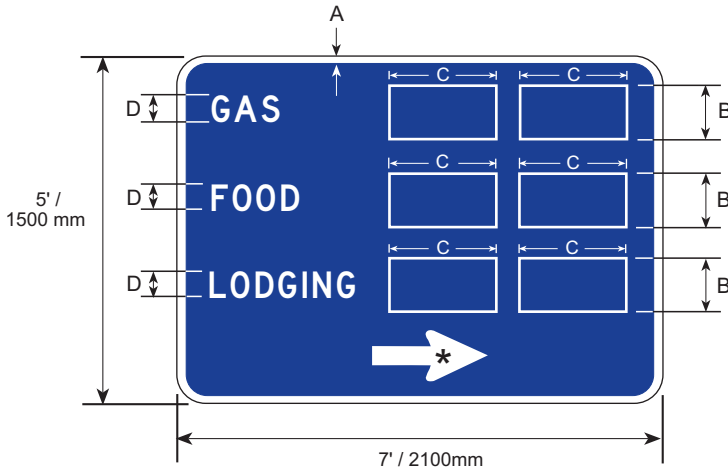

MINIMUM OF 3" BETWEEN BUSINESS SIGNS

* SEE APPENDIX FOR STANDARD ARROW DETAILS

DIMENSIONS (MM)			
A	B	C	D
25	300	600	150D

DIMENSIONS (INCHES)			
A	B	C	D
1	12	24	6D

TYPICAL SIGN (GAS, FOOD, LODGING) LAYOUTS FOR FREEWAY AND EXPRESSWAY RAMPS

GAS, FOOD, AND LODGING BACKGROUNDS SHALL BE BLUE REFLECTIVE SHEETING
 LEGEND SHALL BE WHITE REFLECTIVE SHEETING

LG-R2

2/98

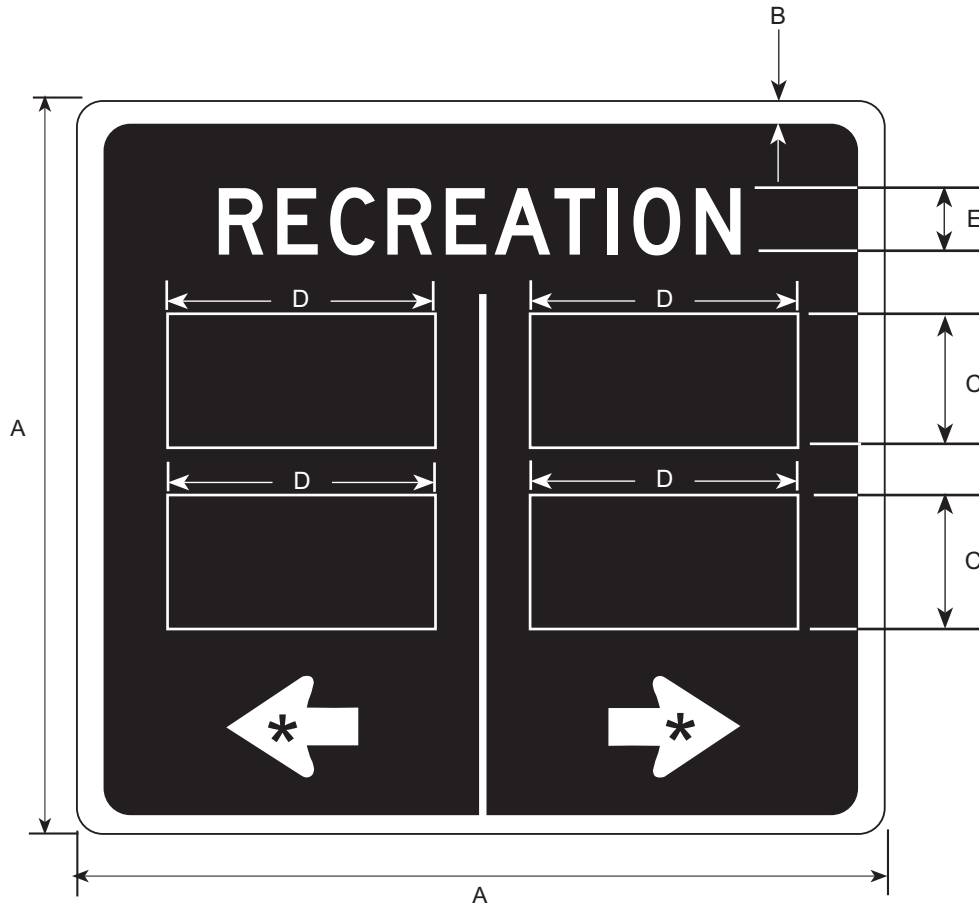

MINIMUM OF 3" BETWEEN BUSINESS SIGNS

* SEE APPENDIX FOR STANDARD ARROW DETAILS

DIMENSIONS (MILLIMETERS)				
A	B	C	D	E
1500	25	300	600	150D

DIMENSIONS (INCHES)				
A	B	C	D	E
60	1	12	24	6D

TYPICAL SIGN (RECREATION) LAYOUT FOR FREEWAY OR EXPRESSWAY RAMP

RECREATION BACKGROUND SHALL BE BROWN REFLECTIVE SHEETING.
LEGEND SHALL BE WHITE REFLECTIVE SHEETING.

LG-R3

2/98

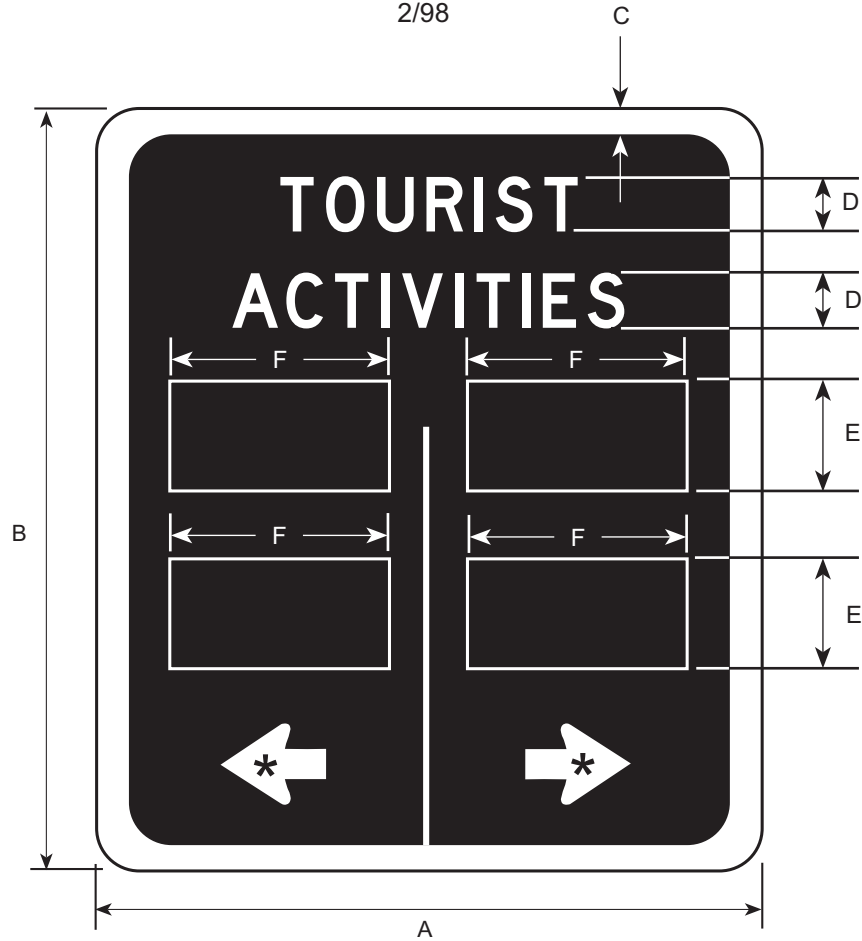

MINIMUM OF 3" BETWEEN BUSINESS SIGNS

* SEE APPENDIX FOR STANDARD ARROW DETAILS

DIMENSIONS (MILLIMETERS)					
A	B	C	D	E	F
1500	1800	25	150D	300	600

DIMENSIONS (INCHES)					
A	B	C	D	E	F
60	72	1	6D	12	24

TYPICAL SIGN (TOURIST ACTIVITIES) LAYOUT FOR FREEWAY OR EXPRESSWAY RAMPS

TOURIST ACTIVITIES BACKGROUND SHALL BE BLUE REFLECTIVE SHEETING. LEGEND SHALL BE WHITE REFLECTIVE SHEETING.

LG-R4

5/06

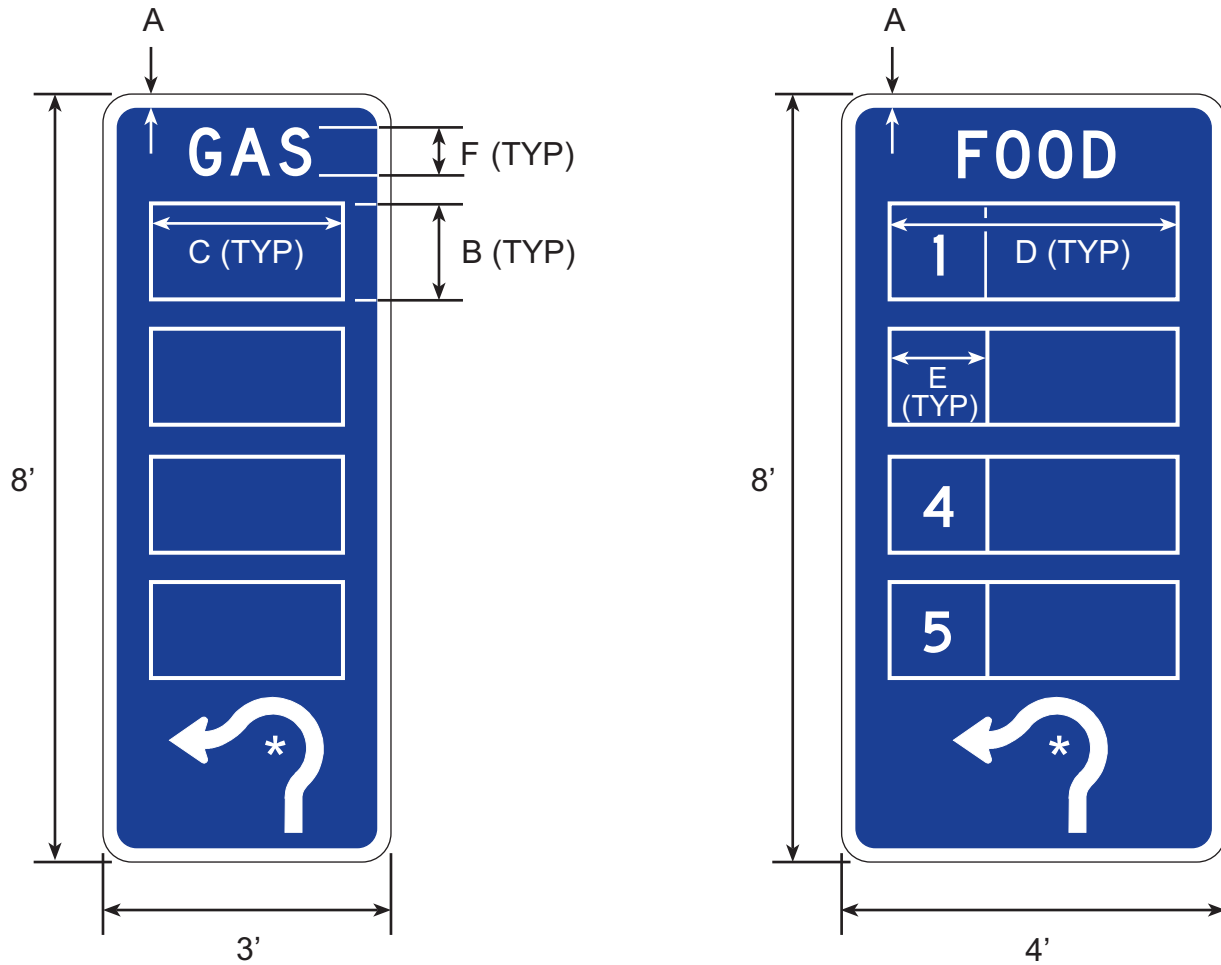

* SEE APPENDIX FOR STANDARD ARROW DETAILS
SEE LG-R1 FOR ARROW DIMENSIONS

DIMENSIONS (MILLIMETERS)					
A	B	C	D	E	F
25	300	600	900	300	150D

DIMENSIONS (INCHES)					
A	B	C	D	E	F
1	12	24	36	12	6D

TYPICAL SIGN (GAS, FOOD, LODGING) LAYOUTS FOR FREEWAY AND EXPRESSWAY RAMP HAVING A ROUNDABOUT

GAS, FOOD, AND LODGING BACKGROUNDS SHALL BE BLUE REFLECTIVE SHEETING
LEGEND SHALL BE WHITE REFLECTIVE SHEETING

M1-1

11/00

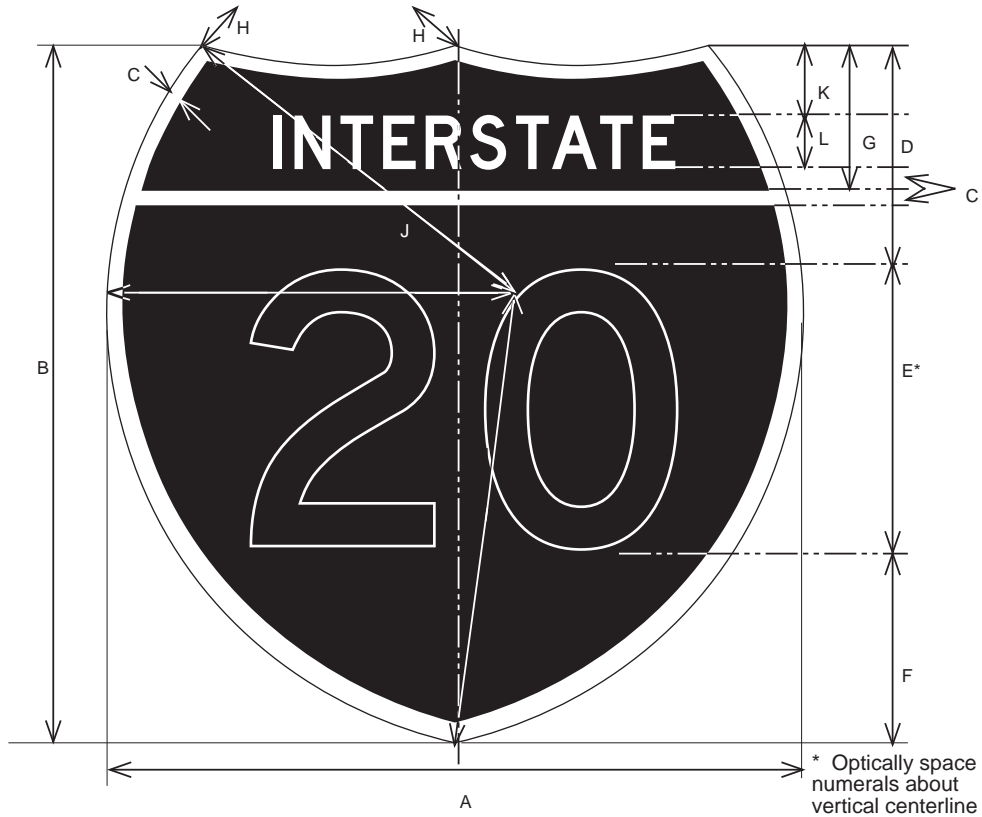

INTERSTATE SHIELD FOR INDEPENDENT & GUIDE SIGN USE

SIGN	DIMENSIONS (MILLIMETERS)										
	A	B	C	D	E	F	G	H	J	K	L
1,2-Digits	600	600	13	163	250D	138	125	375	375	50	63C
1,2-Digits	900	900	19	244	300D	206	188	563	563	75	94C
1,2-Digits	1200	1200	25	325	500D	275	250	750	750	100	125C
3-Digits	750	600	13	163	250D	138	125	600	425	50	63C
3-Digits	1125	900	19	244	375D	206	188	900	638	75	94C
3-Digits	1500	1200	25	325	500D	275	250	1200	850	100	125C

SIGN	DIMENSIONS (INCHES)										
	A	B	C	D	E	F	G	H	J	K	L
1,2-Digits	24	24	1/2	6 1/2	10D	5 1/2	5	15	15	2	2 1/2C
1,2-Digits	36	36	3/4	9 3/4	12D	8 1/4	7 1/2	22 1/2	22 1/2	3	3 3/4C
1,2-Digits	48	48	1	13	20D	1	10	30	30	4	5C
3-Digits	30	24	1/2	6 1/2	10D	5 1/2	5	24	17	2	2 1/2C
3-Digits	45	36	3/4	9 3/4	15D	8 1/4	7 1/2	36	25 1/2	3	3 3/4C
3-Digits	60	48	1	13	20D	1	10	48	34	4	5C

COLORS

LEGEND - WHITE (REFL)

TOP - RED (REFL)

BOTTOM - BLUE (REFL)

M1-2

11/97

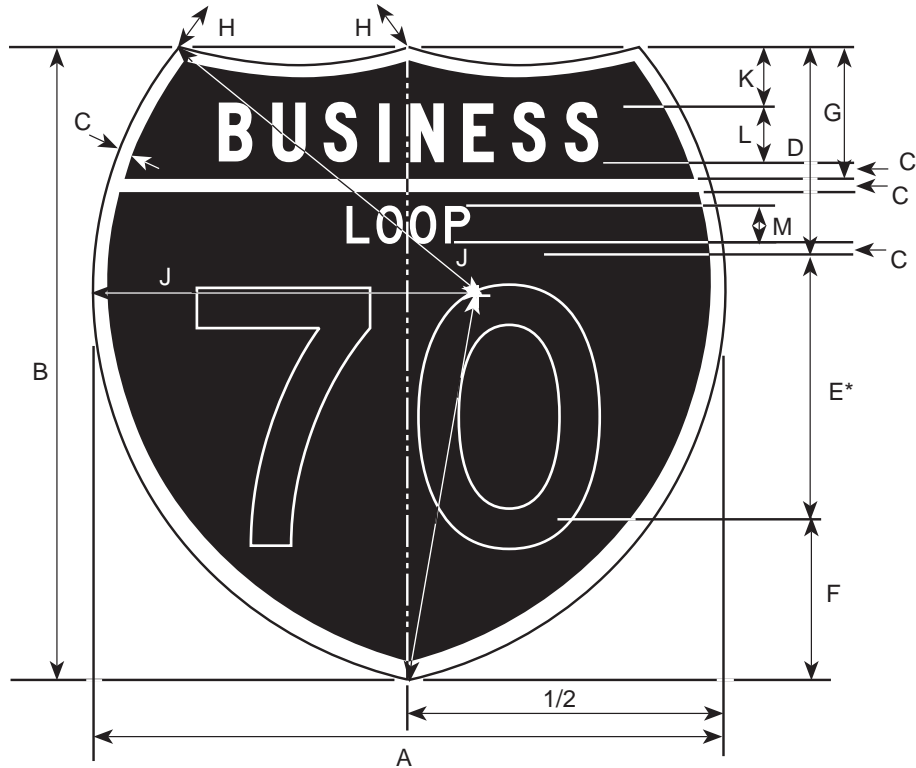

*OPTICALLY SPACE NUMERALS ABOUT VERTICAL CENTERLINE

OFF- INTERSTATE BUSINESS LOOP MARKER

SIGN	DIMENSIONS (MILLIMETERS)											
	A	B	C	D	E	F	G	H	J	K	L	M
1,2 DIGITS	600	600	325	200	250D	150	125	375	375	50	63C	38D
1,2 DIGITS	900	900	475	300	375D	225	188	563	563	75	94C	56D
1,2 DIGITS	1200	1200	625	400	500D	300	250	750	750	100	125C	75D
3 DIGITS	750	600	325	200	250D	150	125	600	425	50	63C	38D
3 DIGITS	112	900	475	300	375D	225	188	900	638	75	94C	56D
3 DIGITS	1500	1200	625	400	500D	300	250	1200	850	100	125C	75D

SIGN	DIMENSIONS (INCHES)											
	A	B	C	D	E	F	G	H	J	K	L	M
1,2 DIGITS	24	24	1/2	8	10D	6	5	15	15	2	2 1/2C	1 1/2D
1,2 DIGITS	36	36	3/4	12	15D	9	7 1/2	22 1/2	22 1/2	3	3 3/4C	2 1/4D
1,2 DIGITS	48	48	1	16	20D	12	10	30	30	4	5C	3D
3 DIGITS	30	24	1/2	8	10D	6	5	24	17	2	2 1/2C	1 1/2D
3 DIGITS	45	36	3/4	12	15D	9	7 1/2	36	25 1/2	3	3 3/4C	2 1/4D
3 DIGITS	60	48	1	16	20D	12	10	48	34	4	5C	3D

COLORS

LEGEND - WHITE (REFL)
BACKGROUND - GREEN (REFL)

M1-3

11/97

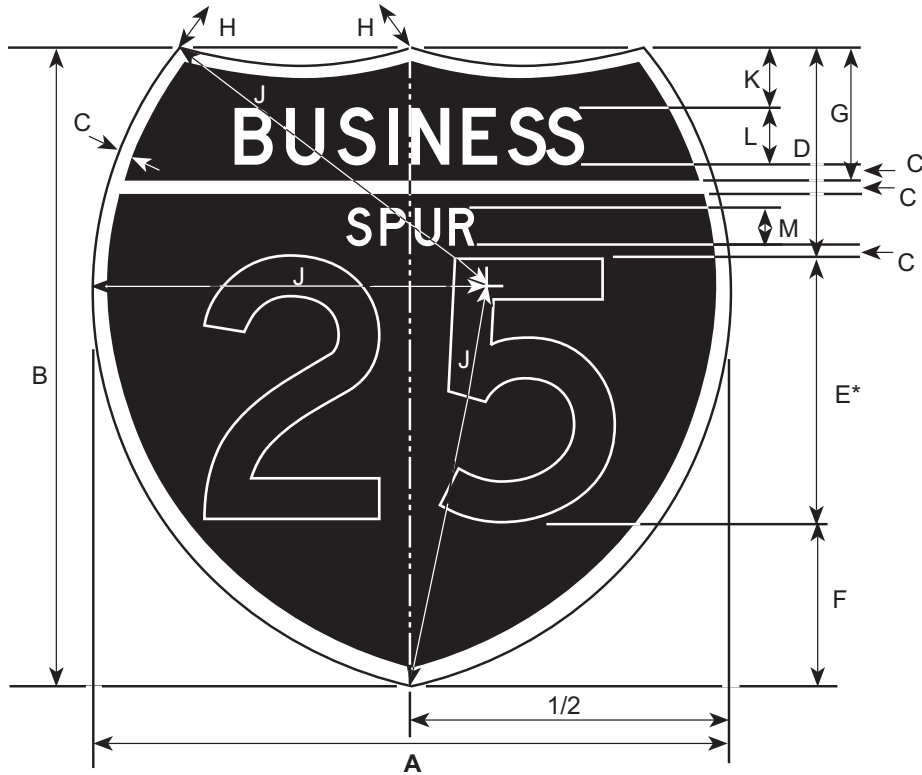

*OPTICALLY SPACE NUMERALS ABOUT VERTICAL CENTERLINE

OFF- INTERSTATE

BUSINESS SPUR MARKER

SIGN	DIMENSIONS (MILLIMETERS)											
	A	B	C	D	E	F	G	H	J	K	L	M
1,2 DIGITS	600	600	325	200	250D	150	125	375	375	50	63C	38D
1,2 DIGITS	900	900	475	300	375D	225	188	563	563	75	94C	56D
1,2 DIGITS	1200	1200	625	400	500D	300	250	750	750	100	125C	75D
3 DIGITS	750	600	325	200	250D	150	125	600	425	50	63C	38D
3 DIGITS	112	900	475	300	375D	225	188	900	638	75	94C	56D
3 DIGITS	1500	1200	625	400	500D	300	250	1200	850	100	125C	75D

SIGN	DIMENSIONS (INCHES)											
	A	B	C	D	E	F	G	H	J	K	L	M
1,2 DIGITS	24	24	1/2	8	10D	6	5	15	15	2	2 1/2C	1 1/2D
1,2 DIGITS	36	36	3/4	12	15D	9	7 1/2	22 1/2	22 1/2	3	3 3/4C	2 1/4D
1,2 DIGITS	48	48	1	16	20D	12	10	30	30	4	5C	3D
3 DIGITS	30	24	1/2	8	10D	6	5	24	17	2	2 1/2C	1 1/2D
3 DIGITS	45	36	3/4	12	15D	9	7 1/2	36	25 1/2	3	3 3/4C	2 1/4D
3 DIGITS	60	48	1	16	20D	12	10	48	34	4	5C	3D

COLORS

LEGEND — WHITE (REFL)
BACKGROUND - GREEN (REFL)

M1-4

5/06

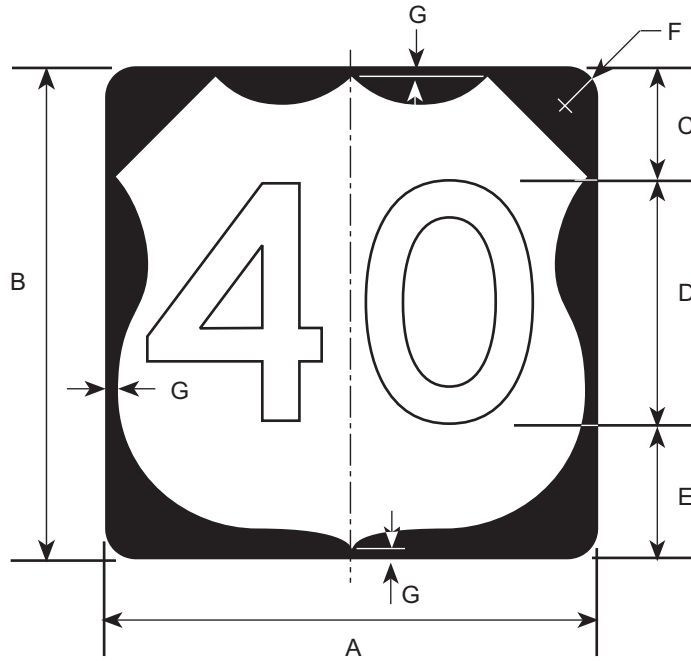

SIGN	DIMENSIONS (MILLIMETERS)						
	A	B	C	D	E	F	G
1,2 DIGIT	600	600	138	300D	163	13	38
1,2 DIGIT	900	900	206	450D	244	19	56
1,2 DIGIT	1200	1200	275	600D	325	25	75
3 DIGIT	750	600	138	300D	163	13	38
3 DIGIT	112	900	206	450D	244	19	56
3 DIGIT	1500	1200	275	600D	325	25	75

SIGN	DIMENSIONS (INCHES)						
	A	B	C	D	E	F	G
1,2 DIGIT	24	24	5 1/2	12D	6 1/2	1/2	1 1/2
1,2 DIGIT	36	36	8 1/4	18D	9 3/4	3/4	2 1/4
1,2 DIGIT	48	48	11	24D	13	1	3
3 DIGIT	30	24	5 1/2	12D	6 1/2	1/2	1 1/2
3 DIGIT	45	36	8 1/4	18D	9 3/4	3/4	2 1/4
3 DIGIT	60	48	11	24D	13	1	3

COLORS

LEGEND & BACKGROUND— BLACK (NON-REFL)
SHIELD— WHITE (REFL)

M1-4A

11/97

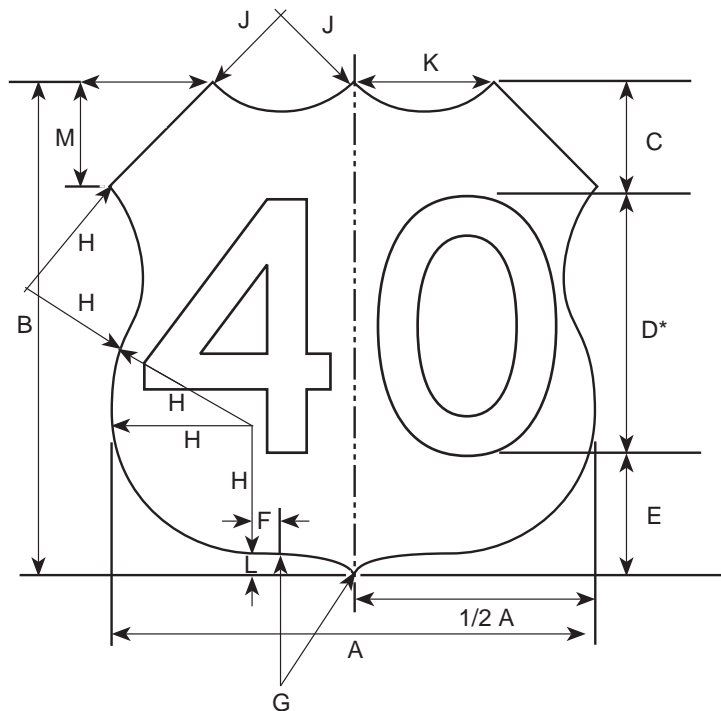

U.S. ROUTE MARKER FOR GUIDE SIGN USE

*OPTICALLY SPACE NUMERALS ABOUT VERTICAL CENTERLINE

SIGN	DIMENSIONS (MILLIMETERS)										
	A	B	C	D	E	F	G	H	J	K	L
1,2 DIGITS	600	600	138	300D	163	25	125	175	125	175	50
1,2 DIGITS	900	900	206	450D	244	38	188	263	188	263	75
1,2 DIGITS	1200	1200	275	600D	325	50	250	350	250	350	100
3 DIGITS	750	600	138	300D	163	100	125	125	225	250	50
3 DIGITS	112	900	206	450D	244	138	188	263	338	375	75
3 DIGITS	1500	1200	275	600D	325	200	250	350	450	500	100

SIGN	DIMENSIONS (INCHES)										
	A	B	C	D	E	F	G	H	J	K	L
1,2 DIGITS	24	24	5 1/2	12D	6 1/2	1	5	7	5	7	2
1,2 DIGITS	36	36	8 1/4	18D	9 3/4	1 1/2	7 1/2	10 1/2	7 1/2	10 1/2	3
1,2 DIGITS	48	48	11	24D	13	2	10	14	10	14	4
3 DIGITS	30	24	5 1/2	12D	6 1/2	4	5	7	9	10	2
3 DIGITS	45	36	8 1/4	18D	9 3/4	5 1/2	7 1/2	10 1/2	13 1/2	15	3
3 DIGITS	60	48	11	24D	13	8	10	14	18	20	4

COLORS

LEGEND - BLACK (NON-REFL)
BACKGROUND - WHITE (REFL)

M1-401

11/03

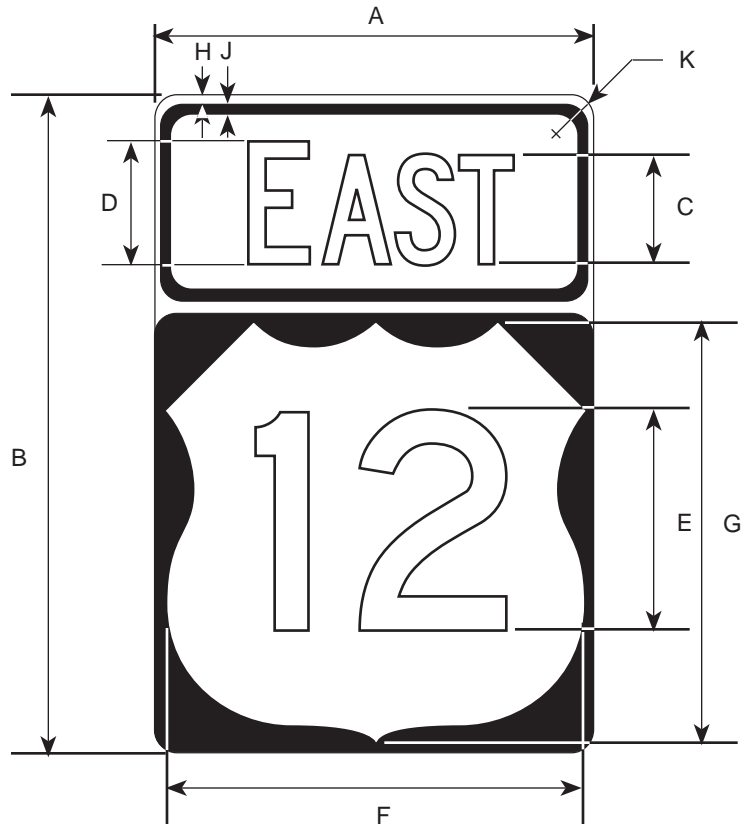

SIGN	DIMENSIONS (MILLIMETERS)									
	A	B	C	D	E	F	G	H	J	K
1,2 DIGIT	600	900	150C	200C	300D	575	575	9	16	38
1,2 DIGIT	900	1200	200C	225C	450D	850	863	9	16	38
3 DIGIT	750	900	150C	200C	300D	725	575	9	16	38
3 DIGIT	1200	1200	200C	225C	450D	1075	863	9	16	38

SIGN	DIMENSIONS (INCHES)									
	A	B	C	D	E	F	G	H	J	K
1,2 DIGIT	24	36	6C	8C	12D	23	23	3/8	5/8	1 1/2
1,2 DIGIT	36	48	8C	9C	18D	34	34 1/2	3/8	5/8	1 1/2
3 DIGIT	30	36	6C	8C	12D	29	23	3/8	5/8	1 1/2
3 DIGIT	48	48	8C	9C	18D	43	34 1/2	3/8	5/8	1 1/2

COLORS

LEGEND & BACKGROUND - BLACK (NON-REFL)

SHIELD - WHITE (REFL)

M1-601

5/06

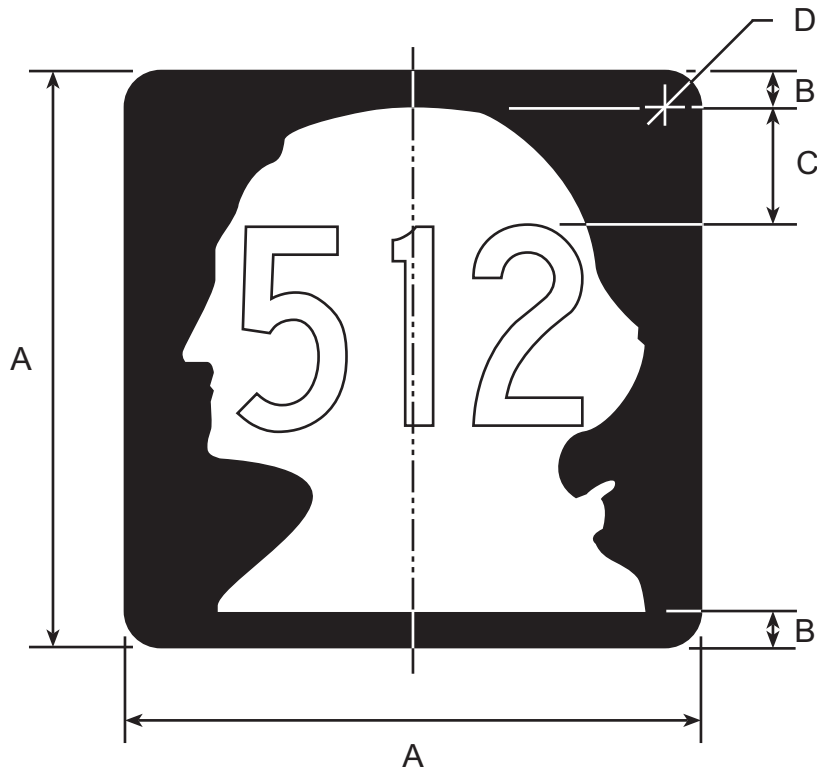

INDEPENDENT (TRAILBLAZER) USE

DIMENSIONS (MILLIMETERS)							
A	B	C	D	SHIELD SIZE	NUMBER SIZE & SERIES		
					1 DIGIT	2 DIGIT	3 DIGIT
600	25	150	38	500 x 550	325C	250C	200C
900	25	238	56	783 x 850	450C	375C	300C

DIMENSIONS (INCHES)							
A	B	C	D	SHIELD SIZE	NUMBER SIZE & SERIES		
					1 DIGIT	2 DIGIT	3 DIGIT
24	1	6	1 1/2	20 x 22	13C	10C	8C
36	1	9 1/2	2 1/4	31 5/16 x 34	18C	15C	12C

COLORS

SHIELD SYMBOL - WHITE (REFL)
 BACKGROUND & NUMBERS - BLACK (NON-REFL)

M1-602

5/06

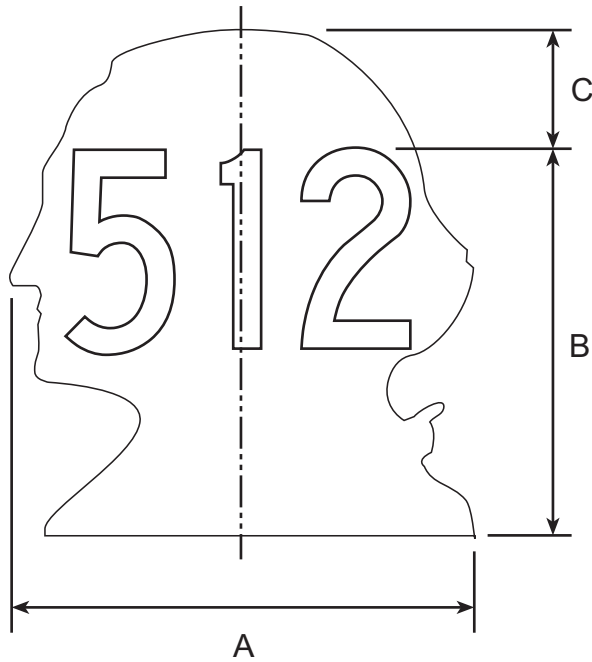

GUIDE SIGN USE

DIMENSIONS (MILLIMETERS)					
A	B	C	NUMBER SIZE & SERIES		
			1 DIGIT	2 DIGIT	3 DIGIT
408	450	125	250C	200C	150C
544	600	166	325C	275C	200C
830	900	250	500C	400C	300C

DIMENSIONS (INCHES)					
A	B	C	NUMBER SIZE & SERIES		
			1 DIGIT	2 DIGIT	3 DIGIT
16 5/16	18	5	10C	8C	6C
21 3/4	24	6 5/8	13C	11C	8C
33 3/16	36	10	20C	16C	12C

COLORS

SHIELD SYMBOL - WHITE REFL)
 NUMBERS - BLACK (NON-REFL)

M1-7

6/00



* OPTICALLY SPACE NUMERALS ABOUT VERTICAL CENTERLINE

DIMENSIONS (MILLIMETERS)								
A	B	C	D	E	F	G	H	J
319	450	13	66	150D	27	100	41	50
425	600	13	88	200D	43	125	56	63

DIMENSIONS (INCHES)								
A	B	C	D	E	F	G	H	J
12 3/4	18	1/2	2 5/8	6D	1 1/8	4	1 5/8	2
17	24	1/2	3 1/2	8D	1 3/4	5	2 1/4	2 1/2

COLORS

LEGEND - WHITE (REFL.)
BACKGROUND - BROWN (REFL.)

M1-701

5/06

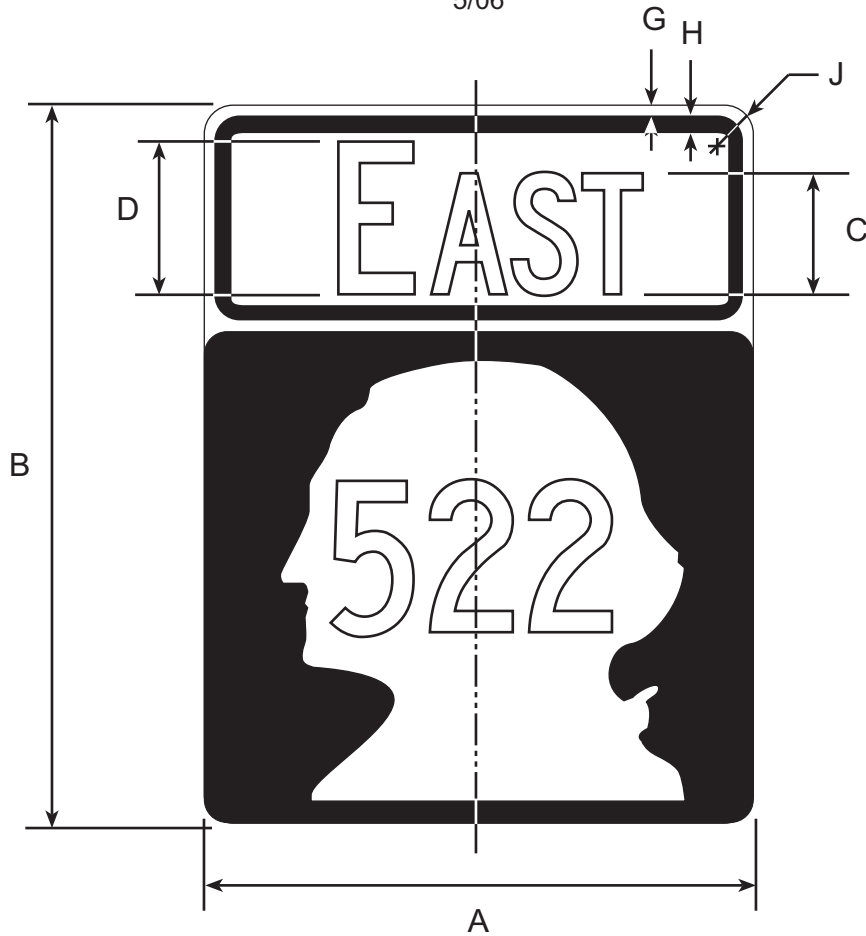

DIMENSIONS (MILLIMETERS)										
A	B	C	D	NUMBER SIZE & SERIES			SHIELD SIZE	G	H	J
				1 DIGIT	2 DIGITS	3 DIGITS				
600	900	150C	200C	325C	250C	200C	500 X 550	9	16	38
900	1200	150C	200C	450C	375C	300C	783 X 850	9	16	38

DIMENSIONS (INCHES)										
A	B	C	D	NUMBER SIZE & SERIES			SHIELD SIZE	G	H	J
				1 DIGIT	2 DIGITS	3 DIGITS				
24	36	6C	8C	13C	10C	8C	20 x 22	3/8	5/8	1 1/2
36	48	6C	8C	18C	15C	12C	31 5/16 x 34	3/8	5/8	1 1/2

COLORS

LEGEND & BACKGROUND— BLACK (NON-REFL)
SHIELD— WHITE (REFL)

M1-8

6/00



* SEE APPENDIX FOR SYMBOL DESIGN

DIMENSIONS (MILLIMETERS)								
A	B	C	D	E	F	G	H	J
300	450	25	131	100	125D	44	59	38

DIMENSIONS (INCHES)								
A	B	C	D	E	F	G	H	J
12	18	1	5 1/4	4	5D	1 3/4	2 3/8	1 1/2

COLORS

LEGEND & SYMBOL -- WHITE (REFL.)
 INNER BACKGROUND -- GREEN (REFL.)
 OUTER BACKGROUND -- WHITE (REFL.)

M1-9

11/97

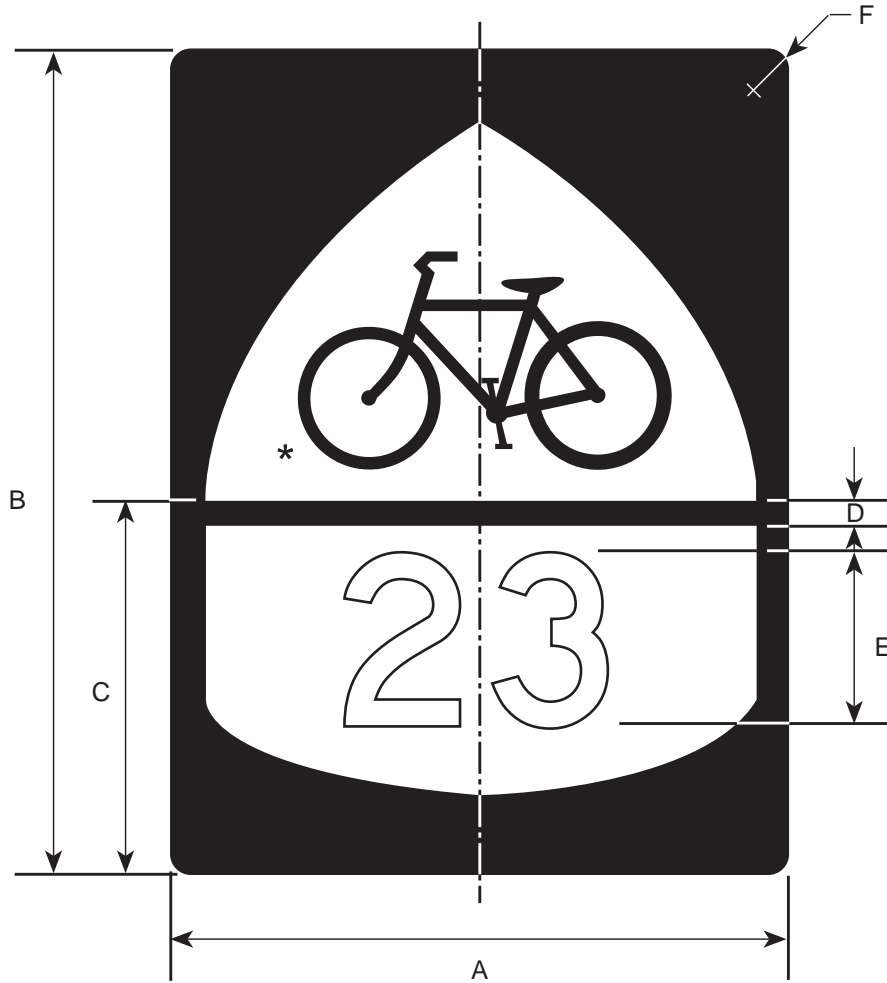

* SEE APPENDIX FOR SYMBOL DESIGN

DIMENSIONS (MILLIMETERS)					
A	B	C	D	E	F
450	600	268.7	12.5	125D	37.5

DIMENSIONS (INCHES)					
A	B	C	D	E	F
18	24	10 3/4	1/2	5D	1 1/2

COLORS

LEGEND - BLACK (NON-REFL)
 INNER BACKGROUND - WHITE (REFL)
 OUTER BACKGROUND - BLACK (NON-REFL)

M2-1 & M2-2

11/97

M2-1

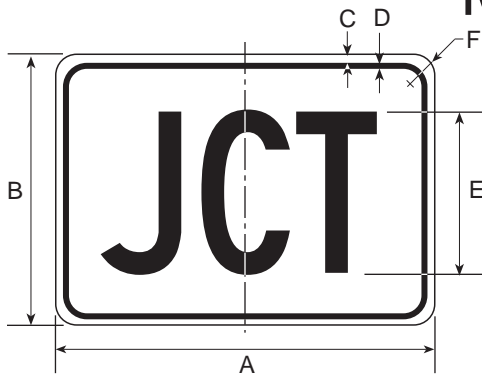

DIMENSIONS (MILLIMETERS)					
A	B	C	D	E	F
525	375	9.37	15.62	225C	37.5

COLORS
 LEGEND - BLACK (NON-REFL)
 BACKGROUND - WHITE (REFL)

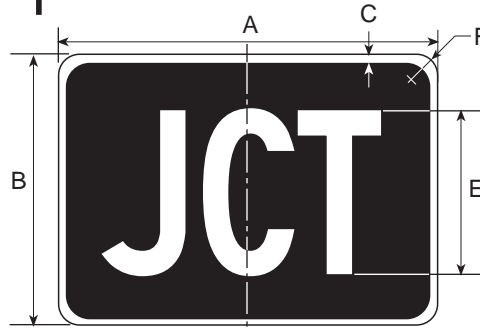

INTERSTATE

DIMENSIONS (INCHES)					
A	B	C	D	E	F
21	15	3/8	5/8	9C	1 1/2

COLORS
 LEGEND - WHITE (REFL)
 BACKGROUND - BLUE (REFL)

M2-2

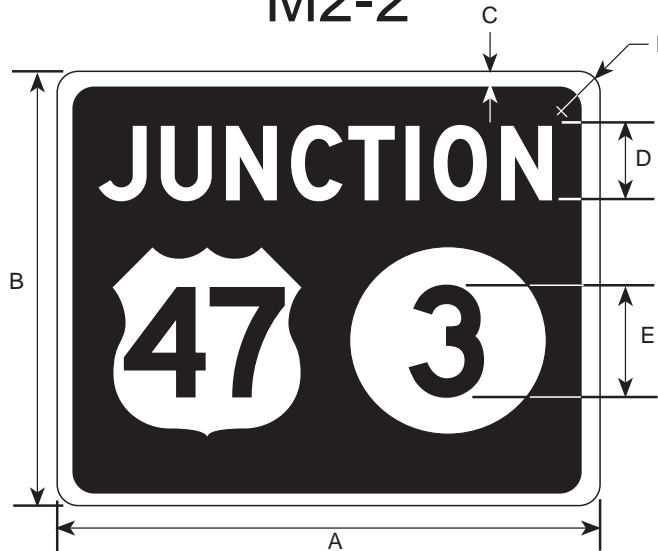

* USE STANDARD SHIELD DESIGNS
 *INCREASE WIDTH WHERE MORE THAN TWO SHIELDS ARE USED

DIMENSIONS					
A	B	C	D	E	F
1500	1200	18.75	200D	300C	75

DIMENSIONS					
A	B	C	D	E	F
60	48	3/4	8D	12D	3

COLORS
 BORDER AND SHIELD - WHITE (REFL)
 LEGEND - LINE 1-WHITE (REFL) LINE 2-BLACK (NON-REFL)
 BACKGROUND - BLACK (NON-REFL) OR GREEN

M3-1

03/03

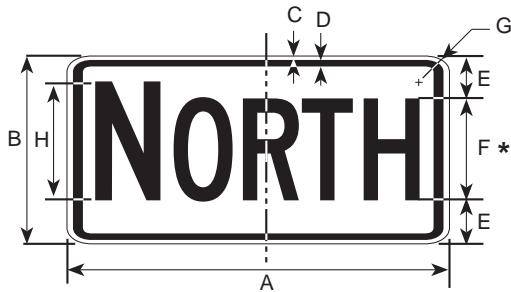

M3-2

03/03

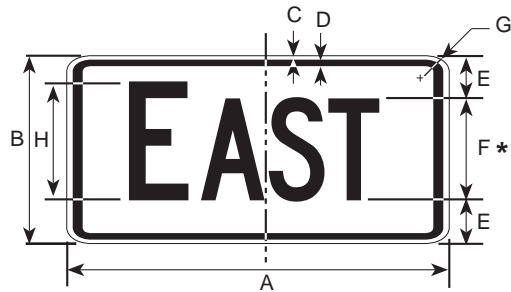

* Reduce Spacing 20% for 24" width sign and 50% for 30" width sign

DIMENSIONS (MILLIMETERS)							
A	B	C	D	E	F	G	H
600	300	9	16	75	150C	38	175C
750	375	9	16	88	200C	38	225C

DIMENSIONS (MILLIMETERS)							
A	B	C	D	E	F	G	H
600	300	9	16	75	150C	38	175C
750	375	9	16	88	200C	38	225C

DIMENSIONS (INCHES)							
A	B	C	D	E	F	G	H
24	12	3/8	5/8	3	6C	1 1/2	7C
30	15	3/8	5/8	3 1/2	8C	1 1/2	9C

DIMENSIONS (INCHES)							
A	B	C	D	E	F	G	H
24	12	3/8	5/8	3	6C	1 1/2	7C
30	15	3/8	5/8	3 1/2	8C	1 1/2	9C

COLORS

LEGEND - BLACK (REFL.)
BACKGROUND - WHITE (REFL.)

M3-1B

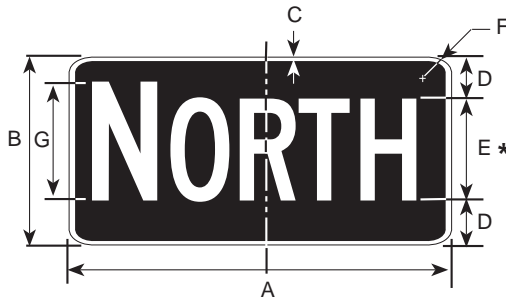

(INTERSTATE)

M3-2B

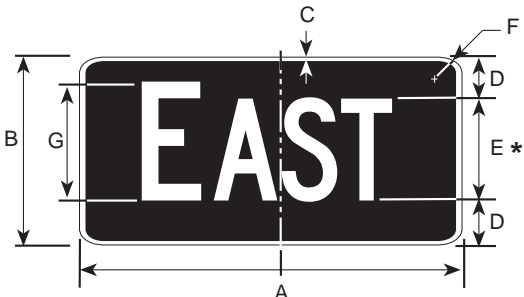

(INTERSTATE)

USE 30" X 15" SIZE WITH 30" X 24" SHIELD OR WITH 36" X 36" SHIELD

* Reduce Spacing 20% for 24" width sign and 50% for 30" width sign

DIMENSIONS (MILLIMETERS)						
A	B	C	D	E	F	G
600	300	13	75	150C	38	175C
750	375	13	88	200C	38	225C

DIMENSIONS (MILLIMETERS)						
A	B	C	D	E	F	G
600	300	13	75	150C	38	175C
750	375	13	88	200C	38	225C

DIMENSIONS (INCHES)						
A	B	C	D	E	F	G
24	12	1/2	3	6C	1 1/2	7C
30	15	1/2	3 1/2	8C	1 1/2	9C

DIMENSIONS (INCHES)						
A	B	C	D	E	F	G
24	12	1/2	3	6C	1 1/2	7C
30	15	1/2	3 1/2	8C	1 1/2	9C

COLORS

LEGEND - WHITE (REFL.)
BACKGROUND - BLUE (REFL.)

M3-3

6/03

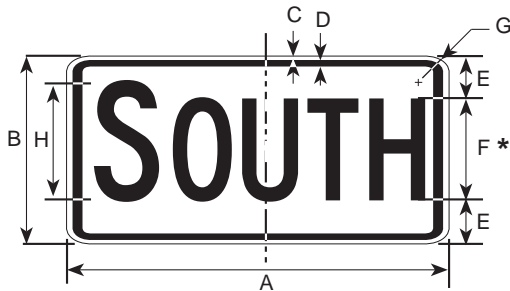

M3-4

6/03

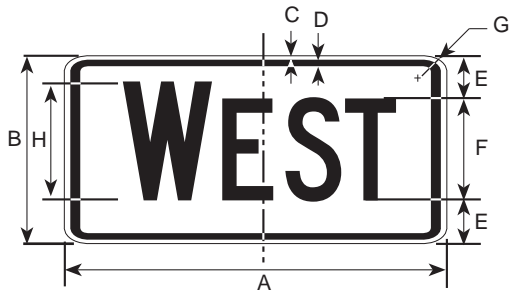

* Reduce Spacing 20% for 24" width sign and 50% for 30" width sign

DIMENSIONS (MILLIMETERS)							
A	B	C	D	E	F	G	H
600	300	9	16	75	150C	38	175C
750	375	9	16	88	200C	38	225C

DIMENSIONS (MILLIMETERS)							
A	B	C	D	E	F	G	H
600	300	9	16	75	150C	38	175C
750	375	9	16	88	200C	38	225C

DIMENSIONS (INCHES)							
A	B	C	D	E	F	G	H
24	12	3/8	5/8	3	6C	1 1/2	7C
30	15	3/8	5/8	3 1/2	8C	1 1/2	9C

DIMENSIONS (INCHES)							
A	B	C	D	E	F	G	H
24	12	3/8	5/8	3	6C	1 1/2	7C
30	15	3/8	5/8	3 1/2	8C	1 1/2	9C

COLORS

LEGEND - BLACK (REFL.)

BACKGROUND - WHITE (REFL.)

M3-3B

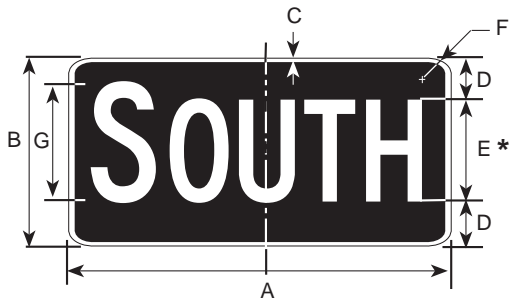

(INTERSTATE)

M3-4B

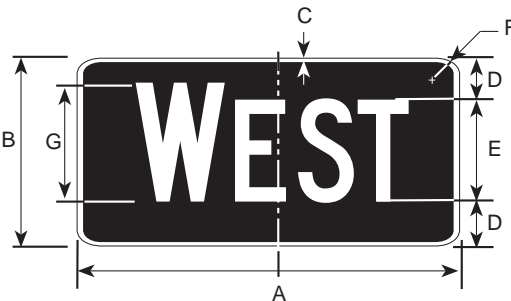

(INTERSTATE)

USE 30" X 15" SIZE WITH 30" X 24" SHIELD OR WITH 36" X 36" SHIELD

* Reduce Spacing 20% for 24" width sign and 50% for 30" width sign

DIMENSIONS (MILLIMETERS)						
A	B	C	D	E	F	G
600	300	13	75	150C	38	175C
750	375	13	88	200C	38	225C

DIMENSIONS (MILLIMETERS)						
A	B	C	D	E	F	G
600	300	13	75	150C	38	175C
750	375	13	88	200C	38	225C

DIMENSIONS (INCHES)						
A	B	C	D	E	F	G
24	12	1/2	3	6C	1 1/2	7C
30	15	1/2	3 1/2	8C	1 1/2	9C

DIMENSIONS (INCHES)						
A	B	C	D	E	F	G
24	12	1/2	3	6C	1 1/2	7C
30	15	1/2	3 1/2	8C	1 1/2	9C

COLORS

LEGEND - WHITE (REFL.)

BACKGROUND - BLUE (REFL.)

M4-1

11/97



DIMENSIONS (MILLIMETERS)						
A	B	C	D	E	F	G
600	300	9	16	100	100B	38
750	375	9	16	11	150B	38

DIMENSIONS (INCHES)						
A	B	C	D	E	F	G
24	12	3/8	5/8	4	4B	1 1/2
30	15	3/8	5/8	4 1/2	6B	1 1/2

M4-101

5/97

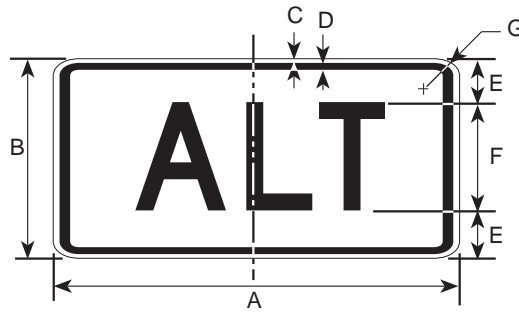

DIMENSIONS (MILLIMETERS)						
A	B	C	D	E	F	G
600	300	9	16	75	150C	38
750	375	9	16	88	200C	38

DIMENSIONS (INCHES)						
A	B	C	D	E	F	G
24	12	3/8	5/8	3	6C	1 1/2
30	15	3/8	5/8	3 1/2	8C	1 1/2

M4-2

11/97

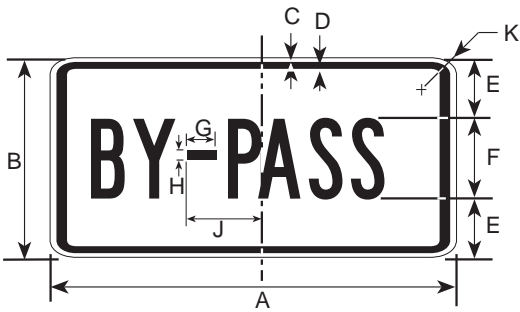

DIMENSIONS (MILLIMETERS)									
A	B	C	D	E	F	G	H	J	K
600	300	9	16	88	125B	19	16	84	38
750	375	9	16	100	175B	25	22	97	38

DIMENSIONS (INCHES)									
A	B	C	D	E	F	G	H	J	K
24	12	3/8	5/8	3 1/2	5B	3/4	5/8	3 3/8	1 1/2
30	15	3/8	5/8	4	7B	1	7/8	3 7/8	1 1/2

M4-3

11/97

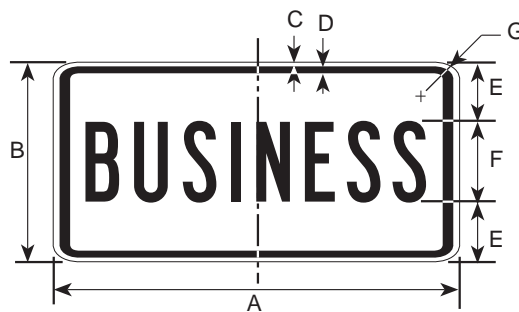

DIMENSIONS (MILLIMETERS)						
A	B	C	D	E	F	G
600	300	9	16	75	150C	38
750	375	9	16	88	200C	38

DIMENSIONS (INCHES)						
A	B	C	D	E	F	G
24	12	3/8	5/8	3 1/2	5B	1 1/2
30	15	3/8	5/8	4	7B	1 1/2

COLORS

LEGEND - BLACK (NON-REFL.)
BACKGROUND - WHITE (REFL.)

M4-4

11/97

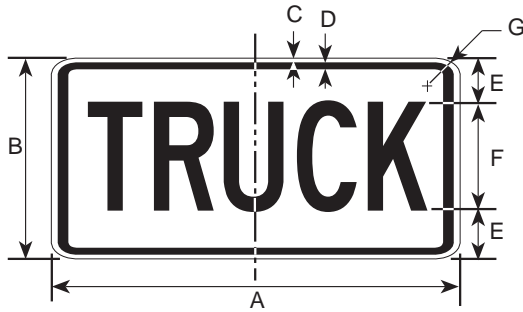

DIMENSIONS (MILLIMETERS)						
A	B	C	D	E	F	G
600	300	9	16	75	150C	38
750	375	9	16	88	200C	38

DIMENSIONS (INCHES)						
A	B	C	D	E	F	G
24	12	3/8	5/8	3	6C	1 1/2
30	15	3/8	5/8	3 1/2	8C	1 1/2

M4-6

11/97

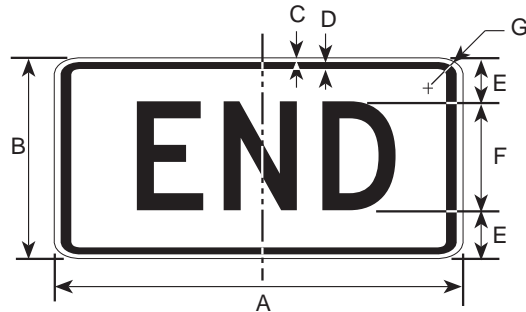

DIMENSIONS (MILLIMETERS)						
A	B	C	D	E	F	G
600	300	9	16	75	150D	38
750	375	9	16	88	200D	38

DIMENSIONS (INCHES)						
A	B	C	D	E	F	G
24	12	3/8	5/8	3	6D	1 1/2
30	15	3/8	5/8	3 1/2	8D	1 1/2

COLORS

LEGEND - BLACK (NON-REFL.)

BACKGROUND - WHITE (REFL.)

M4-5

11/97

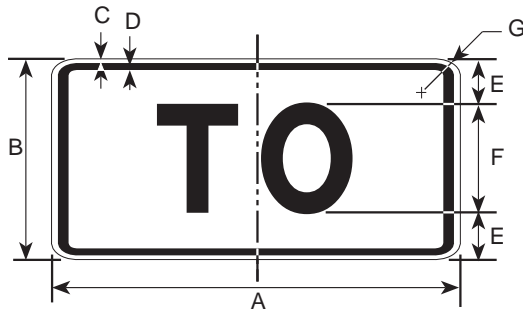

DIMENSIONS (MILLIMETERS)						
A	B	C	D	E	F	G
600	300	9	16	75	150E	38
750	375	9	16	88	200E	38

DIMENSIONS (INCHES)						
A	B	C	D	E	F	G
24	12	3/8	5/8	3	6E	1 1/2
30	15	3/8	5/8	3 1/2	8E	1 1/2

COLORS

LEGEND - BLACK (NON-REFL.)

BACKGROUND - WHITE (REFL.)

M4-5B

11/97

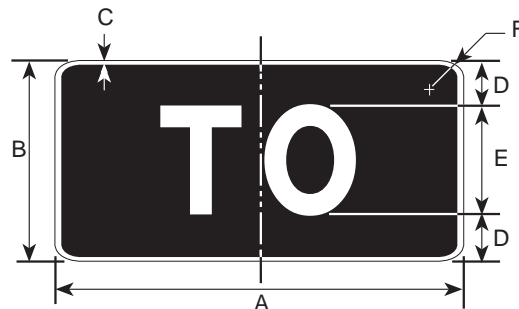

(INTERSTATE)

DIMENSIONS (MILLIMETERS)					
A	B	C	D	E	F
600	300	13	75	150E	38
750	375	13	88	200E	38

DIMENSIONS (INCHES)					
A	B	C	D	E	F
24	12	1/2	3	6E	1 1/2
30	15	1/2	3 1/2	8E	1 1/2

COLORS

LEGEND - WHITE (REFL.)

BACKGROUND - BLUE (REFL.)

M4-7

11/97

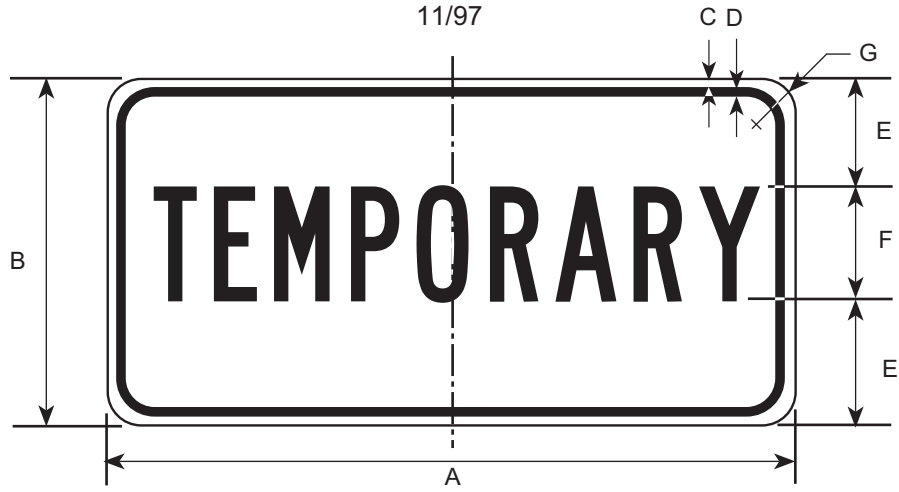

COLORS

LEGEND—BLACK (NON-REFL)
BACKGROUND—WHITE (REFL)

M4-7B

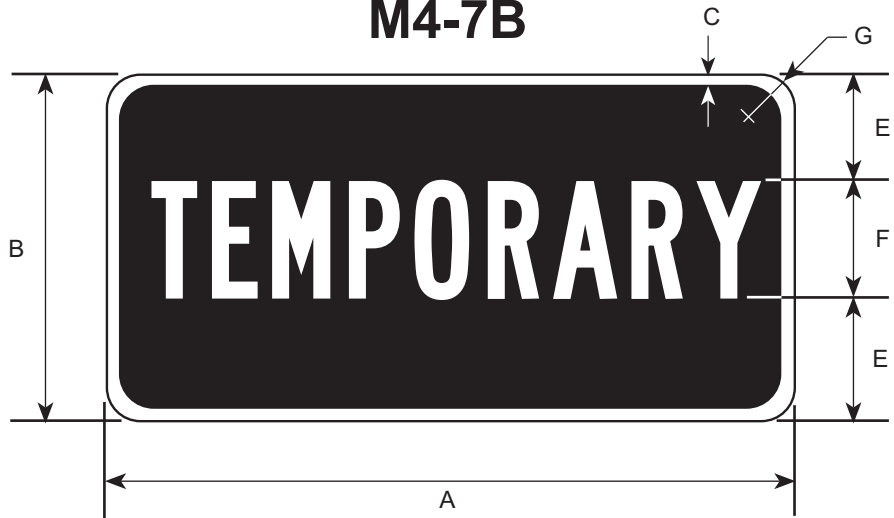

COLORS

LEGEND—WHITE (REFL)
BACKGROUND—BLUE (REFL)

DIMENSIONS (MILLIMETERS)

A	B	C	D	E	F	G
600	300	9	16	100	100B	38
750	375	9	16	125	125B	38

DIMENSIONS (INCHES)

A	B	C	D	E	F	G
24	12	3/8	5/8	4	4B	1 1/2
30	15	3/8	5/8	5	5B	1 1/2

M4-7A

2/06

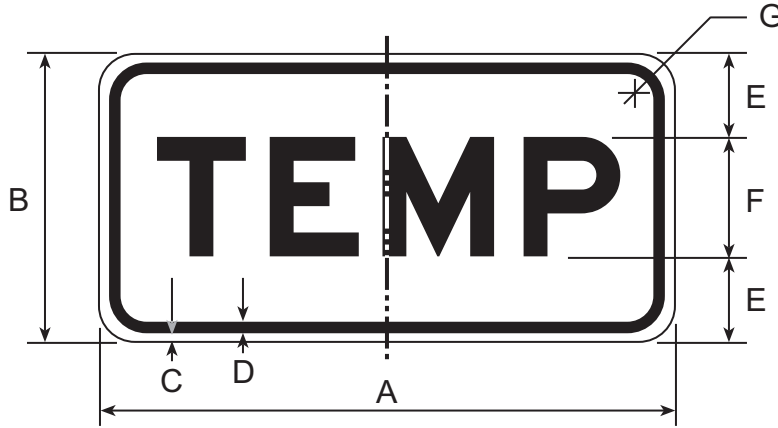

COLORS

LEGEND - BLACK (NON-REFL)
BACKGROUND - WHITE (REFL)

M4-7B

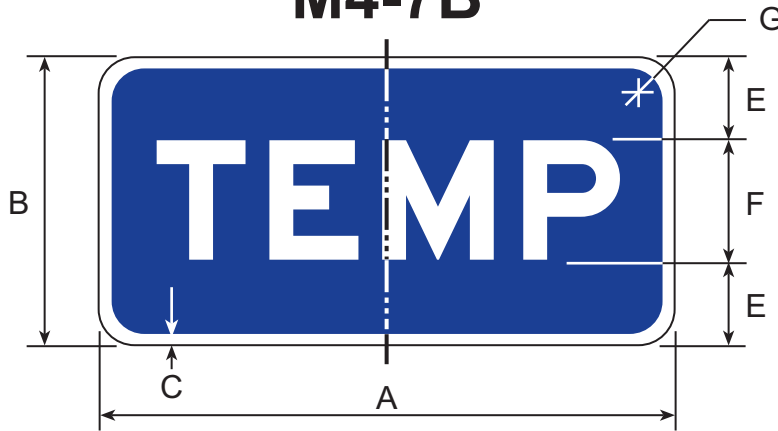

COLORS

LEGEND - WHITE (REFL)
BACKGROUND - BLUE (REFL)

DIMENSIONS (MILLIMETERS)						
A	B	C	D	E	F	G
600	300	9	16	87.5	125E	38
750	375	9	16	112.5	150E	38

DIMENSIONS (INCHES)						
A	B	C	D	E	F	G
24	12	3/8	5/8	3 1/2	5E	1 1/2
30	15	3/8	5/8	4 1/2	6E	1 1/2

M4-8

11/97



DIMENSIONS (MILLIMETERS)					
A	B	C	D	E	F
60	30	9	1	15	4
75	37	9	1	200	4

DIMENSIONS (INCHES)					
A	B	C	D	E	F
2	1	3/8	5/8	6	1
3	1	3/8	5/8	8	1

COLORS
LEGEND — BLACK (NON-REFL)
BACKGROUND-ORANGE (REFL)

M4-9L/R

5/06

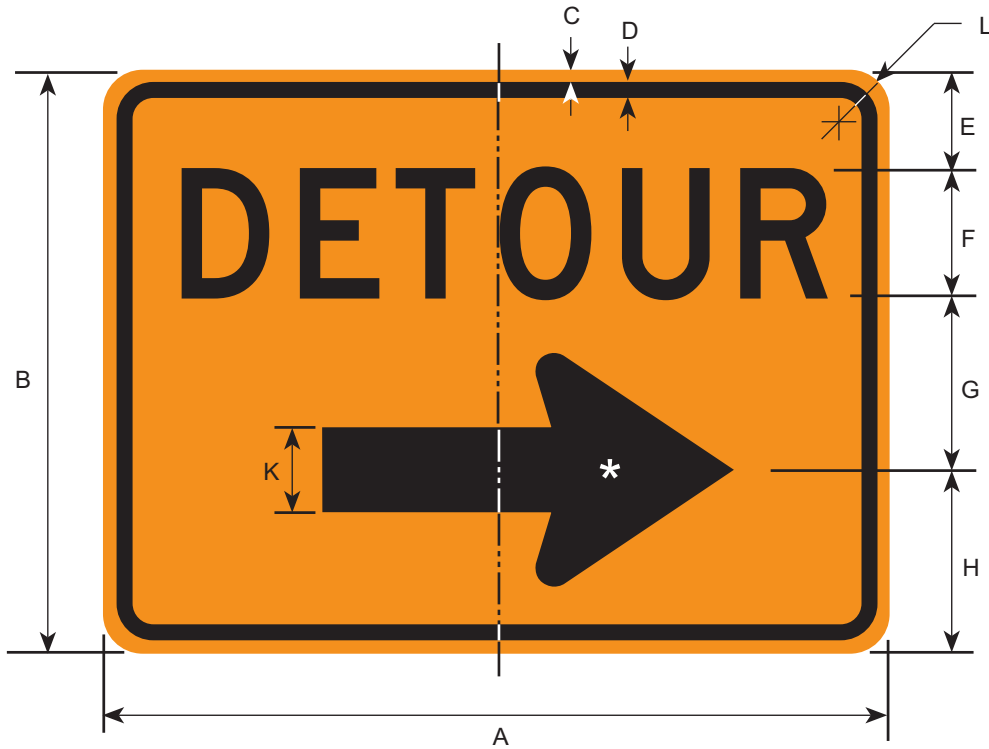

* SEE APPENDIX FOR STANDARD ARROW DETAILS

DIMENSIONS (MILLIMETERS)									
A	B	C	D	E	F	G	H	K	L
750	600	9	16	100	125D	175	200	113	38
1200	900	16	22	150	200D	250	300	175	56
1500	1200	19	31	200	250D	350	400	225	75

DIMENSIONS (INCHES)									
A	B	C	D	E	F	G	H	K	L
30	24	3/8	5/8	4	5D	7	8	4 1/2	1 1/2
48	36	5/8	7/8	6	8D	10	12	7	2 1/4
60	48	3/4	1 1/4	8	10D	14	16	9	3

COLORS

LEGEND, ARROW, & BORDER — BLACK (NON-REFL)
 BACKGROUND — ORANGE (REFL)

M4-9A

5/06

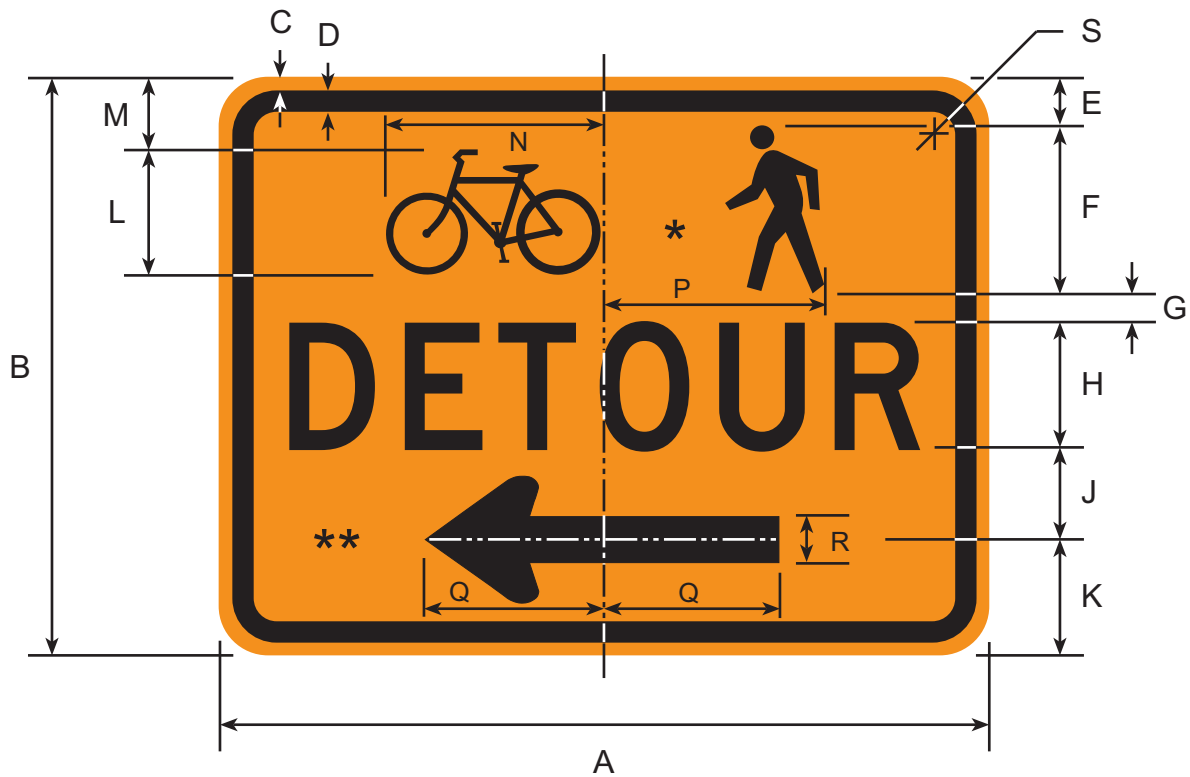

* SEE APPENDIX FOR SYMBOL DESIGNS

** SEE APPENDIX FOR STANDARD ARROW DETAILS

DIMENSIONS (INCHES)									
A	B	C	D	E	F	G	H	J	K
30	24	1/2	3/4	2	7 13/64	1	5D	3 51/64	5
48	36	3/4	1 1/4	3	10 41/64	1 41/64	8D	5 59/64	6 51/64
60	48	3/4	1 1/4	5 13/64	13 21/64	2 5/64	10D	7 13/32	10

L	M	N	P	Q	R	S
5 21/64	3 1/8	9	8 17/32	7	2	1 7/8
6 59/64	4 13/32	13 17/32	13 19/64	11 13/64	3 13/64	3
8 5/64	10 1/8	16 13/16	16 13/16	14	4	3

COLORS

LEGEND, SYMBOLS, & BORDER - BLACK (NON-REFL)
BACKGROUND - ORANGE (REFL)

M4-9B

5/06

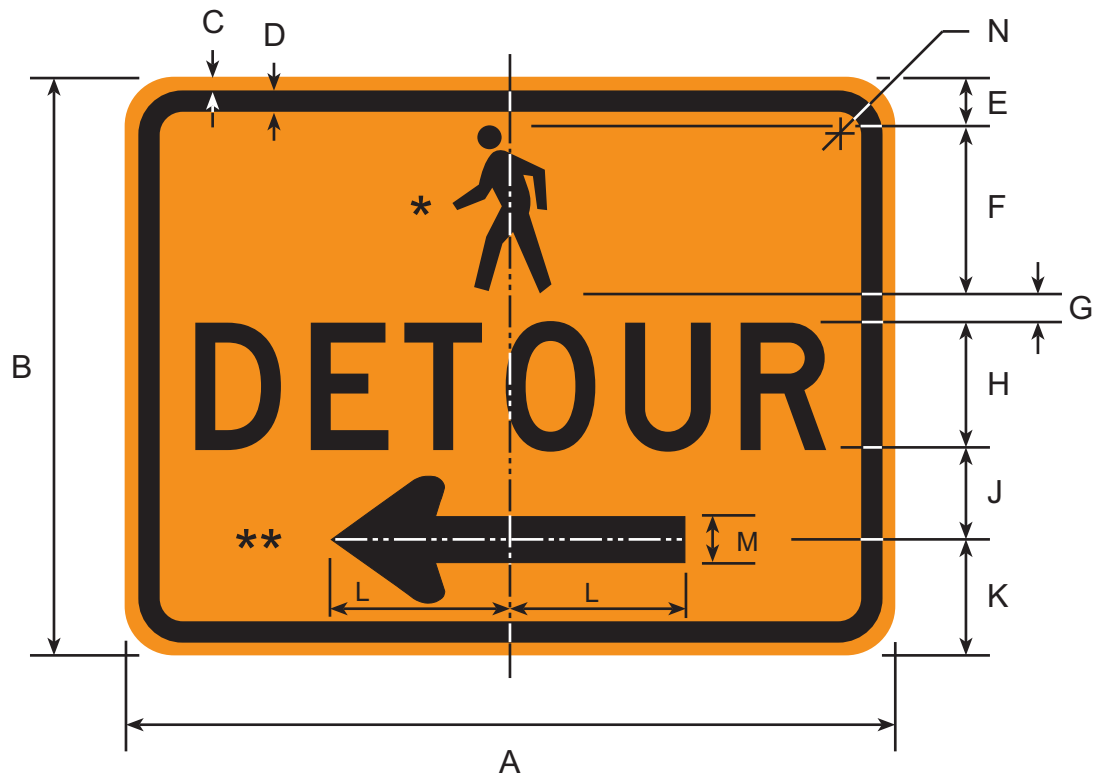

* SEE APPENDIX FOR SYMBOL DESIGN

** SEE APPENDIX FOR STANDARD ARROW DETAILS

DIMENSIONS (INCHES)						
A	B	C	D	E	F	G
30	24	1/2	3/4	2	7 13/64	1
48	36	3/4	1 1/4	3	10 41/64	1 41/64
60	48	3/4	1 1/4	5 13/64	13 21/64	2 5/64

H	J	K	L	M	N
5D	3 51/64	5	7	2	1 7/8
8D	5 59/64	6 51/64	11 13/64	3 13/64	3
10D	7 13/32	10	14	4	3

COLORS

LEGEND, SYMBOLS, & BORDER - BLACK (NON-REFL)
BACKGROUND - ORANGE (REFL)

M4-9C

5/06

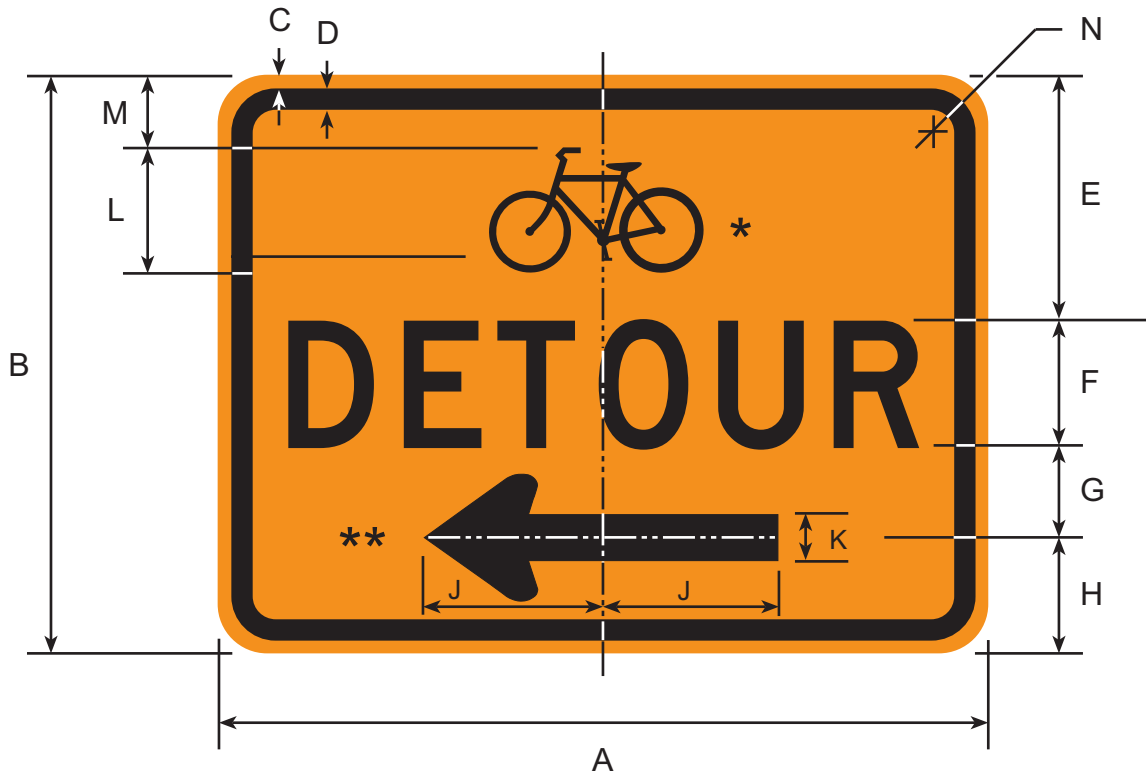

* SEE APPENDIX FOR SYMBOL DESIGN

** SEE APPENDIX FOR STANDARD ARROW DETAILS

DIMENSIONS (INCHES)						
A	B	C	D	E	F	G
30	24	1/2	3/4	10 13/64	5D	3 51/64
48	36	3/4	1 1/4	15 19/64	8D	5 59/64
60	48	3/4	1 1/4	20 39/64	10D	7 13/32

H	J	K	L	M	N
5	7	2	5 21/64	9	1 7/8
6 51/64	11 13/64	3 13/64	6 59/64	13 17/32	3
10	14	4	8 5/64	16 13/16	3

COLORS

LEGEND, SYMBOLS, & BORDER - BLACK (NON-REFL)
BACKGROUND - ORANGE (REFL)

M4-10L & M4-10R

11/97

M4-10L

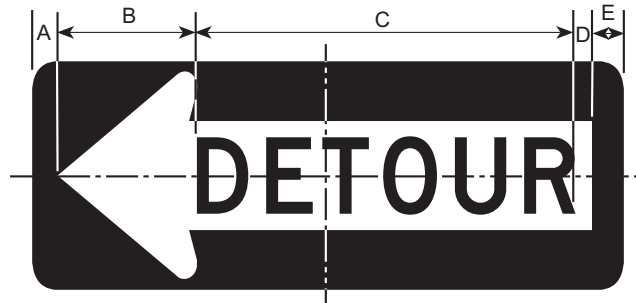

DIMENSIONS (MILLIMETERS)

A	B	C	D	E
69	313	694	50	75

DIMENSIONS (INCHES)

A	B	C	D	E
2 3/4	12 1/2	27 3/4	2	3

M4-10R

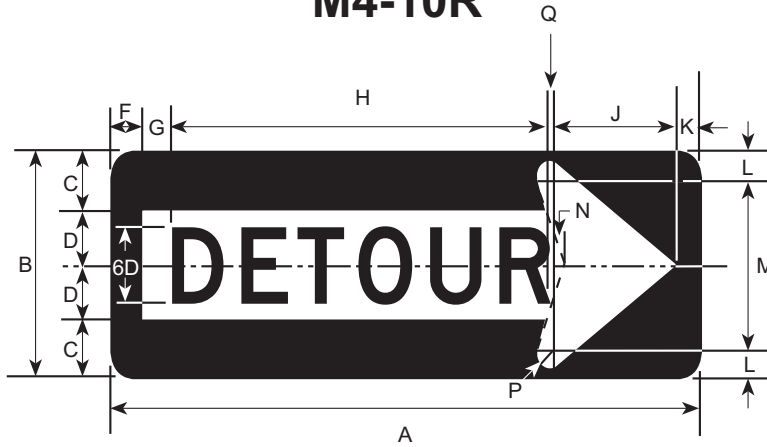

DIMENSIONS (MILLIMETERS)

A	B	C	D	E	F	G	H	J	K	L	M	N	P	Q
1200	450	122	103	150D	75	50	694	300	69	56	338	19	31	13

DIMENSIONS (INCHES)

A	B	C	D	E	F	G	H	J	K	L	M	N	P	Q
48	18	4 7/8	4 1/8	6D	3	2	27 3/4	12	2 3/4	2 1/4	13 1/2	3/4	1 1/4	1/2

COLORS

- LEGEND - BLACK (NON-REFL.)
- ARROW - ORANGE (REFL.)
- BACKGROUND - BLACK (NON - REFL.)

M4-11, M4-12 & M4-13

11/97

M4-11

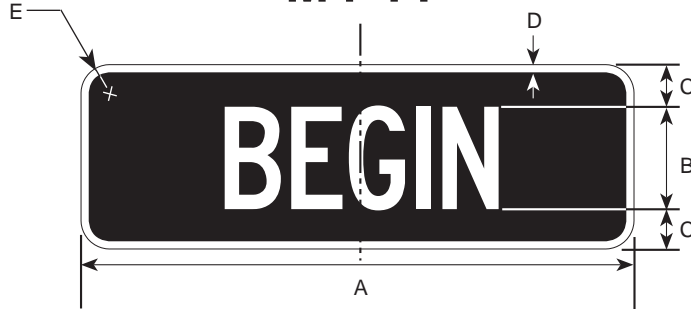

DIMENSIONS (MILLIMETERS)				
A	B	C	D	E
600	100C	25	13	38

DIMENSIONS (INCHES)				
A	B	C	D	E
24	4C	1	1/2	1 1/2

M4-12

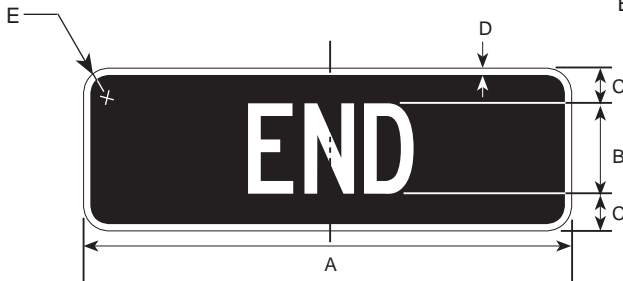

DIMENSIONS (MILLIMETERS)				
A	B	C	D	E
600	100C	25	13	38

DIMENSIONS (INCHES)				
A	B	C	D	E
24	4C	1	1/2	1 1/2

M4-13

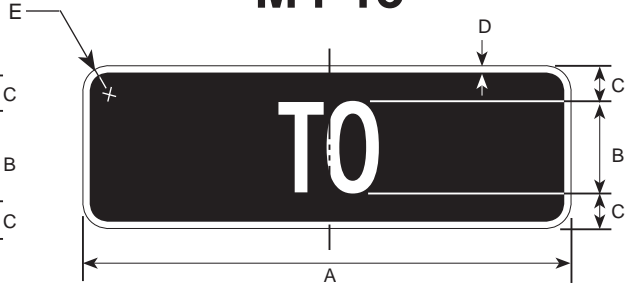

DIMENSIONS (MILLIMETERS)				
A	B	C	D	E
600	100C	25	13	38

DIMENSIONS (INCHES)				
A	B	C	D	E
24	4C	1	1/2	1 1/2

COLORS

LEGEND - WHITE (REFL)
BACKGROUND - GREEN (REFL)

M4-1101, M4-1201, & M4-1301

11/97

(BICYCLE ROUTES)

M4-1101



DIMENSIONS (MILLIMETERS)				
A	B	C	D	E
300	50C	25	6	19

DIMENSIONS (INCHES)				
A	B	C	D	E
12	2C	1	1/4	3/4

M4-1201

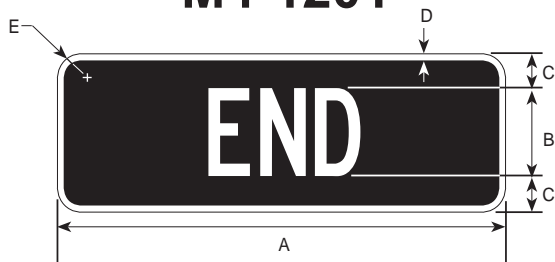

DIMENSIONS (MILLIMETERS)				
A	B	C	D	E
300	100C	25	6	19

DIMENSIONS (INCHES)				
A	B	C	D	E
12	2C	1	1/4	3/4

M4-1301

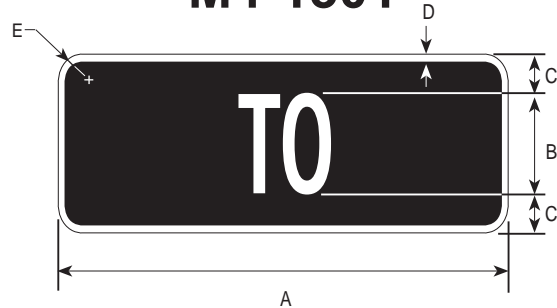

DIMENSIONS (MILLIMETERS)				
A	B	C	D	E
300	50C	25	6	19

DIMENSIONS (INCHES)				
A	B	C	D	E
12	2C	1	1/4	3/4

COLORS

LEGEND - WHITE (REFL)
BACKGROUND - GREEN (REFL)

M5-1

5/06

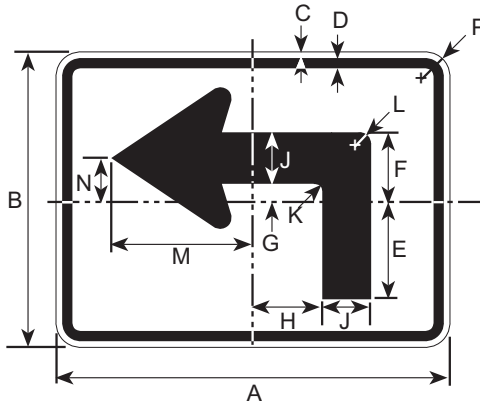

M5-1B

5/06

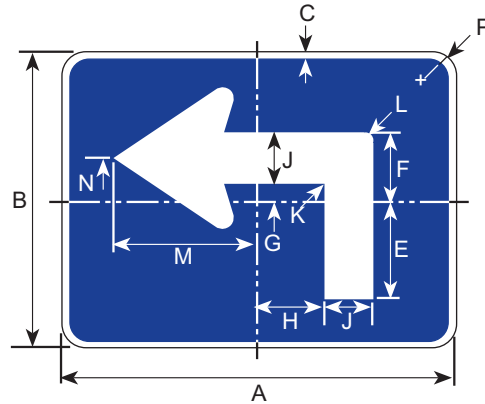

DIMENSIONS (MILLIMETERS)													
A	B	C	D	E	F	G	H	J	K	L	M	N	P
525	375	9	16	127	84	22	80	66	9	14	178	52	38

DIMENSIONS (INCHES)													
A	B	C	D	E	F	G	H	J	K	L	M	N	P
21	15	3/8	5/8	5 1/16	3 3/8	3/4	3 3/16	2 5/8	3/8	9/16	7 1/8	2 1/16	1 1/2

M5-2

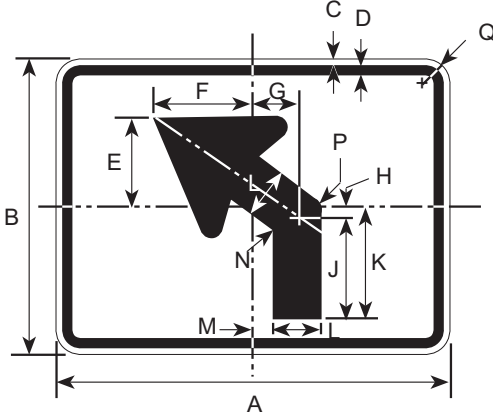

M5-2B

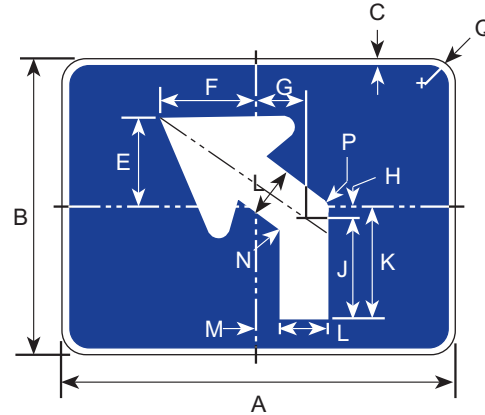

DIMENSIONS (MILLIMETERS)													
A	B	C	E	F	G	H	J	K	L	M	N	P	Q
525	375	9	119	113	61	19	117	136	66	28	9	14	38

DIMENSIONS (INCHES)														
A	B	C	D	E	F	G	H	J	K	L	M	N	P	Q
21	15	3/8	5/8	4 3/4	4 1/2	2 7/16	3/4	4 11/16	5 7/16	2 5/8	1 1/8	3/8	9/16	1 1/2

COLORS

ARROW & BORDER - BLACK (NON-REFL)
BACKGROUND - WHITE (REFL)

COLORS

ARROW - WHITE (REFL)
BACKGROUND - BLUE (REFL)

M6-1

6/00

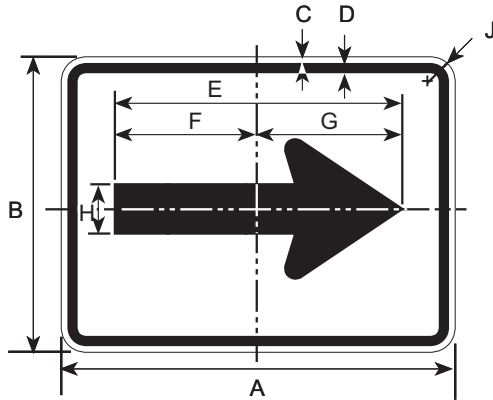

M6-1B

6/00

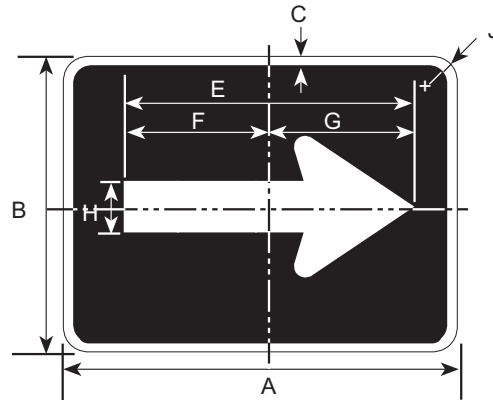

DIMENSIONS (MILLIMETERS)								
A	B	C	D	E	F	G	H	J
525	375	9	16	52	178	188	66	38

DIMENSIONS (INCHES)								
A	B	C	D	E	F	G	H	J
21	15	3/8	5/8	14 5/8	7 1/8	7 1/2	2 5/8	1 1/2

M6-2R

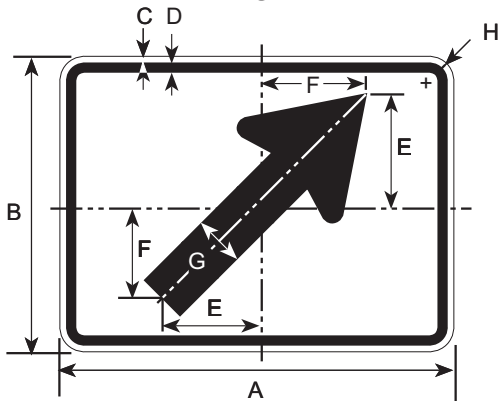

M6-2BR

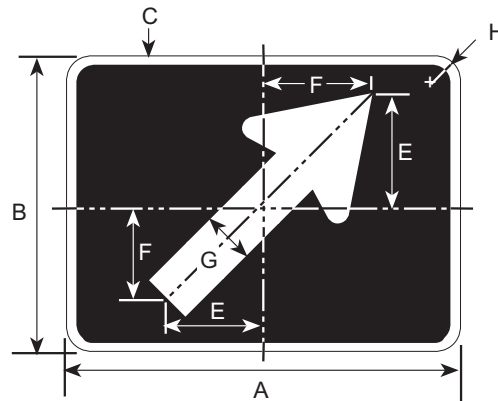

M6-2L



DIMENSIONS (MILLIMETERS)							
A	B	C	D	E	F	G	H
525	375	9	16	127	141	66	38

DIMENSIONS (INCHES)							
A	B	C	D	E	F	G	H
21	15	3/8	5/8	5 1/16	5 5/8	2 5/8	1 1/2

M6-2BL



COLORS

LEGEND - BLACK (NON-REFL.)
BACKGROUND - WHITE (REFL.)

COLORS

LEGEND - WHITE (REFL.)
BACKGROUND - BLUE (REFL.)

M6-3

11/97

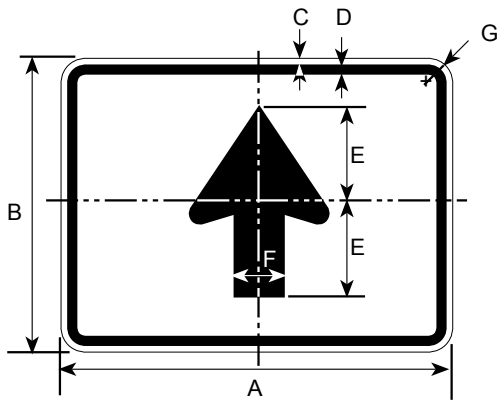

M6-3B

11/97

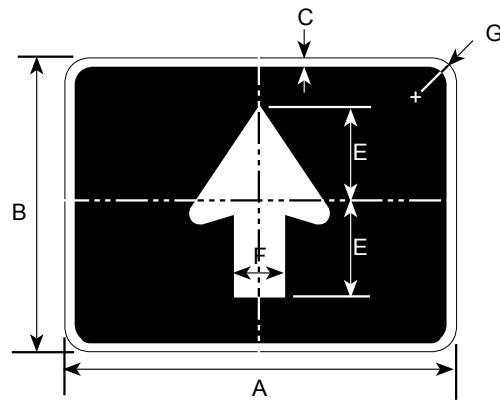

DIMENSIONS (MILLIMETERS)						
A	B	C	D	E	F	G
525	375	9	16	122	66	38

DIMENSIONS (INCHES)						
A	B	C	D	E	F	G
21	15	3/8	5/8	4 7/8	2 5/8	1 1/2

M6-4

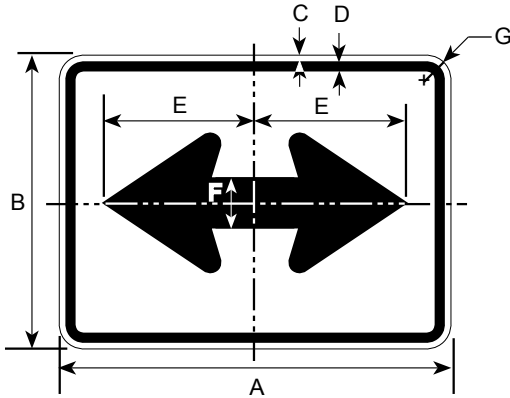

M6-4B

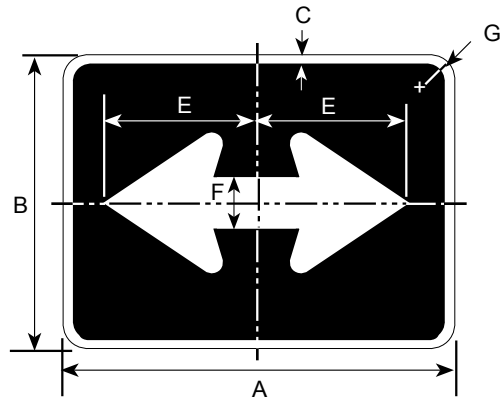

DIMENSIONS (MILLIMETERS)						
A	B	C	D	E	F	G
525	375	9	16	188	66	38

DIMENSIONS (INCHES)						
A	B	C	D	E	F	G
21	15	3/8	5/8	7 1/2	2 5/8	1 1/2

COLORS
 LEGEND - BLACK (NON-REFL.)
 BACKGROUND - WHITE (REFL.)

COLORS
 LEGEND - WHITE (REFL.)
 BACKGROUND - BLUE (REFL.)

M6-5

11/97

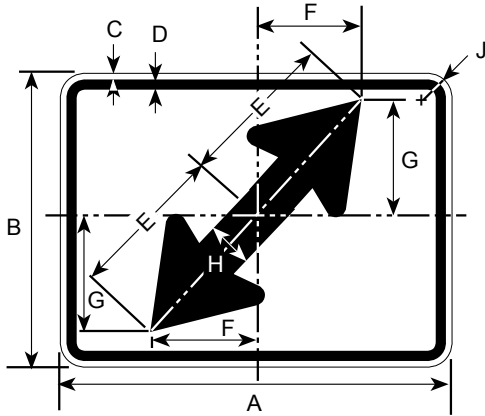

M6-5B

11/97

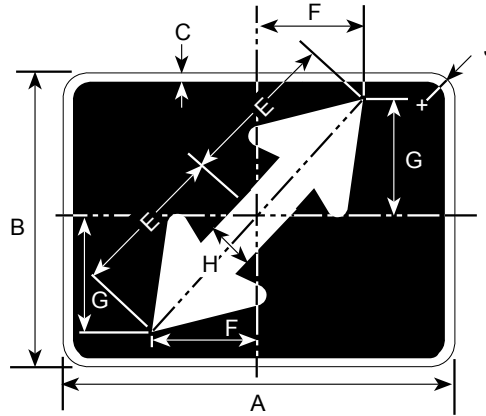

DIMENSIONS (MILLIMETERS)								
A	B	C	D	E	F	G	H	J
525	375	9	16	197	237	131	56	38

DIMENSIONS (INCHES)								
A	B	C	D	E	F	G	H	J
21	15	3/8	5/8	7 7/8	5 7/8	5 1/4	2 1/4	1 1/2

M6-6

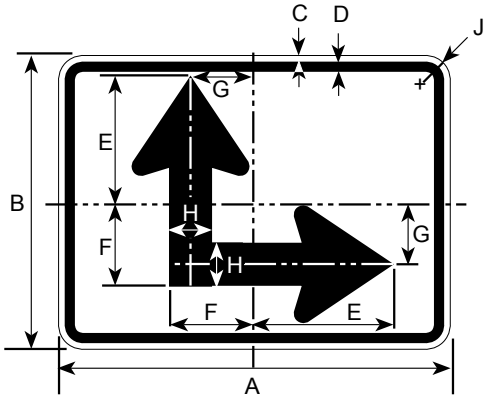

M6-6B

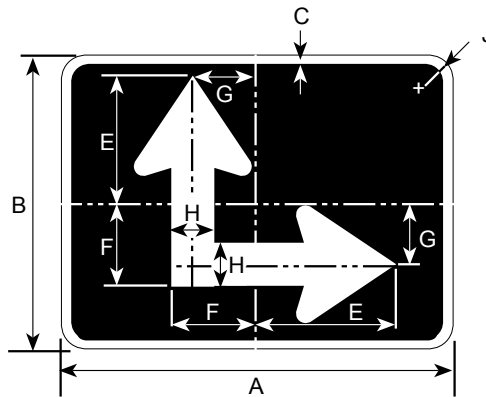

DIMENSIONS (MILLIMETERS)								
A	B	C	D	E	F	G	H	J
525	375	9	16	144	97	69	56	38

DIMENSIONS (INCHES)								
A	B	C	D	E	F	G	H	J
21	15	3/8	5/8	5 3/4	3 7/8	2 3/4	2 1/4	1 1/2

COLORS

LEGEND - BLACK (NON-REFL.)
BACKGROUND - WHITE (REFL.)

COLORS

LEGEND - WHITE (REFL.)
BACKGROUND - BLUE (REFL.)

M6-7

11/97

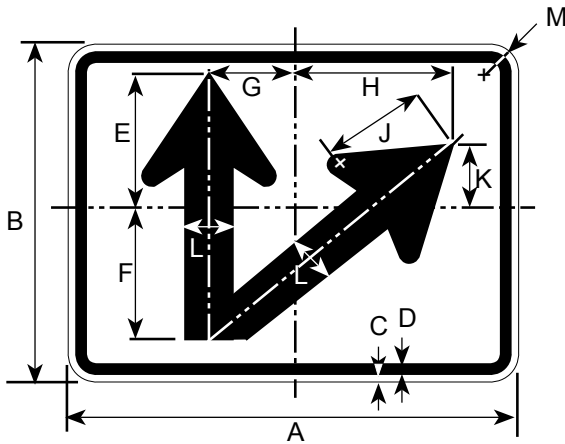

M6-7B

11/97

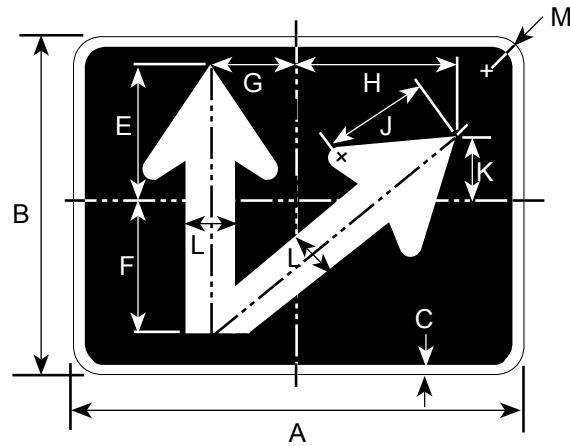

DIMENSIONS (MILLIMETERS)											
A	B	C	D	E	F	G	H	J	K	L	M
525	375	9	16	144	138	97	169	11	53	56	38

DIMENSIONS (INCHES)											
A	B	C	D	E	F	G	H	J	K	L	M
21	15	3/8	5/8	5 3/4	5 1/2	3 7/8	6 3/4	4 1/2	2 1/8	2 1/4	1 1/2

COLORS

LEGEND - BLACK (NON-REFL.)
BACKGROUND - WHITE (REFL.)

COLORS

LEGEND - WHITE (REFL.)
BACKGROUND - BLUE (REFL.)

M7-1, M7-2 & M7-3

11/97

M7-1

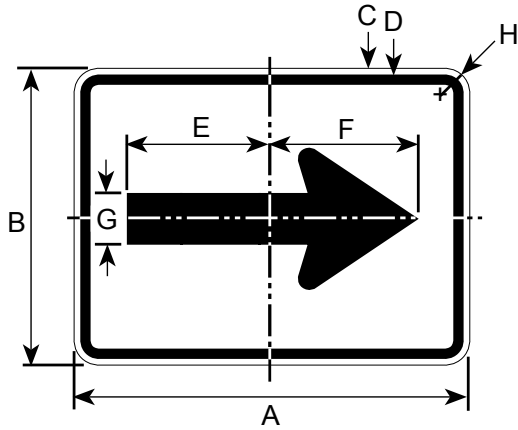

DIMENSIONS (MILLIMETERS)							
A	B	C	D	E	F	G	H
300	225	134	9	106	11	41	38

DIMENSIONS (INCHES)							
A	B	C	D	E	F	G	H
12	9	5 3/8	3/8	4 1/4	4 1/2	1 5/8	1 1/2

M7-2

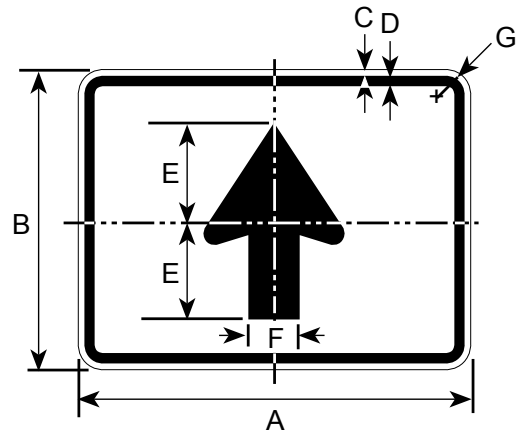

DIMENSIONS (MILLIMETERS)						
A	B	C	D	E	F	G
300	225	9	9	75	41	1 1/2

DIMENSIONS (INCHES)						
A	B	C	D	E	F	G
12	9	3/8	3/8	3	1 5/8	1 1/2

M7-3

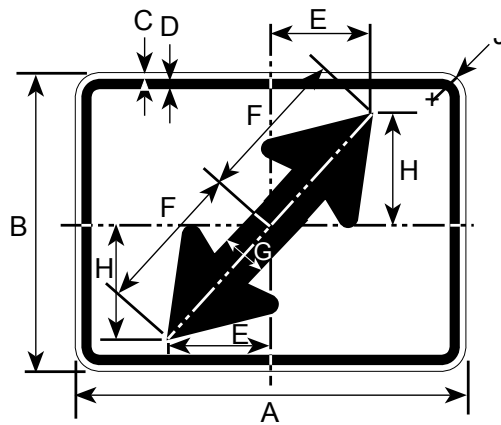

DIMENSIONS (MILLIMETERS)								
A	B	C	D	E	F	G	H	J
300	225	9	9	91	11	34	75	38

DIMENSIONS (INCHES)								
A	B	C	D	E	F	G	H	J
12	9	3/8	3/8	3 5/8	4 1/2	1 3/8	3	1 1/2

COLORS

LEGEND - BLACK (NON-REFL.)
BACKGROUND - WHITE (REFL.)

M7-4, M7-5, M7-6 & M7-7

11/97

M7-4

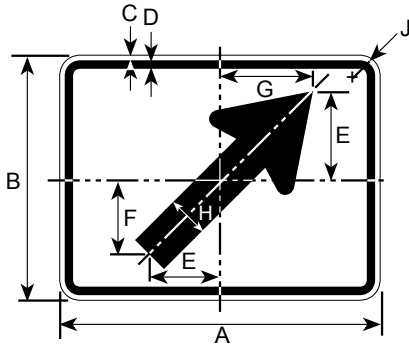

DIMENSIONS (MILLIMETERS)								
A	B	C	D	E	F	G	H	J
300	225	9	9	75	66	84	41	38

DIMENSIONS (INCHES)								
A	B	C	D	E	F	G	H	J
12	9	3/8	3/8	3	2 5/8	3 3/8	1 5/8	1 1/2

M7-5

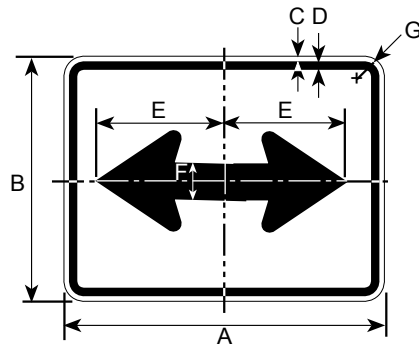

DIMENSIONS (MILLIMETERS)						
A	B	C	D	E	F	G
300	225	9	9	109	41	38

DIMENSIONS (INCHES)						
A	B	C	D	E	F	G
12	9	3/8	3/8	4 3/8	1 5/8	1 1/2

M7-6

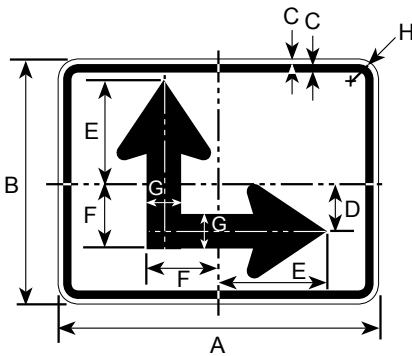

DIMENSIONS (MILLIMETERS)							
A	B	C	D	E	F	G	H
300	225	9	41	84	56	34	38

DIMENSIONS (INCHES)							
A	B	C	D	E	F	G	H
12	9	3/8	1 5/8	3 3/8	2 1/4	1 3/8	1 1/2

M7-7

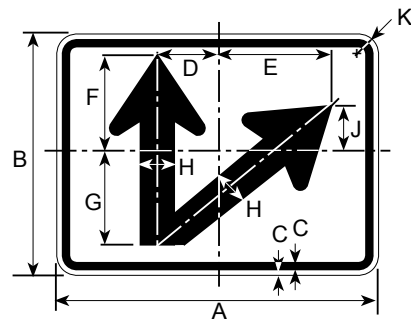

DIMENSIONS (MILLIMETERS)									
A	B	C	D	E	F	G	H	J	K
300	225	9	56	100	84	78	34	31	38

DIMENSIONS (INCHES)									
A	B	C	D	E	F	G	H	J	K
12	9	3/8	2 1/4	4	3 3/8	3 1/8	1 3/8	1 1/4	1 1/2

COLORS

LEGEND - BLACK (NON-REFL.)
BACKGROUND - WHITE (REFL.)

M8-101

5/06

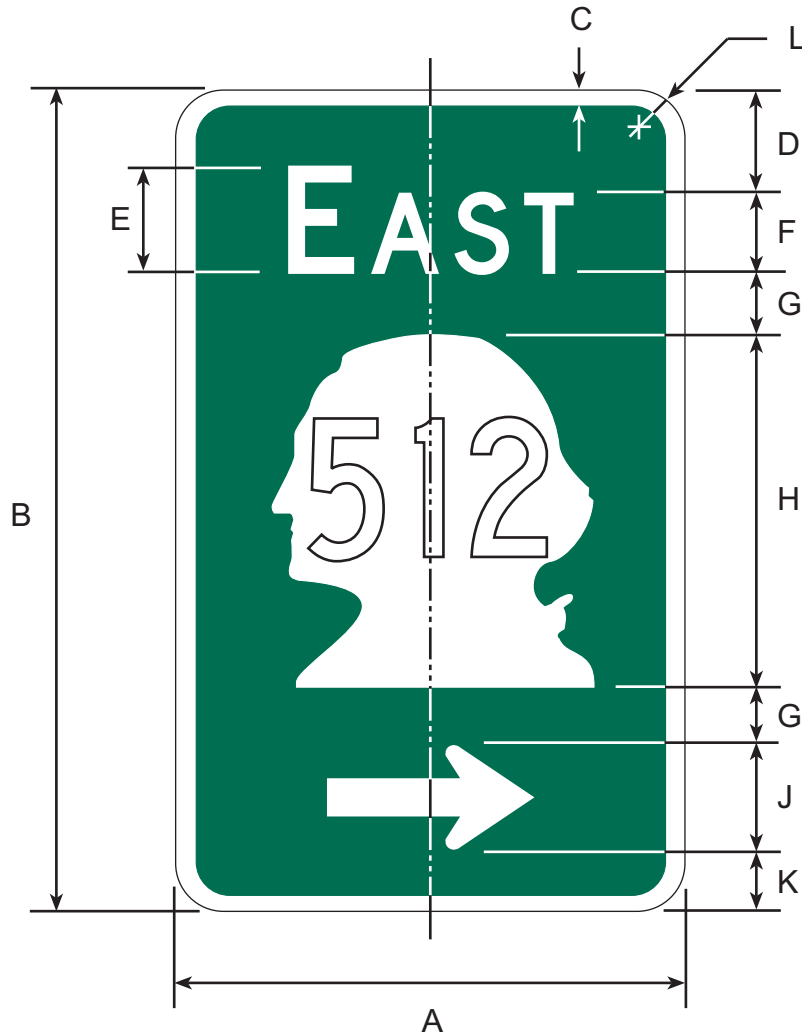

NUMERALS ON STATE AND FEDERAL SHIELDS SHALL BE BLACK.
FOR NUMERALS SIZE AND SERIES SEE APPLICABLE ROUTE MARKER.

DIMENSIONS (MILLIMETERS)										
A	B	C	D	E	F	G	H	J	K	L
900	1500	19	200	200D	150D	94	550	213 x 250	150	100

DIMENSIONS (INCHES)										
A	B	C	D	E	F	G	H	J	K	L
36	60	3/4	8	8D	6D	3 3/4	22	8 1/2 x 10	6	4

COLORS

LEGEND - WHITE (REFL)
BACKGROUND - GREEN (REFL)

M8-201

2/06



* SEE APPENDIX FOR STANDARD ARROW DETAIL

DIMENSIONS (MILLIMETERS)							
A	B	C	D	E	F	ARROW	SHIELD
2100	900	19	150D	200D	100	#1	600

DIMENSIONS (INCHES)							
A	B	C	D	E	F	ARROW	SHIELD
84	36	3/4	6D	8D	4	#1	24

COLORS

LEGEND— WHITE (REFL)
BACKGROUND— GREEN (REFL)

M8-301

9/03

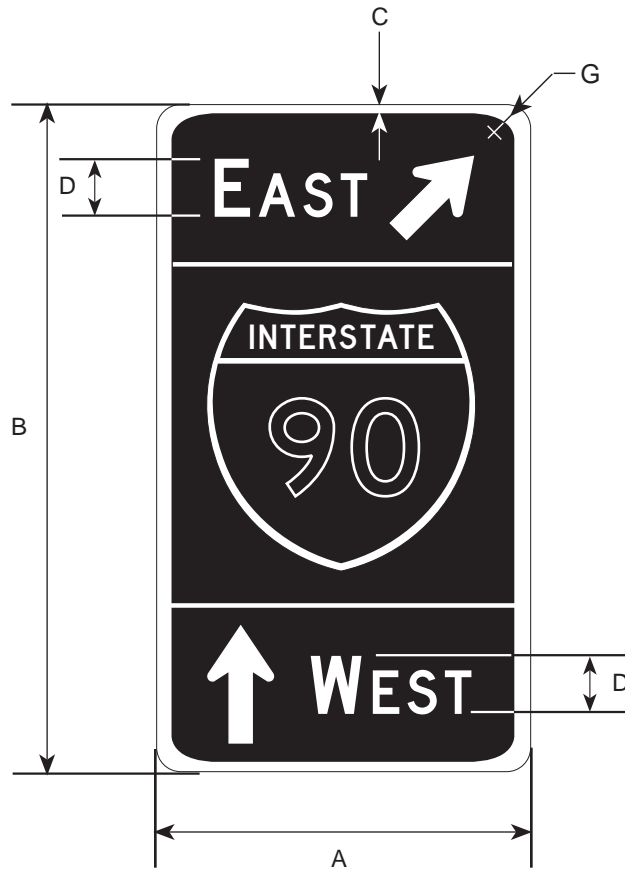

BORDER SHALL BE USED ON STANDARD ROUTE MARKERS

DIMENSIONS (MILLIMETERS)						
A	B	C	D	ARROW	G	SHIELD
1200	1800	19	200D/150D	213 X 250	150	600

DIMENSIONS (INCHES)						
A	B	C	D	ARROW	G	SHIELD
48	72	3/4	8D/6D	8 1/2 X 10	6	24

COLORS

LEGEND - WHITE (REFL.)
BACKGROUND - GREEN (REFL.)

M8-401

9/03

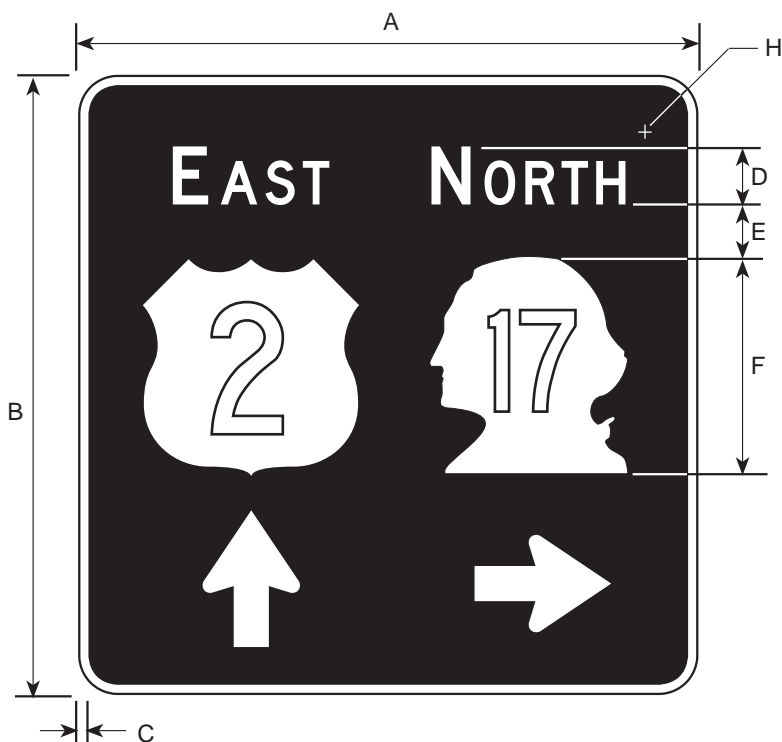

NUMERALS ON ADJACENT SHIELDS SHALL BE THE SAME SIZE, HOWEVER, IT WILL BE PERMISSIBLE TO USE DIFFERENT LETTER SERIES IF NECESSARY AND APPROVED BY THE STATE ENGINEER.

*

THE 60" X 60" SIGN SIZE APPLIES TO THOSE SIGNS WITH ONE U.S. SHIELD AND ONE STATE SHIELD, OR TWO STATE SHIELDS MARKED EAST AND WEST. FOR SIGNS WITH TWO U.S. SHIELDS OR TWO STATE SHIELDS OR TWO STATE SHIELDS MARKED NORTH AND SOUTH, THE SIZE SHALL BE 72" X 60"

DIMENSIONS (MILLIMETERS)									
A	B	C	D	E	F	ARROW	H	SHIELD	
1500	1500	19	200D/150D	125	600	213 X 250	150	600	

DIMENSIONS (INCHES)									
A	B	C	D	E	F	ARROW	H	SHIELD	
60	60	3/4	8D/6D	5	24	8 1/2 X 10	6	24	

COLORS

LEGEND - WHITE (REFL.)

BACKGROUND - GREEN (REFL.)

P-1, P-2

11/97

P-1

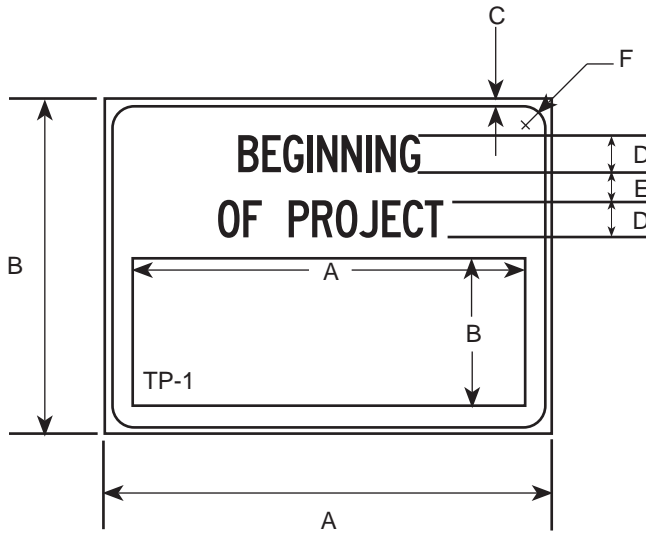

P-2

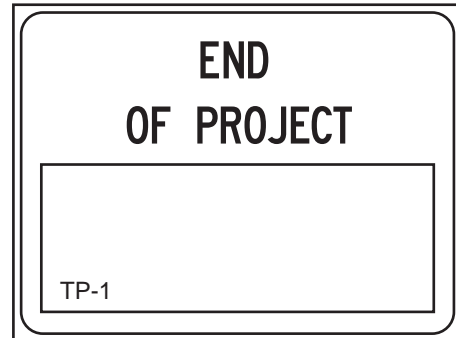

PANEL	DIMENSIONS (MILLIMETERS)					
	A	B	C	D	E	F
	600	450	16	50C	9	38
TP-1	525	200	—	31C	—	—

PANEL	DIMENSIONS (INCHES)					
	A	B	C	D	E	F
	24	18	5/8	2C	3/8	1 1/2
TP-1	21	8	—	1 1/4C	—	—

COLORS

LEGEND - BLACK (NON-REFL)
BACKGROUND - ORANGE (REFL)

P-3, P-4

11/97

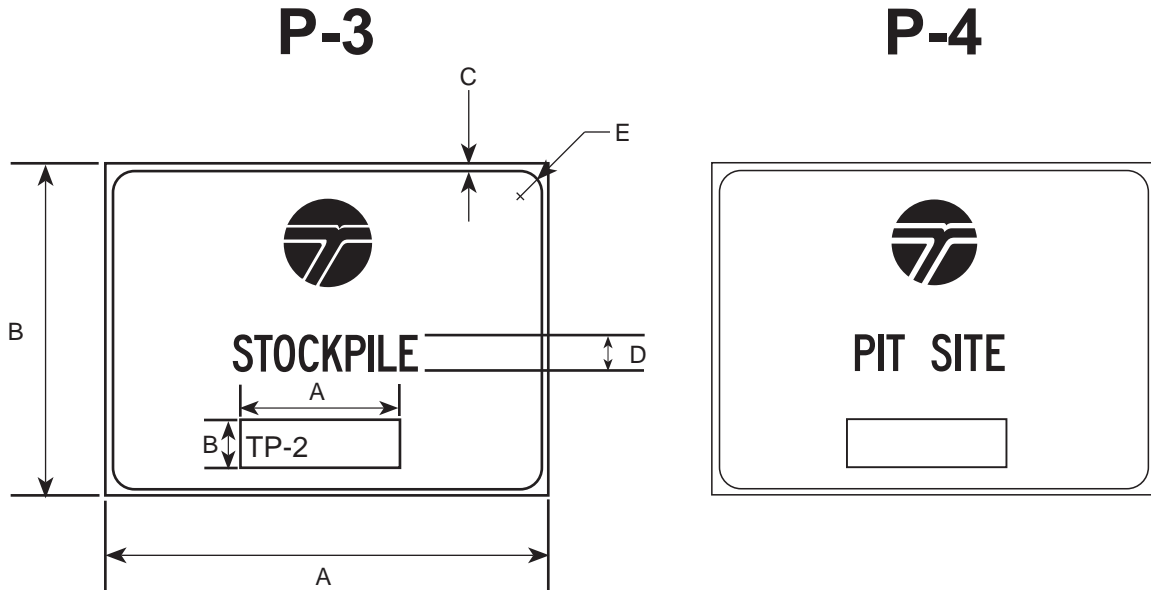

PANEL	DIMENSIONS (MILLIMETERS)				
	A	B	C	D	E
	600	450	16	50C	38
TP-2	200	75	—	50C	—

PANEL	DIMENSIONS (INCHES)				
	A	B	C	D	E
	24	18	5/8	2C	1 1/2
TP-2	8	3	—	2C	—

COLORS

LEGEND - BLACK (NON-REFL)
BACKGROUND - ORANGE (REFL)

P-5, P-6

11/97

P-5

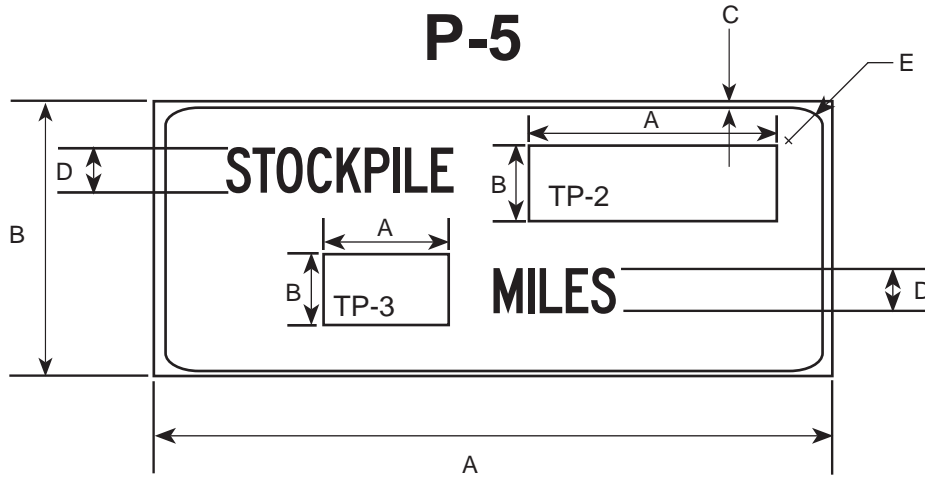

P-6

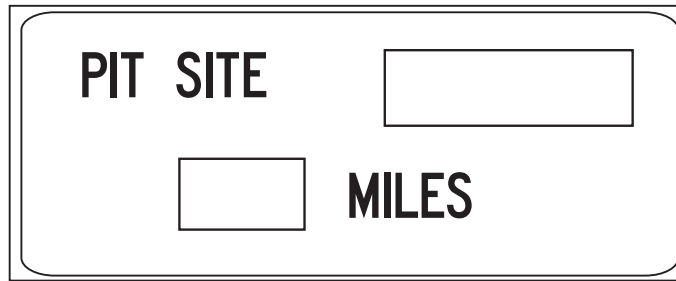

PANEL	DIMENSIONS (MILLIMETERS)				
	A	B	C	D	E
	600	450	16	50C	38
TP-2	200	75	—	50C	—
TP-3	100	75	—	50C	—

PANEL	DIMENSIONS (INCHES)				
	A	B	C	D	E
	24	18	5/8	2C	1 1/2
TP-2	8	3	—	2C	—
TP-3	4	3	—	2C	—

COLORS

LEGEND - BLACK (NON-REFL)
BACKGROUND - ORANGE (REFL)

R1-1

11/97

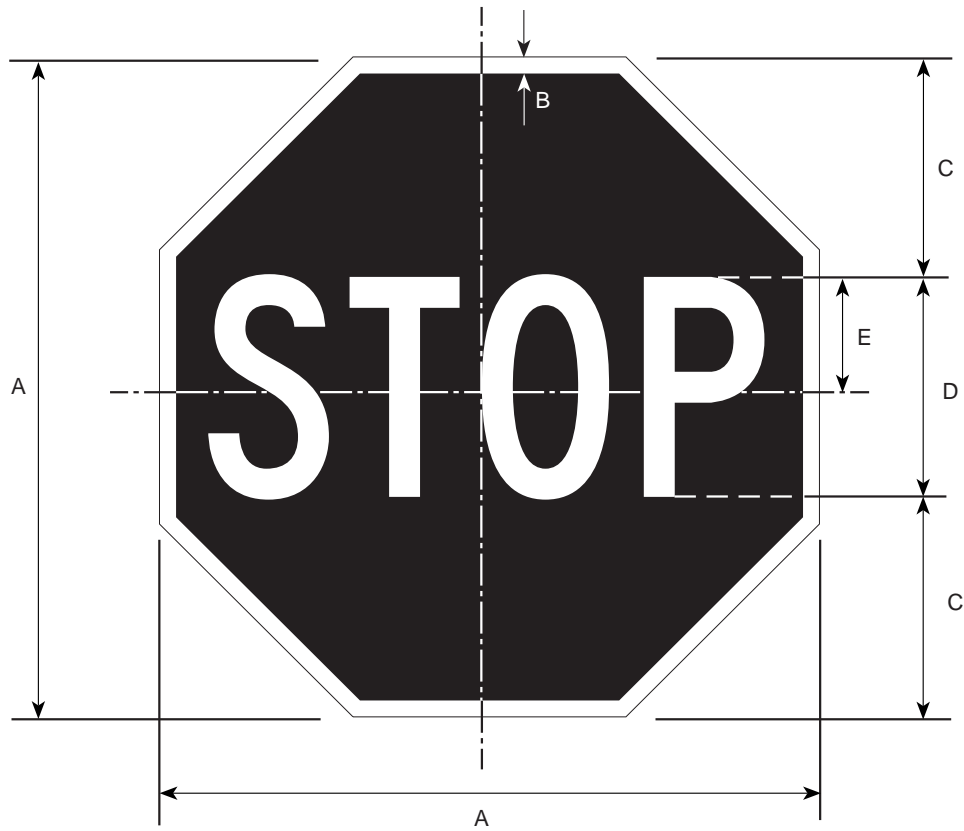

DIMENSIONS (MILLIMETERS)				
A	B	C	D	E
450	9	150	150C	75
600	16	200	200C	100
750	19	250	250C	125
900	22	300	300C	150
1200	31	400	400C	200

DIMENSIONS (INCHES)				
A	B	C	D	E
18	3/8	6	6C	3
24	5/8	8	8C	4
30	3/4	10	10C	5
36	7/8	12	12C	6
48	1 1/4	16	16C	8

COLORS

LEGEND - WHITE (REFL)
BACKGROUND - RED (REFL)

R1-2

11/97

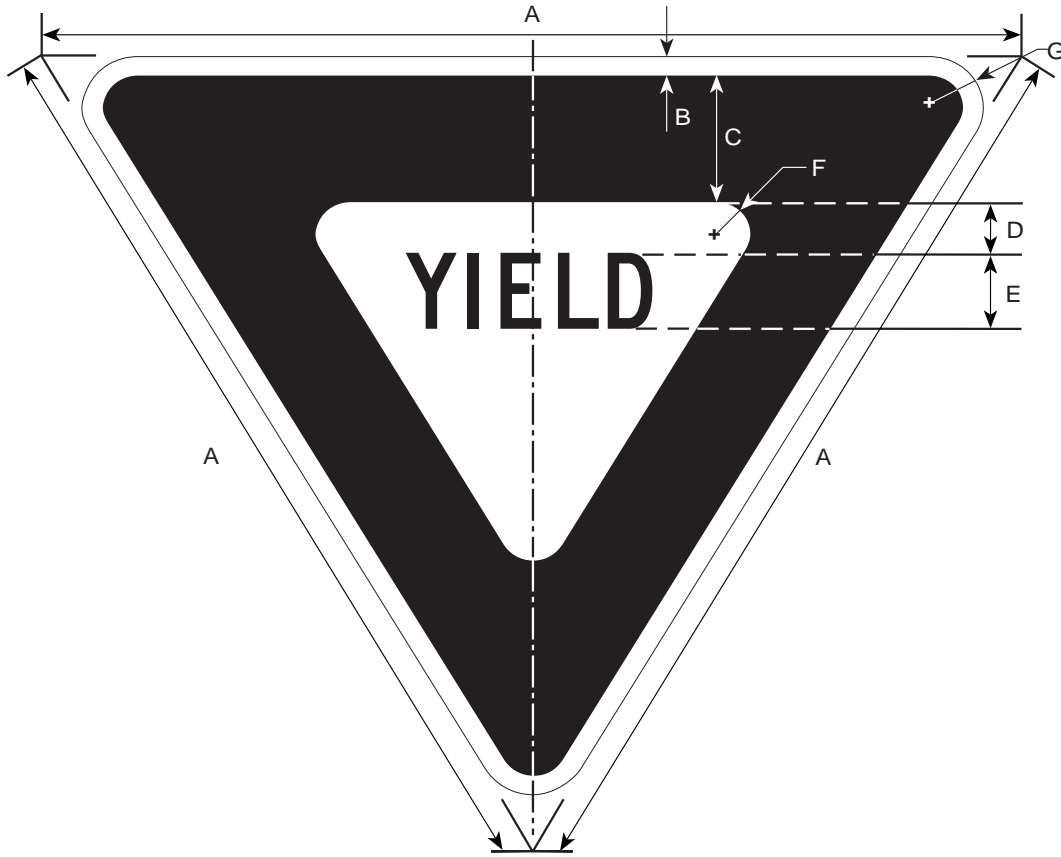

DIMENSIONS (MILLIMETERS)						
A	B	C	D	E	F	G
600	9	75	34	50C	22	38
750	16	100	44	63C	22	38
900	19	125	50	75C	31	50
1200	25	150	69	100C	50	75
1500	38	200	88	125C	63	100

DIMENSIONS (INCHES)						
A	B	C	D	E	F	G
24	3/8	3	1 3/8	2C	7/8	1 1/2
30	5/8	4	1 3/4	2 1/2C	7/8	1 1/2
36	3/4	5	2	3C	1 1/4	2
48	1	6	2 3/4	4C	2	3
60	1 1/2	8	3 1/2	5C	2 1/2	4

COLORS

LEGEND - RED (REFL)
BACKGROUND - WHITE (REFL)

R1-2A

6/03

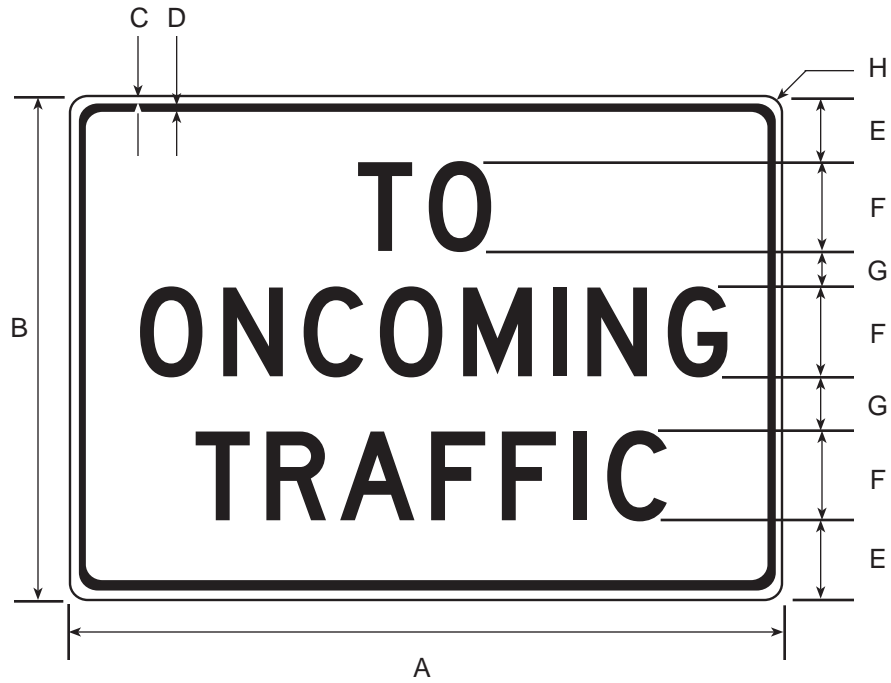

DIMENSIONS (MILLIMETERS)							
A	B	C	D	E	F	G	H
600	450	9	16	63	75D	50	38

DIMENSIONS (INCHES)							
A	B	C	D	E	F	G	H
24	18	3/8	5/8	2 1/2	3D	2	1 1/2

COLORS
 LEGEND - BLACK
 BACKGROUND - WHITE (REFL)

R1-3

11/97

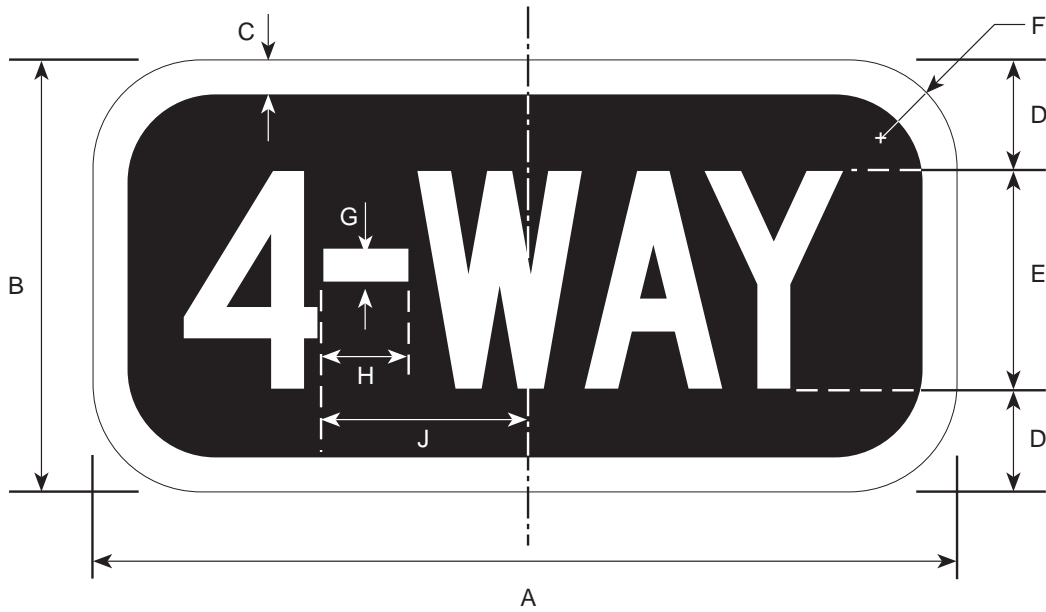

DIMENSIONS (MILLIMETERS)								
A	B	C	D	E	F	G	H	J
300	150	13	38	75C	38	11	27	69

DIMENSIONS (INCHES)								
A	B	C	D	E	F	G	H	J
12	6	1/2	1 1/2	3C	1 1/2	27/64	1 1/16	2 3/4

COLORS

LEGEND - WHITE (REFL)
BACKGROUND - RED (REFL)

R1-4

11/97

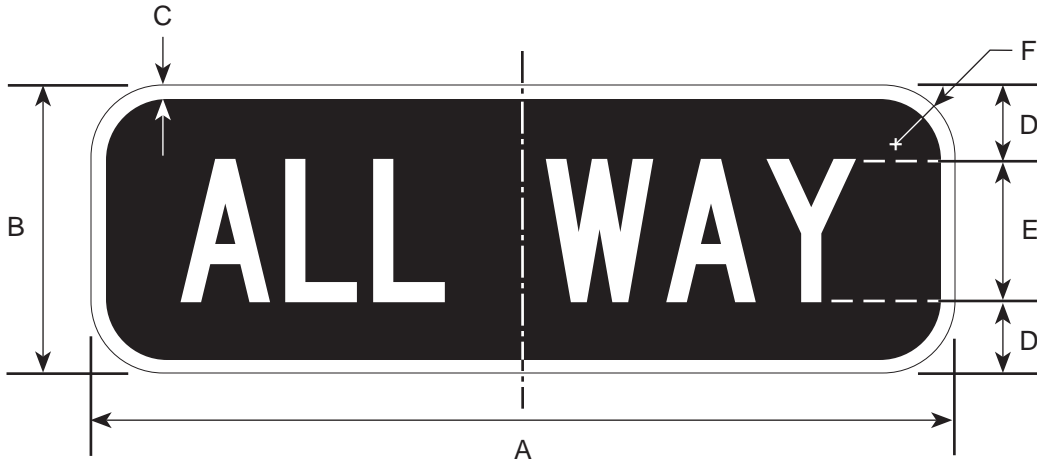

DIMENSIONS (MILLIMETERS)					
A	B	C	D	E	F
450	150	13	38	75C	38

DIMENSIONS (INCHES)					
A	B	C	D	E	F
18	6	1/2	1 1/2	3C	1 1/2

COLORS

LEGEND - WHITE (REFL)
 BACKGROUND - RED (REFL)

R1-5L

2/06

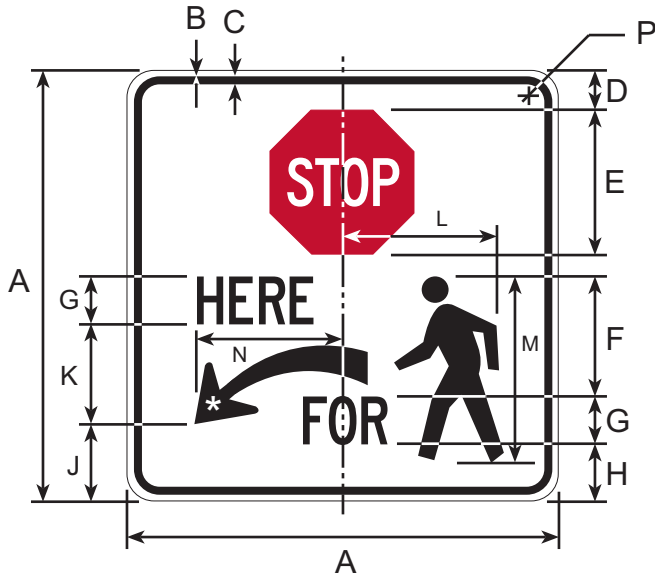

R1-5R



DIMENSIONS (MILLIMETERS)													
A	B	C	D	E	F	G	H	J	K	L	M	N	P
450	9	16	41	144	125	50C	60	75	109	165	193	165	38
750	13	19	69	256	213	75C	106	125	181	275	325	275	47
900	16	22	81	319	250	100C	119	150	219	331	391	331	56

DIMENSIONS (INCHES)													
A	B	C	D	E	F	G	H	J	K	L	M	N	P
18	3/8	5/8	1 5/8	5 3/4	5	2C	2 3/8	3	4 3/8	6 5/8	7 3/4	6 5/8	1 1/2
30	1/2	3/4	2 3/4	10 1/4	8 1/2	3C	4 1/4	5	7 1/4	11	13	11	1 7/8
36	5/8	7/8	3 1/4	12 3/4	10	4C	4 3/4	6	8 3/4	13 1/4	15 5/8	13 1/4	2 1/4

* See R10-6A for arrow details

COLORS

- SIGN LEGEND, ARROW, & PEDESTRIAN SYMBOL - BLACK (NON-REFL)
- BACKGROUND - WHITE (REFL)
- STOP SYMBOL - RED (REFL)
- STOP LEGEND - WHITE (REFL)

R1-6A

2/06

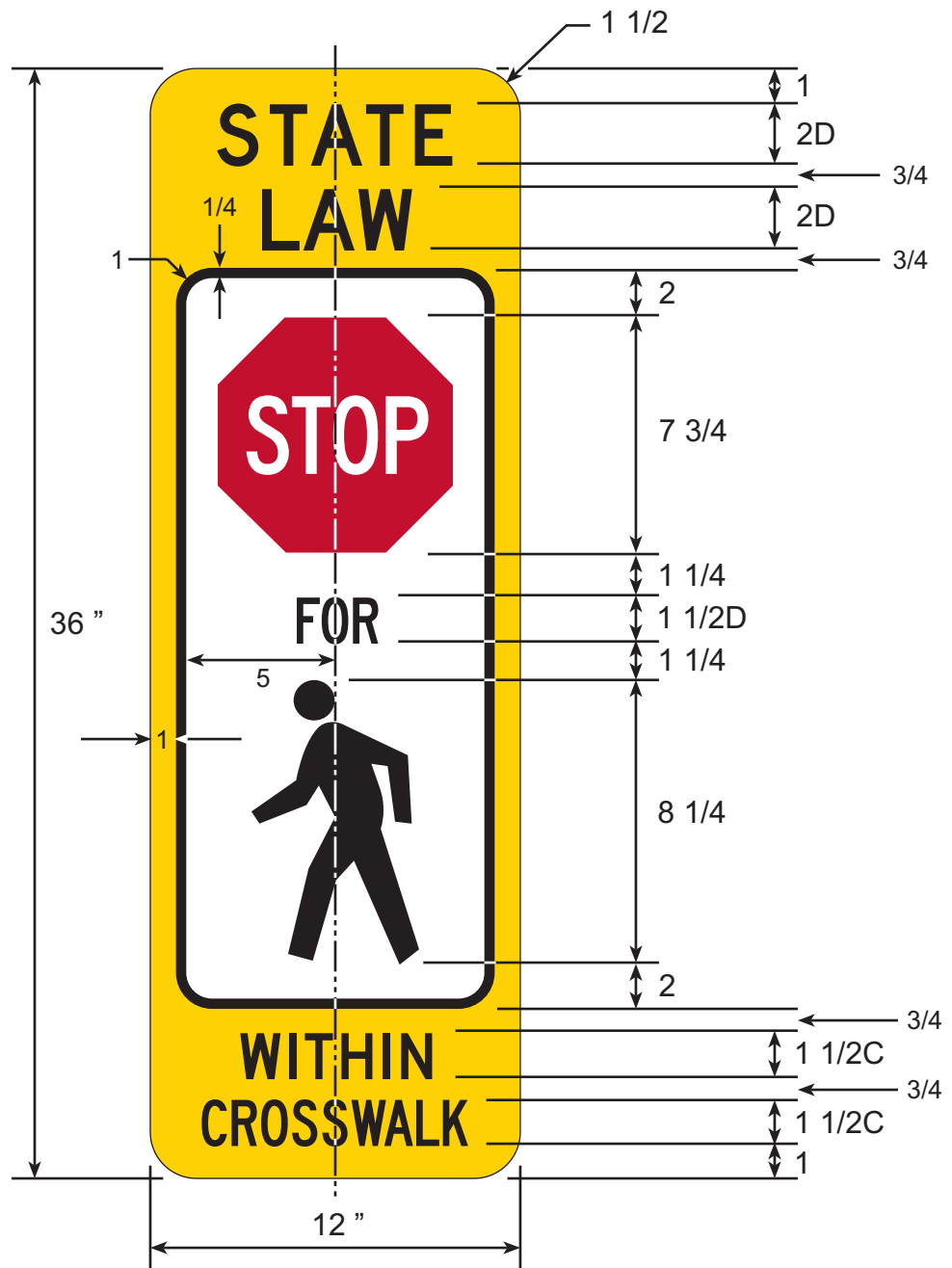

COLORS

- LEGEND - BLACK (NON-REFL)
- BACKGROUND - YELLOW OR FLOURESCENT YELLOW-GREEN (REFL)
- PED SYMBOL - BLACK (NON-REFL) ON WHITE (REFL)
- STOP SYMBOL - RED (REFL)
- STOP LEGEND - WHITE (REFL)

R2-1

11/97



DIMENSIONS (MILLIMETERS)								
A	B	C	D	E	F	G	H	J
450	600	9	16	75	75E	50	200E	38
600	750	9	16	100	100E	50	250E	38
750	900	13	19	100	125E	75	300E	47
900	1200	16	22	150	150E	125	350E	56
1200	1500	19	31	200	200E	150	400E	75

DIMENSIONS (INCHES)								
A	B	C	D	E	F	G	H	J
18	24	3/8	5/8	3	3E	2	8E	1 1/2
24	30	3/8	5/8	4	4E	2	10E	1 1/2
30	36	1/2	3/4	4	5E	3	12E	1 7/8
36	48	5/8	7/8	6	6E	5	14E	2 1/4
48	60	3/4	1 1/4	8	8E	6	16E	3

COLORS

LEGEND - BLACK (NON-REFL)
BACKGROUND - WHITE (REFL)

* Optically space numerals
about vertical centerline

R2-2

11/97

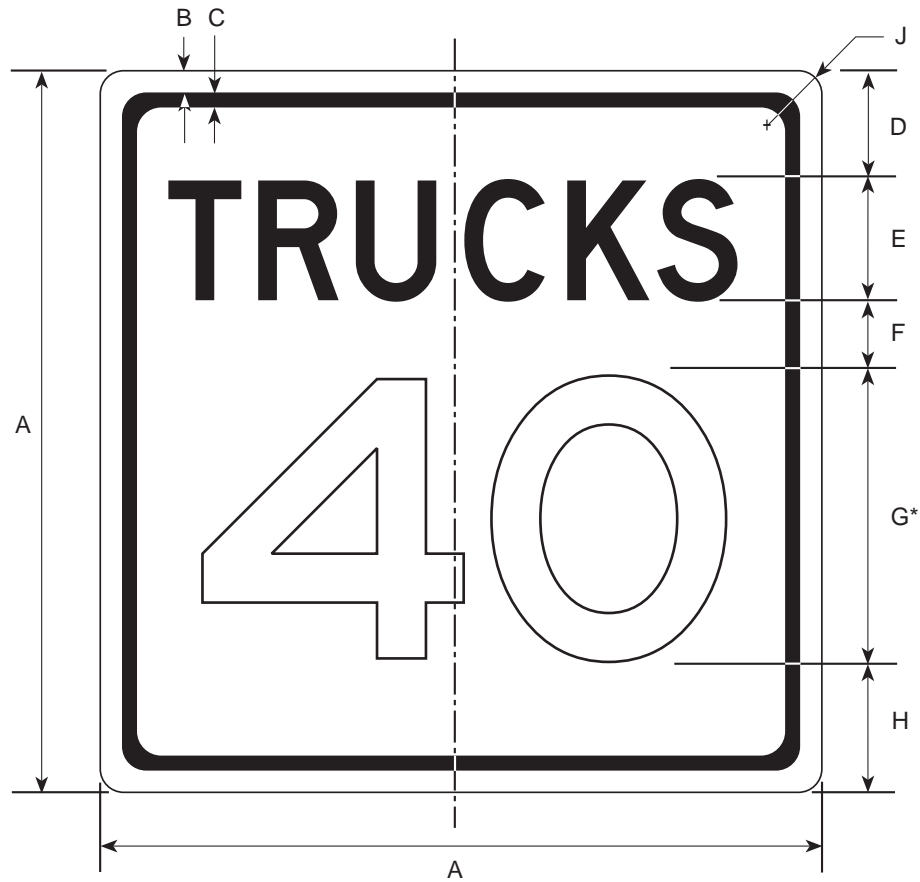

DIMENSIONS (MILLIMETERS)								
A	B	C	D	E	F	G	H	J
450	9	16	69	75D	44	200E	63	38
600	9	16	100	100D	63	250E	88	38
900	16	22	150	150D	100	350E	150	56
1200	19	31	200	200D	200	400E	200	75

DIMENSIONS (INCHES)								
A	B	C	D	E	F	G	H	J
18	3/8	5/8	2 3/4	3D	1 3/4	8E	2 1/2	1 1/2
24	3/8	5/8	4	4D	2 1/2	10E	3 1/2	1 1/2
36	5/8	7/8	6	6D	4	14E	6	2 1/4
48	3/4	1 1/4	8	8D	8	16E	8	3

COLORS

LEGEND - BLACK (NON-REFL)
BACKGROUND - WHITE (REFL)

* Optically space numerals
about vertical centerline

R2-3

11/97



* OPTICALLY SPACE NUMERALS ABOUT VERTICAL CENTERLINE

DIMENSIONS (MILLIMETERS)						
A	B	C	D	E	F	G
450	13	75	50E	50	200E	38
600	13	100	75E	75	250E	38
900	19	163	100E	125	350E	56
1200	25	225	150E	200	400E	75

DIMENSIONS (INCHES)						
A	B	C	D	E	F	G
18	1/2	3	2E	2	8E	1 1/2
24	1/2	4	3E	3	10E	1 1/2
36	3/4	6 1/2	4E	5	14E	2 1/4
48	1	9	6E	8	16E	3

COLORS

LEGEND - WHITE (REFL)
 BACKGROUND - BLACK (NON-REFL)

R2-4

11/97

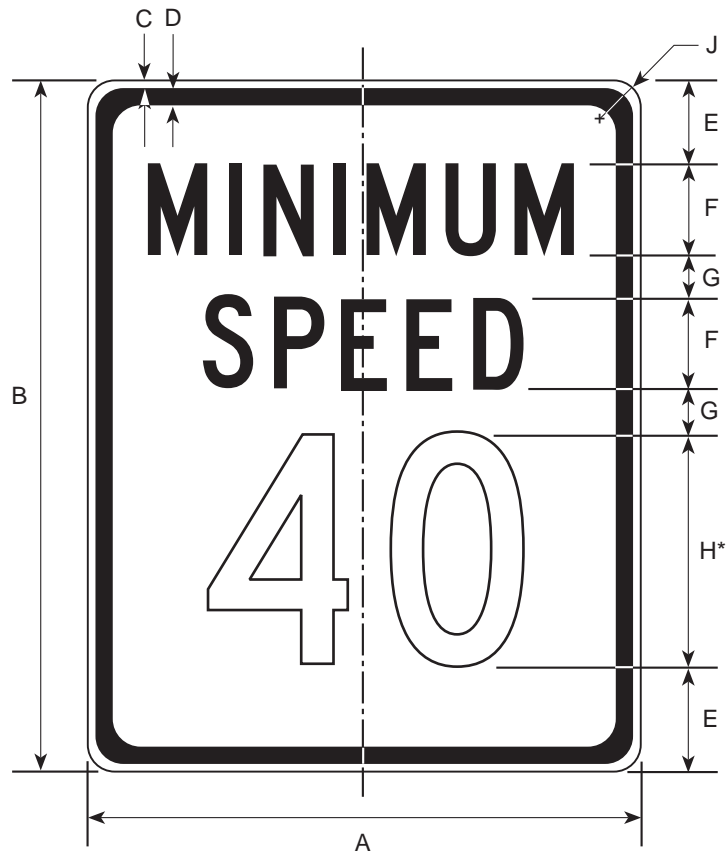

* OPTICALLY SPACE NUMERALS ABOUT VERTICAL CENTER LINE

DIMENSIONS (MILLIMETERS)								
A	B	C	D	E	F	G	H	J
600	750	9	16	100	100C	50	250D	38
900	1200	16	22	150	150C	125	350D	56
1200	1500	19	31	200	200C	150	400D	75

DIMENSIONS (INCHES)								
A	B	C	D	E	F	G	H	J
24	30	3/8	5/8	4	4C	2	10D	1 1/2
36	48	5/8	7/8	6	6C	5	14D	2 1/4
48	60	3/4	1 1/4	8	8C	6	16D	3

COLORS

LEGEND - BLACK (NON-REFL)
BACKGROUND - WHITE (REFL)

R2-4A

6/00

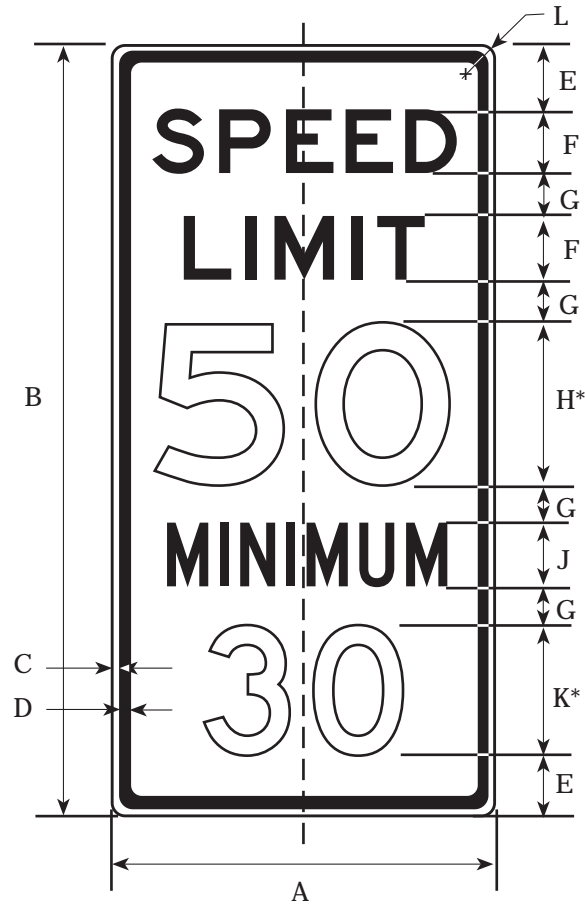

DIMENSIONS (MILLIMETERS)										
A	B	C	D	E	F	G	H	J	K	L
600	1200	9	16	100	100E	63	250E	100C	200D	38
900	1800	16	22	150	150E	100	350E	150C	300D	56
1200	2400	19	31	200	200E	162.5	400E	200C	350D	75

DIMENSIONS (INCHES)										
A	B	C	D	E	F	G	H	J	K	L
24	48	3/8	5/8	4	4E	2 1/2	10E	4C	8D	1 1/2
36	72	5/8	7/8	6	6E	4	14E	6C	12D	2 1/4
48	96	3/4	1 1/4	8	8E	6 1/2	16E	8C	14D	3

* Optically space numerals about vertical centerline.

COLORS

LEGEND - BLACK (NON-REFL)
BACKGROUND - WHITE (REFL)

R2-501

6/00

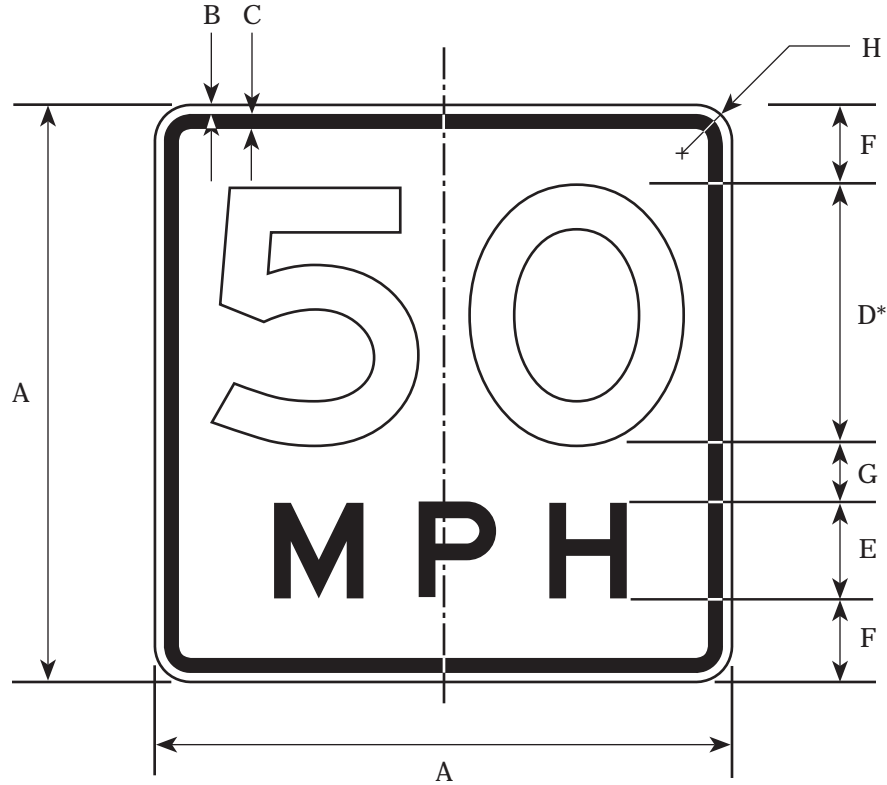

DIMENSIONS (MILLIMETERS)							
A	B	C	D	E	F	G	H
450	9	9	200E	75E	66	43	38
600	9	16	250E	100E	100	50	38
750	13	19	300E	125E	119	87	47
900	19	22	375E	150E	13	100	56
1200	19	28	450E	175E	200	75	72

DIMENSIONS (INCHES)							
A	B	C	D	E	F	G	H
18	3/8	3/8	8E	3E	2 5/8	1 3/4	1 1/2
24	3/8	5/8	10E	4E	4	2	1 1/2
30	1/2	3/4	12E	5E	4 3/4	3 1/2	1 7/8
36	3/4	7/8	15E	6E	5 1/2	4	2 1/4
48	3/4	1 1/4	18E	7E	8	7	2 7/8

COLORS

LEGEND - BLACK (NON-REFL)
BACKGROUND - WHITE (REFL)

* Optically space numerals
about vertical centerline

R3-1

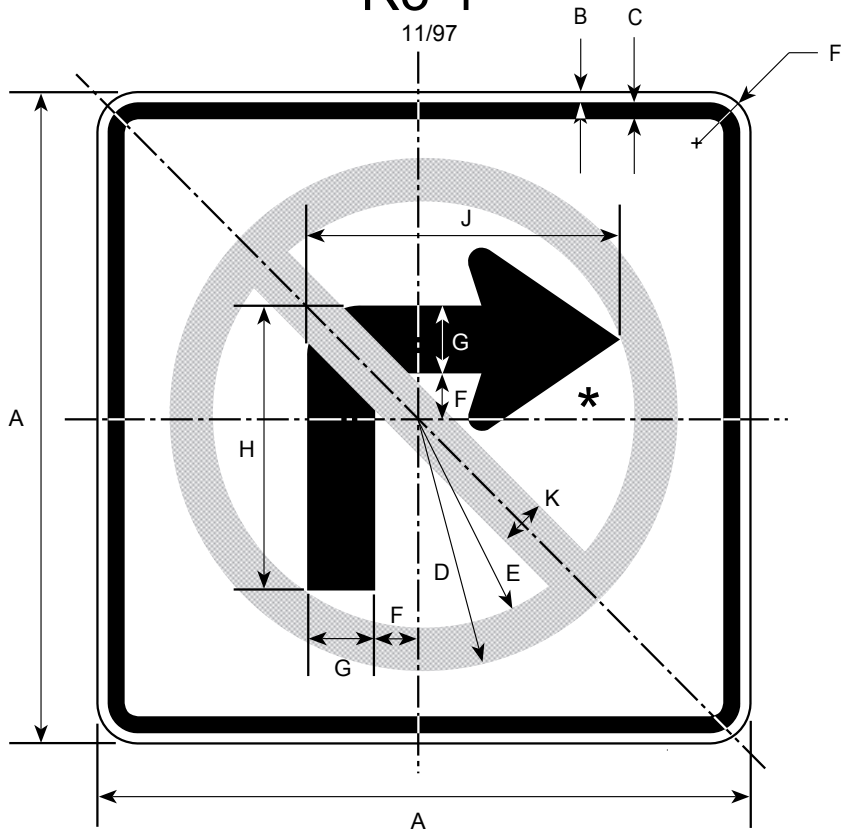

* See appendix for standard arrow details

DIMENSIONS (MILLIMETERS)									
A	B	C	D	E	F	G	H	J	K
600	9	16	263	213	38	63	263	288	50
750	13	19	328	266	47	78	328	363	63
900	16	22	394	319	56	94	394	431	75
1200	19	31	525	425	75	125	525	575	100

DIMENSIONS (INCHES)									
A	B	C	D	E	F	G	H	J	K
24	3/8	5/8	10 1/2	8 1/2	1 1/2	2 1/2	10 1/2	11 1/2	2
30	1/2	3/4	13 1/8	10 5/8	1 7/8	3 1/8	13 1/8	14 1/2	2 1/2
36	5/8	7/8	15 3/4	12 3/4	2 1/4	3 3/4	15 3/4	17 1/4	3
48	3/4	1 1/4	21	17	3	5	21	23	4

COLORS

CIRCLE, DIAGONAL — RED (REFL)
 SYMBOL, BORDER, LEGEND — BLACK (NON-REFL)
 BACKGROUND — WHITE (REFL)

R3-2

11/97

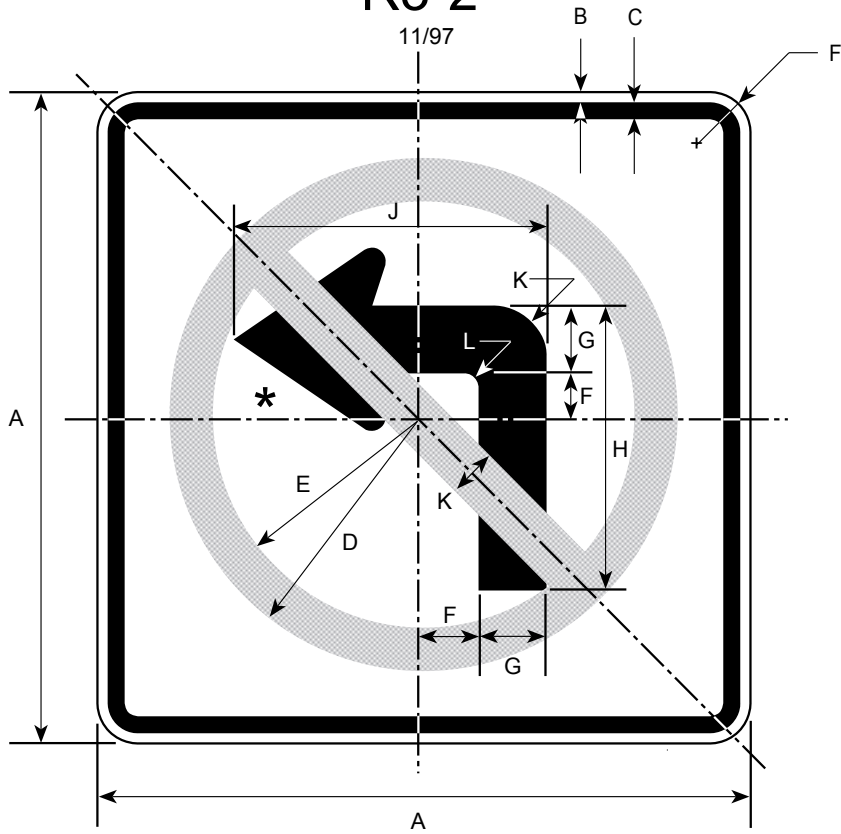

* See appendix for standard arrow details

DIMENSIONS (MILLIMETERS)										
A	B	C	D	E	F	G	H	J	K	L
600	9	16	263	213	38	63	263	288	50	13
750	13	19	328	266	47	78	328	363	63	16
900	16	22	394	319	56	94	394	431	75	19
1200	19	31	525	425	75	125	525	575	100	25

DIMENSIONS (INCHES)										
A	B	C	D	E	F	G	H	J	K	L
24	3/8	5/8	10 1/2	8 1/2	1 1/2	2 1/2	10 1/2	11 1/2	2	1/2
30	1/2	3/4	13 1/8	10 5/8	1 7/8	3 1/8	13 1/8	14 1/2	2 1/2	5/8
36	5/8	7/8	15 3/4	12 3/4	2 1/4	3 3/4	15 3/4	17 1/4	3	3/4
48	3/4	1 1/4	21	17	3	5	21	23	4	1

COLORS

CIRCLE, DIAGONAL — RED (REFL)
 SYMBOL, BORDER, LEGEND — BLACK (NON-REFL)
 BACKGROUND — WHITE (REFL)

R3-3

11/97

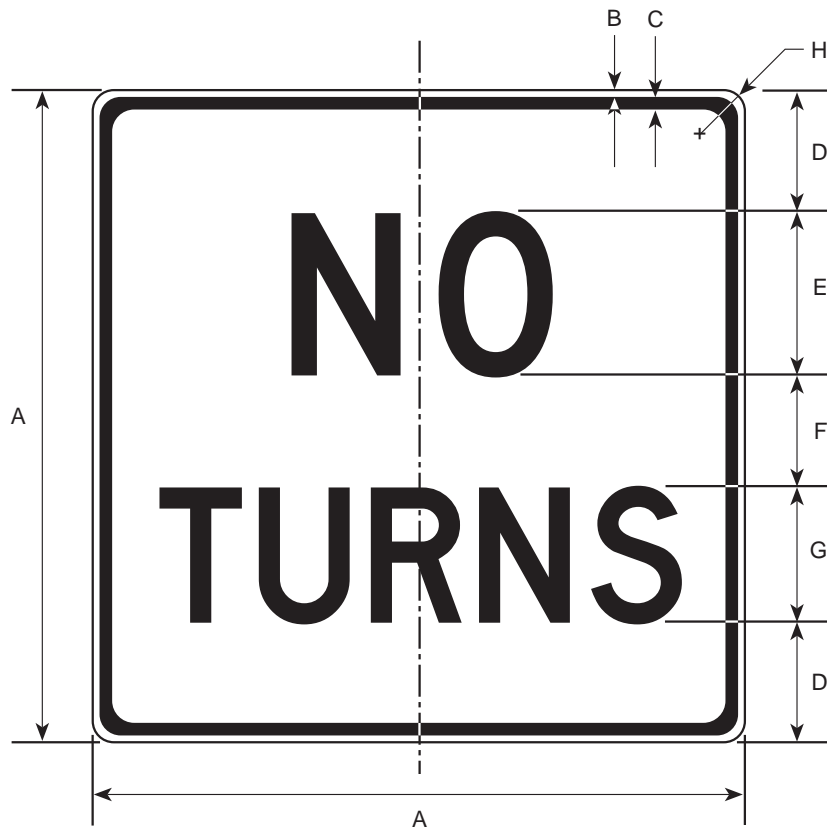

* Reduce spacing 35%

DIMENSIONS (MILLIMETERS)							
A	B	C	D	E	F	G	H
600	9	16	113	150D	100	125D	38
900	16	22	150	250D	150	200D	56
1200	19	31	225	300D	200	250D	75

DIMENSIONS (INCHES)							
A	B	C	D	E	F	G	H
24	3/8	5/8	4 1/2	6D	4	5D	1 1/2
36	5/8	7/8	6	10D	6	8D	2 1/4
48	3/4	1 1/4	9	12D	8	10D	3

COLORS

LEGEND - BLACK (NON-REFL)
BACKGROUND - WHITE (REFL)

R3-4

11/97

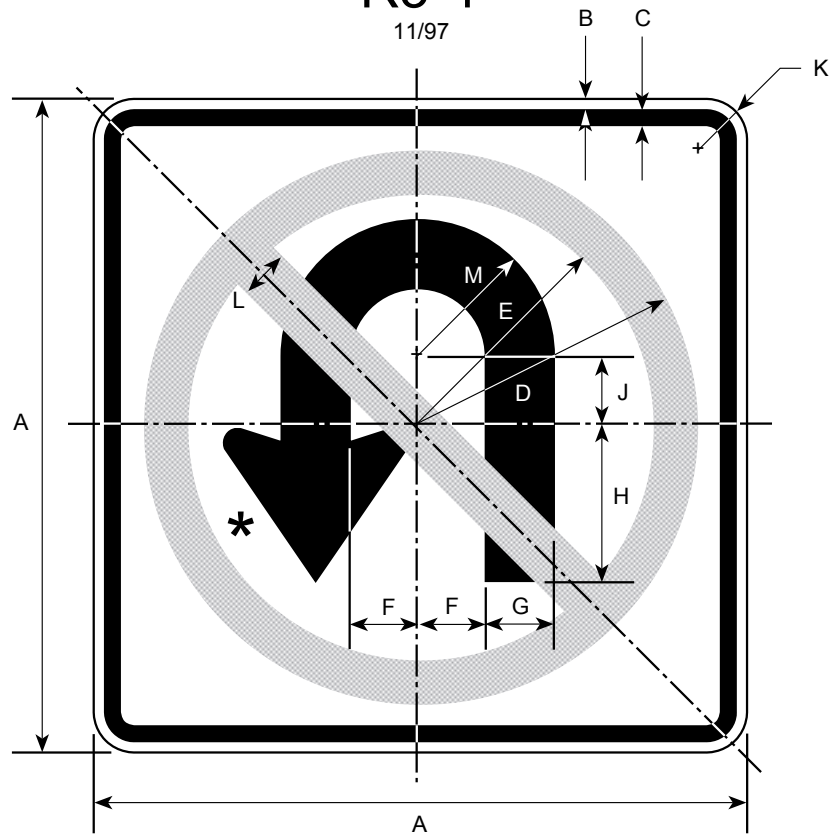

* See appendix for standard arrow details

DIMENSIONS (MILLIMETERS)											
A	B	C	D	E	F	G	H	J	K	L	M
600	9	16	263	213	63	63	150	56	38	50	125
750	13	19	328	266	78	78	188	70	47	63	156
900	16	22	394	319	94	94	225	84	56	75	188
1200	19	31	525	425	125	125	300	113	75	100	250

DIMENSIONS (INCHES)											
A	B	C	D	E	F	G	H	J	K	L	M
24	3/8	5/8	10 1/2	8 1/2	2 1/2	2 1/2	6	2 1/4	1 1/2	2	5
30	1/2	3/4	13 1/8	10 5/8	3 1/8	3 1/8	7 1/2	2 13/16	1 7/8	2 1/2	6 1/4
36	5/8	7/8	15 3/4	12 3/4	3 3/4	3 3/4	9	3 3/8	2 1/4	3	7 1/2
48	3/4	1 1/4	21	17	5	5	12	4 1/2	3	4	10

COLORS

CIRCLE, DIAGONAL — RED (REFL)
 SYMBOL, BORDER, LEGEND — BLACK (NON-REFL)
 BACKGROUND — WHITE (REFL)

R3-5L & R3-5R

07/00

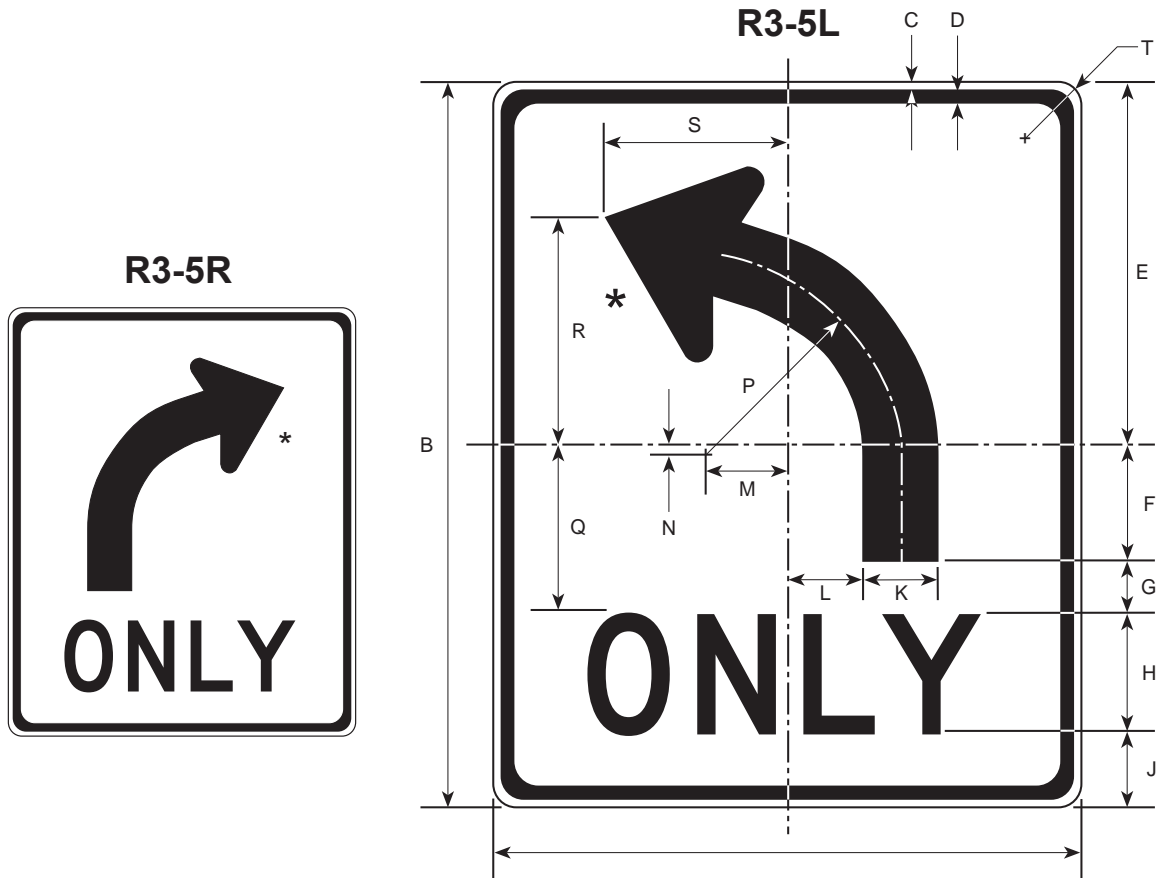

* See appendix for standard arrow details

DIMENSIONS (MILLIMETERS)								
A	B	C	D	E	F	G	H	J
750	900	13	19	450	144	63	150D	94
K	L	M	N	P	Q	R	S	T
94	97	94	13	238	206	281	231	47

DIMENSIONS (INCHES)								
A	B	C	D	E	F	G	H	J
30	36	1/2	3/4	18	5 3/4	2 1/2	6D	3 3/4
K	L	M	N	P	Q	R	S	T
3 3/4	3 7/8	3 3/4	1/2	9 1/2	8 1/4	11 1/4	9 1/4	1 7/8

COLORS

LEGEND - BLACK (NON-REFL)
 BACKGROUND - WHITE (REFL)

R3-501

11/97

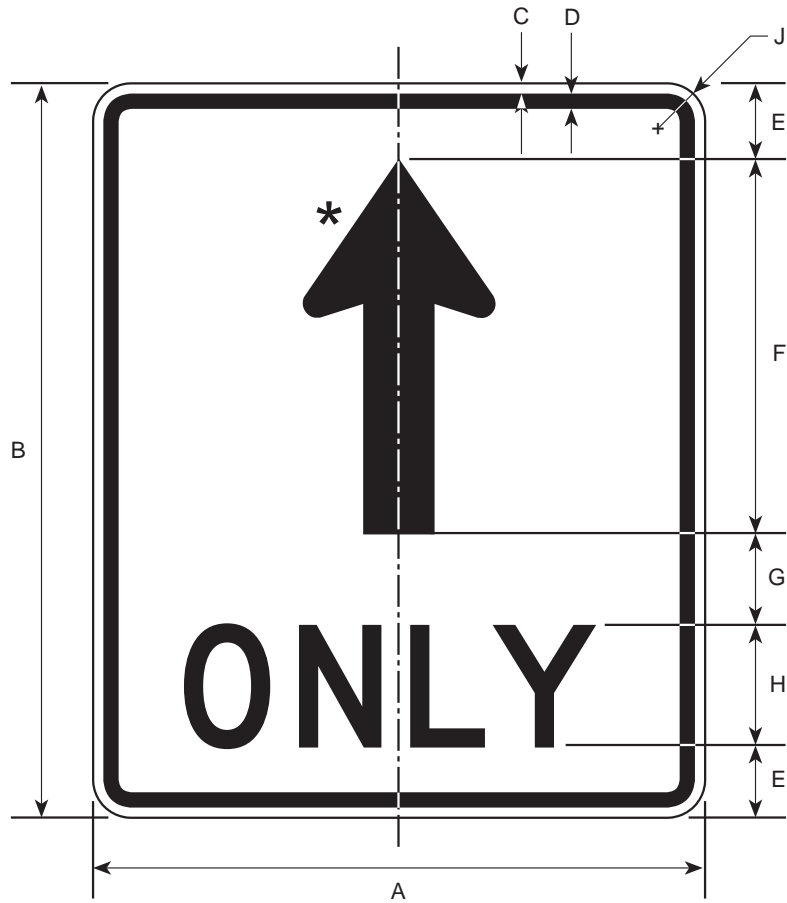

* See appendix for standard arrow details

DIMENSIONS (MILLIMETERS)								
A	B	C	D	E	F	G	H	J
750	900	13	19	94	450	113	150D	47

DIMENSIONS (INCHES)								
A	B	C	D	E	F	G	H	J
30	36	1/2	3/4	3 3/4	18	4 1/2	6D	1 7/8

COLORS

LEGEND - BLACK (NON-REFL)

BACKGROUND - WHITE (REFL)

R3-6

11/97

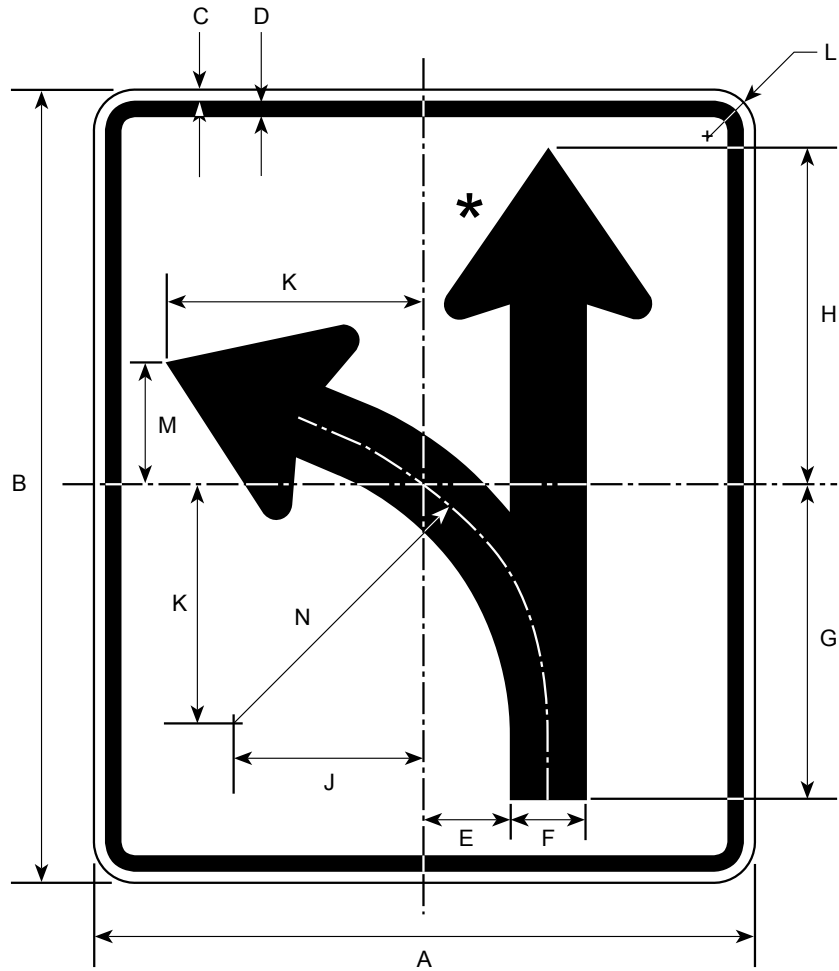

* See appendix for standard arrow details

DIMENSIONS (MILLIMETERS)												
A	B	C	D	E	F	G	H	J	K	L	M	N
750	900	13	19	97	88	356	409	222	281	47	141	363

DIMENSIONS (INCHES)												
A	B	C	D	E	F	G	H	J	K	L	M	N
30	36	1/2	3/4	3 7/8	3 1/2	14 1/4	16 3/8	8 7/8	11 1/4	1 7/8	5 5/8	14 1/2

COLORS

LEGEND — BLACK (NON-REFL)
 BACKGROUND — WHITE (REFL)

R3-7L

11/97

R3-7R

11/97

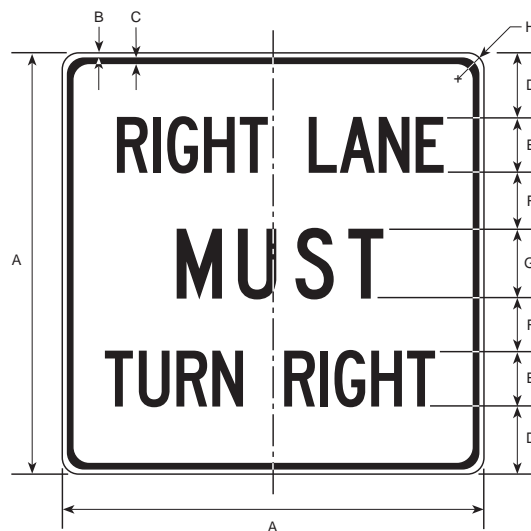
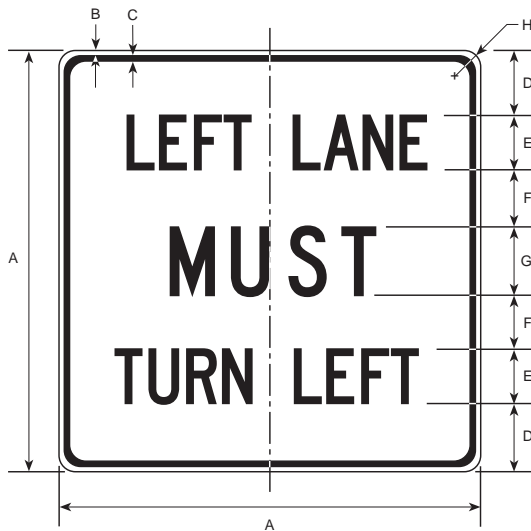

DIMENSIONS (MILLIMETERS)							
A	B	C	D	E	F	G	H
750	13	19	113	100C	100	125C	47

DIMENSIONS (INCHES)							
A	B	C	D	E	F	G	H
30	1/2	3/4	4 1/2	4C	4	5C	1 7/8

COLORS

LEGEND - BLACK (NON-REFL)
BACKGROUND - WHITE (REFL)

R3-701

11/97

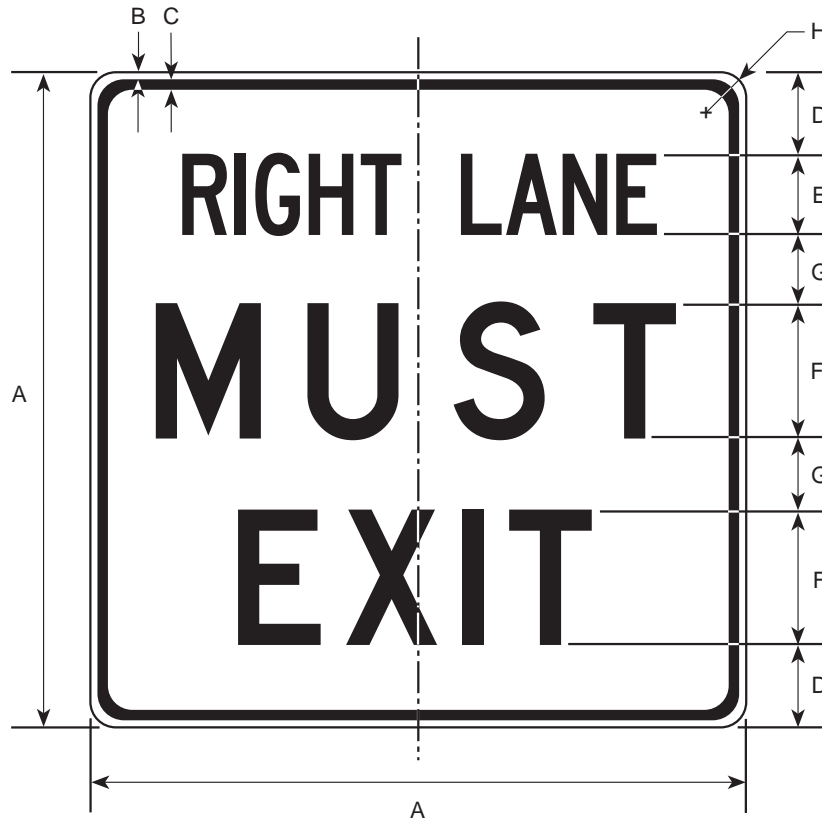

DIMENSIONS (MILLIMETERS)							
A	B	C	D	E	F	G	H
1200	19	31	150	150C	250D	125	75

DIMENSIONS (INCHES)							
A	B	C	D	E	F	G	H
48	3/4	1 1/4	6	6C	10D	5	3

COLORS

LEGEND - BLACK (NON-REFL)
BACKGROUND - WHITE (REFL)

R3-702

6/00

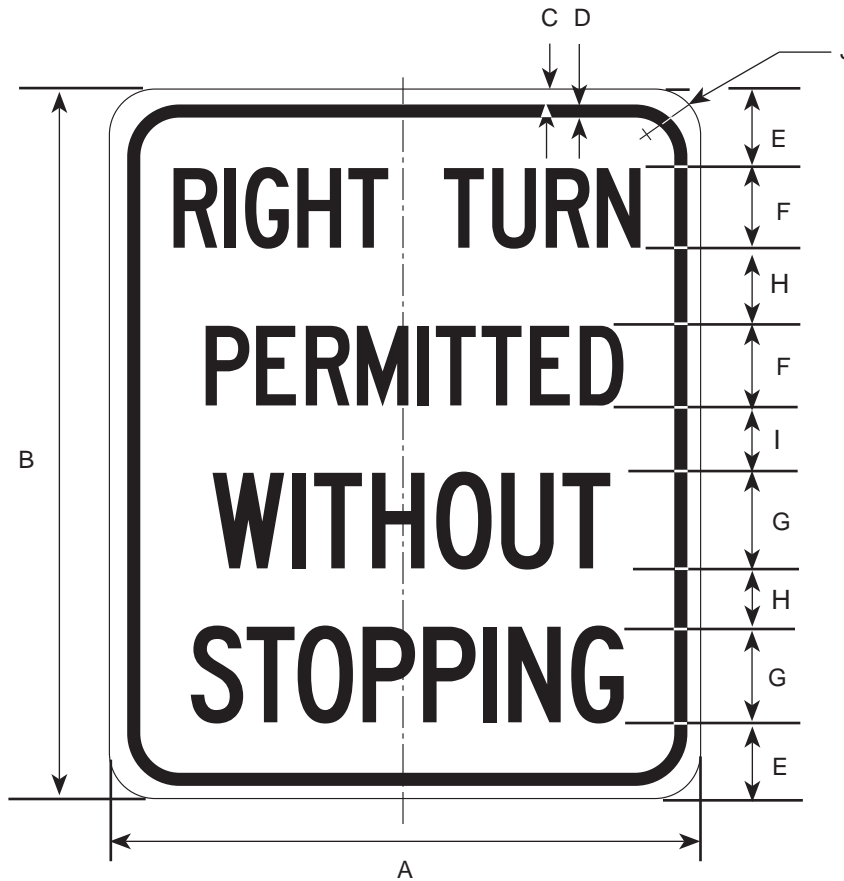

DIMENSIONS (MILLIMETERS)									
A	B	C	D	E	F	G	H	I	J
750	900	13	19	106	100C	125C	63	87	47

DIMENSIONS (INCHES)									
A	B	C	D	E	F	G	H	I	J
30	36	1/2	3/4	4 1/4	4C	5C	2 1/2	3 1/2	1 7/8

COLORS

LEGEND - BLACK (NON-REFL)
 BACKGROUND - WHITE (REFL)

R3-703

6/00



DIMENSIONS (MILLIMETERS)								
A	B	C	D	E	F	G	H	J
1200	1500	19	31	162.5	200D	125	200C	75

DIMENSIONS (INCHES)								
A	B	C	D	E	F	G	H	J
48	60	3/4	1 1/4	6 1/2	8D	5	8C	3

COLORS

LEGEND - BLACK (NON-REFL)
 BACKGROUND - WHITE (REFL)

R3-8

8/00

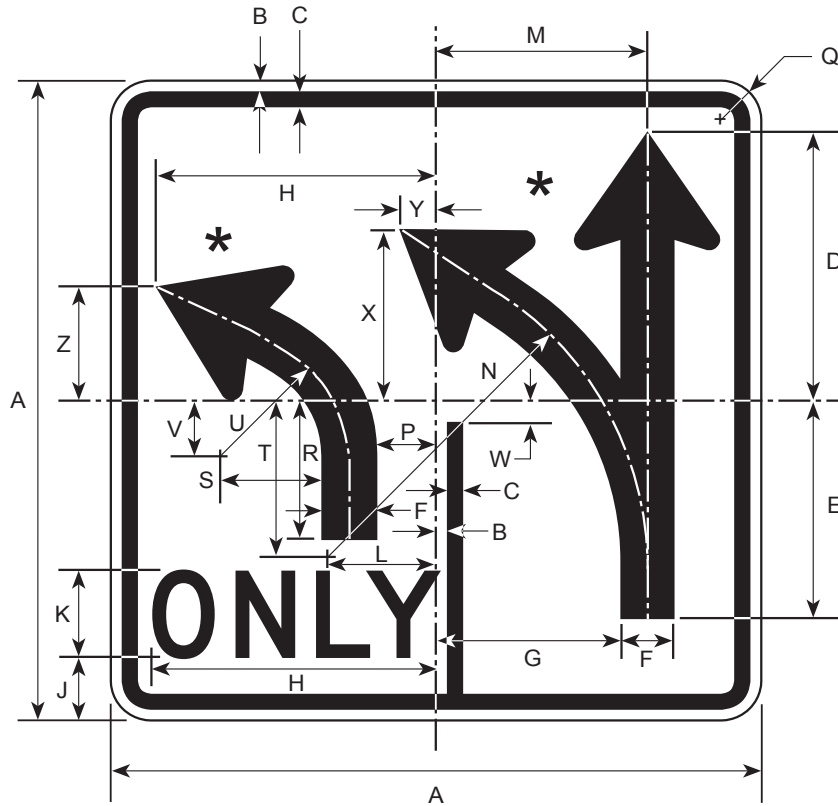

* See appendix for standard arrow details

DIMENSIONS (MILLIMETERS)											
A	B	C	D	E	F	G	H	J	K	L	M
750	13	19	316	256	63	213	322	75	100D	119	244
900	13	19	409	356	75	222	384	75	150C	163	259
N	P	Q	R	S	T	U	V	W	X	Y	Z
363	69	47	163	113	188	144	66	25	200	44	125
433	88	47	188	128	228	161	75	50	250	78	147

DIMENSIONS (INCHES)											
A	B	C	D	E	F	G	H	J	K	L	M
30	1/2	3/4	12 5/8	10 1/4	2 1/2	8 1/2	12 7/8	3	4D	4 3/4	9 3/4
36	1/2	3/4	16 3/8	14 1/4	3	8 7/8	15 3/8	3	6C	6 1/2	10 3/8
N	P	Q	R	S	T	U	V	W	X	Y	Z
14 1/2	2 3/4	1 7/8	6 1/2	4 1/2	7 1/2	5 3/4	2 5/8	1	8	1 3/4	5
17 5/16	3 1/2	1 7/8	7 1/2	5 1/8	9 1/8	6 7/16	3	2	10	3 1/8	5 7/8

COLORS

LEGEND - BLACK (NON-REFL)
BACKGROUND - WHITE (REFL)

R3-8A

6/03

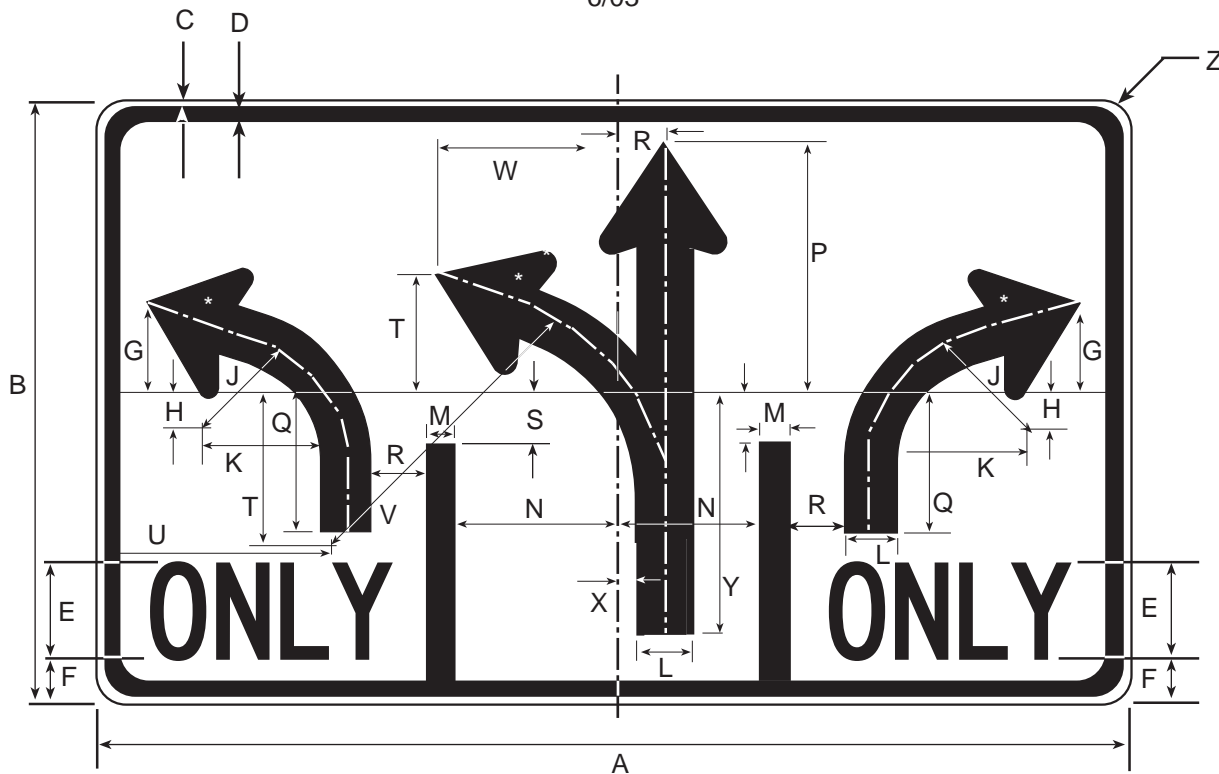

*SEE APPENDIX FOR STANDARD ARROW DETAIL.

DIMENSIONS (MILLIMETERS)											
A	B	C	D	E	F	G	H	J	K	L	M
1200	750	19	31	100D	75	100	84	145	116	63	30
N	P	Q	R	S	T	U	V	W	X	Y	Z
170	338	166	42	25	188	233	369	244	11	277	75

DIMENSIONS (INCHES)											
A	B	C	D	E	F	G	H	J	K	L	M
48	30	3/4	1 1/4	4D	3	4	3 3/8	5 13/16	4 5/8	2 1/2	1 3/16
N	P	Q	R	S	T	U	V	W	X	Y	Z
6 13/16	13 1/2	6 5/8	1 11/16	1	7 1/2	9 5/16	14 3/4	9 3/4	7/16	11 1/16	3

COLORS
 LEGEND - BLACK (NON-REFL)
 BACKGROUND - WHITE (REFL)

R3-801

8/00

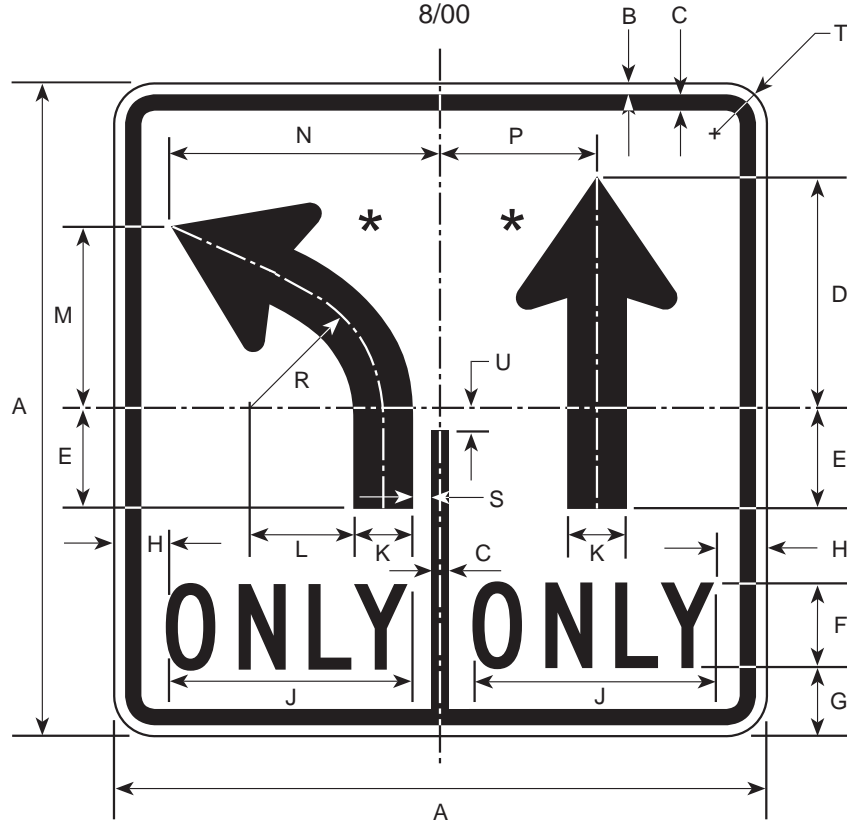

* See appendix for standard arrow details

DIMENSIONS (MILLIMETERS)								
A	B	C	D	E	F	G	H	J
750	13	19	227	98	100C	75	64	278
900	13	19	316	108	125C	75	64	341
K	L	M	N	P	R	S	T	U
63	113	200	298	172	144	39	47	25
75	134	253	384	206	180	39	47	50

DIMENSIONS (INCHES)								
A	B	C	D	E	F	G	H	J
30	1/2	3/4	9 1/16	3 15/16	4C	3	2 9/16	11 1/8
36	1/2	3/4	12 5/8	4 15/16	5C	3	2 9/16	13 5/8
K	L	M	N	P	R	S	T	U
2 1/2	4 1/2	8	11 15/16	6 7/8	5 3/4	1 9/16	1 7/8	1
3	5 3/8	10 1/8	15 3/8	8 1/4	7 3/16	1 9/16	1 7/8	2

COLORS

LEGEND - BLACK (NON-REFL)
BACKGROUND - WHITE (REFL)

R3-802

11/97

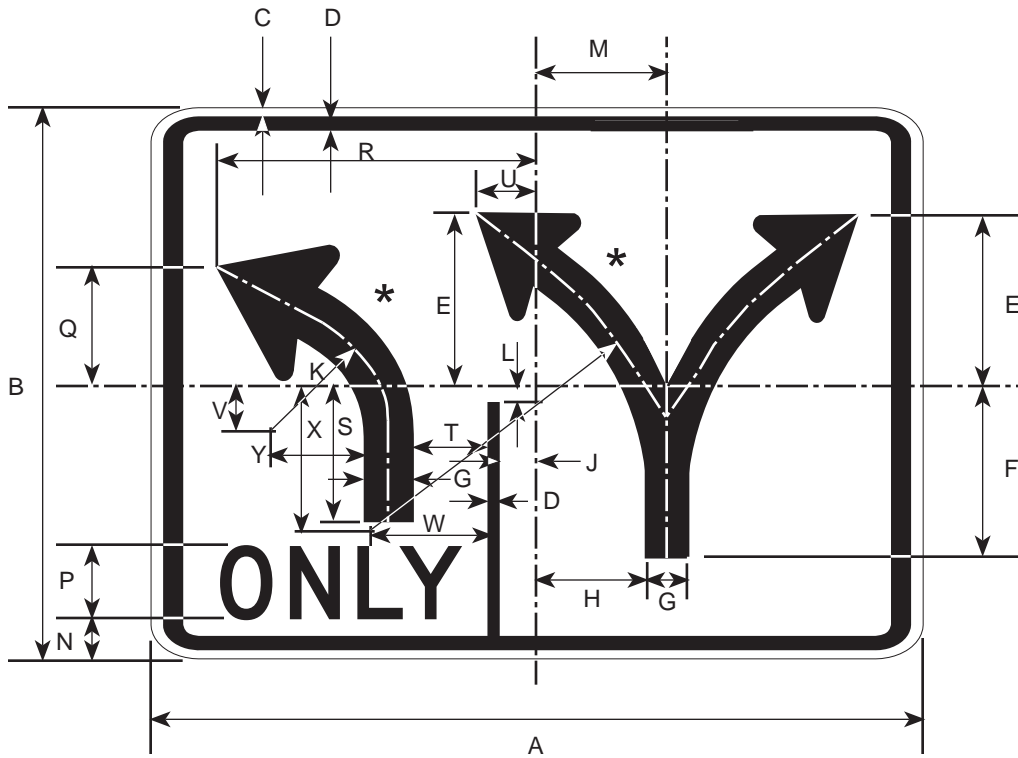

* See appendix for standard arrow details

DIMENSIONS (MILLIMETERS)											
A	B	C	D	E	F	G	H	J	K	L	M
900	750	13	19	200	256	63	181	44	144	25	169
N	P	Q	R	S	T	U	V	W	X	Y	Z
75	100D	125	397	163	81	11	66	131	188	11	363

DIMENSIONS (INCHES)											
A	B	C	D	E	F	G	H	J	K	L	M
36	30	1/2	3/4	8	10 1/4	2 1/2	7 1/4	1 3/4	5 3/4	1	6 3/4
N	P	Q	R	S	T	U	V	W	X	Y	Z
3	4D	5	15 7/8	6 1/2	3 1/4	4 3/4	2 5/8	5 1/4	7 1/2	4 1/2	14 1/2

COLORS

LEGEND - BLACK (NON-REFL)
BACKGROUND - WHITE (REFL)

R3-9A

11/97

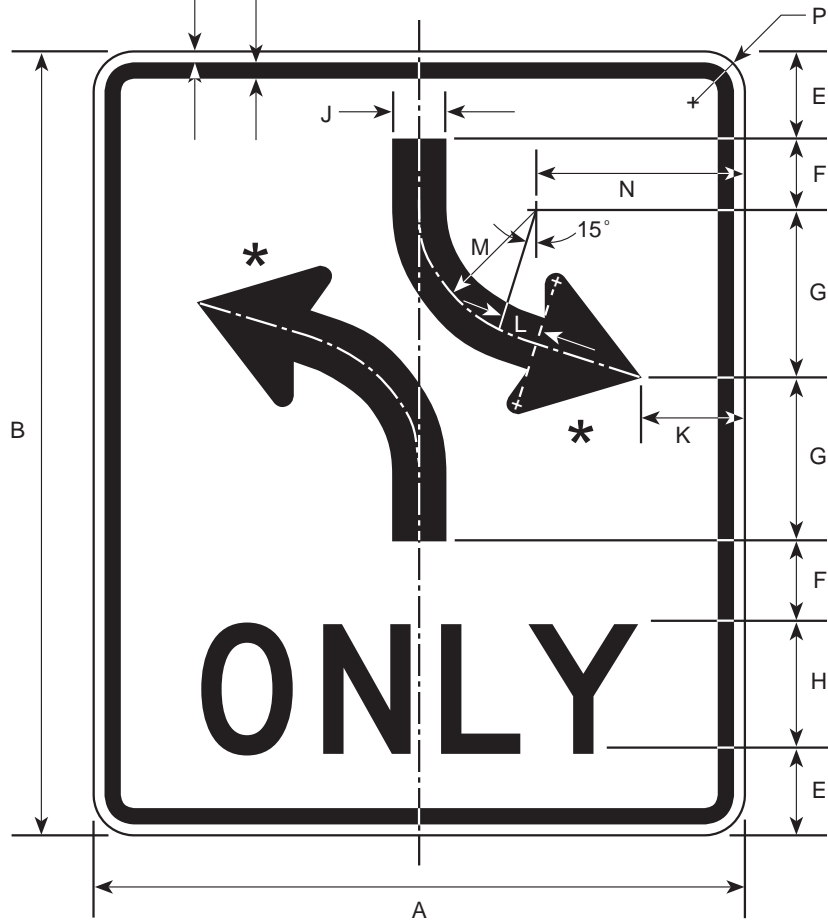

* See appendix for standard arrow details

DIMENSIONS (MILLIMETERS)

A	B	C	D	E	F	G	H
750	900	13	19	100	75	200	150D

J	K	L	M	N	P
63	100	38	150	225	47

DIMENSIONS (INCHES)

A	B	C	D	E	F	G	H
30	36	1/2	3/4	4	3	8	6D

J	K	L	M	N	P
2 1/2	4	1 1/2	6	9	1 7/8

COLORS

LEGEND - BLACK (NON-REFL)
BACKGROUND - WHITE (REFL)

R3-9B

11/97

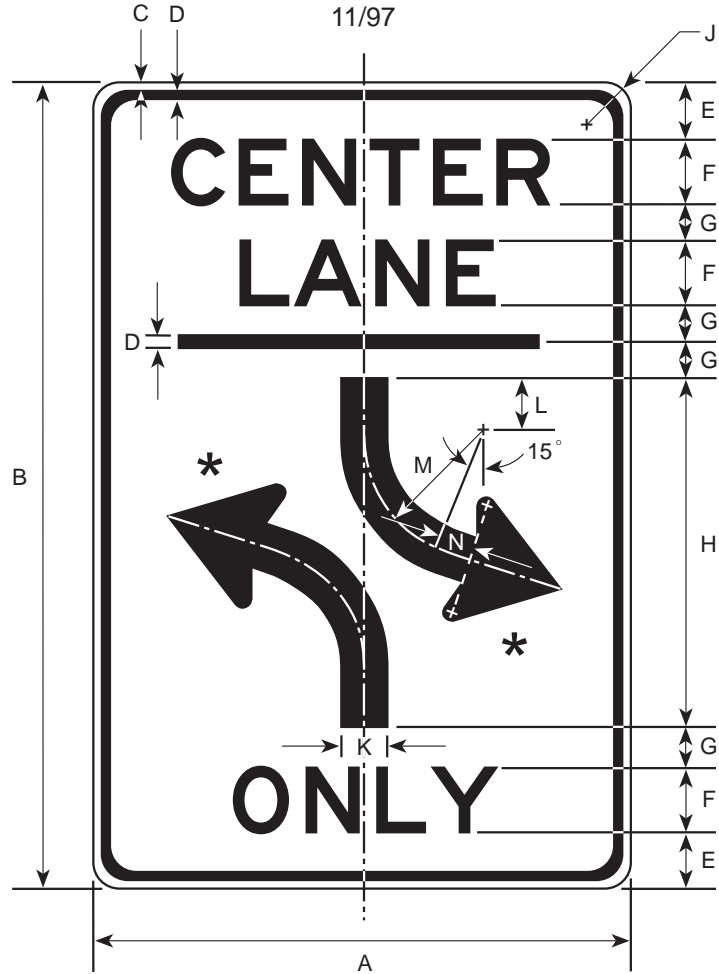

* See appendix for standard arrow details

DIMENSIONS (MILLIMETERS)												
A	B	C	D	E	F	G	H	J	K	L	M	N
600	900	9	16	63	75E	38	400	38	50	63	150	38
900	1200	16	22	88	125E	38	500	56	75	75	200	50

DIMENSIONS (INCHES)												
A	B	C	D	E	F	G	H	J	K	L	M	N
24	36	3/8	5/8	2 1/2	3E	1 1/2	16	1 1/2	2 1/2	2 1/2	6	1 1/2
36	48	5/8	7/8	3 1/2	5E	1 1/2	20	2 1/4	3	3	8	2

COLORS

LEGEND - BLACK (NON-REFL)
BACKGROUND - WHITE (REFL)

R3-10

11/97

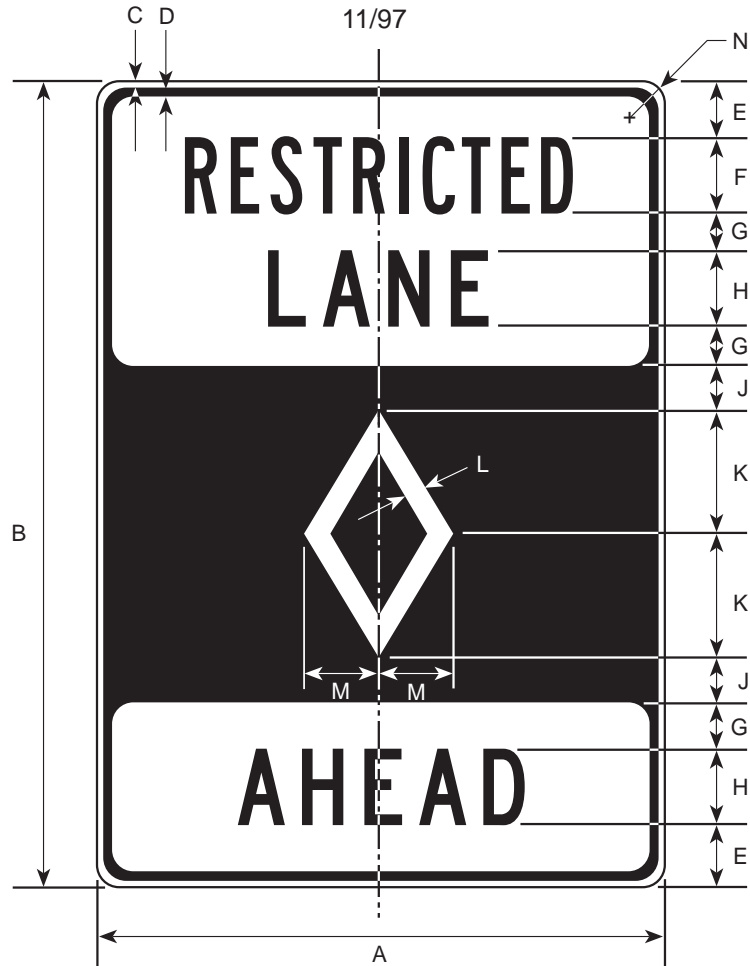

DIMENSIONS (MILLIMETERS)												
A	B	C	D	E	F	G	H	J	K	L	M	N
750	1050	13	19	81	100B	50	100C	31	188	28	94	47
900	1500	16	22	113	150B	75	150C	50	250	38	125	56
1200	2100	19	31	150	200B	100	200C	75	375	56	188	75

DIMENSIONS (INCHES)												
A	B	C	D	E	F	G	H	J	K	L	M	N
30	42	1/2	3/4	3 1/4	4B	2	4C	1 1/4	7 1/2	1 1/8	3 3/4	1 7/8
36	60	5/8	7/8	4 1/2	6B	3	6C	2	10	1 1/2	5	2 1/4
48	84	3/4	1 1/4	6	8B	4	8C	3	15	2 1/4	7 1/2	3

COLORS

LEGEND - BLACK (NON-REFL)
 BACKGROUND - WHITE (REFL)
 SYMBOL - REFL WHITE ON BLACK

R3-102

8/02



* 20% - REDUCED SPACING

DIMENSIONS (MILLIMETERS)												
A	B	C	D	E	F	G	H	J	K	L	M	N
900	1500	16	22	113	150D	75	125C	50	250	38	125	75

DIMENSIONS (INCHES)												
A	B	C	D	E	F	G	H	J	K	L	M	N
48	84	5/8	7/8	4 1/2	6D	3	6C	2	10	1 1/2	5	3

COLORS

LEGEND - BLACK (NON-REFL)
 BACKGROUND - WHITE (REFL)
 SYMBOL - REFL WHITE ON BLACK

R3-103

6/03

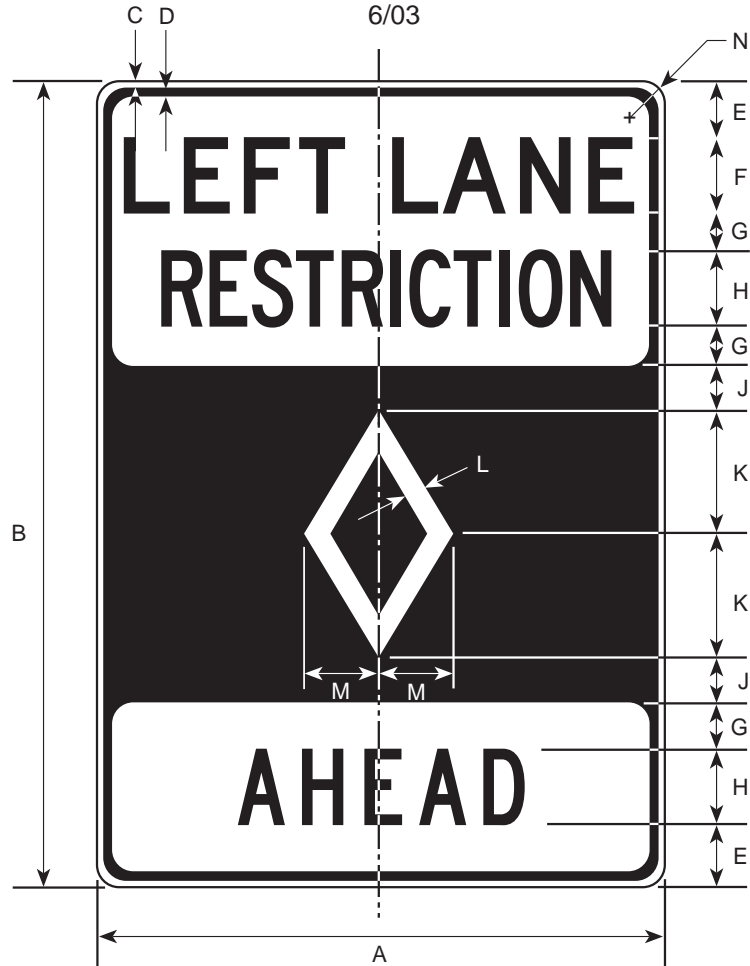

DIMENSIONS (MILLIMETERS)												
A	B	C	D	E	F	G	H	J	K	L	M	N
1200	2100	19	31	113	150D	75	150C	50	250	38	125	75

DIMENSIONS (INCHES)												
A	B	C	D	E	F	G	H	J	K	L	M	N
48	84	3/4	1 1/4	4 1/2	6D	3	6C	2	10	1 1/2	5	3

COLORS

LEGEND - BLACK (NON-REFL)
 BACKGROUND - WHITE (REFL)
 SYMBOL - REFL WHITE ON BLACK

R3-11

6/00

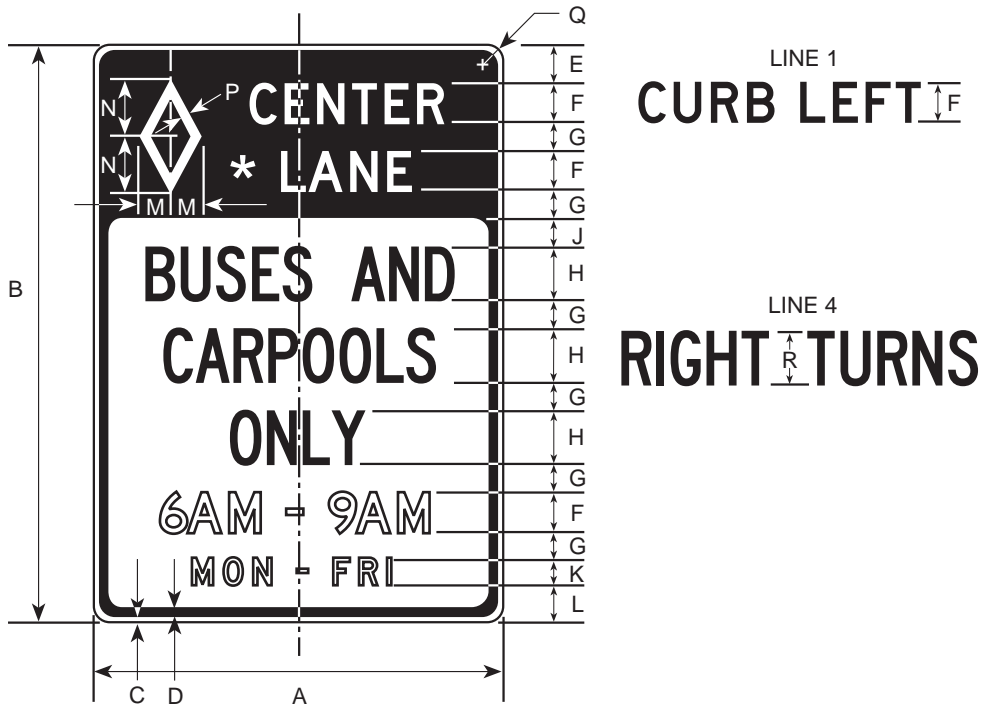

* Optically locate Symbol and Top Legend

DIMENSIONS (MILLIMETERS)							
A	B	C	D	E	F	G	H
750	1050	13	19	63	75D	50	100C
1200	1500	16	22	100	100D	75	150C
J	K	L	M	N	P	Q	R
38	50D	75	63	125	19	47	100B
50	75D	75	94	188	28	56	150B

DIMENSIONS (INCHES)							
A	B	C	D	E	F	G	H
30	42	1/2	3/4	2 1/2	3D	2	4C
48	60	5/8	7/8	4	4D	3	6C
J	K	L	M	N	P	Q	R
1 1/2	2D	3	2 1/2	5	3/4	1 7/8	4B
2	3D	3	3 3/4	7 1/2	1 1/8	2 1/4	6B

TOP	COLORS	BOTTOM
SYMBOL & LEGEND - WHITE (REFL)	LEGEND - BLACK (NON-REFL)	LEGEND - BLACK (NON-REFL)
BACKGROUND - BLACK (NON-REFL)	BACKGROUND - WHITE (REFL)	BACKGROUND - WHITE (REFL)

R3-1102R

3/06

R3-1102L

3/06

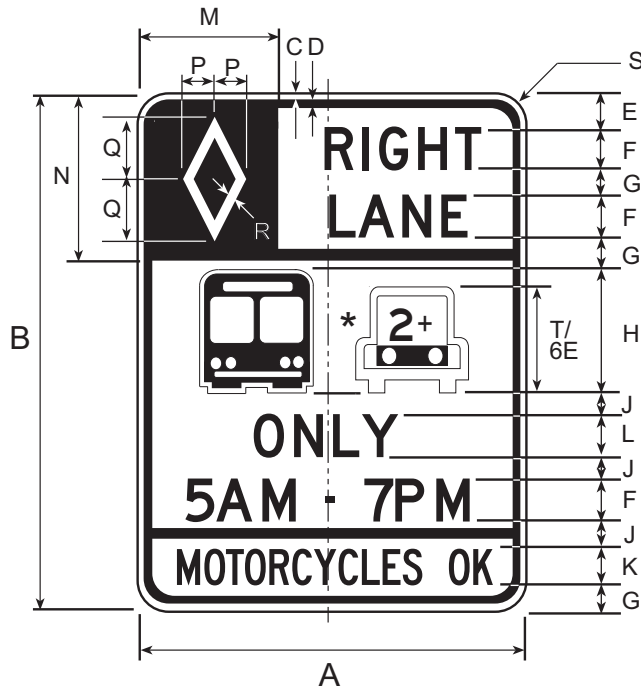

* SEE APPENDIX FOR STANDARD SYMBOLS

DIMENSIONS (MILLIMETERS)								
A	B	C	D	E	F	G	H	J
1350	1800	19	31	150	150D	100	450	75
K	L	M	N	P	Q	R	S	T
75C	150E	55	650	125	250	38	38	300

DIMENSIONS (INCHES)								
A	B	C	D	E	F	G	H	J
54	72	3/4	1 1/4	6	6D	4	18	3
K	L	M	N	P	Q	R	S	T
3C	6E	22	26	5	10	1 1/2	3	12

COLORS

LEGEND - BLACK (NON-REFL)
 BACKGROUND - WHITE (REFL)
 PREFERENTIAL LANE SYMBOL - WHITE (REFL) ON BLACK (NON-REFL)

R3-1103R

3/06

R3-1103L

3/06

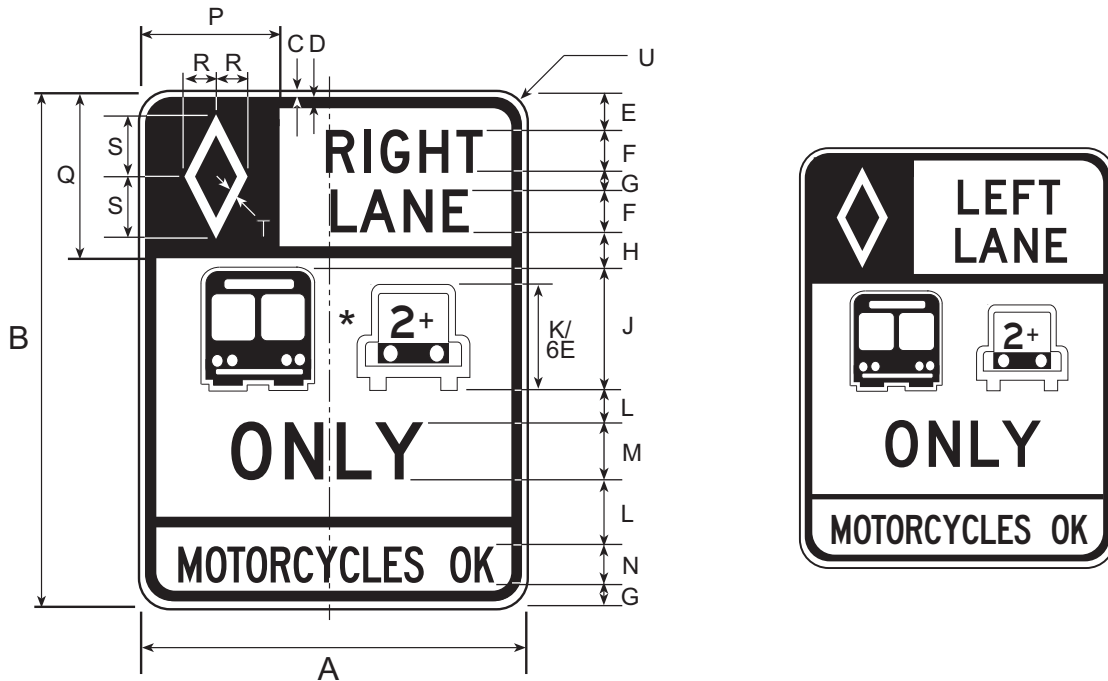

* SEE APPENDIX FOR STANDARD SYMBOLS

DIMENSIONS (MILLIMETERS)									
A	B	C	D	E	F	G	H	J	K
1350	1800	19	31	150	150D	100	125	450	300

L	M	N	P	Q	R	S	T	U
150	200D	75C	550	650	125	250	38	75

DIMENSIONS (INCHES)									
A	B	C	D	E	F	G	H	J	K
54	72	3/4	1 1/4	6	6D	4	5	18	12

L	M	N	P	Q	R	S	T	U
6	8D	3C	22	26	5	10	1 1/2	3

COLORS

LEGEND - BLACK (NON-REFL)
 BACKGROUND - WHITE (REFL)
 SYMBOLS - WHITE (REFL) ON BLACK (NON-REFL)

R3-1104L

6/03

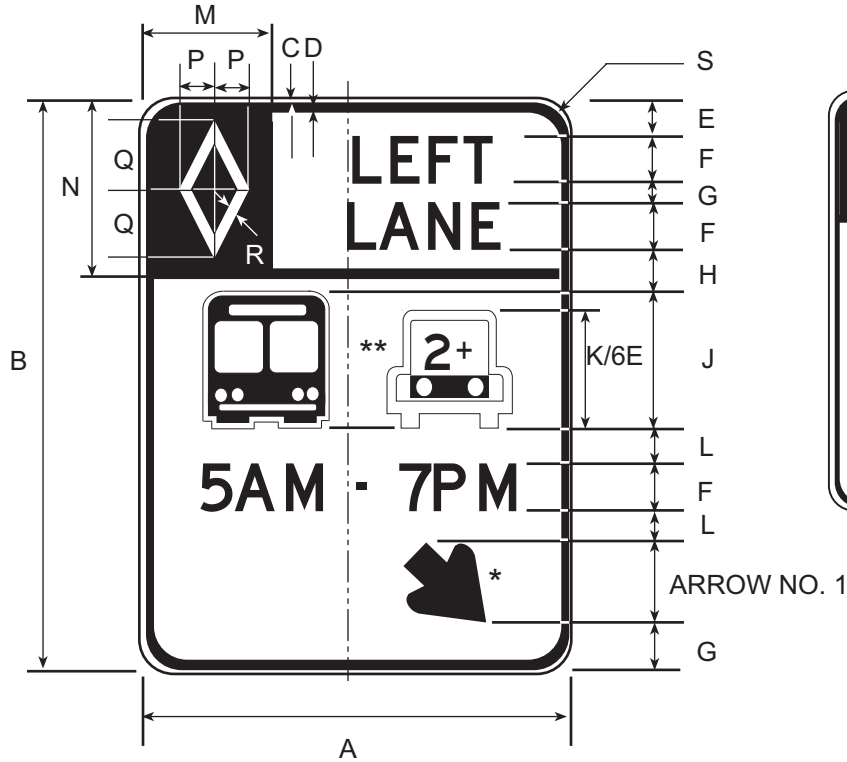

R3-1104R

6/03



* SEE APPENDIX FOR STANDARD ARROW DETAILS

** SEE APPENDIX FOR STANDARD SYMBOLS

DIMENSIONS (MILLIMETERS)								
A	B	C	D	E	F	G	H	J
1350	1800	19	31	150	150D	100	125	450

K	L	M	N	P	Q	R	S
300	75	550	650	125	200	38	75

DIMENSIONS (MILLIMETERS)								
A	B	C	D	E	F	G	H	J
54	72	3/4	1 1/4	6	6D	4	5	18

K	L	M	N	P	Q	R	S
12	3	22	26	5	10	1 1/2	3

COLORS

LEGEND - BLACK (NON-REFL)

BACKGROUND - WHITE (REFL)

SYMBOLS - WHITE (REFL) ON BLACK (NON-REFL)

R3-12

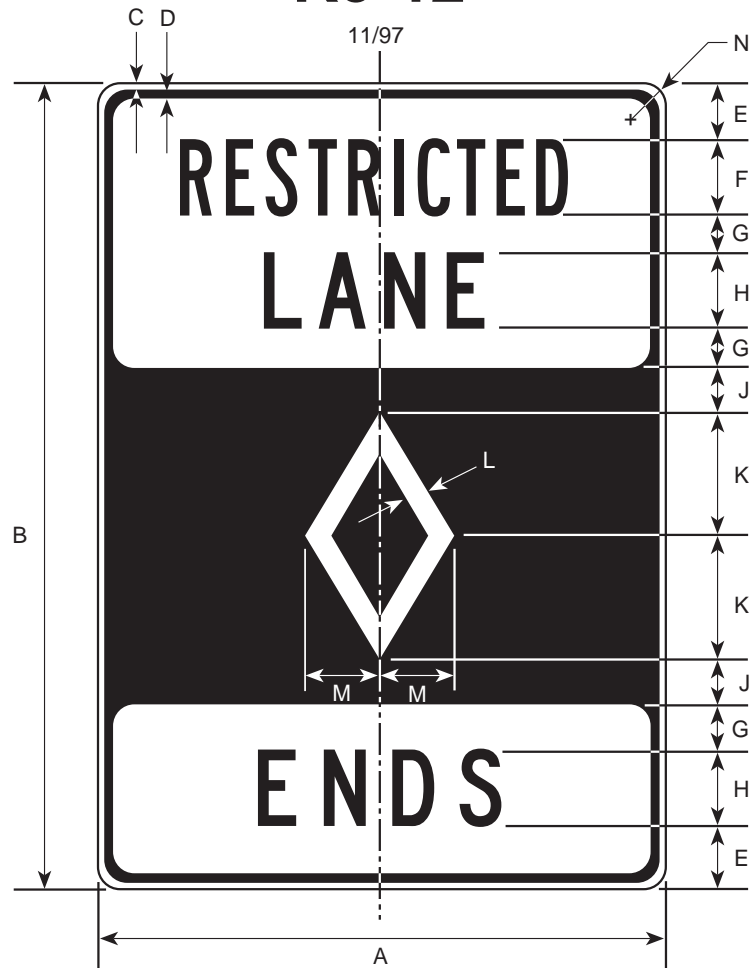

DIMENSIONS (MILLIMETERS)

A	B	C	D	E	F	G	H	J	K	L	M	N
750	1050	13	19	81	100B	50	100C	31	188	28	94	47
900	1500	16	22	113	150B	75	150C	50	250	38	125	56
1200	2100	19	31	150	200B	100	200C	75	375	56	188	75

DIMENSIONS (INCHES)

A	B	C	D	E	F	G	H	J	K	L	M	N
30	42	1/2	3/4	3 1/4	4B	2	4C	1 1/4	7 1/2	1 1/8	3 3/4	1 7/8
36	60	5/8	7/8	4 1/2	6B	3	6C	2	10	1 1/2	5	2 1/4
48	84	3/4	1 1/4	6	8B	4	8C	3	15	2 1/4	7 1/2	3

COLORS

LEGEND - BLACK (NON-REFL)
 BACKGROUND - WHITE (REFL)
 SYMBOL - REFL WHITE ON BLACK

R3-1201

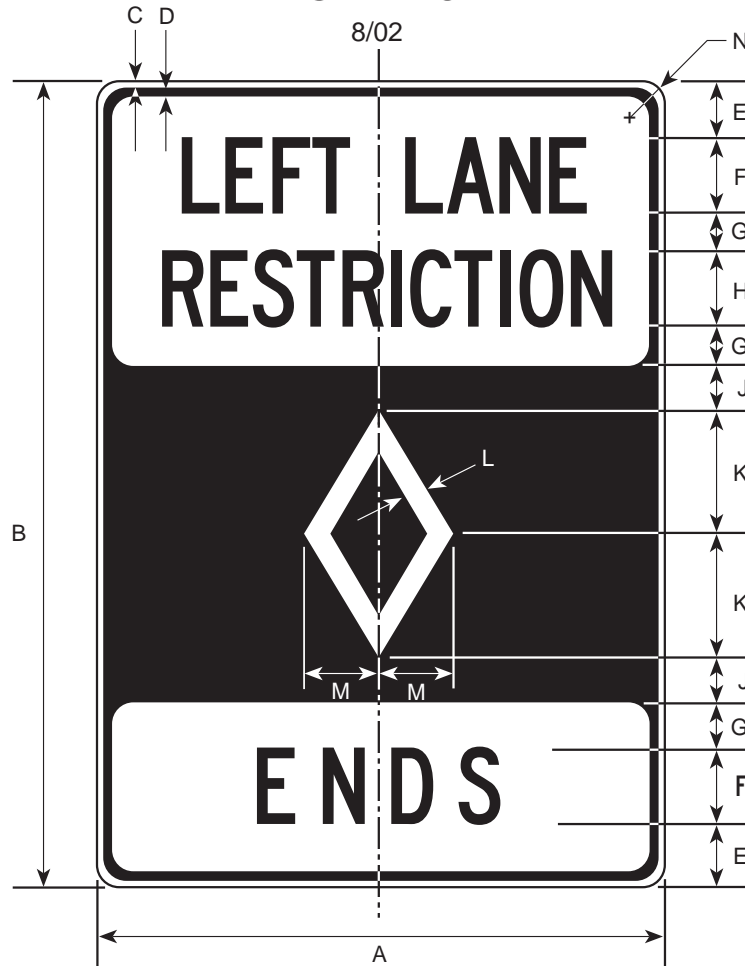

DIMENSIONS (MILLIMETERS)												
A	B	C	D	E	F	G	H	J	K	L	M	N
1200	1500	16	22	113	150D	75	150C	50	250	38	125	56

DIMENSIONS (INCHES)												
A	B	C	D	E	F	G	H	J	K	L	M	N
48	60	5/8	7/8	4 1/2	6D	3	6C	2	10	1 1/2	5	2 1/4

COLORS

LEGEND - BLACK (NON-REFL)
 BACKGROUND - WHITE (REFL)
 SYMBOL - REFL WHITE ON BLACK

R3-1202

6/03

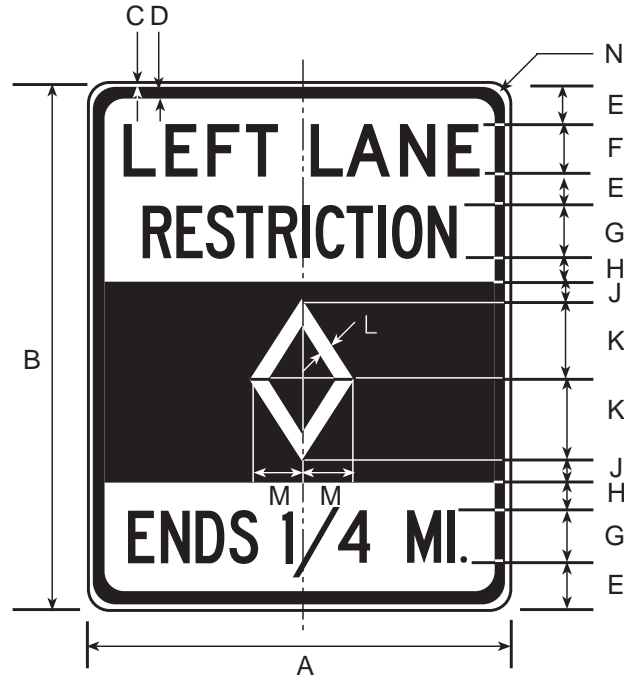

DIMENSIONS (MILLIMETERS)												
A	B	C	D	E	F	G	H	J	K	L	M	N
1200	1500	19	31	100	150D	150C	75	50	250	38	125	75

DIMENSIONS (INCHES)												
A	B	C	D	E	F	G	H	J	K	L	M	N
48	60	3/4	1 1/4	4	6D	6C	3	2	10	1 1/2	5	3

COLORS
 LEGEND - BLACK (NON-REFL)
 BACKGROUND - WHITE (REFL)
 SYMBOL - WHITE (REFL) ON BLACK (NON-REFL)

R3-1203

6/03

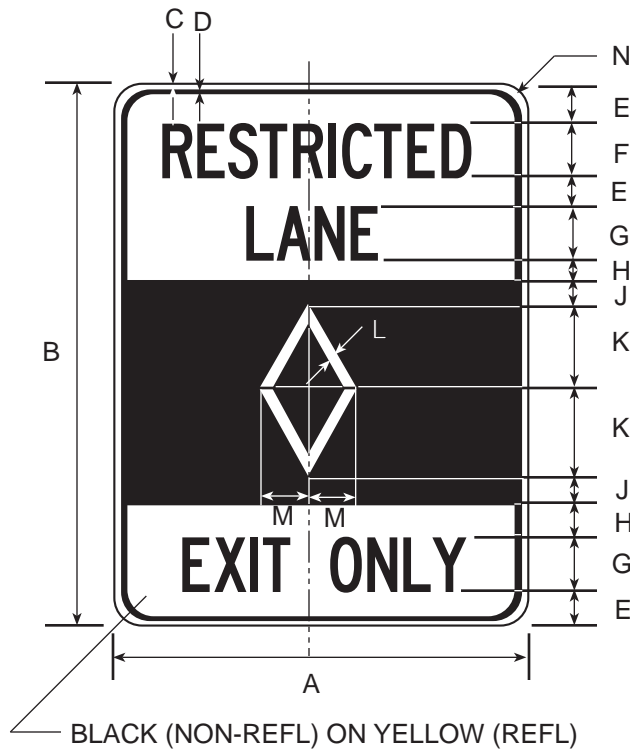

DIMENSIONS (MILLIMETERS)												
A	B	C	D	E	F	G	H	J	K	L	M	N
1200	1500	19	31	100	150C	150D	75	50	250	38	125	75

DIMENSIONS (INCHES)												
A	B	C	D	E	F	G	H	J	K	L	M	N
48	60	3/4	1 1/4	4	6C	6D	3	2	10	1 1/2	5	3

COLORS
 LEGEND - BLACK (NON-REFL)
 BACKGROUND - WHITE (REFL)
 SYMBOL - WHITE (REFL) ON BLACK (NON-REFL)

R3-1204

6/03

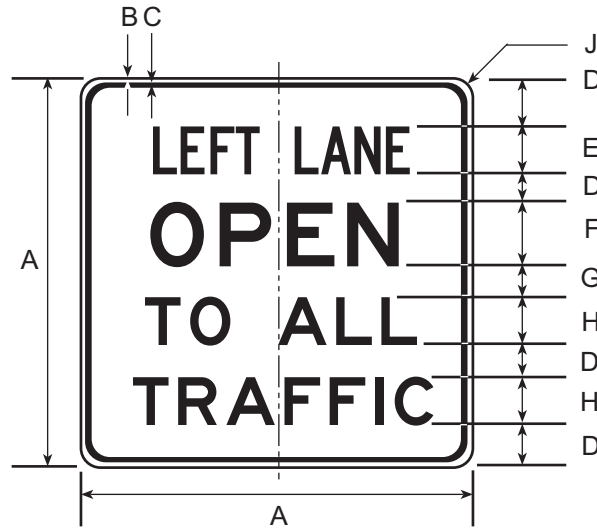

DIMENSIONS (MILLIMETERS)								
A	B	C	D	E	F	G	H	J
1200	19	31	100	150C	200E	150	150E	75

DIMENSIONS (INCHES)								
A	B	C	D	E	F	G	H	J
48	3/4	1 1/4	4	6C	8E	6	6E	3

COLORS
 LEGEND - BLACK (NON-REFL)
 BACKGROUND - WHITE (REFL)

R3-13

11/97

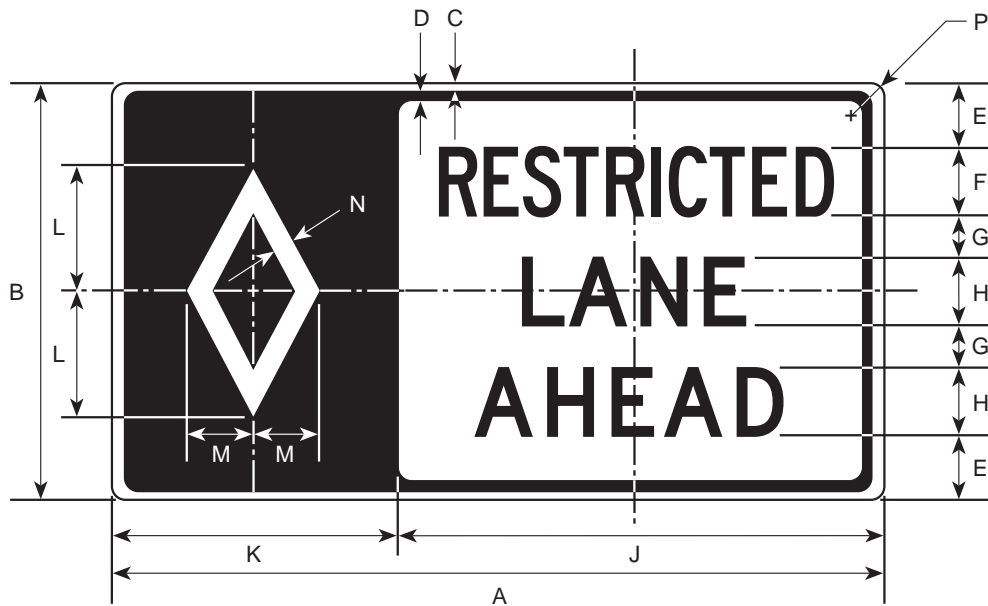

DIMENSIONS (MILLIMETERS)													
A	B	C	D	E	F	G	H	J	K	L	M	N	P
1500	900	16	22	138	150C	88	150D	1050	600	300	150	50	56
2100	1200	19	31	175	200C	125	200D	1350	750	400	200	63	74
2700	1500	25	38	225	250C	150	250D	1650	900	500	250	75	94

DIMENSIONS (INCHES)													
A	B	C	D	E	F	G	H	J	K	L	M	N	P
60	36	5/8	7/8	5 1/2	6C	3 1/2	6D	42	24	12	6	2	2 1/4
84	48	3/4	1 1/4	7	8C	5	8D	54	30	16	8	2 1/2	3
108	60	1	1 1/2	9	10C	6	10D	66	36	20	10	3	3 3/4

COLORS

LEGEND - BLACK (NON-REFL)
 BACKGROUND - WHITE (REFL)
 SYMBOL - REFL WHITE ON BLACK

R3-14

11/97

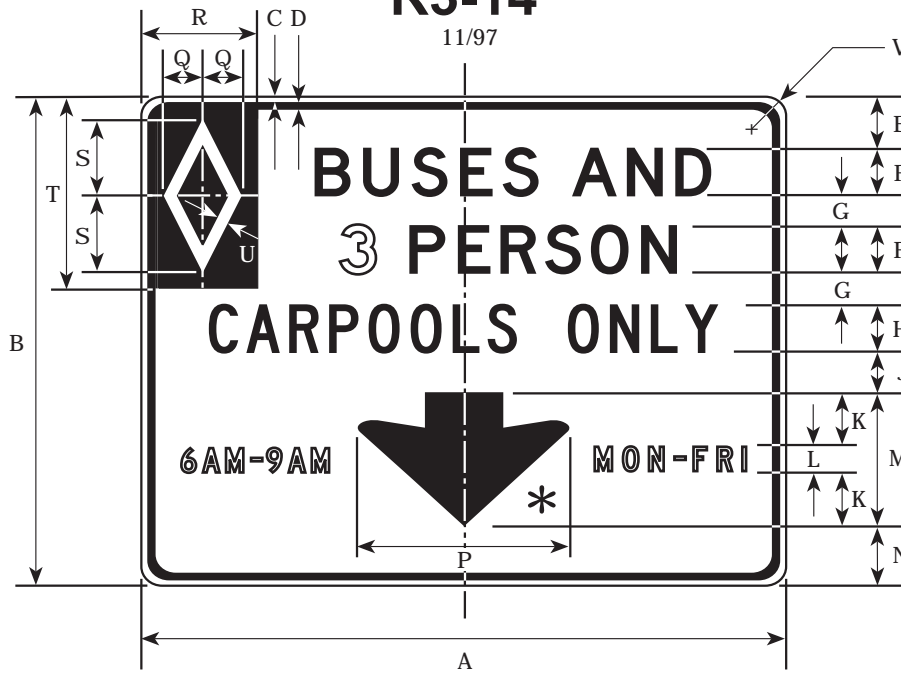

* See appendix for standard arrow details

DIMENSIONS (MILLIMETERS)									
A	B	C	D	E	F	G	H	J	K
1800	1500	25	38	150	150D	100	150C	113	169
2400	1800	31	44	200	200D	150	200C	113	156
2700	2100	38	50	250	250D	150	250C	100	213
L	M	N	P	Q	R	S	T	U	V
75C	413	175	600	100	275	200	550	31	94
100C	413	175	600	125	375	250	750	38	125
125C	550	150	800	150	450	300	900	50	150

DIMENSIONS (INCHES)									
A	B	C	D	E	F	G	H	J	K
72	60	1	1 1/2	6	6D	4	6C	4 1/2	6 3/4
96	72	1 1/4	1 3/4	8	8D	6	8C	4 1/2	6 1/4
108	84	1 1/2	2	10	10D	6	10C	4	8 1/2
L	M	N	P	Q	R	S	T	U	V
3C	16 1/2	7	24	4	11	8	22	1 1/4	3 3/4
4C	16 1/2	7	24	5	15	10	30	1 1/2	5
5C	22	6	32	6	18	12	36	2	6

COLORS

LEGEND - BLACK (NON REFL)
 BACKGROUND - WHITE (REFL)
 SYMBOL - REFL WHITE ON BLACK

R3-1401

3/06

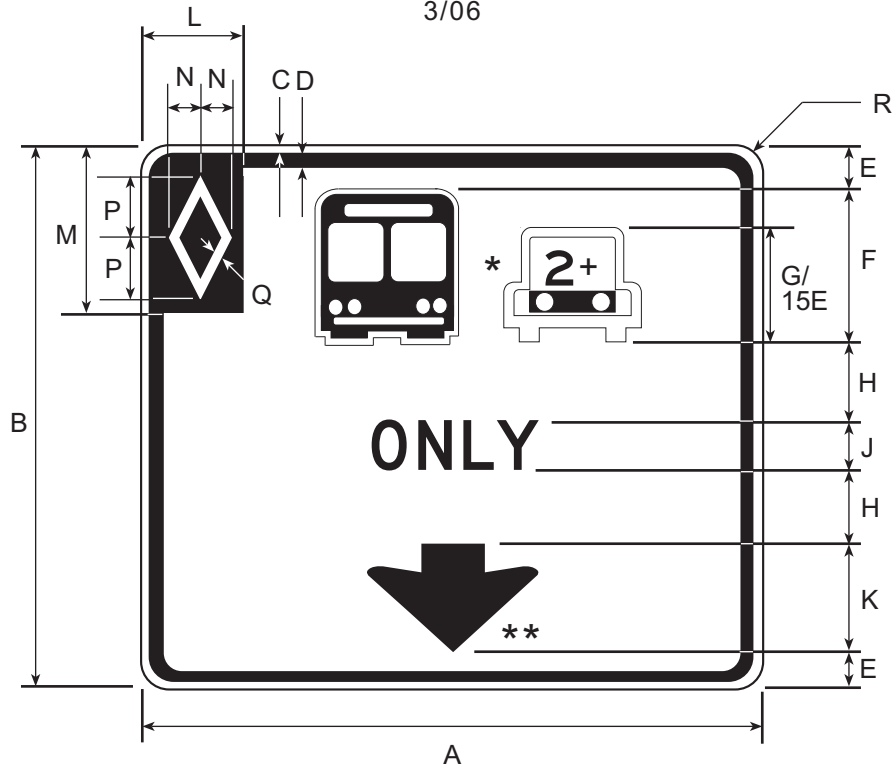

* SEE APPENDIX FOR STANDARD SYMBOLS

** SEE APPENDIX FOR STANDARD ARROW DETAILS

DIMENSIONS (MILLIMETERS)							
A	B	C	D	E	F	G	H
3000	2900	38	50	150	900	750	200
J	K	L	M	N	P	Q	R
250D	550	450	900	150	300	50	150

DIMENSIONS (INCHES)							
A	B	C	D	E	F	G	H
120	96	1 1/2	2	6	36	30	8
J	K	L	M	N	P	Q	R
10D	22	18	36	6	12	2	6

COLORS

LEGEND - BLACK (NON-REFL)

BACKGROUND - WHITE (REFL)

SYMBOLS - WHITE (REFL) ON BLACK (NON-REFL)

R3-1402

6/03

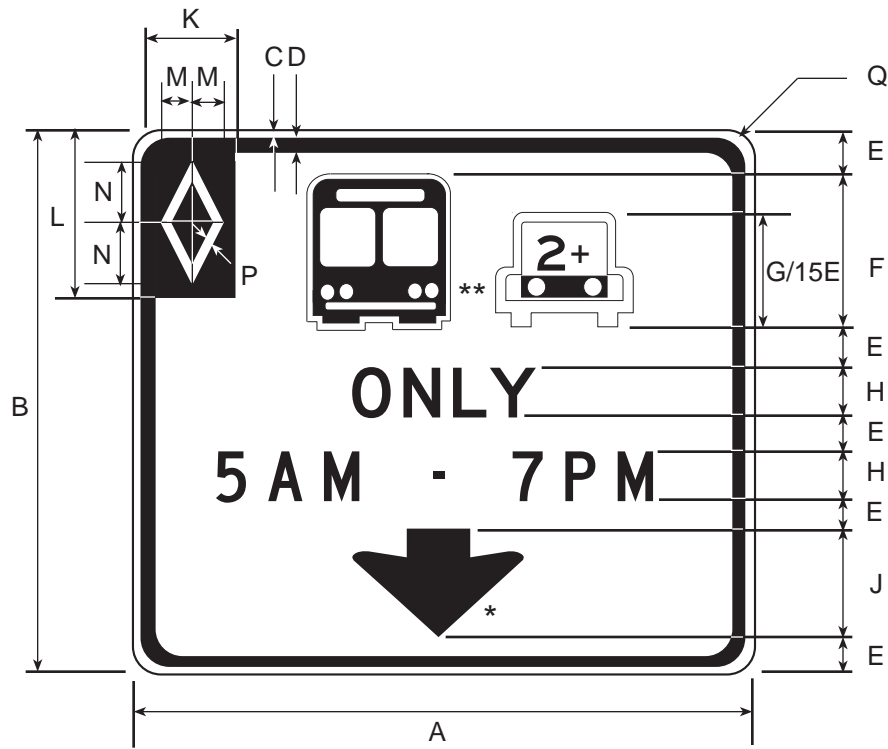

* SEE APPENDIX FOR STANDARD ARROW DETAILS

**SEE APPENDIX FOR STANDARD SYMBOLS

DIMENSIONS (MILLIMETERS)							
A	B	C	D	E	F	G	H
3000	2700	38	50	150	900	750	250D

J	K	L	M	N	P	Q
550	450	900	150	300	50	150

DIMENSIONS (INCHES)							
A	B	C	D	E	F	G	H
120	108	1 1/2	2	6	36	30	10D

J	K	L	M	N	P	Q
22	18	36	6	12	2	6

COLORS

LEGEND - BLACK (NON-REFL)
 BACKGROUND - WHITE (REFL)
 SYMBOLS - WHITE (REFL) ON BLACK (NON-REFL)

R3-15

11/97

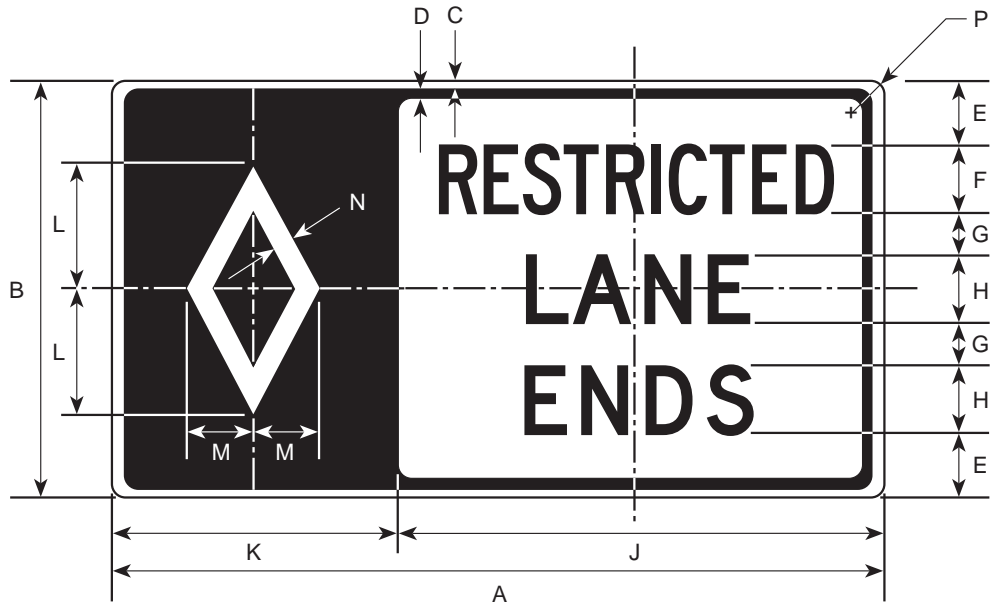

DIMENSIONS (MILLIMETERS)													
A	B	C	D	E	F	G	H	J	K	L	M	N	P
1500	900	16	22	138	150C	88	150D	1050	600	300	150	50	56
2100	1200	19	31	175	200C	125	200D	1350	750	400	200	63	74
2400	1500	25	38	225	250C	150	250D	1650	900	500	250	75	94

DIMENSIONS (INCHES)													
A	B	C	D	E	F	G	H	J	K	L	M	N	P
60	36	5/8	7/8	5 1/2	6C	3 1/2	6D	42	24	12	6	2	2 1/4
84	48	3/4	1 1/4	7	8C	5	8D	54	30	16	8	2 1/2	3
96	60	1	1 1/2	9	10C	6	10D	66	36	20	10	3	3 3/4

COLORS

LEGEND - BLACK (NON-REFL)
 BACKGROUND - WHITE (REFL)
 SYMBOL - REFL WHITE ON BLACK

R3-1502

5/03

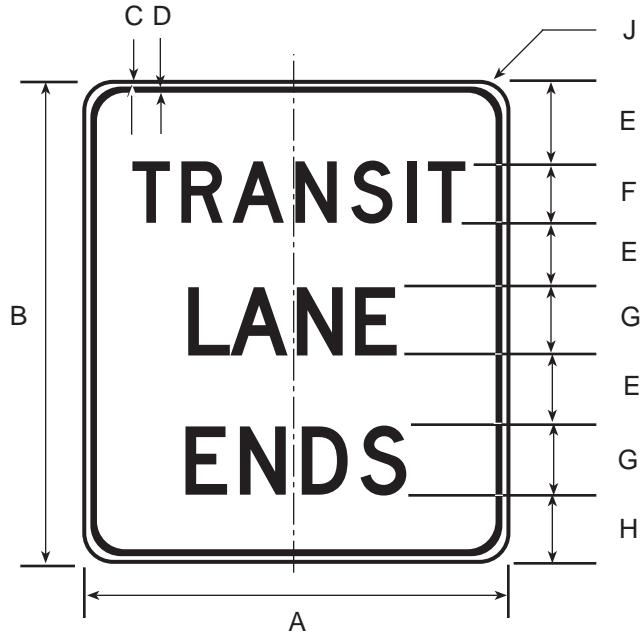

DIMENSIONS (MILLIMETERS)								
A	B	C	D	E	F	G	H	J
1200	1200	19	31	150	175D	200D	175	75

DIMENSIONS (INCHES)								
A	B	C	D	E	F	G	H	J
48	48	3/4	1 1/4	6	7D	8D	7	3

COLORS
 LEGEND - BLACK (NON-REFL)
 BACKGROUND - WHITE (REFL)

R3-1503

5/03

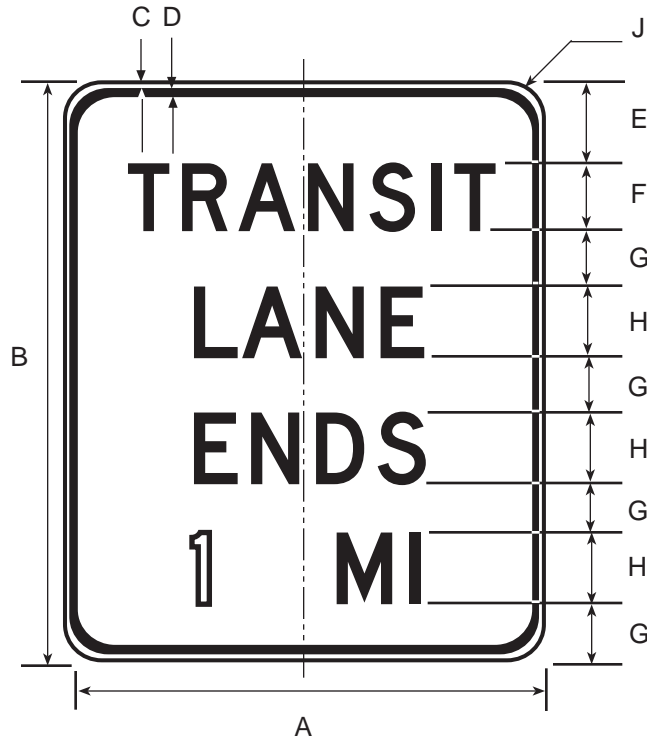

DIMENSIONS (MILLIMETERS)								
A	B	C	D	E	F	G	H	J
1200	1500	19	31	125	175D	150	200D	75

DIMENSIONS (INCHES)								
A	B	C	D	E	F	G	H	J
48	60	3/4	1 1/4	5	7D	6	8D	3

COLORS
 LEGEND - BLACK (NON-REFL)
 BACKGROUND - WHITE (REFL)

R3-17

2/06

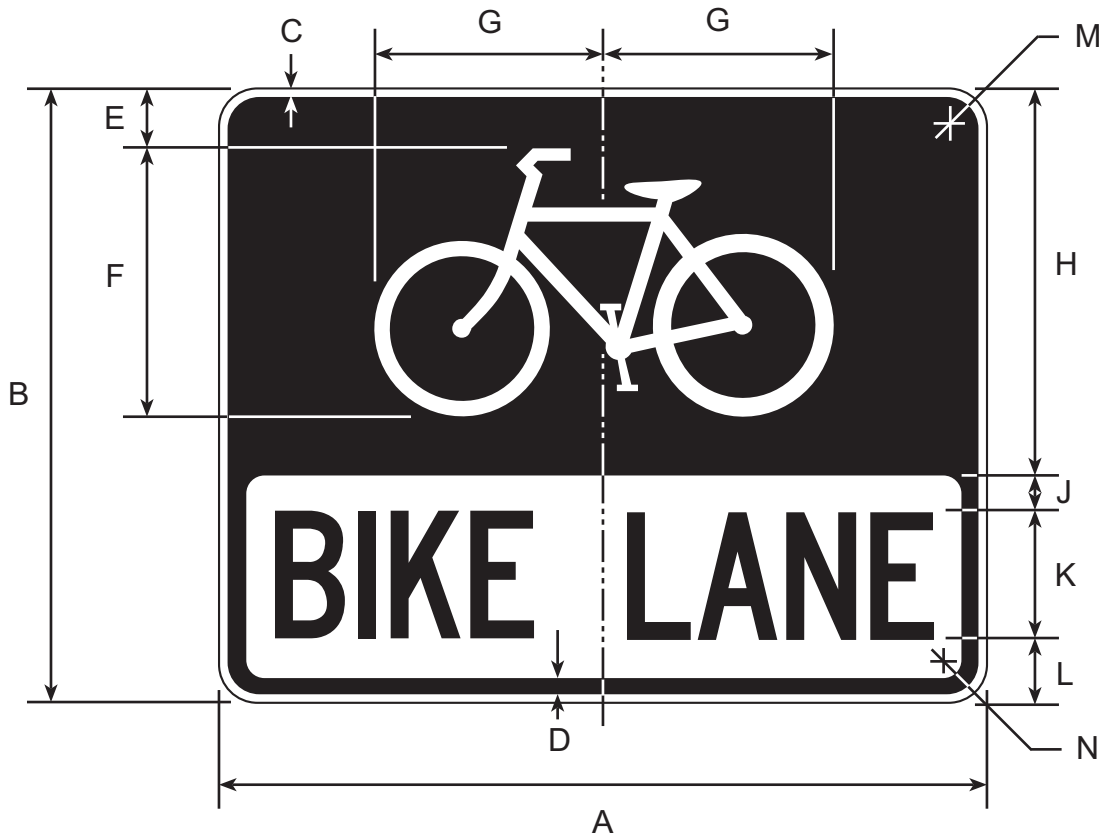

****** See appendix for standard symbol details

DIMENSIONS (MILLIMETERS)												
A	B	C	D	E	F	G	H	J	K	L	M	N
750	600	9	16	69	262	225	375	38	125C	63	38	19

DIMENSIONS (INCHES)												
A	B	C	D	E	F	G	H	J	K	L	M	N
30	24	3/8	5/8	2 3/4	10 1/2	9	15	1 1/2	5C	2 1/2	1 1/2	3/4

COLORS

TOP

SYMBOL - WHITE (REFL)
BACKGROUND - BLACK (NON-REFL)

BOTTOM

LEGEND - BLACK (NON-REFL)
BACKGROUND - WHITE (REFL)

R3-17B

2/06



R3-17C



DIMENSIONS (MILLIMETERS)						
A	B	C	D	E	F	G
750	300	9	16	88	125D	38

DIMENSIONS (INCHES)						
A	B	C	D	E	F	G
30	12	3/8	5/8	3 1/2	5D	1 1/2

COLORS

LEGEND - BLACK (NON-REFL)
BACKGROUND - WHITE (REFL)

R3-18

2/06

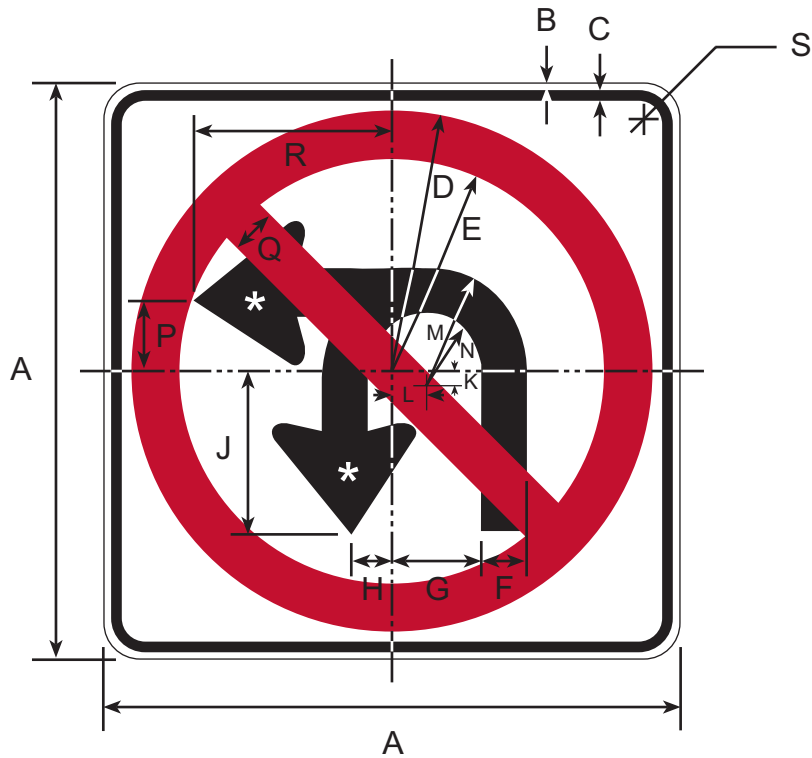

* SEE APPENDIX FOR STANDARD ARROW DETAILS

DIMENSIONS IN INCHES

A	B	C	D	E	F	G	H
24	3/8	5/8	10 13/32	8 9/16	2 5/64	3 11/16	1 27/32
30	1/2	3/4	13	10 3/4	2 19/32	4 19/32	2 9/32
36	5/8	7/8	15 39/64	12 57/64	3 1/8	5 33/64	2 3/4
48	3/4	1 1/4	20 13/16	17 9/64	4 11/64	7 3/8	3 11/16

J	K	L	M	N	P	Q	R	S
6 51/64	13/32	1 1/2	4 21/64	2 1/4	2 59/64	1 39/64	8 3/32	1 1/2
8 17/32	31/64	1 51/64	5 13/32	2 51/64	3 21/32	2	10 3/32	1 7/8
10 1/4	9/16	2 11/64	6 31/64	3 3/8	4 3/8	2 13/32	12 3/32	2 1/4
13 39/64	51/64	2 7/8	8 41/64	4 31/64	5 27/32	3 13/64	16 11/64	3

COLORS

CIRCLE & DIAGONAL - RED (REFL)
 ARROWS & BORDER - BLACK (NON-REFL)
 BACKGROUND - WHITE (REFL)

R3-2001

11/97

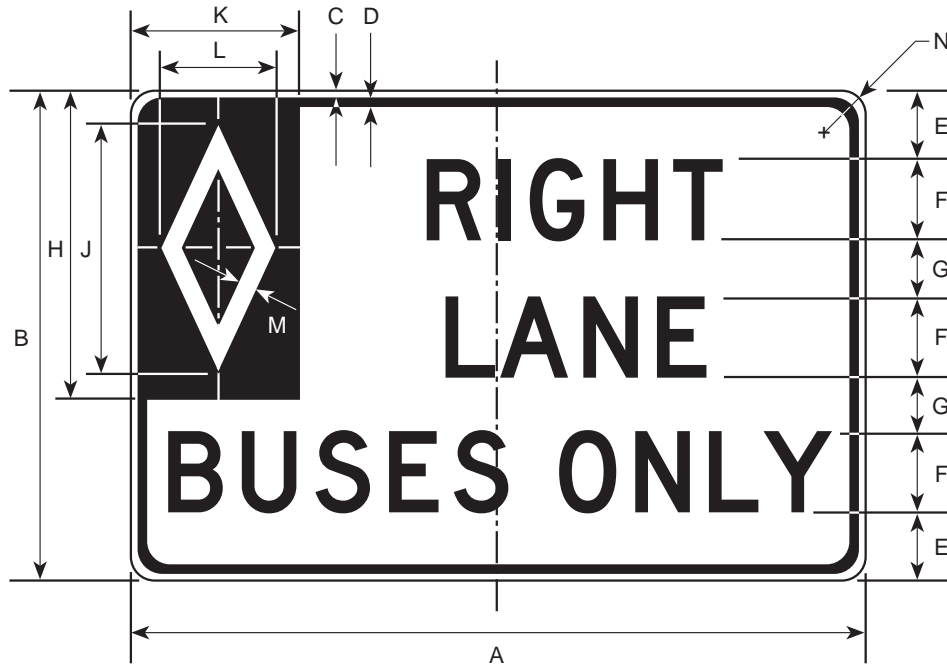

DIMENSIONS (MILLIMETERS)												
A	B	C	D	E	F	G	H	J	K	L	M	N
900	600	13	19	91	100D	59	388	300	200	150	19	38
1200	900	16	25	131	150D	94	578	450	297	225	25	56
1500	1200	19	31	175	200D	125	769	600	394	300	31	75

DIMENSIONS (INCHES)												
A	B	C	D	E	F	G	H	J	K	L	M	N
36	24	1/2	3/4	3 5/8	4D	2 3/8	15 1/2	12	8	6	3/4	1 1/2
48	36	5/8	1	5 1/4	6D	3 3/4	23 1/8	18	11 7/8	9	1	2 1/4
60	48	3/4	1 1/4	7	8D	5	30 3/4	24	15 3/4	12	1 1/4	3

COLORS

LEGEND - BLACK (NON-REFL)

BACKGROUND - WHITE (REFL)

R3-2002

5/03

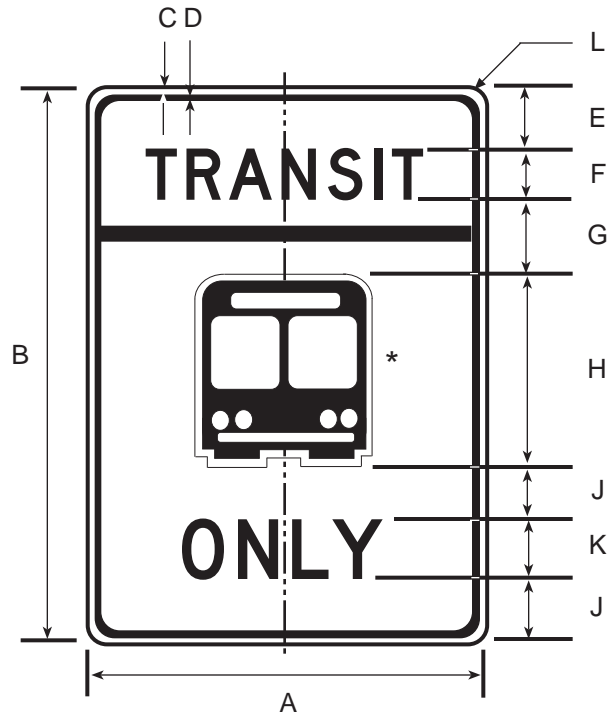

* SEE APPENDIX FOR STANDARD SYMBOL

DIMENSIONS (MILLIMETERS)										
A	B	C	D	E	F	G	H	J	K	L
900	1500	16	22	125	150D	175	550	150	200D	56

DIMENSIONS (INCHES)										
A	B	C	D	E	F	G	H	J	K	L
36	60	5/8	7/8	5	6D	7	22	6	8D	2 1/4

COLORS
 LEGEND - BLACK (NON-REFL)
 BACKGROUND - WHITE (REFL)

R3-2003

5/03

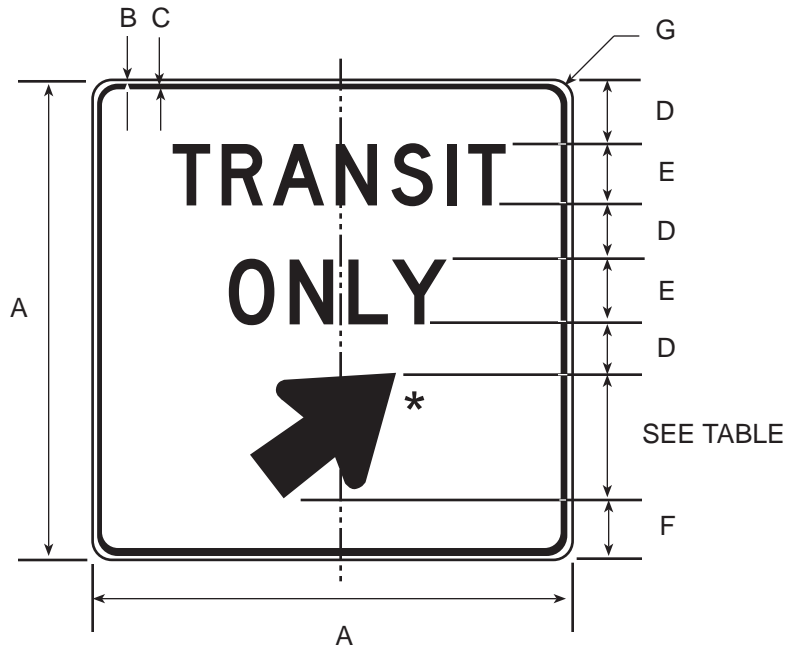

* SEE APPENDIX FOR STANDARD ARROW DETAIL

DIMENSIONS (MILLIMETERS)							
A	B	C	D	E	F	ARROW SIZE	G
1500	19	31	200	200D	225	NO. 1	75

DIMENSIONS (INCHES)							
A	B	C	D	E	F	ARROW SIZE	G
60	3/4	1 1/4	8	8D	9	NO. 1	3

COLORS
 LEGEND - BLACK (NON-REFL)
 BACKGROUND - WHITE (REFL)

R3-2004

5/03

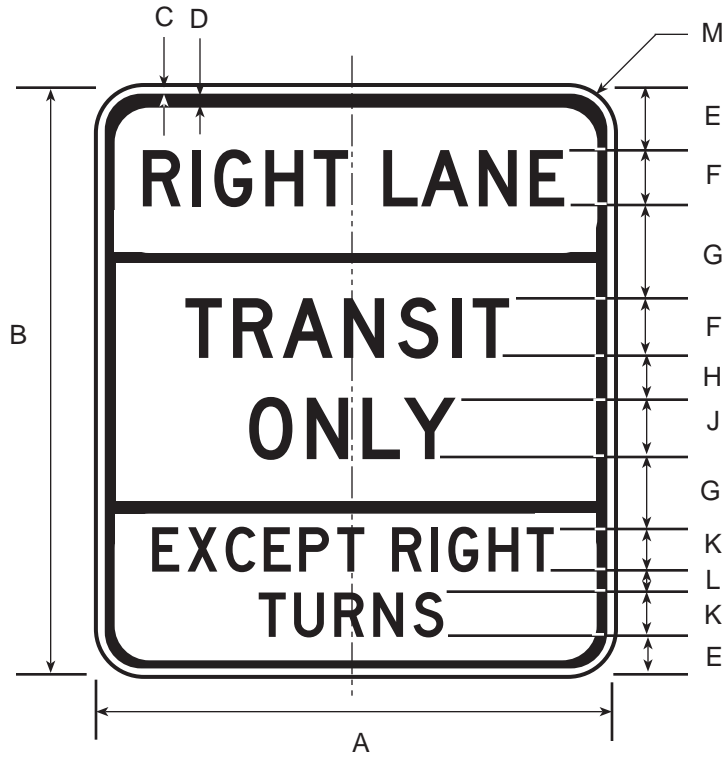

DIMENSIONS (MILLIMETERS)											
A	B	C	D	E	F	G	H	J	K	L	M
900	1050	16	22	100	100D	125	75	125D	75D	50	56

DIMENSIONS (INCHES)											
A	B	C	D	E	F	G	H	J	K	L	M
36	42	5/8	7/8	4	4D	5	3	5D	3D	2	2 1/4

COLORS
 LEGEND - BLACK (NON-REFL)
 BACKGROUND - WHITE (REFL)

R3-2005

6/03

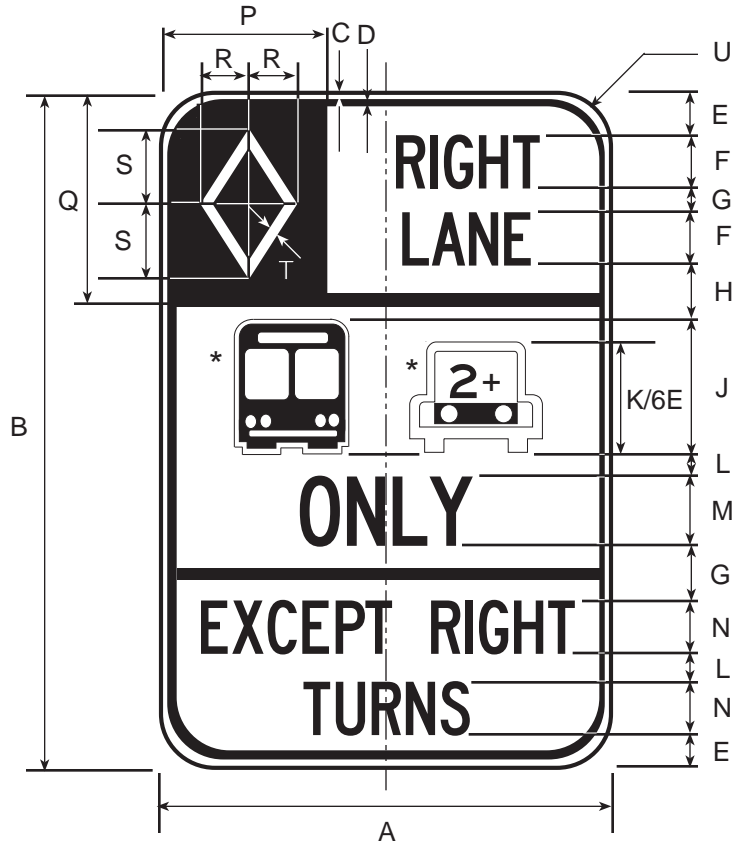

* SEE APPENDIX FOR STANDARD SYMBOLS

DIMENSIONS (MILLIMETERS)									
A	B	C	D	E	F	G	H	J	K
900	1350	16	22	100	100D	75	125	350	12

L	M	N	P	Q	R	S	T	U
50	125D	75C	300	450	94	188	31	56

DIMENSIONS (MILLIMETERS)									
A	B	C	D	E	F	G	H	J	K
36	54	5/8	7/8	4	4D	3	5	14	12

L	M	N	P	Q	R	S	T	U
2	5D	3C	12	18	3 3/4	7 1/2	1 1/4	2 1/4

COLORS
 LEGEND - BLACK (NON-REFL)
 BACKGROUND - WHITE (REFL)
 SYMBOLS - WHITE (REFL) ON BLACK (NON-REFL)

R4-1

11/97

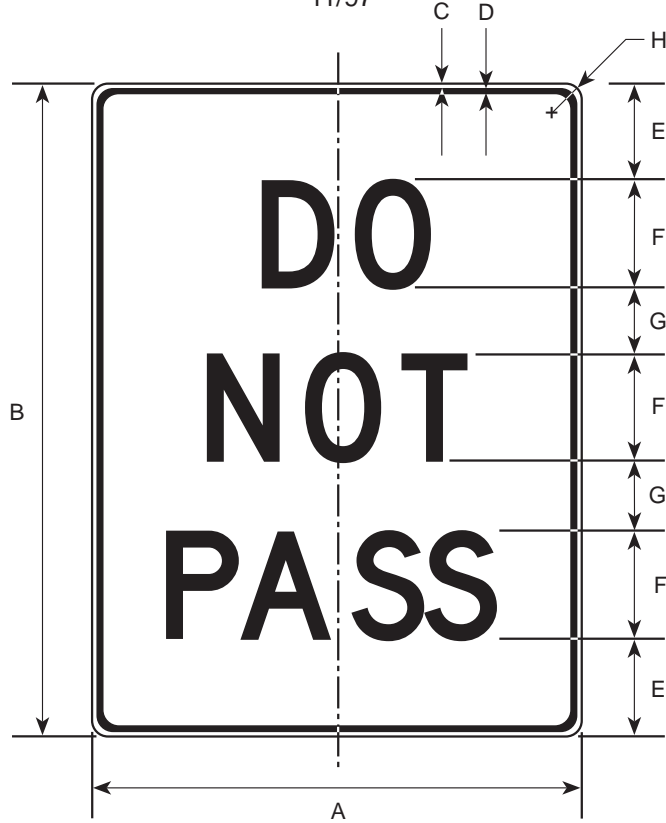

DIMENSIONS (MILLIMETERS)							
A	B	C	D	E	F	G	H
450	600	9	16	88	100D	63	38
600	750	9	16	88	150D	63	38
900	1200	16	22	175	200D	125	56
1200	1500	19	31	200	250D	175	75

DIMENSIONS (INCHES)							
A	B	C	D	E	F	G	H
18	24	3/8	5/8	3 1/2	4D	2 1/2	1 1/2
24	30	3/8	5/8	3 1/2	6D	2 1/2	1 1/2
36	48	5/8	7/8	7	8D	5	2 1/4
48	60	3/4	1 1/4	8	10D	7	3

COLORS

LEGEND - BLACK (NON-REFL)
 BACKGROUND - WHITE (REFL)

R4-2

11/97

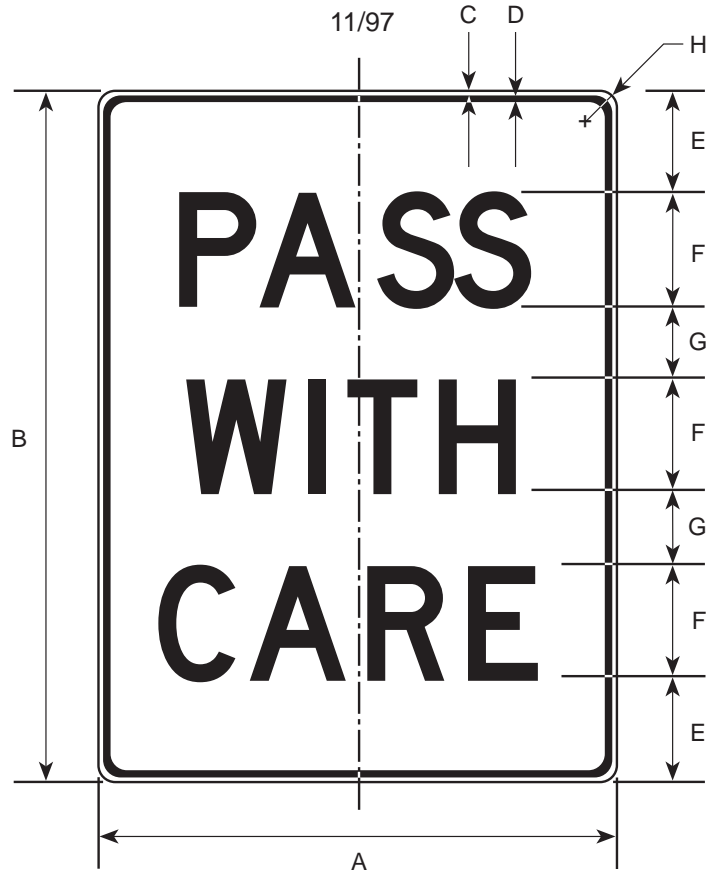

DIMENSIONS (MILLIMETERS)

A	B	C	D	E	F	G	H
450	600	9	16	88	100C	63	38
600	750	9	16	88	150C	63	38
900	1200	16	22	175	200C	125	56
1200	1500	19	31	200	250C	175	75

DIMENSIONS (INCHES)

A	B	C	D	E	F	G	H
18	24	3/8	5/8	3 1/2	4C	2 1/2	1 1/2
24	30	3/8	5/8	3 1/2	6C	2 1/2	1 1/2
36	48	5/8	7/8	7	8C	5	2 1/4
48	60	3/4	1 1/4	8	10C	7	3

COLORS

LEGEND - BLACK (NON-REFL)
BACKGROUND - WHITE (REFL)

R4-3

6/02



DIMENSIONS (MILLIMETERS)							
A	B	C	D	E	F	G	H
600	750	9	16	91	100D	56	38
750	900	13	19	97	125D	69	47
900	1200	16	22	150	150D	100	56
1200	1500	19	31	181	200D	113	75

DIMENSIONS (INCHES)							
A	B	C	D	E	F	G	H
24	30	3/8	5/8	3 5/8	4D	2 1/4	1 1/2
30	36	1/2	3/4	3 5/8	5D	2 3/4	1 7/8
36	48	5/8	7/8	6	6D	4	2 1/4
48	60	3/4	1 1/4	7 1/4	8D	4 1/2	3

COLORS

LEGEND - BLACK (NON-REFL)
 BACKGROUND - WHITE (REFL)

R4-301

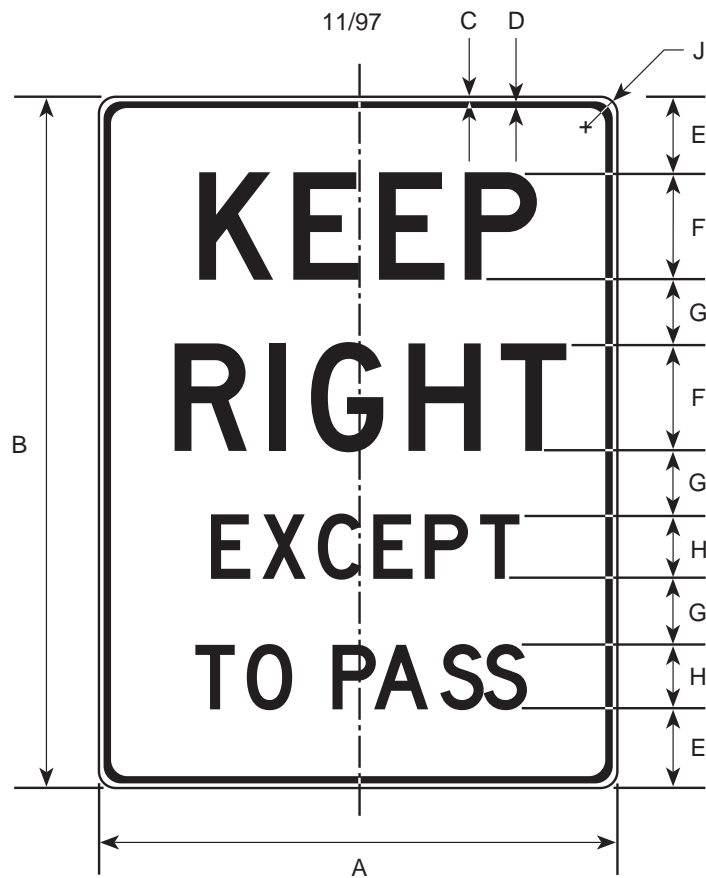

DIMENSIONS (MILLIMETERS)								
A	B	C	D	E	F	G	H	J
900	1200	16	22	150	200D	100	100D	56
1200	1500	19	31	181	250D	113	150D	75

DIMENSIONS (INCHES)								
A	B	C	D	E	F	G	H	J
36	48	5/8	7/8	6	8D	4	4D	2 1/4
48	60	3/4	1 1/4	7 1/4	10D	4 1/2	6D	3

COLORS

LEGEND - ó BLACK (NON-REFL)
 BACKGROUND - WHITE (REFL)

R4-302

6/00



DIMENSIONS (MILLIMETERS)												
A	B	C	D	E	F	G	H	J	K	L	M	N
1200	1500	19	31	100	150D	75	125C	63	100C	125	125D	50

DIMENSIONS (INCHES)												
A	B	C	D	E	F	G	H	J	K	L	M	N
48	60	3/4	1 1/4	4	6D	3	5C	2 1/2	4C	5	5D	2

COLORS

LEGEND - BLACK (NON-REFL)
 BACKGROUND - WHITE (REFL)

R4-302A

12/98

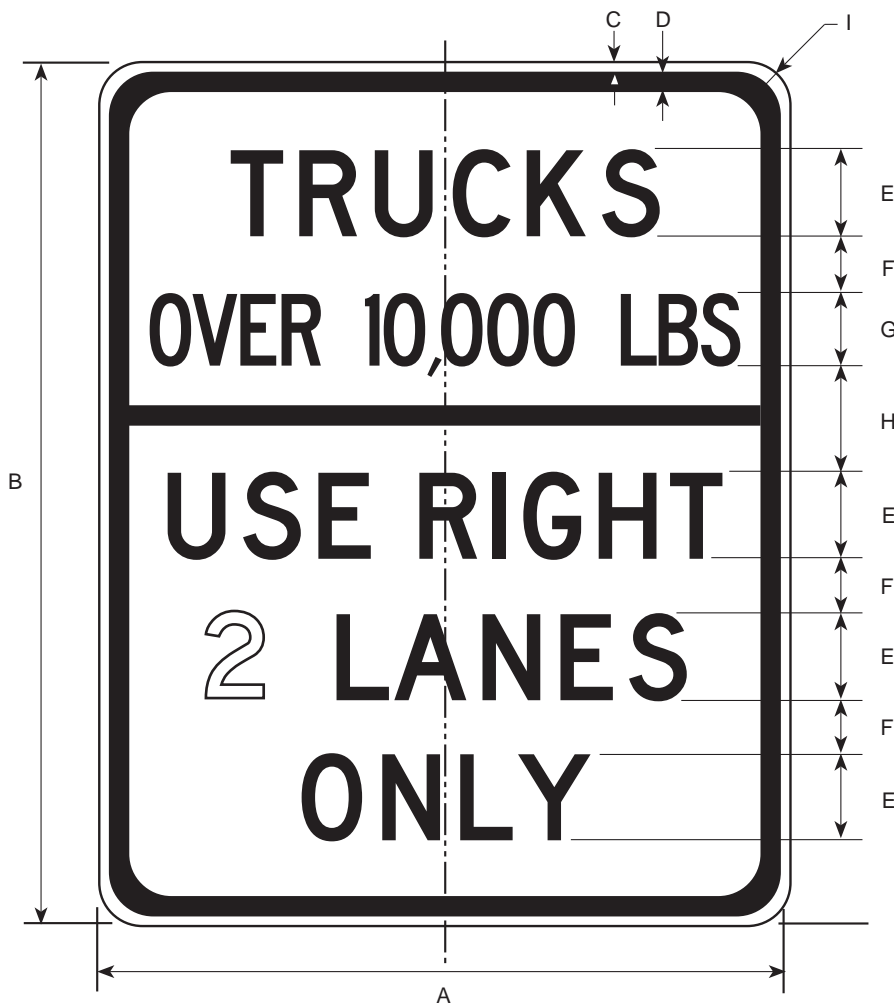

DIMENSIONS (MILLIMETERS)								
A	B	C	D	E	F	G	H	I
1200	1500	19	31	150D	100	125C	188	75

DIMENSIONS (INCHES)								
A	B	C	D	E	F	G	H	I
48	60	3/4	1 1/4	6D	4	5C	7 1/2	3

COLORS

LEGEND - BLACK (NON-REFL)
 BACKGROUND - WHITE (REFL)

R4-302B

12/98

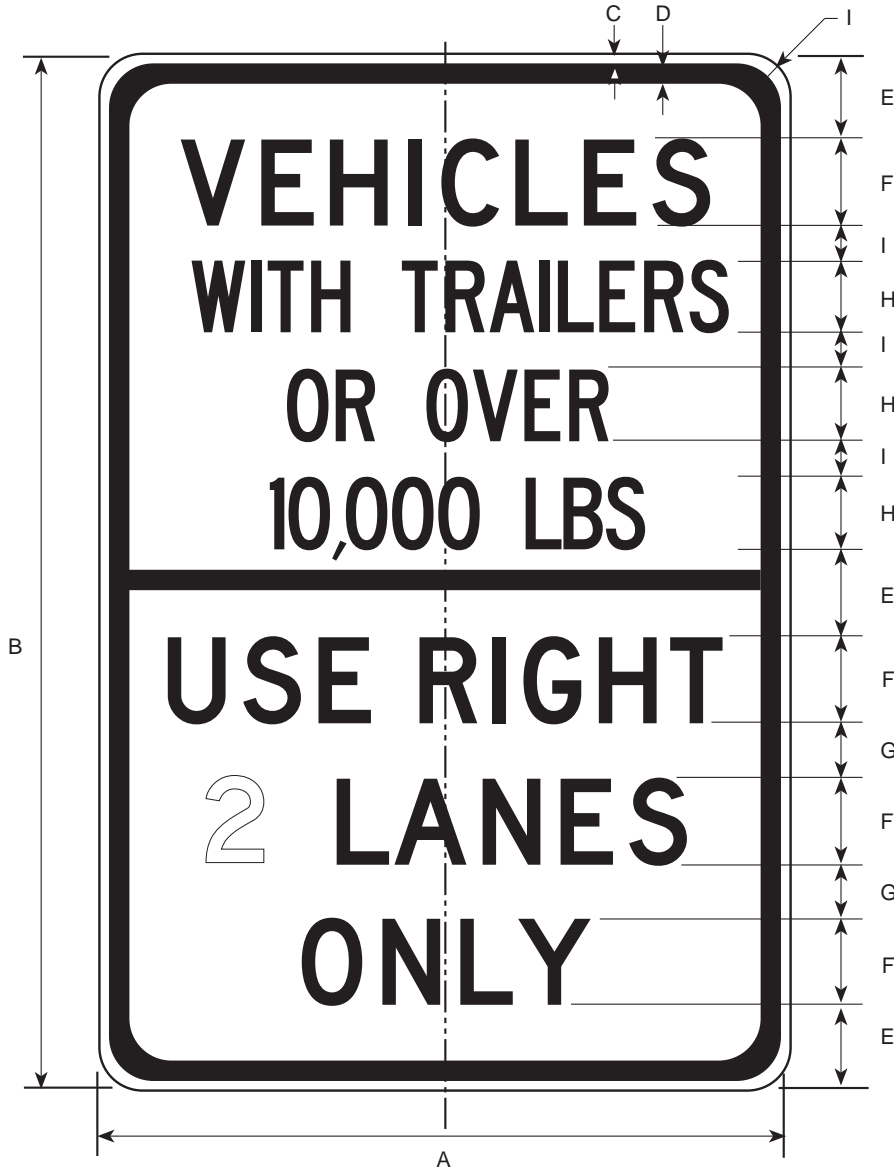

DIMENSIONS (MILLIMETERS)								
A	B	C	D	E	F	G	H	I
1200	1800	19	31	150D	100	125C	188	75

DIMENSIONS (INCHES)								
A	B	C	D	E	F	G	H	I
48	72	3/4	1 1/4	6D	4	5C	7 1/2	3

COLORS

LEGEND - BLACK (NON-REFL)
 BACKGROUND - WHITE (REFL)

R4-4

11/97



* See appendix for standard arrow details

DIMENSIONS (MILLIMETERS)											
A	B	C	D	E	F	G	H	J	K	L	M
900	750	13	19	88	100C	50	100B	225	81	250	47

DIMENSIONS (INCHES)											
A	B	C	D	E	F	G	H	J	K	L	M
36	30	1/2	3/4	3 1/2	4C	2	4B	9	3 1/4	10	1 7/8

COLORS

LEGEND - BLACK (NON-REFL)
BACKGROUND - WHITE (REFL)

R4-5

11/97

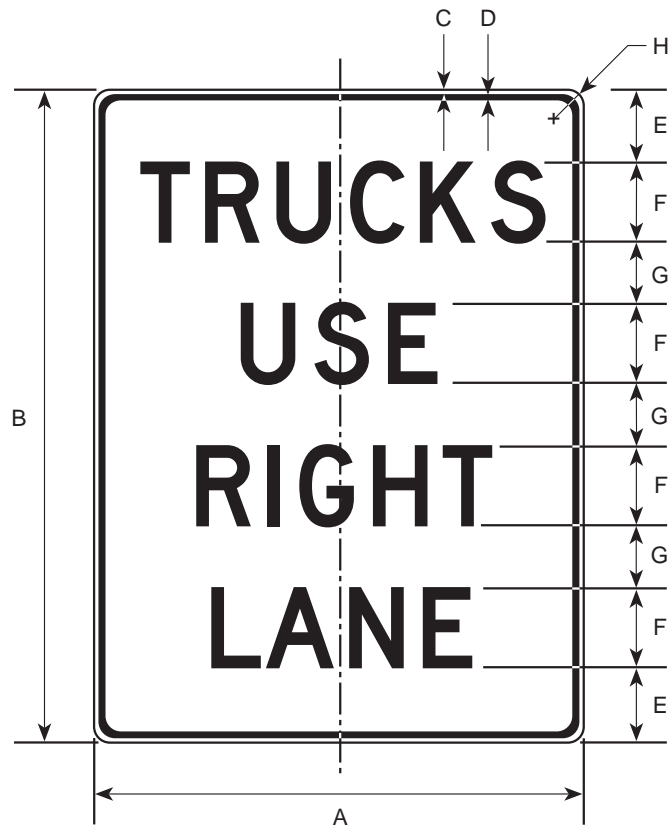

DIMENSIONS (MILLIMETERS)							
A	B	C	D	E	F	G	H
900	1200	16	22	150	150D	100	56
1200	1500	19	31	181	200D	113	75

DIMENSIONS (INCHES)							
A	B	C	D	E	F	G	H
36	48	5/8	7/8	6	6D	4	2 1/4
48	60	3/4	1 1/4	7 1/4	8D	4 1/2	3

COLORS

LEGEND - BLACK (NON-REFL)
 BACKGROUND - WHITE (REFL)

R4-6

11/97

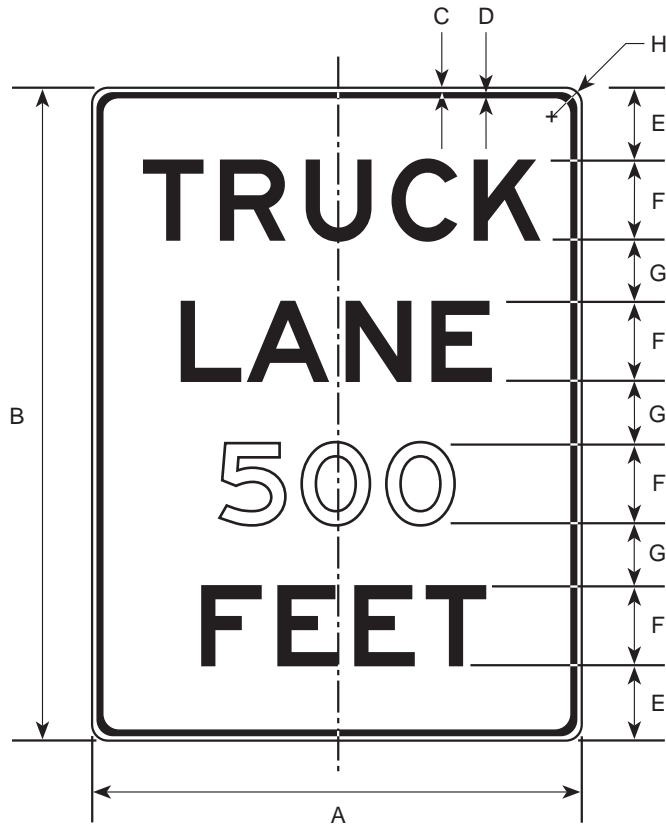

DIMENSIONS (MILLIMETERS)							
A	B	C	D	E	F	G	H
600	750	9	16	91	100E	56	38
900	1200	16	22	150	150E	100	56
1200	1500	19	31	181	200E	113	75

DIMENSIONS (INCHES)							
A	B	C	D	E	F	G	H
24	30	3/8	5/8	3 5/8	4E	2 1/4	1 1/2
36	48	5/8	7/8	6	6E	4	2 1/4
48	60	3/4	1 1/4	7 1/4	8E	4 1/2	3

COLORS

LEGEND - BLACK (NON-REFL)
 BACKGROUND - WHITE (REFL)

R4-601

11/97



DIMENSIONS (MILLIMETERS)								
A	B	C	D	E	F	G	H	J
1200	900	16	22	125	150E	100	200E	56

DIMENSIONS (INCHES)								
A	B	C	D	E	F	G	H	J
48	36	5/8	7/8	5	6E	4	8E	2 1/4

COLORS

LEGEND — BLACK (NON-REFL)
 BACKGROUND — WHITE (REFL)

R4-602

6/00

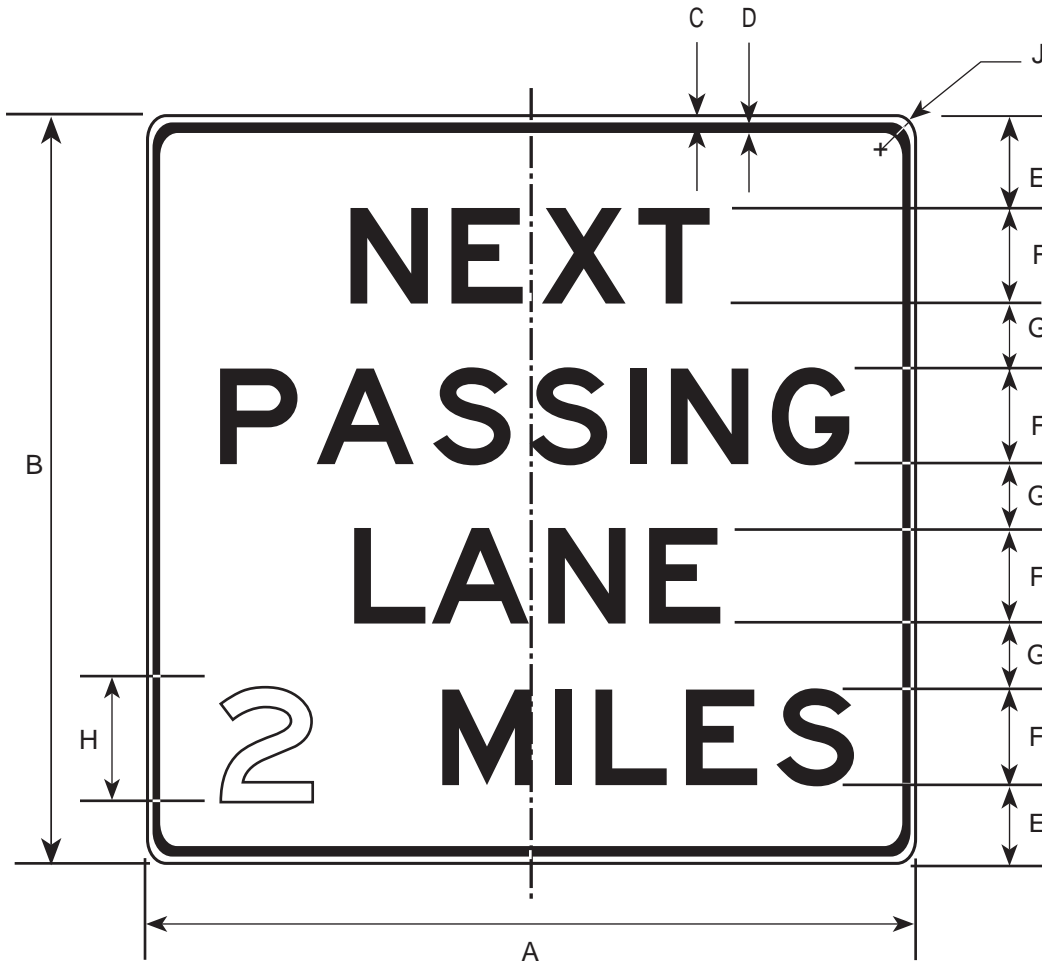

DIMENSIONS (MILLIMETERS)								
A	B	C	D	E	F	G	H	J
1200	1200	16	22	150	150E	100	200E	56

DIMENSIONS (INCHES)								
A	B	C	D	E	F	G	H	J
48	48	5/8	7/8	6	6E	4	8E	2 1/4

COLORS

LEGEND - 6 BLACK (NON-REFL)
 BACKGROUND - WHITE (REFL)

R4-604

6/00

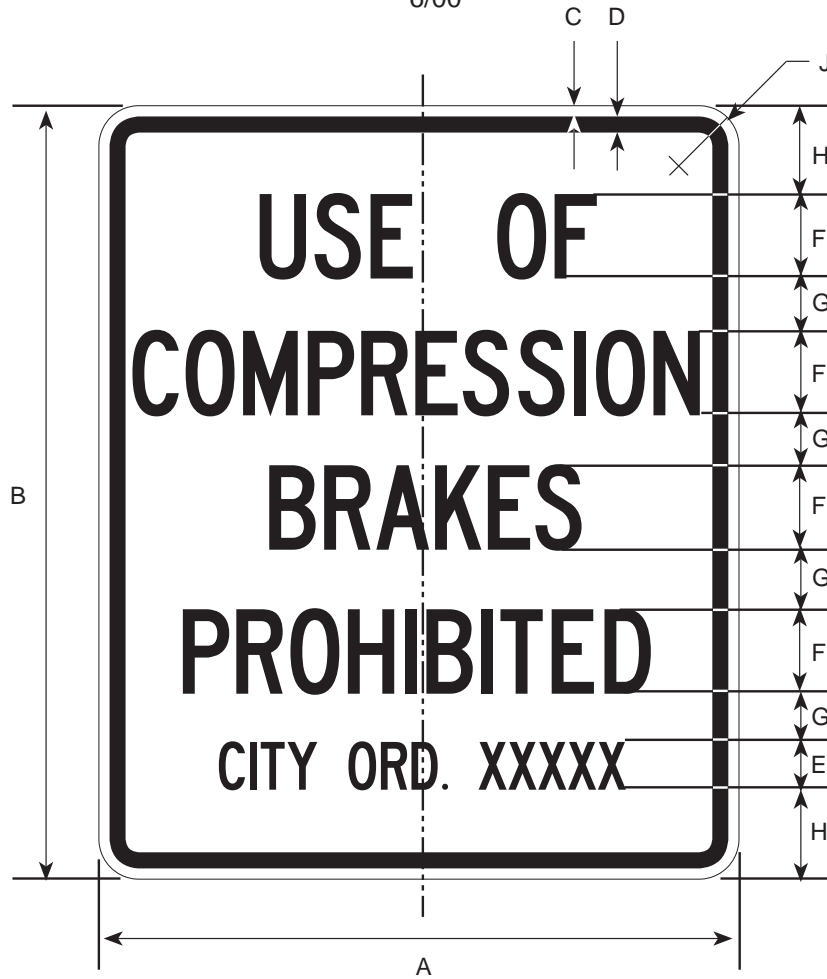

DIMENSIONS (MILLIMETERS)								
A	B	C	D	E	F	G	H	J
750	900	13	19	50C	100C	75	75	47
1200	1500	19	31	75C	150C	75	162.5	56

DIMENSIONS (INCHES)								
A	B	C	D	E	F	G	H	J
30	36	1/2	3/4	2C	4C	3	3	1 7/8
48	60	3/4	1 1/4	3C	6C	3	6 1/2	2 1/4

COLORS

LEGEND - BLACK (NON-REFL)
BACKGROUND - WHITE (REFL)

R4-605

6/00

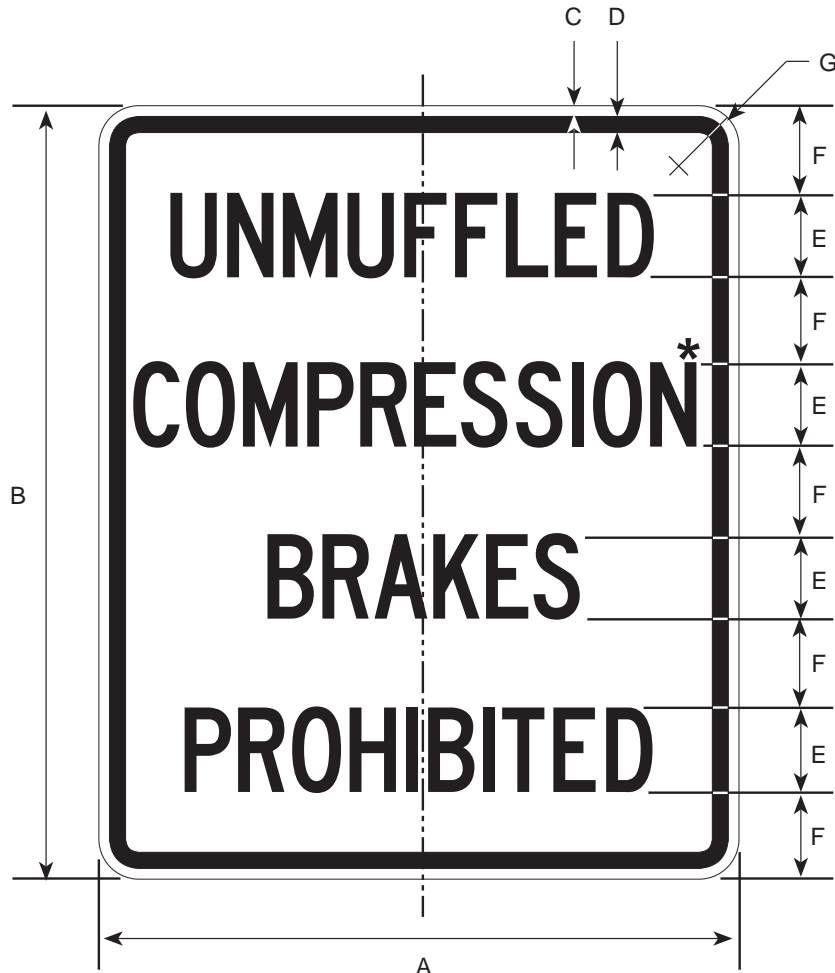

* Reduce spacing 40%.

DIMENSIONS (MILLIMETERS)						
A	B	C	D	E	F	G
750	900	13	19	100C	100	47
1200	1500	19	31	150C	150	56

DIMENSIONS (INCHES)						
A	B	C	D	E	F	G
30	36	1/2	3/4	4C	4	1 7/8
48	60	3/4	1 1/4	6C	6	2 1/4

COLORS

LEGEND - BLACK (NON-REFL)
BACKGROUND - WHITE (REFL)

R4-7

3/06

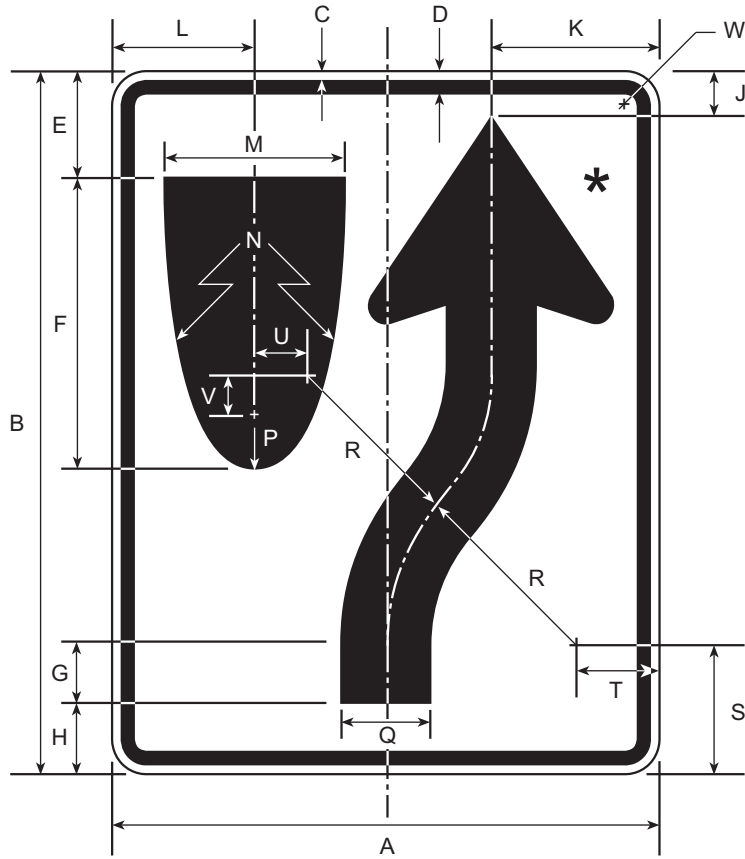

* SEE APPENDIX FOR STANDARD ARROW DETAILS

DIMENSIONS (MILLIMETERS)																				
A	B	C	D	E	F	G	H	J	K	L	M	N	P	Q	R	S	T	U	V	W
450	600	9	16	84	234	47	56	34	138	117	150	563	38	75	169	103	56	27	11	38
600	750	9	16	113	313	63	75	47	184	156	200	750	50	100	225	138	75	34	70	38
900	1200	16	22	169	469	94	113	70	278	234	300	1125	75	150	338	206	113	50	69	56
1200	1500	19	50	225	625	125	150	94	370	313	400	2700	100	200	450	275	150	67	125	75

DIMENSIONS (INCHES)																				
A	B	C	D	E	F	G	H	J	K	L	M	N	P	Q	R	S	T	U	V	W
18	24	3/8	5/8	3 3/8	9 3/8	1 7/8	2 1/4	1 3/8	5 1/2	4 11/16	6	22 1/2	1 1/2	3	6 3/4	4 1/8	2 1/4	1 1/16	7/16	1 1/2
24	30	3/8	5/8	4 1/2	12 1/2	2 1/2	3	1 7/8	7 3/8	6 1/4	8	30	2	4	9	5 1/2	3	1 3/8	2 13/16	1 1/2
36	48	5/8	7/8	6 3/4	18 3/4	3 3/4	4 1/2	2 13/16	11 1/8	9 3/8	12	45	3	6	13 1/2	8 1/4	4 1/2	2	2 3/4	2 1/4
48	60	3/4	1 1/4	9	25	5	6	3 3/4	14 13/16	12 1/2	16	60	4	8	18	11	6	2 11/16	5	3

COLORS

LEGEND — BLACK (NON-REFL)
BACKGROUND — WHITE (REFL)

R4-7A

11/97

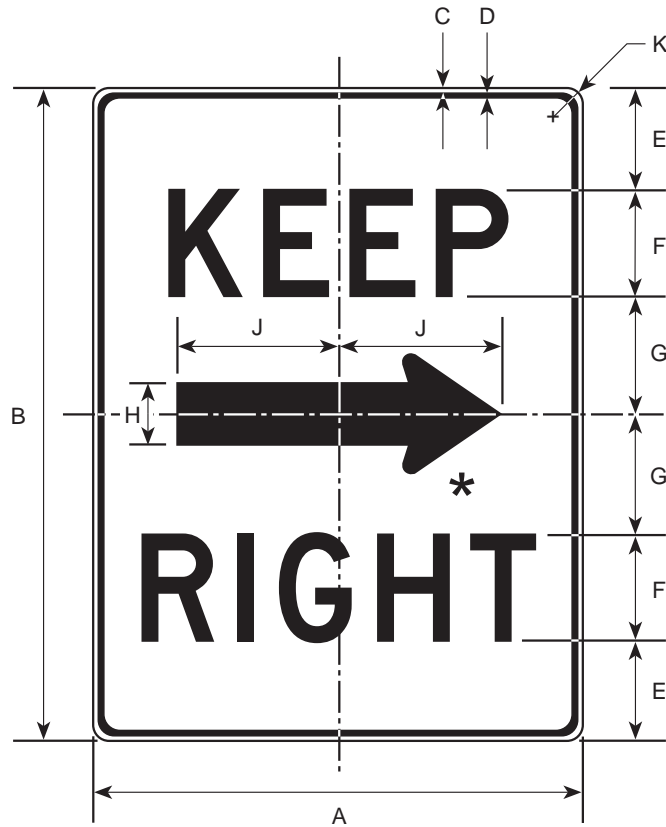

* See appendix for standard arrow details

DIMENSIONS (MILLIMETERS)									
A	B	C	D	E	F	G	H	J	K
450	600	9	16	94	100D	106	56	150	38
600	750	9	16	113	125D	138	66	178	38
900	1200	16	22	188	200D	213	113	288	56
1200	1500	19	31	225	250D	275	131	356	75

DIMENSIONS (INCHES)									
A	B	C	D	E	F	G	H	J	K
18	24	3/8	5/8	3 3/4	4D	4 1/4	2 1/4	6	1 1/2
24	30	3/8	5/8	4 1/2	5D	5 1/2	2 5/8	7 1/8	1 1/2
36	48	5/8	7/8	7 1/2	8D	8 1/2	4 1/2	11 1/2	2 1/4
48	60	3/4	1 1/4	9	10D	11	5 1/4	14 1/4	3

COLORS

LEGEND - BLACK (NON-REFL)
BACKGROUND - WHITE (REFL)

R4-7B

11/97

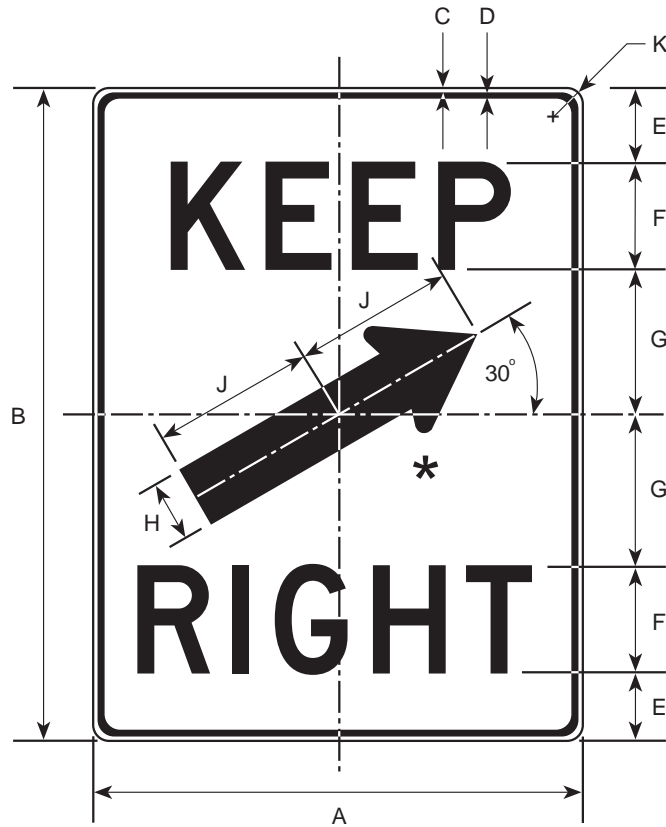

* See appendix for standard arrow details

DIMENSIONS (MILLIMETERS)									
A	B	C	D	E	F	G	H	J	K
450	600	9	16	63	100D	138	56	150	38
600	750	9	16	75	125D	175	66	178	38
900	1200	16	22	125	200D	275	113	288	56
1200	1500	19	31	150	250D	350	131	356	75

DIMENSIONS (INCHES)									
A	B	C	D	E	F	G	H	J	K
18	24	3/8	5/8	2 1/2	4D	5 1/2	2 1/4	6	1 1/2
24	30	3/8	5/8	3	5D	7	2 5/8	7 1/8	1 1/2
36	48	5/8	7/8	5	8D	11	4 1/2	11 1/2	2 1/4
48	60	3/4	1 1/4	6	10D	14	5 1/4	14 1/4	3

COLORS

LEGEND - BLACK (NON-REFL)
BACKGROUND - WHITE (REFL)

R4-8

11/97

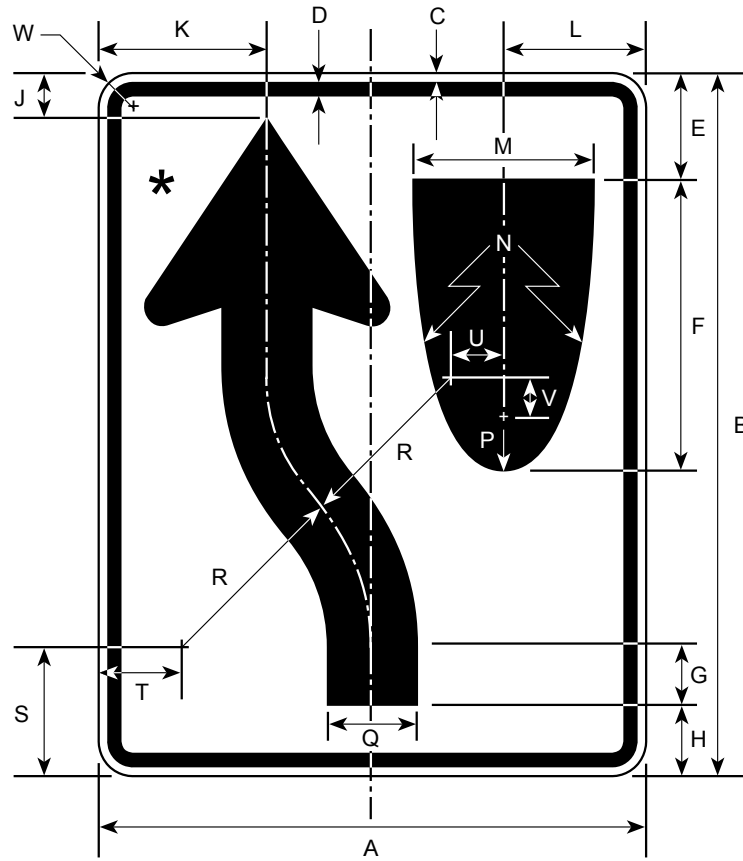

* See appendix for standards arrow details

DIMENSIONS (MILLIMETERS)																				
A	B	C	D	E	F	G	H	J	K	L	M	N	P	Q	R	S	T	U	V	W
450	600	9	16	84	234	47	56	34	138	117	150	563	38	75	169	103	56	27	11	38
600	750	9	16	113	313	63	75	47	184	156	200	750	50	100	225	138	75	34	70	38
900	1200	16	22	169	469	86	113	70	278	234	300	1125	75	150	338	206	113	50	69	56
1200	2700	19	50	225	625	125	150	94	370	313	400	2700	100	200	450	275	150	67	125	75

DIMENSIONS (INCHES)																				
A	B	C	D	E	F	G	H	J	K	L	M	N	P	Q	R	S	T	U	V	W
18	24	3/8	5/8	3 3/8	9 3/8	1 7/8	2 1/4	1 3/8	5 1/2	4 11/16	6	22 1/2	1 1/2	3	6 3/4	4 1/8	2 1/4	1 1/16	7/16	1 1/2
24	30	3/8	5/8	4 1/2	12 1/2	2 1/2	3	1 7/8	7 3/8	6 1/4	8	30	2	4	9	5 1/2	3	1 3/8	2 13/16	1 1/2
36	48	5/8	7/8	6 3/4	18 3/4	3 3/4	4 1/2	2 13/16	11 1/8	9 3/8	12	45	3	6	13 1/2	8 1/4	4 1/2	2	2 3/4	2 1/4
48	60	3/4	1 1/4	9	25	5	6	3 3/4	14 13/16	12 1/2	16	60	4	8	18	11	6	2 11/16	5	3

COLORS

LEGEND — BLACK (NON-REFL)
BACKGROUND — WHITE (REFL)

R4-9

6/03

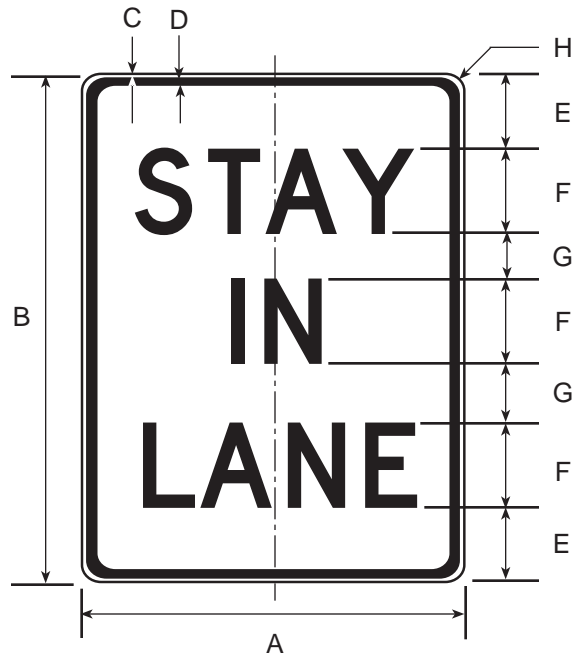

DIMENSIONS (MILLIMETERS)							
A	B	C	D	E	F	G	H
450	600	9	16	75	100D	75	38
600	750	9	16	92	125D	95	38
900	1200	16	22	206	175D	131	56
1200	1500	19	31	188	250D	188	75

DIMENSIONS (INCHES)							
A	B	C	D	E	F	G	H
18	24	3/8	5/8	3	4D	3	1 1/2
24	30	3/8	5/8	3 11/16	5D	3 13/16	1 1/2
36	48	5/8	7/8	5 1/4	7D	5 1/4	2 1/4
48	60	3/4	1 1/4	7 1/2	10D	7 1/2	3

COLORS
 LEGEND - BLACK
 BACKGROUND - WHITE (REFL)

R4-901

11/97



DIMENSIONS (MILLIMETERS)								
A	B	C	D	E	F	G	H	J
600	750	9	16	78	125E	56	100D	38
900	1200	16	22	138	175E	100	150D	56
1200	1500	19	31	169	225E	113	200D	75

DIMENSIONS (INCHES)								
A	B	C	D	E	F	G	H	J
24	30	3/8	5/8	3 1/8	5E	2 1/4	4D	1 1/2
36	48	5/8	7/8	5 1/2	7E	4	6D	2 1/4
48	60	3/4	1 1/4	6 3/4	9E	4 1/2	8D	3

COLORS

LEGEND — BLACK (NON-REFL)
 BACKGROUND — WHITE (REFL)

R4-10

3/06

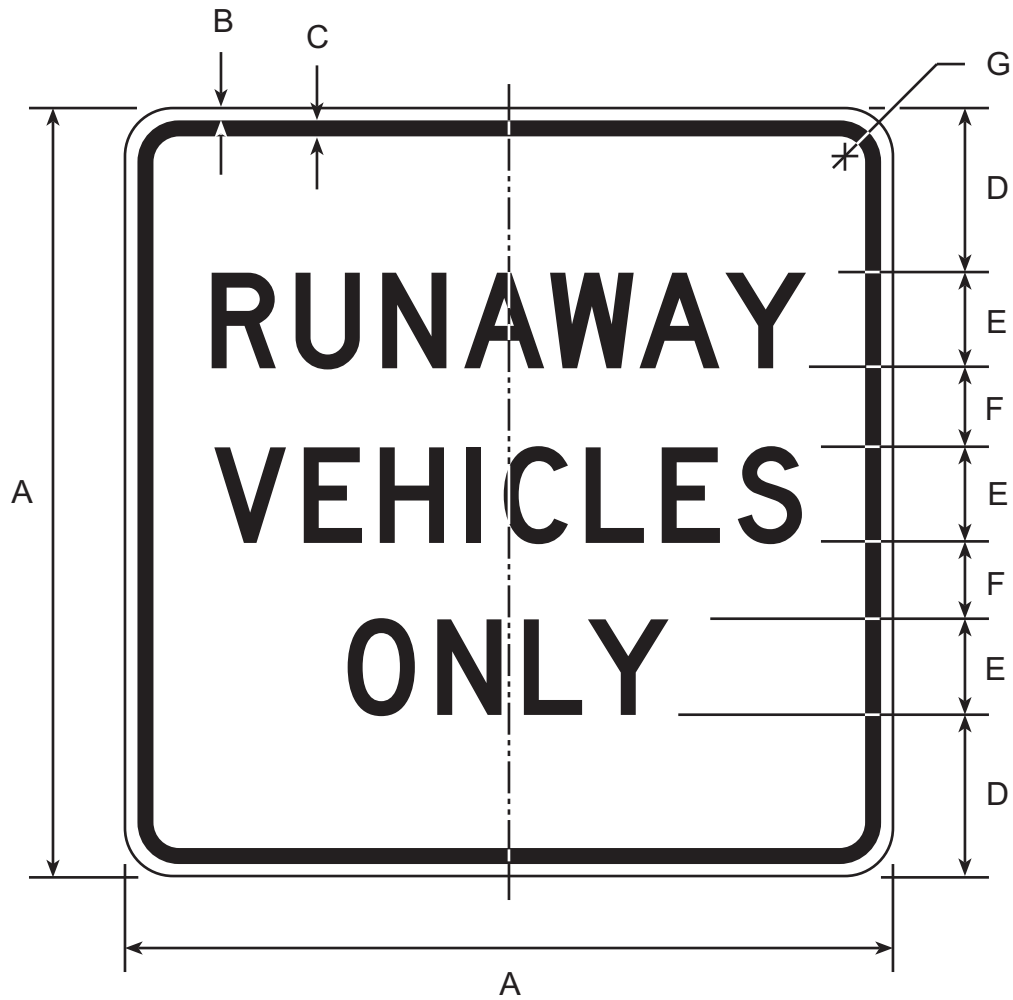

DIMENSIONS (MILLIMETERS)						
A	B	C	D	E	F	G
1200	19	31	250	150D	125	75

DIMENSIONS (INCHES)						
A	B	C	D	E	F	G
48	3/4	1 1/4	10	6D	5	3

COLORS

LEGEND - BLACK (NON-REFL)
BACKGROUND - WHITE (REFL)

R5-1

11/97

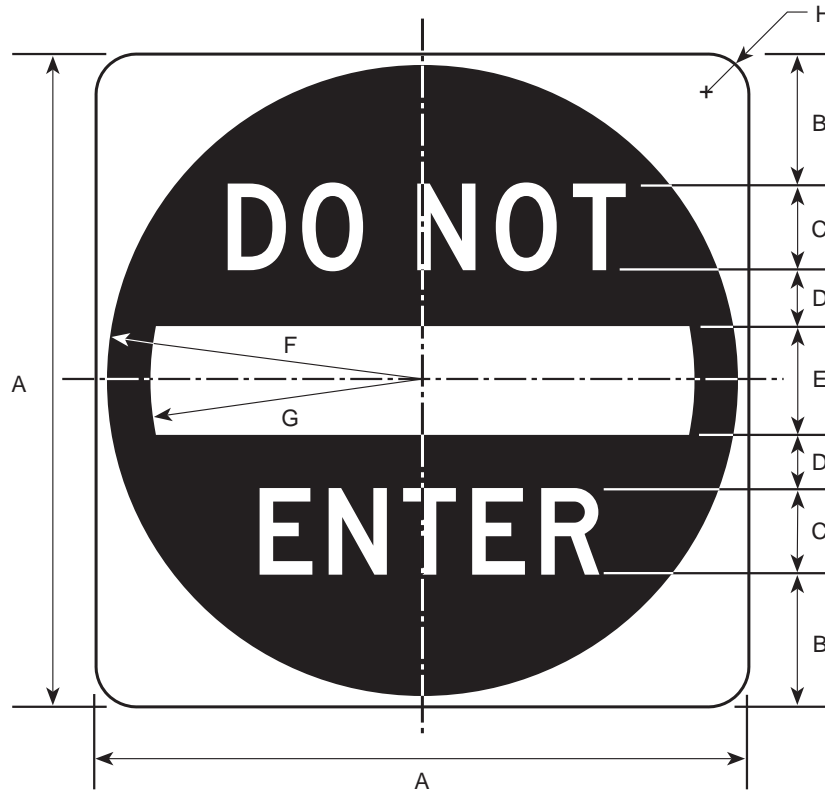

DIMENSIONS (MILLIMETERS)							
A	B	C	D	E	F	G	H
750	163	100D	50	125	363	313	47
900	188	125D	63	150	438	375	56
1200	275	150D	75	200	588	500	75

DIMENSIONS (INCHES)							
A	B	C	D	E	F	G	H
30	6 1/2	4D	2	5	14 1/2	12 1/2	1 7/8
36	7 1/2	5D	2 1/2	6	17 1/2	15	2 1/4
48	11	6D	3	8	23 1/2	20	3

COLORS

SYMBOL - RED (REFL)
 LEGEND & BACKGROUND - WHITE (REFL)

R5-1A

11/97

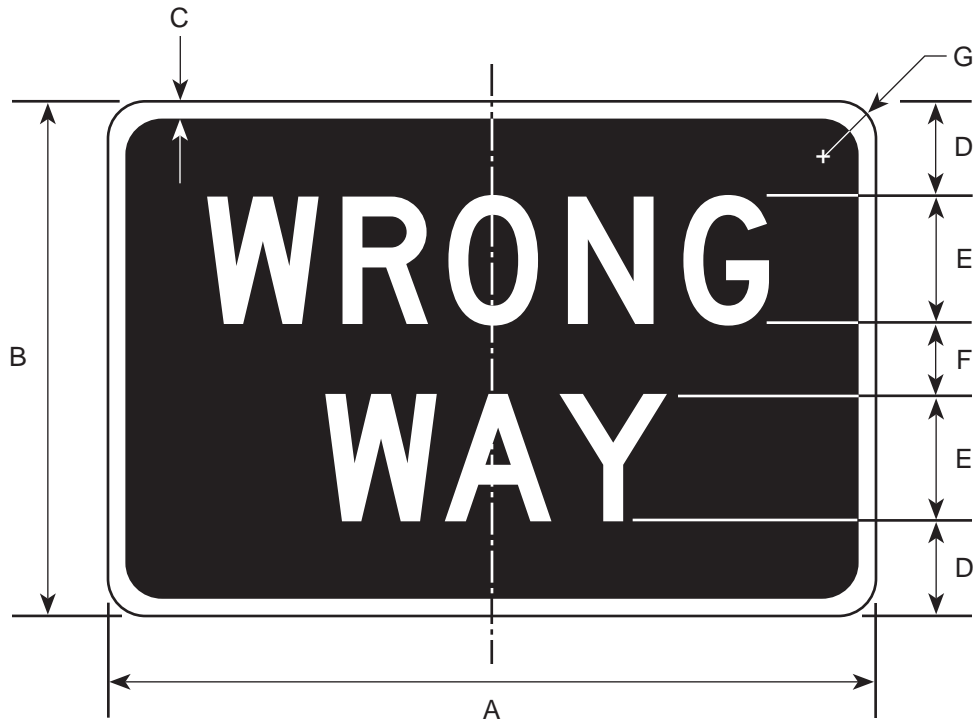

DIMENSIONS (MILLIMETERS)						
A	B	C	D	E	F	G
750	450	16	75	125D	50	38
900	600	19	113	150D	75	38
1050	750	22	125	200D	100	47

DIMENSIONS (INCHES)						
A	B	C	D	E	F	G
30	18	5/8	3	5D	2	1 1/2
36	24	3/4	4 1/2	6D	3	1 1/2
42	30	7/8	5	8D	4	1 7/8

COLORS

LEGEND - WHITE (REFL)
BACKGROUND - RED (REFL)

R5-1B

3/06

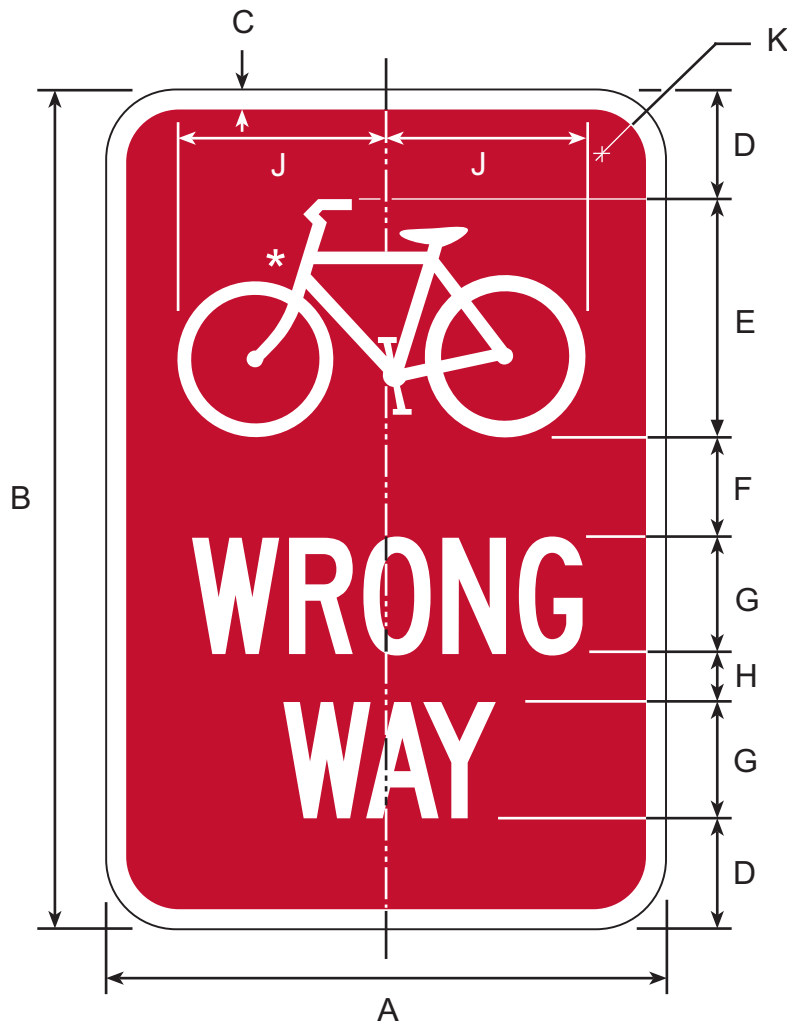

* SEE APPENDIX FOR STANDARD SYMBOL DETAILS

DIMENSIONS (MILLIMETERS)									
A	B	C	D	E	F	G	H	J	K
300	450	9	63	125	50	63C	25	108	38

DIMENSIONS (INCHES)									
A	B	C	D	E	F	G	H	J	K
12	18	3/8	2 1/2	5	2	2 1/2C	1	4 5/16	1 1/2

COLORS

LEGEND & SYMBOL - WHITE (REFL)
BACKGROUND - RED (REFL)

R5-2

11/97

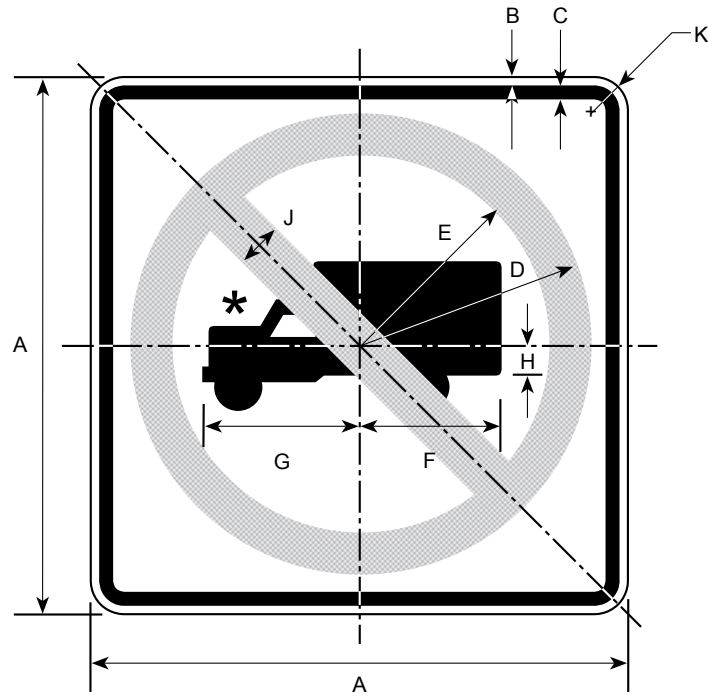

* See appendix for standard symbol details

DIMENSIONS (MILLIMETERS)									
A	B	C	D	E	F	G	H	J	K
600	9	16	263	213	163	172	34	25	38
750	13	19	328	266	203	213	41	63	47
900	16	22	394	319	244	256	50	75	56
1200	19	31	525	425	325	341	66	100	75

DIMENSIONS (INCHES)									
A	B	C	D	E	F	G	H	J	K
24	3/8	5/8	10 1/2	8 1/2	6 1/2	6 7/8	1 3/8	1	1 1/2
30	1/2	3/4	13 1/8	10 5/8	8 1/8	8 1/2	1 5/8	2 1/2	1 7/8
36	5/8	7/8	15 3/4	12 3/4	9 3/4	10 1/4	2	3	2 1/4
48	3/4	1 1/4	21	17	13	13 5/8	2 5/8	4	3

COLORS

CIRCLE & DIAGONAL — RED (REFL)
 SYMBOL & BORDER — BLACK (NON-REFL)
 BACKGROUND — WHITE (REFL)

R5-3

11/97

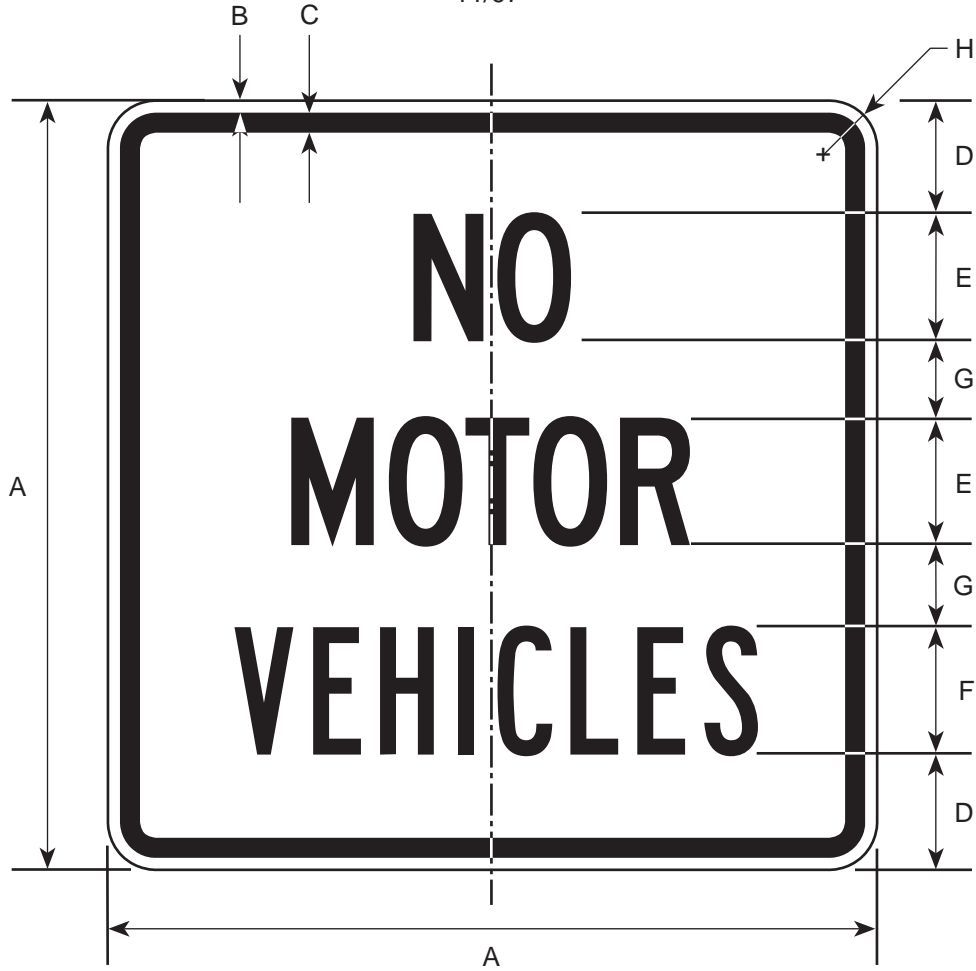

DIMENSIONS (MILLIMETERS)							
A	B	C	D	E	F	G	H
600	9	16	88	100C	100B	63	38

DIMENSIONS (INCHES)							
A	B	C	D	E	F	G	H
24	3/8	5/8	3 1/2	4C	4B	2 1/2	1 1/2

COLORS

LEGEND - BLACK (NON-REFL)
BACKGROUND - WHITE (REFL)

R5-4

11/97

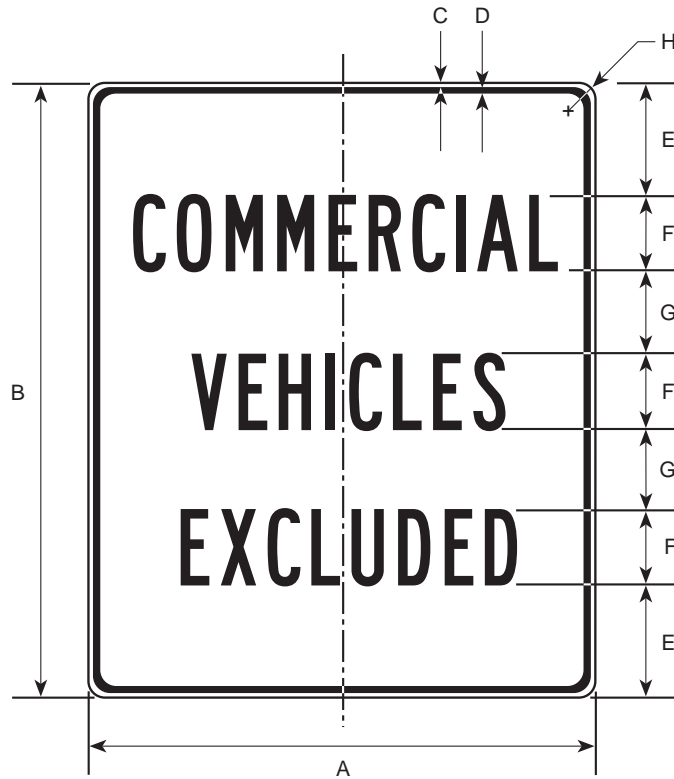

DIMENSIONS (MILLIMETERS)							
A	B	C	D	E	F	G	H
450	600	9	16	106	75B	81	38
600	750	9	16	125	100B	100	38
900	1200	16	22	213	150B	163	56
1200	1500	19	31	250	200B	200	75

DIMENSIONS (INCHES)							
A	B	C	D	E	F	G	H
18	24	3/8	5/8	4 1/4	3B	3 1/4	1 1/2
24	30	3/8	5/8	5	4B	4	1 1/2
36	48	5/8	7/8	8 1/2	6B	6 1/2	2 1/4
48	60	3/4	1 1/4	10	8B	8	3

COLORS

LEGEND - BLACK (NON-REFL)
BACKGROUND - WHITE (REFL)

R5-5

11/97

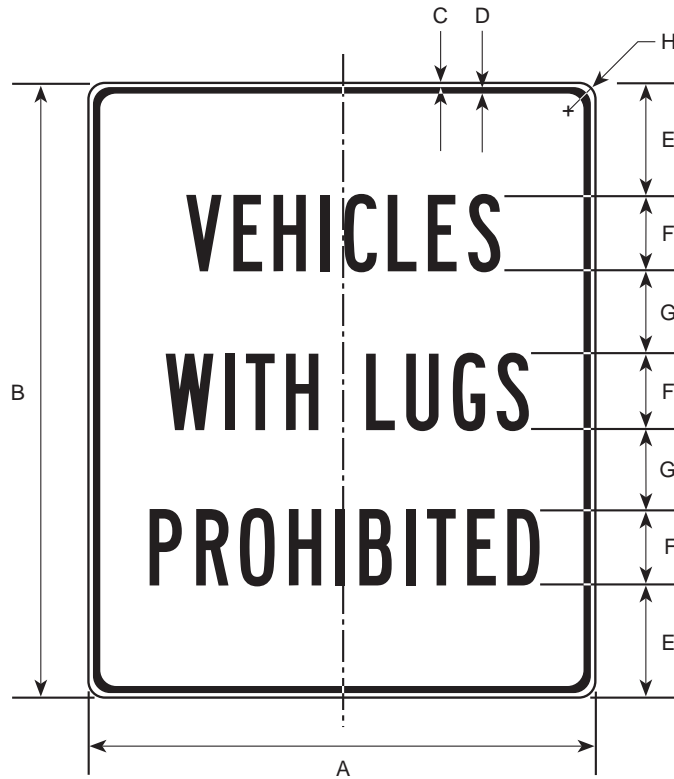

DIMENSIONS (MILLIMETERS)							
A	B	C	D	E	F	G	H
450	600	9	16	106	75B	81	38
600	750	9	16	125	100B	100	38
900	1200	16	22	213	150B	163	56
1200	1500	19	31	250	200B	200	75

DIMENSIONS (INCHES)							
A	B	C	D	E	F	G	H
18	24	3/8	5/8	4 1/4	3B	3 1/4	1 1/2
24	30	3/8	5/8	5	4B	4	1 1/2
36	48	5/8	7/8	8 1/2	6B	6 1/2	2 1/4
48	60	3/4	1 1/4	10	8B	8	3

COLORS

LEGEND - BLACK (NON-REFL)
 BACKGROUND - WHITE (REFL)

R5-6

11/97

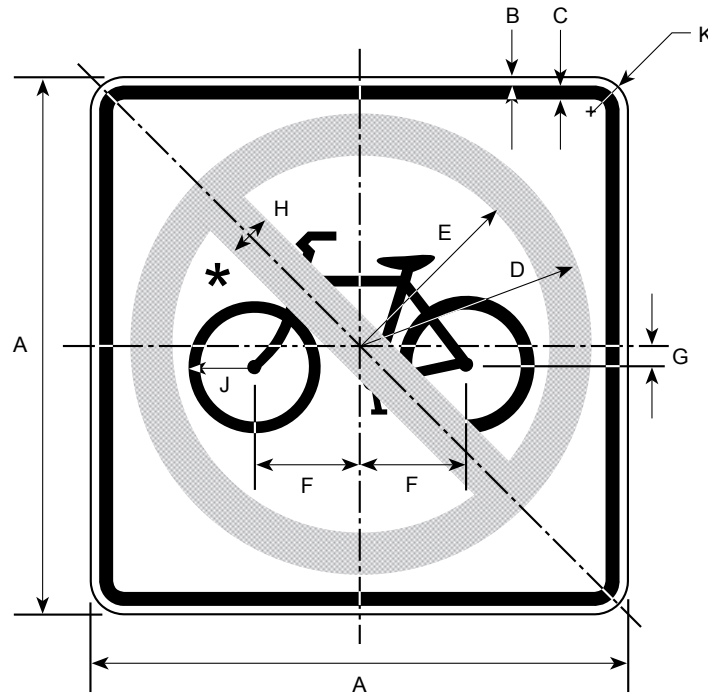

* See appendix for standard symbol details

DIMENSIONS (MILLIMETERS)									
A	B	C	D	E	F	G	H	J	K
600	9	16	263	213	119	19	50	75	38
750	13	19	328	266	147	22	63	94	47
900	16	22	394	319	178	28	75	113	56
1200	19	31	525	425	238	38	100	150	75

DIMENSIONS (INCHES)									
A	B	C	D	E	F	G	H	J	K
24	3/8	5/8	10 1/2	8 1/2	4 3/4	3/4	2	3	1 1/2
30	1/2	3/4	13 1/8	10 5/8	5 7/8	7/8	2 1/2	3 3/4	1 7/8
36	5/8	7/8	15 3/4	12 3/4	7 1/8	1 1/8	3	4 1/2	2 1/4
48	3/4	1 1/4	21	17	9 1/2	1 1/2	4	6	3

COLORS

- CIRCLE & DIAGONAL — RED (REFL)
- SYMBOL & BORDER — BLACK (NON-REFL)
- BACKGROUND — WHITE (REFL)

R5-601

11/97



- * See appendix for standard symbol details
 - ** Centerline of alternative message or arrow
- NOTE: Use 3"C letters or 12"x 6" arrow for alternatives

DIMENSIONS (MILLIMETERS)								
A	B	C	D	E	F	G	H	J
600	9	16	66	200	75C	34	88	38

DIMENSIONS (INCHES)								
A	B	C	D	E	F	G	H	J
24	3/8	5/8	2 5/8	8	3C	1 3/8	3 1/2	1 1/2

COLORS

- SYMBOL & LEGEND - BLACK (NON-REFL)
- BACKGROUND - WHITE (REFL)

R5-602

11/03

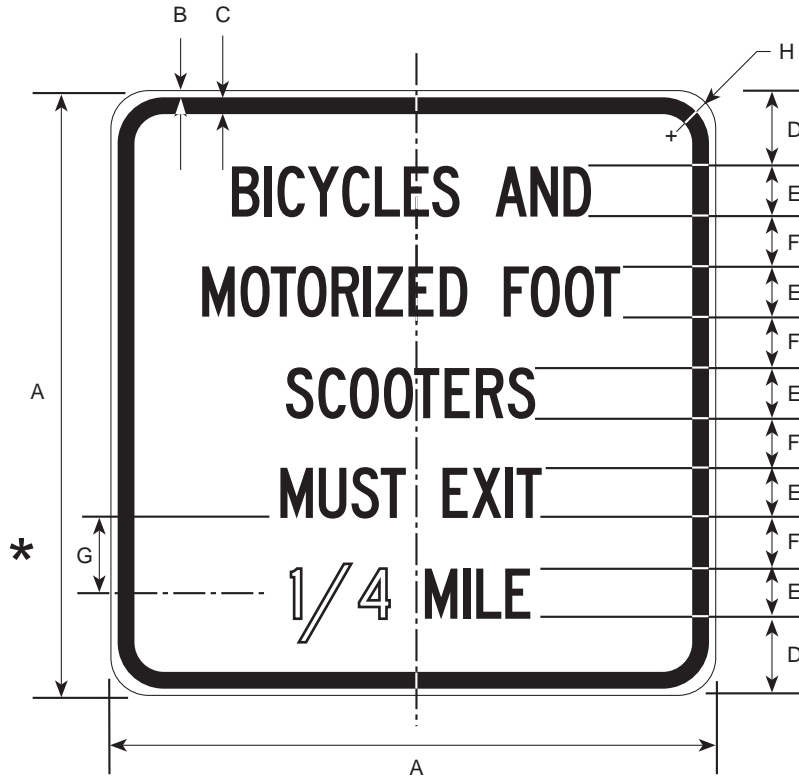

* Centerline of alternative message or arrow
 NOTE: Use 2"C letters or 12"x 6" arrow for alternatives

DIMENSIONS (MILLIMETERS)							
A	B	C	D	E	F	G	H
600	9	16	75	50C	50	75	38

DIMENSIONS (INCHES)							
A	B	C	D	E	F	G	H
24	3/8	5/8	3	2C	2	3	1 1/2

COLORS

LEGEND - BLACK (NON-REFL)
 BACKGROUND - WHITE (REFL)

R5-10A

11/97



DIMENSIONS (MILLIMETERS)							
A	B	C	D	E	F	G	H
750	900	13	19	100	100B	50	47

DIMENSIONS (INCHES)							
A	B	C	D	E	F	G	H
30	36	1/2	3/4	4	4B	2	1 7/8

COLORS

LEGEND - BLACK (NON-REFL)
 BACKGROUND - WHITE (REFL)

R5-10B

11/97



DIMENSIONS (MILLIMETERS)							
A	B	C	D	E	F	G	H
750	450	9	16	75	75C	38	38

DIMENSIONS (INCHES)							
A	B	C	D	E	F	G	H
30	18	3/8	5/8	3	3C	1 1/2	1 1/2

COLORS

LEGEND - BLACK (NON-REFL)
 BACKGROUND - WHITE (REFL)

R5-10C

11/97



DIMENSIONS (MILLIMETERS)							
A	B	C	D	E	F	G	H
600	300	9	16	56	75C	38	38

DIMENSIONS (INCHES)							
A	B	C	D	E	F	G	H
24	12	3/8	5/8	2 1/4	3C	1 1/2	1 1/2

COLORS

LEGEND - BLACK (NON-REFL)
BACKGROUND - WHITE (REFL)

R5-1001

11/97



DIMENSIONS (MILLIMETERS)							
A	B	C	D	E	F	G	H
450	300	9	16	50	50C	25	38

DIMENSIONS (INCHES)							
A	B	C	D	E	F	G	H
18	12	3/8	5/8	2	2C	1	1 1/2

COLORS

LEGEND - BLACK (NON-REFL)
BACKGROUND - WHITE (REFL)

R5-1002

11/97

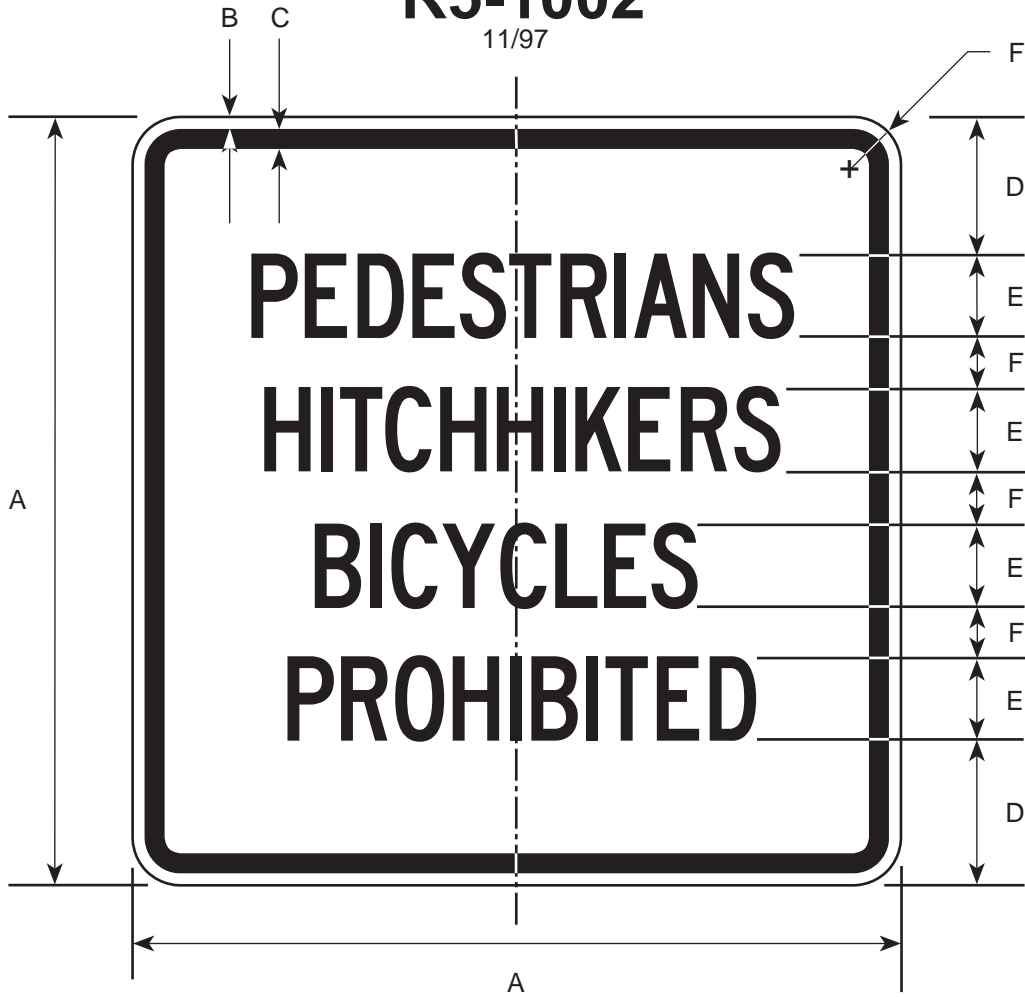

DIMENSIONS (MILLIMETERS)					
A	B	C	D	E	F
450	9	16	69	50C	38

DIMENSIONS (INCHES)					
A	B	C	D	E	F
18	3/8	5/8	2 3/4	2C	1 1/2

COLORS

LEGEND - BLACK (NON-REFL)
BACKGROUND - WHITE (REFL)

R5-1003

10/03

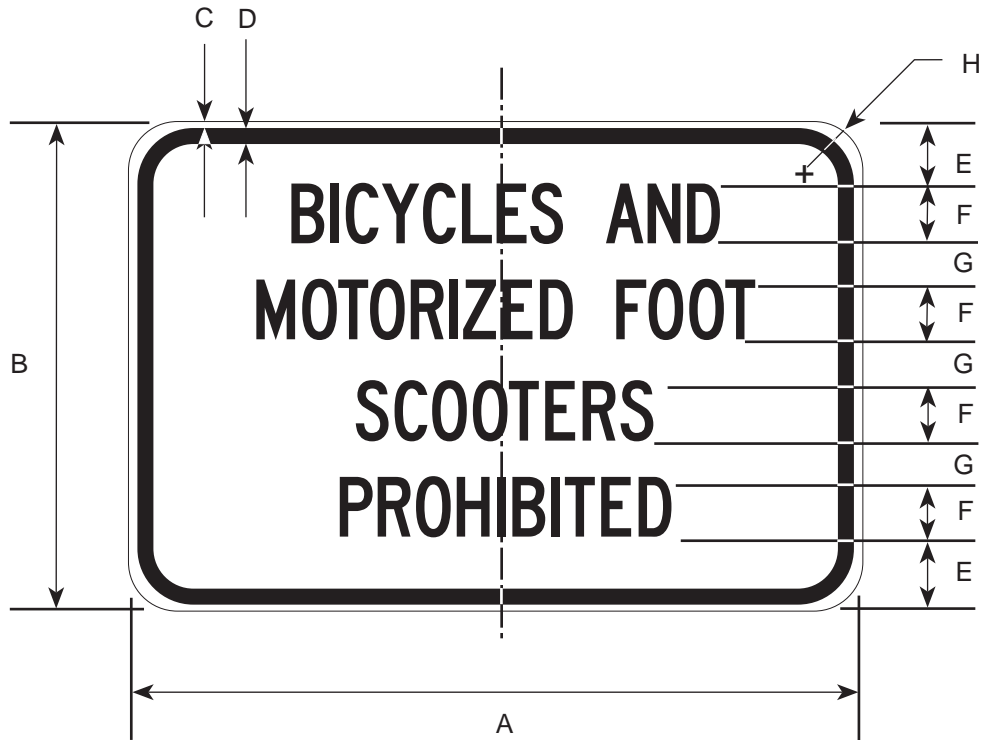

DIMENSIONS (MILLIMETERS)							
A	B	C	D	E	F	G	H
900	600	13	19	75	75C	50	38

DIMENSIONS (INCHES)							
A	B	C	D	E	F	G	H
36	24	1/2	3/4	3	3C	2	1 1/2

COLORS

LEGEND - BLACK (NON-REFL)
 BACKGROUND - WHITE (REFL)

R5-1004

11/03

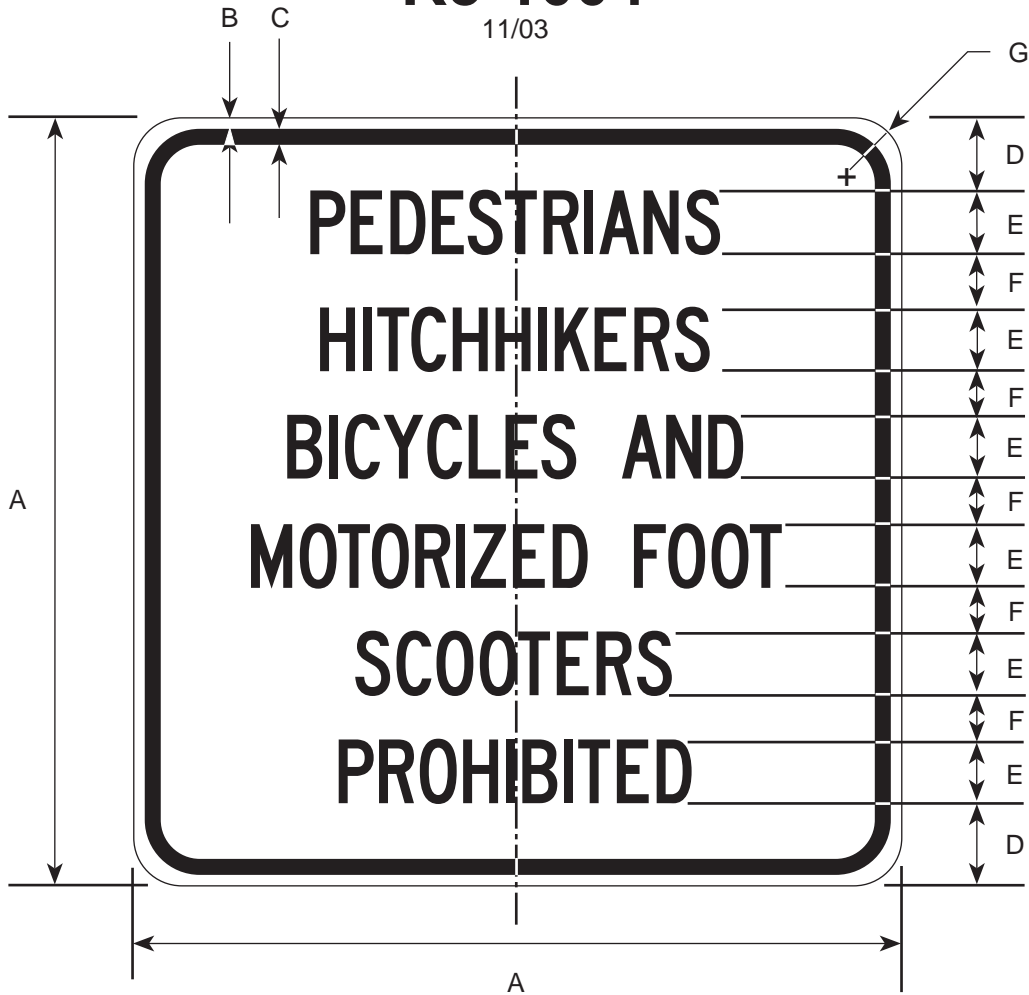

DIMENSIONS (MILLIMETERS)						
A	B	C	D	E	F	G
600	9	16	64	50C	34	38

DIMENSIONS (INCHES)						
A	B	C	D	E	F	G
24	3/8	5/8	2 9/16	2C	1 3/8	1 1/2

COLORS

LEGEND - BLACK (NON-REFL)
BACKGROUND - WHITE (REFL)

R5-1201

11/97

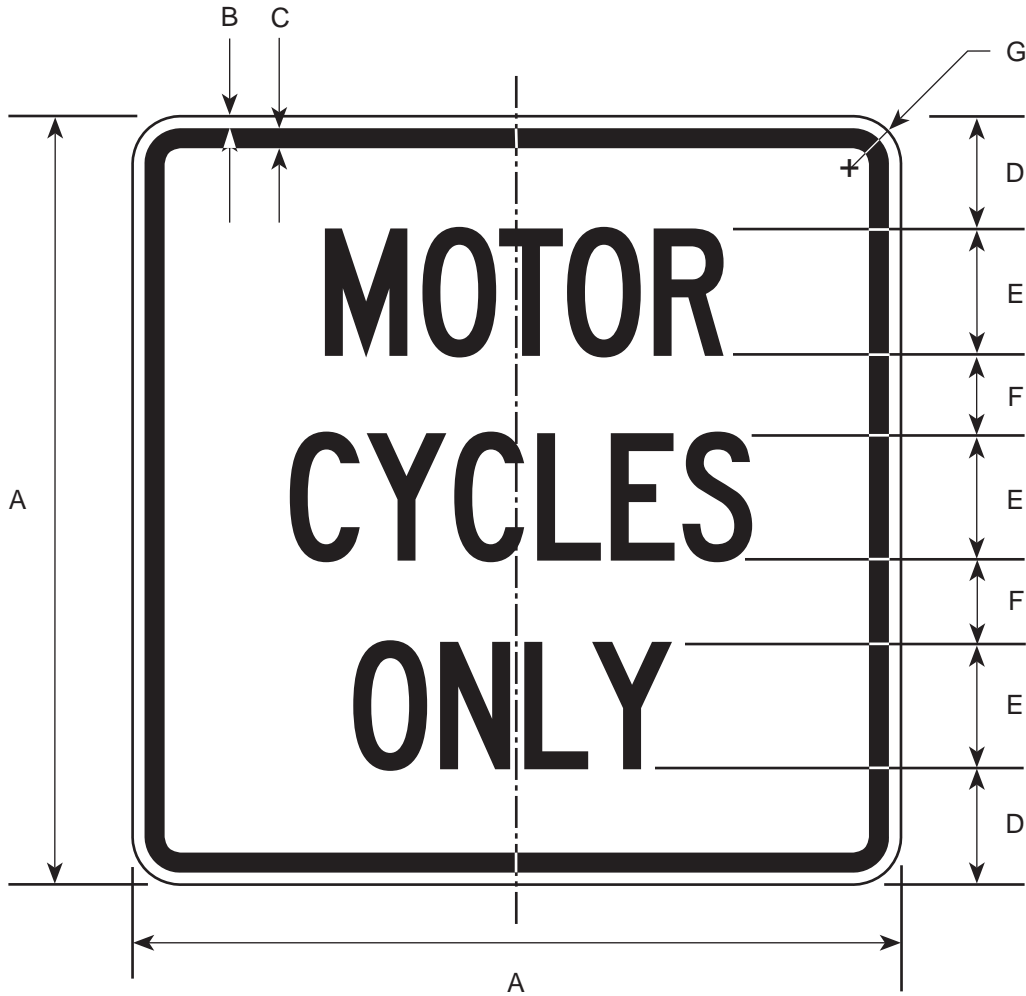

DIMENSIONS (MILLIMETERS)						
A	B	C	D	E	F	G
450	9	16	66	75C	47	38

DIMENSIONS (INCHES)						
A	B	C	D	E	F	G
18	3/8	5/8	2 5/8	3C	1 7/8	1 1/2

COLORS

LEGEND - BLACK (NON-REFL)
 BACKGROUND - WHITE (REFL)

R5-1301

11/97

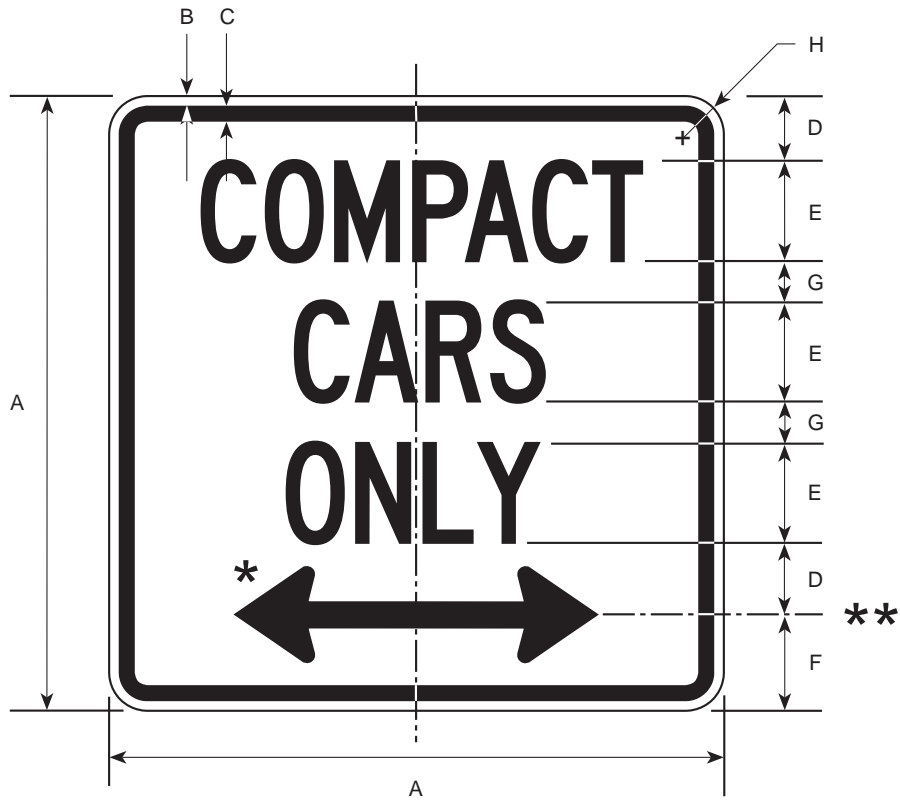

- * See appendix for standard arrow details
 - ** Centerline of 2" wide arrow
- NOTE: Designate Left, Right, or Both

DIMENSIONS (MILLIMETERS)							
A	B	C	D	E	F	G	H
450	9	16	50	75C	75	25	38

DIMENSIONS (INCHES)							
A	B	C	D	E	F	G	H
18	3/8	5/8	2	3C	3	1	1 1/2

COLORS

LEGEND - BLACK (NON-REFL)
 BACKGROUND - WHITE (REFL)

R6-1 L / R

5/06

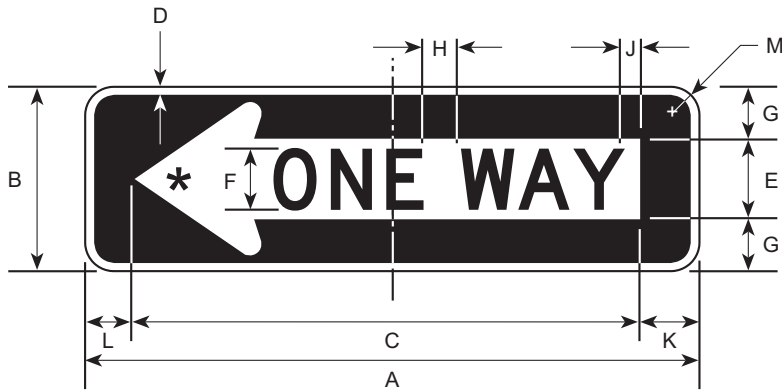

R6-1L

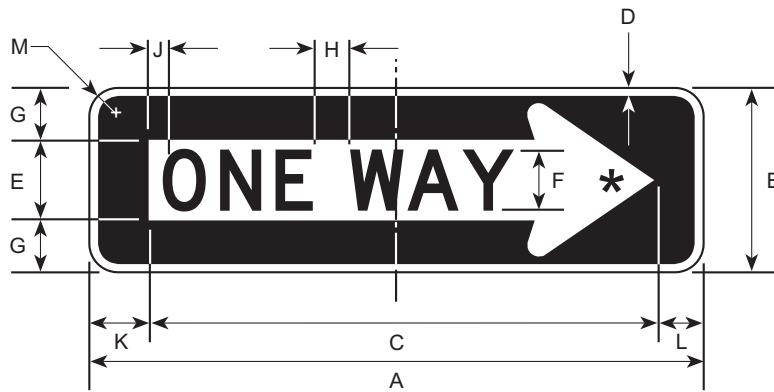

R6-1R

* See appendix for standard arrow details

DIMENSIONS (MILLIMETERS)											
A	B	C	D	E	F	G	H	J	K	L	M
900	300	775	13	131	100D	84	50	31	75	50	38
1350	450	1125	25	175	125D	138	75	100	125	100	47

DIMENSIONS (INCHES)											
A	B	C	D	E	F	G	H	J	K	L	M
36	12	31	1/2	5 1/4	4D	3 3/8	2	1 1/4	3	2	1 1/2
54	18	45	1	3	5D	5 1/2	3	4	5	4	1 7/8

COLORS

LEGEND — BLACK (NON-REFL)
 ARROW & BORDER — WHITE (REFL)
 BACKGROUND — BLACK (NON-REFL)

R6-2 L / R

11/97



* See appendix for standard arrow details
NOTE: Right shown only

DIMENSIONS (MILLIMETERS)												
A	B	C	D	E	F	G	H	J	K	L	M	N
450	600	9	16	63	125D	38	113	138	56	150	147	38
600	750	9	16	75	150D	47	152	177	75	200	194	38

DIMENSIONS (INCHES)												
A	B	C	D	E	F	G	H	J	K	L	M	N
18	24	3/8	5/8	2 1/2	5D	1 1/2	4 1/2	5 1/2	2 1/4	6	5 7/8	1 1/2
24	30	3/8	5/8	3	6D	1 7/8	6 1/16	7 1/16	3	8	7 3/4	1 1/2

COLORS

LEGEND — BLACK (NON-REFL)
BACKGROUND — WHITE (REFL)

R6-3

11/97

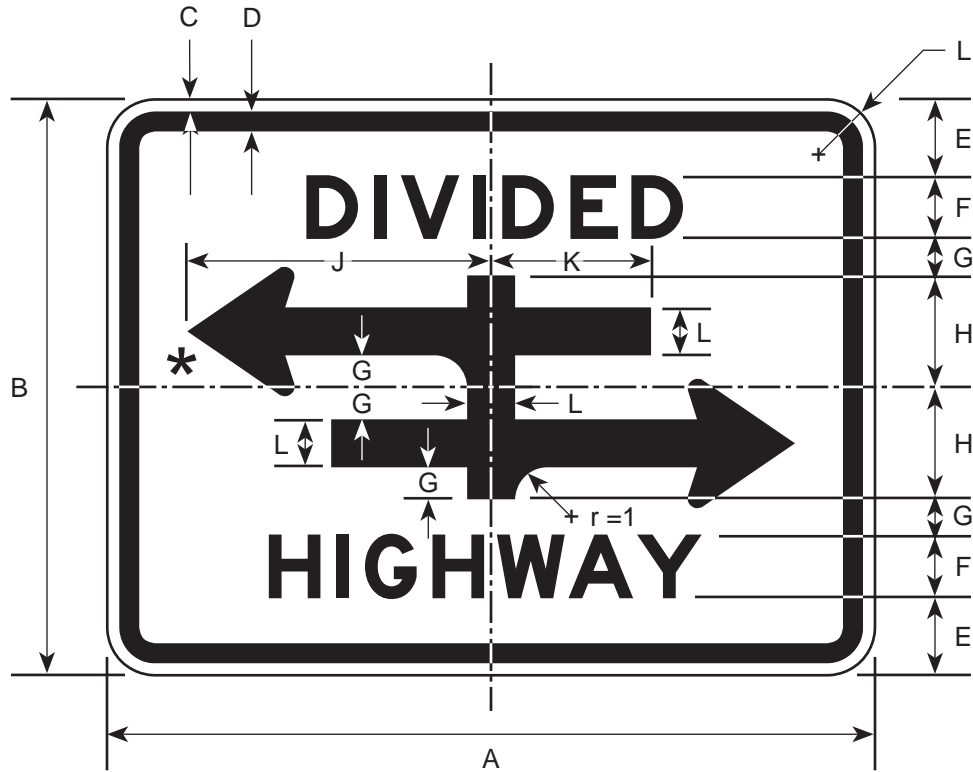

* See appendix for standard arrow details

DIMENSIONS (MILLIMETERS)										
A	B	C	D	E	F	G	H	J	K	L
600	450	9	16	63	50E	25	88	238	125	38

DIMENSIONS (INCHES)										
A	B	C	D	E	F	G	H	J	K	L
24	18	3/8	5/8	2 1/2	2E	1	3 1/2	9 1/2	5	1 1/2

COLORS

LEGEND - BLACK (NON-REFL)
 BACKGROUND - WHITE (REFL)

R6-3A

11/97

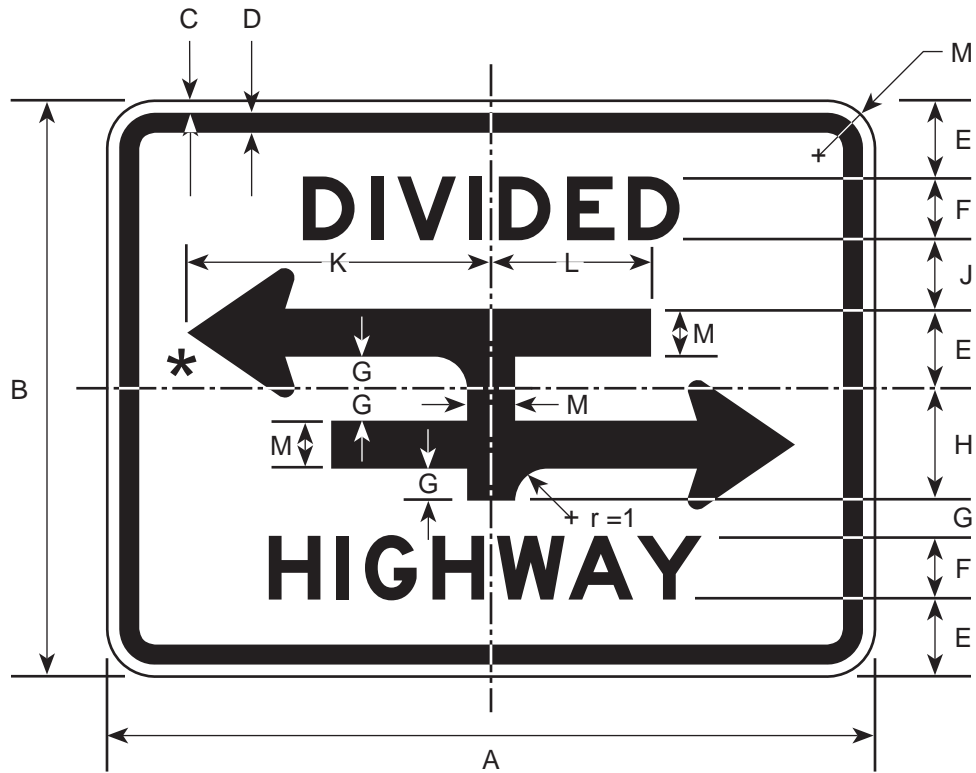

* See appendix for standard arrow details

DIMENSIONS (MILLIMETERS)											
A	B	C	D	E	F	G	H	J	K	L	M
600	450	9	16	63	50E	25	88	50	238	125	38

DIMENSIONS (INCHES)											
A	B	C	D	E	F	G	H	J	K	L	M
24	18	3/8	5/8	2 1/2	2E	1	3 1/2	2	9 1/2	5	1 1/2

COLORS

LEGEND - BLACK (NON-REFL)
BACKGROUND - WHITE (REFL)

R7-1 & R7-101

11/97

R7-1

R7-101



* SEE APPENDIX FOR STANDARD ARROW DETAILS
DESIGNATE LEFT, RIGHT, OR BOTH

DIMENSIONS (MILLIMETERS)				
A	B	C	D	E
300	450	50C	75B	75C

DIMENSIONS (INCHES)				
A	B	C	D	E
12	18	2C	3B	3C

COLORS

LEGEND - RED
BACKGROUND - WHITE (REFL)

R7-102

11/97



DESIGNATE LEFT, RIGHT, OR BOTH

DIMENSIONS (MILLIMETERS)				
A	B	C	D	E
300	450	75C	50B	75B

DIMENSIONS (INCHES)				
A	B	C	D	E
12	18	3C	2B	3B

TOP LEFT
 COLORS: LEGEND - WHITE
 BACKGROUND - RED

TOP RIGHT & BOTTOM
 LEGEND - RED
 BACKGROUND - WHITE

R7-107

11/97

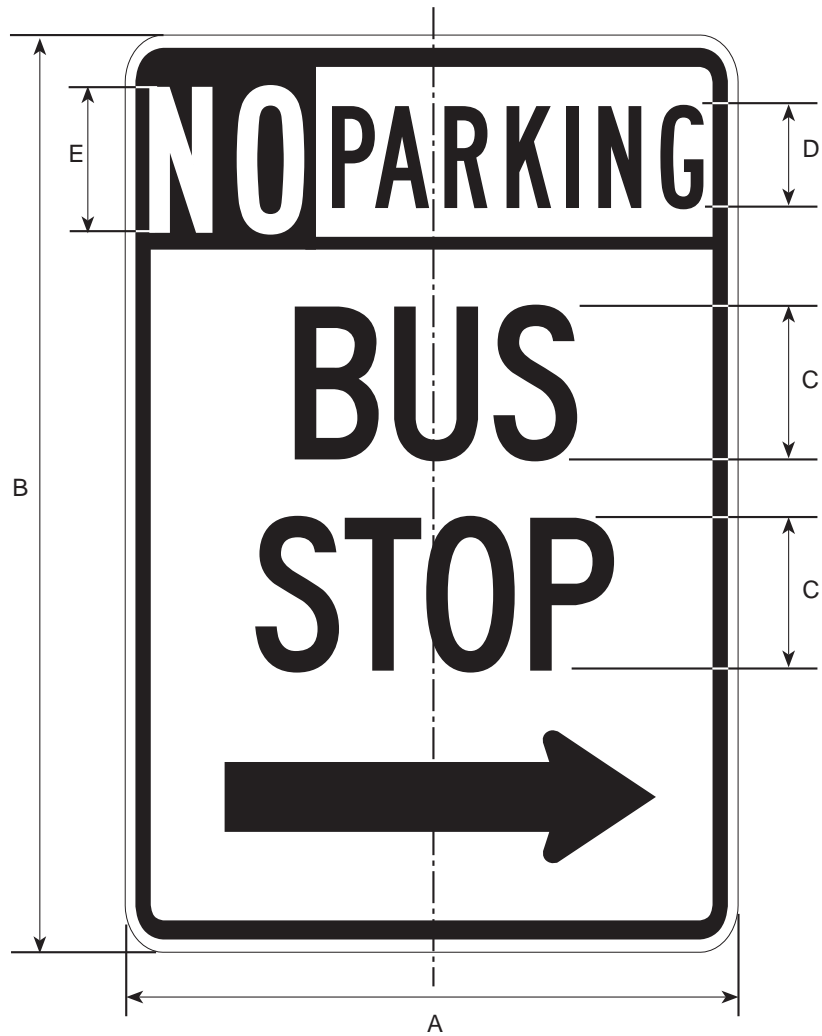

DIMENSIONS (MILLIMETERS)				
A	B	C	D	E
300	450	75C	50B	75C

DIMENSIONS (INCHES)				
A	B	C	D	E
12	18	3C	2B	3C

TOP
 COLORS: LEGEND - WHITE
 BACKGROUND - RED

TOP RIGHT & BOTTOM
 LEGEND - RED
 BACKGROUND - WHITE

R7-107A

11/97

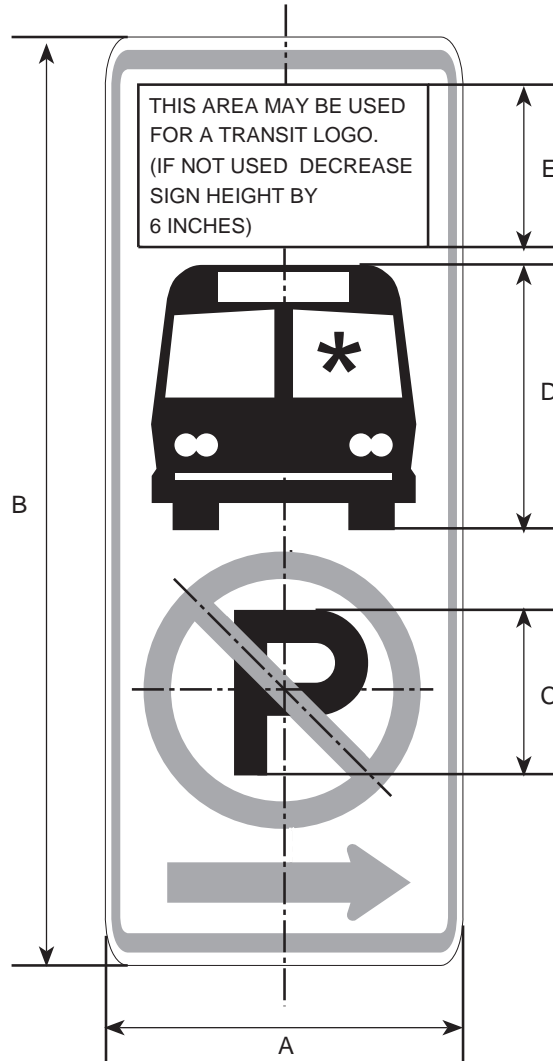

* SEE APPENDIX FOR SYMBOL DESIGN

DIMENSIONS (MILLIMETERS)				
A	B	C	D	E
300	750	150E(M)	200	128

DIMENSIONS (INCHES)				
A	B	C	D	E
12	30	6E(M)	8	5 1/8

COLORS

LEGEND, BORDER, CIRCLE, DIAGONAL, ARROW - RED
 BACKGROUND - WHITE
 TRANSIT LOGO, BUS SYMBOL - BLACK (PREFERABLE)
 LETTER P - BLACK

R7-108

11/97

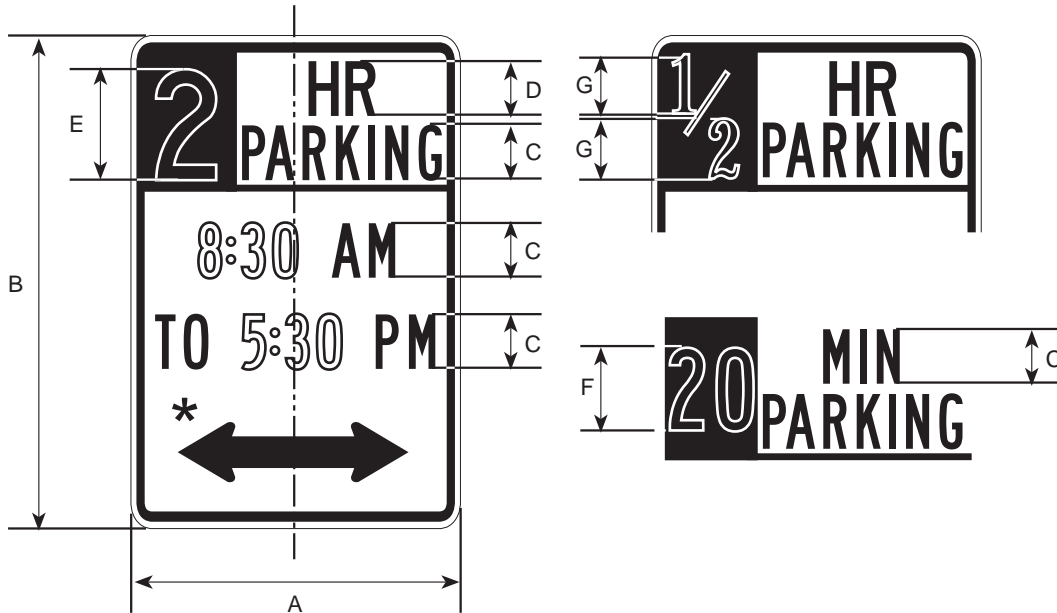

* SEE APPENDIX FOR STANDARD ARROW DETAILS

DIMENSIONS (MILLIMETERS)						
A	B	C	D	E	F	G
300	450	50B	50C	100C	75B	50D

DIMENSIONS (INCHES)						
A	B	C	D	E	F	G
12	18	2B	2C	4C	3B	2D

COLORS

TOP LEFT
 LEGEND - WHITE
 BACKGROUND - GREEN

TOP RIGHT & BOTTOM
 LEGEND - GREEN
 BACKGROUND - WHITE

R7-2 & R7-2A

11/97

R7-2



R7-2A

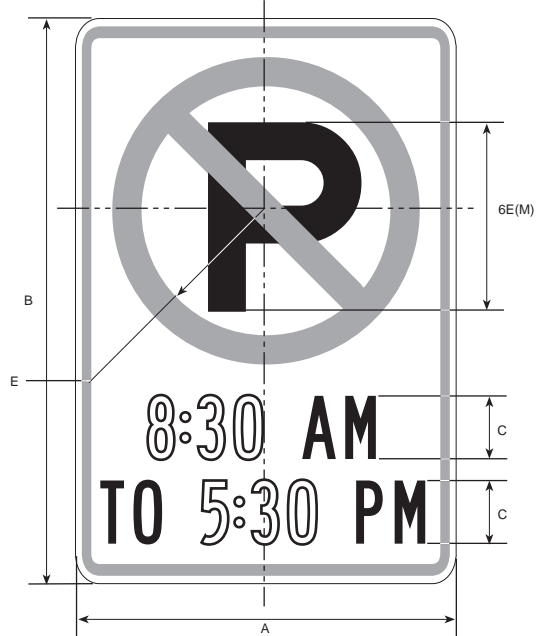

* SEE APPENDIX FOR STANDARD ARROW DETAILS, DESIGNATE LEFT, RIGHT, OR BOTH

DIMENSIONS (MILLIMETERS)				
A	B	C	D	E
300	450	50B	75B	75C

DIMENSIONS (INCHES)				
A	B	C	D	E
12	18	2B	3B	3C

COLORS

LEGEND - RED
BACKGROUND - WHITE (REFL)

DIMENSIONS (MILLIMETERS)				
A	B	C	D	E
300	450	50B	150E(M)	97

DIMENSIONS (INCHES)				
A	B	C	D	E
12	18	2B	6E(M)	3 7/8

COLORS

CIRCLE, DIAGONAL, LEGEND,
BORDER - RED
BACKGROUND - WHITE
"P" - BLACK

R7-201 & R7-201A

11/97

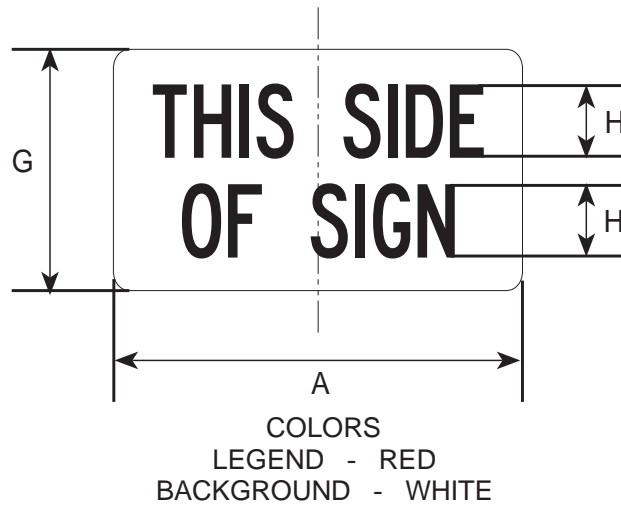
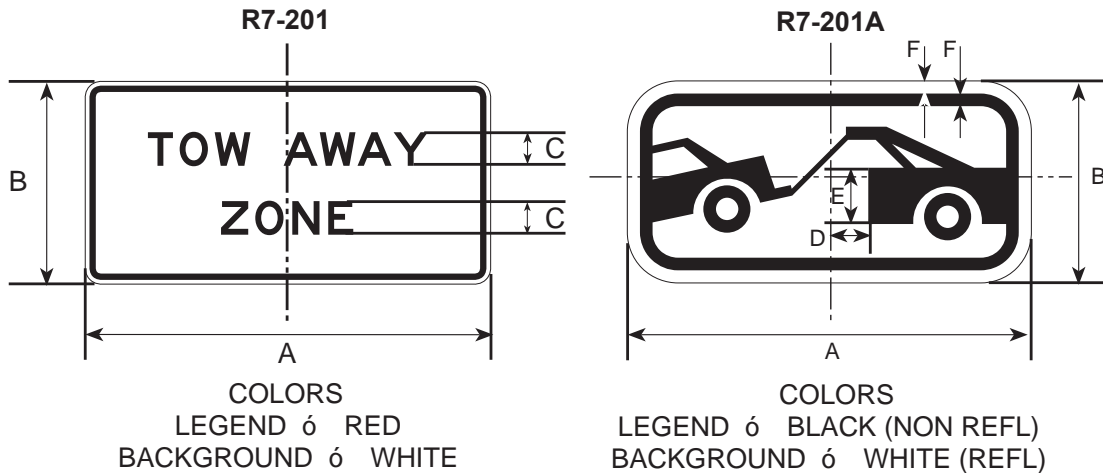

DIMENSIONS (MILLIMETERS)							
A	B	C	D	E	F	G	H
300	150	25E	28	31	10	163	50C

DIMENSIONS (INCHES)							
A	B	C	D	E	F	G	H
12	6	1E	1 1/8	1 1/4	3/8	6 1/2	2C

R7-202

11/97



DIMENSIONS (MILLIMETERS)				
A	B	C	D	E
300	450	50B	75B	75C

DIMENSIONS (INCHES)				
A	B	C	D	E
12	18	2B	3B	3C

COLORS

LEGEND - RED
 BACKGROUND - WHITE (REFL)

R7-203

3/06



DIMENSIONS (MILLIMETERS)											
A	B	C	D	E	F	G	H	J	K	L	M
450	600	9	16	243	56	50D	44	88	50C	75	38
600	750	9	16	300	69	63D	56	119	63C	81	38

DIMENSIONS (INCHES)											
A	B	C	D	E	F	G	H	J	K	L	M
18	24	3/8	5/8	9 3/4	2 1/4	2D	1 3/4	3 1/2	2C	3	1 1/2
24	30	3/8	5/8	12	2 3/4	2 1/2D	2 1/4	4 3/4	2 1/2C	3 1/4	1 1/2

COLORS

- TOP LEGEND - WHITE (REFL)
- TOP BACKGROUND - RED (REFL)
- BOTTOM LEGEND - RED (REFL)
- BOTTOM BACKGROUND - WHITE (REFL)

R7-3

11/97



*See appendix for standard arrow details
Designate left, right, or both.

DIMENSIONS (MILLIMETERS)				
A	B	C	D	E
300	450	25C	75B	75C

DIMENSIONS (INCHES)				
A	B	C	D	E
12	18	1C	3B	3C

COLORS

LEGEND - RED
BACKGROUND - WHITE (REFL)

R7-301

11/97



DIMENSIONS (MILLIMETERS)				
A	B	C	D	E
300	450	50C	75B	75C

DIMENSIONS (INCHES)				
A	B	C	D	E
12	18	2C	3B	3C

COLORS

LEGEND - RED
BACKGROUND - WHITE (REFL)

R7-4

11/97

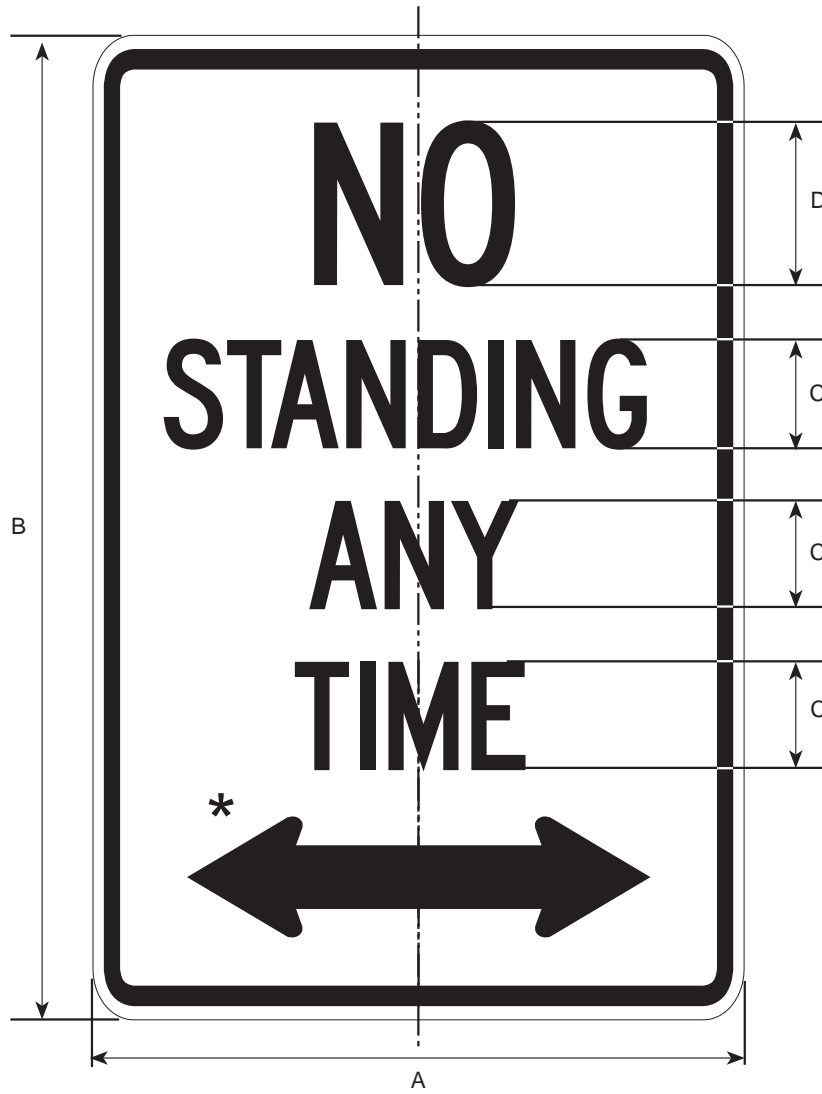

*See appendix for standard arrow details
Designate left, right, or both.

DIMENSIONS (MILLIMETERS)			
A	B	C	D
300	450	50C	75C

DIMENSIONS (INCHES)			
A	B	C	D
12	18	2C	3C

COLORS

LEGEND - RED
BACKGROUND - WHITE (REFL)

R7-401 & R7-402

11/97

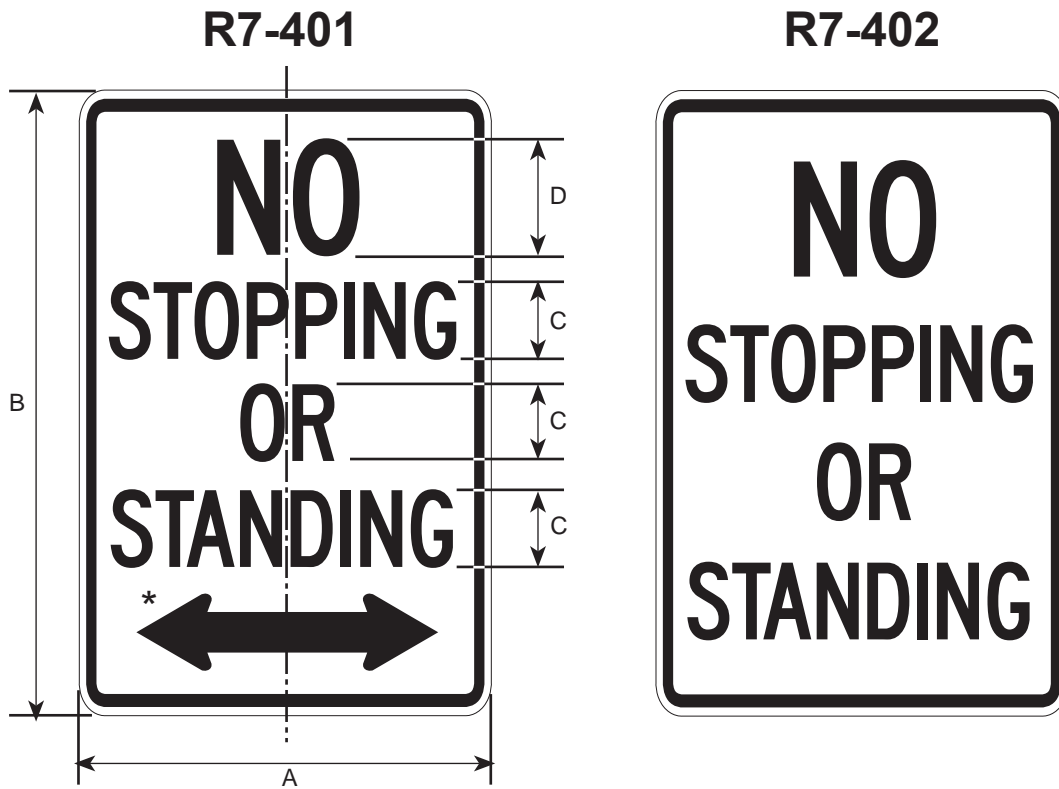

* SEE APPENDIX FOR STANDARD ARROW DETAILS
DESIGNATE LEFT, RIGHT, OR BOTH

DIMENSIONS (MILLIMETERS)			
A	B	C	D
300	450	50C	75C

DIMENSIONS (INCHES)			
A	B	C	D
12	18	2C	3C

COLORS

LEGEND - RED
BACKGROUND - WHITE (REFL)

R7-5

11/97

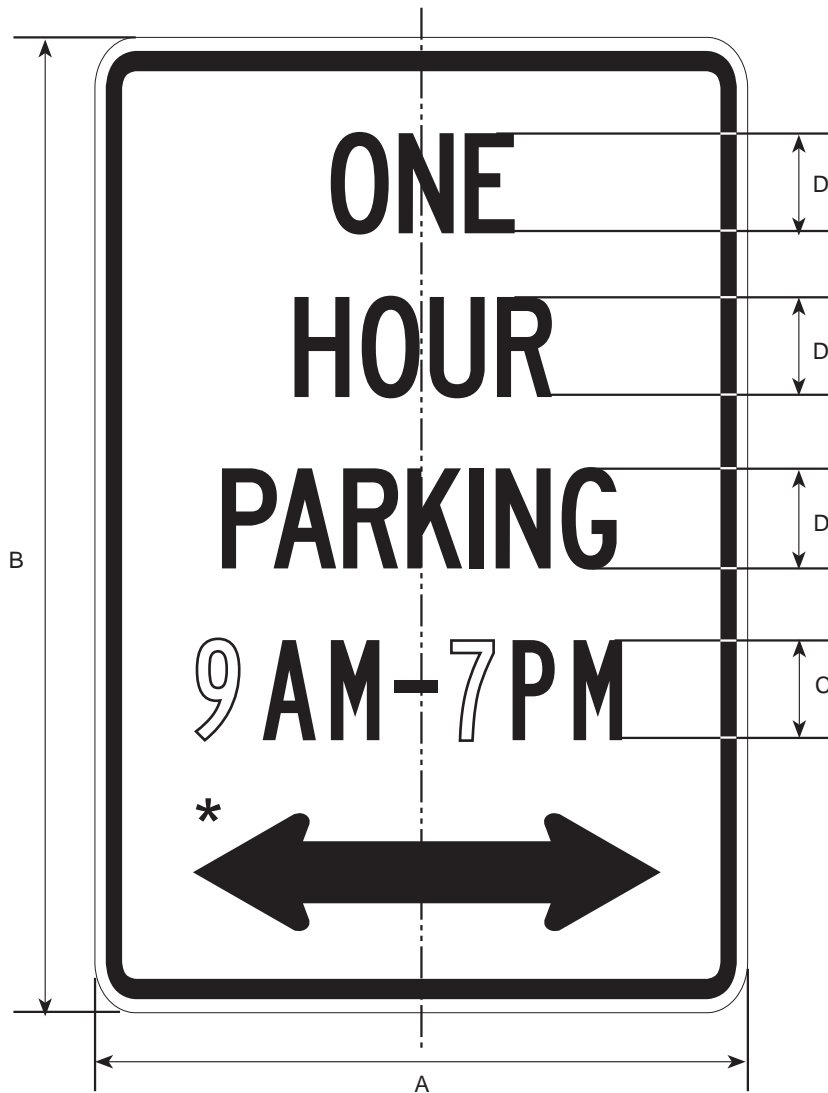

*See appendix for standard arrow details
Designate left, right, or both.

DIMENSIONS (MILLIMETERS)			
A	B	C	D
300	450	50B	50C

DIMENSIONS (INCHES)			
A	B	C	D
12	18	2B	2C

COLORS

LEGEND - GREEN
BACKGROUND - WHITE

R7-6 & R7-601

11/97

R7-6

R7-601



* SEE APPENDIX FOR STANDARD ARROW00 DETAILS
DESIGNATE LEFT, RIGHT, OR BOTH

DIMENSIONS (MILLIMETERS)				
A	B	C	D	E
300	450	50C	75B	75C

DIMENSIONS (INCHES)				
A	B	C	D	E
12	18	2C	3B	3C

COLORS

LEGEND - RED

BACKGROUND - WHITE (REFL)

R7-7 & R7-701

11/97

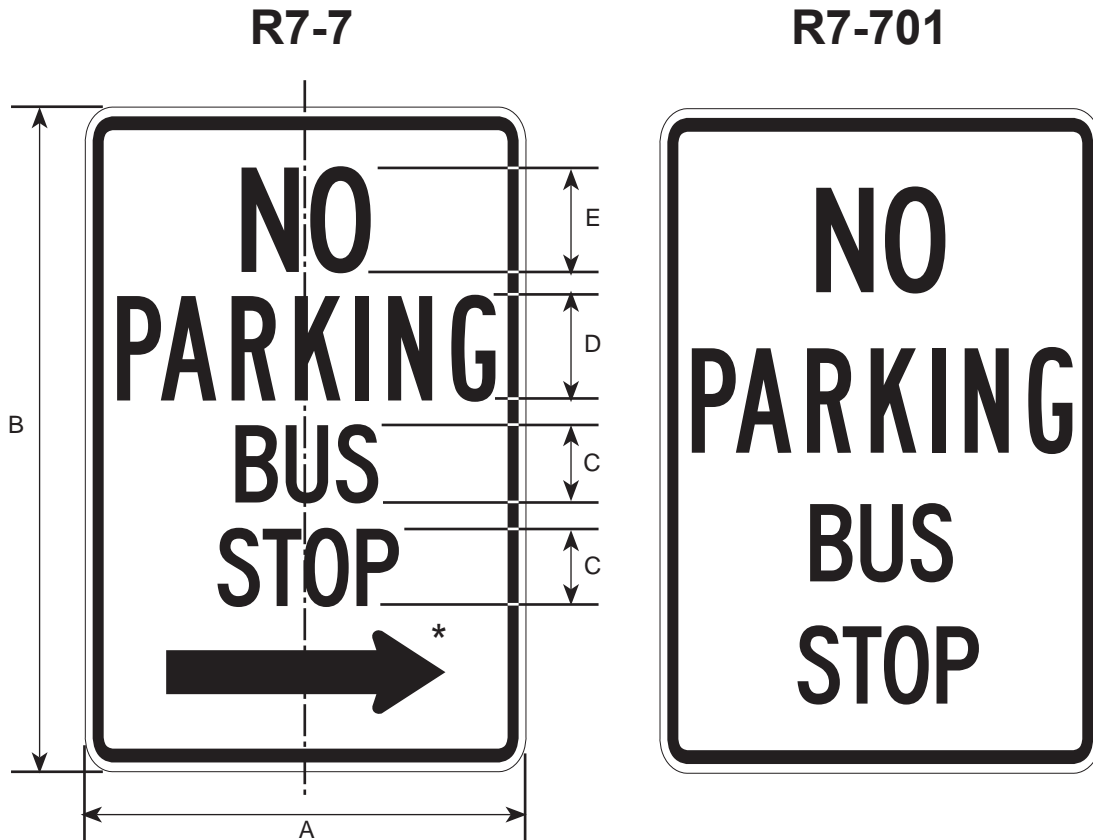

* SEE APPENDIX FOR STANDARD ARROW DETAILS
DESIGNATE LEFT, RIGHT, OR BOTH

DIMENSIONS (MILLIMETERS)				
A	B	C	D	E
300	450	50C	75B	75C

DIMENSIONS (INCHES)				
A	B	C	D	E
12	18	2C	3B	3C

COLORS

LEGEND - RED
BACKGROUND - WHITE (REFL)

R7-801

11/97



DIMENSIONS (MILLIMETERS)										
A	B	C	D	E	F	G	H	J	K	L
300	450	10	16	50C	19C	25	13	19	150	38

DIMENSIONS (INCHES)										
A	B	C	D	E	F	G	H	J	K	L
12	18	3/8	5/8	2C	3/4C	1	1/2	3/4	6	1 1/2

COLORS

- LEGEND - GREEN (REFL)
- SYMBOL - BLUE (REFL)
- BACKGROUND - WHITE (REFL)

R7-801A

11/97

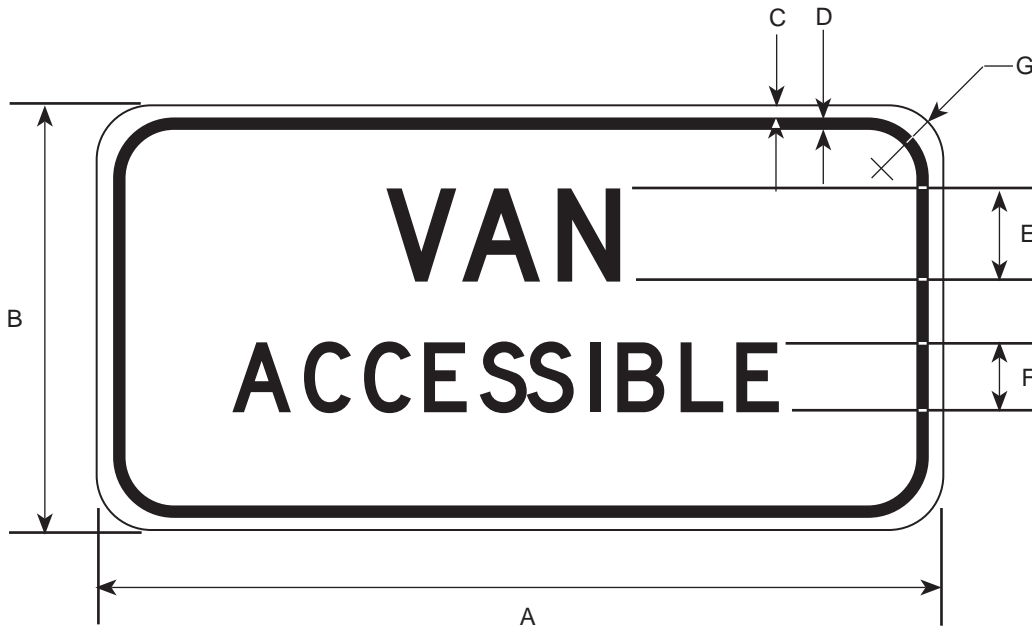

DIMENSIONS (MILLIMETERS)						
A	B	C	D	E	F	G
300	150	9	9	38D	25D	38
450	225	16	16	50D	38D	38

DIMENSIONS (MILLIMETERS)						
A	B	C	D	E	F	G
12	6	3/8	3/8	1 1/2D	1D	1 1/2
18	9	5/8	5/8	2D	1 1/2D	1 1/2

COLORS

REGULATORY (COLORS MAY BE REVERSED)

LEGEND - GREEN OR BLACK (NON-REFL)

BACKGROUND - WHITE (REFL)

DIRECTIONAL

LEGEND - WHITE (REFL)

BACKGROUND - BLUE (REFL)

R7-801P

11/97

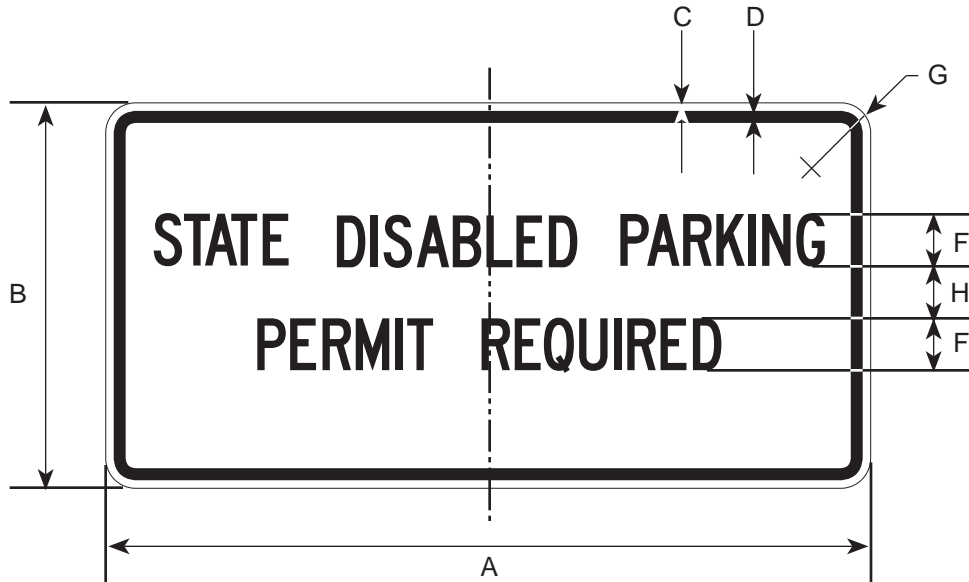

DIMENSIONS (MILLIMETERS)						
A	B	C	D	E	F	G
300	150	10	16	19C	13	38

DIMENSIONS (INCHES)						
A	B	C	D	E	F	G
12	6	3/8	5/8	3/4C	1/2	1 1/2

COLORS

LEGEND - GREEN (REFL)
 BACKGROUND - WHITE (REFL)

R7-9

3/06

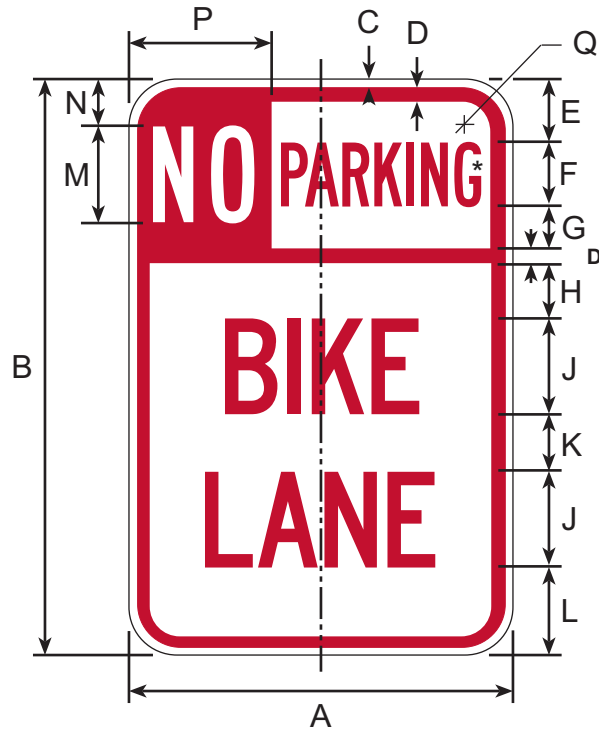

* REDUCE SPACING 15%

DIMENSIONS (MILLIMETERS)							
A	B	C	D	E	F	G	H
300	450	9	16	59	59B	25	44

J	K	L	M	N	P	Q
75C	47	69	75B	33	109	38

DIMENSIONS (INCHES)							
A	B	C	D	E	F	G	H
12	18	3/8	5/8	2	2B	1	1 3/4

J	K	L	M	N	P	Q
3C	1 7/8	2 3/4	3B	1 5/16	4 3/8	1 1/2

COLORS

LEGEND - RED (REFL) & WHITE (REFL)
 BACKGROUND - WHITE (REFL) & RED (REFL)

R7-9A

11/97

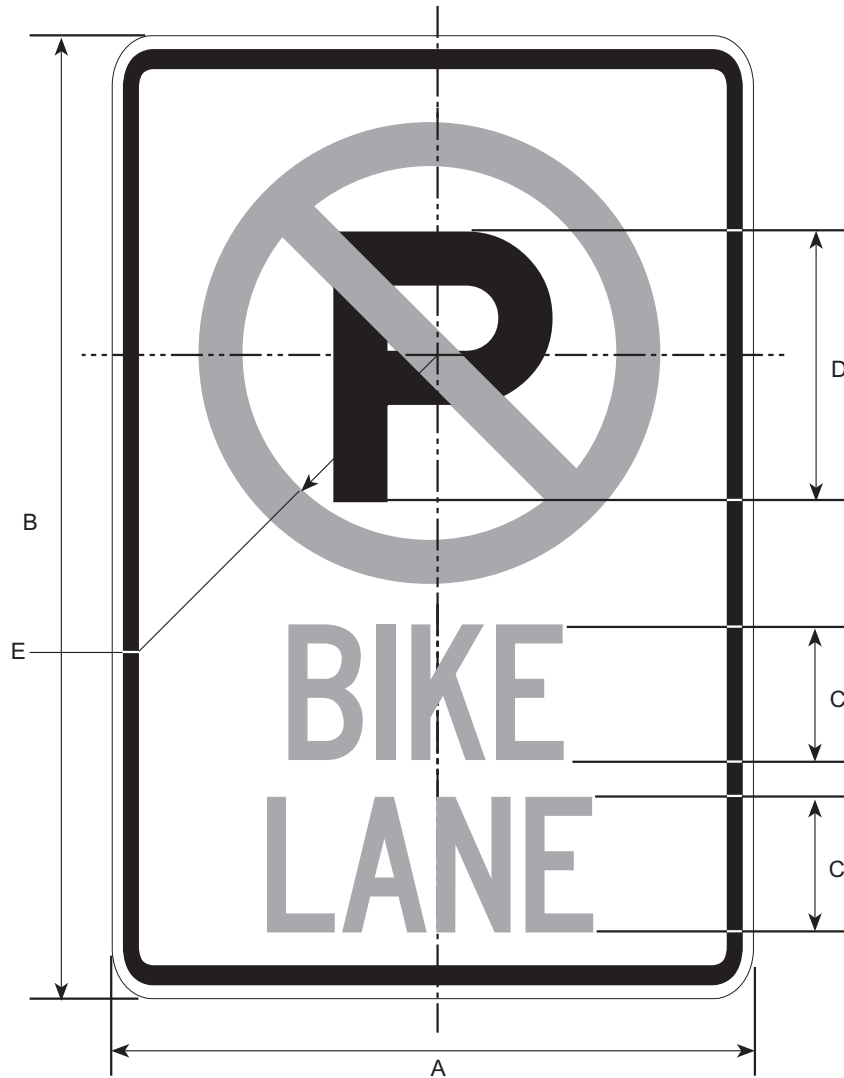

DIMENSIONS (MILLIMETERS)				
A	B	C	D	E
300	450	63C	125E(M)	85

DIMENSIONS (INCHES)				
A	B	C	D	E
12	18	2 1/2C	5E(M)	3 3/8

COLORS

LEGEND, CIRCLE, DIAGONAL — RED

BACKGROUND — WHITE

LETTER P, BORDER — BLACK

R7-10801

11/97



DIMENSIONS (MILLIMETERS)		
A	B	C
300	450	75A

DIMENSIONS (INCHES)		
A	B	C
12	18	3A

COLORS

LEGEND - GREEN
BACKGROUND - WHITE

R7-10802

11/97

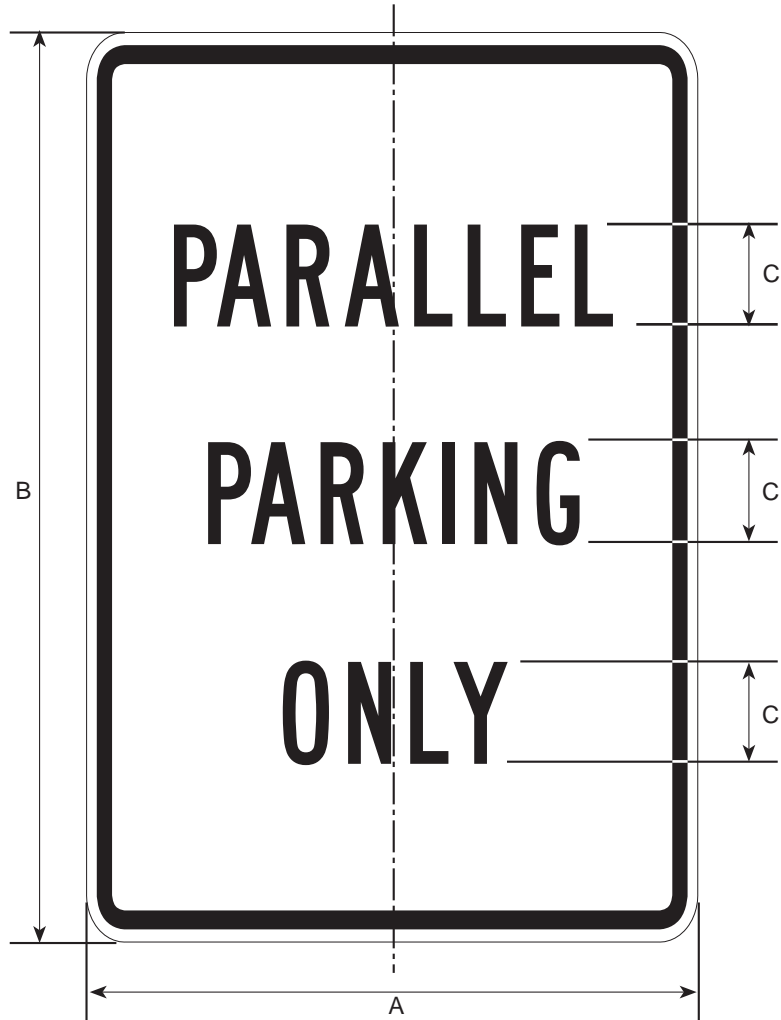

DIMENSIONS (MILLIMETERS)		
A	B	C
300	450	50B

DIMENSIONS (INCHES)		
A	B	C
12	18	2B

COLORS

LEGEND - BLACK
BACKGROUND - WHITE

R8-1

11/97



DIMENSIONS (MILLIMETERS)

A	B	C	D	E	F	G
450	600	10	16	75D	75C	50D
600	750	10	16	125D	125C	75D
900	1200	16	22	175D	175C	100D
1200	1500	19	31	225D	225C	125D

DIMENSIONS (INCHES)

A	B	C	D	E	F	G
18	24	3/8	5/8	3D	3C	2D
24	30	3/8	5/8	5D	5C	3D
36	48	5/8	7/8	7D	7C	4D
48	60	3/4	1 1/4	9D	9C	5D

COLORS

LEGEND - RED (REFL)
 BACKGROUND - WHITE (REFL)

R8-2

11/97



DIMENSIONS (MILLIMETERS)										
A	B	C	D	E	F	G	H	J	K	L
450	600	9	16	88	75D	63	75C	50C	50	38
600	750	9	16	91	125D	56	125C	75C	56	38
900	1200	16	22	150	175D	125	175C	100C	100	56
1200	1500	19	31	188	225D	150	225C	125C	125	75

DIMENSIONS (INCHES)										
A	B	C	D	E	F	G	H	J	K	L
18	24	3/8	5/8	3 1/2	3D	2 1/2	3C	2C	2	1 1/2
24	30	3/8	5/8	3 5/8	5D	2 1/4	5C	3C	2 1/4	1 1/2
36	48	5/8	7/8	6	7D	5	7C	4C	4	2 1/4
48	60	3/4	1 1/4	7 1/2	9D	6	9C	5C	5	3

COLORS

LEGEND - RED (REFL)
 BACKGROUND - WHITE (REFL)

R8-3

11/97



DIMENSIONS (MILLIMETERS)								
A	B	C	D	E	F	G	H	J
450	600	9	16	175	100D	75	75C	38
600	750	9	16	181	150D	113	125C	38
900	900	16	22	188	200D	150	175C	56
1200	1200	19	31	263	250D	200	225C	75

DIMENSIONS (INCHES)								
A	B	C	D	E	F	G	H	J
18	24	3/8	5/8	7	4D	3	3C	1 1/2
24	30	3/8	5/8	7 1/4	6D	4 1/2	5C	1 1/2
36	36	5/8	7/8	7 1/2	8D	6	7C	2 1/4
48	48	3/4	1 1/4	10 1/2	10D	8	9C	3

COLORS

LEGEND - RED (REFL)
 BACKGROUND - WHITE (REFL)

R8-3A

11/9

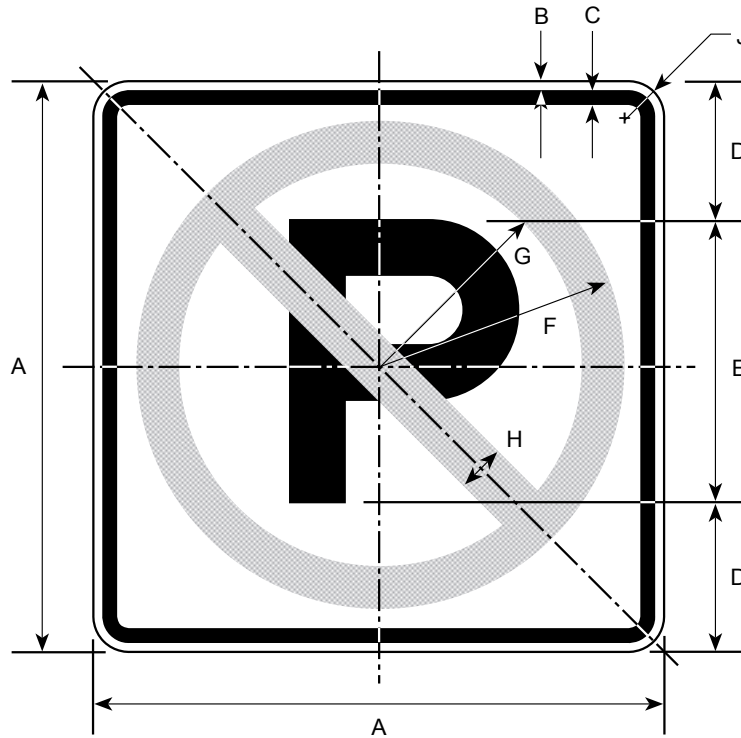

DIMENSIONS (MILLIMETERS)								
A	B	C	D	E	F	G	H	J
300	9	16	75	150E(M)	122	97	25	38
600	13	19	150	300E(M)	263	213	62	38
900	16	22	225	450E(M)	394	319	75	56
1200	19	31	300	600E(M)	525	425	100	75

DIMENSIONS (INCHES)								
A	B	C	D	E	F	G	H	J
12	3/8	3/8	3	6E(M)	4 7/8	3 7/8	1	1 1/2
24	3/8	5/8	6	12E(M)	10 1/2	8 1/2	2 1/2	1 1/2
36	5/8	7/8	9	18E(M)	15 3/4	12 3/4	3	2 1/4
48	3/4	1 1/4	12	24E(M)	21	17	4	3

COLORS

CIRCLE & DIAGONAL — RED (REFL)
 SYMBOL & BORDER — BLACK (NON-REFL)
 BACKGROUND — WHITE (REFL)

R8-3AP

11/97



OTHER TYPICAL LEGENDS

**ON
TRACKS**

**ON
BRIDGE**

**ON
PAVEMENT**

**6 AM
TO 6 PM**

**EXCEPT ON
SHOULDERS**

**LOADING
ZONE**



DIMENSIONS (MILLIMETERS)

A	B	C	D	E	F	G	H
300	VAR	9	9	VAR	VAR	VAR	38
600	VAR	9	16	VAR	VAR	VAR	38

DIMENSIONS (INCHES)

A	B	C	D	E	F	G	H
12	VAR	3/8	3/8	VAR	VAR	VAR	1 1/2
24	VAR	3/8	5/8	VAR	VAR	VAR	1 1/2

COLORS

LEGEND - RED (REFL)
BACKGROUND - WHITE (REFL)

R8-3C

3/06

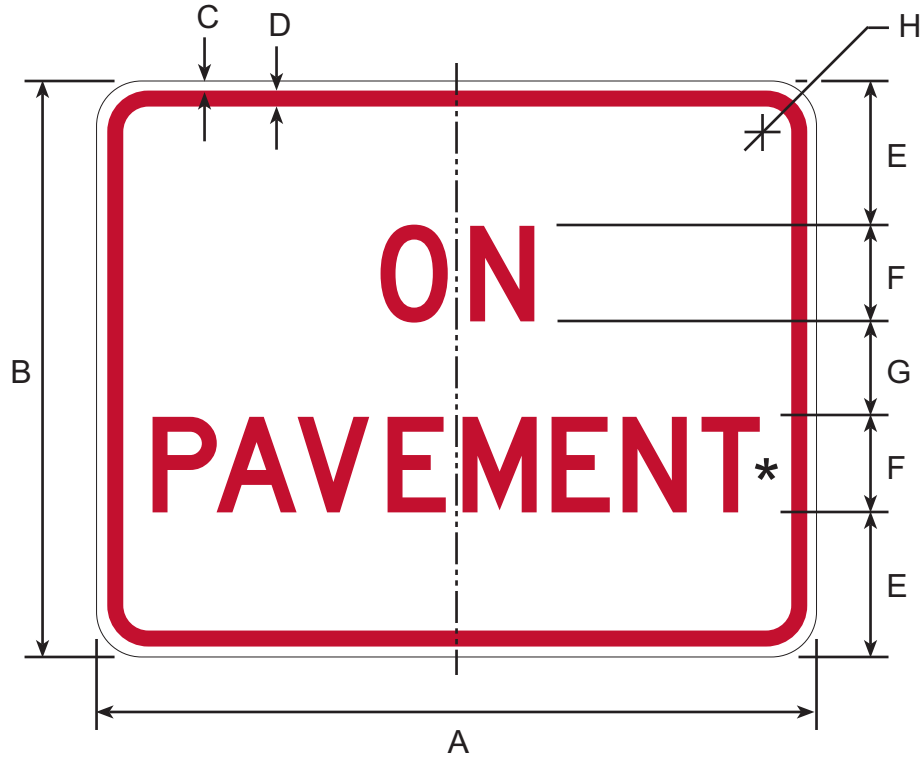

* REDUCE SPACING TO FIT FOR 30" (750MM) WIDE SIGN

DIMENSIONS (MILLIMETERS)							
A	B	C	D	E	F	G	H
300	225	9	11	66	34D	25	38
450	300	9	16	75	50D	50	38
600	450	9	16	119	75D	62	38
750	600	13	19	150	100D	100	47

DIMENSIONS (INCHES)							
A	B	C	D	E	F	G	H
12	9	3/8	7/16	2 5/8	1 3/8D	1	1 1/2
18	12	3/8	5/8	3	2D	2	1 1/2
24	18	3/8	5/8	4 3/4	3D	2 1/2	1 1/2
30	24	1/2	3/4	6	4D	4	1 7/8

COLORS

LEGEND - RED (REFL)
BACKGROUND - WHITE (REFL)

R8-3D

3/06

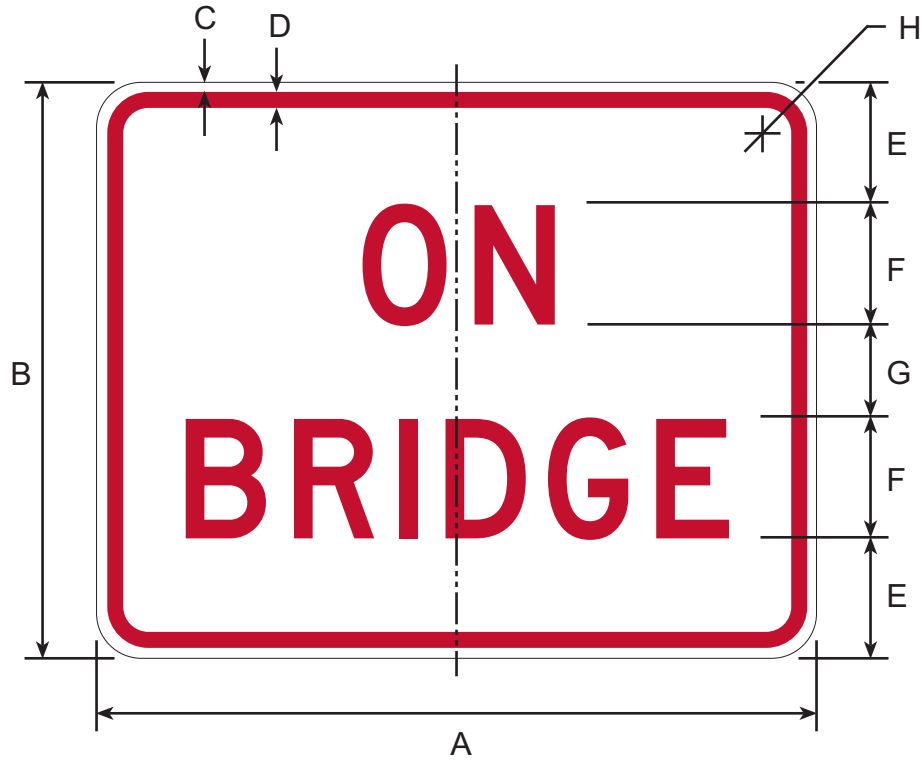

DIMENSIONS (MILLIMETERS)							
A	B	C	D	E	F	G	H
300	225	9	11	50	50D	25	38
450	300	9	16	50	75D	50	38
600	450	9	16	94	100D	63	38
750	600	13	19	125	125D	100	47

DIMENSIONS (INCHES)							
A	B	C	D	E	F	G	H
12	9	3/8	7/16	2	2D	1	1 1/2
18	12	3/8	5/8	2	3D	2	1 1/2
24	18	3/8	5/8	3 3/4	4D	2 1/2	1 1/2
30	24	1/2	3/4	5	5D	4	1 7/8

COLORS

LEGEND - RED (REFL)
BACKGROUND - WHITE (REFL)

R8-301

11/97



DIMENSIONS (MILLIMETERS)							
A	B	C	D	E	F	G	H
750	900	9	16	175D	150C	100C	38

DIMENSIONS (INCHES)							
A	B	C	D	E	F	G	H
30	36	3/8	5/8	7D	6C	4C	1 1/2

COLORS

LEGEND - BLACK (NON-REFL)
BACKGROUND - WHITE (REFL)

R8-4

11/97



DIMENSIONS (MILLIMETERS)								
A	B	C	D	E	F	G	H	J
750	600	9	16	88	100C	63	100D	38
1200	900	16	22	125	150C	100	150D	56

DIMENSIONS (INCHES)								
A	B	C	D	E	F	G	H	J
30	24	3/8	5/8	3 1/2	4C	2 1/2	4D	1 1/2
48	36	5/8	7/8	5	6C	4	6D	2 1/4

COLORS

LEGEND - BLACK (NON-REFL)
 BACKGROUND - WHITE (REFL)

R8-5

11/97



DIMENSIONS (MILLIMETERS)										
A	B	C	D	E	F	G	H	J	K	L
450	600	9	16	88	75D	63	75B	50D	50	38
600	750	9	16	91	125D	56	125B	75D	56	38
900	1200	16	22	150	175D	125	175B	100D	100	56
1200	1500	19	31	188	225D	150	225B	125D	125	75

DIMENSIONS (INCHES)										
A	B	C	D	E	F	G	H	J	K	L
18	24	3/8	5/8	3 1/2	3D	2 1/2	3B	2D	2	1 1/2
24	30	3/8	5/8	3 5/8	5D	2 1/4	5B	3D	2 1/4	1 1/2
36	48	5/8	7/8	6	7D	5	7B	4D	4	2 1/4
48	60	3/4	1 1/4	7 1/2	9D	6	9B	5D	5	3

COLORS

LEGEND - RED (REFL)
 BACKGROUND - WHITE (REFL)

R8-6

11/97

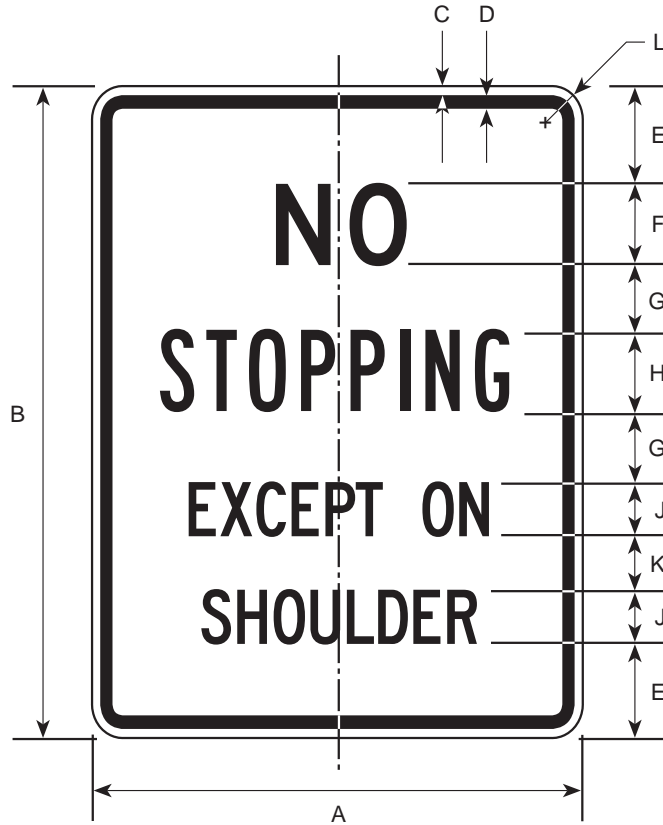

DIMENSIONS (MILLIMETERS)										
A	B	C	D	E	F	G	H	J	K	L
450	600	9	16	88	75D	63	75B	50C	50	38
600	750	9	16	91	125D	56	125B	75C	56	38
900	1200	16	22	150	175D	125	175B	100C	100	56
1200	1500	19	31	188	225D	150	225B	125C	125	75

DIMENSIONS (INCHES)										
A	B	C	D	E	F	G	H	J	K	L
18	24	3/8	5/8	3 1/2	3D	2 1/2	3B	2C	2	1 1/2
24	30	3/8	5/8	3 5/8	5D	2 1/4	5B	3C	2 1/4	1 1/2
36	48	5/8	7/8	6	7D	5	7B	4C	4	2 1/4
48	60	3/4	1 1/4	7 1/2	9D	6	9B	5C	5	3

COLORS

LEGEND - RED (REFL)
BACKGROUND - WHITE (REFL)

R8-7

11/97



DIMENSIONS (MILLIMETERS)								
A	B	C	D	E	F	G	H	J
750	600	9	16	88	100C	63	100D	38
1200	900	16	22	125	150C	100	150D	56

DIMENSIONS (INCHES)								
A	B	C	D	E	F	G	H	J
30	24	3/8	5/8	3 1/2	4C	2 1/2	4D	1 1/2
48	36	5/8	7/8	5	6C	4	6D	2 1/4

COLORS

LEGEND - BLACK (NON-REFL)
BACKGROUND - WHITE (REFL)

R8-8

6/00

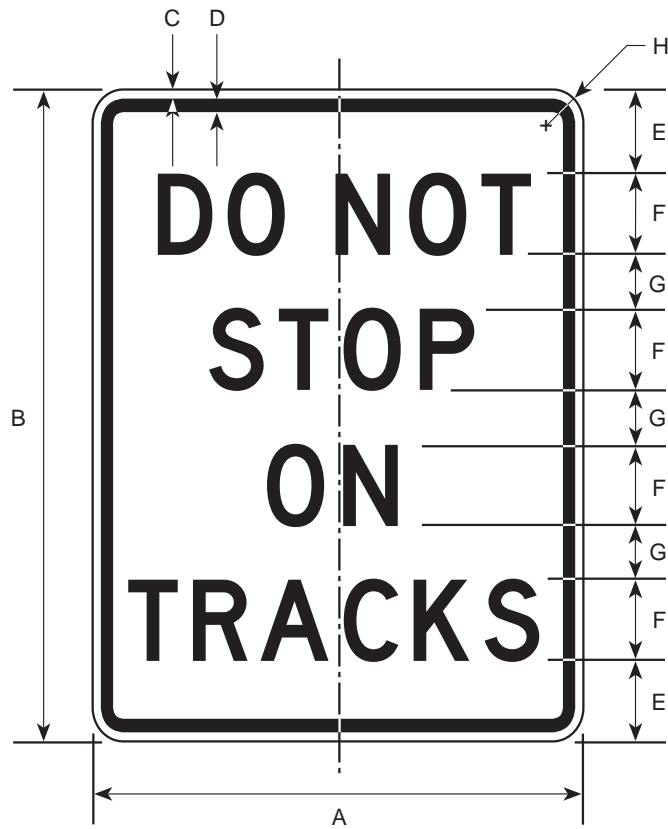

DIMENSIONS (MILLIMETERS)							
A	B	C	D	E	F	G	H
600	750	9	16	91	100D	56	38
900	1200	16	22	150	150D	100	56
1200	1500	19	31	181	200D	113	75

DIMENSIONS (INCHES)							
A	B	C	D	E	F	G	H
24	30	3/8	5/8	3 5/8	4D	2 1/4	1 1/2
36	48	5/8	7/8	6	6D	4	2 1/4
48	60	3/4	1 1/4	7 1/4	8D	4 1/2	3

COLORS

LEGEND - BLACK (REFL)
BACKGROUND - WHITE (REFL)

R8-9

11/97

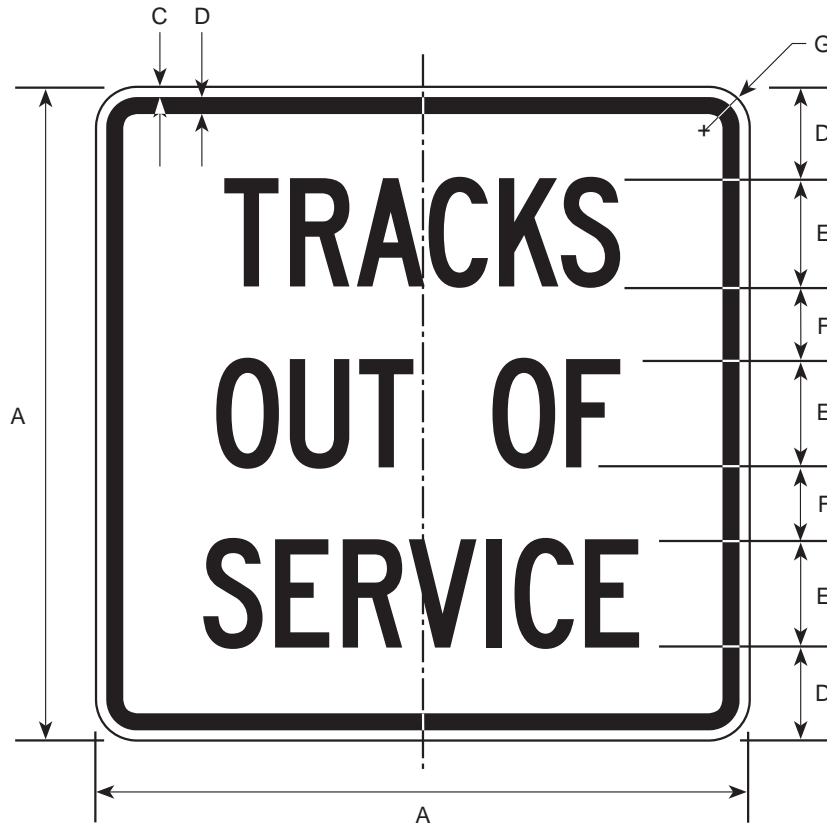

DIMENSIONS (MILLIMETERS)						
A	B	C	D	E	F	G
600	9	16	88	100C	63	38
900	16	22	125	150C	100	56
1200	19	31	175	200C	125	75

DIMENSIONS (INCHES)						
A	B	C	D	E	F	G
24	3/8	5/8	3 1/2	4C	2 1/2	1 1/2
36	5/8	7/8	5	6C	4	2 1/4
48	3/4	1 1/4	7	8C	5	3

COLORS

LEGEND - BLACK (NON-REFL)
 BACKGROUND - WHITE (REFL)

R8-1201

11/97



DIMENSIONS (MILLIMETERS)							
A	B	C	D	E	F	G	H
450	600	9	16	100C	100B	75	38

DIMENSIONS (INCHES)							
A	B	C	D	E	F	G	H
18	24	3/8	5/8	4C	4B	3	1 1/2

COLORS

LEGEND - GREEN (REFL)
 BACKGROUND - WHITE (REFL)

R9-1

11/97



DIMENSIONS (MILLIMETERS)										
A	B	C	D	E	F	G	H	J	K	L
450	600	9	16	75	100D	63	75D	50D	50	38

DIMENSIONS (INCHES)										
A	B	C	D	E	F	G	H	J	K	L
18	24	3/8	5/8	3	4D	2 1/2	3D	2D	2	1 1/2

COLORS

LEGEND - BLACK (NON-REFL)
 BACKGROUND - WHITE (REFL)

R9-2

11/97

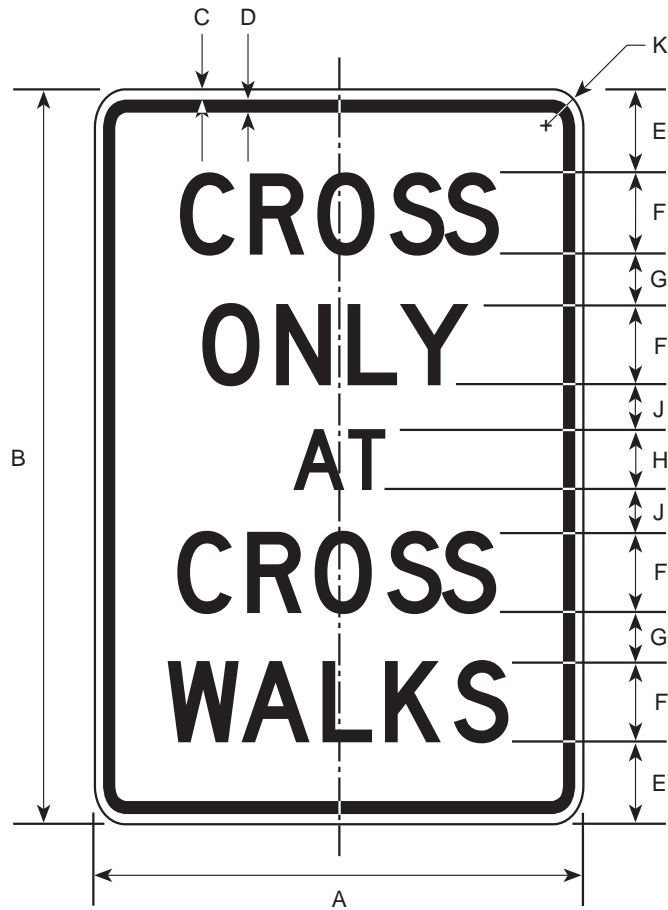

DIMENSIONS (MILLIMETERS)									
A	B	C	D	E	F	G	H	J	K
300	450	9	9	50	50D	31	38D	25	38

DIMENSIONS (INCHES)									
A	B	C	D	E	F	G	H	J	K
12	18	3/8	3/8	2	2D	1 1/4	1 1/2D	1	1 1/2

COLORS

LEGEND - BLACK (NON-REFL)
 BACKGROUND - WHITE (REFL)

R9-3

11/97

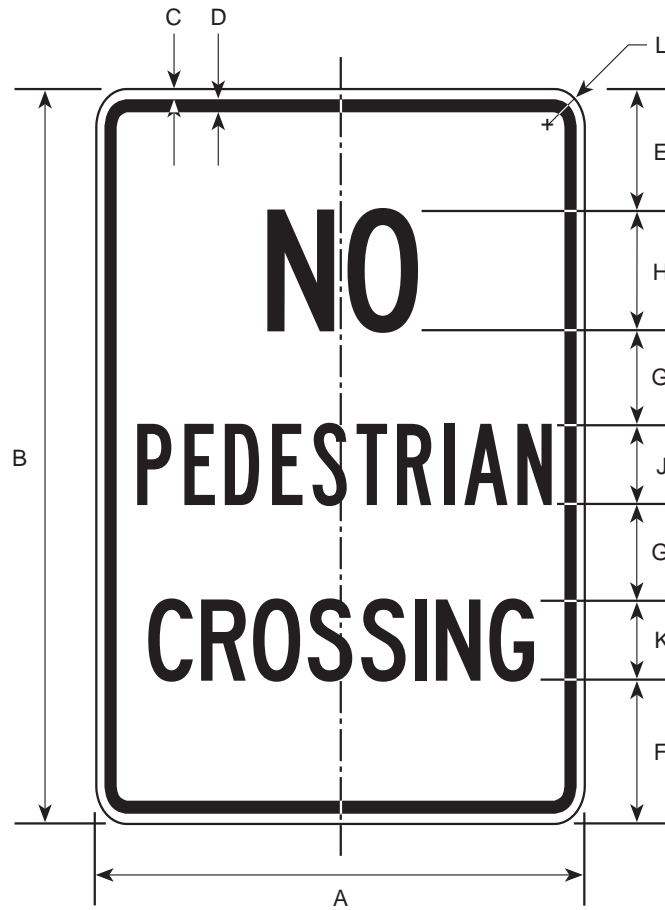

DIMENSIONS (MILLIMETERS)										
A	B	C	D	E	F	G	H	J	K	L
300	450	9	9	75	88	56	75C	50B	50C	38

DIMENSIONS (INCHES)										
A	B	C	D	E	F	G	H	J	K	L
12	18	3/8	3/8	3	3 1/2	2 1/4	3C	2B	2C	1 1/2

COLORS

LEGEND - BLACK (NON-REFL)
 BACKGROUND - WHITE (REFL)

R9-3A

11/94

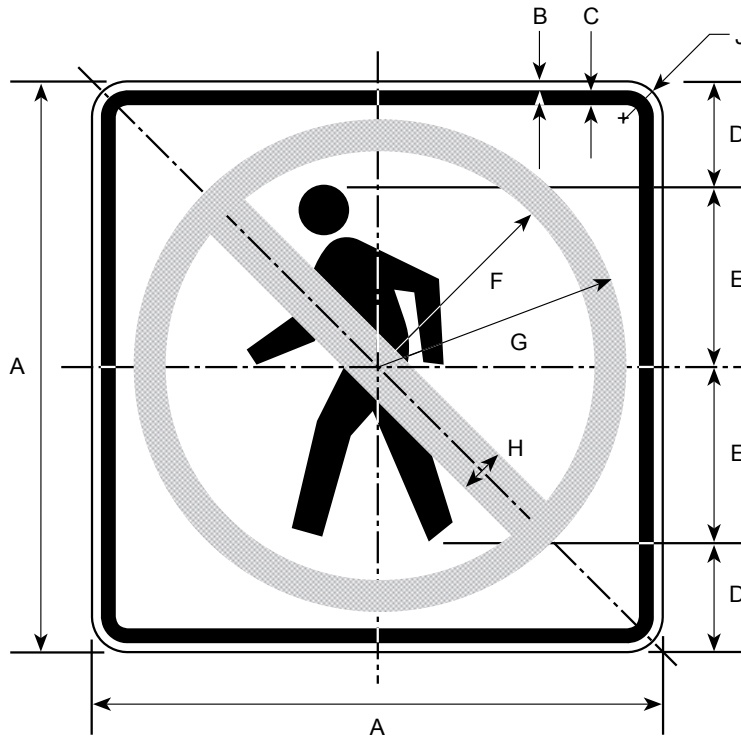

* See appendix for standard symbol details

DIMENSIONS (MILLIMETERS)								
A	B	C	D	E	F	G	H	J
450	9	16	88	138	159	191	38	38
600	9	16	113	188	213	263	50	50
750	13	19	144	231	266	328	63	63

DIMENSIONS (INCHES)								
A	B	C	D	E	F	G	H	J
18	3/8	5/8	3 1/2	5 1/2	6 3/8	7 5/8	1 1/2	1 1/2
24	3/8	5/8	4 1/2	7 1/2	8 1/2	10 1/2	2	2
30	1/2	3/4	5 3/4	9 1/4	10 5/8	13 1/8	2 1/2	2 1/2

COLORS

CIRCLE & DIAGONAL — RED (REFL)
 SYMBOL & BORDER — BLACK (NON-REFL)
 BACKGROUND — WHITE (REFL)

R9-3B L/R

11/97

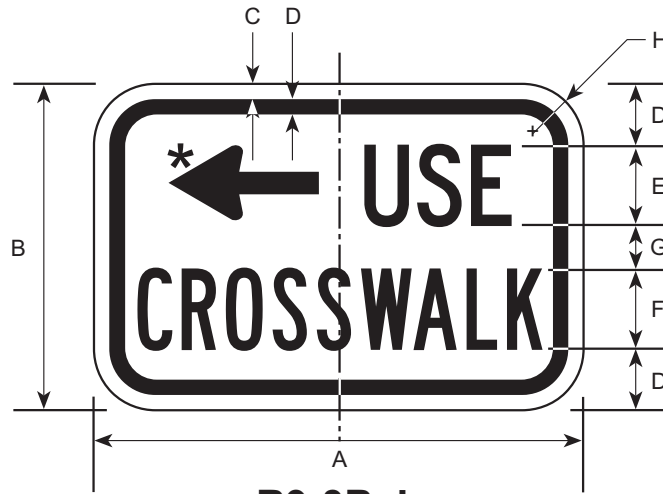

R9-3B L

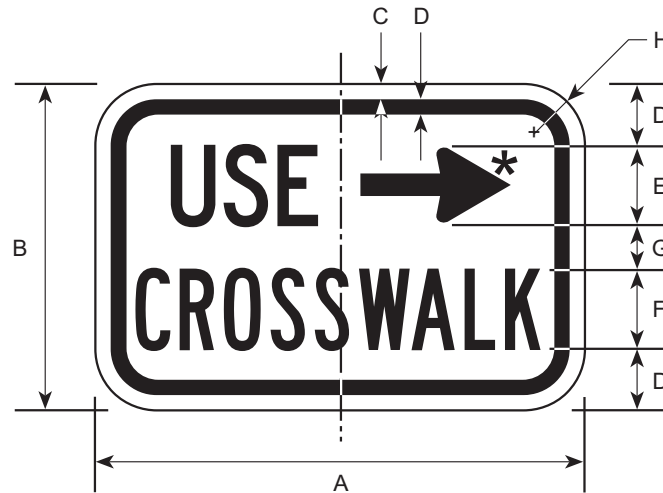

R9-3B R

* See appendix for standard arrow details

DIMENSIONS (MILLIMETERS)							
A	B	C	D	E	F	G	H
450	300	9	56	75C	75B	38	38

DIMENSIONS (INCHES)							
A	B	C	D	E	F	G	H
18	12	3/8	2.25	3C	3B	1 1/2	1 1/2

COLORS

LEGEND — BLACK (NON-REFL)
BACKGROUND — WHITE (REFL)

R9-3C

3/06

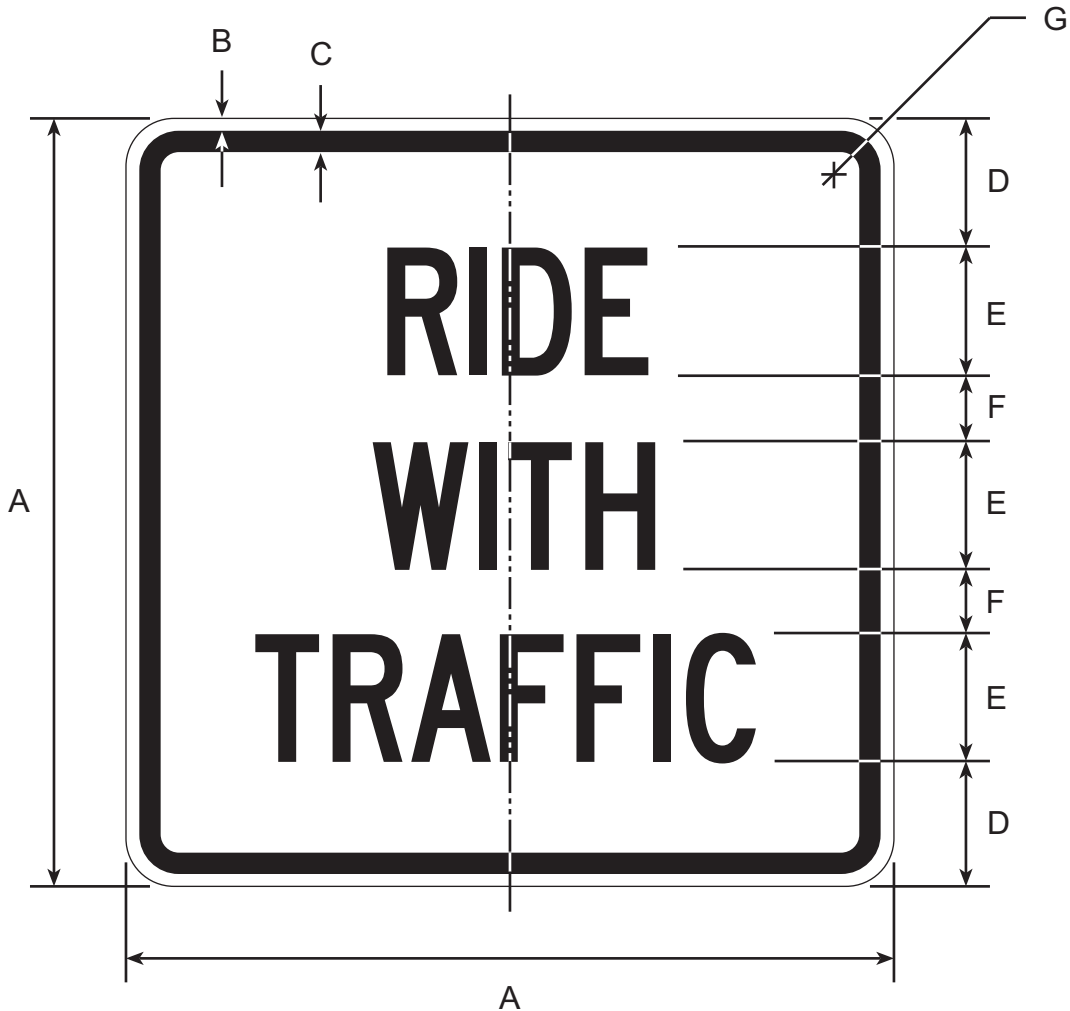

DIMENSIONS (MILLIMETERS)						
A	B	C	D	E	F	G
300	9	11	50	50C	25	38

DIMENSIONS (INCHES)						
A	B	C	D	E	F	G
12	3/8	7/16	2	2C	1	1 1/2

COLORS

LEGEND - BLACK (NON-REFL)
 BACKGROUND - WHITE (REFL)

R9-4

11/97



DIMENSIONS (MILLIMETERS)								
A	B	C	D	E	F	G	H	J
450	600	9	16	75	150C	50	100C	38

DIMENSIONS (INCHES)								
A	B	C	D	E	F	G	H	J
18	24	3/8	5/8	3	6C	2	4C	1 1/2

COLORS

LEGEND — BLACK (NON-REFL)
 BACKGROUND — WHITE (REFL)

R9-4A

11/97

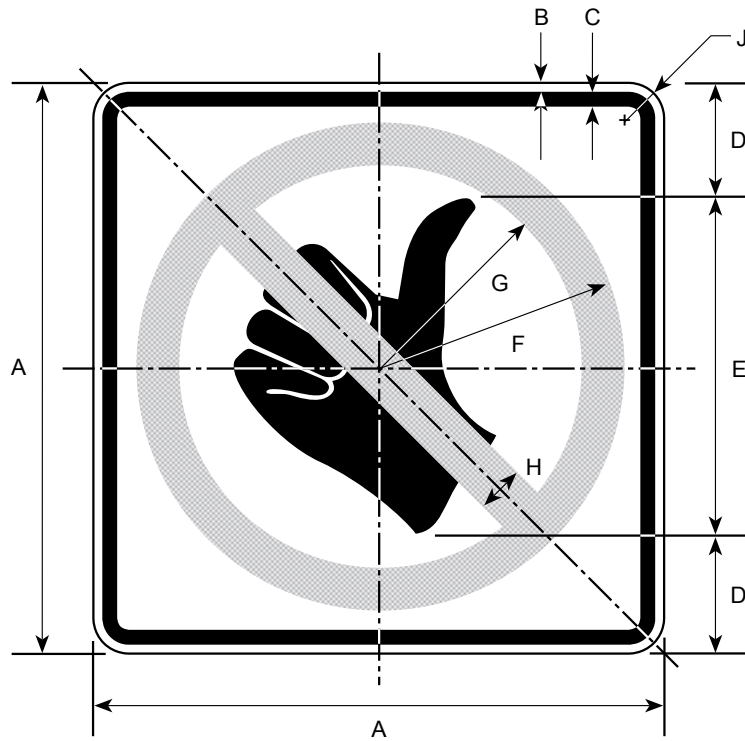

* See appendix for standard symbol details

DIMENSIONS (MILLIMETERS)								
A	B	C	D	E	F	G	H	J
450	9	16	94	263	191	159	38	38
600	9	16	125	350	263	213	50	38

DIMENSIONS (INCHES)								
A	B	C	D	E	F	G	H	J
18	3/8	5/8	3 3/4	10 1/2	7 5/8	6 3/8	1 1/2	1 1/2
24	3/8	5/8	5	14	10 1/2	8 1/2	2	1 1/2

COLORS

CIRCLE & DIAGONAL — RED (REFL)
 SYMBOL & BORDER — BLACK (NON-REFL)
 BACKGROUND — WHITE (REFL)

R9-5

11/97

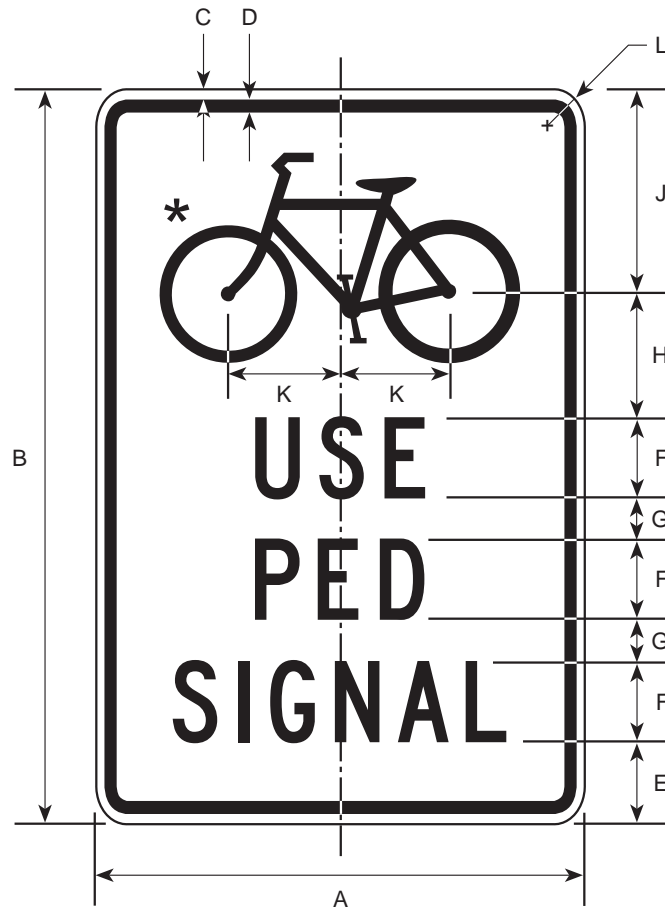

* See appendix for standard symbol details

DIMENSIONS (MILLIMETERS)										
A	B	C	D	E	F	G	H	J	K	L
300	450	9	9	50	50C	25	75	125	69	38

DIMENSIONS (INCHES)										
A	B	C	D	E	F	G	H	J	K	L
12	18	3/8	3/8	2	2C	1	3	5	2 3/4	1 1/2

COLORS

LEGEND - BLACK (NON-REFL)
 BACKGROUND - WHITE (REFL)

R9-6

11/97

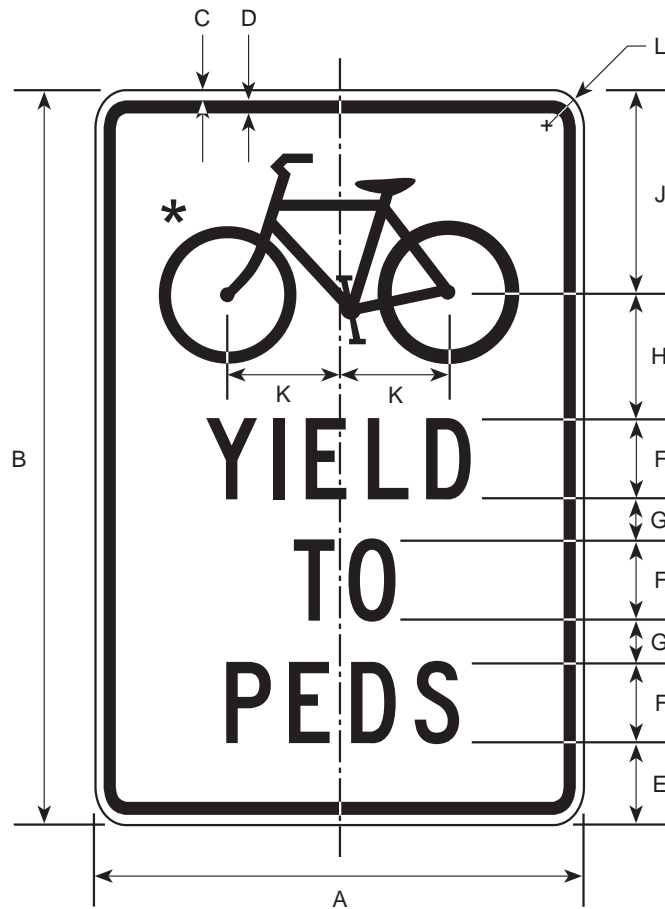

* See appendix for standard symbol details

DIMENSIONS (MILLIMETERS)										
A	B	C	D	E	F	G	H	J	K	L
300	450	9	9	50	50C	25	75	125	69	38

DIMENSIONS (INCHES)										
A	B	C	D	E	F	G	H	J	K	L
12	18	3/8	3/8	2	2C	1	3	5	2 3/4	1 1/2

COLORS

LEGEND - BLACK (NON-REFL)
 BACKGROUND - WHITE (REFL)

R9-7

11/97



* See appendix for standard symbol details

DIMENSIONS (MILLIMETERS)							
A	B	C	D	E	F	G	H
300	450	9	9	50	100B	38	50B
J	K	L	M	N	P	Q	
50	113	9	31	69	81	38	

DIMENSIONS (INCHES)							
A	B	C	D	E	F	G	H
12	18	3/8	3/8	2	4B	1 1/2	2B
J	K	L	M	N	P	Q	
2	4 1/2	3/8	1 1/4	2 3/4	3 1/4	1 1/2	

COLORS

LEGEND - BLACK (NON-REFL)
BACKGROUND - WHITE (REFL)

R9-8

6/03

R9-9

6/03

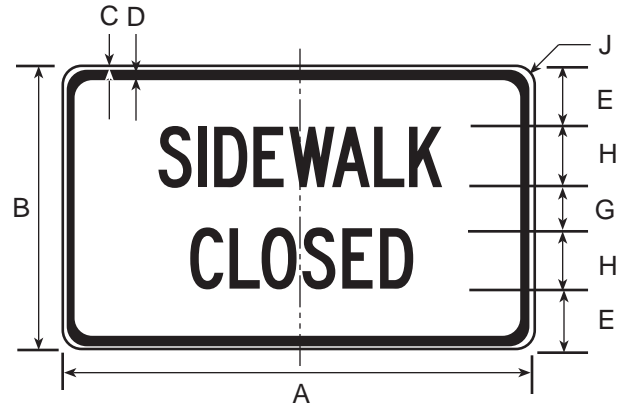
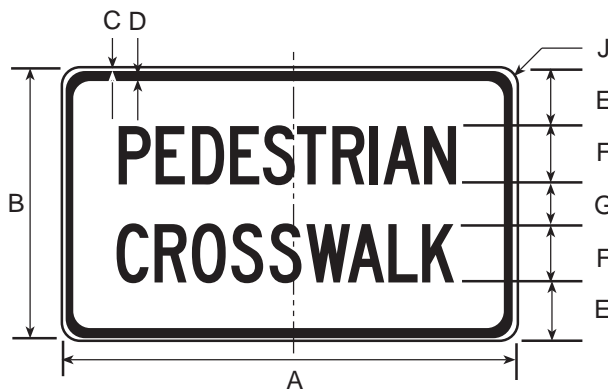

DIMENSIONS (MILLIMETERS)								
A	B	C	D	E	F	G	H	J
600	300	9	12	53	75C	44	75D	38

DIMENSIONS (INCHES)								
A	B	C	D	E	F	G	H	J
24	12	3/8	5/8	2 1/8	3C	1 3/4	3D	1 1/2

COLORS
 LEGEND - BLACK
 BACKGROUND - WHITE (REFL)

R9-10

6/03

R9-11

6/03

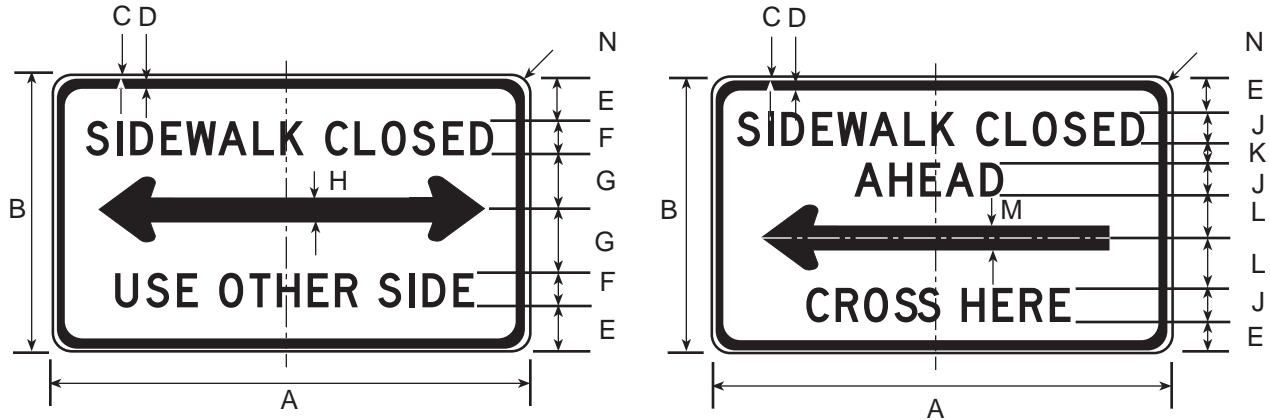

*SEE APPENDIX FOR STANDARD ARROW DETAILS

DIMENSIONS (MILLIMETERS)						
A	B	C	D	E	F	G
600	300	9	16	44	50C	56
H	J	K	L	M	N	
41	38D	19	41	17	38	

DIMENSIONS (INCHES)						
A	B	C	D	E	F	G
24	12	3/8	5/8	1 3/4	2C	2 1/4
H	J	K	L	M	N	
1 5/8	1 1/2D	3/4	1 5/8	1 1/16	1 1/2	

COLORS
 LEGEND - BLACK
 BACKGROUND - WHITE (REFL)

R9-11A

6/03

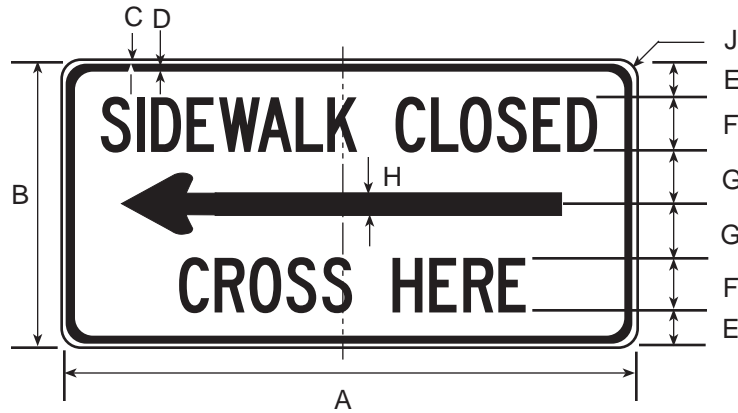

*SEE APPENDIX FOR STANDARD ARROW DETAILS

DIMENSIONS (MILLIMETERS)								
A	B	C	D	E	F	G	H	J
600	300	9	16	44	50C	56	41	38

DIMENSIONS (INCHES)								
A	B	C	D	E	F	G	H	J
24	12	3/8	5/8	1 3/4	2C	2 1/4	1 5/8	1 1/2

COLORS
 LEGEND - BLACK
 BACKGROUND - WHITE (REFL)

R10-1

11/97

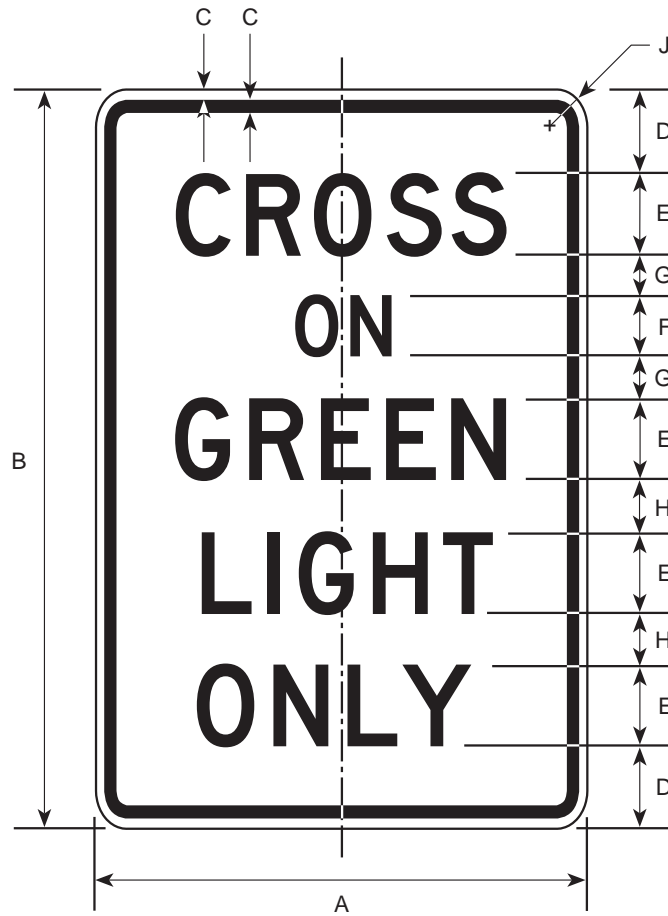

DIMENSIONS (MILLIMETERS)								
A	B	C	D	E	F	G	H	J
300	450	9	50	50D	38D	25	31	38

DIMENSIONS (INCHES)								
A	B	C	D	E	F	G	H	J
12	18	3/8	2	2D	1 1/2D	1	1 1/4	1 1/2

COLORS

LEGEND - BLACK (NON-REFL)
BACKGROUND - WHITE (REFL)

R10-2

11/97

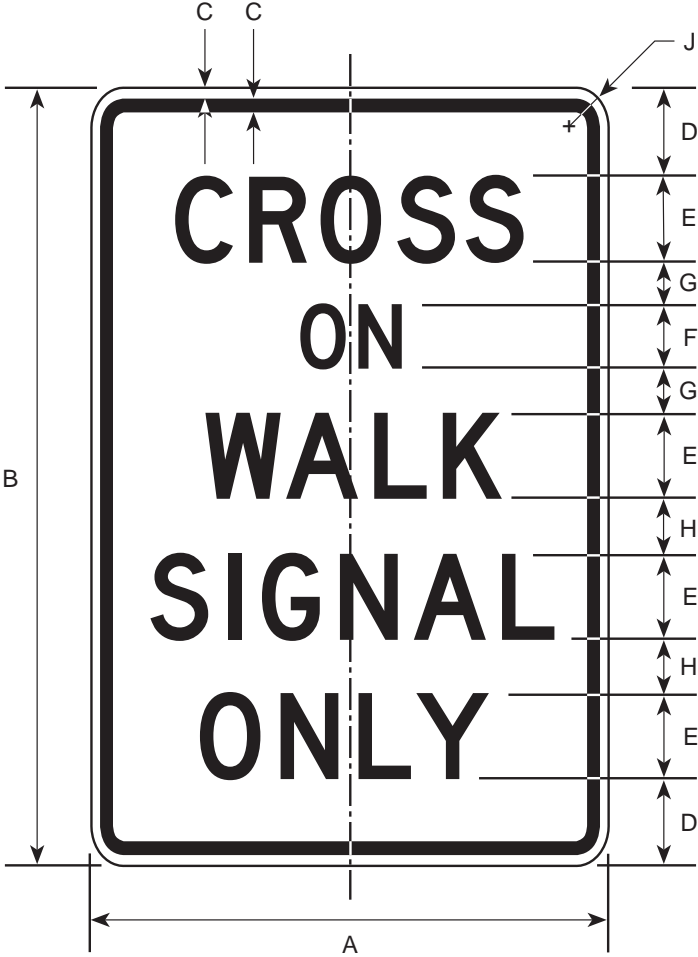

DIMENSIONS (MILLIMETERS)								
A	B	C	D	E	F	G	H	J
300	450	9	50	50D	38D	25	31	38

DIMENSIONS (INCHES)								
A	B	C	D	E	F	G	H	J
12	18	3/8	2	2D	1 1/2D	1	1 1/4	1 1/2

COLORS

LEGEND - BLACK (NON-REFL)
 BACKGROUND - WHITE (REFL)

R10-2A

11/97

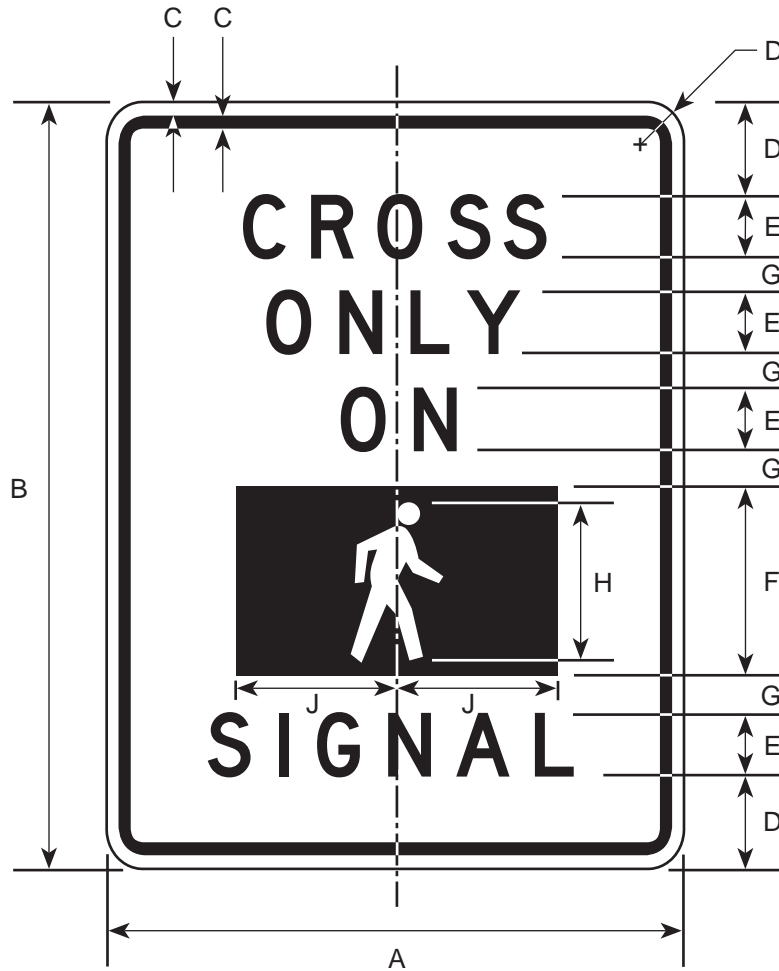

DIMENSIONS (MILLIMETERS)								
A	B	C	D	E	F	G	H	J
225	300	9	38	25D	75	13	63	50

DIMENSIONS (INCHES)								
A	B	C	D	E	F	G	H	J
9	12	3/8	1 1/2	1D	3	1/2	2 1/2	2

COLORS

LEGEND - BLACK (NON-REFL)
 BACKGROUND - WHITE (REFL)
 SYMBOL - WHITE (REFL)

R10-3

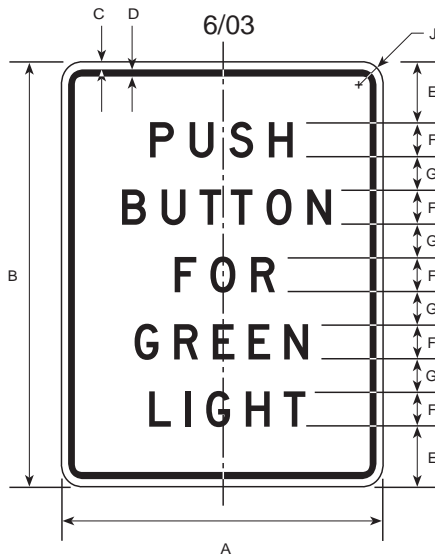

R10-4

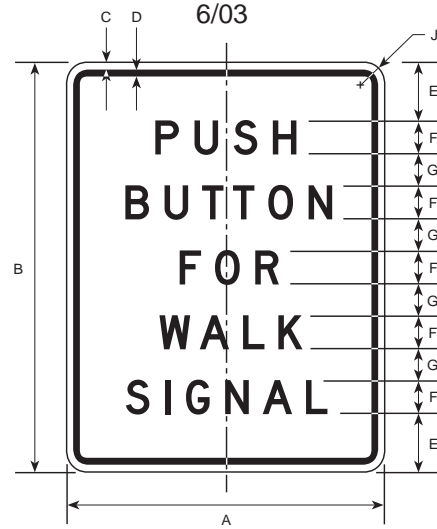

R10-3A

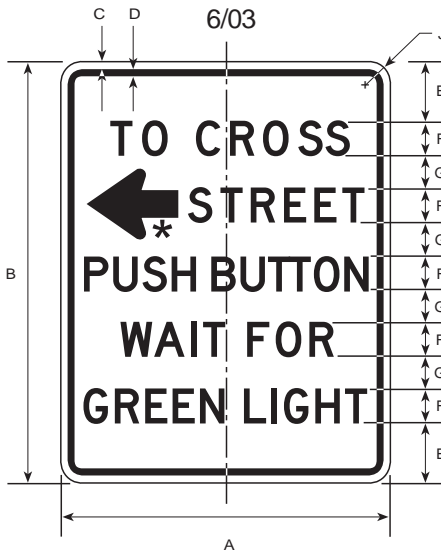

R10-4A

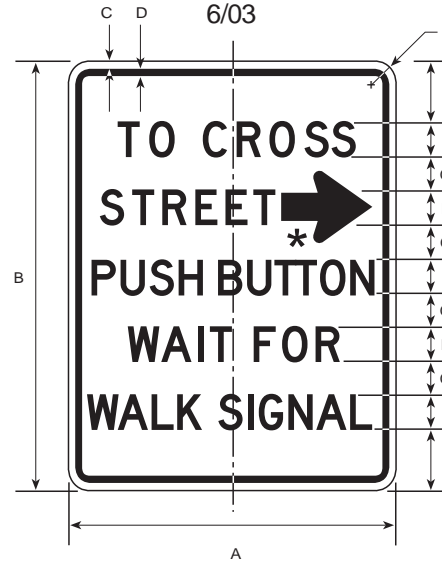

*SEE APPENDIX FOR STANDARD ARROW DETAILS

DIMENSIONS (MILLIMETERS)								
A	B	C	D	E	F	G	H	J
225	300	9	9	38	25D	25	25C	38

DIMENSIONS (INCHES)								
A	B	C	D	E	F	G	H	J
9	12	3/8	3/8	1 1/2	1D	1	1C	1 1/2

COLORS

LEGEND - BLACK (NON-REFL)
BACKGROUND - WHITE (REFL)

R10-4001

11/97

R10-4002

11/97

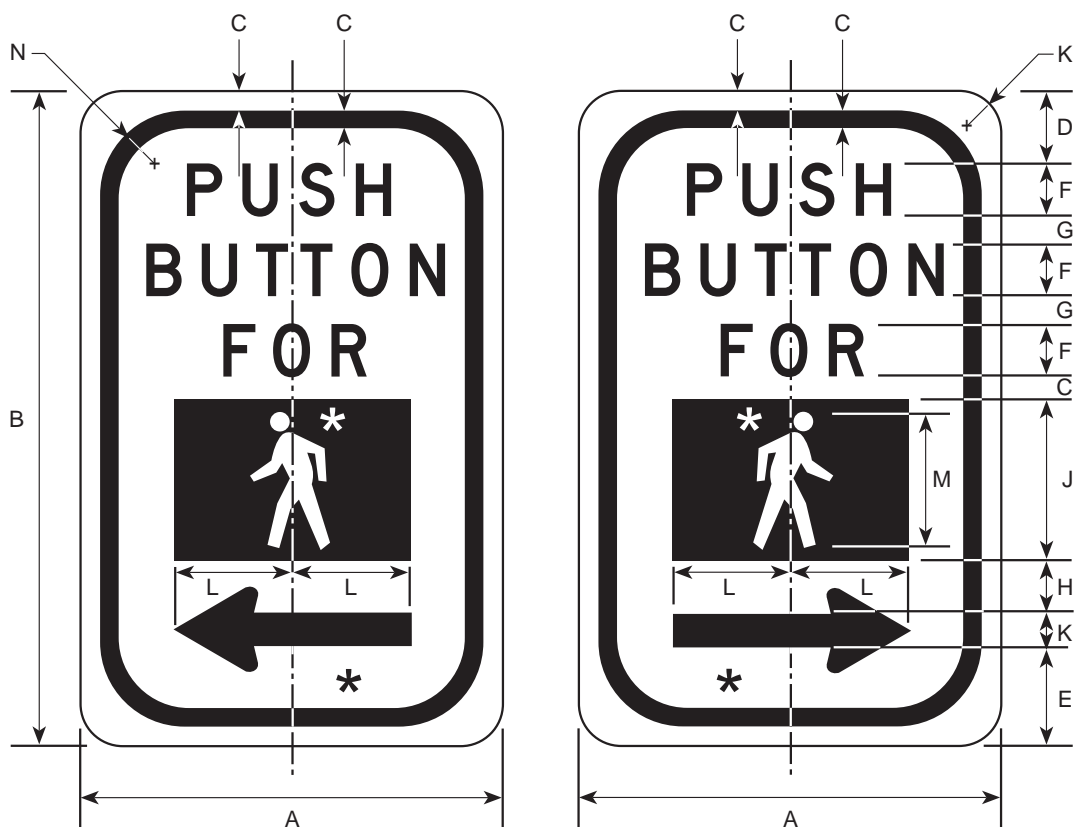

✱ See appendix for standard symbol details.

* See appendix for standard arrow details.

DIMENSIONS (MILLIMETERS)

A	B	C	D	E	F	G	H	J	K	L	M	N
125	194	6	22	28	16D	8	16	47	13	31	25	38

DIMENSIONS (INCHES)

A	B	C	D	E	F	G	H	J	K	L	M	N
5	7 3/4	1/4	7/8	1 1/8	5/8D	5/16	5/8	1 7/8	1/2	1 1/4	1 1/2	1

COLORS

LEGEND - BLACK (NON-REFL)

BACKGROUND - WHITE (REFL)

SYMBOL - WHITE (REFL)

R10-5

11/97



DIMENSIONS (MILLIMETERS)

A	B	C	D	E	F	G	H	J
450	600	9	16	75	75C	50	75D	38
600	750	9	16	81	100C	63	100D	38
750	900	13	19	106	125C	63	125D	47

DIMENSIONS (INCHES)

A	B	C	D	E	F	G	H	J
18	24	3/8	5/8	3	3C	2	3D	1 1/2
24	30	3/8	5/8	3 1/4	4C	2 1/2	4D	1 1/2
30	36	1/2	3/4	4 1/4	5C	2 1/2	5D	1 7/8

COLORS

LEGEND - BLACK (NON-REFL)
BACKGROUND - WHITE (REFL)

R10-6L & R10-6R

11/97

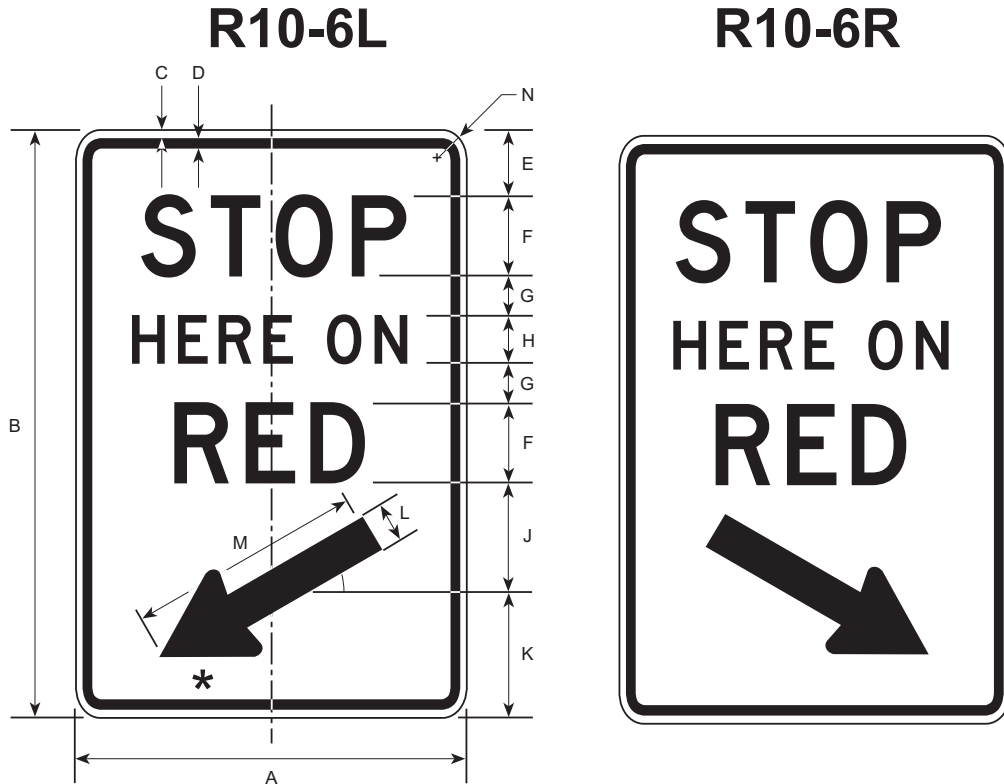

* See appendix for standard arrow details

DIMENSIONS (MILLIMETERS)												
A	B	C	D	E	F	G	H	J	K	L	M	N
600	900	9	16	100	125D	63	75D	163	188	66	366	38

DIMENSIONS (INCHES)												
A	B	C	D	E	F	G	H	J	K	L	M	N
24	36	3/8	5/8	4	5D	2 1/2	3D	6 1/2	7 1/2	2 5/8	14 5/8	1 1/2

COLORS

LEGEND — BLACK (NON-REFL)
BACKGROUND — WHITE (REFL)

R10-601L

3/06

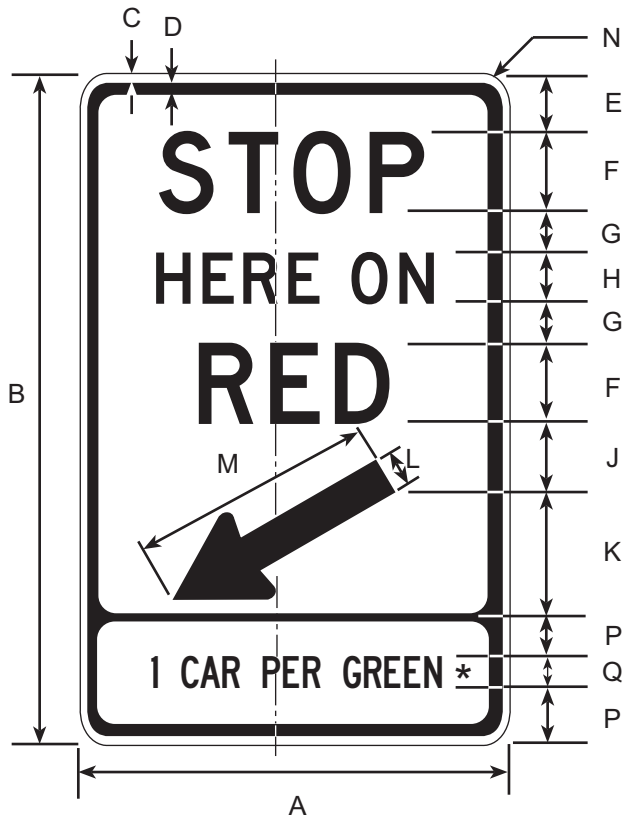

R10-601R



* - REDUCED SPACING

DIMENSIONS (MILLIMETERS)							
A	B	C	D	E	F	G	H
600	1050	9	16	100	125D	63	75D

J	K	L	M	N	P	Q
113	238	66	366	38	50	50C

DIMENSIONS (INCHES)							
A	B	C	D	E	F	G	H
24	42	3/8	5/8	4	5D	2 1/2	3D

J	K	L	M	N	P	Q
4 1/2	9 1/2	2 5/8	14 5/8	1 1/2	2	2C

COLORS

LEGEND — BLACK (NON-REFL)
BACKGROUND — WHITE (REFL)

R10-6A

11/97

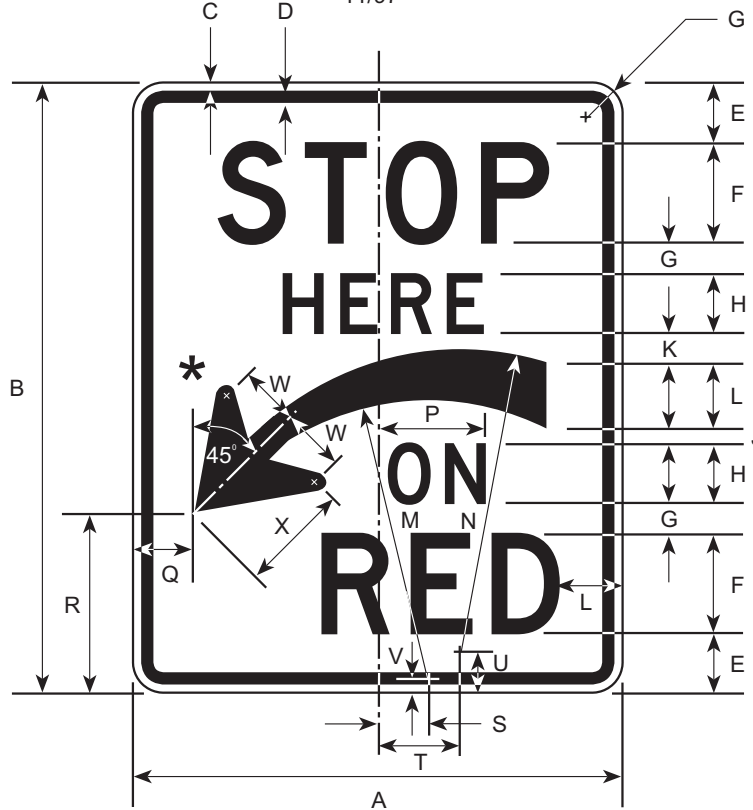

* See appendix for standard arrow details

DIMENSIONS (MILLIMETERS)										
A	B	C	D	E	F	G	H	J	K	L
600	750	9	16	75	125D	38	75D	13	31	81
M	N	P	Q	R	S	T	U	V	W	X
328	361	131	66	213	63	100	75D	19	80	134

DIMENSIONS (INCHES)										
A	B	C	D	E	F	G	H	J	K	L
24	30	3/8	5/8	3	5D	1 1/2	3D	1/2	1 1/4	3 1/4
M	N	P	Q	R	S	T	U	V	W	X
13 1/8	14 7/16	5 1/4	2 5/8	8 1/2	2 1/2	4	3D	3/4	3 3/16	5 3/8

COLORS

LEGEND — BLACK (NON-REFL)
 BACKGROUND — WHITE (REFL)

R10-601

5/03

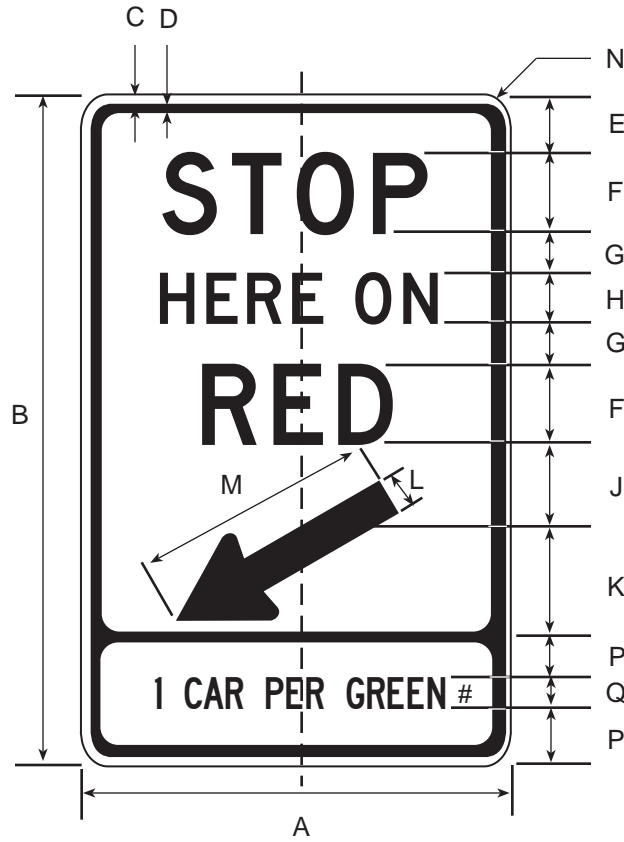

- REDUCED SPACING

DIMENSIONS (MILLIMETERS)							
A	B	C	D	E	F	G	H
600	1050	9	16	100	125D	63	75D
J	K	L	M	N	P	Q	
163	188	66	366	38	50	50C	

DIMENSIONS (INCHES)							
A	B	C	D	E	F	G	H
24	42	3/8	5/8	4	5D	2 1/2	3D
J	K	L	M	N	P	Q	
6 1/2	7 1/2	2 5/8	14 5/8	1 1/2	2	2C	

COLORS

LEGEND - BLACK (NON-REFL)
BACKGROUND - WHITE (REFL)

R10-7

11/97

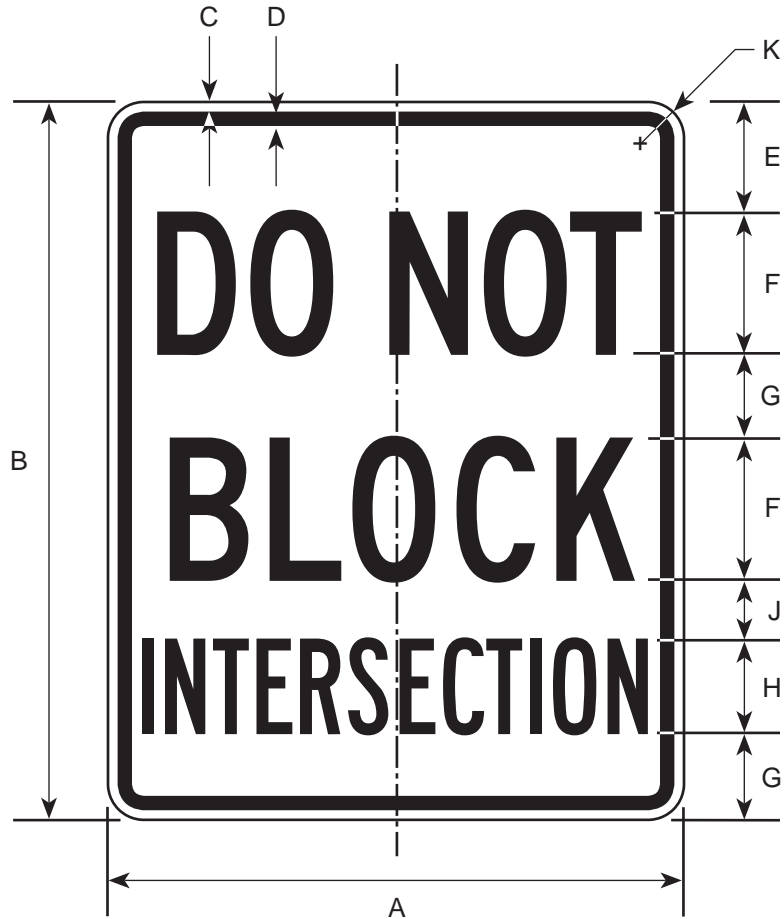

DIMENSIONS (MILLIMETERS)									
A	B	C	D	E	F	G	H	J	K
600	750	9	16	113	150C	88	100B	63	38

DIMENSIONS (INCHES)									
A	B	C	D	E	F	G	H	J	K
24	30	3/8	5/8	4 1/2	6C	3 1/2	4B	2 1/2	1 1/2

COLORS

LEGEND - BLACK (NON-REFL)
 BACKGROUND - WHITE (REFL)

R10-701

12/98

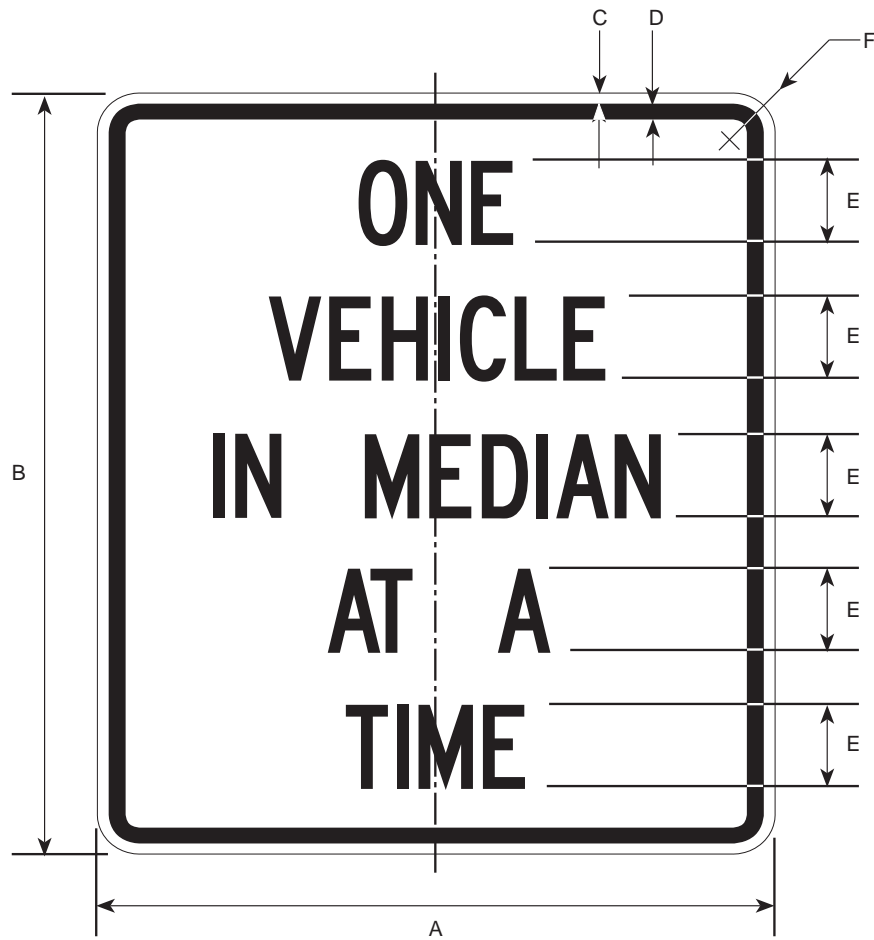

DIMENSIONS (MILLIMETERS)					
A	B	C	D	E	F
600	750	9	16	75C	38
900	1200	16	22	150C	56

DIMENSIONS (INCHES)					
A	B	C	D	E	F
24	30	3/8	5/8	3C	1 1/2
36	48	5/8	7/8	6C	2 1/4

COLORS

LEGEND - BLACK (NON-REFL)
BACKGROUND - WHITE (REFL)

R10-8

11/97

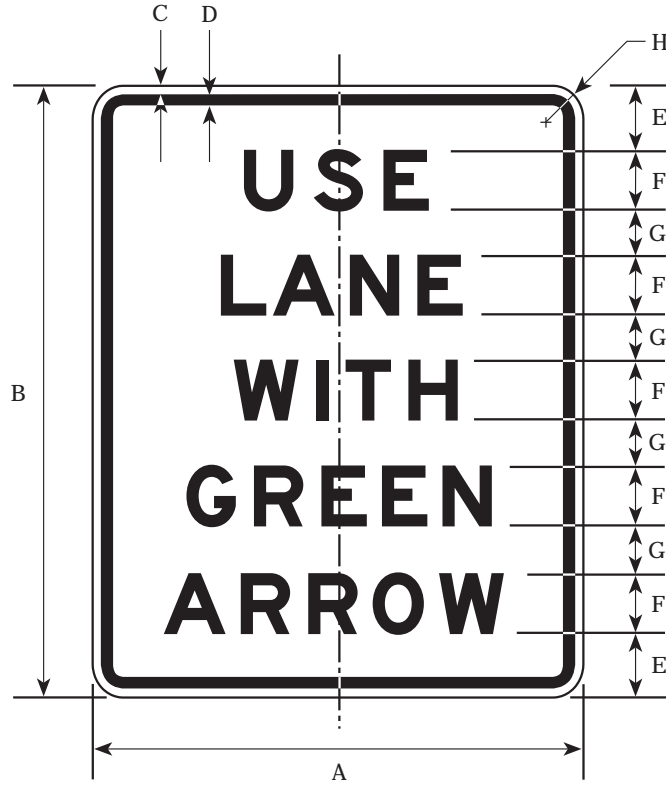

DIMENSIONS (MILLIMETERS)							
A	B	C	D	E	F	G	H
450	600	9	16	75	50E	50	38
600	750	9	16	75	75E	56	38
750	900	13	19	75	100E	63	47

DIMENSIONS (INCHES)							
A	B	C	D	E	F	G	H
18	24	3/8	5/8	3	2E	2	1 1/2
24	30	3/8	5/8	3	3E	2 1/4	1 1/2
30	36	1/2	3/4	3	4E	2 1/2	1 7/8

COLORS

LEGEND - BLACK (NON-REFL)
 BACKGROUND - WHITE (REFL)

R10-10 L / R

11/97

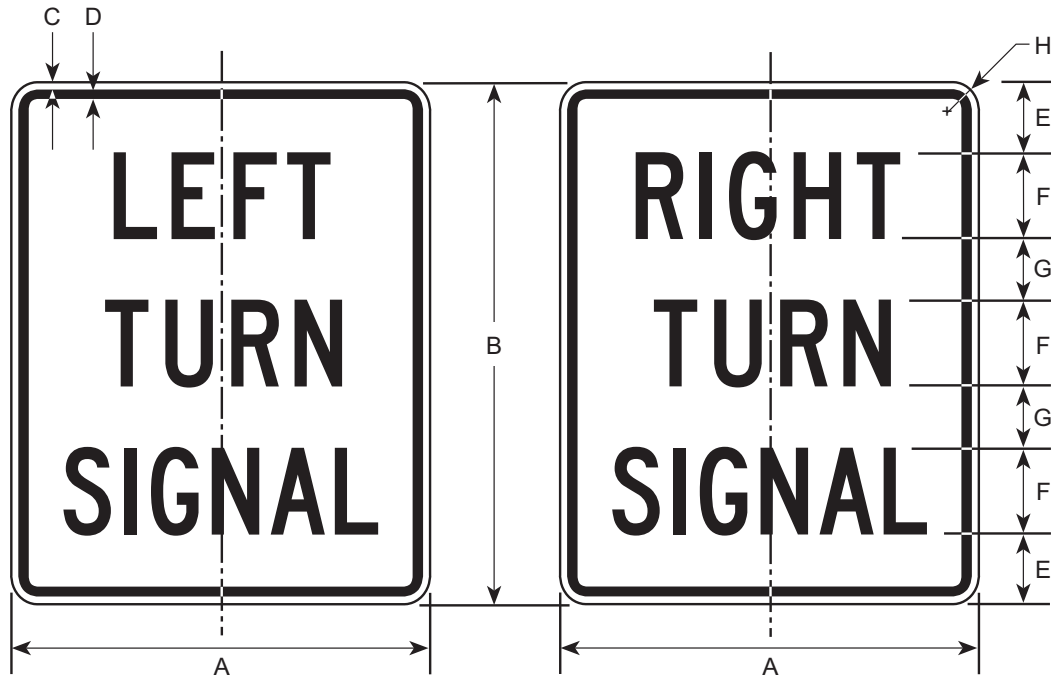

R10-10 L

R10-10 R

DIMENSIONS (MILLIMETERS)							
A	B	C	D	E	F	G	H
600	750	9	16	100	125C	88	38

DIMENSIONS (INCHES)							
A	B	C	D	E	F	G	H
24	30	3/8	5/8	4	5C	3 1/2	1 1/2

COLORS

LEGEND — BLACK (NON-REFL)
 BACKGROUND — WHITE (REFL)

R10-11

3/06

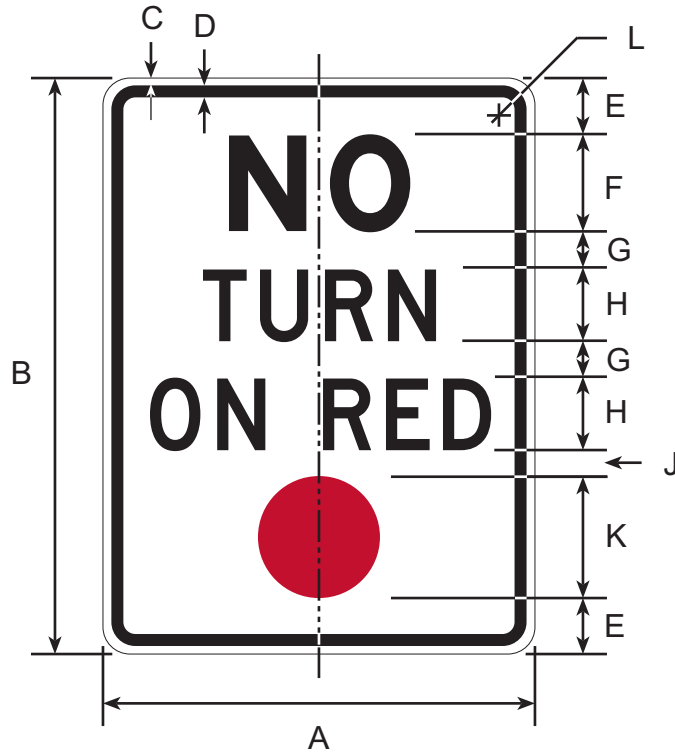

DIMENSIONS (MILLIMETERS)										
A	B	C	D	E	F	G	H	J	K	L
450	600	9	16	60	100E	44	75D	19	125	38
600	750	9	16	75	125E	50	100D	25	150	38
900	1200	16	22	106	200E	88	150D	38	250	56

DIMENSIONS (INCHES)										
A	B	C	D	E	F	G	H	J	K	L
18	24	3/8	5/8	2 3/8	4E	1 3/4	3D	3/4	5	1 1/2
24	30	3/8	5/8	3	5E	2	4D	1	6	1 1/2
36	48	5/8	7/8	4 1/4	8E	3 1/2	6D	1 1/2	10	2 1/4

COLORS

LEGEND - BLACK (NON-REFL)
 SYMBOL - RED (REFL)
 BACKGROUND - WHITE (REFL)

R10-11A

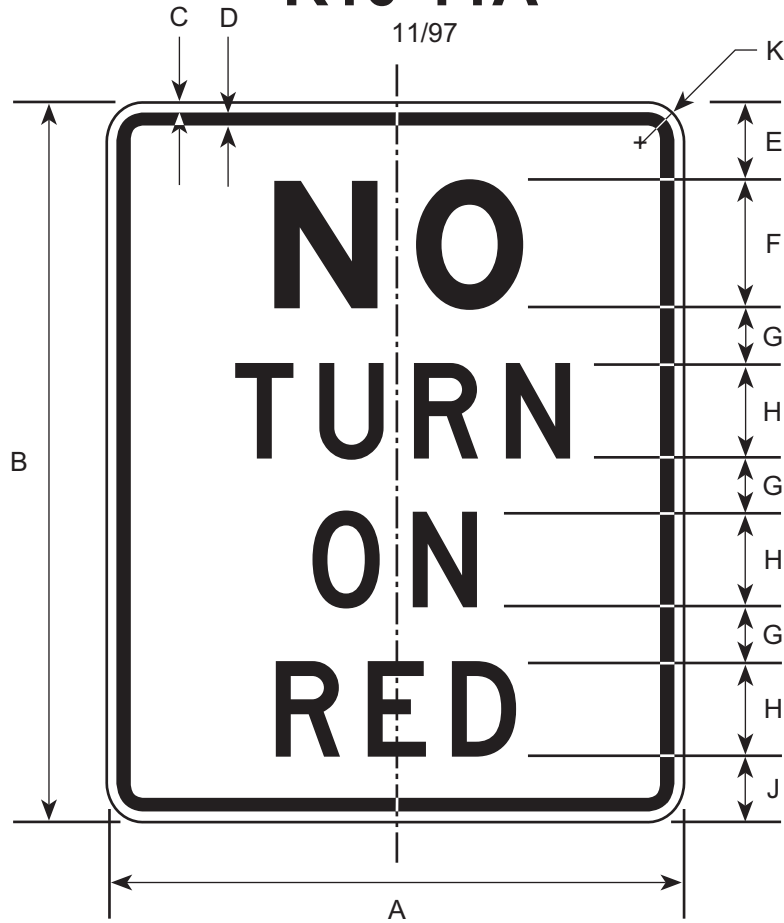

DIMENSIONS (MILLIMETERS)									
A	B	C	D	E	F	G	H	J	K
450	600	9	16	75	100E	44	75D	69	38
600	750	9	16	81	125E	56	100D	75	38
900	1200	16	22	150	200E	88	150D	138	56

DIMENSIONS (INCHES)									
A	B	C	D	E	F	G	H	J	K
18	24	3/8	5/8	3	4E	1 3/4	3D	2 3/4	1 1/2
24	30	3/8	5/8	3 1/4	5E	2 1/4	4D	3	1 1/2
36	48	5/8	7/8	6	8E	3 1/2	6D	5 1/2	2 1/4

COLORS

LEGEND — BLACK (NON-REFL)
 BACKGROUND — WHITE (REFL)

R10-11B

11/97

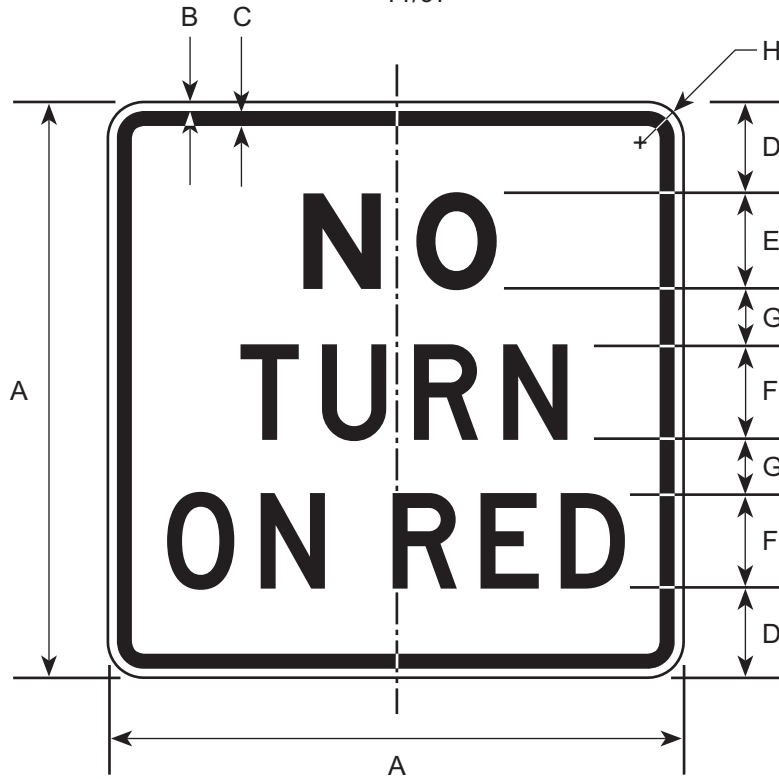

DIMENSIONS (MILLIMETERS)							
A	B	C	D	E	F	G	H
450	9	16	69	75E	75D	44	38
600	9	16	88	100E	100D	63	38
750	13	19	113	125E	125D	75	47

DIMENSIONS (INCHES)							
A	B	C	D	E	F	G	H
18	3/8	5/8	2 3/4	3E	3D	1 3/4	1 1/2
24	3/8	5/8	3 1/2	4E	4D	2 1/2	1 1/2
30	1/2	3/4	4 1/2	5E	5D	3	1 7/8

COLORS

LEGEND — BLACK (NON-REFL)
 BACKGROUND — WHITE (REFL)

R10-12

6/00

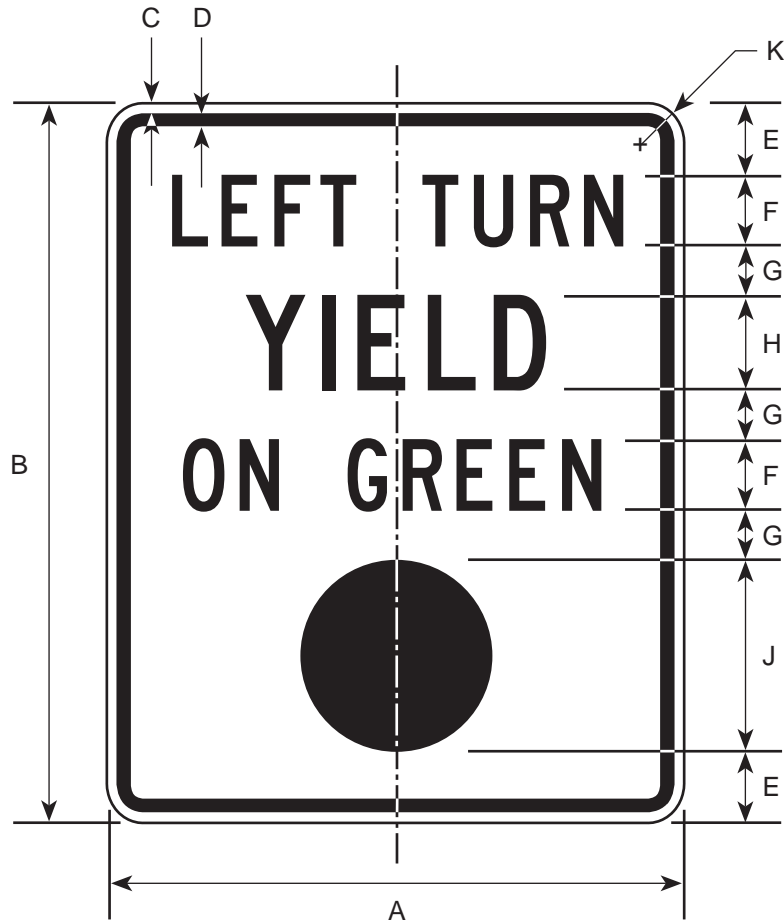

DIMENSIONS (MILLIMETERS)									
A	B	C	D	E	F	G	H	J	K
600	750	9	16	75	75C	50	100C	200	38
750	900	13	19	81	100C	62.5	125C	225	50

DIMENSIONS (INCHES)									
A	B	C	D	E	F	G	H	J	K
24	30	3/8	5/8	3	3C	2	4C	8	1 1/2
30	36	1/2	3/4	3 1/4	4C	2 1/2	5C	9	2

COLORS

SYMBOL - GREEN (REFL)
 LEGEND - BLACK (NON-REFL)
 BACKGROUND - WHITE (REFL)

R10-1201

11/97

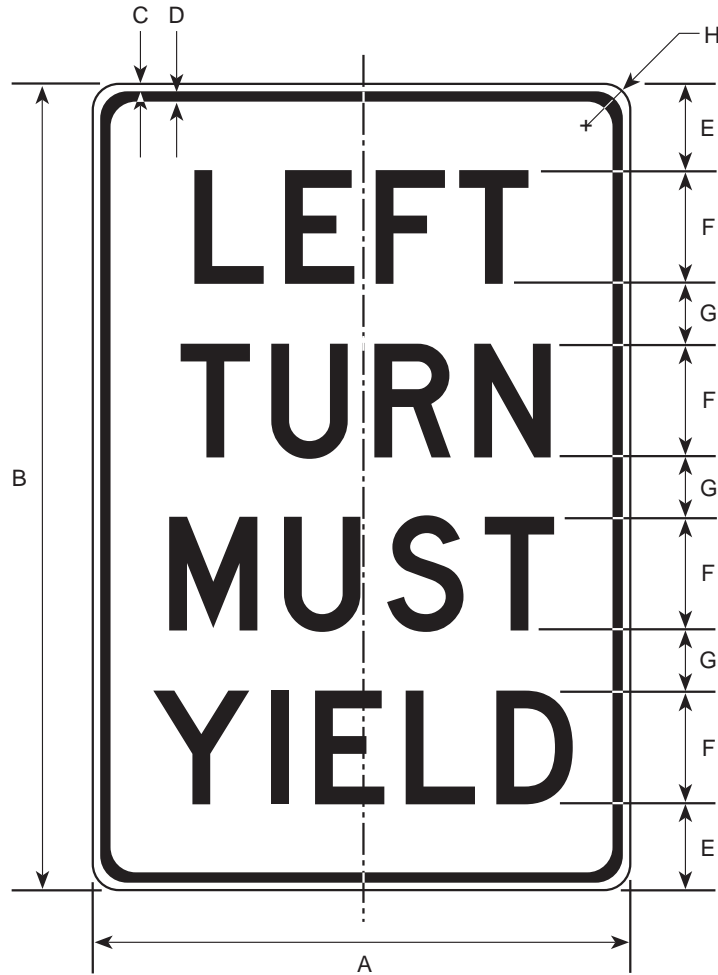

DIMENSIONS (MILLIMETERS)							
A	B	C	D	E	F	G	H
600	900	9	16	97	125D	69	38

DIMENSIONS (INCHES)							
A	B	C	D	E	F	G	H
24	36	3/8	5/8	3 7/8	5D	2 3/4	1 1/2

COLORS

LEGEND - BLACK (NON-REFL)
 BACKGROUND - WHITE (REFL)

R10-13

9/03

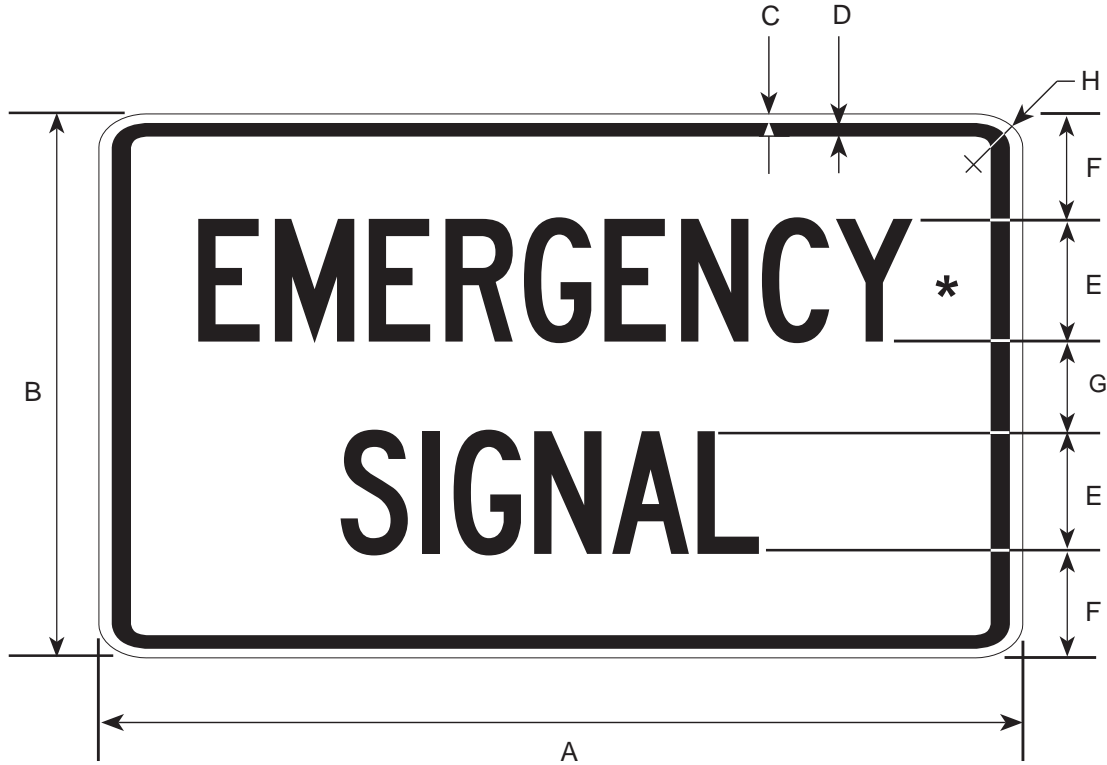

* - 30% REDUCE SPACING

DIMENSIONS (MILLIMETERS)							
A	B	C	D	E	G	F	H
750	450	9	16	125C	125	100	38

DIMENSIONS (INCHES)							
A	B	C	D	E	F	G	H
36	24	1/2	3/4	5C	5	4	2 1/4

COLORS

LEGEND - BLACK (NON-REFL)
BACKGROUND - WHITE (REFL)

R10-1401

5/03

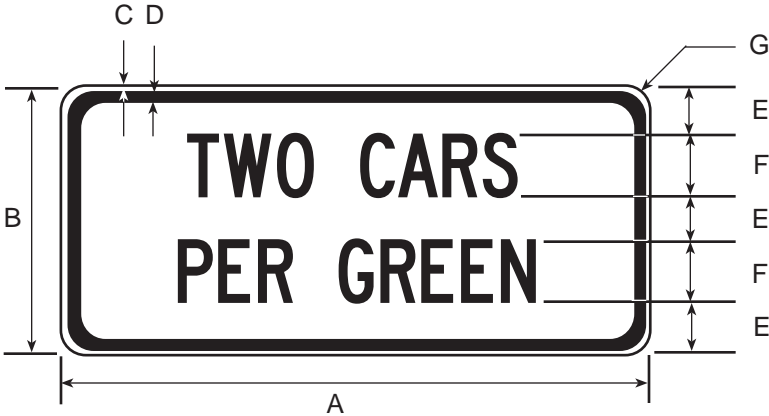

DIMENSIONS (MILLIMETERS)						
A	B	C	D	E	F	G
600	300	9	16	50	75C	25

DIMENSIONS (INCHES)						
A	B	C	D	E	F	G
24	12	3/8	5/8	2	3C	1

COLORS

LEGEND - BLACK (NON-REFL)
 BACKGROUND - WHITE (REFL)

R10-1402

5/03

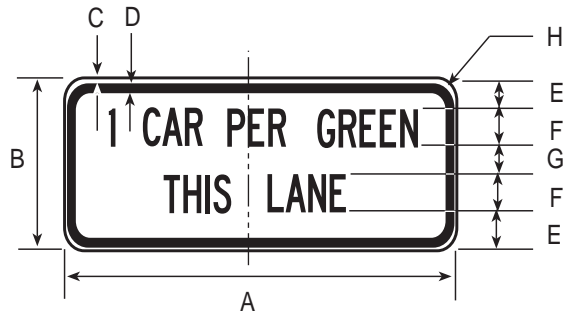

R10-1403

5/03

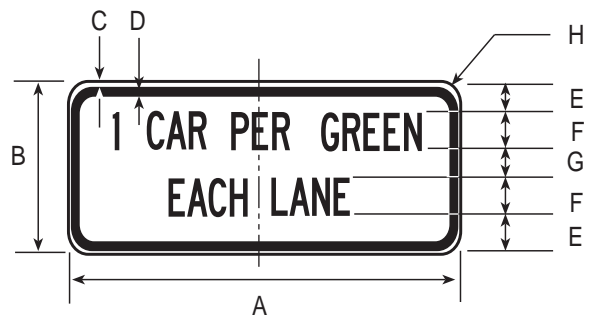

DIMENSIONS (MILLIMETERS)							
A	B	C	D	E	F	G	H
1200	450	16	22	88	100C	75	56

DIMENSIONS (INCHES)							
A	B	C	D	E	F	G	H
48	18	5/8	7/8	3 1/2	4C	3	2 1/4

COLORS

LEGEND - BLACK (NON-REFL)
BACKGROUND - WHITE (REFL)

R10-1404

5/03

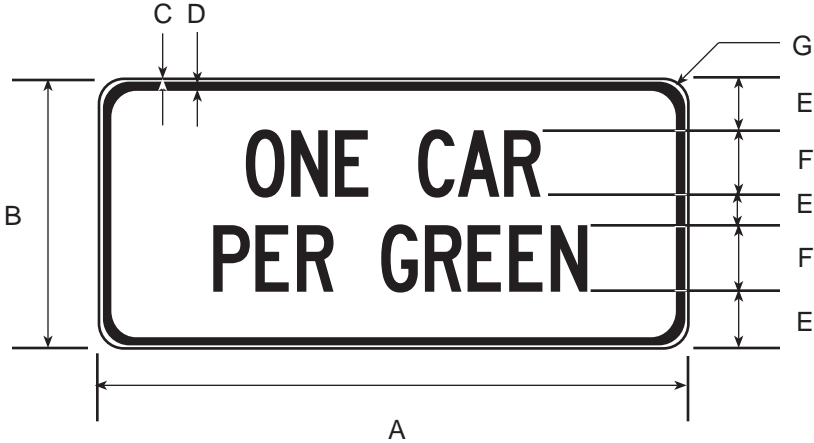

DIMENSIONS (MILLIMETERS)						
A	B	C	D	E	F	G
600	300	9	16	50	75C	38

DIMENSIONS (INCHES)						
A	B	C	D	E	F	G
24	12	3/8	5/8	2	3C	1 1/2

COLORS
 LEGEND - BLACK (NON-REFL)
 BACKGROUND - WHITE (REFL)

R10-1405

5/03

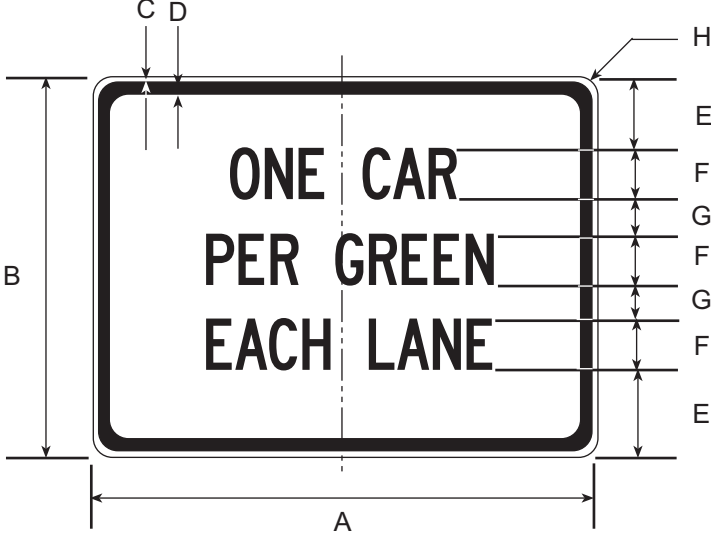

DIMENSIONS (MILLIMETERS)							
A	B	C	D	E	F	G	H
600	450	9	16	63	75C	50	38

DIMENSIONS (INCHES)							
A	B	C	D	E	F	G	H
24	18	3/8	5/8	2 1/2	3C	2	1 1/2

COLORS
 LEGEND - BLACK (NON-REFL)
 BACKGROUND - WHITE (REFL)

R10-15

3/06

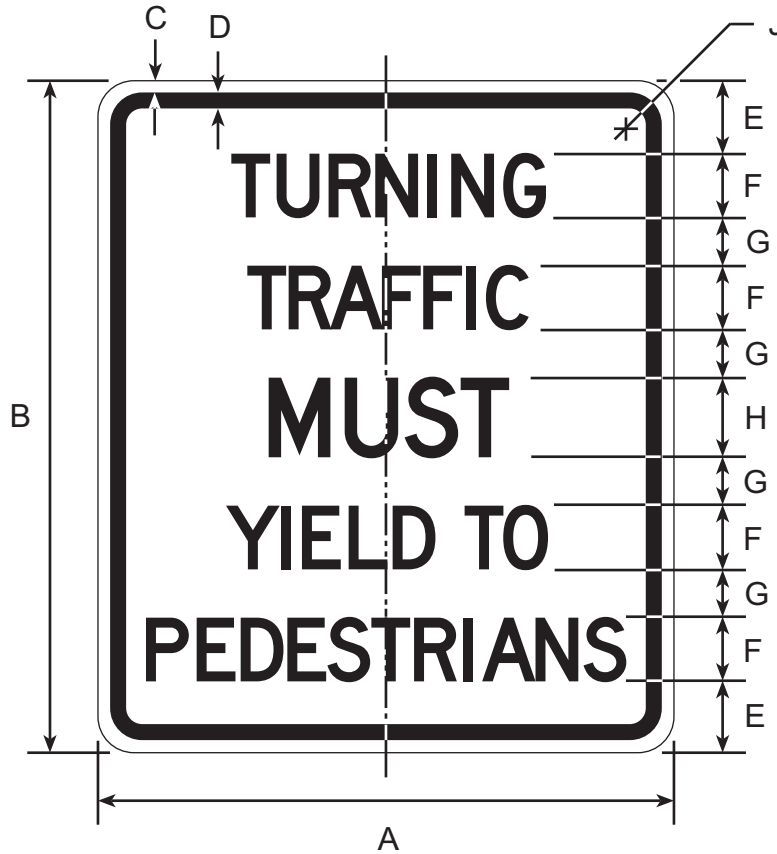

DIMENSIONS (MILLIMETERS)								
A	B	C	D	E	F	G	H	J
600	750	9	16	106	62D	50	88	38
750	900	13	19	113	75D	69	100	47
900	1050	16	22	113	100D	75	125	56

DIMENSIONS (INCHES)								
A	B	C	D	E	F	G	H	J
24	30	3/8	5/8	4 1/4	2 1/2D	2	3 1/2D	1 1/2
30	36	1/2	3/4	4 1/2	3D	2 3/4	4D	1 7/8
36	42	5/8	7/8	4 1/2	4D	3	5D	2 1/4

COLORS

LEGEND - BLACK (NON-REFL)
BACKGROUND - WHITE (REFL)

R10-16

3/06

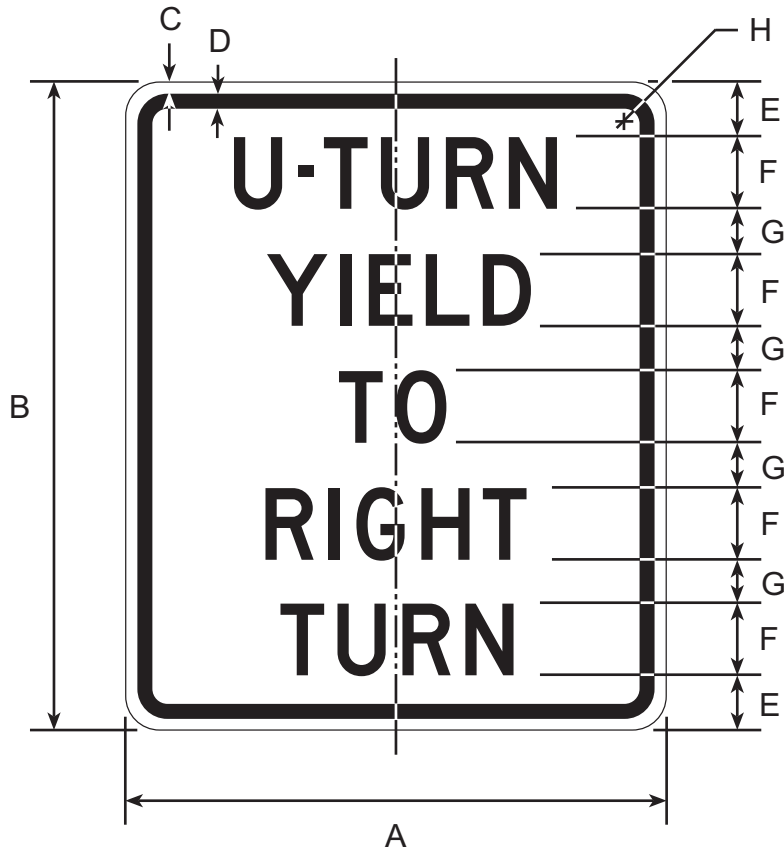

DIMENSIONS (MILLIMETERS)							
A	B	C	D	E	F	G	H
450	600	9	16	75	50D	50	38
600	750	9	16	75	75D	56	38
750	900	13	19	75	100D	62	47

DIMENSIONS (INCHES)							
A	B	C	D	E	F	G	H
18	24	3/8	5/8	3	2D	2	1 1/2
24	30	3/8	5/8	3	3D	2 1/4	1 1/2
30	36	1/2	3/4	3	4D	2 1/2	1 7/8

COLORS

LEGEND - BLACK (NON-REFL)
 BACKGROUND - WHITE (REFL)

R10-17A

3/06

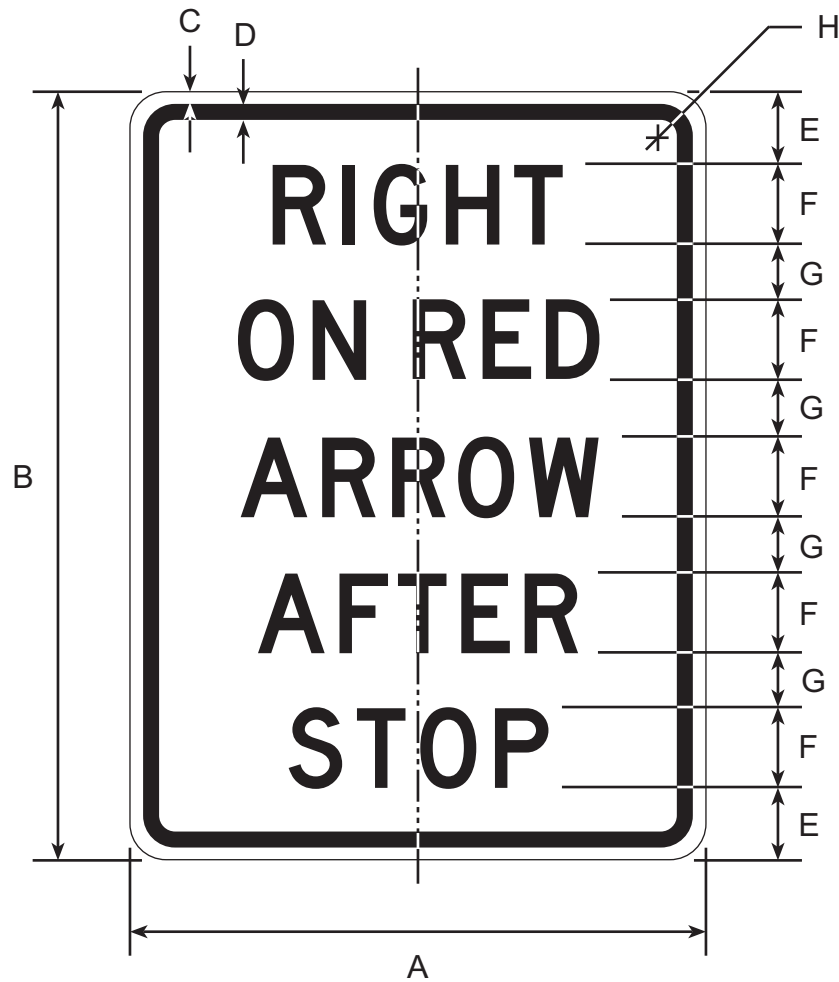

DIMENSIONS (MILLIMETERS)							
A	B	C	D	E	F	G	H
750	900	13	19	88	100D	56	47
900	1200	16	22	113	125D	88	56

DIMENSIONS (INCHES)							
A	B	C	D	E	F	G	H
30	36	1/2	3/4	3 1/2	4D	2 1/4	1 7/8
36	48	5/8	7/8	4 1/2	5D	3 1/2	2 1/4

COLORS

LEGEND - BLACK (NON-REFL)
BACKGROUND - WHITE (REFL)

R10-18

3/06

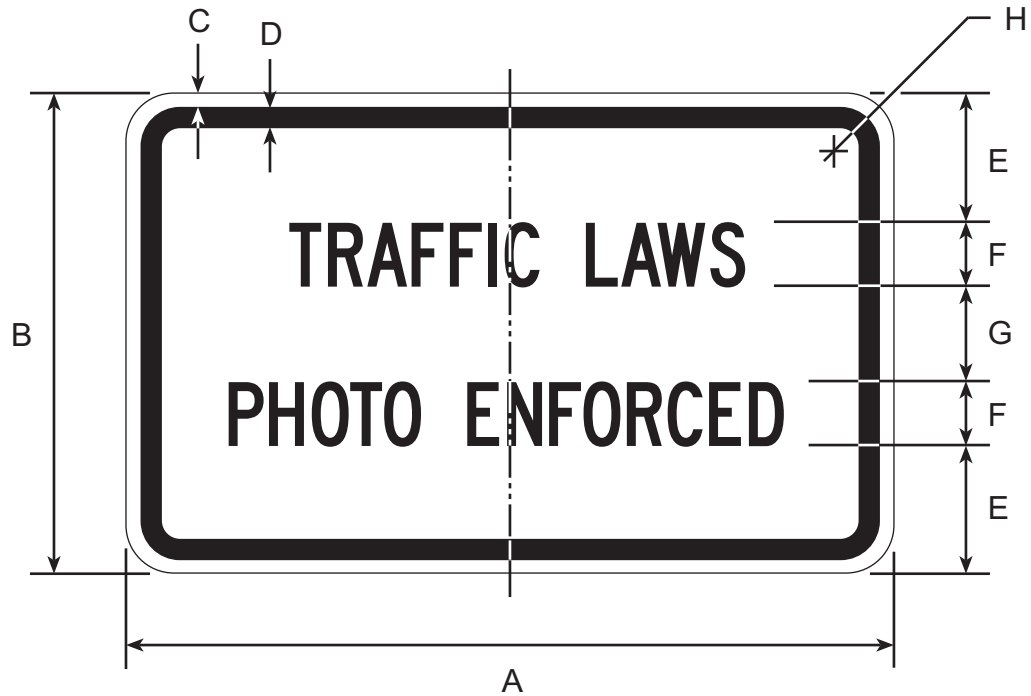

DIMENSIONS (MILLIMETERS)							
A	B	C	D	E	F	G	H
600	300	9	16	75	50C	50	38
900	450	16	22	113	75C	75	56
1200	750	19	31	200	100C	150	75
1800	900	25	31	225	150C	150	75

DIMENSIONS (INCHES)							
A	B	C	D	E	F	G	H
24	12	3/8	5/8	3	2C	2	1 1/2
36	18	5/8	7/8	4 1/2	3C	3	2 1/4
48	30	3/4	1 1/4	8	4C	6	3
72	36	1	1 1/4	9	6C	6	3

COLORS

LEGEND - BLACK (NON-REFL)
BACKGROUND - WHITE (REFL)

R10-19

3/06

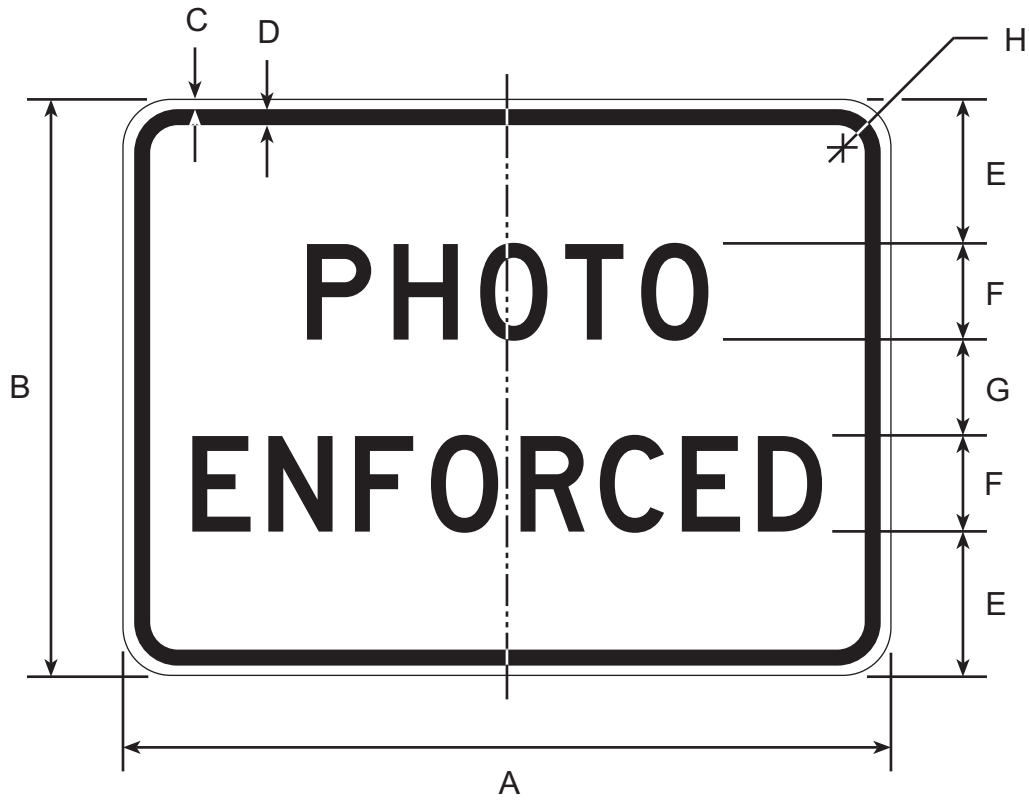

DIMENSIONS (MILLIMETERS)							
A	B	C	D	E	F	G	H
600	450	9	16	113	75D	75	38
900	750	16	22	200	100D	150	56
1200	900	19	31	225	150D	150	75

DIMENSIONS (INCHES)							
A	B	C	D	E	F	G	H
24	18	3/8	5/8	4 1/2	3D	3	1 1/2
36	30	5/8	7/8	8	4D	6	2 1/4
48	36	3/4	1 1/4	9	6D	6	3

COLORS

LEGEND - BLACK (NON-REFL)
BACKGROUND - WHITE (REFL)

R10-20A

3/06

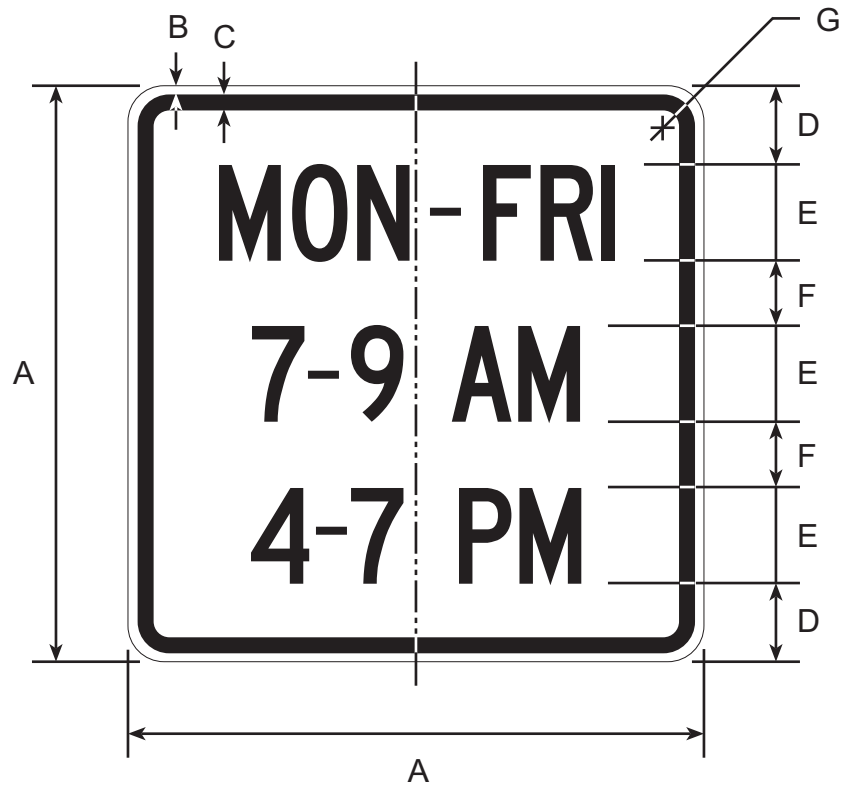

DIMENSIONS (MILLIMETERS)						
A	B	C	D	E	F	G
600	9	16	88	100C	62	38
750	13	19	113	125C	75	47
1200	19	31	175	200C	125	75

DIMENSIONS (INCHES)						
A	B	C	D	E	F	G
24	3/8	5/8	3 1/2	4C	2 1/2	1 1/2
30	1/2	3/4	4 1/2	5C	3	1 7/8
48	3/4	1 1/4	7	8C	5	3

COLORS

LEGEND - BLACK (NON-REFL)
BACKGROUND - WHITE (REFL)

R10-20B

3/06

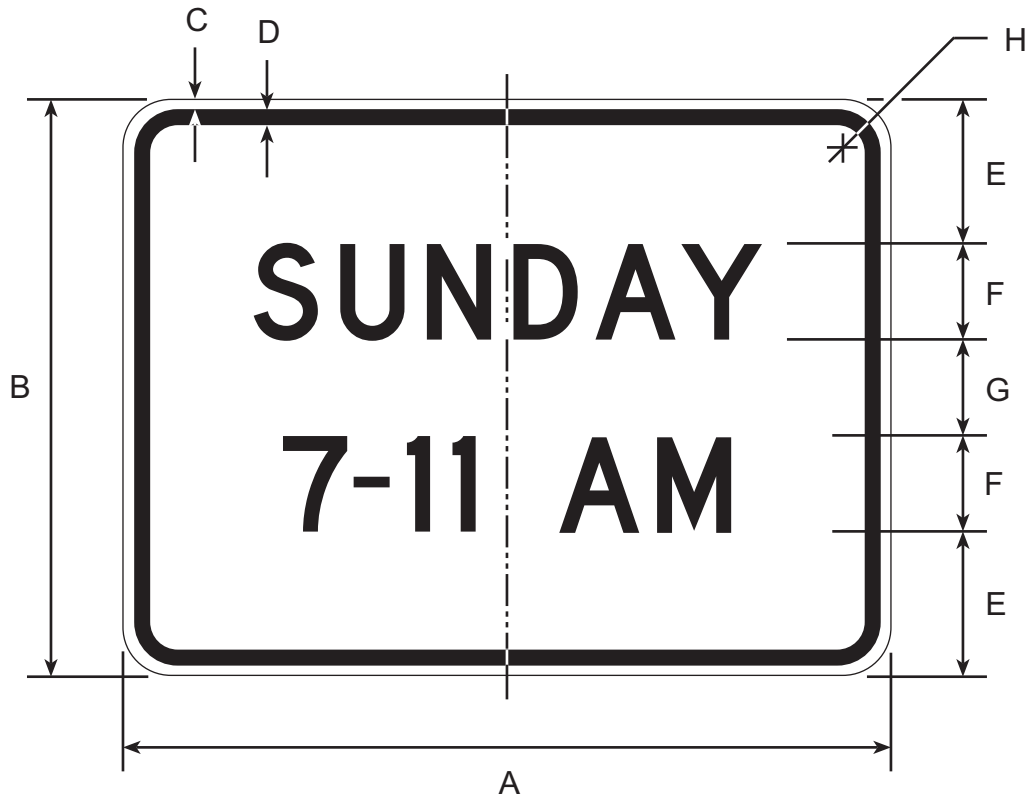

DIMENSIONS (MILLIMETERS)							
A	B	C	D	E	F	G	H
600	450	9	16	113	75D	75	38
750	600	13	19	150	100D	100	47
1200	900	19	31	225	150D	150	75

DIMENSIONS (INCHES)							
A	B	C	D	E	F	G	H
24	18	3/8	5/8	4 1/2	3D	3	1 1/2
30	24	1/2	3/4	6	4D	4	1 7/8
48	36	3/4	1 1/4	9	6D	6	3

COLORS

LEGEND - BLACK (NON-REFL)
BACKGROUND - WHITE (REFL)

R10-21

3/06

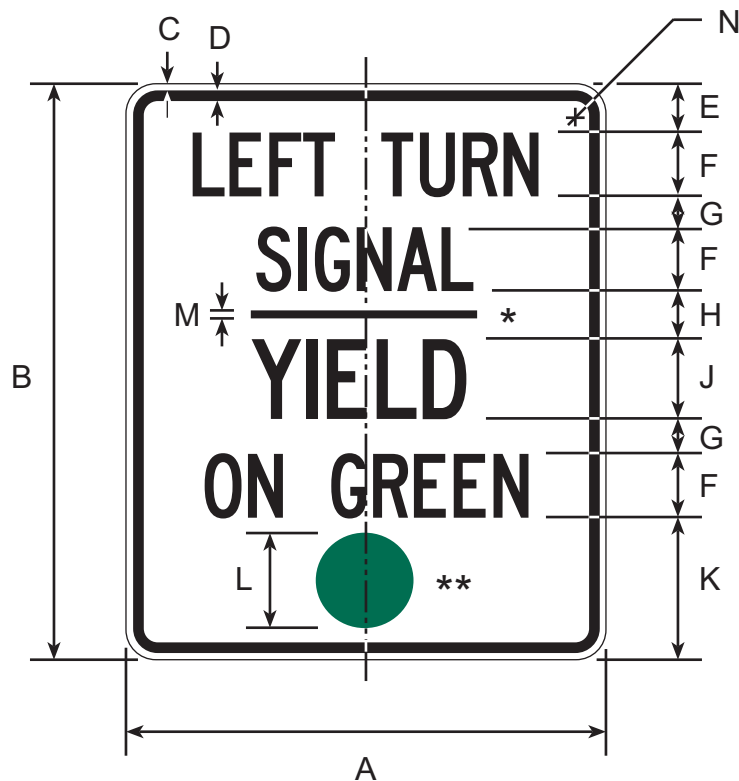

* Optically center between lines 2 & 3

** Optically center between line 4 & bottom border

DIMENSIONS (MILLIMETERS)												
A	B	C	D	E	F	G	H	J	K	L	M	N
450	600	9	16	50	62C	25	62	75C	175	125	9	38
600	750	9	16	62	75C	41	75	100C	206	150	16	38
750	900	13	19	75	100C	50	75	125C	225	175	19	47

DIMENSIONS (INCHES)												
A	B	C	D	E	F	G	H	J	K	L	M	N
18	24	3/8	5/8	2	2 1/2C	1	2 1/2	3C	7	5	3/8	1 1/2
24	30	3/8	5/8	2 1/2	3C	1 5/8	3	4C	8 1/4	6	5/8	1 1/2
30	36	1/2	3/4	3	4C	2	3	5C	9	7	3/4	1 7/8

COLORS

LEGEND - BLACK (NON-REFL)
 BALL - GREEN (REFL)
 BACKGROUND - WHITE (REFL)

R10-22

3/06

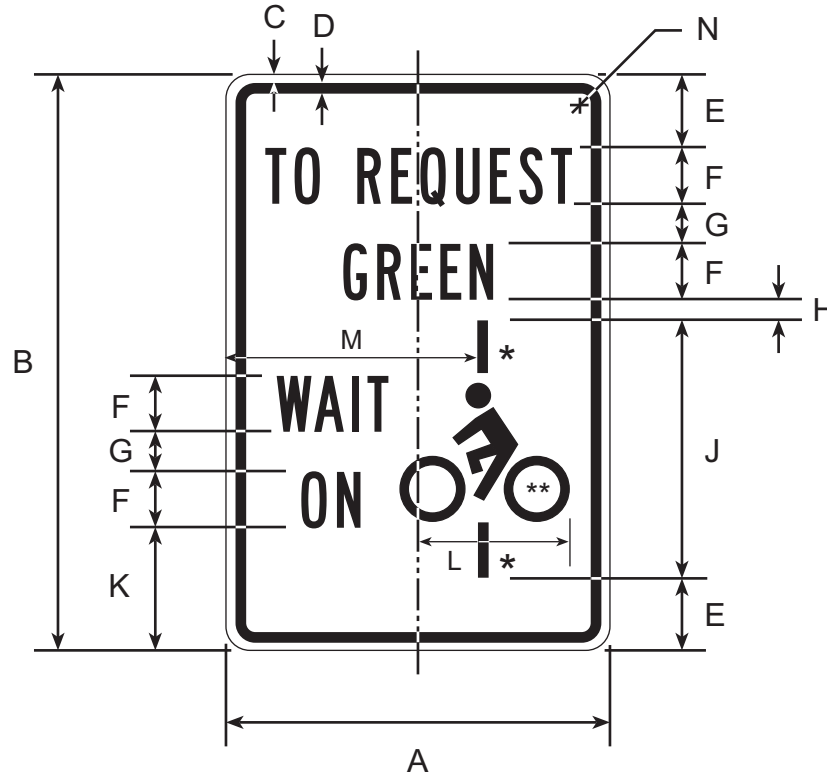

* Pavement marking depictions (2) are 1/2" x 1 3/4"

** See appendix for bicyclist symbol pattern

DIMENSIONS (MILLIMETERS)												
A	B	C	D	E	F	G	H	J	K	L	M	N
300	450	9	11	56	44B	31	25	200	97	116	175	38

DIMENSIONS (INCHES)												
A	B	C	D	E	F	G	H	J	K	L	M	N
12	18	3/8	7/16	2 1/4	1 3/4B	1 1/4	1	8	3 7/8	4 5/8	7	1 1/2

COLORS

LEGEND & SYMBOL - BLACK (NON-REFL)
 BACKGROUND - WHITE (REFL)

R11-1

11/97

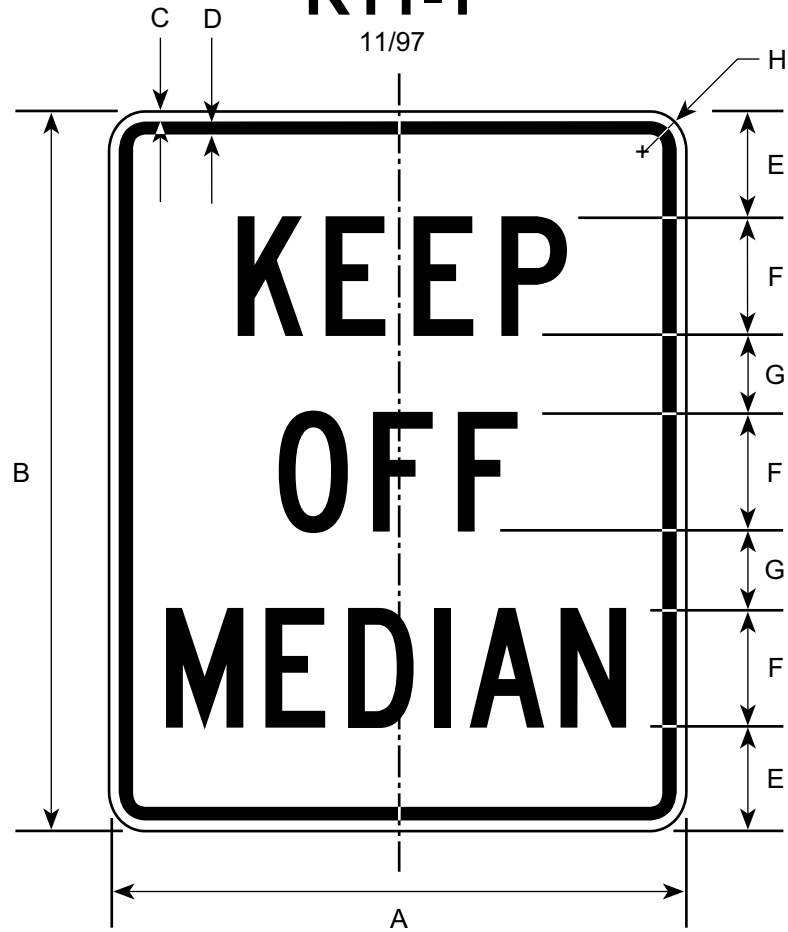

DIMENSIONS (MILLIMETERS)							
A	B	C	D	E	F	G	H
600	750	9	16	106	125C	81	38
900	1200	16	22	169	200C	131	56
1200	1500	19	31	213	250C	163	75

DIMENSIONS (INCHES)							
A	B	C	D	E	F	G	H
24	30	3/8	5/8	4 1/4	5C	3 1/4	1 1/2
36	48	5/8	7/8	6 3/4	8C	5 1/4	2 1/4
48	60	3/4	1 1/4	8 1/2	10C	6 1/2	3

COLORS

LEGEND — BLACK (NON-REFL)
 BACKGROUND — WHITE (REFL)

R11-2

11/97



DIMENSIONS (MILLIMETERS)							
A	B	C	D	E	F	G	H
1200	750	13	19	125	200D	100	47

DIMENSIONS (INCHES)							
A	B	C	D	E	F	G	H
48	30	1/2	3/4	5	8D	4	1 7/8

COLORS

LEGEND - BLACK (NON-REFL)
 BACKGROUND - WHITE (REFL)

R11-201

11/03

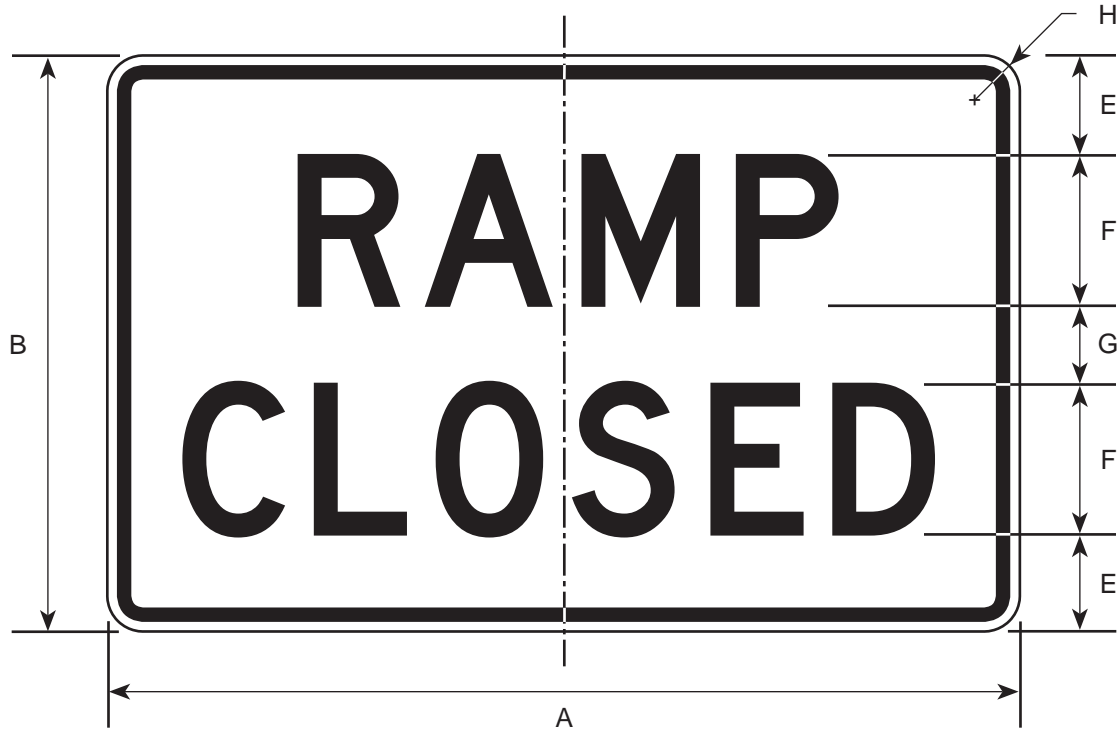

DIMENSIONS (MILLIMETERS)							
A	B	C	D	E	F	G	H
1200	750	13	19	125	200D	100	47

DIMENSIONS (INCHES)							
A	B	C	D	E	F	G	H
48	30	1/2	3/4	5	8D	4	1 7/8

COLORS

LEGEND - BLACK (NON-REFL)
BACKGROUND - WHITE (REFL)

R11-3

11/97

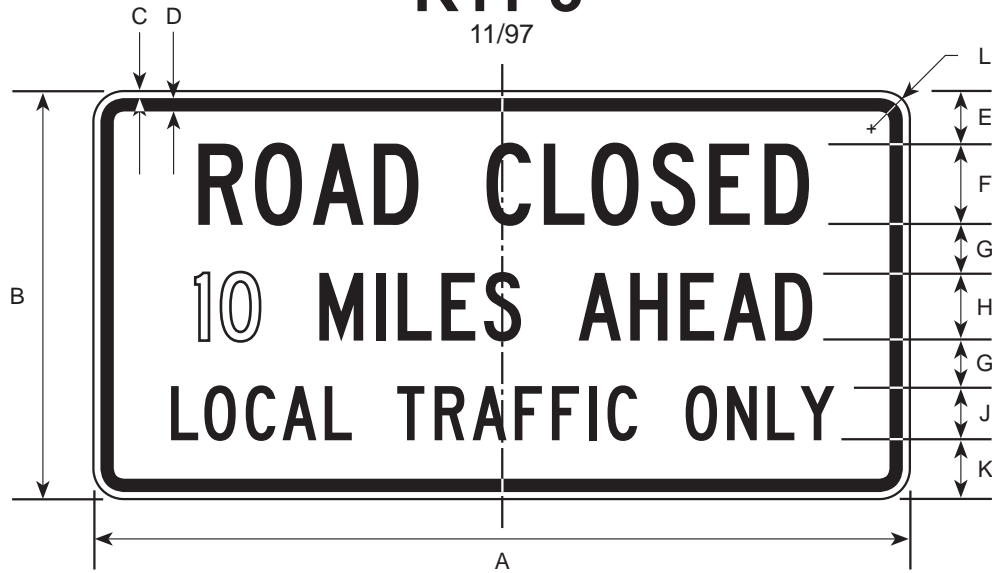

R11-3A

11/97

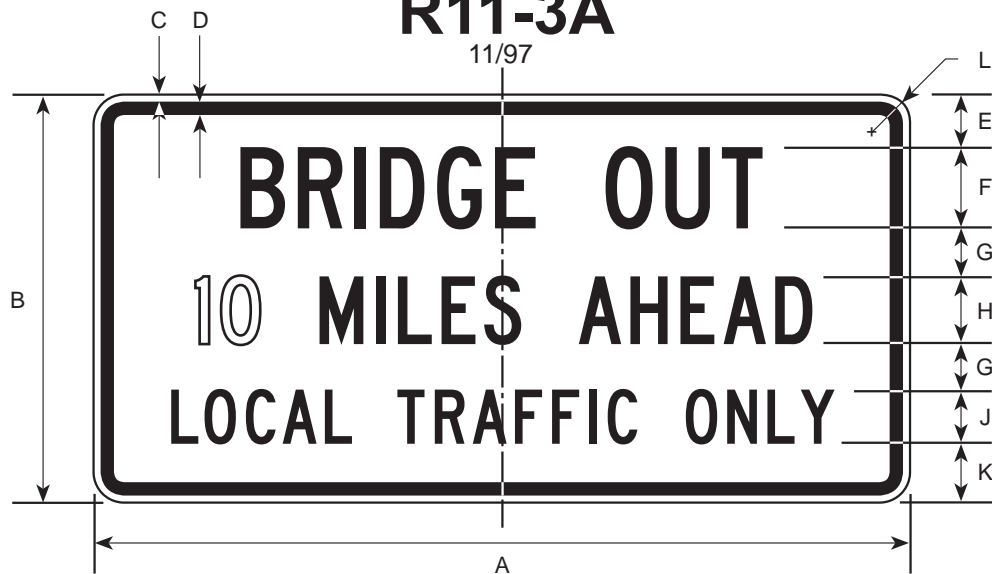

DIMENSIONS (MILLIMETERS)

A	B	C	D	E	F	G	H	J	K	L
1500	750	13	19	100	150C	84	125C	100C	106	47

DIMENSIONS (INCHES)

A	B	C	D	E	F	G	H	J	K	L
60	30	1/2	3/4	4	6C	3 3/8	5C	4C	4 1/4	1 7/8

COLORS

LEGEND - BLACK (NON-REFL)
BACKGROUND - WHITE (REFL)

R11-3 (MOD.)

11/97



DIMENSIONS (MILLIMETERS)						
A	B	C	D	E	F	G
1500	1200	9	150D	200D	200C	100C

DIMENSIONS (INCHES)						
A	B	C	D	E	F	G
600	48	3/8	6D	8D	5C	4C

COLORS

LEGEND - BLACK (NON-REFL.)
BACKGROUND - WHITE (REFL.)

R11-4

11/97

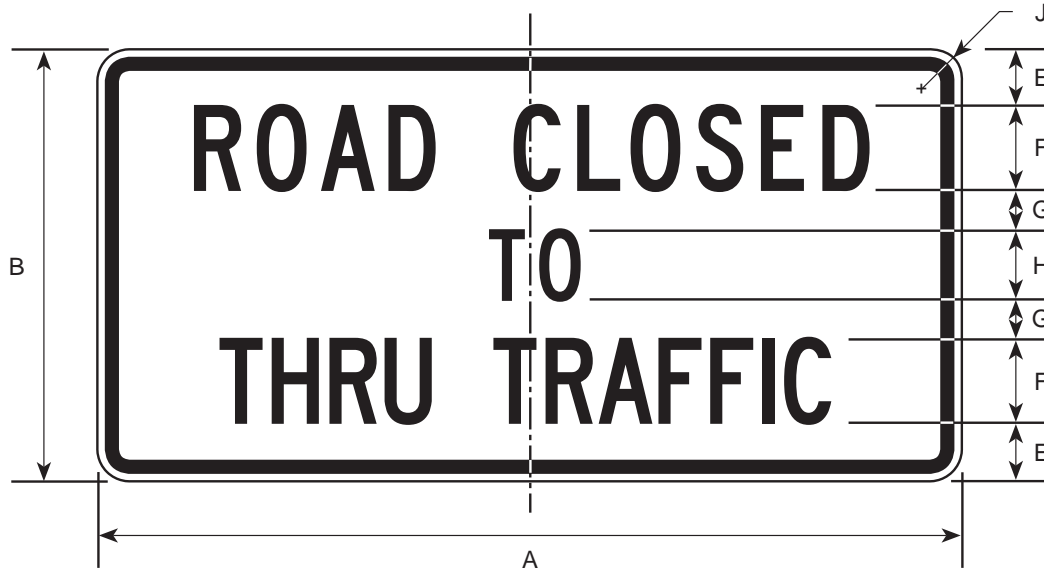

DIMENSIONS (MILLIMETERS)								
A	B	C	D	E	F	G	H	J
1500	750	13	19	100	150C	63	125C	47

DIMENSIONS (INCHES)								
A	B	C	D	E	F	G	H	J
60	30	1/2	3/4	4	6C	2 1/2	5C	1 7/8

COLORS

LEGEND - BLACK (NON-REFL)
 BACKGROUND - WHITE (REFL)

R11-501

11/97

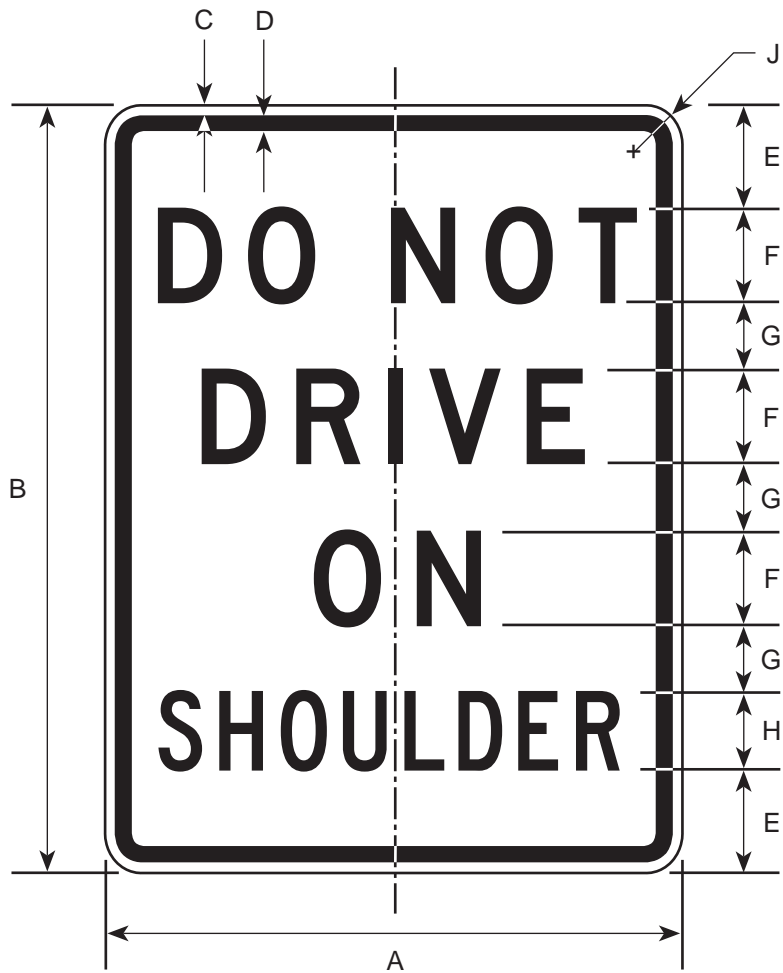

DIMENSIONS (MILLIMETERS)								
A	B	C	D	E	F	G	H	J
900	1200	13	19	163	150D	100	125C	47

DIMENSIONS (INCHES)								
A	B	C	D	E	F	G	H	J
36	48	1/2	3/4	6 1/2	6D	4	5C	1 7/8

COLORS

LEGEND - BLACK (NON-REFL)
 BACKGROUND - WHITE (REFL)

R11-1501

11/97

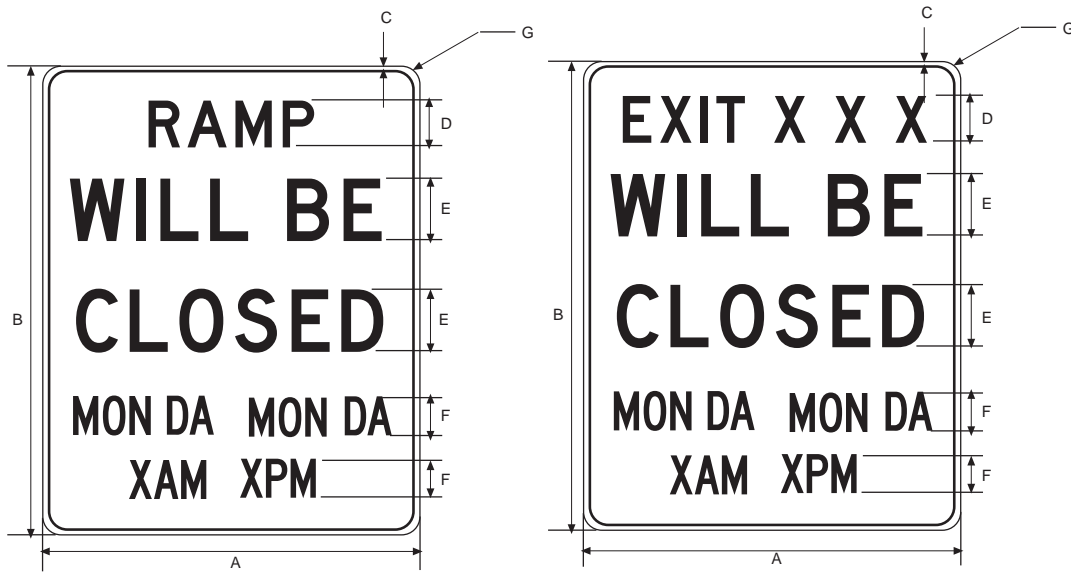

DIMENSIONS (MILLIMETERS)						
A	B	C	D	E	F	G
1200	1500	18.75	150D	200D	125C	100

DIMENSIONS (INCHES)						
A	B	C	D	E	F	G
48	60	3/4	6D	8D	5C	4

COLORS

LEGEND - BLACK (NON-REFL)

BACKGROUND - WHITE (REFL)

R12-1

11/97

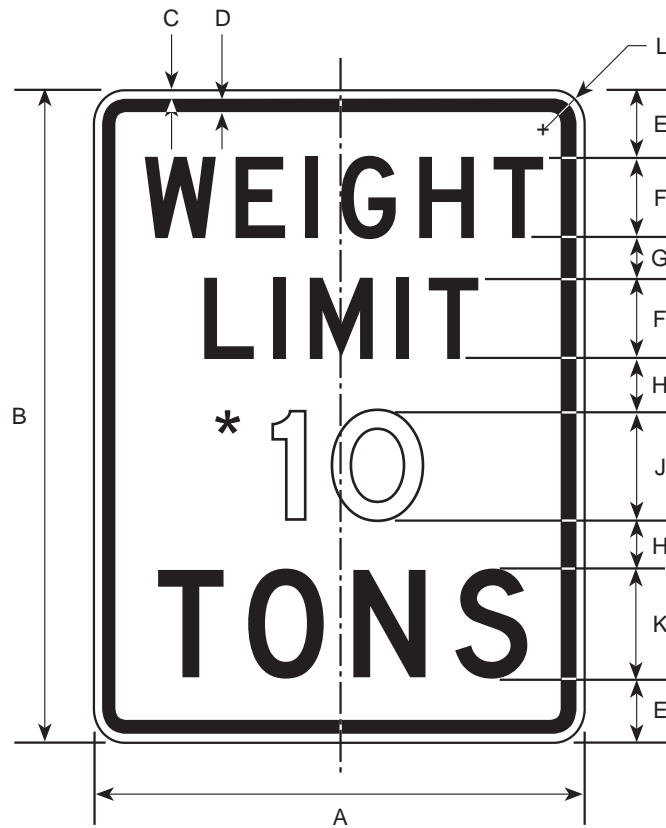

* Optically space numerals about vertical centerline.

DIMENSIONS (MILLIMETERS)										
A	B	C	D	E	F	G	H	J	K	L
600	750	9	16	75	100D	44	53	125E	125D	38
900	1200	16	22	119	150D	75	94	200E	200D	56

DIMENSIONS (INCHES)										
A	B	C	D	E	F	G	H	J	K	L
24	30	3/8	5/8	3	4D	1 3/4	2 1/8	5E	5D	1 1/2
36	48	5/8	7/8	4 3/4	6D	3	3 3/4	8E	8D	2 1/4

COLORS

LEGEND - BLACK (NON-REFL)
 BACKGROUND - WHITE (REFL)

R12-2

11/97

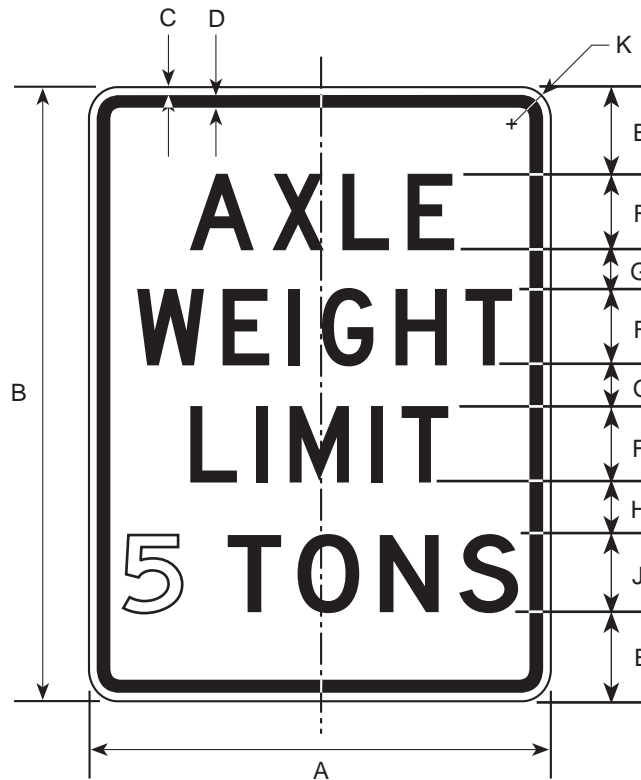

* Optically space numerals about vertical centerline.

DIMENSIONS (MILLIMETERS)									
A	B	C	D	E	F	G	H	J	K
600	750	9	16	81	100D	50	63	125E	38
900	1200	16	22	131	150D	88	11	200E	56

DIMENSIONS (INCHES)									
A	B	C	D	E	F	G	H	J	K
24	30	3/8	5/8	3 1/4	4D	2	2 1/2	5D	1 1/2
36	48	5/8	7/8	5 1/4	6D	3 1/2	4 1/2	8D	2 1/4

COLORS

LEGEND - BLACK (NON-REFL)
BACKGROUND - WHITE (REFL)

R12-3

6/00

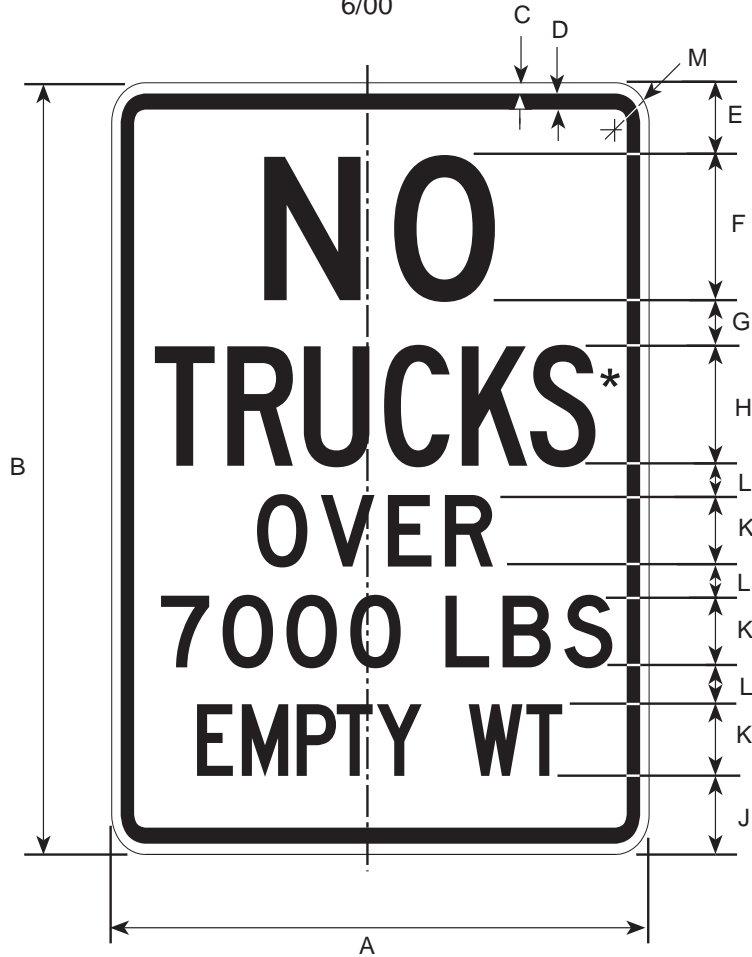

* Reduce spacing 20%.

DIMENSIONS (MILLIMETERS)											
A	B	C	D	E	F	G	H	J	K	L	M
600	900	10	16	87	150D	63	125C	100	75D	50	38

DIMENSIONS (INCHES)											
A	B	C	D	E	F	G	H	J	K	L	M
24	36	3/8	5/8	3 1/2	6D	2 1/2	5C	4	3D	2	1 1/2

COLORS

LEGEND - BLACK (NON REFL)
BACKGROUND - WHITE (REFL)

R12-4

11/97

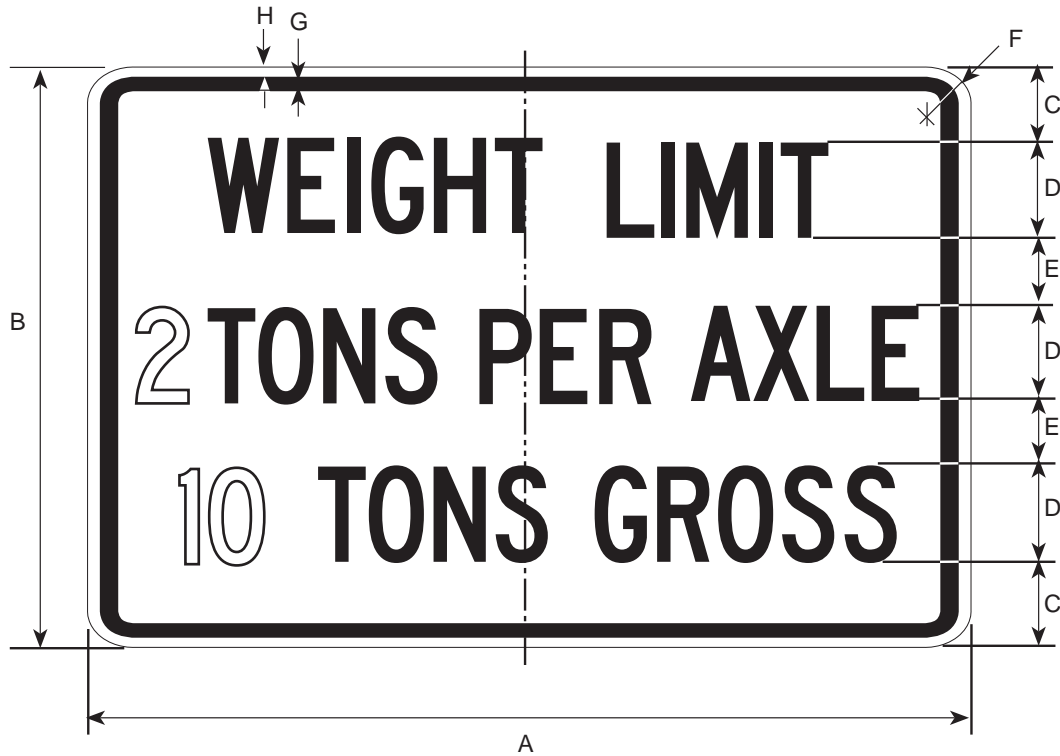

DIMENSIONS (MILLIMETERS)							
A	B	C	D	E	F	G	H
900	600	88	100C	63	38	16	10

DIMENSIONS (INCHES)							
A	B	C	D	E	F	G	H
36	24	3 1/2	4C	2 1/2	1 1/2	5/8	3/8

COLORS

LEGEND - BLACK (NON REFL)
 BACKGROUND - WHITE (REFL)

R12-5

11/97

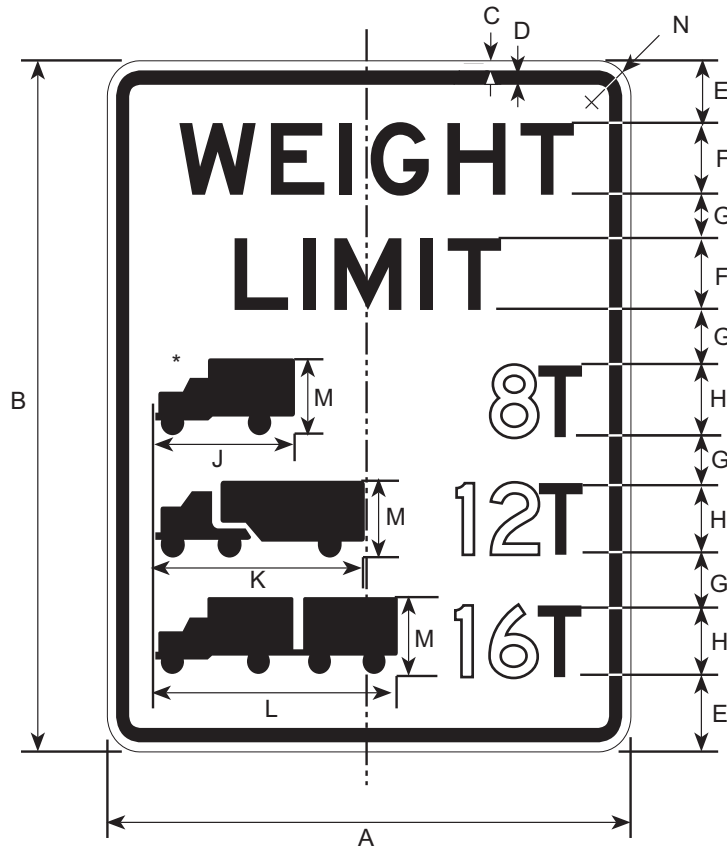

*See appendix for symbol design.

DIMENSIONS (MILLIMETERS)												
A	B	C	D	E	F	G	H	J	K	L	M	N
600	750	10	16	75	75E	56	75D	150	238	275	75	63
750	900	13	19	88	100E	56	100D	200	300	366	100	72
900	1200	16	22	125	125E	81	125D	250	375	460	125	56
1200	1500	19	31	150	150E	113	150D	300	450	550	150	75

DIMENSIONS (INCHES)												
A	B	C	D	E	F	G	H	J	K	L	M	N
24	30	3/8	5/8	3	3E	2 1/4	3D	6	9 1/2	11	3	1 1/2
30	36	1/2	3/4	3 1/2	4E	2 1/4	4D	8	12	14 5/8	4	1 7/8
36	48	5/8	7/8	5	5E	3 1/4	5D	10	15	18 3/8	5	2 1/4
48	60	3/4	1 1/4	6	6E	4 1/2	6D	12	18	22	6	3

COLORS

LEGEND — BLACK (NON-REFL)
 BACKGROUND — WHITE (REFL)

R12-501

4/06

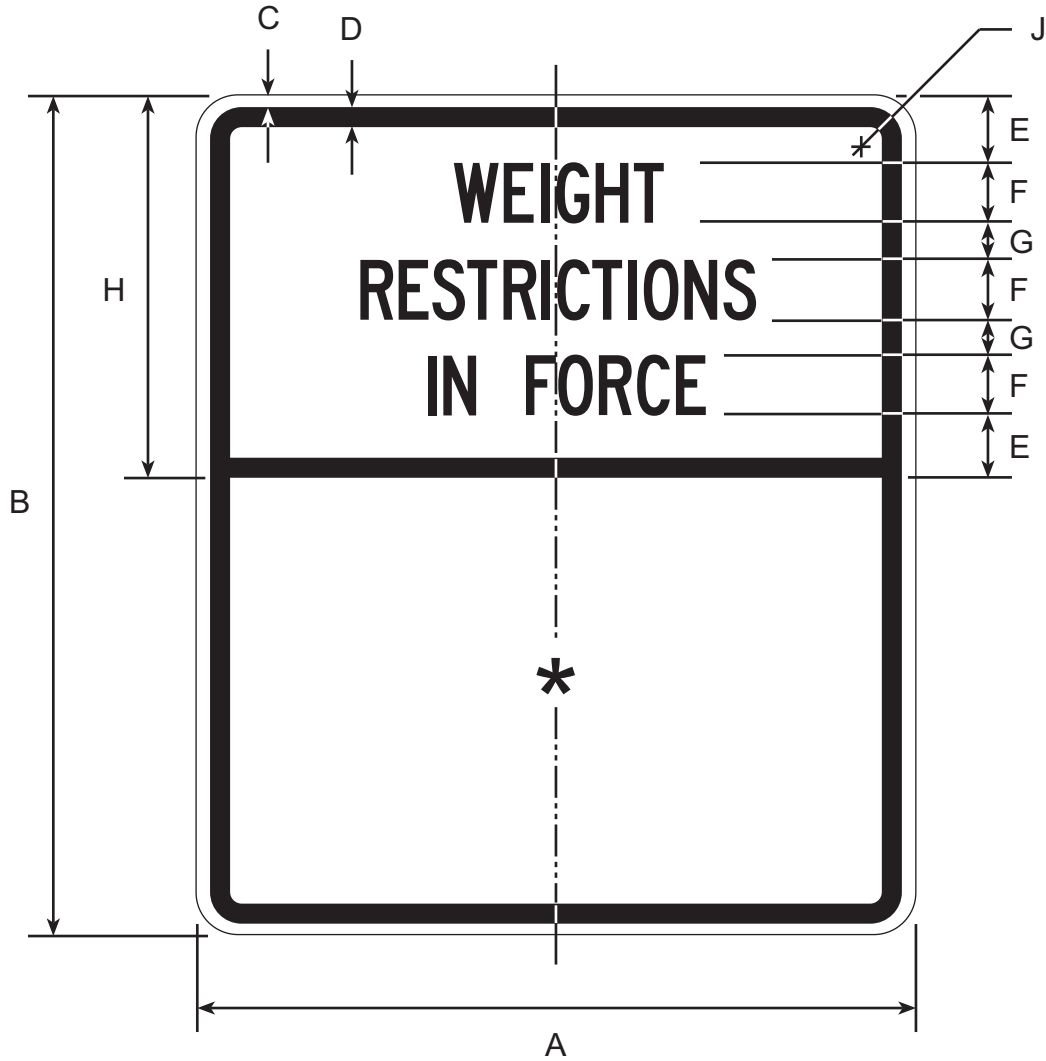

* This space reserved for legal notice

DIMENSIONS (MILLIMETERS)								
A	B	C	D	E	F	G	H	J
900	1050	9	16	3	75C	50	475	38

DIMENSIONS (INCHES)								
A	B	C	D	E	F	G	H	J
36	42	3/8	5/8	3	3C	2	19	1 1/2

COLOR

LEGEND - BLACK (NON-REFL)
BACKGROUND - WHITE (REFL)

R12-502

11/97



DIMENSIONS (MILLIMETERS)							
A	B	C	D	E	F	G	H
900	1050	10	16	100C	50	500	56

DIMENSIONS (INCHES)							
A	B	C	D	E	F	G	H
36	42	3/8	5/8	4C	2	20	2 1/4

COLORS

LEGEND - BLACK (NON-REFL)
 BACKGROUND - WHITE (REFL)

R12-503

11/97



DIMENSIONS (MILLIMETERS)							
A	B	C	D	E	F	G	H
900	900	10	16	100C	150C	69	56

DIMENSIONS (INCHES)							
A	B	C	D	E	F	G	H
36	36	3/8	5/8	4C	6C	2 3/4	2 1/4

COLORS

LEGEND - BLACK (NON-REFL)
 BACKGROUND - WHITE (REFL)

R12-1001

11/97

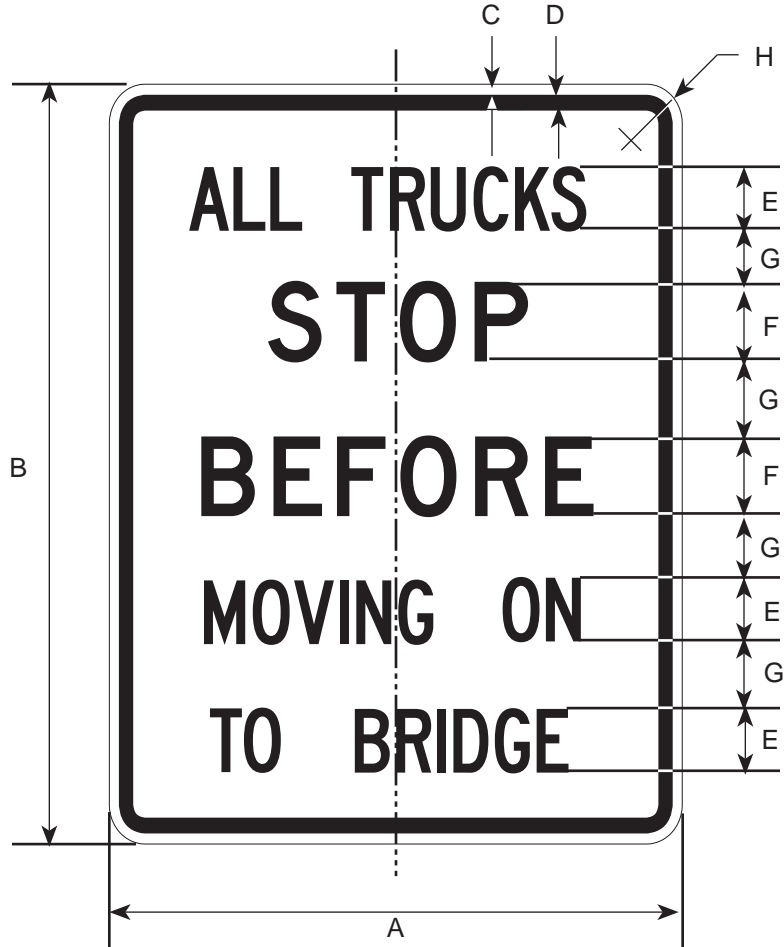

DIMENSIONS (MILLIMETERS)							
A	B	C	D	E	F	G	H
900	1200	16	22	100C	125D	119	56

DIMENSIONS (INCHES)							
A	B	C	D	E	F	G	H
36	48	5/8	7/8	4C	5D	4 3/4	2 1/4

COLORS

LEGEND - BLACK (NON-REFL)
BACKGROUND - WHITE (REFL)

R12-1101

11/97

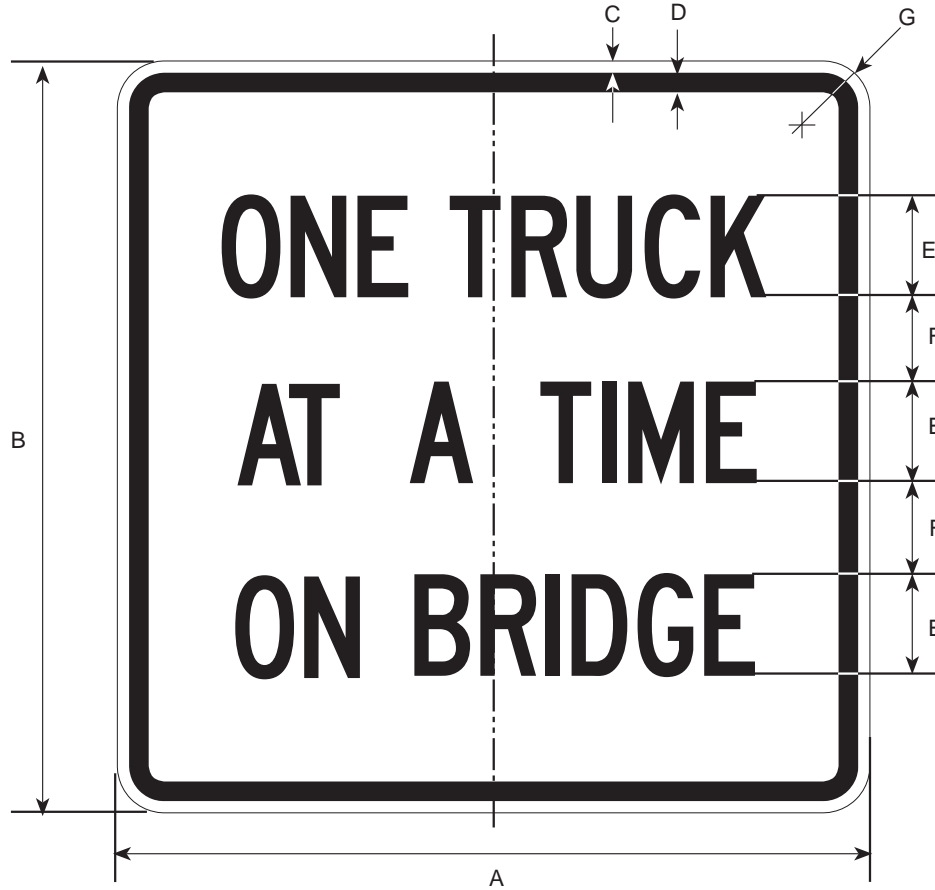

DIMENSIONS (MILLIMETERS)						
A	B	C	D	E	F	G
900	900	16	22	125C	78	56

DIMENSIONS (INCHES)						
A	B	C	D	E	F	G
36	36	5/8	7/8	5C	3 1/8	2 1/4

COLORS

LEGEND - BLACK (NON-REFL)
BACKGROUND - WHITE (REFL)

R13-1

11/97



DIMENSIONS (MILLIMETERS)						
A	B	C	D	E	F	G
1800	1200	38	150	150E	100	75
2400	1650	50	200	200E	150	100
3000	2100	50	250	250E	200	125

DIMENSIONS (INCHES)						
A	B	C	D	E	F	G
72	48	1 1/2	6	6E	4	3
96	66	2	8	8E	6	4
120	84	2	10	10E	8	5

COLORS

LEGEND - WHITE (REFL)
 BACKGROUND - BLACK (NON-REFL)

R13-201

2/00

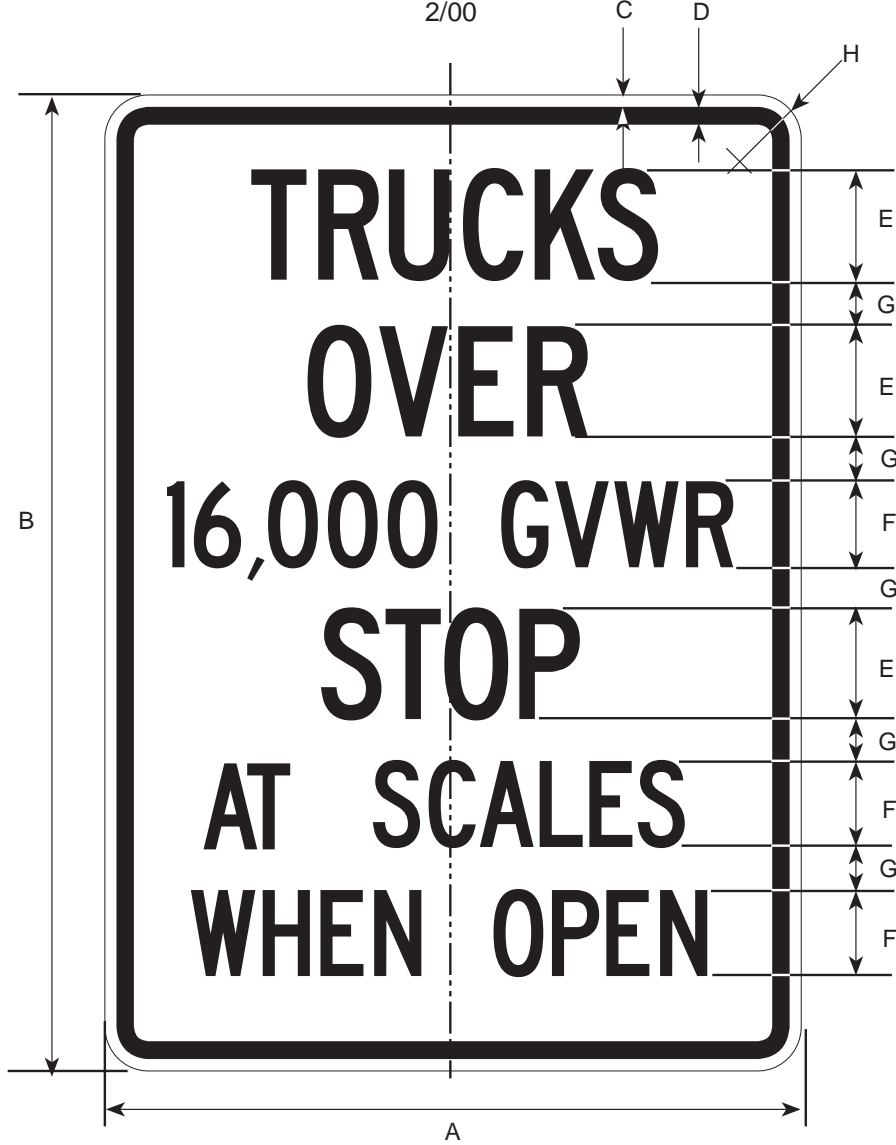

DIMENSIONS (MILLIMETERS)							
A	B	C	D	E	F	G	H
1200	1800	19	31	200C	150C	119	75

DIMENSIONS (INCHES)							
A	B	C	D	E	F	G	H
48	72	3/4	1 1/4	8C	6C	4 3/4	3

COLORS

LEGEND - BLACK (NON-REFL)
 BACKGROUND - WHITE (REFL)

R13-301

11/97

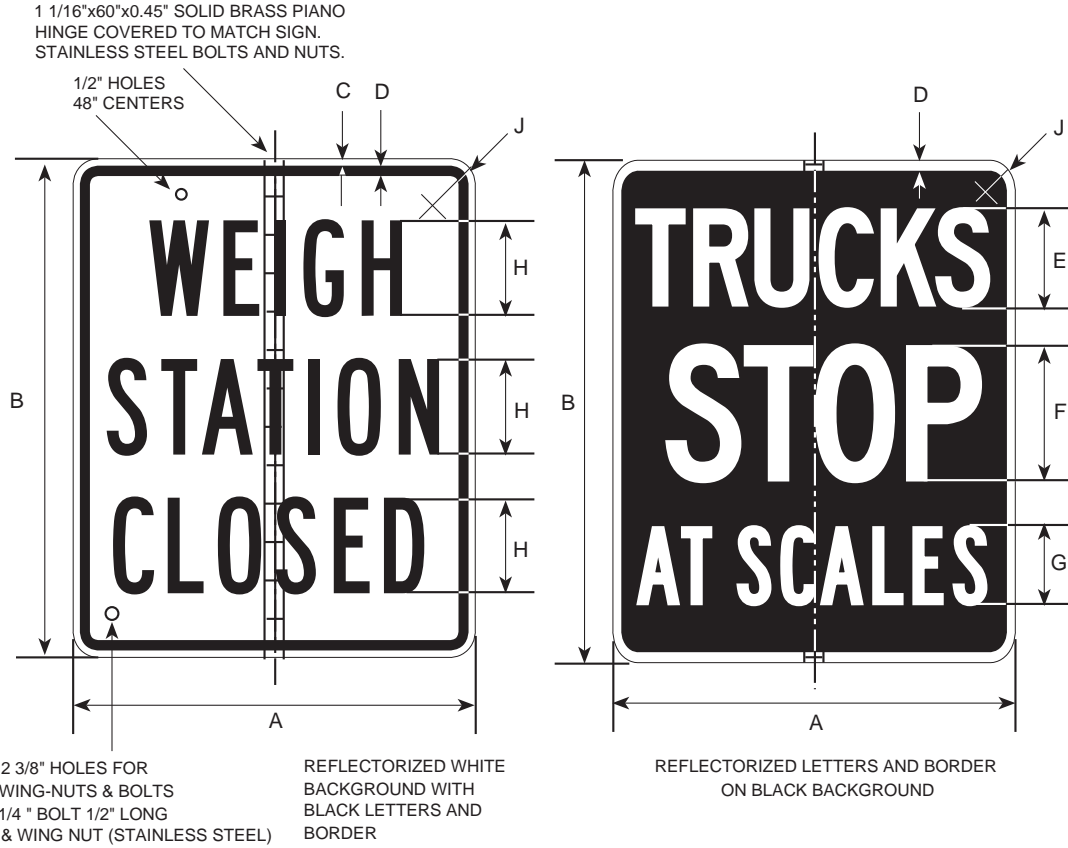

SIGN SIZE 48"x60". THIS SIGN IS COMPRISED OF ONE FULL SIZED PANEL AND ONE HALF-SIZED PANEL. HALF OF EACH MESSAGE IS ON THE FULL-SIZED PANEL. ALSO HALF OF EACH MESSAGE IS ON THE FRONT AND BACK OF THE HALF-SIZED PANEL. SIGN LOCATION IS BETWEEN THE "WEIGH STATION RIGHT LANE" AND "WEIGH STATION" GORE SIGN.

DIMENSIONS (MILLIMETERS)								
A	B	C	D	E	F	G	H	J
1200	1500	19	31	250C	350C	200B	250B	75

DIMENSIONS (INCHES)								
A	B	C	D	E	F	G	H	J
48	60	3/4	1 1/4	10C	14C	8B	10B	3

COLORS

LEGEND - SEE ABOVE
BACKGROUND - SEE ABOVE

R13-302

8/97

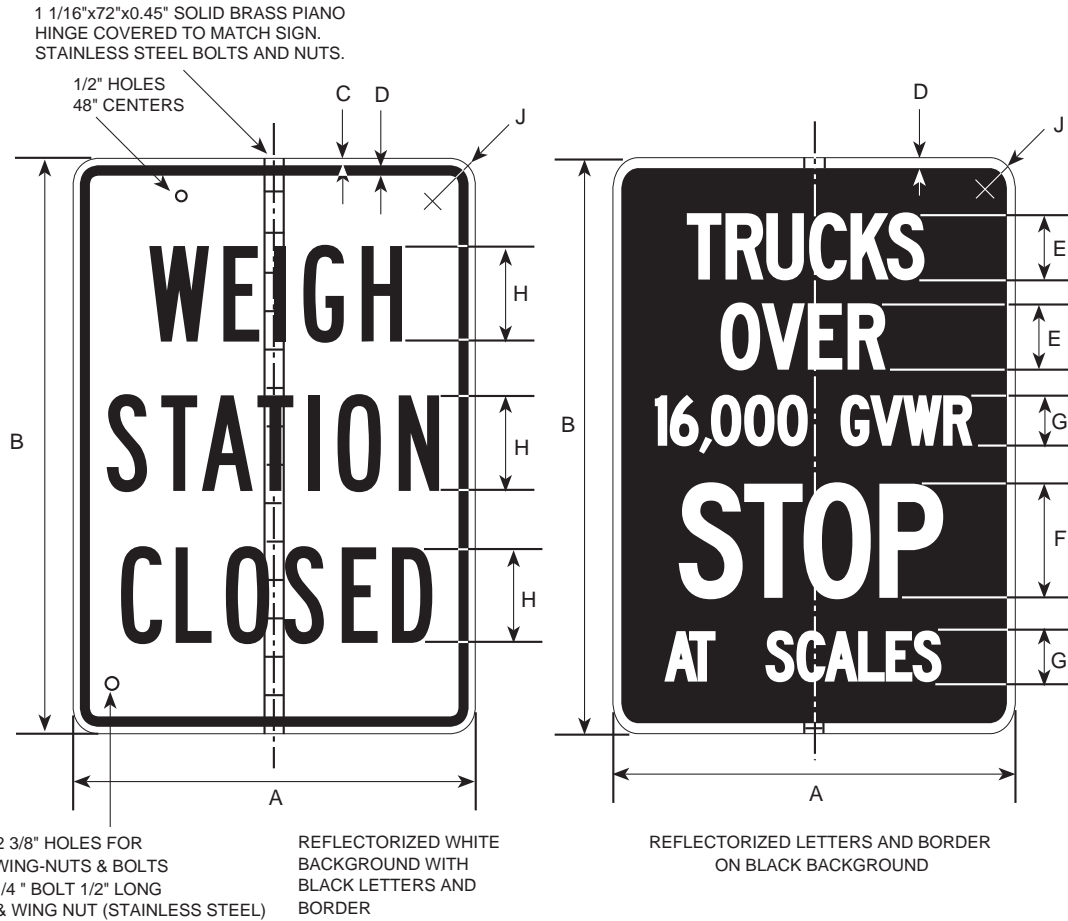

SIGN SIZE 48"x72". THIS SIGN IS COMPRISED OF ONE FULL SIZED PANEL AND ONE HALF-SIZED PANEL. HALF OF EACH MESSAGE IS ON THE FULL-SIZED PANEL. ALSO HALF OF EACH MESSAGE IS ON THE FRONT AND BACK OF THE HALF-SIZED PANEL. SIGN LOCATION IS BETWEEN THE "WEIGH STATION RIGHT LANE" AND "WEIGH STATION" GORE SIGN.

DIMENSIONS (MILLIMETERS)								
A	B	C	D	E	F	G	H	J
1200	1800	19	31	200C	350C	150C	250B	75

DIMENSIONS (INCHES)								
A	B	C	D	E	F	G	H	J
48	72	3/4	1 1/4	8C	14C	6C	10B	3

COLORS

LEGEND - SEE ABOVE
BACKGROUND - SEE ABOVE

R13-401

11/97

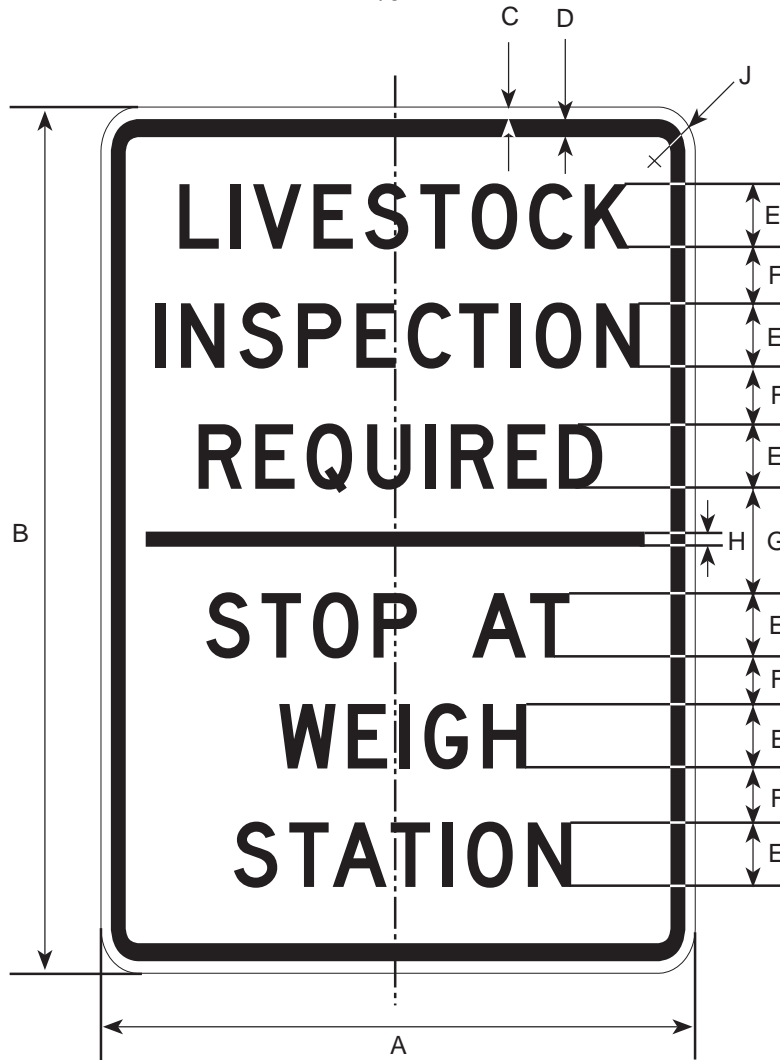

DIMENSIONS (MILLIMETERS)								
A	B	C	D	E	F	G	H	J
1200	1800	19	31	150D	100	200	25	75

DIMENSIONS (INCHES)								
A	B	C	D	E	F	G	H	J
48	72	3/4	1 1/4	6D	4	8	1	3

COLORS

LEGEND - BLACK (NON-REFL)
BACKGROUND - WHITE (REFL)

R14-1

11/97

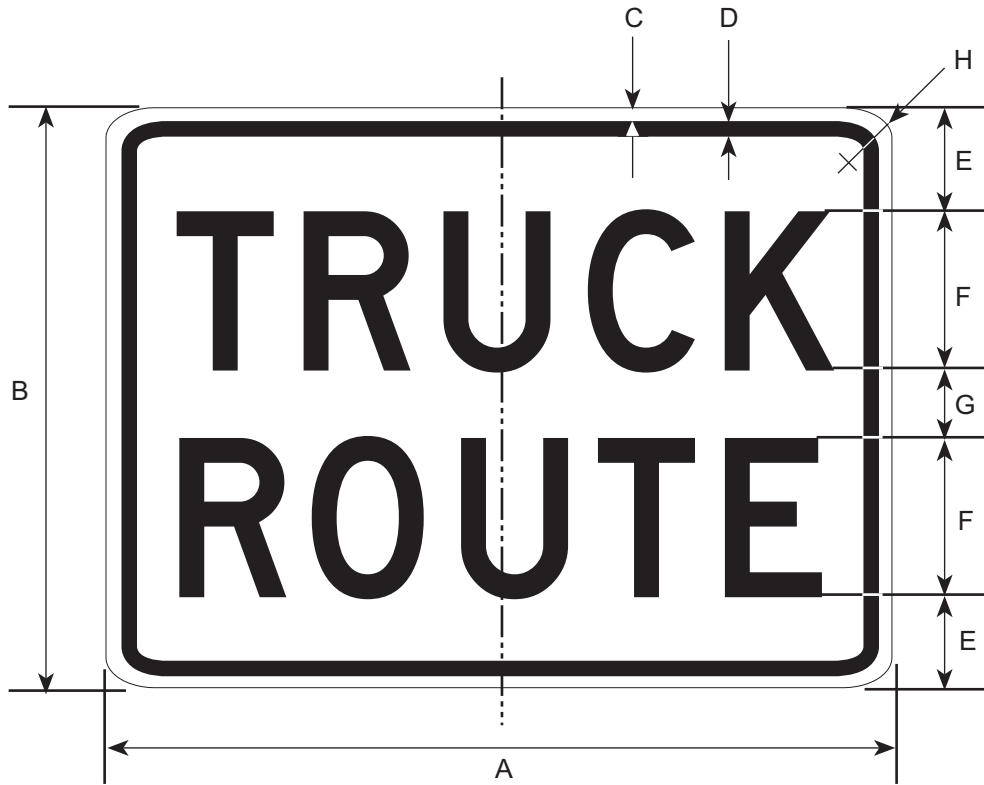

DIMENSIONS (MILLIMETERS)							
A	B	C	D	E	F	G	H
600	450	10	16	75	125D	50	38

DIMENSIONS (INCHES)							
A	B	C	D	E	F	G	H
24	18	3/8	5/8	3	5D	2	1 1/2

COLORS

LEGEND — BLACK (NON-REFL)
 BACKGROUND — WHITE (REFL)

R14-2

4/06

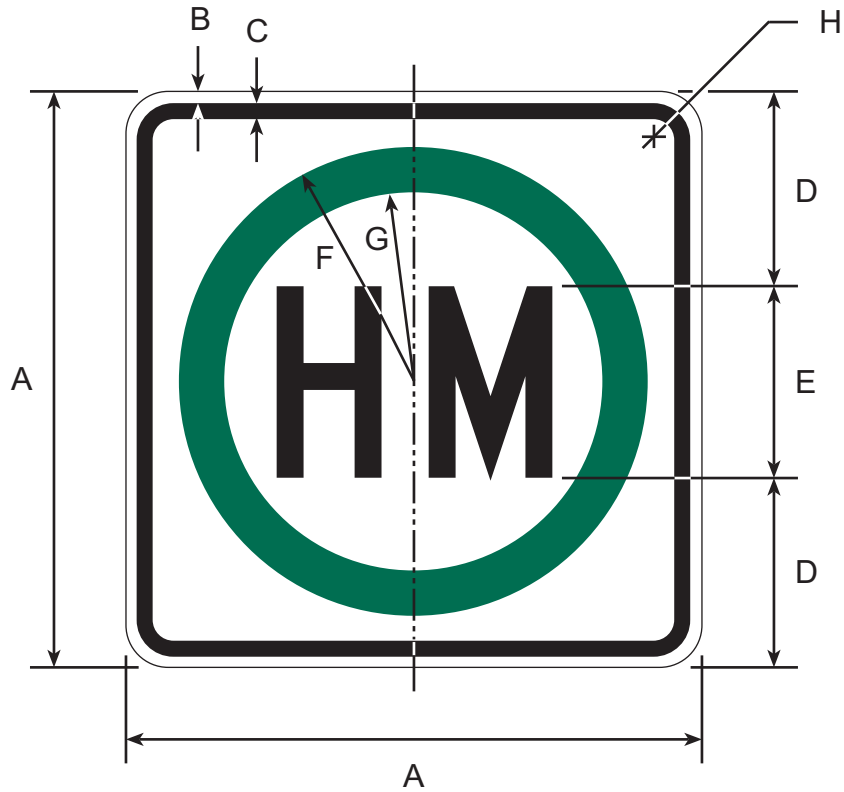

DIMENSIONS (MILLIMETERS)							
A	B	C	D	E	F	G	H
600	9	16	187	187C	250	200	38
750	13	19	250	250C	313	250	47
900	16	22	300	300C	375	300	56
1050	16	22	350	350C	438	350	56

DIMENSIONS (INCHES)							
A	B	C	D	E	F	G	H
24	3/8	5/8	7 1/2	9C	10	8	1 1/2
30	1/2	3/4	10	10C	12 1/2	10	1 7/8
36	5/8	7/8	12	12C	15	12	2 1/4
42	5/8	7/8	14	14C	17 1/2	14	2 1/4

COLORS

LETTERS & BORDER - BLACK (NON-REFL)
 CIRCLE - GREEN (REFL)
 BACKGROUND - WHITE (REFL)

R14-3

4/06

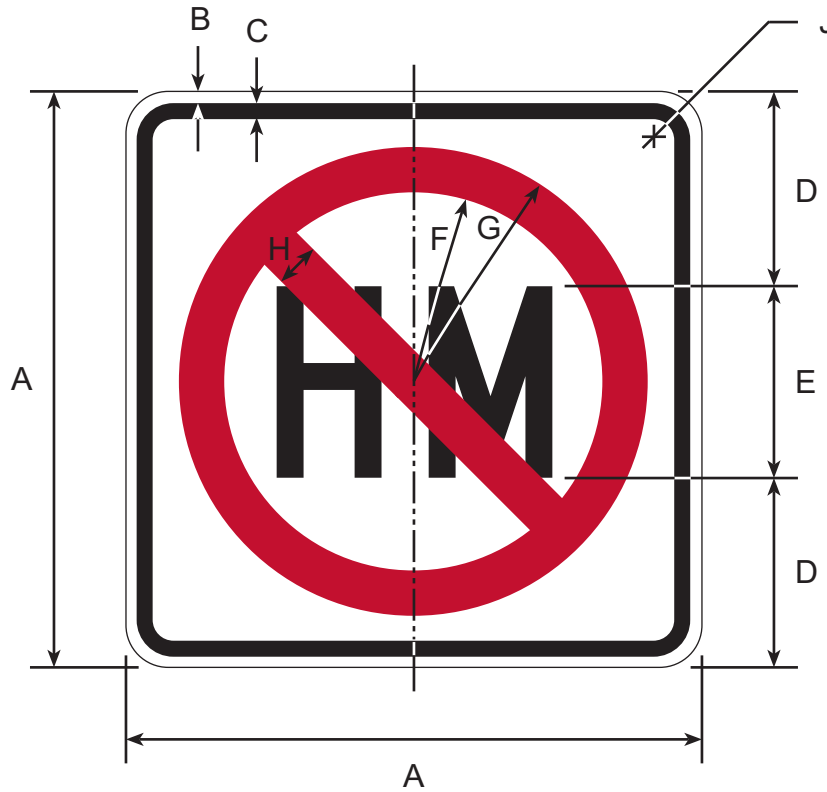

DIMENSIONS (MILLIMETERS)								
A	B	C	D	E	F	G	H	J
600	9	16	187	187C	200	250	50	38
750	13	19	250	250C	250	313	63	47
900	16	22	300	300C	300	375	75	56
1050	16	22	350	350C	350	438	88	56

DIMENSIONS (INCHES)								
A	B	C	D	E	F	G	H	J
24	3/8	5/8	7 1/2	9C	8	10	2	1 1/2
30	1/2	3/4	10	10C	10	12 1/2	2 1/2	1 7/8
36	5/8	7/8	12	12C	12	15	3	2 1/4
42	5/8	7/8	14	14C	14	17 1/2	3 1/2	2 1/4

COLORS

LETTERS & BORDER - BLACK (NON-REFL)
 CIRCLE & DIAGONAL - RED (REFL)
 BACKGROUND - WHITE (REFL)

R14-4

11/97

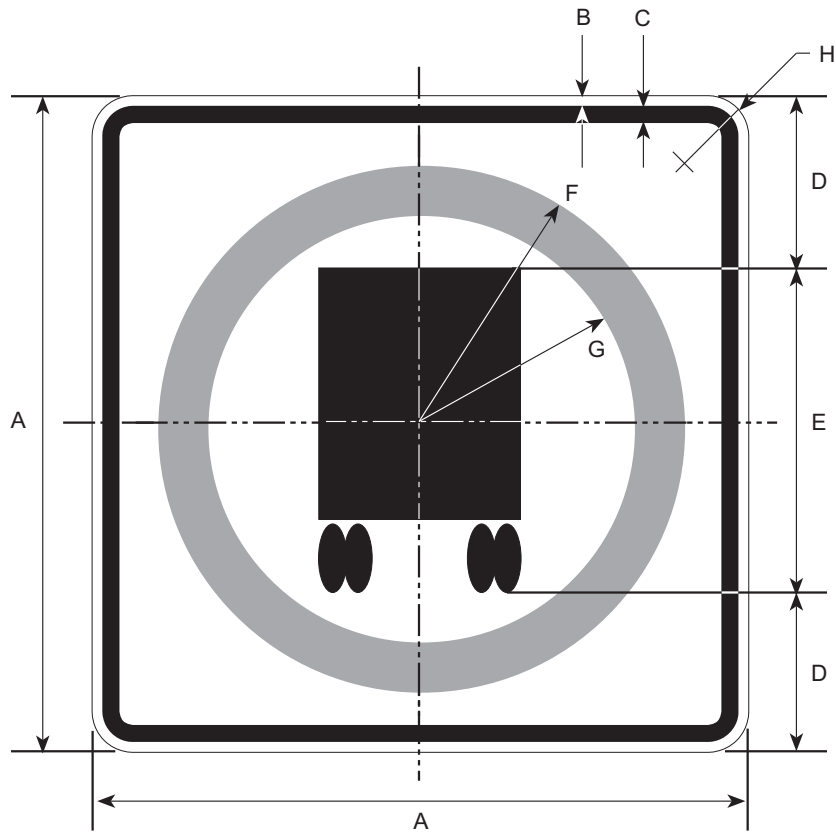

DIMENSIONS (MILLIMETERS)							
A	B	C	D	E	F	G	H
600	10	16	125	350	263	213	38
750	13	19	156	438	328	266	47
900	16	22	188	525	394	319	56
1200	19	31	250	700	525	425	75

DIMENSIONS (INCHES)							
A	B	C	D	E	F	G	H
24	3/8	5/8	5	14	10 1/2	8 1/2	1 1/2
30	1/2	3/4	6 1/4	17 1/2	13 1/8	10 5/8	1 7/8
36	5/8	7/8	7 1/2	21	15 3/4	12 3/4	2 1/4
48	3/4	1 1/4	10	28	21	17	3

COLORS

SYMBOL AND BORDER — BLACK (NON-REFL)
 BACKGROUND — WHITE (REFL)
 CIRCLE — GREEN (REFL)

R14-5

11/97

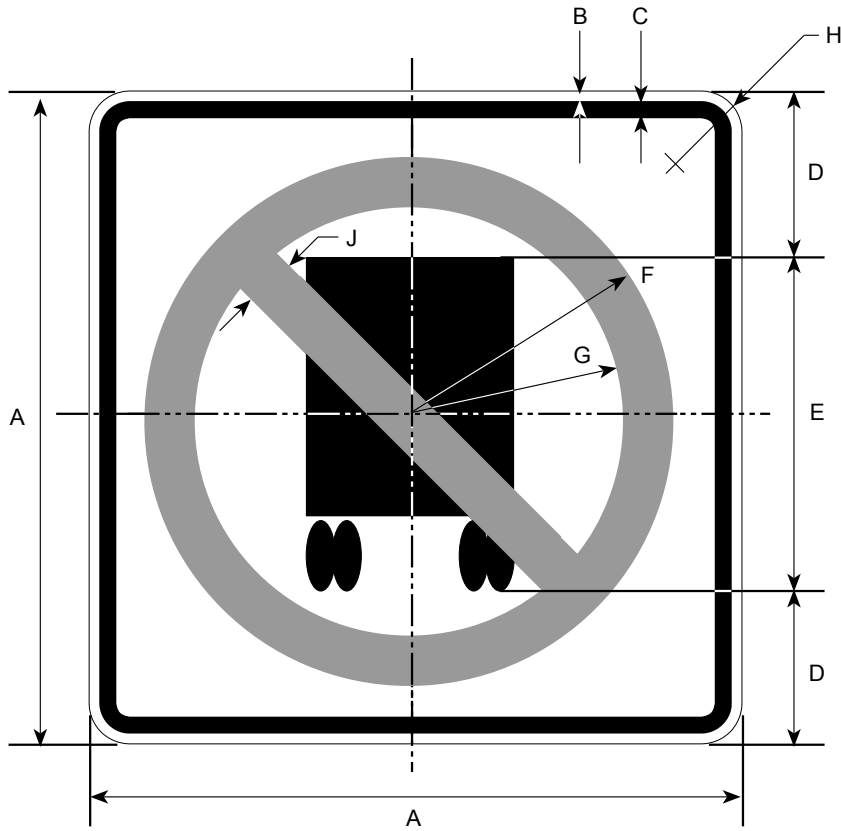

DIMENSIONS (MILLIMETERS)								
A	B	C	D	E	F	G	H	J
600	10	16	125	350	263	213	38	50
750	13	19	156	438	328	266	47	63
900	16	22	188	525	394	319	56	75
1200	19	31	250	700	525	425	75	100

DIMENSIONS (INCHES)								
A	B	C	D	E	F	G	H	J
24	3/8	5/8	5	14	10 1/2	8 1/2	1 1/2	2
30	1/2	3/4	6 1/4	17 1/2	13 1/8	10 5/8	1 7/8	2 1/2
36	5/8	7/8	7 1/2	21	15 3/4	12 3/4	2 1/4	3
48	3/4	1 1/4	10	28	21	17	3	4

COLORS

SYMBOL, BORDER, LEGEND — BLACK (NON-REFL)
 BACKGROUND — WHITE (REFL)
 CIRCLE AND DIAGONAL — RED (REFL)

R15-1

11/97

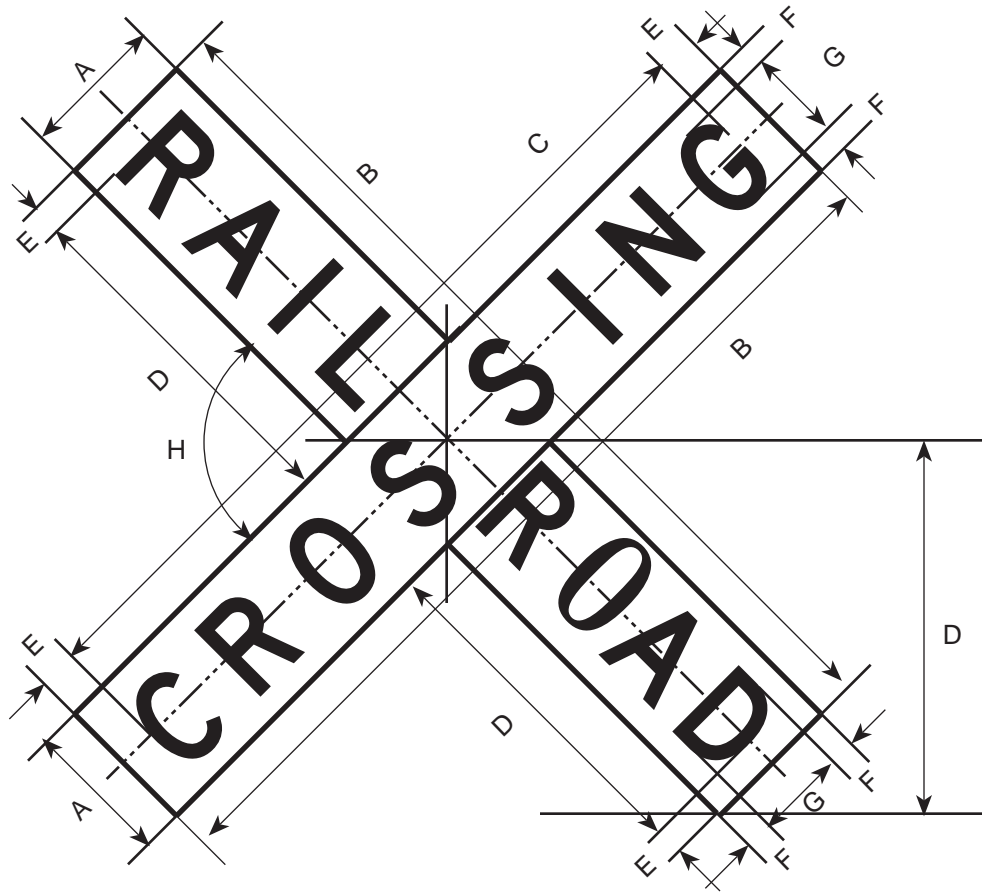

DIMENSIONS (MILLIMETERS)							
A	B	C	D	E	F	G	H
225	1200	1125	450	38	44	138D	90°

DIMENSIONS (INCHES)							
A	B	C	D	E	F	G	H
9	48	45	18	1 1/2	1 3/4	5 1/2D	90°

COLORS

LEGEND - BLACK (NON-REFL)
BACKGROUND - WHITE (REFL)

R15-2

11/97

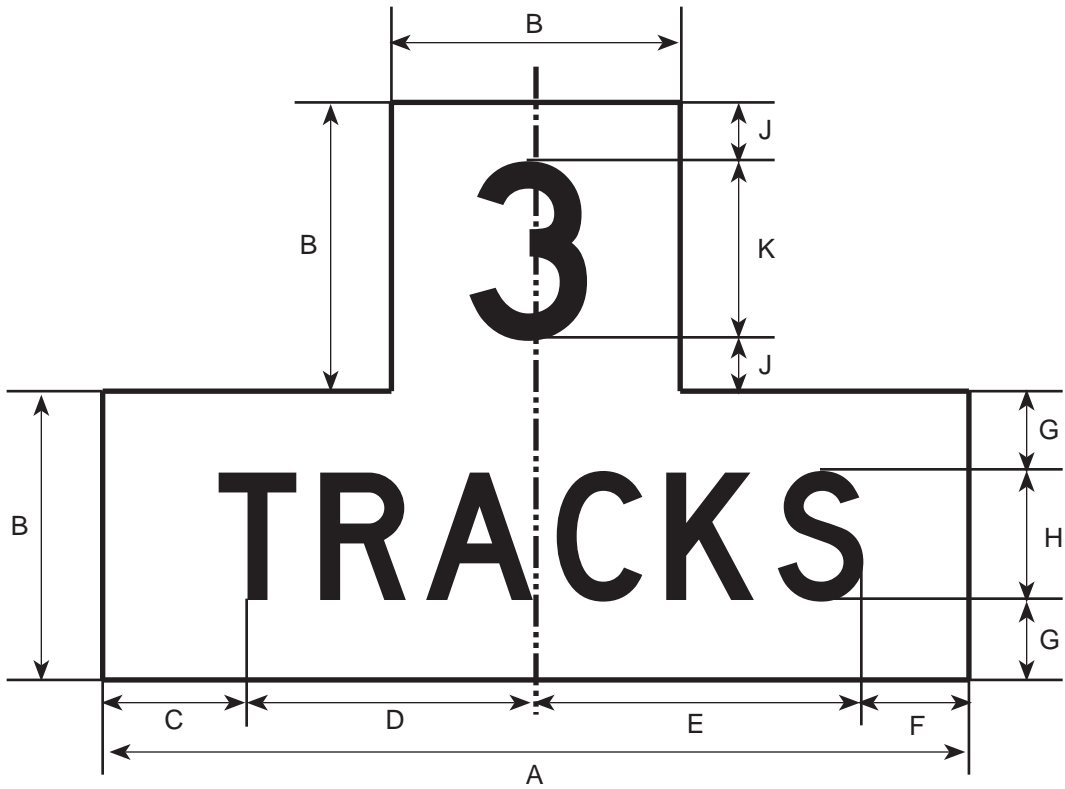

DIMENSIONS (MILLIMETERS)									
A	B	C	D	E	F	G	H	J	K
675	225	88	250	247	91	63	100D	44	138D

DIMENSIONS (INCHES)									
A	B	C	D	E	F	G	H	J	K
27	9	3 1/2	10	9 7/8	3 5/8	2 1/2	4D	1 3/4	5 1/2D

COLORS (may be reversed)

LEGEND - BLACK (NON REFL)

BACKGROUND - WHITE (REFL)

R15-3

11/97

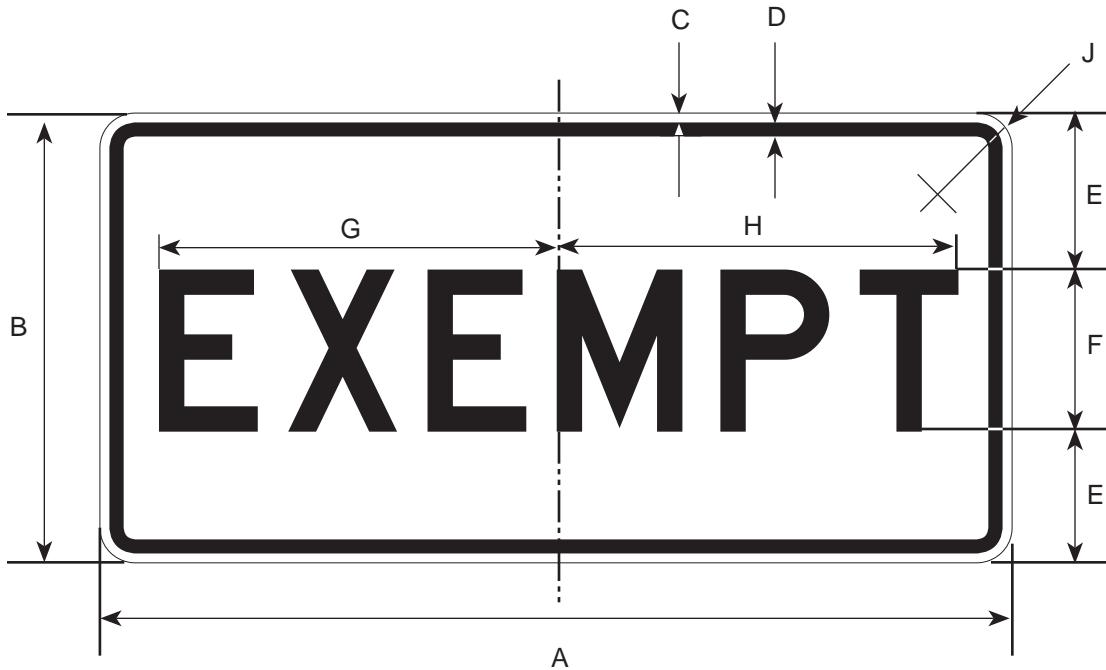

DIMENSIONS (MILLIMETERS)								
A	B	C	D	E	F	G	H	J
600	300	10	16	100	100D	244	250	38

DIMENSIONS (INCHES)								
A	B	C	D	E	F	G	H	J
24	12	3/8	5/8	4	4D	9 3/4	10	1 1/2

(FOR USE WITH MUTCD W10-1)

COLORS

LEGEND - BLACK (NON-REFL)
BACKGROUND - YELLOW (REFL)

(FOR USE WITH MUTCD R15-1)

COLORS

LEGEND - BLACK (NON-REFL)
BACKGROUND - WHITE (REFL)

R16-101

11/97

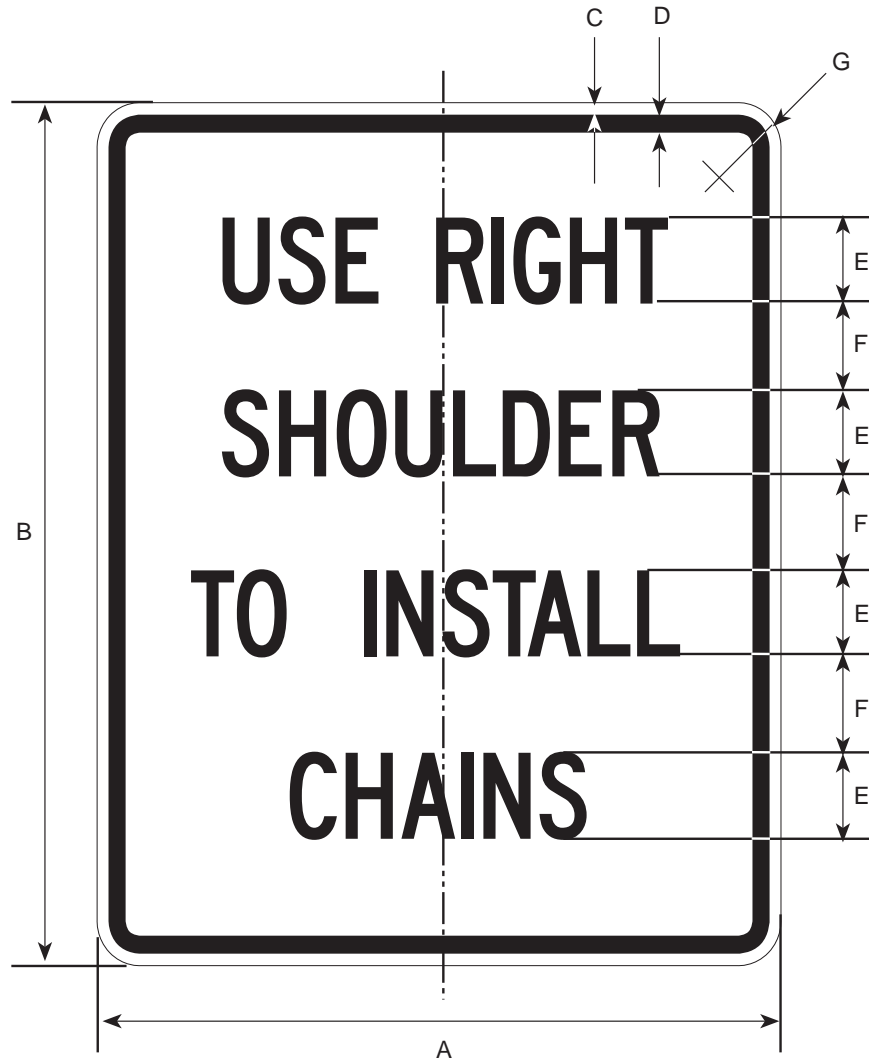

DIMENSIONS (MILLIMETERS)						
A	B	C	D	E	F	G
1200	1500	19	31	150C	163	75

DIMENSIONS (INCHES)						
A	B	C	D	E	F	G
48	60	3/4	1 1/4	6C	6 1/2	3

COLORS

LEGEND - BLACK (NON-REFL)
 BACKGROUND - WHITE (NON-REFL)

R16-102

11/97

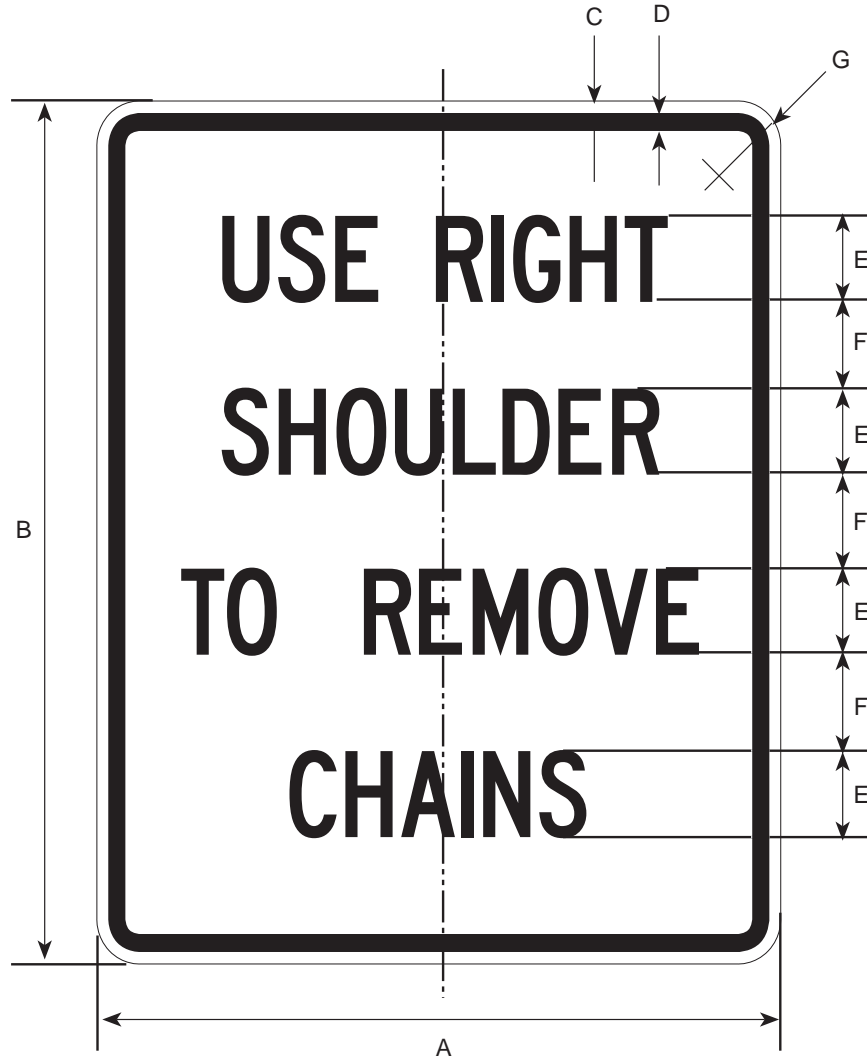

DIMENSIONS (MILLIMETERS)						
A	B	C	D	E	F	G
1200	1500	19	31	150C	163	75

DIMENSIONS (INCHES)						
A	B	C	D	E	F	G
48	60	3/4	1 1/4	6C	6 1/2	3

COLORS

LEGEND - BLACK (NON-REFL)
BACKGROUND - WHITE (NON-REFL)

R16-203

9/01

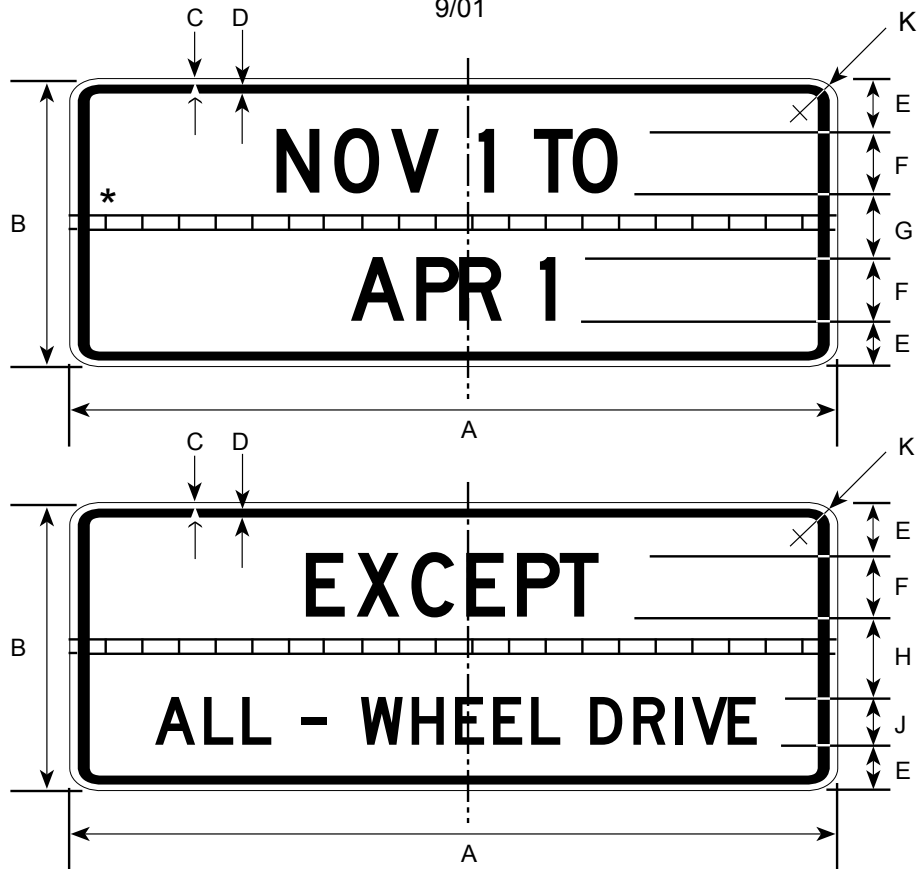

* 1 1/16"x48"x0.45" PIANO HINGE COVERED TO MATCH SIGN (TYP.)

DIMENSIONS (MILLIMETERS)									
A	B	C	D	E	F	G	H	J	K
1200	450	16	22	75	100D	100	125	75D	56

DIMENSIONS (INCHES)									
A	B	C	D	E	F	G	H	J	K
48	18	5/8	7/8	3	4D	4	5	3D	2 1/4

COLORS

LEGEND — BLACK (NON-REFL)
BACKGROUND — WHITE (REFL)

R16-2100

9/01

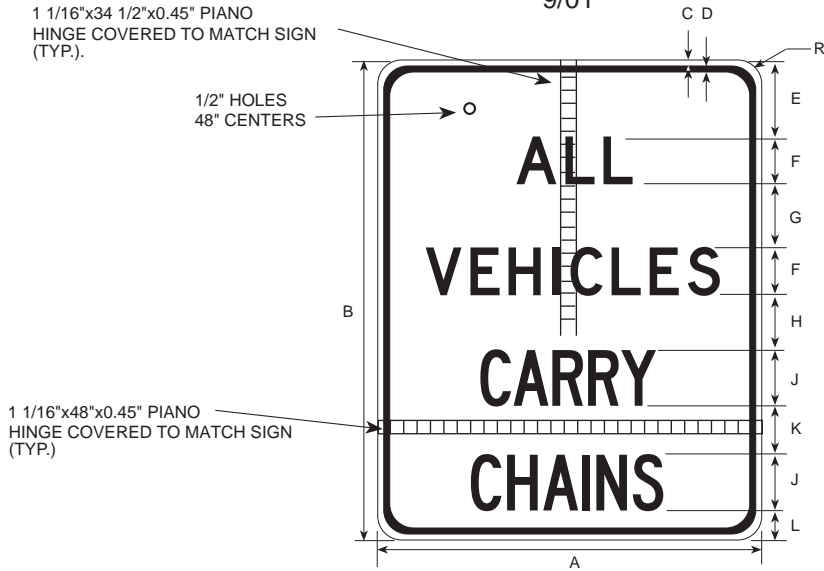

R16-2101

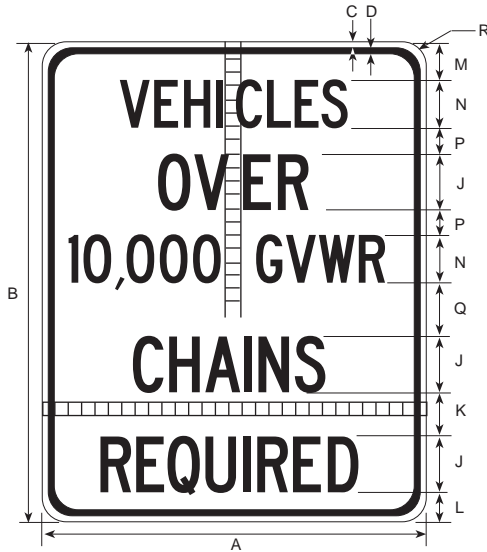

R16-2102

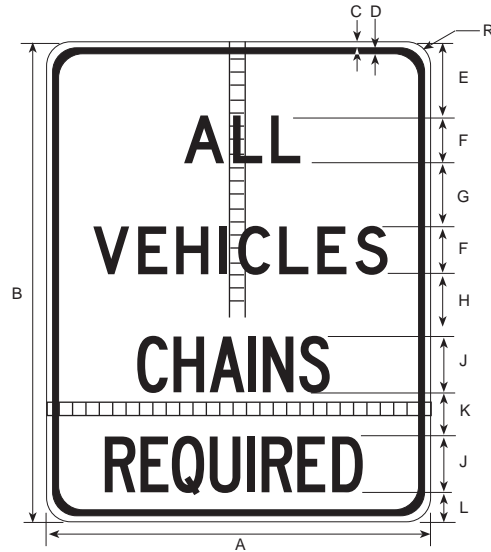

DIMENSIONS (MILLIMETERS)															
A	B	C	D	E	F	G	H	J	K	L	M	N	P	Q	R
1200	1500	19	31	350	150D	200	175	175C	144	94	19	150C	81	169	75

DIMENSIONS (INCHES)															
A	B	C	D	E	F	G	H	J	K	L	M	N	P	Q	R
48	60	3/4	1 1/4	10	6D	8	7	7C	5 3/4	3 3/4	4 3/4	6C	3 1/4	6 3/4	3

COLORS

LEGEND - BLACK (NON-REFL)
BACKGROUND - WHITE (REFL)

R16-2103

9/01

1 1/16"x60" 1/2"x0.45" PIANO
HINGE COVERED TO MATCH SIGN
(TYP).

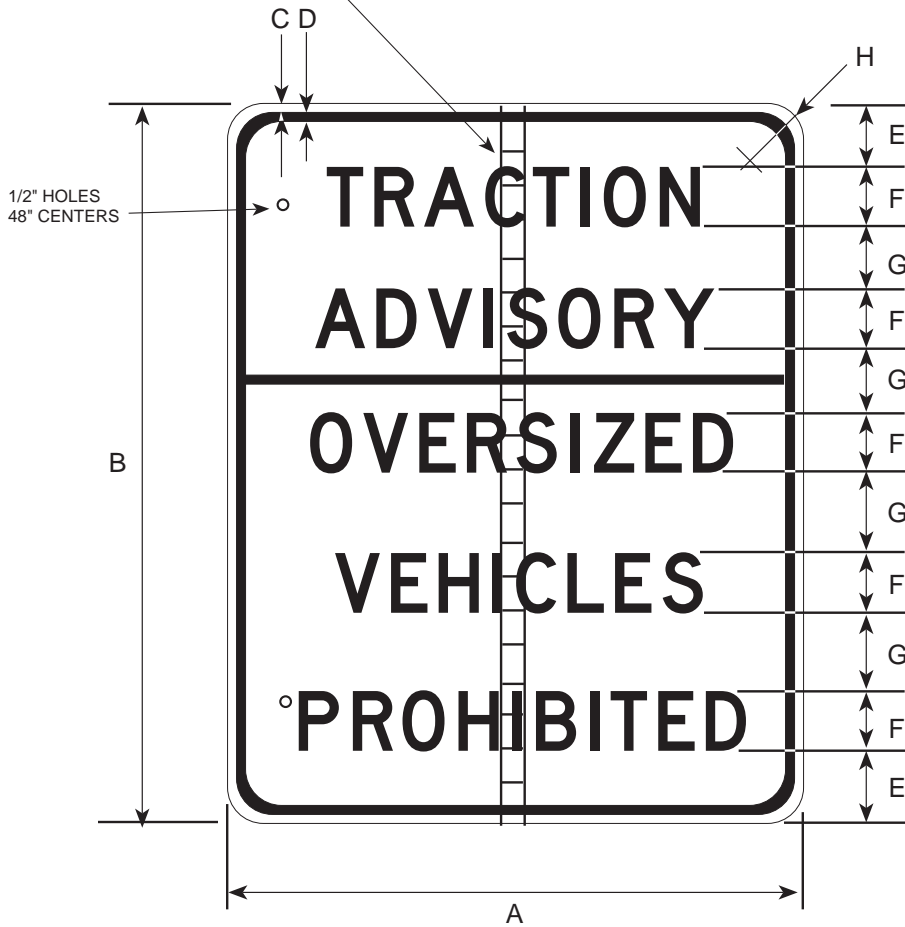

DIMENSIONS (MILLIMETERS)							
A	B	C	D	E	F	G	H
1200	1500	19	31	163	125D	138	75

DIMENSIONS (INCHES)							
A	B	C	D	E	F	G	H
48	72	3/4	1 1/4	6 1/2	5D	5 1/2	3

COLORS

LEGEND - BLACK (NON-REFL)
BACKGROUND - WHITE (REFL)

R16-301

11/97



DIMENSIONS (MILLIMETERS)					
A	B	C	D	E	F
900	600	16	100C	63	38
1200	900	31	150C	94	75

DIMENSIONS (INCHES)					
A	B	C	D	E	F
36	24	5/8	4C	2 1/2	1 1/2
48	36	1 1/4	6C	3 3/4	3

COLORS

LEGEND - WHITE (REFL)
 BACKGROUND - BLACK (NON-REFL)

R16-501

11/97

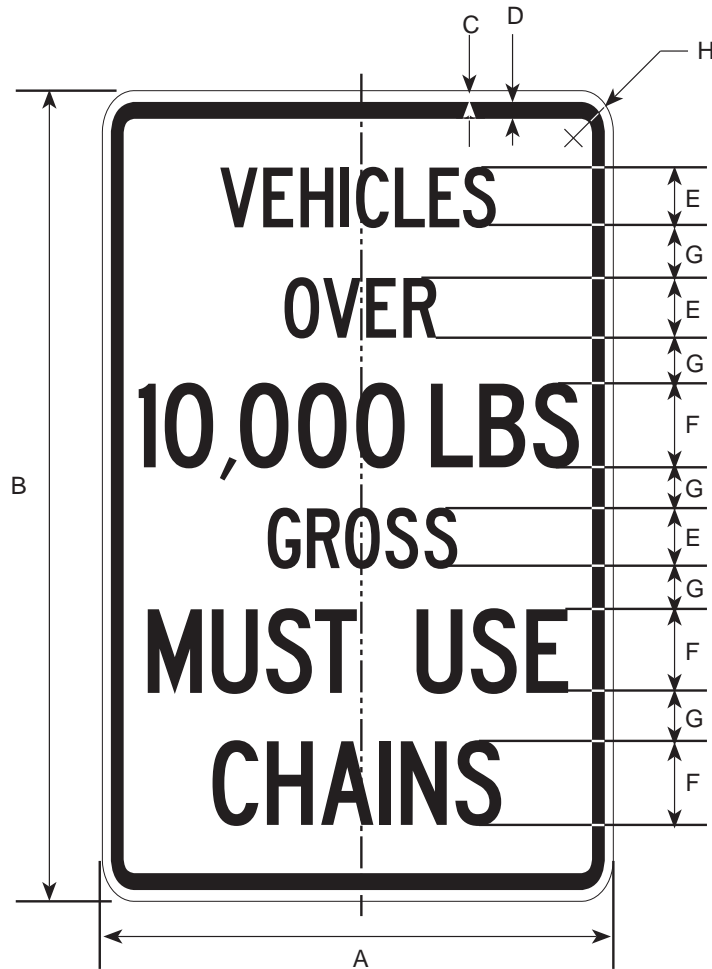

DIMENSIONS (MILLIMETERS)							
A	B	C	D	E	F	G	H
1200	1800	19	31	125C	175C	113	75

DIMENSIONS (INCHES)							
A	B	C	D	E	F	G	H
48	72	3/4	1 1/4	5C	7C	4 1/2	3

COLORS

LEGEND - BLACK (NON-REFL)
 BACKGROUND - WHITE (REFL)

R16-501A

11/97

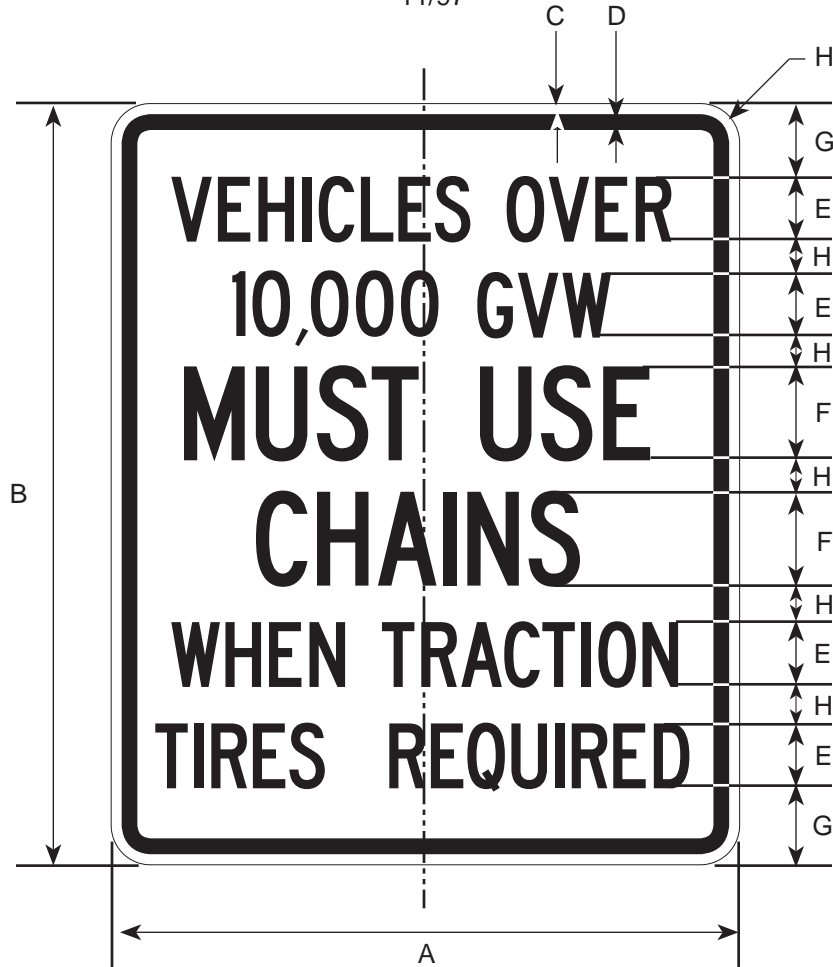

DIMENSIONS (MILLIMETERS)							
A	B	C	D	E	F	G	H
1200	1500	19	31	125C	175C	137	75

DIMENSIONS (INCHES)							
A	B	C	D	E	F	G	H
48	60	3/4	1 1/4	5C	7C	5 1/2	3

COLORS

LEGEND - BLACK (NON-REFL)
BACKGROUND - WHITE (REFL)

R16-601

11/97

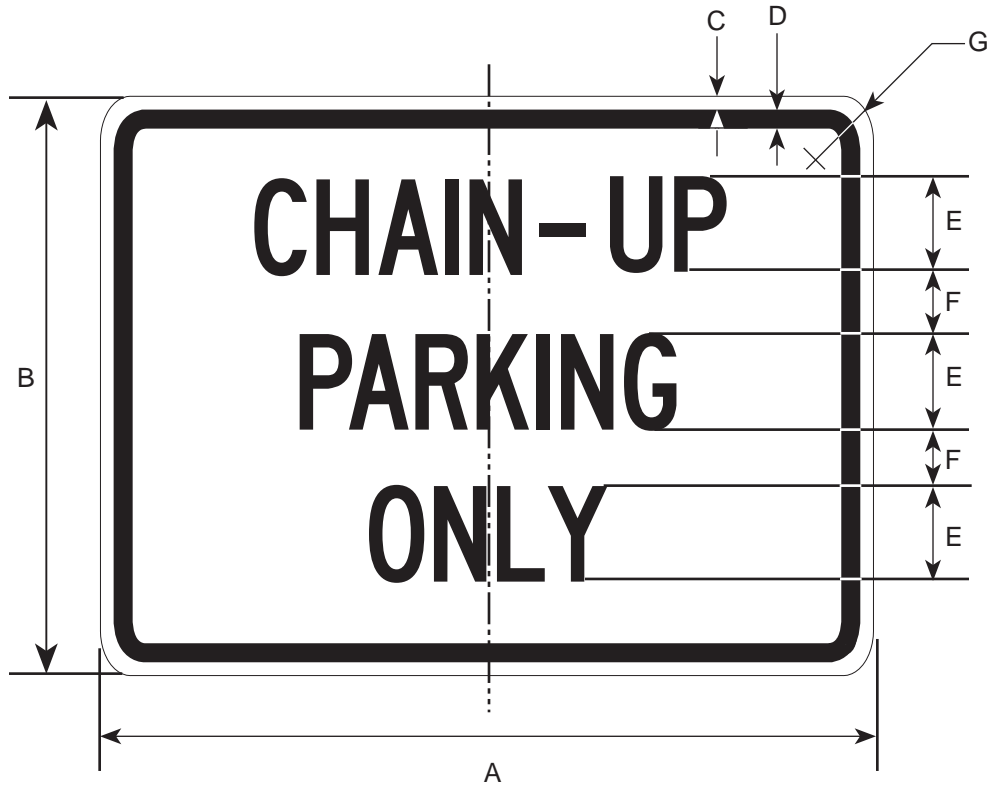

DIMENSIONS (MILLIMETERS)						
A	B	C	D	E	F	G
1200	900	19	31	150C	125	56

DIMENSIONS (INCHES)						
A	B	C	D	E	F	G
48	36	3/4	1 1/4	6C	5	2 1/4

COLORS

LEGEND - BLACK (NON-REFL)
BACKGROUND - WHITE (REFL)

R16-701

11/97



DIMENSIONS (MILLIMETERS)						
A	B	C	D	E	F	G
1200	900	19	31	150C	125	56

DIMENSIONS (INCHES)						
A	B	C	D	E	F	G
48	36	3/4	1 1/4	6C	5	2 1/4

COLORS

LEGEND - BLACK (NON-REFL)
 BACKGROUND - WHITE (REFL)

R17-101

11/97



DIMENSIONS (MILLIMETERS)							
A	B	C	D	E	F	G	H
600	750	9.375	15.62	125D	100D	50	37.5

DIMENSIONS (INCHES)							
A	B	C	D	E	F	G	H
24	30	3/8	5/8	5D	4D	2	1 1/2

COLOR
 LEGEND - BLACK
 BACKGROUND - WHITE

R17-2

4/99



DIMENSIONS (MILLIMETERS)						
A	B	C	D	E	F	G
600	450	10	16	25/19	63/47	38

DIMENSIONS (INCHES)						
A	B	C	D	E	F	G
24	18	1/4	3/8	1/.75	2.5/1.875	1 1/2

COLOR
 LEGEND - BLACK (REFL)
 BACKGROUND - WHITE (REFL)

R18-101

11/97

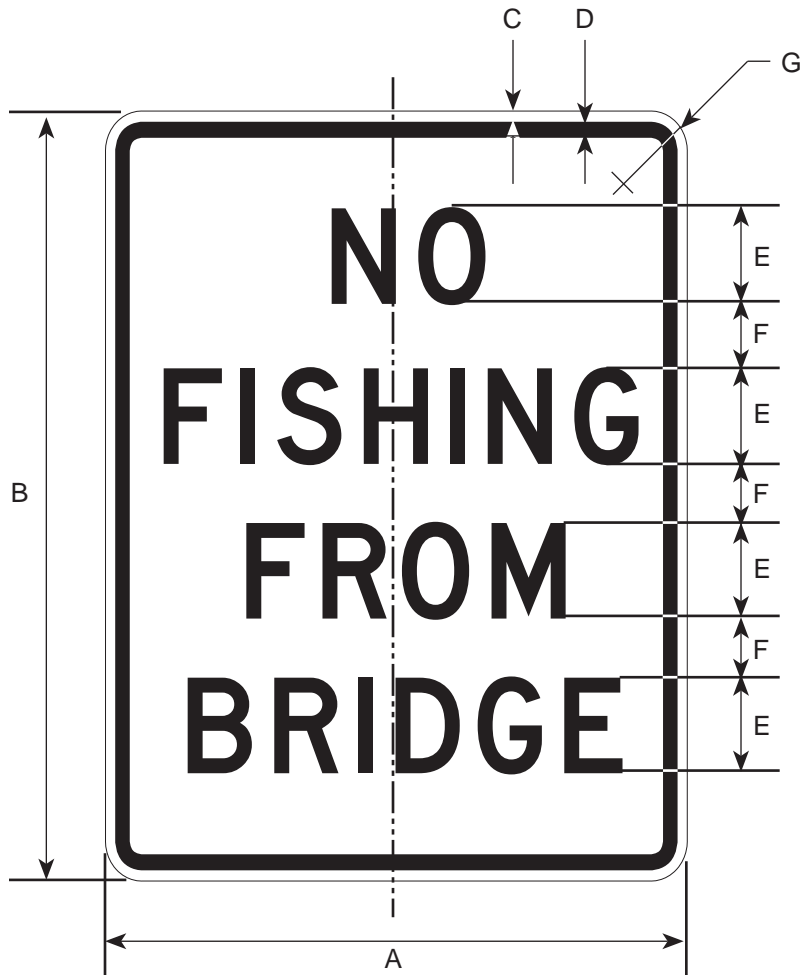

DIMENSIONS (MILLIMETERS)						
A	B	C	D	E	F	G
450	600	10	16	75D	50	38

DIMENSIONS (INCHES)						
A	B	C	D	E	F	G
18	24	3/8	5/8	3D	2	1 1/2

COLORS

LEGEND - BLACK (NON-REFL)
BACKGROUND - WHITE (REFL)

R18-201

11/97

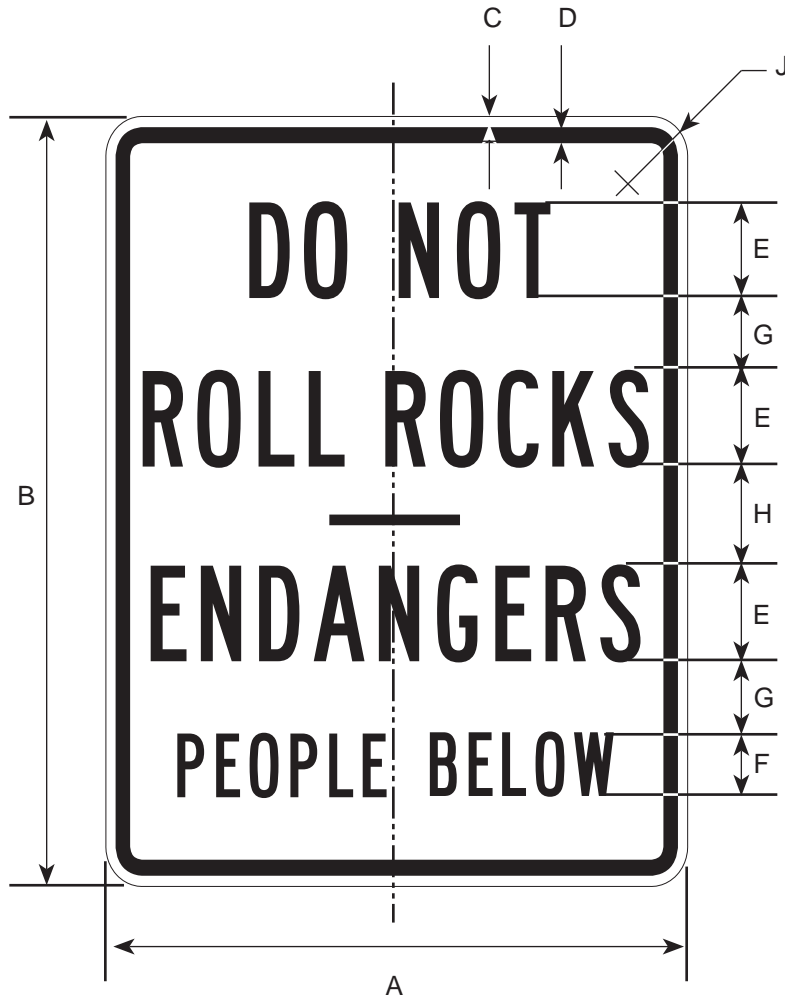

DIMENSIONS (MILLIMETERS)								
A	B	C	D	E	F	G	H	J
450	600	10	16	75B	50B	88	100	38

DIMENSIONS (INCHES)								
A	B	C	D	E	F	G	H	J
18	24	3/8	5/8	3B	2B	3 1/2	4	1 1/2

COLORS

LEGEND - BLACK (NON-REFL)
BACKGROUND - WHITE (REFL)

R18-301

11/97

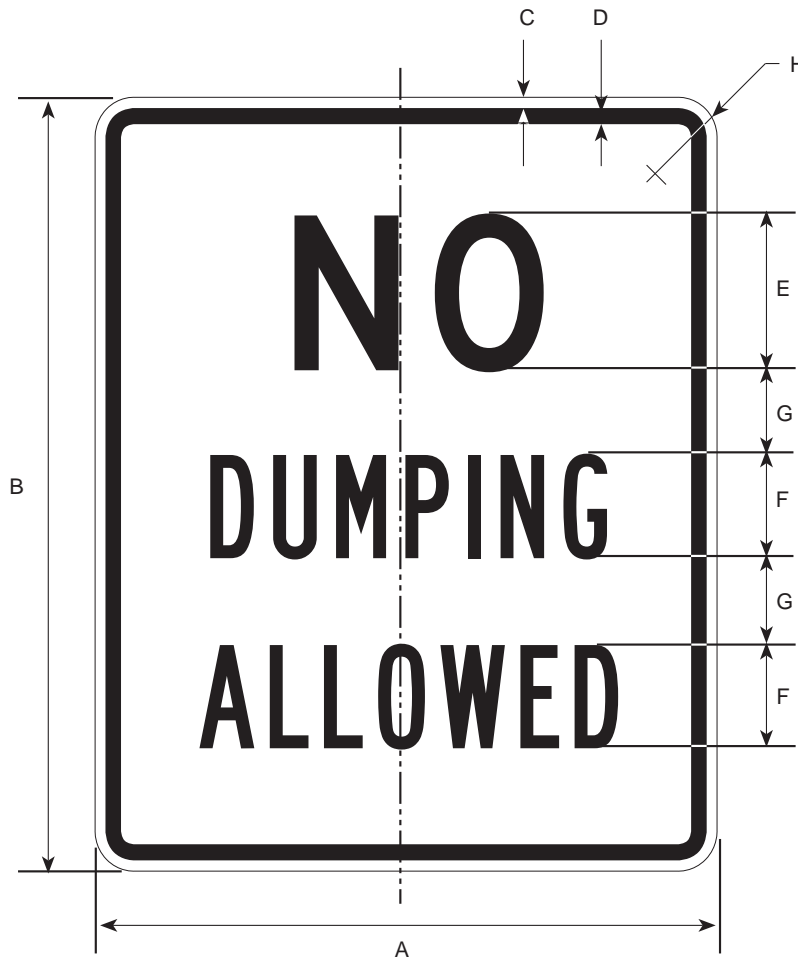

DIMENSIONS (MILLIMETERS)							
A	B	C	D	E	F	G	H
600	750	10	16	150D	100B	88	38

DIMENSIONS (INCHES)							
A	B	C	D	E	F	G	H
24	30	3/8	5/8	6D	4B	3 1/2	1 1/2

COLORS

LEGEND - BLACK (NON-REFL)
BACKGROUND - WHITE (REFL)

S1-1

6/00

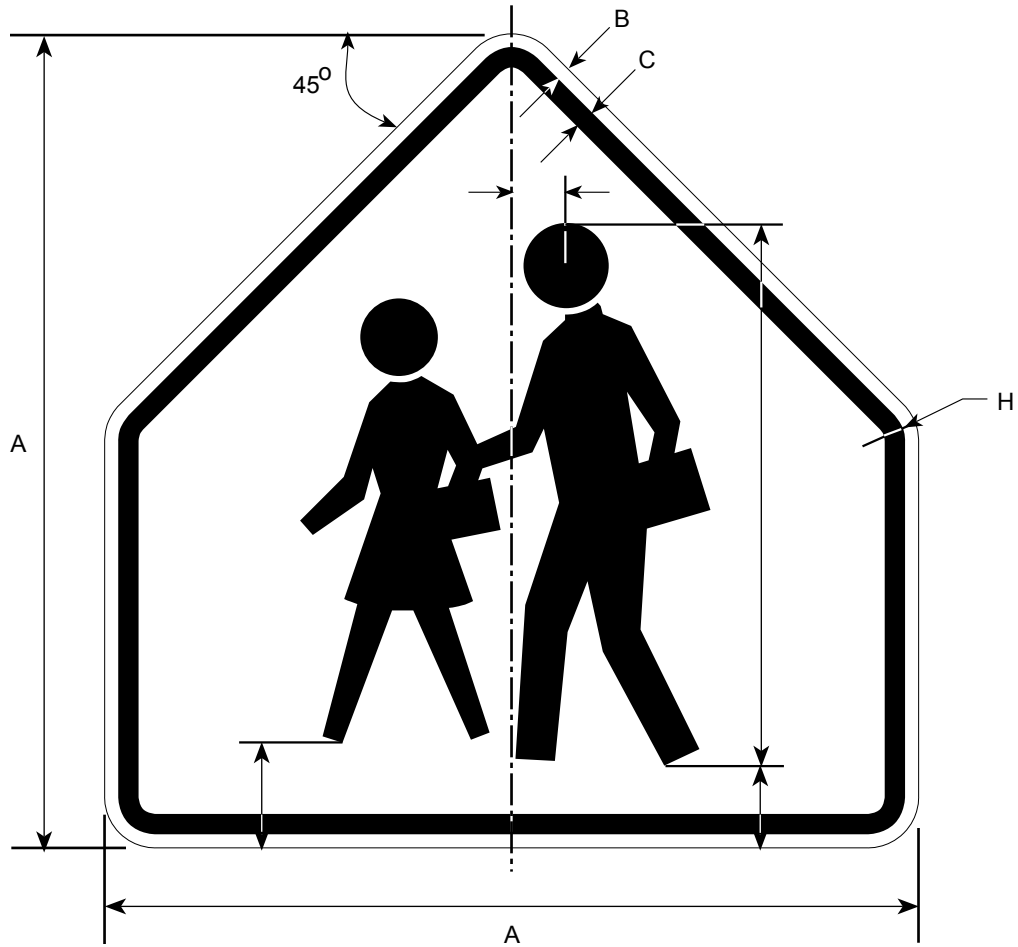

* SEE APPENDIX FOR SYMBOL DESIGN

DIMENSIONS (MILLIMETERS)							
A	B	C	D	E	F	G	H
750	13	19	50	500	75	94	47
900	16	22	63	600	88	113	56
1200	19	33	81	800	125	150	75

DIMENSIONS (INCHES)							
A	B	C	D	E	F	G	H
30	1/2	3/4	2	20	3	3 3/4	1 7/8
36	5/8	7/8	2 1/2	24	3 1/2	4 1/2	2 1/4
48	3/4	1 1/4	3 1/4	32	5	6	3

COLORS

LEGEND— BLACK (NON-REFL)
 BACKGROUND -- FLUORESCENT YELLOW GREEN (REFL)

S3-1

11/97

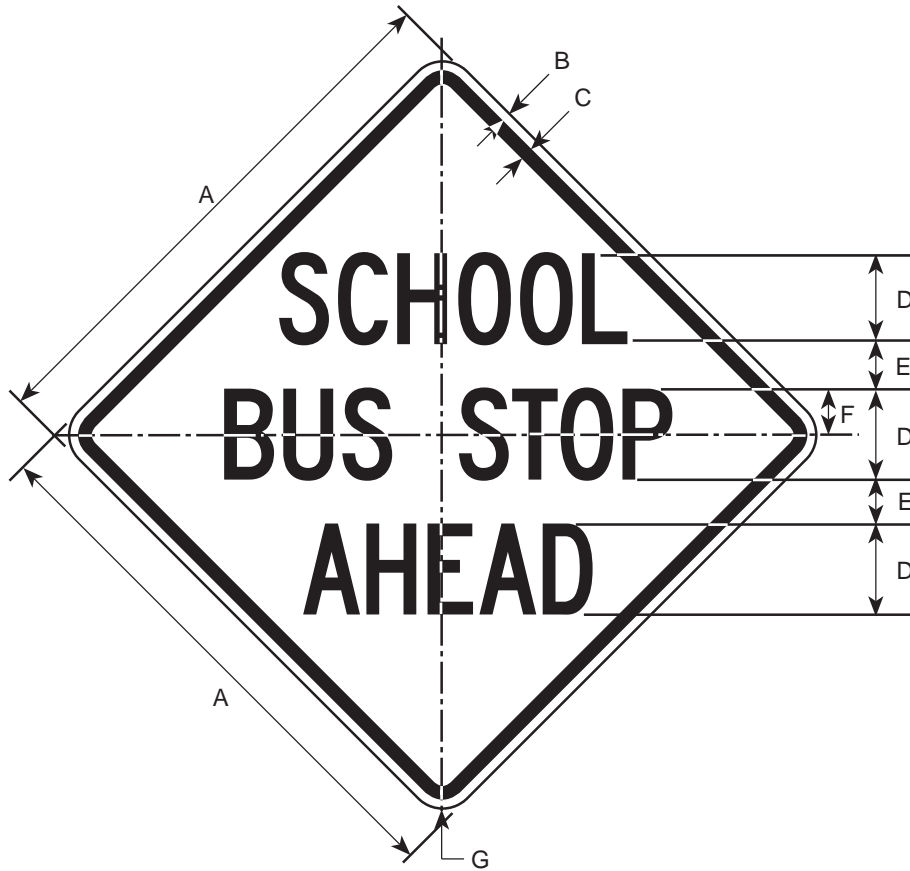

DIMENSIONS (MILLIMETERS)						
A	B	C	D	E	F	G
750	13	19	125C	50	63	47
900	16	22	150C	75	75	56
1200	19	31	200C	125	100	75

DIMENSIONS (INCHES)						
A	B	C	D	E	F	G
30	1/2	3/4	5C	2	2 1/2	1 7/8
36	5/8	7/8	6C	3	3	2 1/4
48	3/4	1 1/4	8C	5	4	3

COLORS

LEGEND -- BLACK (NON-REFL.)
 BACKGROUND -- YELLOW (REFL.)

S3-201

11/97

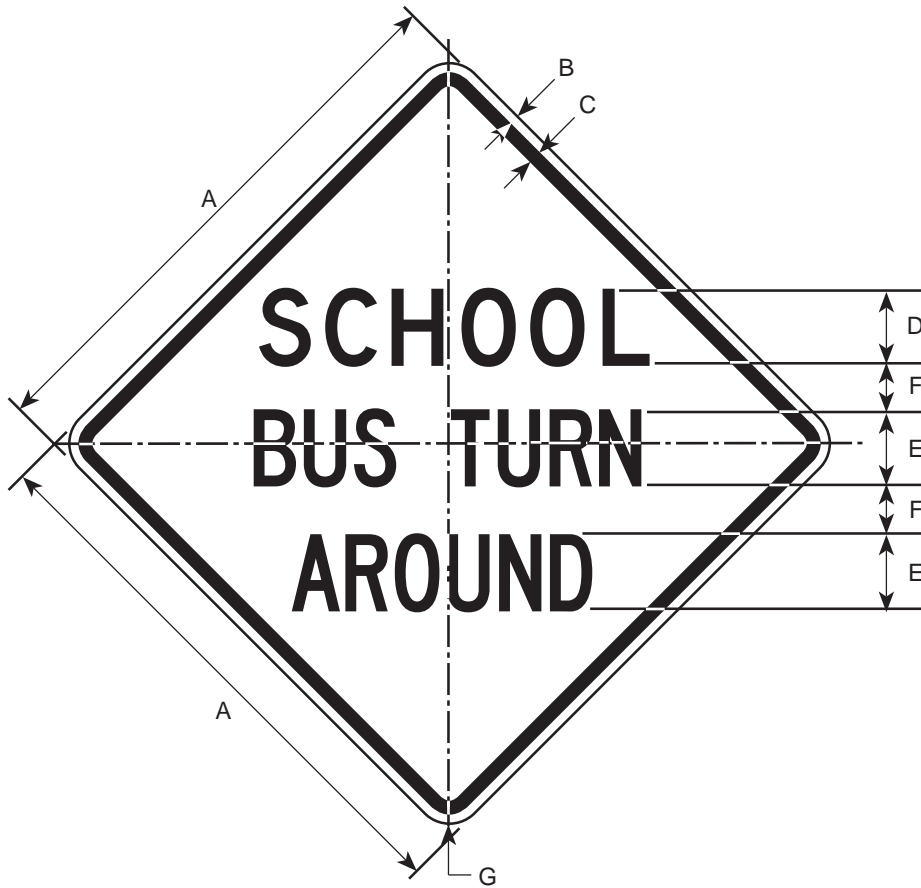

DIMENSIONS (MILLIMETERS)						
A	B	C	D	E	F	G
750	13	19	100D	100C	3	1 7/8
900	16	22	125D	125C	4	2 1/4
1200	19	31	175D	175C	5	3

DIMENSIONS (INCHES)						
A	B	C	D	E	F	G
30	1/2	3/4	4D	4C	3	1 7/8
36	5/8	7/8	5D	5C	4	12 1/4
48	3/4	1 1/4	7D	7C	5	3

COLORS

LEGEND -- BLACK (NON-REFL.)
 BACKGROUND -- YELLOW (REFL.)

S4-1

11/97

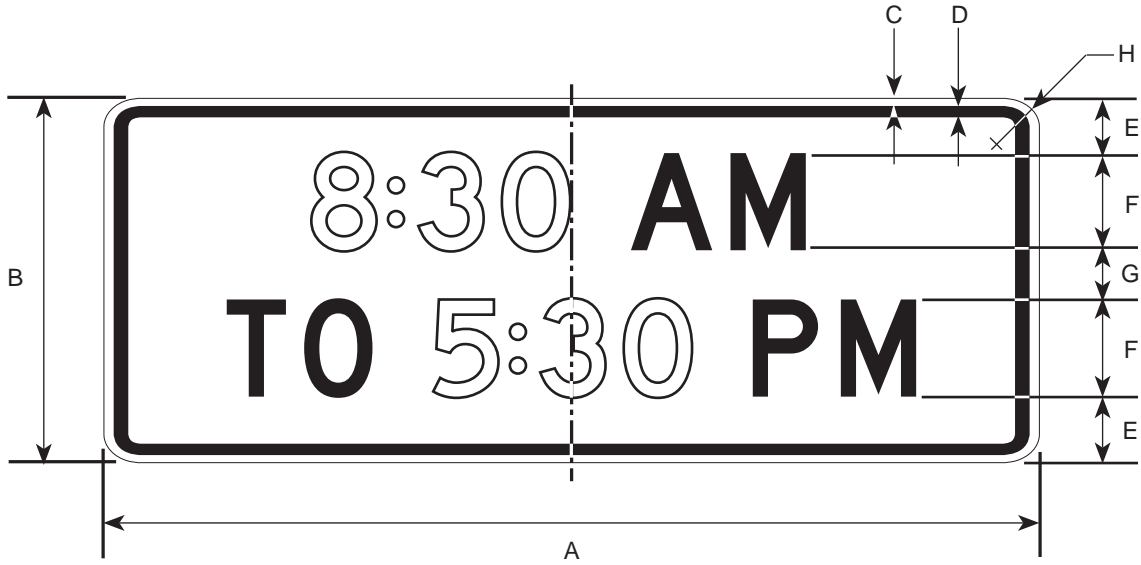

DIMENSIONS (MILLIMETERS)							
A	B	C	D	E	F	G	H
600	300	9	16	50	87D	25	38
900	450	16	22	81	125D	38	56
1200	600	19	31	11	150	62	75

DIMENSIONS (INCHES)							
A	B	C	D	E	F	G	H
24	12	5/8	5/8	2	3 1/2D	1	1 1/2
36	18	3/4	7/8	3.25	5D	1 1/2	2 1/4
48	24	1 1/4	1 1/4	4.75	6D	2 1/2	3

COLORS

LEGEND -- BLACK (NON-REFL.)
 BACKGROUND -- WHITE (REFL.)

S4-2

6/00

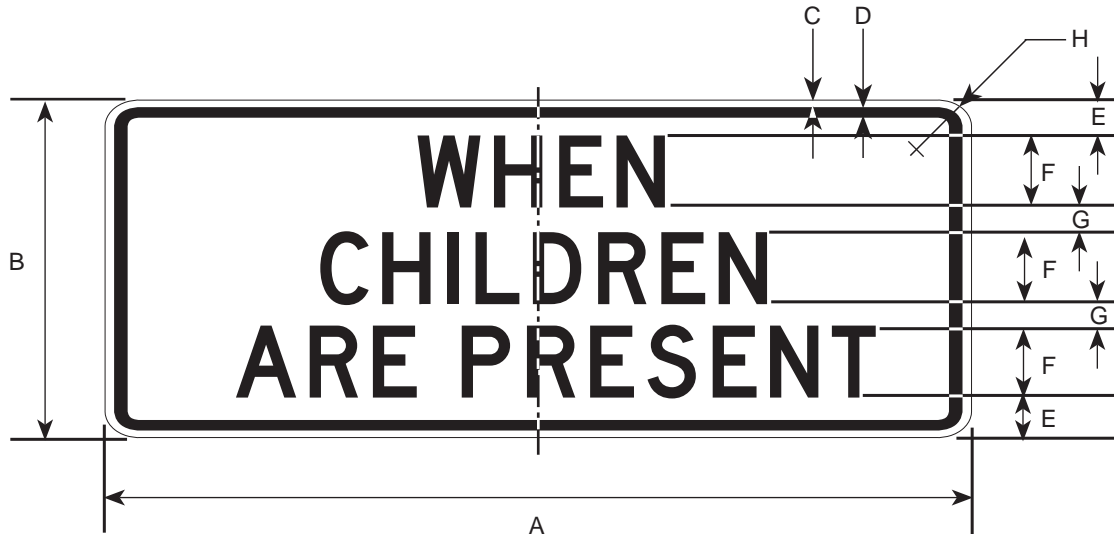

DIMENSIONS (MILLIMETERS)							
A	B	C	D	E	F	G	H
600	250	9	16	37	50D	13	38
900	375	16	22	56	75D	19	56
1200	500	19	31	75	100D	25	75

DIMENSIONS (INCHES)							
A	B	C	D	E	F	G	H
24	10	3/8	5/8	1 1/2	2D	1/2	1 1/2
36	15	5/8	7/8	2 1/4	3D	3/4	2 1/4
48	20	3/4	1 1/4	3	4D	1	3

COLORS

LEGEND -- BLACK (NON-REFL.)

BACKGROUND -- WHITE (REFL.)

S4-3

6/00

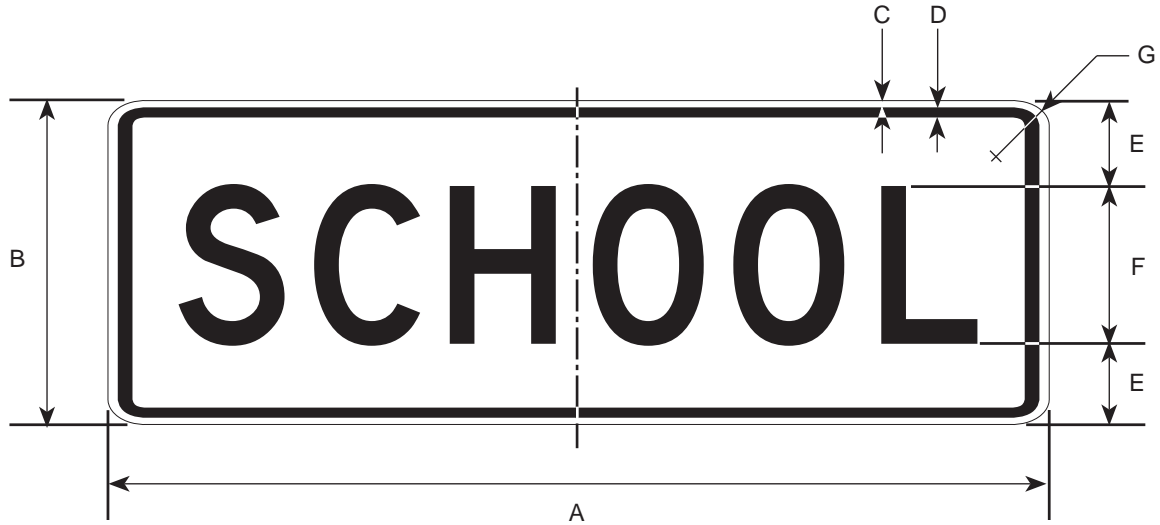

DIMENSIONS (MILLIMETERS)						
A	B	C	D	E	F	G
600	200	9	16	50	100D	38
900	300	16	22	75	150D	56
1200	400	19	31	100	200D	75

DIMENSIONS (INCHES)						
A	B	C	D	E	F	G
24	8	3/8	5/8	2	4D	1 1/2
36	12	5/8	7/8	3	6D	2 1/4
48	16	3/4	1 1/4	4	8D	3

COLORS

LEGEND -- BLACK (NON-REFL.)
 BACKGROUND -- FLUORESCENT YELLOW GREEN (REFL.)

S4-4

6/00

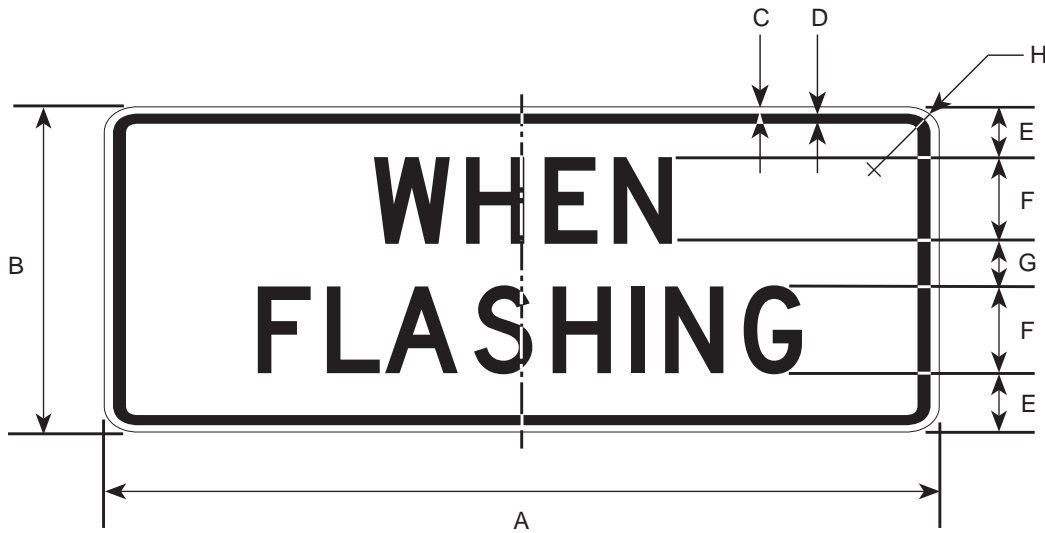

DIMENSIONS (MILLIMETERS)							
A	B	C	D	E	F	G	H
600	250	9	16	50	62.5D	25	38
900	375	16	22	69	100D	38	56
1200	500	19	31	100	125D	50	75

DIMENSIONS (INCHES)							
A	B	C	D	E	F	G	H
24	10	3/8	5/8	2	2 1/2D	1	1 1/2
36	15	5/8	7/8	2 3/4	4D	1 1/2	2 1/4
48	20	3/4	1 1/4	4	5D	2	3

COLORS

LEGEND -- BLACK (NON-REFL.)
BACKGROUND -- WHITE

S4-5 & S4-5A

5/06

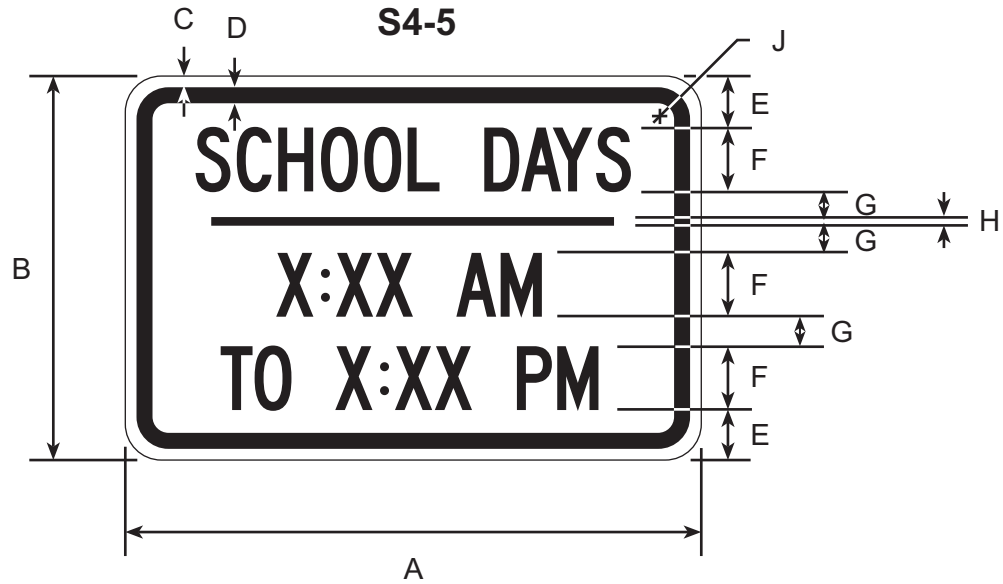

S4-5A



DIMENSIONS (MILLIMETERS)								
A	B	C	D	E	F	G	H	J
600	450	9	16	69	63C	38	16	38
900	600	16	22	81	100C	38	22	56

DIMENSIONS (INCHES)								
A	B	C	D	E	F	G	H	J
24	18	3/8	5/8	2 3/4	2 1/2C	1 1/2	5/8	1 1/2
36	24	5/8	7/8	3 1/4	4C	1 1/2	7/8	2 1/4

COLORS

LEGEND & BORDER - BLACK (NON-REFL)
BACKGROUND - WHITE (REFL)

S4-501

11/97



DIMENSIONS (MILLIMETERS)						
A	B	C	D	E	F	G
600	250	9	16	63D	25	47
900	375	16	22	100D	38	56
1200	500	19	31	125D	50	75

DIMENSIONS (INCHES)						
A	B	C	D	E	F	G
24	10	3/8	5/8	2 1/2D	1	1 1/2
36	15	5/8	7/8	4D	1 1/2	2 1/4
48	20	3/4	1 1/4	5D	2	3

COLORS

LEGEND -- BLACK (NON-REFL.)
 BACKGROUND -- WHITE (REFL.)

S5-1

6/00

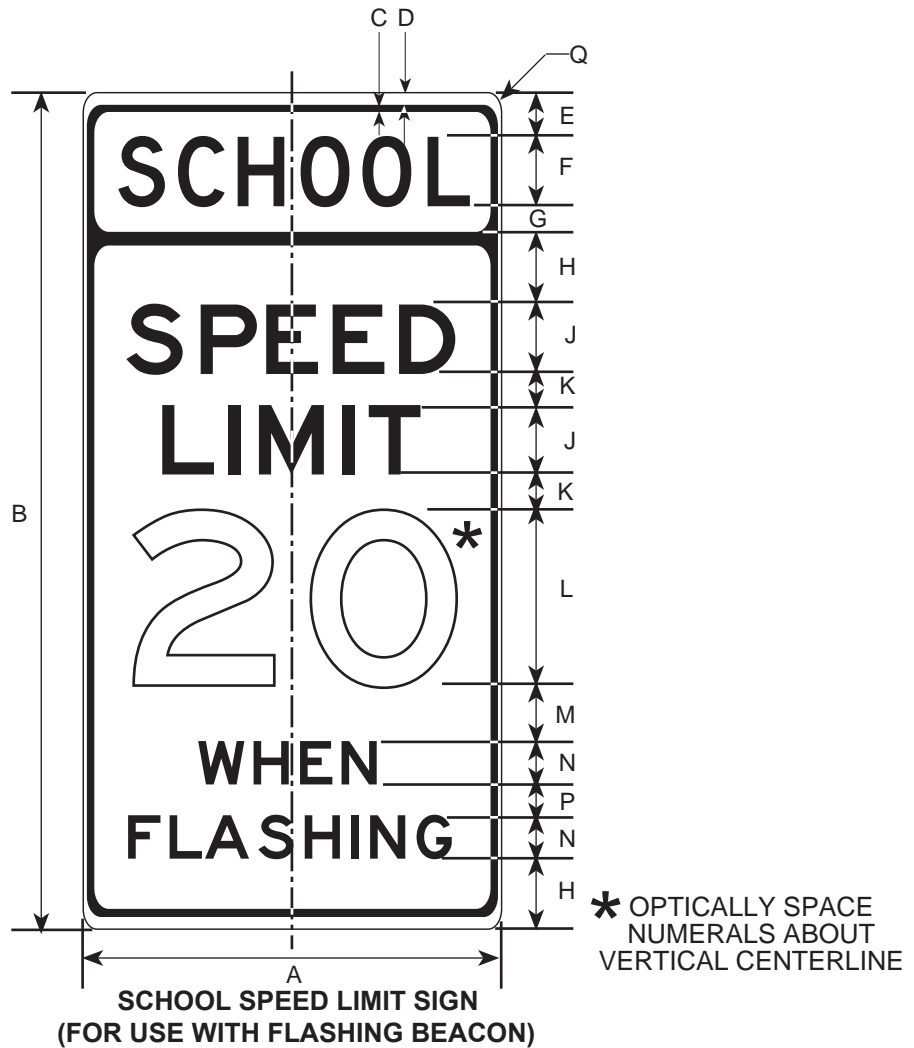

DIMENSIONS (MILLIMETERS)														
A	B	C	D	E	F	G	H	J	K	L	M	N	P	Q
600	1200	9	16	62.5	100D	37.5	100	100E	50	250E	75	62.5D	50	38
900	1800	16	22	94	125D	56	150	150E	100	350E	100	100D	50	56
1200	1400	22	31	125	200D	75	200	200E	150	450E	150	125D	100	75

DIMENSIONS (INCHES)														
A	B	C	D	E	F	G	H	J	K	L	M	N	P	Q
24	48	3/8	5/8	2 1/2	4D	1 1/2	4	4E	2	10E	3	2 1/2D	2	1 1/2
36	72	5/8	7/8	3 3/4	6D	2 1/4	6	6E	4	14E	4	4D	2	2 1/4
48	96	7/8	1 1/4	5	8D	3	8	8E	6	16E	6	5D	4	3

COLORS

TOP
LEGEND - BLACK (NON-REFL)
BACKGROUND - FLUORESCENT YELLOW GREEN (REFL)

BOTTOM
LEGEND - BLACK (NON-REFL)
BACKGROUND - WHITE (REFL)

S5-101

6/00

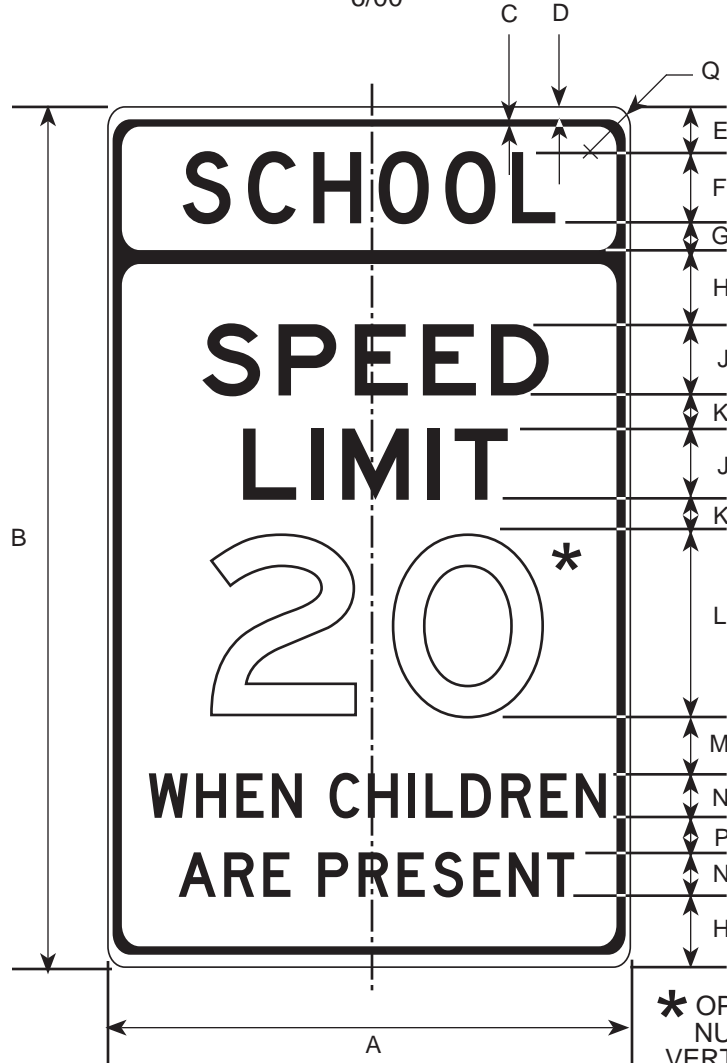

* OPTICALLY SPACE NUMERALS ABOUT VERTICAL CENTERLINE

DIMENSIONS (MILLIMETERS)														
A	B	C	D	E	F	G	H	J	K	L	M	N	P	Q
750	1200	9	16	62.5	100D	37.5	100	100E	50	250E	75	62.5D	50	38
1200	1800	16	22	94	150D	56	150	150E	100	350E	100	100D	50	56
1500	2400	22	31	125	200D	75	200	200E	150	400E	150	125D	100	75

DIMENSIONS (INCHES)														
A	B	C	D	E	F	G	H	J	K	L	M	N	P	Q
30	48	3/8	5/8	2 1/2	4D	1 1/2	4	4E	2	10E	3	2 1/2D	2	1 1/2
48	72	5/8	7/8	3 3/4	6D	2 1/4	6	6E	4	14E	4	4D	2	2 1/4
60	96	7/8	1 1/4	5	8D	3	8	8E	6	16E	6	5D	4	3

COLORS

TOP
 LEGEND - BLACK (NON-REFL)
 BACKGROUND - FLUORESCENT YELLOW GREEN (REFL)

BOTTOM
 LEGEND - BLACK (NON-REFL)
 BACKGROUND - WHITE (REFL)

S5-2

11/97

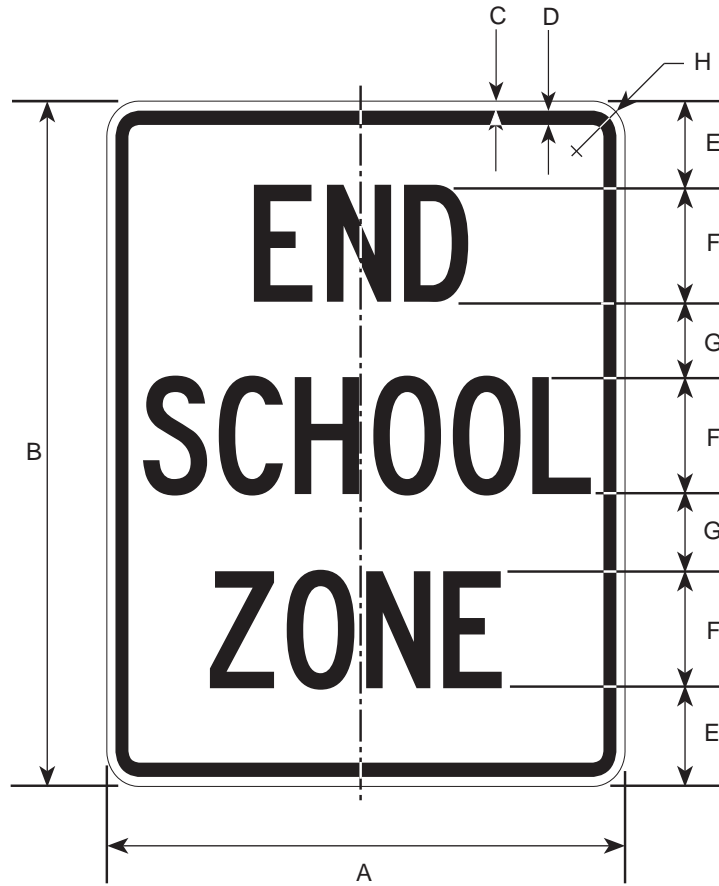

DIMENSIONS (MILLIMETERS)							
A	B	C	D	E	F	G	H
450	600	9	16	88	100C	63	38
600	750	9	16	100	125C	88	38
900	1200	16	22	163	200C	138	56

DIMENSIONS (INCHES)							
A	B	C	D	E	F	G	H
18	24	3/8	5/8	3 1/2	4C	2 1/2	1 1/2
24	30	3/8	5/8	4	5C	3 1/2	1 1/2
36	48	5/8	7/8	6 1/2	8C	5 1/2	2 1/4

COLORS

LEGEND -- BLACK (NON-REFL.)
 BACKGROUND -- WHITE (REFL.)

W1-1L & W1-1R

11/97

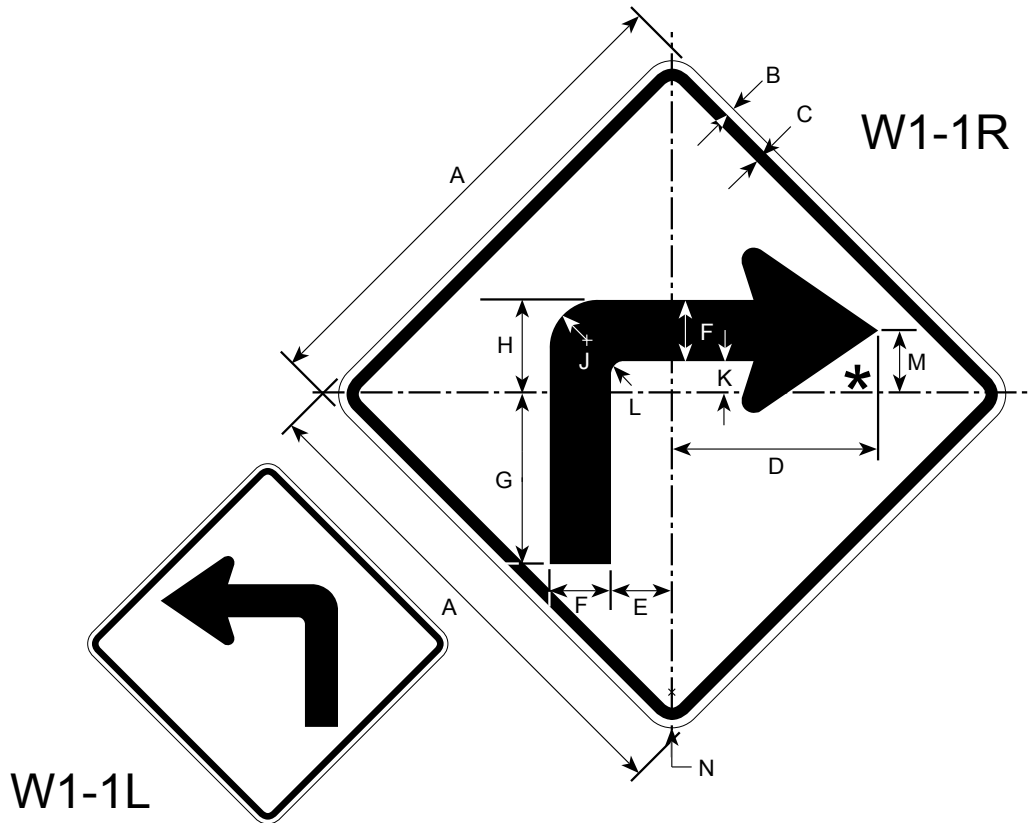

* SEE APPENDIX FOR STANDARD ARROW

DIMENSIONS (MILLIMETERS)												
A	B	C	D	E	F	G	H	J	K	L	M	N
450	9	16	181	56	66	147	94	47	25	16	63	38
600	9	16	241	75	88	194	125	63	38	20	81	38
750	13	19	300	94	109	242	156	75	47	25	102	47
900	16	22	359	111	131	291	188	91	63	31	122	56
1200	19	31	480	150	175	388	250	122	75	41	163	75

DIMENSIONS (INCHES)												
A	B	C	D	E	F	G	H	J	K	L	M	N
18	3/8	5/8	7 1/4	2 1/4	2 5/8	5 7/8	3 3/4	1 7/8	1	5/8	2 1/2	1 1/2
24	3/8	5/8	9 5/8	3	3 1/2	7 3/4	5	2 1/2	1 1/2	13/16	3 1/4	1 1/2
30	1/2	3/4	12	3 3/4	4 3/8	9	6 1/4	3	1 7/8	1	4 1/16	1 7/8
36	5/8	7/8	14 3/8	4 1/2	5 1/4	11	7 1/2	3 5/8	2 1/4	1 1/4	4 7/8	2 1/4
48	3/4	1 1/4	19 3/16	6	7	15 1/2	10	4 7/8	3	1 5/8	6 1/2	3

COLORS

LEGEND — BLACK (NON-REFL)
BACKGROUND — YELLOW (REFL)

W1-2L & W1-2R

11/97

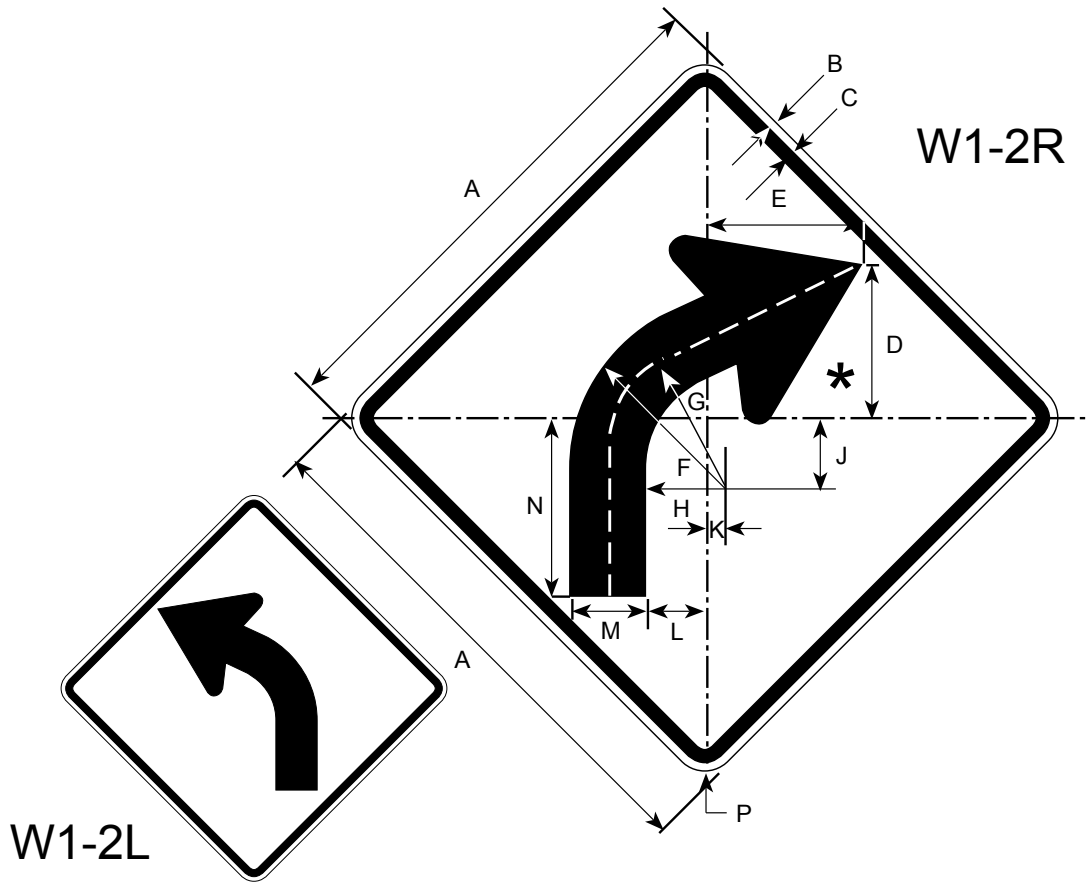

* SEE APPENDIX FOR STANDARD ARROW DETAILS

DIMENSIONS (MILLIMETERS)													
A	B	C	D	E	F	G	H	J	K	L	M	N	P
450	9	16	134	138	150	11	84	44	31	50	66	156	38
600	9	16	178	181	200	156	11	59	44	69	88	206	38
750	13	19	222	227	250	195	141	73	55	86	109	258	47
900	16	22	266	272	300	234	168	88	66	103	131	309	56
1200	19	31	355	363	400	313	225	11	88	138	175	406	75

DIMENSIONS (INCHES)													
A	B	C	D	E	F	G	H	J	K	L	M	N	P
18	3/8	5/8	5 3/8	5 1/2	6	4 3/4	3 3/8	1 3/4	1 1/4	2	2 5/8	6 1/4	1 1/2
24	3/8	5/8	7 1/8	7 1/4	8	6 1/4	4 1/2	2	1 3/4	2 3/4	3 1/2	8 1/4	1 1/2
30	1/2	3/4	8 7/8	9 1/16	10	7 13/16	5 5/8	2 15/16	2 3/16	3 7/16	4 3/8	10 5/16	1 7/8
36	5/8	7/8	10 7/8	10 7/8	12	9 3/8	6 3/4	3 1/2	2 5/8	4 1/8	5 1/4	12 3/8	2 1/4
48	3/4	1 1/4	14 13/16	14 1/2	16	12 1/2	9	4	3 1/2	5 1/2	7	16 1/2	3

COLORS

LEGEND — BLACK (NON-REFL)
 BACKGROUND — YELLOW (REFL)

W1-3L & W1-3R

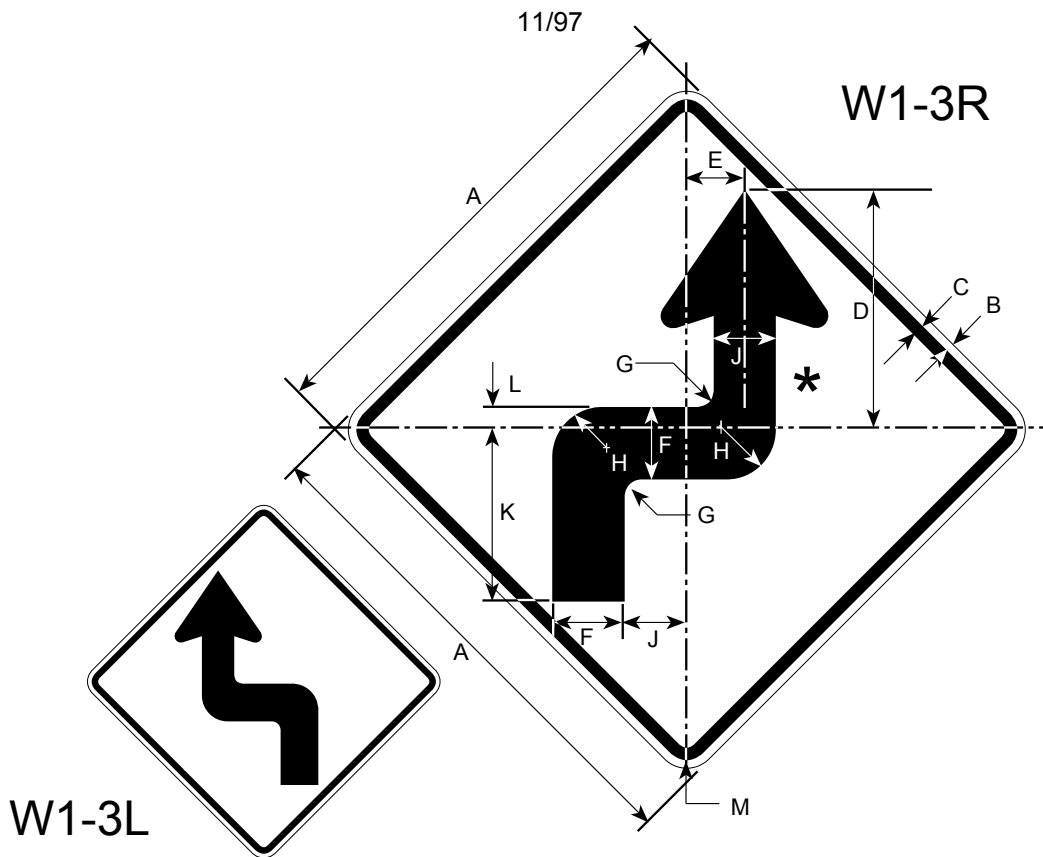

* SEE APPENDIX FOR STANDARD ARROW DETAILS

DIMENSIONS (MILLIMETERS)											
A	B	C	D	E	F	G	H	J	K	L	M
600	9	16	290	70	88	21	63	75	208	27	38
750	13	19	363	88	109	25	75	94	259	34	47
900	16	22	436	105	131	31	91	113	312	41	56
1200	19	31	580	141	175	41	122	150	416	55	75

DIMENSIONS (INCHES)											
A	B	C	D	E	F	G	H	J	K	L	M
24	3/8	5/8	11	2 13/16	3 1/2	13/16	2 1/2	3	8 5/16	1 3/32	1 1/2
30	1/2	3/4	14 1/2	3 1/2	4 3/8	1	3	3 3/4	10 3/8	1 3/8	1 7/8
36	5/8	7/8	17 7/16	4 7/32	5 1/4	1 1/4	3 5/8	4 1/2	12 15/32	1 21/32	2 1/4
48	3/4	1 1/4	23 3/16	5 5/8	7	1 5/8	4 7/8	6	16 5/8	2 3/16	3

COLORS

LEGEND — BLACK (NON-REFL)
BACKGROUND — YELLOW (REFL)

W1-4L & W1-4R

11/97

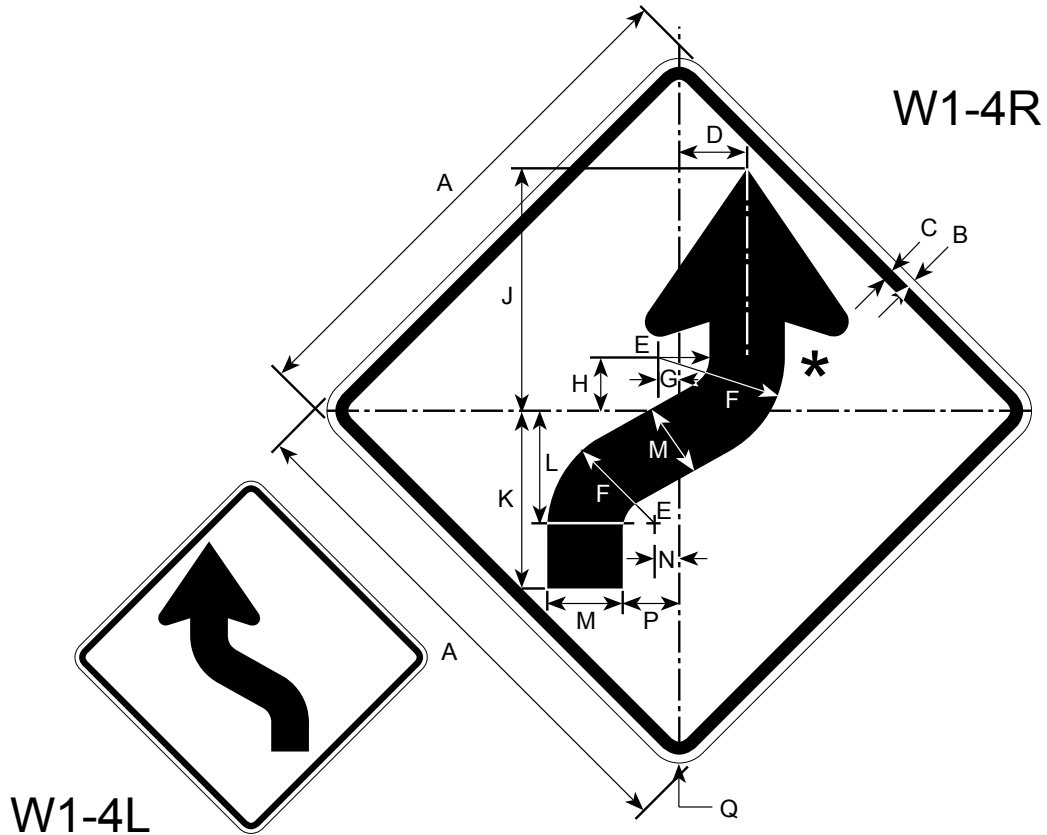

* See appendix for standard arrow details

DIMENSIONS (MILLIMETERS)														
A	B	C	D	E	F	G	H	J	K	L	M	N	P	Q
450	9	16	59	28	94	1	66	216	156	100	66	22	50	28
600	9	16	83	38	125	2	88	250	206	131	88	28	59	38
750	13	19	99	47	156	3	109	351	258	164	109	34	84	47
900	16	22	111	63	191	4	131	422	309	197	131	42	99	63
1200	19	31	158	75	250	5	175	563	413	263	175	63	131	75

DIMENSIONS (INCHES)														
A	B	C	D	E	F	G	H	J	K	L	M	N	P	Q
18	3/8	5/8	2 3/8	1 1/8	3 3/4	1/16	2 5/8	8 5/8	6 1/4	4	2 5/8	7/8	2	1 1/2
24	3/8	5/8	3 5/32	1 1/2	5	3/32	3 1/2	11	8 1/4	5 1/4	3 1/2	1 1/8	2 5/8	1 1/2
30	1/2	3/4	3 15/16	1 7/8	6 1/4	1/8	4 3/8	14 1/16	10 15/16	6 9/16	4 3/8	1 13/16	3 9/32	1 7/8
36	5/8	7/8	4 23/32	2 1/4	7 1/2	5/32	5 1/4	16 7/8	12 3/8	7 7/8	5 1/4	1	3 15/16	2 1/4
48	3/4	1 1/4	6 5/16	3	10	3/16	7	22 1/2	16 1/2	10 1/2	7	2 1/4	5 1/4	3

COLORS

LEGEND — BLACK (NON-REFL)
BACKGROUND — YELLOW (REFL)

W1-4BR

11/97

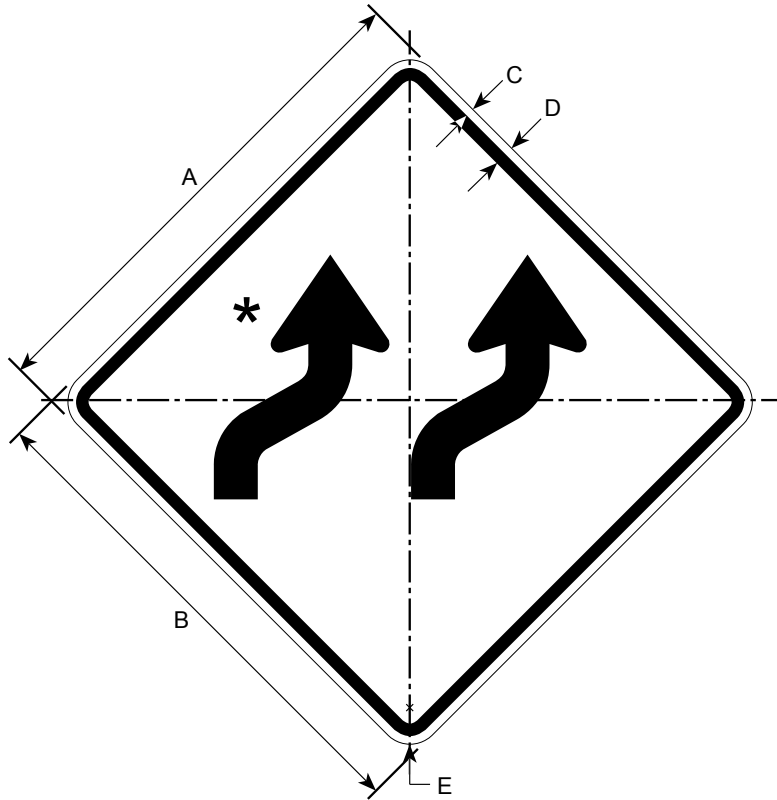

* SEE APPENDIX FOR STANDARD ARROW DETAILS

DIMENSIONS (MILLIMETERS)				
A	B	C	D	E
600	600	9	16	38
750	750	13	19	47
900	900	16	22	56
1200	1200	19	31	75

DIMENSIONS (INCHES)				
A	B	C	D	E
24	24	3/8	5/8	1 1/2
30	30	1/2	3/4	1 7/8
36	36	5/8	7/8	2 1/4
48	48	3/4	1 1/4	3

COLORS
 LEGEND—BLACK (NON-REFL)
 BACKGROUND—ORANGE (REFL)

W1-4CR

11/97

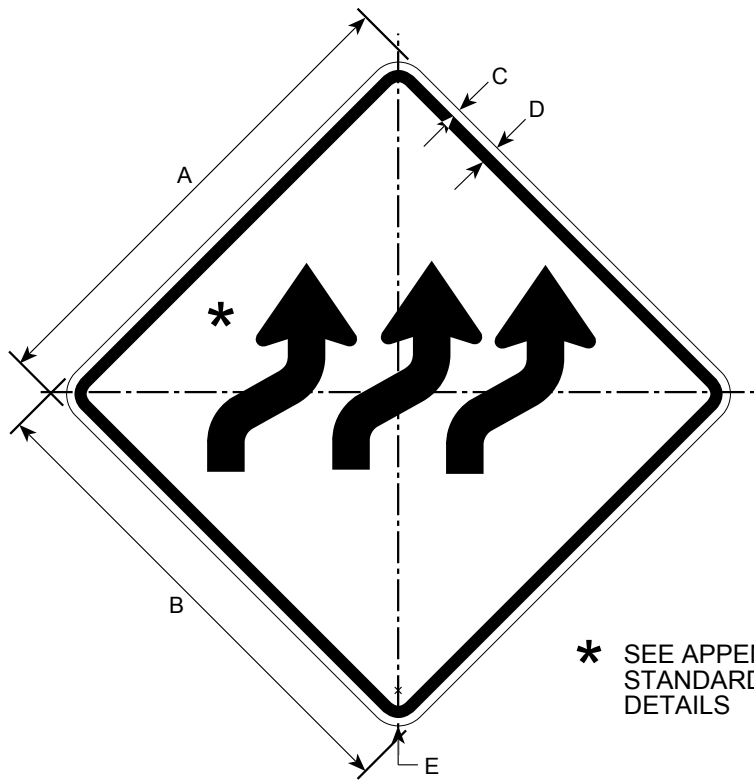

* SEE APPENDIX FOR
STANDARD ARROW
DETAILS

DIMENSIONS (MILLIMETERS)				
A	B	C	D	E
600	600	9	16	38
750	750	13	19	47
900	900	16	22	56
1200	1200	19	31	75

DIMENSIONS (INCHES)				
A	B	C	D	E
24	24	3/8	5/8	1 1/2
30	30	1/2	3/4	1 7/8
36	36	5/8	7/8	2 1/4
48	48	3/4	1 1/4	3

COLORS

LEGEND - BLACK (NON-REFL.)
BACKGROUND - ORANGE (REFL.)

W1-5L

11/97

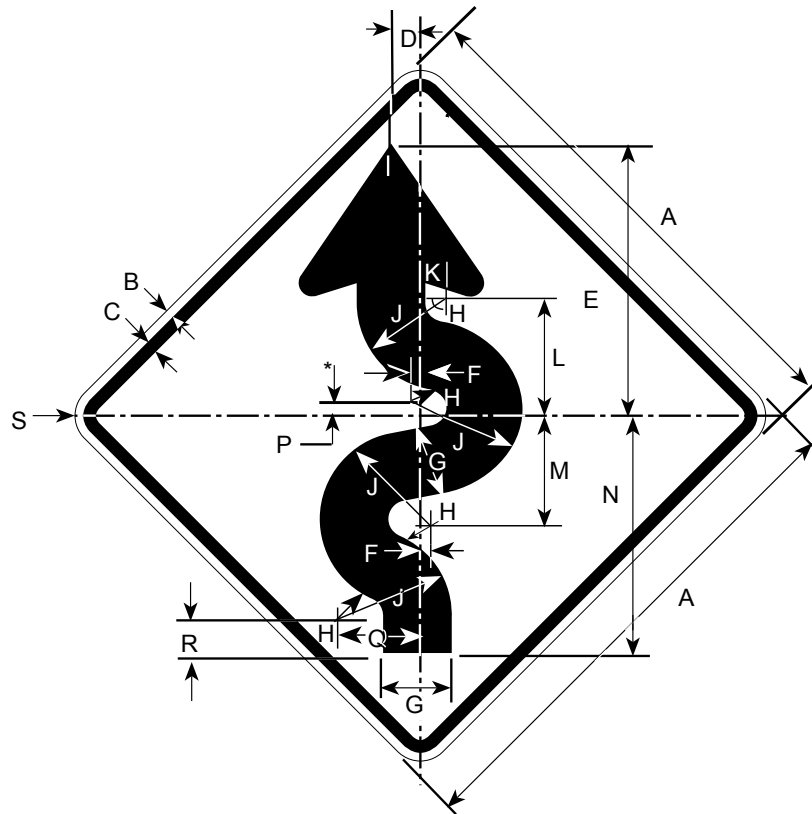

* SEE APPENDIX FOR STANDARD ARROW DETAILS

DIMENSIONS (MILLIMETERS)																
A	B	C	D	E	F	G	H	J	K	L	M	N	P	Q	R	S
450	9	16	25	241	9	63	16	75	25	100	100	216	6	50	31	38
600	9	16	31	319	13	94	22	103	31	130	131	284	6	63	40	38
750	13	19	39	399	16	102	27	133	39	149	164	355	8	81	50	47
900	16	22	47	478	19	122	33	155	47	195	197	427	9	94	60	56
1200	19	31	63	638	25	163	44	206	62	260	262	569	13	125	80	75

DIMENSIONS (INCHES)																
A	B	C	D	E	F	G	H	J	K	L	M	N	P	Q	R	S
18	3/8	5/8	1	9 5/8	3/8	2 1/2	5/8	3	1	4	4	8 5/8	1/4	2	1 1/4	1 1/2
24	3/8	5/8	1 1/4	12 3/4	1/2	3 1/4	7/8	4 1/8	1 1/4	5 3/16	5 1/4	11	1/4	2 1/2	1 19/32	1 1/2
30	1/2	3/4	1 9/16	15 1/16	5/8	4 1/16	1 3/32	5 5/32	1 9/16	6 31/64	6 9/16	14 7/32	5/16	3 1/8	2	1 7/8
36	5/8	7/8	1 7/8	19 1/8	3/4	4 7/8	1 5/16	6 3/16	1 7/8	7 25/32	7 7/8	17 1/16	3/8	3 3/4	2 13/32	2 1/4
48	3/4	1 1/4	2 1/2	25 1/2	1	6 1/2	1 3/4	8 1/4	10 1/2	10 3/8	10 1/2	22 3/4	1/2	5	3 3/16	3

COLORS
 LEGEND — BLACK (NON-REFL)
 BACKGROUND — YELLOW (REFL)

W1-5R

11/97

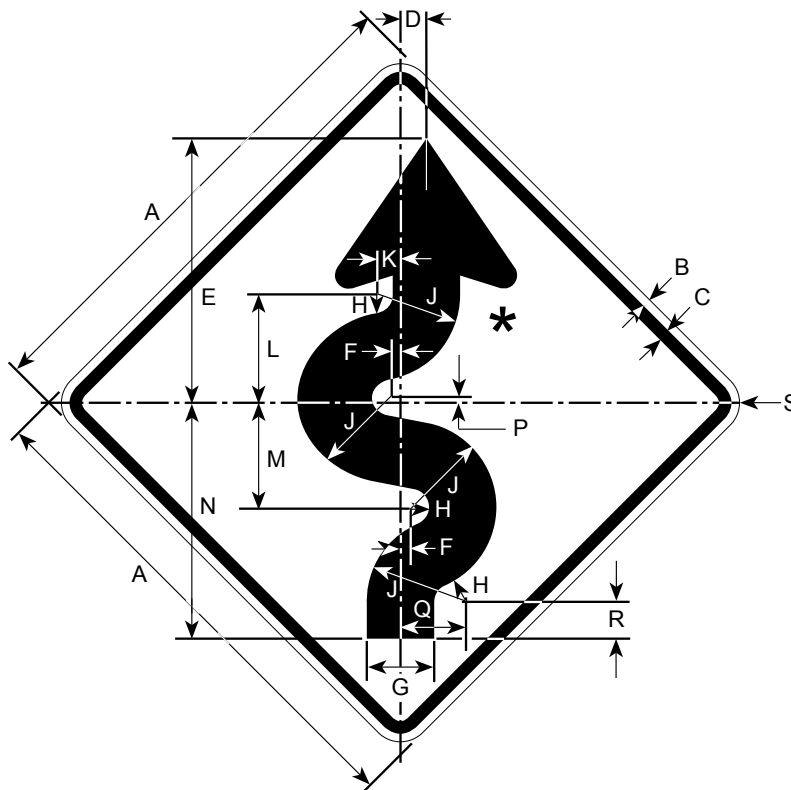

* SEE APPENDIX FOR STANDARD ARROW DETAILS

DIMENSIONS (MILLIMETERS)																
A	B	C	D	E	F	G	H	J	K	L	M	N	P	Q	R	S
450	9	16	25	241	9	63	16	75	25	100	100	216	6	50	31	38
600	9	16	31	319	13	94	22	103	31	130	131	284	6	63	40	38
750	13	19	39	399	16	102	27	133	39	149	164	355	8	81	50	47
900	16	22	47	478	19	122	33	155	47	195	197	427	9	94	60	56
1200	19	31	63	638	25	163	44	206	62	260	262	569	13	125	80	75

DIMENSIONS (INCHES)																
A	B	C	D	E	F	G	H	J	K	L	M	N	P	Q	R	S
18	3/8	5/8	1	9 5/8	3/8	2 1/2	5/8	3	1	4	4	8 5/8	1/4	2	1 1/4	1 1/2
24	3/8	5/8	1 1/4	12 3/4	1/2	3 1/4	7/8	4 1/8	1 1/4	5 3/16	5 1/4	11	1/4	2 1/2	1 19/32	1 1/2
30	1/2	3/4	1 9/16	15 1/16	5/8	4 1/16	1 3/32	5 5/32	1 9/16	6 31/64	6 9/16	14 7/32	5/16	3 1/8	2	1 7/8
36	5/8	7/8	1 7/8	19 1/8	3/4	4 7/8	1 5/16	6 3/16	1 7/8	7 25/32	7 7/8	17 1/16	3/8	3 3/4	2 13/32	2 1/4
48	3/4	1 1/4	2 1/2	25 1/2	1	6 1/2	1 3/4	8 1/4	10 1/2	10 3/8	10 1/2	22 3/4	1/2	5	3 3/16	3

COLORS

LEGEND — BLACK (NON-REFL)
 BACKGROUND — YELLOW (REFL)

W1-6

11/97

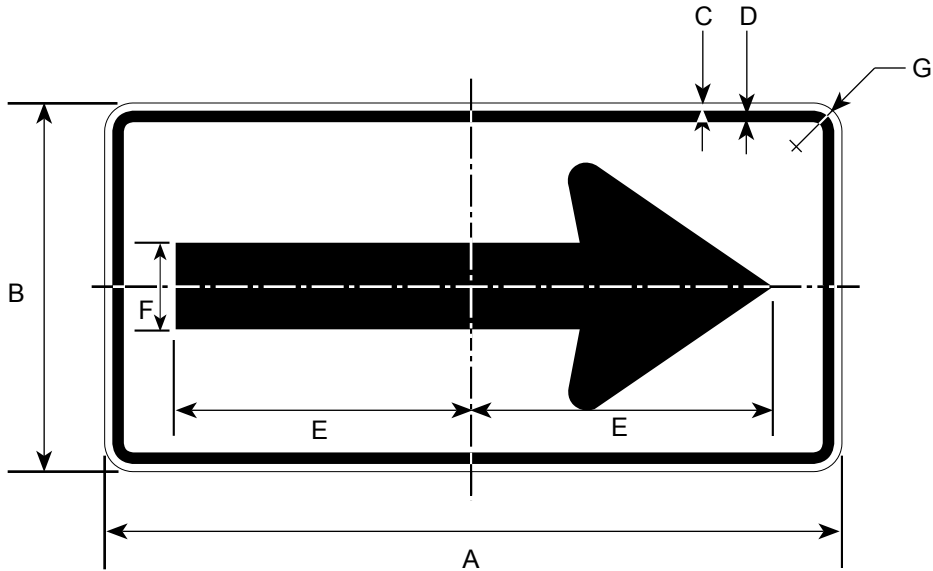

* SEE APPENDIX FOR STANDARD ARROW DETAILS

DIMENSIONS (MILLIMETERS)						
A	B	C	D	E	F	G
600	300	9	16	241	81	38
900	450	9	16	366	125	38
1200	600	13	19	488	163	47
1500	750	16	22	609	200	56
2400	1200	19	31	975	313	75

DIMENSIONS (INCHES)						
A	B	C	D	E	F	G
24	12	3/8	5/8	9 5/8	3 1/4	1 1/2
36	18	3/8	5/8	14 5/8	5	1 1/2
48	24	1/2	3/4	19 1/2	6 1/2	1 7/8
60	30	5/8	7/8	24 3/8	8	2 1/4
96	48	3/4	1 1/4	39	12 1/2	3

COLORS

LEGEND — BLACK (NON-REFL)
BACKGROUND — YELLOW (REFL)

W1-7

11/97

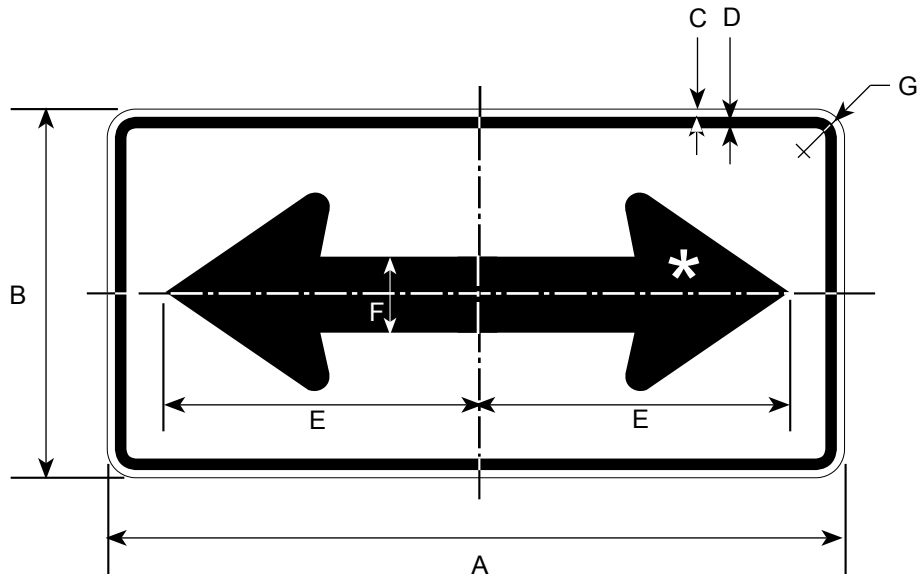

* SEE APPENDIX FOR STANDARD ARROW DETAILS

DIMENSIONS (MILLIMETERS)						
A	B	C	D	E	F	G
600	300	9	16	259	81	38
900	450	9	16	391	125	38
1200	600	13	19	513	163	47
1500	750	16	22	634	200	56
2400	1200	19	31	1025	313	75

DIMENSIONS (INCHES)						
A	B	C	D	E	F	G
24	12	3/8	5/8	10 3/8	3 1/4	1 1/2
36	18	3/8	5/8	15 5/8	5	1 1/2
48	24	1/2	3/4	20 1/2	6 1/2	1 7/8
60	30	5/8	7/8	25 3/8	8	2 1/4
96	48	3/4	1 1/4	41	12 1/2	3

COLORS

LEGEND — BLACK (NON-REFL)
 BACKGROUND — YELLOW (REFL)

W1-8

11/97

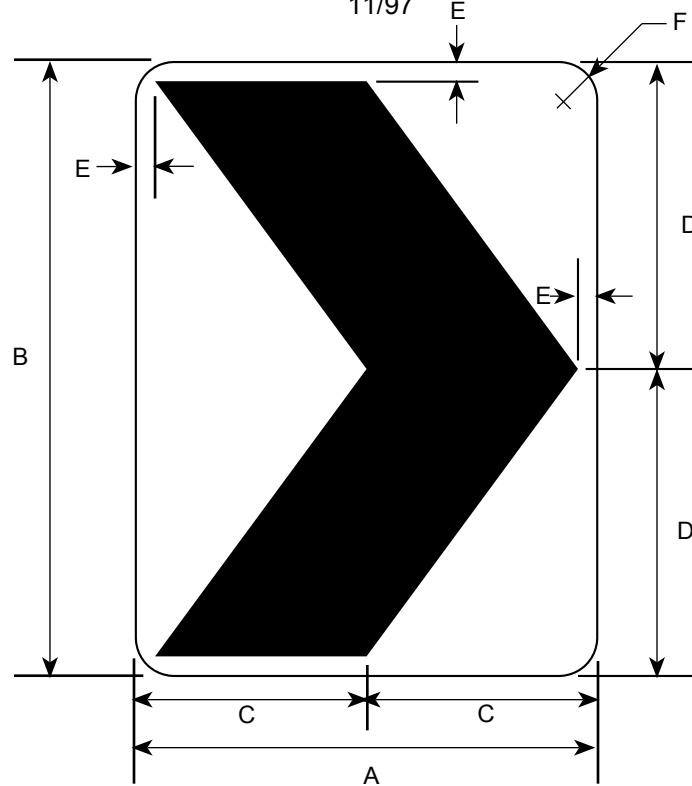

* SEE APPENDIX FOR STANDARD ARROW DETAILS

DIMENSIONS (MILLIMETERS)					
A	B	C	D	E	F
300	450	150	225	13	38
450	600	225	300	19	38
600	750	300	375	22	38
750	900	375	450	25	47
900	1200	450	600	28	56

DIMENSIONS (INCHES)					
A	B	C	D	E	F
12	18	6	9	1/2	1 1/2
18	24	9	12	3/4	1 1/2
24	30	12	15	7/8	1 1/2
30	36	15	18	1	1 7/8
36	48	18	24	1 1/8	2 1/4

COLORS

CHEVRON — BLACK (NON-REFL)
 BACKGROUND — YELLOW (REFL)

W1-901L & W1-901R

11/97

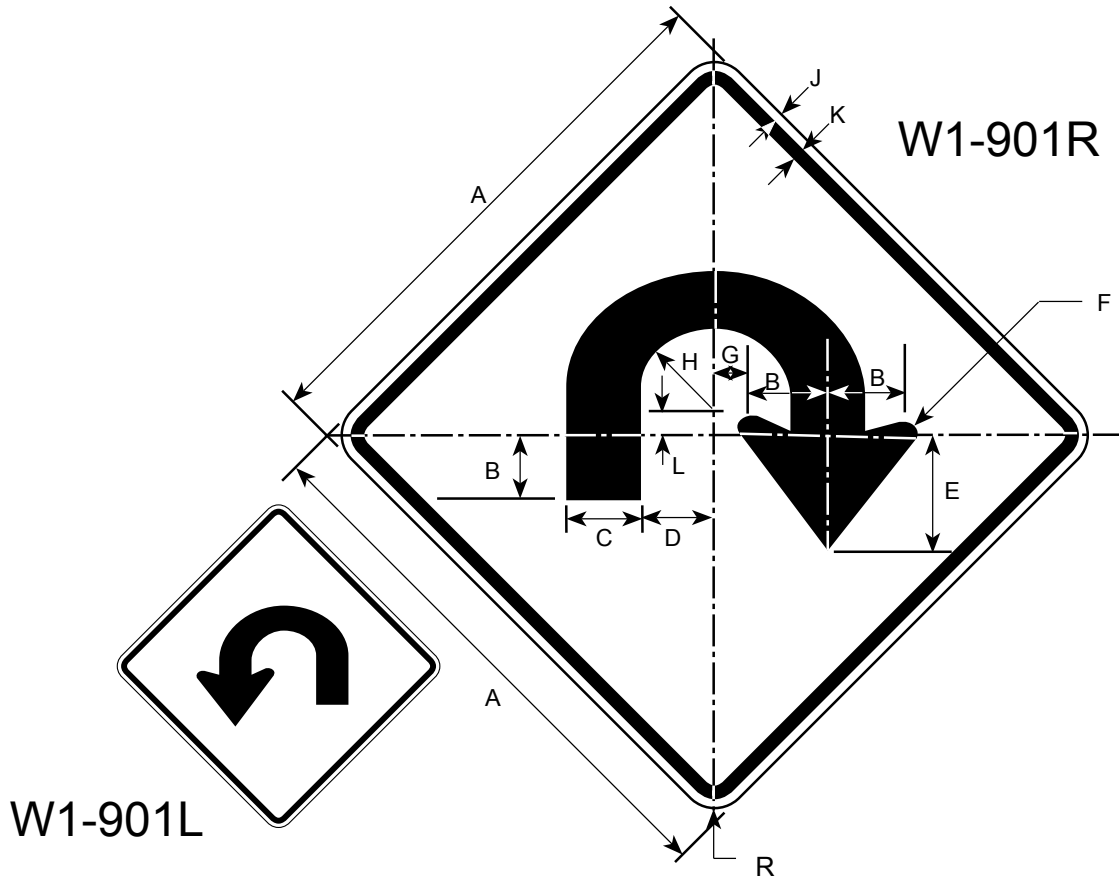

* SEE APPENDIX FOR STANDARD ARROW DETAILS

DIMENSIONS (MILLIMETERS)											
A	B	C	D	E	F	G	H	J	K	L	M
750	125	109	144	219	19	6	192	22	13	19	47
900	150	130	172	263	24	6	231	28	16	22	56
1200	200	175	231	350	30	9	309	38	19	31	75

DIMENSIONS (INCHES)											
A	B	C	D	E	F	G	H	J	K	L	M
30	5	4 3/8	5 3/4	8 3/4	3/4	1/4	7	7/8	1/2	3/4	1 7/8
36	6	5 1/4	6 7/8	10 1/2	15/16	1/4	7 1/2	1 1/8	5/8	7/8	2 1/4
48	8	7	9 1/4	14	1 3/16	3/8	9	1 1/2	3/4	1 1/4	3

COLORS

LEGEND - BLACK (NON-REFL.)
BACKGROUND - YELLOW (REFL.)

W1-10L&R

4/06

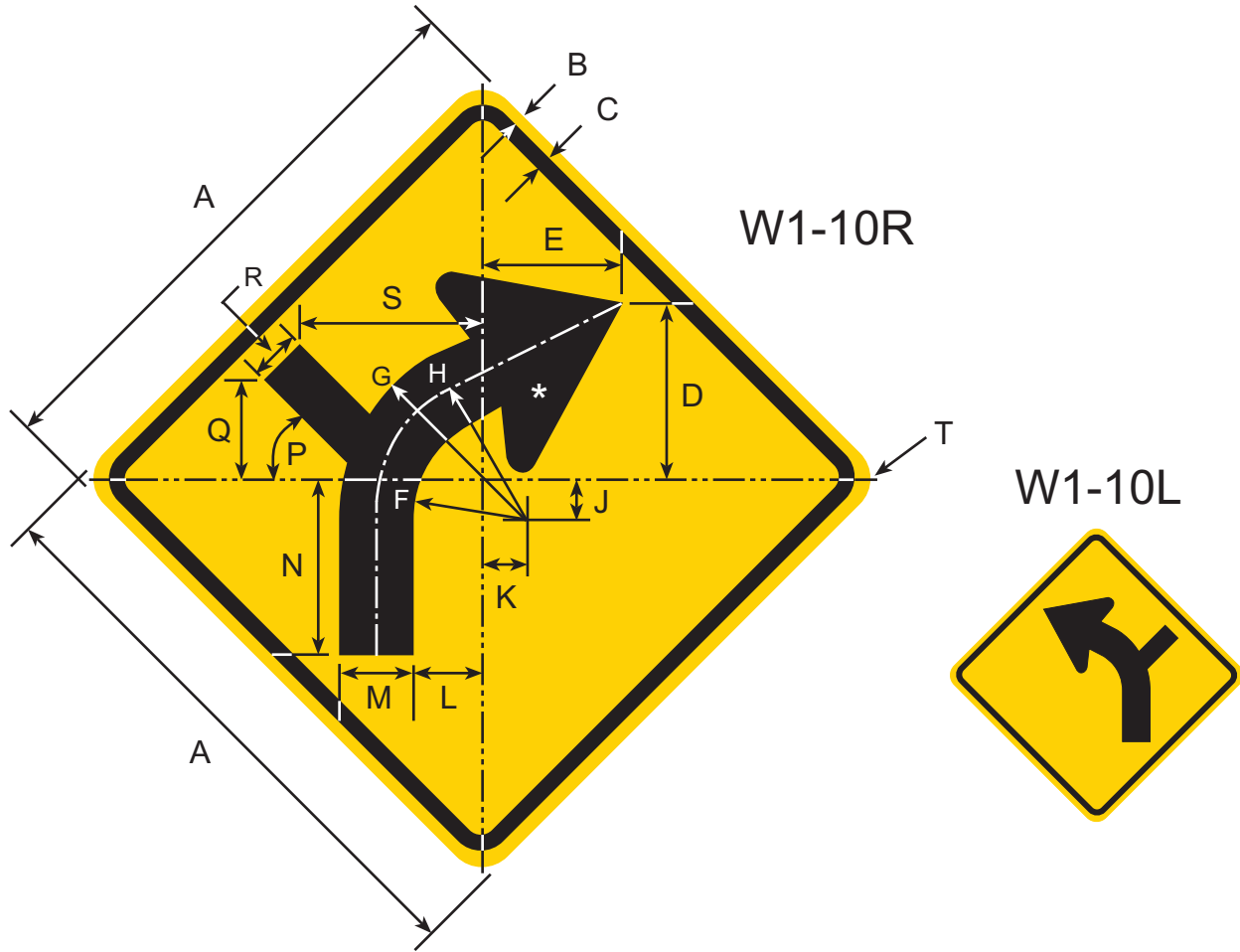

* SEE APPENDIX FOR STANDARD ARROW DETAILS

DIMENSIONS (INCHES)								
A	B	C	D	E	F	G	H	J
30	1/2	3/4	9 47/64	7 17/32	5 51/64	9 51/64	7 51/64	2 15/64
36	5/8	7/8	12 11/64	9 23/64	7 13/64	12 13/64	9 45/64	2 27/32
48	3/4	1 1/4	17	13 1/8	10	17	13 33/64	3 31/32

K	L	M	N	P	Q	R	S	T
2 11/64	3 31/64	4	9 23/32	45	5 11/64	2 39/64	9 39/64	1 7/8
2 59/64	4 23/64	5	12 11/64	45	6 13/64	3	11 17/32	2 1/4
4 5/64	6 5/64	7	17	45	8 9/32	4	15 3/8	3

COLORS

LEGEND, BORDER, & SYMBOL - BLACK (NON-REFL)
BACKGROUND - YELLOW (REFL)

W1-15

2/06

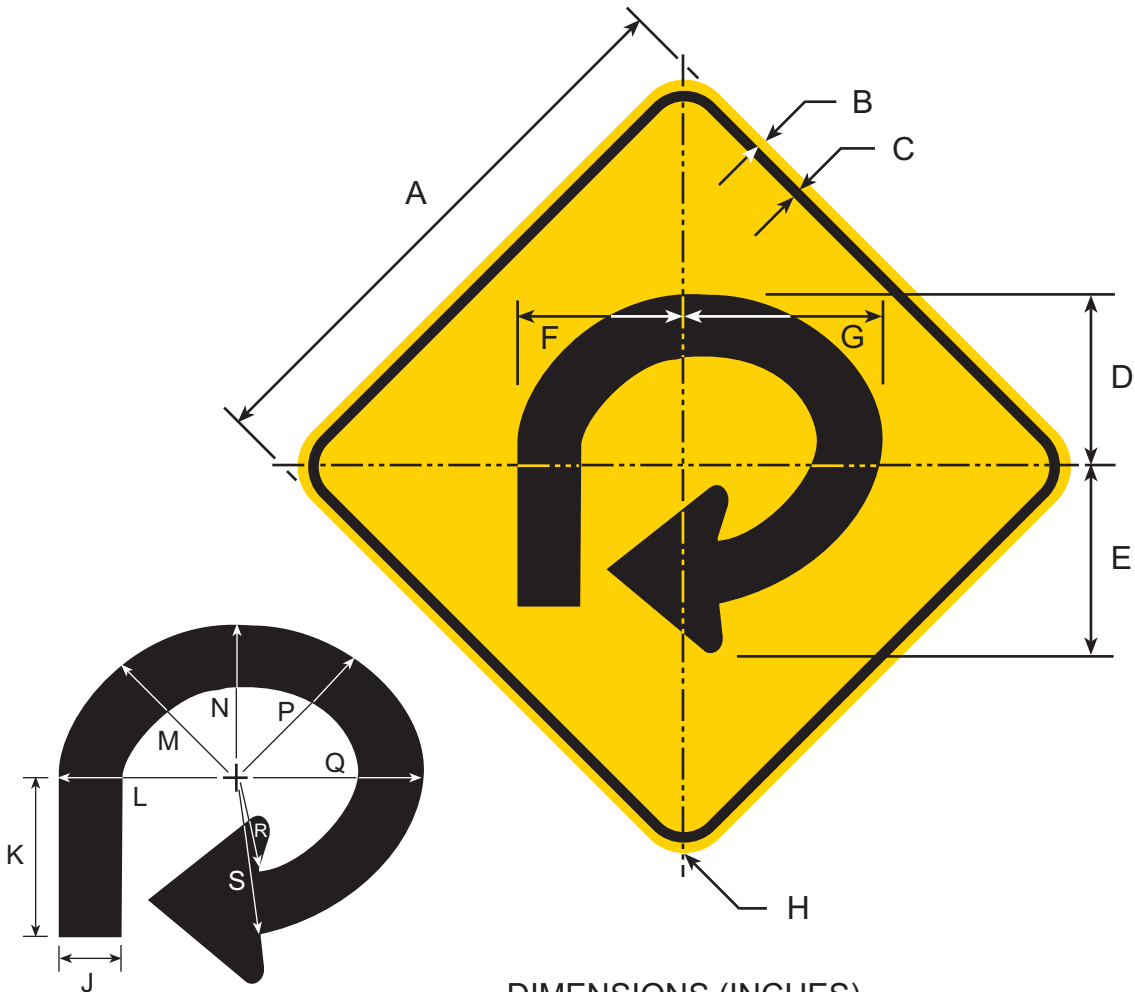

DIMENSIONS (INCHES)

A	B	C	D	E	F	G	H
30	1/2	3/4	9 9/32	10 5/32	8 19/32	10 5/16	1 7/8
36	5/8	7/8	11 1/8	12 7/32	10 5/16	12 13/32	2 1/4
48	3/4	1 1/4	14 27/32	16 1/4	13 3/4	16 17/32	3

J	K	L	M	N	P	Q	R	S
3 3/16	8 13/32	9 7/16	8 31/32	8 3/8	8 21/32	9 7/16	5 9/32	8 1/2
3 27/32	10 3/32	11 5/16	10 25/32	10 1/16	10 25/32	11 5/16	6 5/16	10 5/32
5 1/8	13 7/16	15 1/8	14 11/32	13 3/8	14 11/32	15 1/8	8 7/16	13 9/16

COLORS

LEGEND, BORDER, & SYMBOL - BLACK (NON-REFL)
 BACKGROUND - YELLOW (REFL)

W2-1

6/00

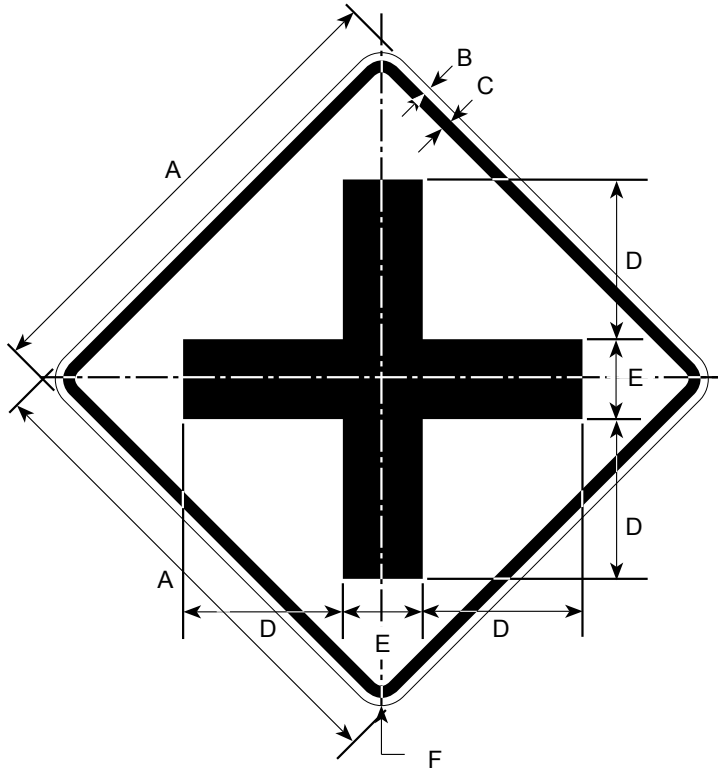

DIMENSIONS (MILLIMETERS)					
A	B	C	D	E	F
450	9	16	150	75	38
600	9	16	200	100	38
750	13	19	250	125	38
900	16	22	300	150	47
1200	19	31	400	200	56

DIMENSIONS (INCHES)					
A	B	C	D	E	F
18	3/8	5/8	6	3	1 1/2
24	3/8	5/8	8	4	1 1/2
30	1/2	3/4	10	5	1 7/8
36	5/8	7/8	12	6	2 1/4
48	3/4	1 1/4	16	8	3

COLORS

LEGEND — BLACK (NON-REFL)
 BACKGROUND — YELLOW (REFL)

W2-2

6/00

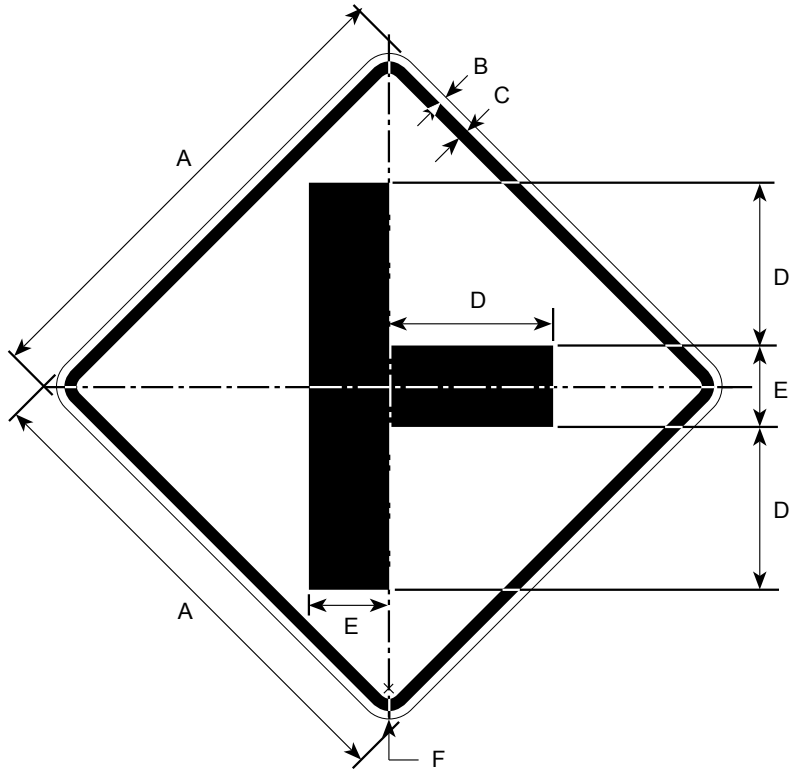

DIMENSIONS (MILLIMETERS)					
A	B	C	D	E	F
450	9	16	150	75	38
600	9	16	200	100	38
750	13	19	250	125	38
900	16	22	300	150	47
1200	19	31	400	200	56

DIMENSIONS (INCHES)					
A	B	C	D	E	F
18	3/8	5/8	6	3	1 1/2
24	3/8	5/8	8	4	1 1/2
30	1/2	3/4	10	5	1 7/8
36	5/8	7/8	12	6	2 1/4
48	3/4	1 1/4	16	8	3

COLORS

LEGEND — BLACK (NON-REFL)
BACKGROUND — YELLOW (REFL)

W2-3

10/97

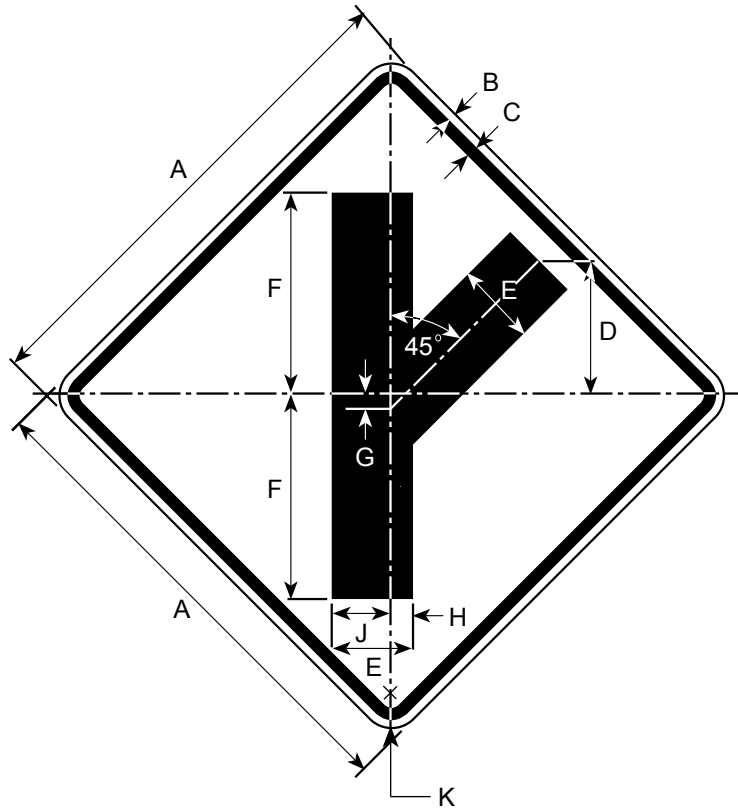

* SEE APPENDIX FOR STANDARD SYMBOL DETAILS

DIMENSIONS (MILLIMETERS)									
A	B	C	D	E	F	G	H	J	K
450	9	16	125	75	194	9	19	56	38
600	9	16	167	100	250	14	25	75	38
750	13	19	208	125	313	17	31	94	47
900	16	22	250	150	375	21	38	111	56
1200	19	31	333	200	500	28	50	150	75

DIMENSIONS (INCHES)									
A	B	C	D	E	F	G	H	J	K
18	3/8	5/8	5	3	7 3/4	3/8	3/4	2 1/4	1 1/2
24	3/8	5/8	6 21/32	4	10	9/16	1	3	1 1/2
30	1/2	3/4	8 5/16	5	12 1/2	11/16	1 1/4	3 3/4	1 7/8
36	5/8	7/8	10	6	15	27/32	1 1/2	4 1/2	2 1/4
48	3/4	1 1/4	13 5/16	7	20	1 1/8	2	6	3

COLORS

LEGEND — BLACK (NON-REFL)
 BACKGROUND — YELLOW (REFL)

W2-4

11/97

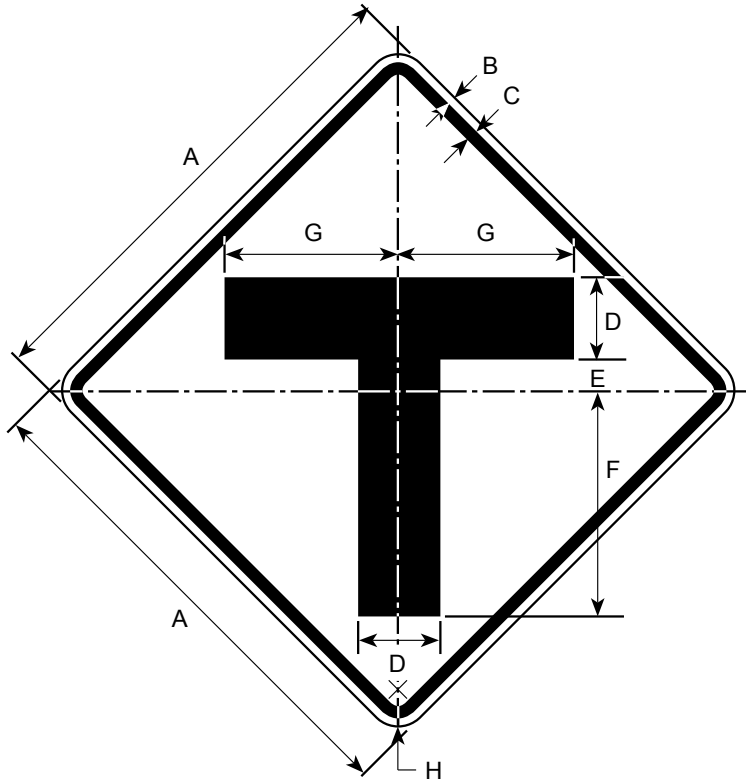

DIMENSIONS (MILLIMETERS)							
A	B	C	D	E	F	G	H
450	9	16	75	31	209	159	38
600	9	16	100	38	275	213	38
750	13	19	125	47	344	266	47
900	16	22	150	56	413	319	56
1200	19	31	200	75	550	425	75

DIMENSIONS (INCHES)							
A	B	C	D	E	F	G	H
18	3/8	5/8	3	1 1/4	8 3/8	6 3/8	1 1/2
24	3/8	5/8	4	1 1/2	1	8 1/2	1 1/2
30	1/2	3/4	5	1 7/8	13 3/4	10 5/8	1 7/8
36	5/8	7/8	6	2 1/4	16 1/2	12 3/4	2 1/4
48	3/4	1 1/4	8	3	22	17	3

COLORS

LEGEND — BLACK (NON-REFL)
 BACKGROUND — YELLOW (REFL)

W2-401

11/97

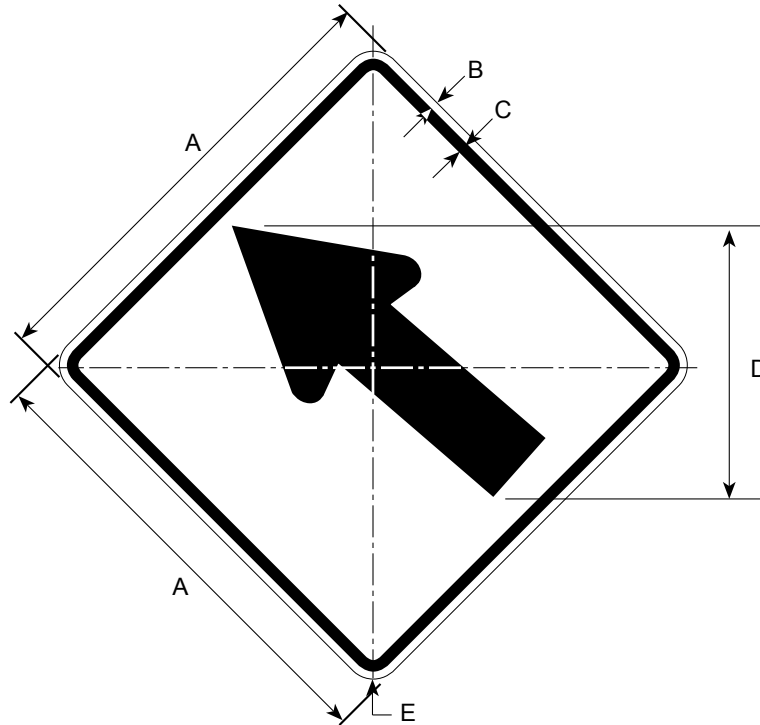

* SEE APPENDIX FOR STANDARD ARROW

DIMENSIONS (MILLIMETERS)				
A	B	C	D	E
750	13	19	94	125
900	16	22	111	150
1200	19	31	150	200

DIMENSIONS (INCHES)				
A	B	C	D	E
30	1/2	3/4	2 1/2	1 7/8
36	5/8	7/8	3	2 1/4
48	3/4	1 1/4	4	3

COLORS

LEGEND — BLACK (NON-REFL)
 BACKGROUND — YELLOW (REFL)

W2-5

11/97

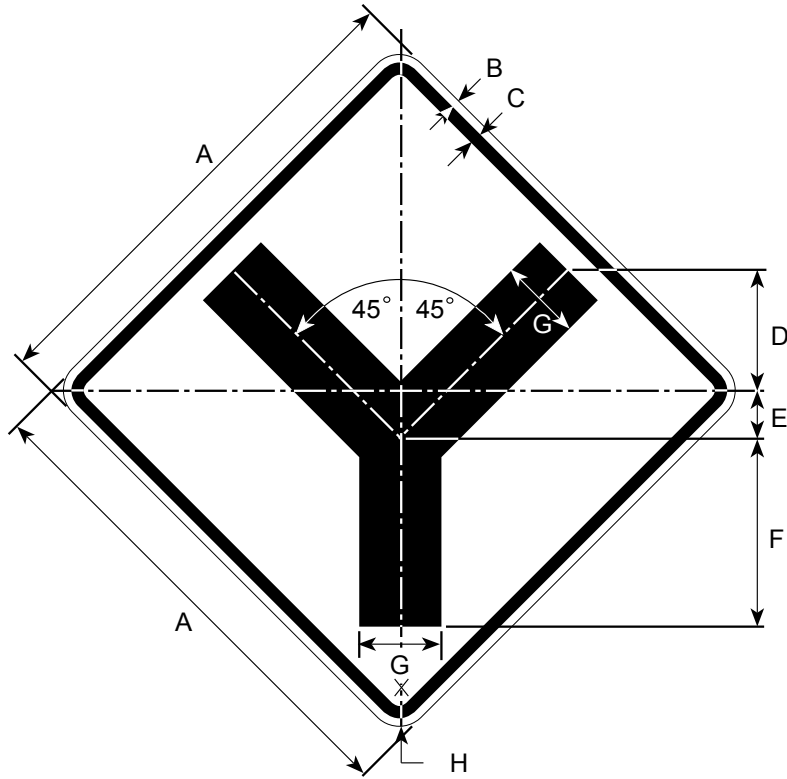

DIMENSIONS (MILLIMETERS)

A	B	C	D	E	F	G	H
450	9	16	11	44	169	75	38
600	9	16	148	60	227	100	38
750	13	19	184	75	285	125	47
900	16	22	221	90	342	150	56
1200	19	31	296	121	455	200	75

DIMENSIONS (INCHES)

A	B	C	D	E	F	G	H
18	3/8	5/8	4 1/2	1 3/4	8 3/8	6 3/8	1 1/2
24	3/8	5/8	5 29/32	2 13/32	1	8 1/2	1 1/2
30	1/2	3/4	7 3/8	3	13 3/4	10 5/8	1 7/8
36	5/8	7/8	8 27/32	3 19/32	16 1/2	12 3/4	2 1/4
48	3/4	1 1/4	11	18 3/16	22	17	3

COLORS

LEGEND — BLACK (NON REFL.)
 BACKGROUND — YELLOW (REFL.)

W2-6

4/03

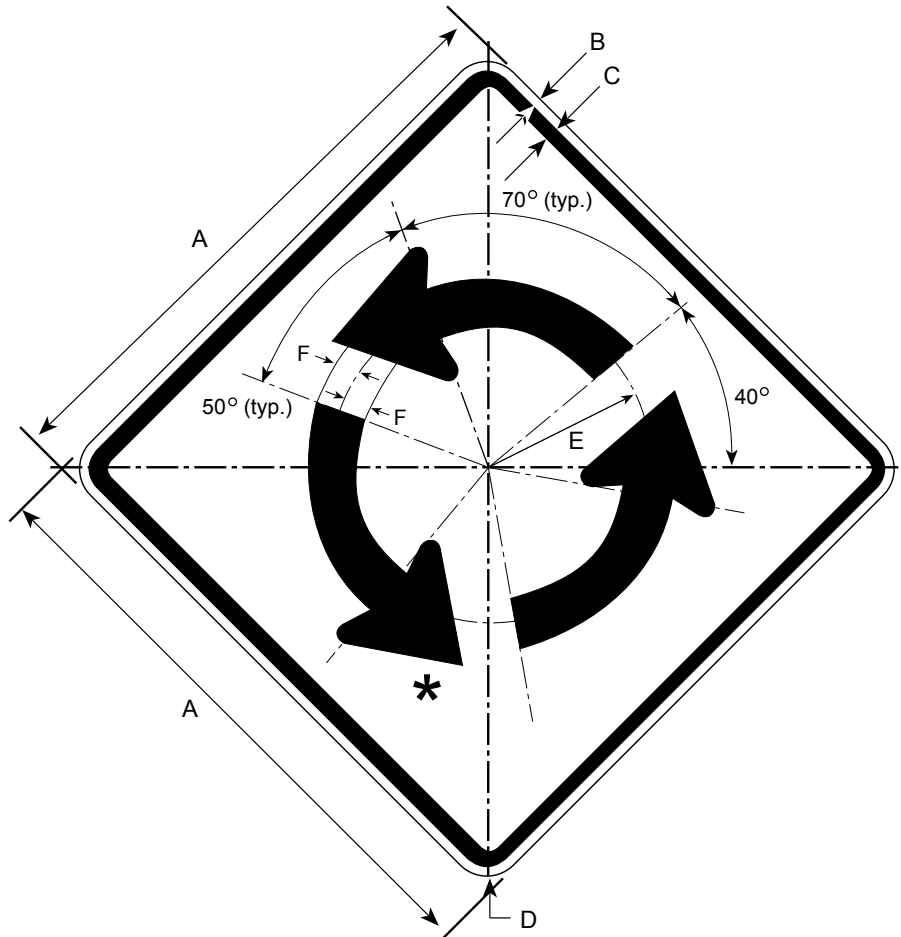

* SEE APPENDIX FOR STANDARD ARROW DETAILS

DIMENSIONS (MILLIMETERS)					
A	B	C	D	E	F
900	16	22	56	250	40
1200	19	31	75	333	53

DIMENSIONS (INCHES)					
A	B	C	D	E	F
36	5/8	7/8	2 1/4	10	1 5/8
48	3/4	1 1/4	3	13 1/4	2 1/8

COLORS

LEGEND — BLACK (NON-REFL)
BACKGROUND — YELLOW (REFL)

W2-6P

4/03

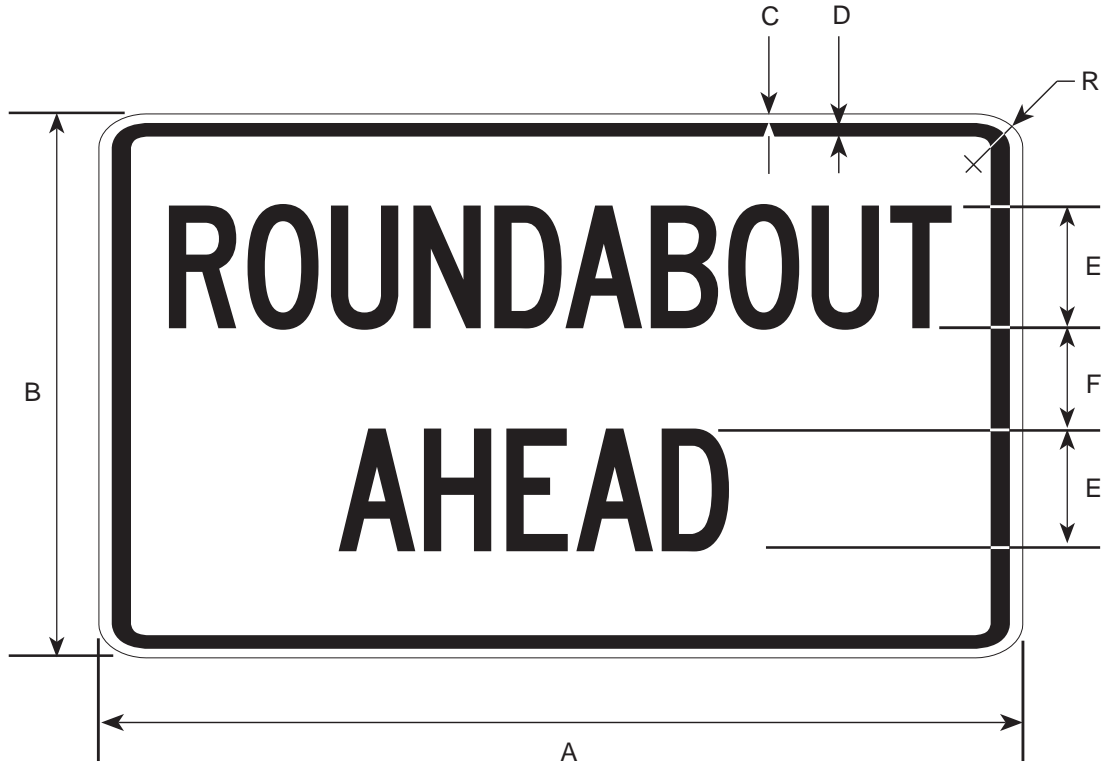

DIMENSIONS (MILLIMETERS)						
A	B	C	D	E	F	R
900	450	9	16	100-C	400	38
1200	600	13	19	150-C	400	47

DIMENSIONS (INCHES)						
A	B	C	D	E	F	R
36	18	3/8	5/8	4-C	4	1 1/2
48	24	1/2	3/4	6-C	4	1 7/8

COLORS

LEGEND - BLACK (NON-REFL)
BACKGROUND - YELLOW (REFL)

W2-601

11/97

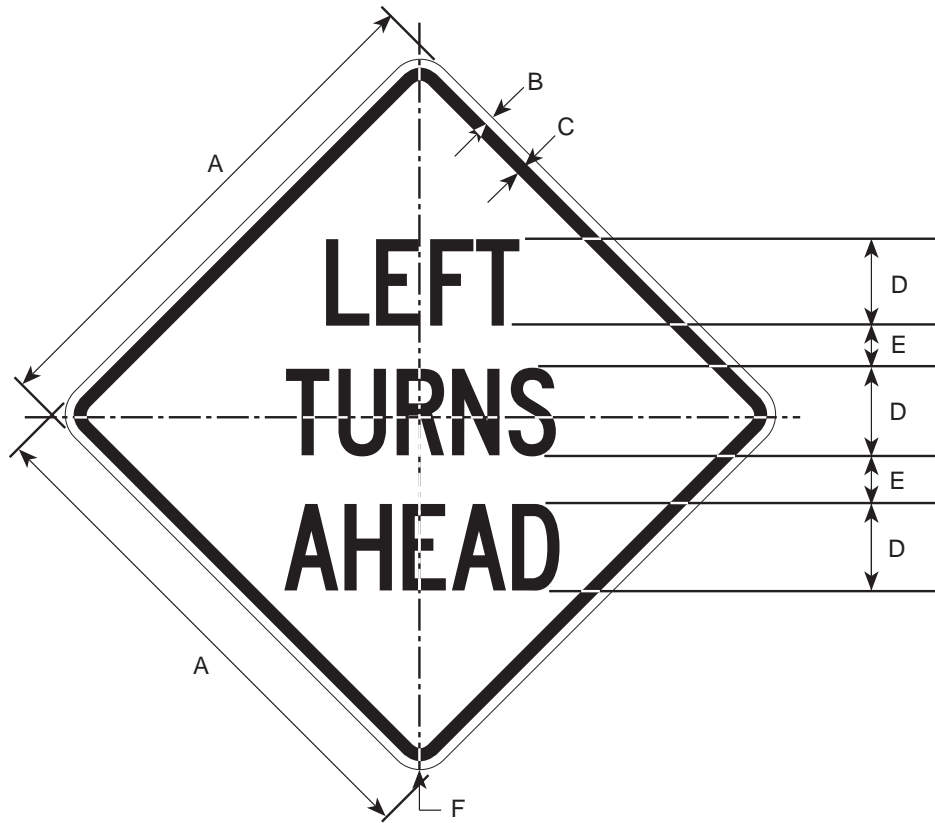

DIMENSIONS (MILLIMETERS)					
A	B	C	D	E	F
750	13	19	188	94	125
900	16	22	225	11	150
1200	19	31	300	150	200

DIMENSIONS (INCHES)					
A	B	C	D	E	F
30	1/2	3/4	5-C	2 1/2	1 7/8
36	5/8	7/8	6-C	3	2 1/4
48	3/4	1 1/4	8-C	4	3

COLORS

LEGEND - BLACK (NON-REFL)
 BACKGROUND - YELLOW (REFL)

W3-1

11/97

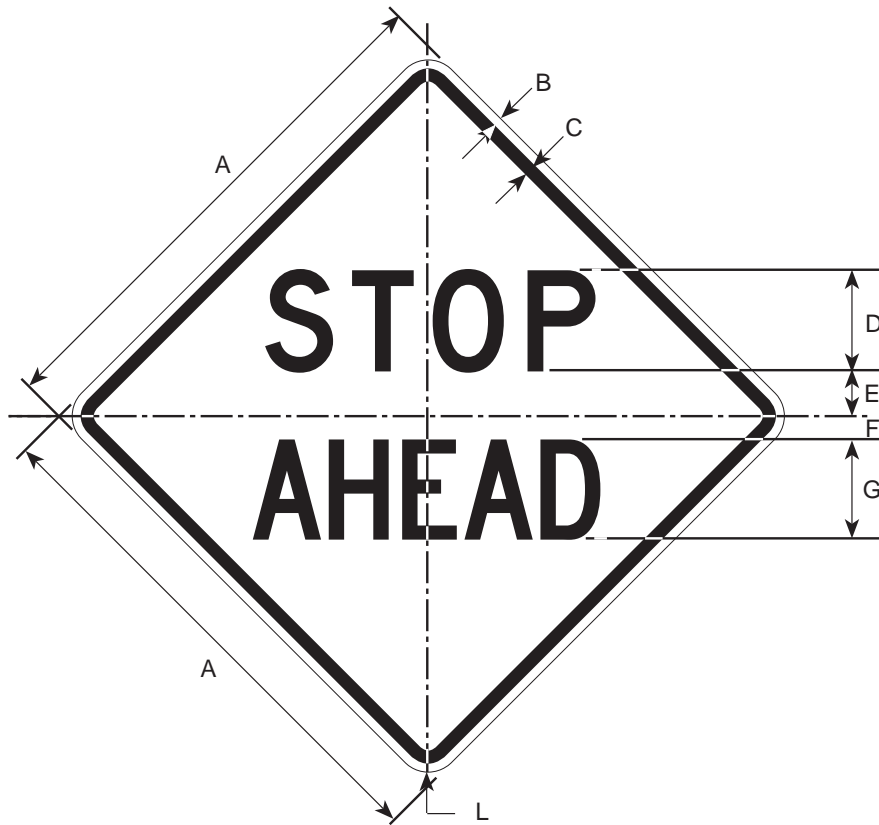

DIMENSIONS (MILLIMETERS)							
A	B	C	D	E	F	G	L
450	9	16	75D	44	19	75C	38
750	13	19	150D	63	31	150C	47
900	16	22	175D	75	38	175C	56
1200	19	31	225D	100	50	225C	75

DIMENSIONS (INCHES)							
A	B	C	D	E	F	G	L
18	3/8	5/8	3D	1 3/4	3/4	3C	1 1/2
30	1/2	3/4	6D	2 1/2	1 1/4	6C	1 7/8
36	5/8	7/8	7D	3	1 1/2	7C	2 1/4
48	3/4	1 1/4	9D	4	2	9C	3

COLORS

LEGEND - BLACK (NON-REFL)
 BACKGROUND - YELLOW (REFL)

W3-1A

11/97

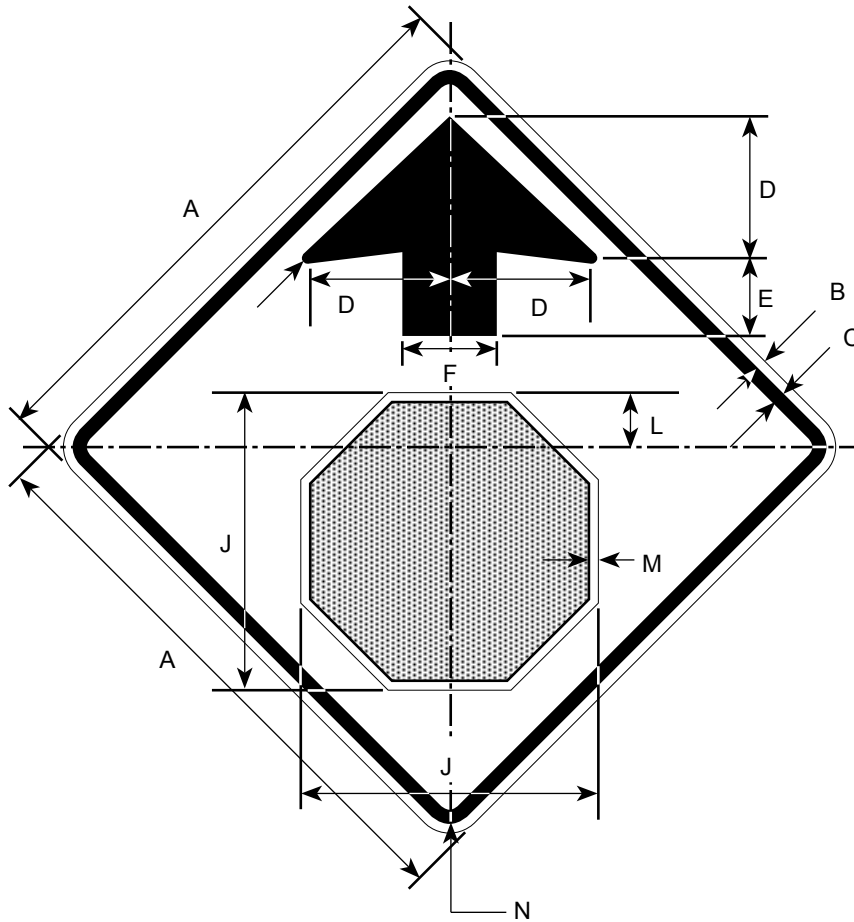

DIMENSIONS (MILLIMETERS)

A	B	C	D	E	F	G	H	J	K	L	M	N
750	13	19	188	97	125	16	8	394	156	72	13	47
900	16	22	225	11	150	19	9	475	188	88	16	56
1200	19	31	300	150	200	25	13	628	250	11	19	75

DIMENSIONS (INCHES)

A	B	C	D	E	F	G	H	J	K	L	M	N
30	1/2	3/4	7 1/2	3 3/4	5	5/8	5/16	15 3/4	6 1/4	2 7/8	1/2	1 7/8
36	5/8	7/8	9	4 1/2	6	3/4	3/8	19	7 1/2	3 1/2	5/8	2 1/4
48	3/4	1 1/4	12	6	8	1	1/2	25 1/8	10	4 1/2	3/4	3

COLORS

BORDER & ARROW - BLACK (NON-REFL)

SYMBOL - WHITE BORDER ON RED BACKGROUND (REFL)

BACKGROUND - YELLOW (REFL)

W3-2A

11/97

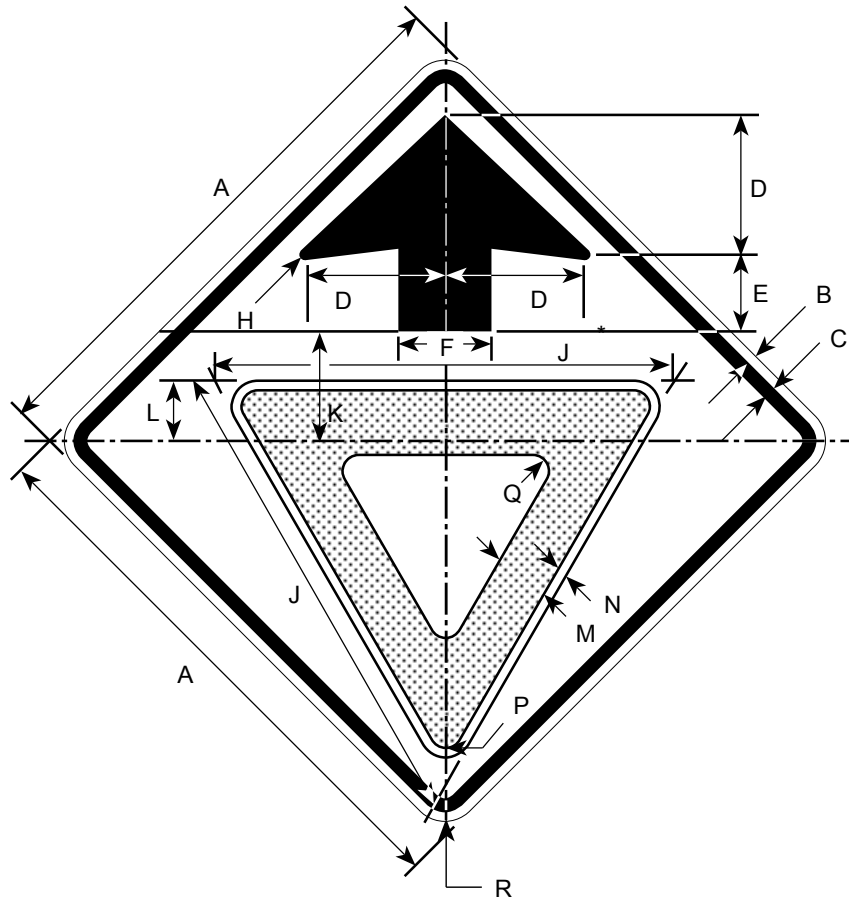

* SEE APPENDIX FOR STANDARD ARROW DETAILS

DIMENSIONS (MILLIMETERS)

A	B	C	D	E	F	H	J	K	L	M	N	P	Q	R
750	13	19	188	94	125	8	625	156	75	84	13	31	16	47
900	16	22	225	11	150	9	700	188	84	94	16	34	19	56
1200	19	31	300	150	200	13	950	250	11	125	19	47	25	75

DIMENSIONS (INCHES)

A	B	C	D	E	F	H	J	K	L	M	N	P	Q	R
30	1/2	3/4	7 1/2	3 3/4	5	5/16	25	6 1/4	3	3 3/8	7/8	1 1/4	5/8	1 7/8
36	5/8	7/8	9	4 1/2	6	3/8	28	7 1/2	3 3/8	3 3/4	1 1/8	1 3/8	3/4	2 1/4
48	3/4	1 1/4	12	6	8	1/2	38	10	4 1/2	5	1 13/16	1 7/8	1	3

COLORS

BORDER & ARROW - BLACK (NON-REFL)

SYMBOL - RED BORDER ON WHITE BACKGROUND (REFL)

BACKGROUND - YELLOW (REFL)

W3-3

11/97

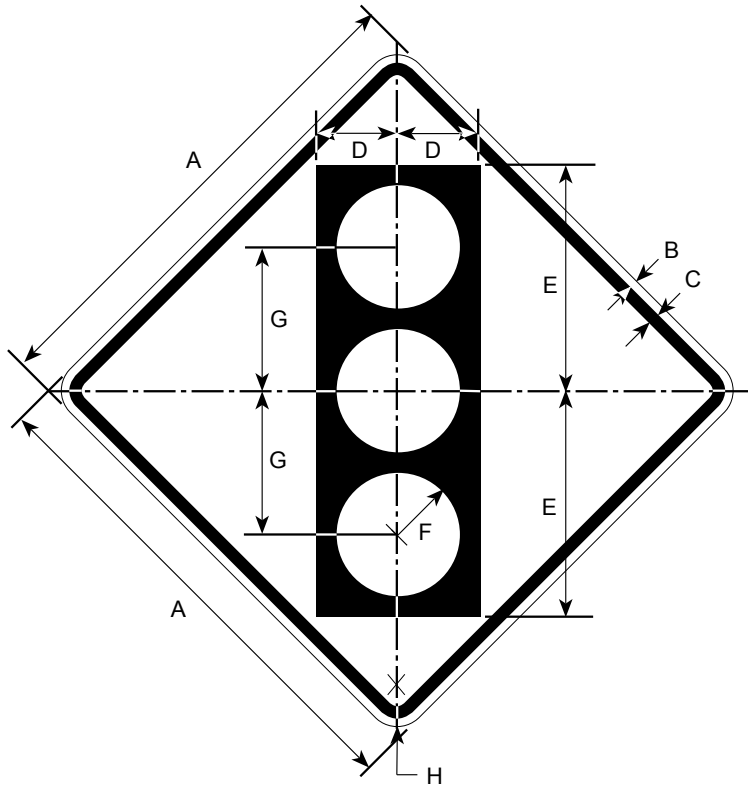

DIMENSIONS (MILLIMETERS)							
A	B	C	D	E	F	G	H
450	9	16	75	200	56	125	38
750	13	19	125	344	94	219	47
900	16	22	144	394	106	250	56
1200	19	31	188	500	125	313	75

DIMENSIONS (INCHES)							
A	B	C	D	E	F	G	H
18	3/8	5/8	3	8	2 1/4	5	1 1/2
30	1/2	3/4	5	13 3/4	3 3/4	8 3/4	1 7/8
36	5/8	7/8	5 3/4	15 3/4	4 1/4	10	2 1/4
48	3/4	1 1/4	7 1/2	20	5	12 1/2	3

COLORS

SYMBOL AND LEGEND— BLACK (NON-REFL)
 BOTTOM CIRCLE— GREEN (REFL)
 TOP CIRCLE— RED (REFL)
 BACKGROUND— YELLOW (REFL)

W3-401

11/97

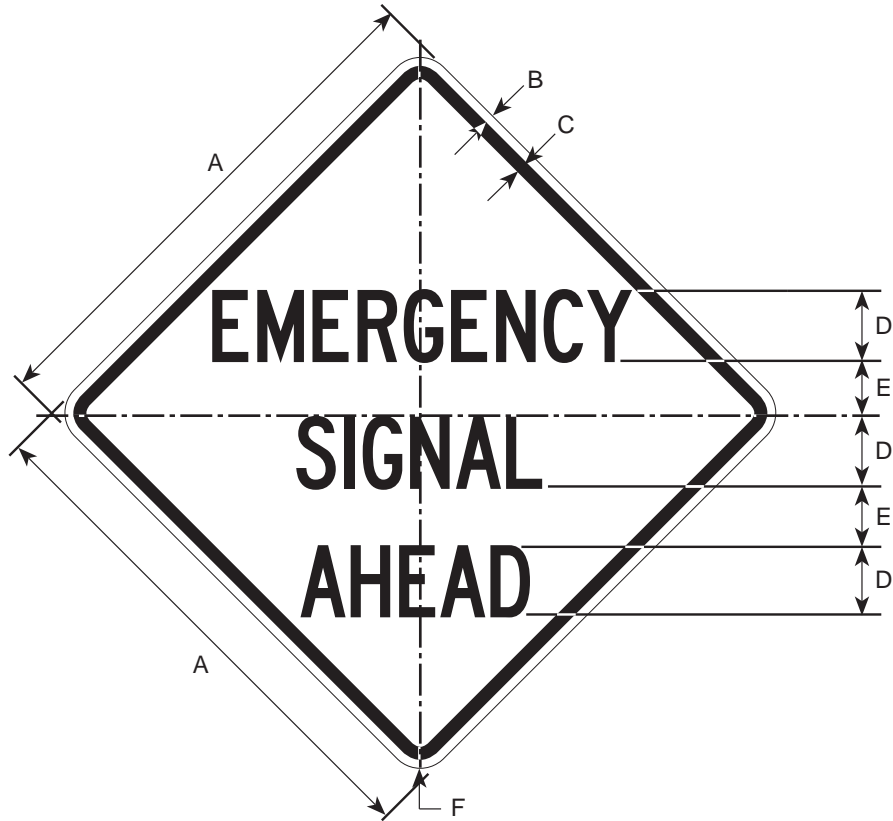

DIMENSIONS (MILLIMETERS)					
A	B	C	D	E	F
750	13	19	100C	88	47
900	16	22	125C	75	56
1200	19	31	150C	100	75

DIMENSIONS (INCHES)					
A	B	C	D	E	F
30	1/2	3/4	4-C	3 1/2	1 7/8
36	5/8	7/8	5-C	4 1/2	2 1/4
48	3/4	1 1/4	6-C	6	3

COLORS

LEGEND - BLACK (NON-REFL)
 BACKGROUND - YELLOW (REFL)

W3-5

4/06

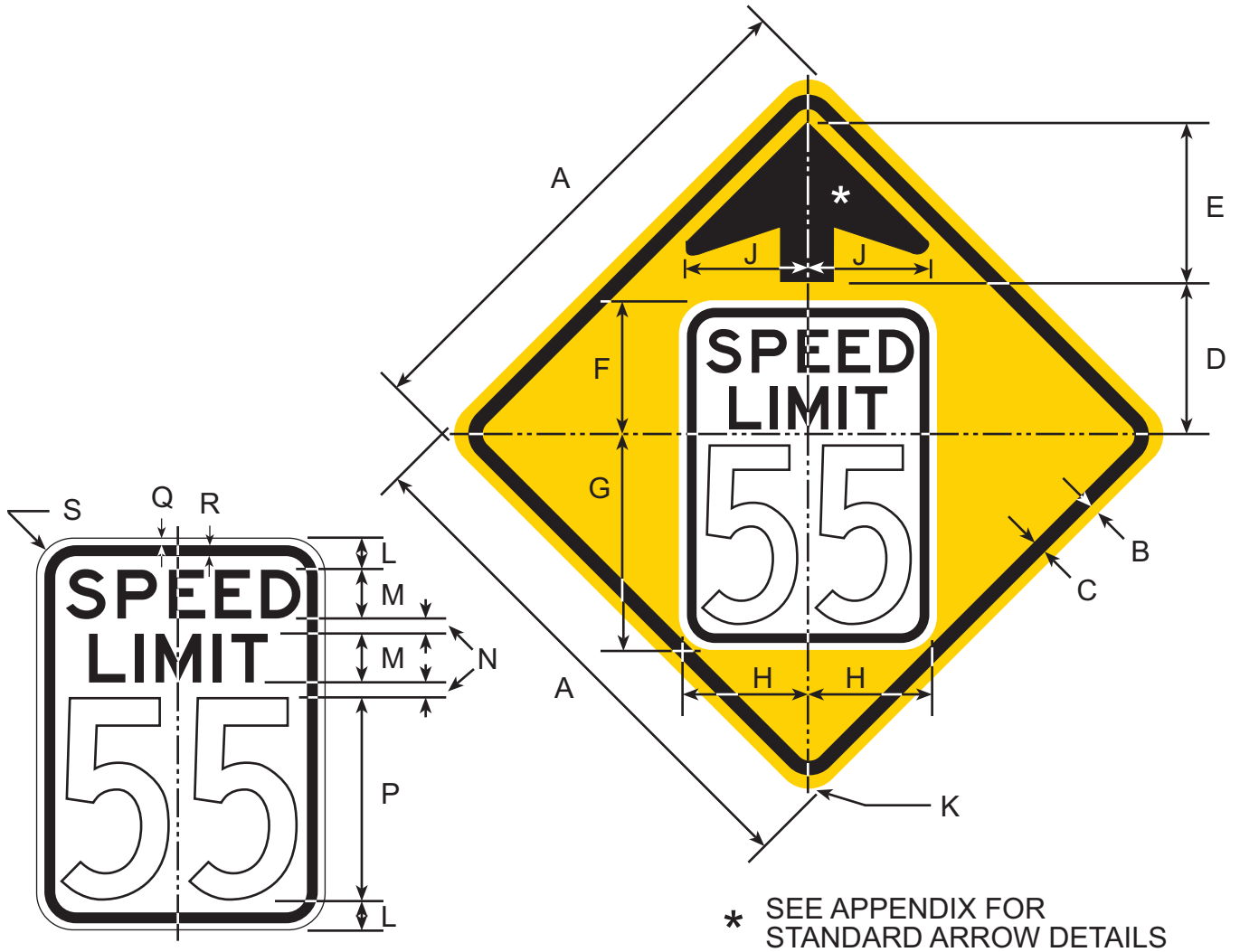

* SEE APPENDIX FOR STANDARD ARROW DETAILS

DIMENSIONS (INCHES)							
A	B	C	D	E	F	G	H
36	5/8	7/8	10	12	9	15	9
48	3/4	1 1/4	11 3/4	18	10 3/4	19 3/4	12

J	K	L	M	N	P	Q	R	S
9	2 1/4	2	3E	1	12C	3/8	5/8	2 1/4
12	3	2 1/4	4E	1 1/4	15C	3/8	5/8	3

COLORS

BORDER & ARROW - BLACK (NON-REFL)
 SYMBOL - See R2-1
 BACKGROUND - YELLOW (REFL)

W3-501

6/03

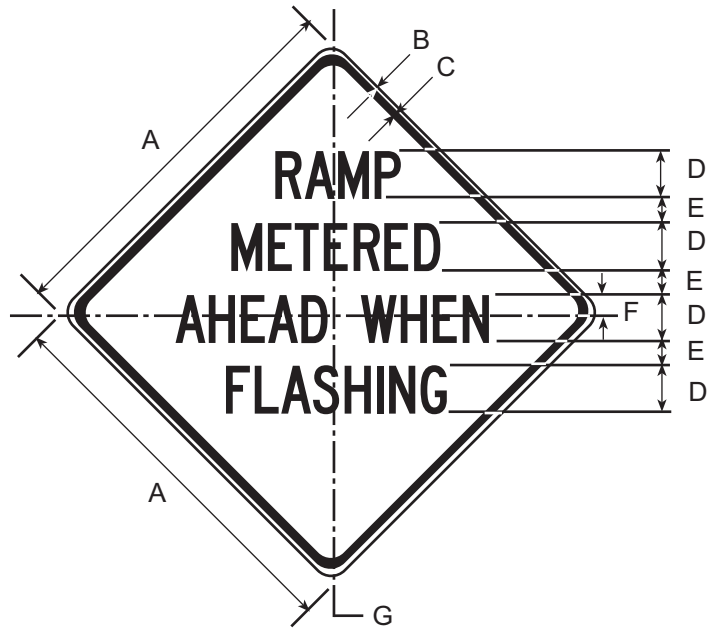

DIMENSIONS (MILLIMETERS)						
A	B	C	D	E	F	G
900	16	22	125C	50	25	56
1200	19	31	150C	100	19	75

DIMENSIONS (INCHES)						
A	B	C	D	E	F	G
36	5/8	7/8	5C	2	1	2 1/4
48	3/4	1 1/4	6C	4	3/4	3

COLORS

LEGEND - BLACK (NON-REFL)

BACKGROUND - YELLOW (REFL)

W4-1L & W4-1R

11/97

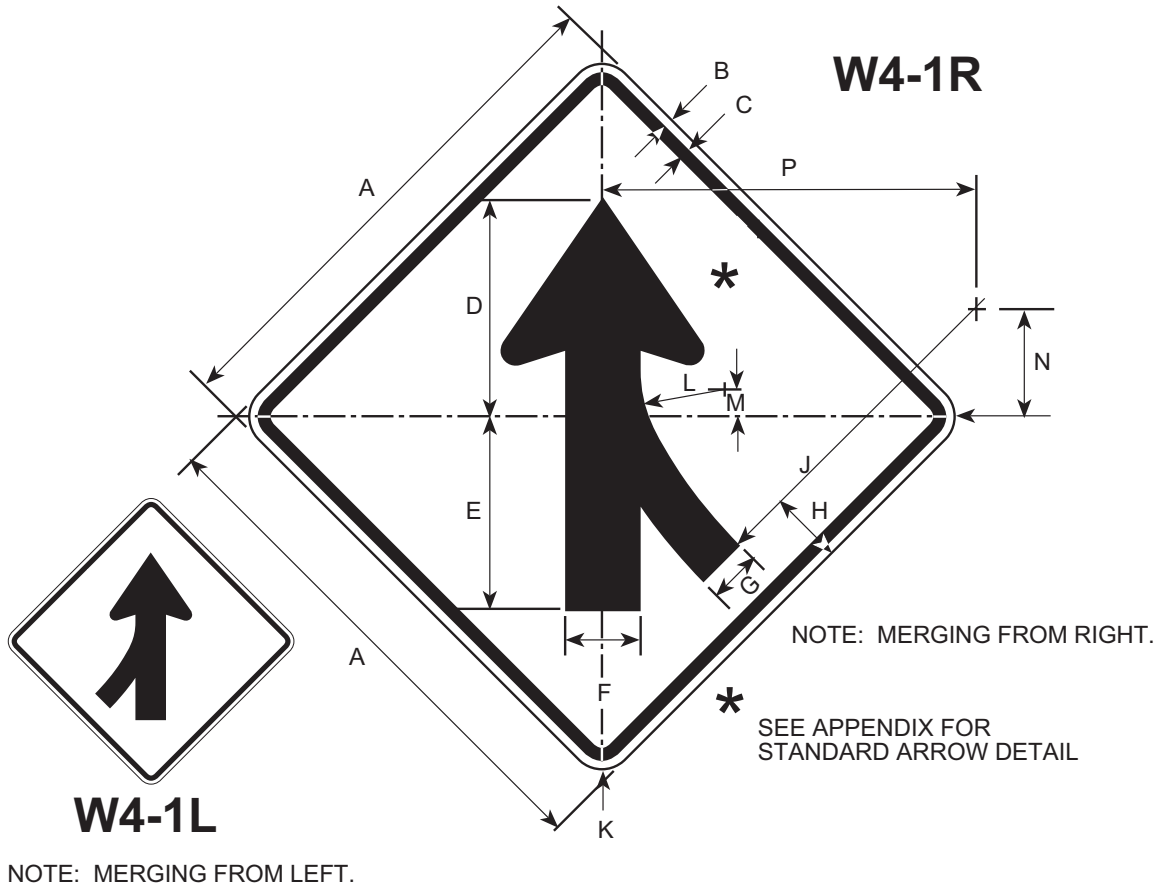

DIMENSIONS (MILLIMETERS)													
A	B	C	D	E	F	G	H	J	K	L	M	N	P
600	9	16	256	222	88	59	105	556	38	159	66	259	555
750	13	19	325	275	109	75	131	700	47	200	75	325	694
900	16	22	394	331	131	191	158	841	56	241	100	391	832
1200	19	31	513	438	175	11	209	112	75	567	131	522	110

DIMENSIONS (INCHES)													
A	B	C	D	E	F	G	H	J	K	L	M	N	P
24	3/8	5/8	10 1/4	8 3/4	3 1/2	2 3/8	4 3/16	22 1/4	1 1/2	6 3/8	2 5/8	10 3/8	22 3/16
30	1/2	3/4	13	1	4 3/8	3	4 1/2	28	1 7/8	8	3	13	27 3/4
36	5/8	7/8	15 3/4	13 1/4	5 1/4	3 5/8	5 5/8	33 5/8	2 1/4	9 5/8	4	15 5/8	35 5/16
48	3/4	1 1/4	20 1/2	17 1/2	7	4 3/4	6 3/4	45	3	12 13/16	5 1/4	20 3/4	44 3/8

COLORS

LEGEND — BLACK (NON-REFL)
BACKGROUND — YELLOW (REFL)

W4-2L & W4-2R

2/06

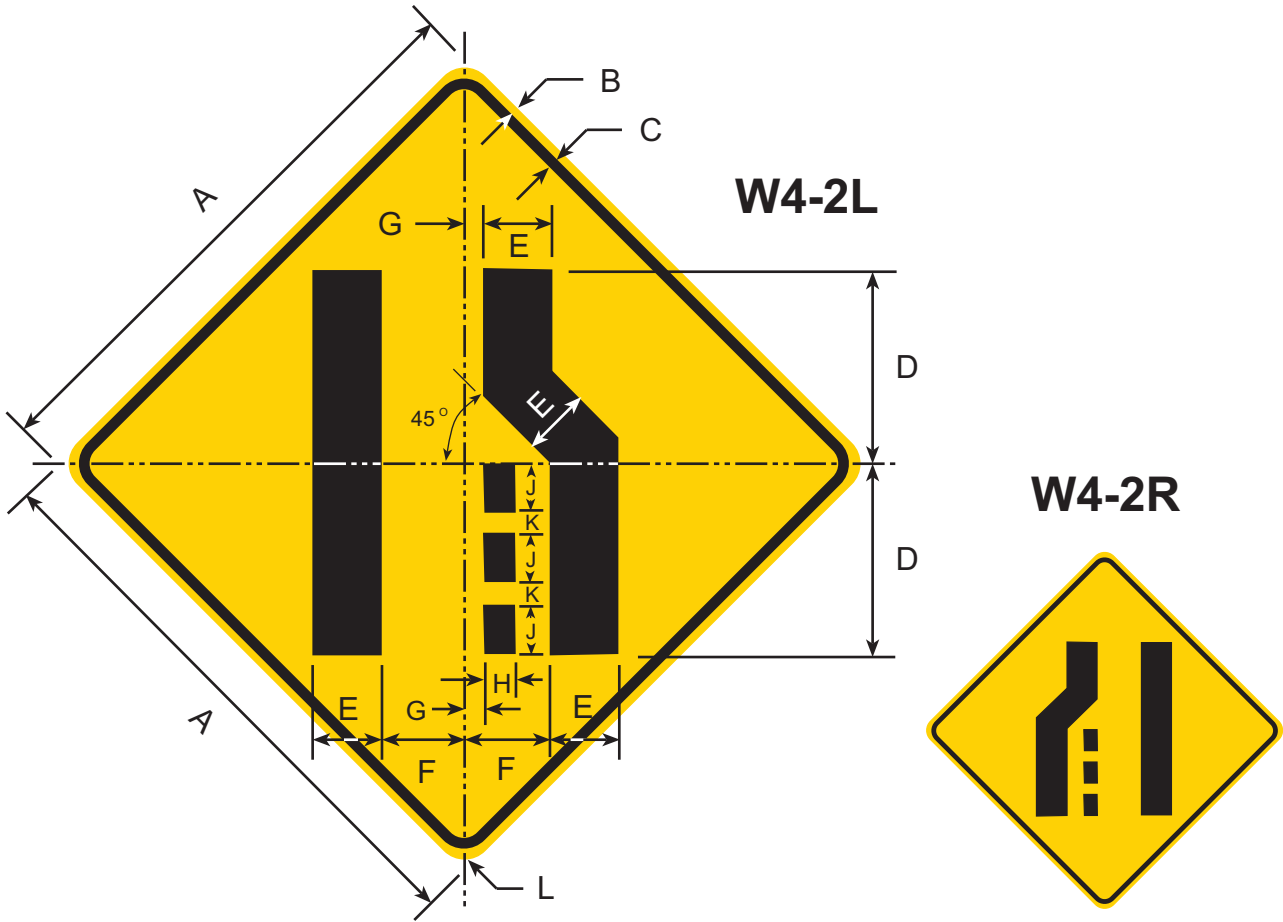

DIMENSIONS (MILLIMETERS)										
A	B	C	D	E	F	G	H	J	K	L
750	13	19	250	84	104	22	38	63	31	47
900	16	22	300	100	125	25	44	75	38	56
1200	19	31	400	134	167	31	59	100	50	75

DIMENSIONS (INCHES)										
A	B	C	D	E	F	G	H	J	K	L
30	1/2	3/4	10	3 3/8	4 3/16	7/8	1 1/2	2 1/2	1 1/4	1 7/8
36	5/8	7/8	12	4	5	1	1 3/4	3	1 1/2	2 1/4
48	3/4	1 1/4	16	5 3/8	6 11/16	1 1/4	2 3/8	4	2	3

COLORS

SYMBOL & BORDER — BLACK (NON-REFL)
 BACKGROUND — YELLOW (REFL)

W4-3L & W4-3R

11/97

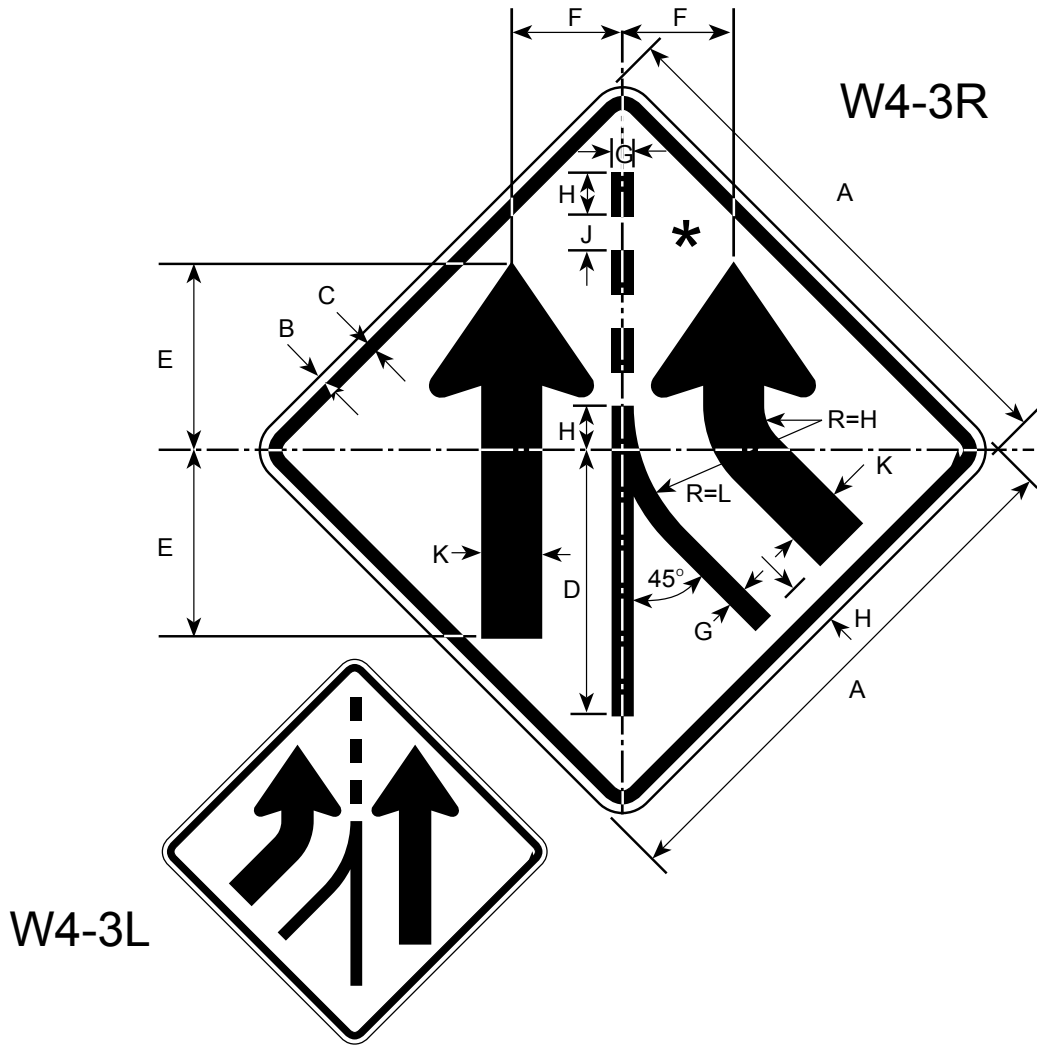

* SEE APPENDIX FOR STANDARD ARROW DETAILS

DIMENSIONS (MILLIMETERS)										
A	B	C	D	E	F	G	H	J	K	L
1200	19	31	600	425	250	50	100	75	138	394

DIMENSIONS (INCHES)										
A	B	C	D	E	F	G	H	J	K	L
48	3/4	1 1/4	24	17	10	2	4	3	5 1/2	15 3/4

COLORS

LEGEND — BLACK (NON-REFL)
 BACKGROUND — YELLOW (REFL)

W4-4P

8/03

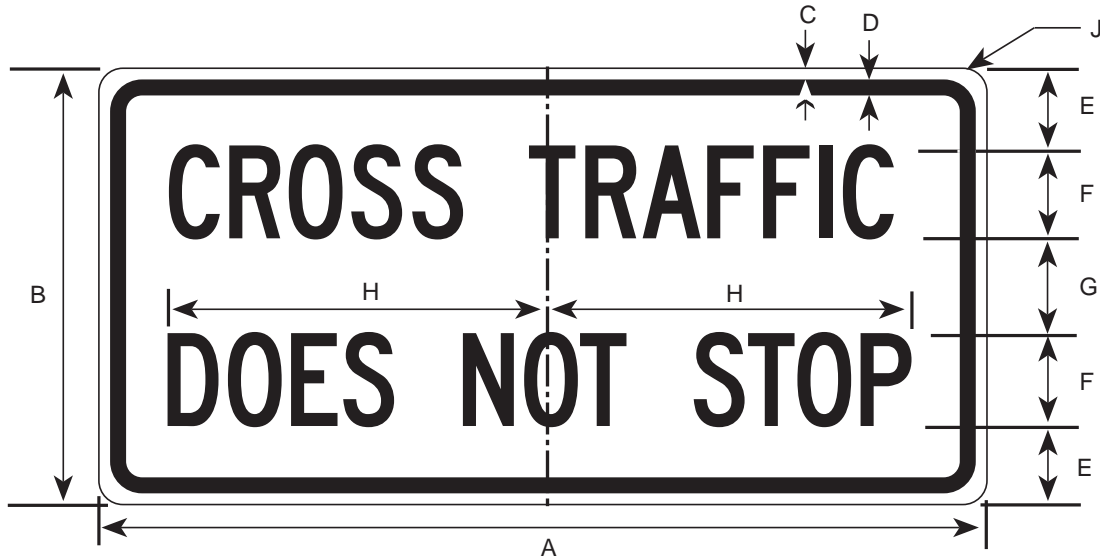

DIMENSIONS (MILLIMETERS)								
A	B	C	D	E	F	G	H	J
600	300	9	16	63	56C	63	250	38
750	450	13	20	100	75C	100	313	38

DIMENSIONS (INCHES)								
A	B	C	D	E	F	G	H	J
24	12	3/8	5/8	2 1/2	2 1/4C	2 1/2	10	1 1/2
30	18	1/2	3/4	4	3C	4	12 1/2	1 1/2

COLORS

LEGEND - BLACK (NON-REFL)
 BACKGROUND - YELLOW (REFL)

W4-5

4/06

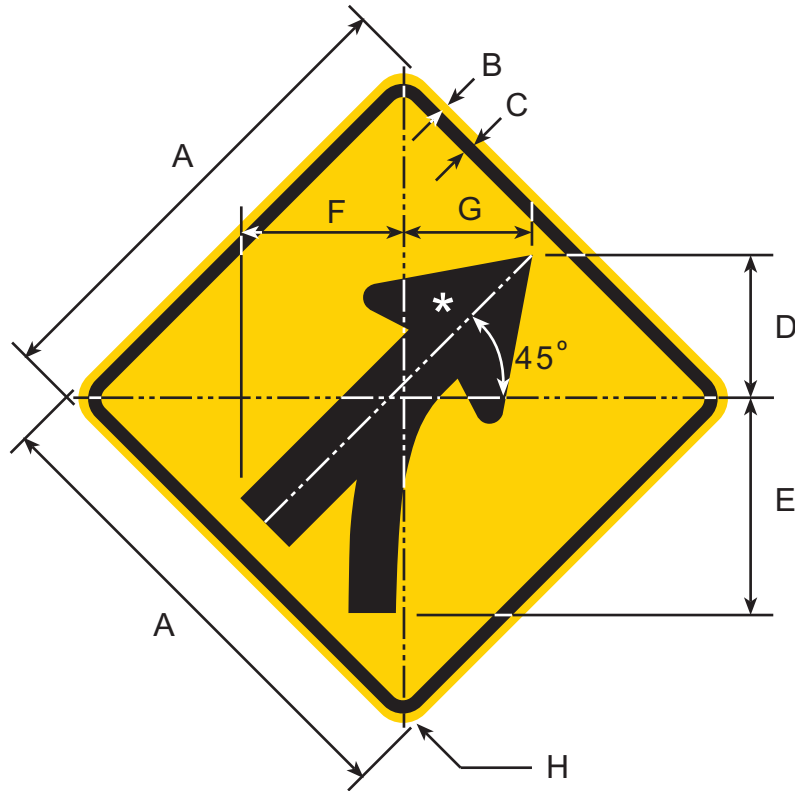

* SCALE AND ROTATE W4-1 SYMBOL TO FIT DIMENSIONS

DIMENSIONS (MILLIMETERS)							
A	B	C	D	E	F	G	H
750	13	19	229	344	261	204	47
900	16	22	273	413	314	245	56
1200	19	31	364	550	418	326	75

DIMENSIONS (INCHES)							
A	B	C	D	E	F	G	H
30	1/2	3/4	9 1/8	13 49/64	10 29/64	8 11/64	1 7/8
36	5/8	7/8	10 59/64	16 17/32	12 9/16	9 13/16	2 1/4
48	3/4	1 1/4	14 37/64	22	16 47/64	13 3/64	3

COLORS

SYMBOL & BORDER - BLACK (NON-REFL)
BACKGROUND - YELLOW (REFL)

W4-6

4/06

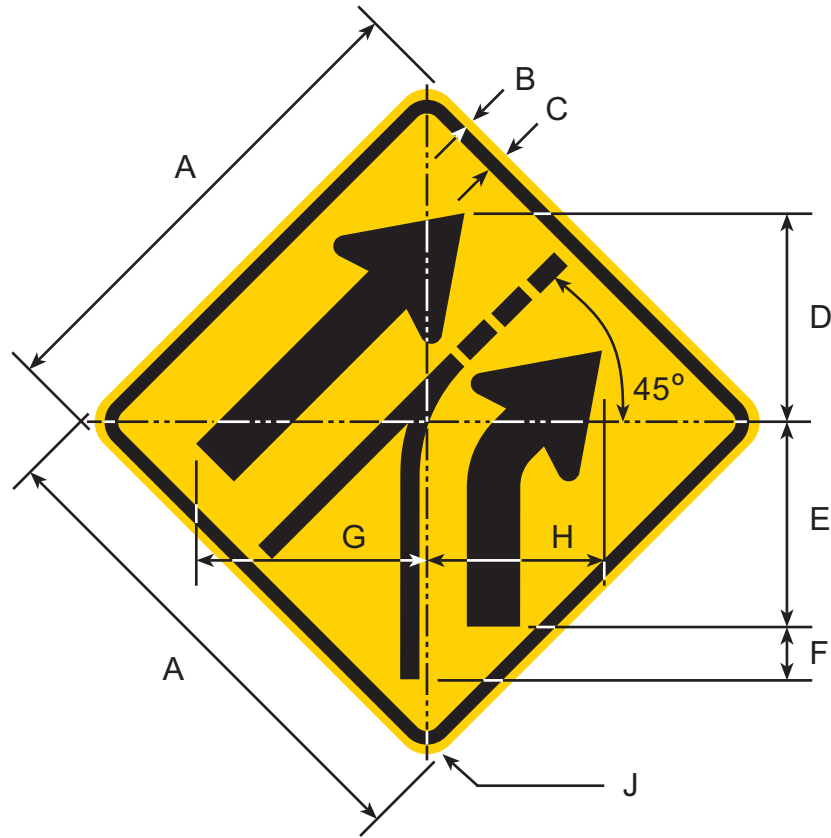

* SCALE AND ROTATE W4-3 SYMBOL TO FIT DIMENSIONS

DIMENSIONS (MILLIMETERS)								
A	B	C	D	E	F	G	H	J
750	13	19	324	335	59	364	281	47
900	16	22	389	402	70	437	336	56
1200	19	31	518	536	319	582	448	75

DIMENSIONS (INCHES)								
A	B	C	D	E	F	G	H	J
30	1/2	3/4	12 31/32	13 13/32	2 11/32	14 37/64	11 13/64	1 7/8
36	5/8	7/8	15 37/64	16 3/32	2 13/16	17 1/2	13 29/64	2 1/4
48	3/4	1 1/4	20 47/64	21 29/64	3 3/4	23 19/64	17 15/16	3

COLORS

SYMBOL & BORDER - BLACK (NON-REFL)
BACKGROUND - YELLOW (REFL)

W5-1

6/00

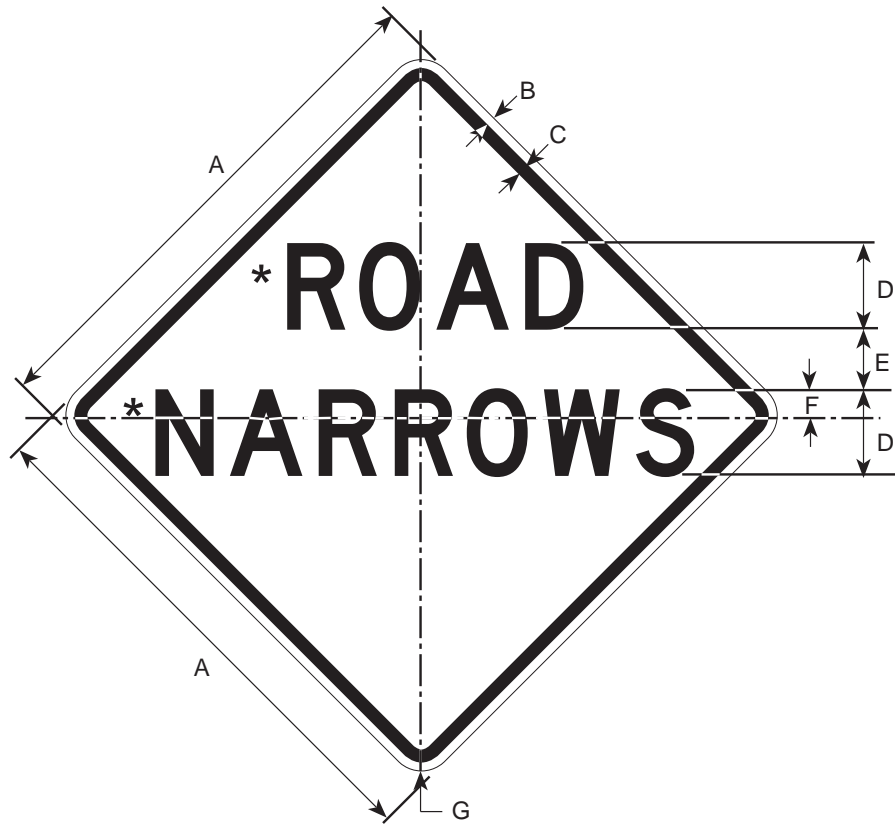

* REDUCE SPACING 25%

DIMENSIONS (MILLIMETERS)						
A	B	C	D	E	F	G
750	13	19	125D	75	47	47
900	16	22	150D	88	50	56
1200	19	31	200D	100	75	75

DIMENSIONS (INCHES)						
A	B	C	D	E	F	G
30	1/2	3/4	5D	3	1 3/4	1 7/8
36	5/8	7/8	6D	3 1/2	2	2 1/4
48	3/4	1 1/4	8D	4	3	3

COLORS

LEGEND - BLACK (NON-REFL)
BACKGROUND - YELLOW (REFL)

W5-2

11/97

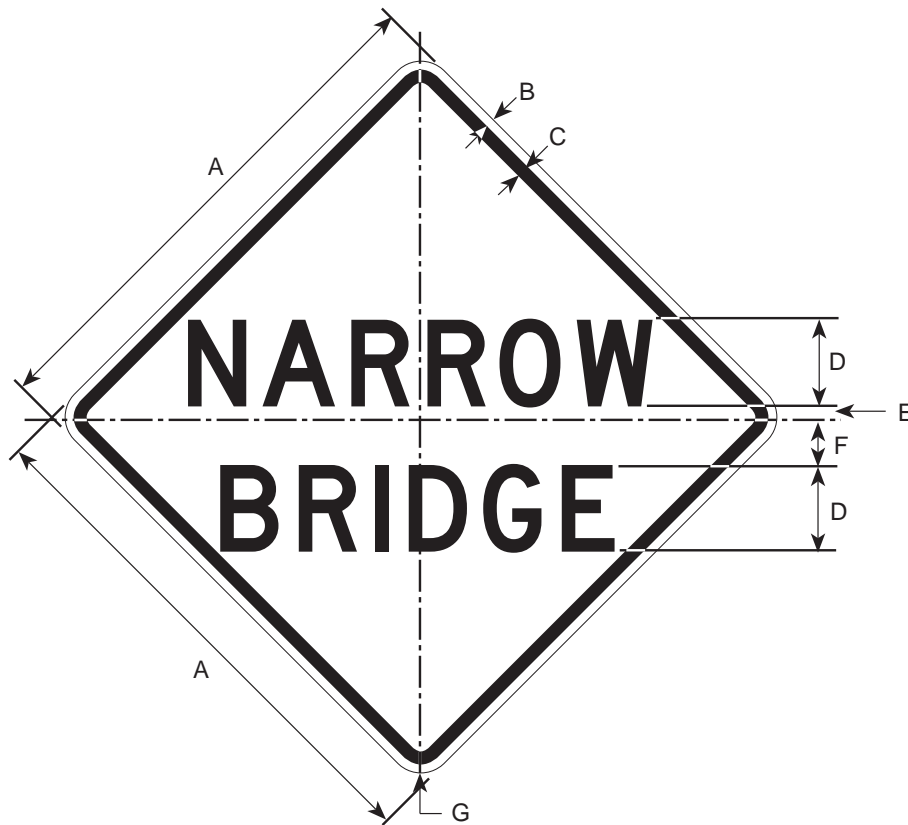

DIMENSIONS (MILLIMETERS)						
A	B	C	D	E	F	G
600	9	16	100D	6	50	38
750	13	19	125D	13	63	47
900	16	22	150D	19	75	56
1200	19	31	200D	31	100	75

DIMENSIONS (INCHES)						
A	B	C	D	E	F	G
24	3/8	5/8	4D	1/4	2	1 1/2
30	1/2	3/4	5D	1/2	2 1/2	1 7/8
36	5/8	7/8	6D	3/4	3	2 1/4
48	3/4	1 1/4	8D	1 1/4	4	3

COLORS

LEGEND - BLACK (NON-REFL)
BACKGROUND - YELLOW (REFL)

W5-3

11/97

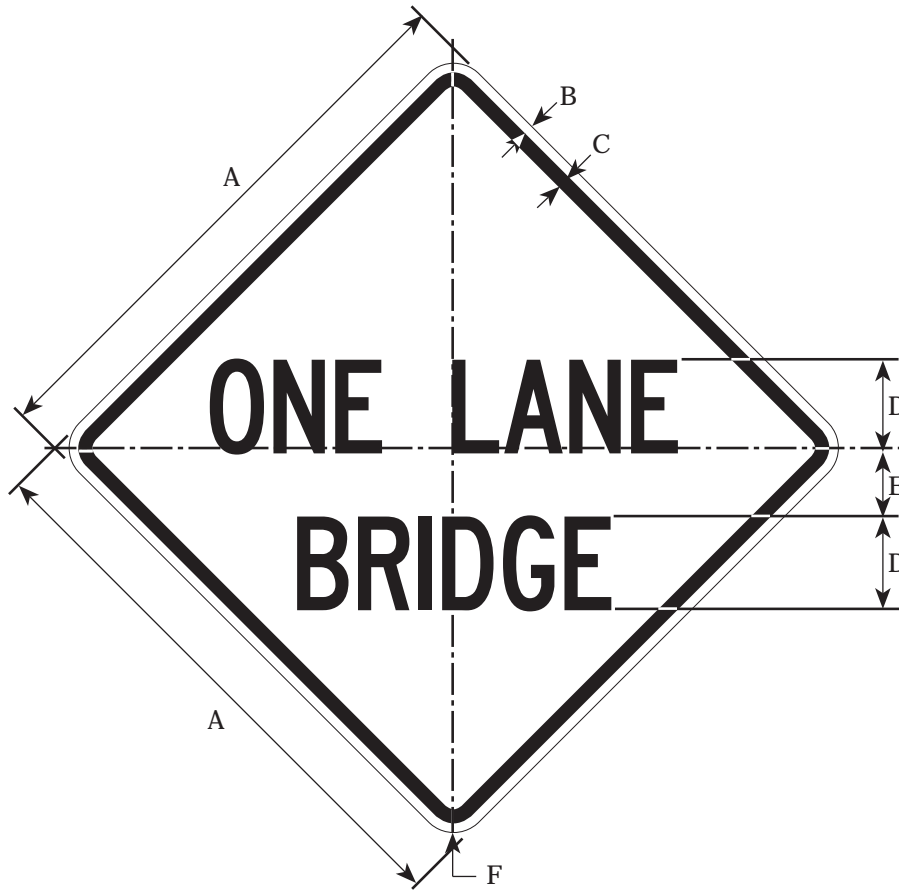

DIMENSIONS (MILLIMETERS)					
A	B	C	D	E	F
750	13	19	125C	84	47
900	16	22	150C	100	56
1200	19	31	200C	133	75

DIMENSIONS (INCHES)					
A	B	C	D	E	F
30	1/2	3/4	5C	3 1/4	1 7/8
36	5/8	7/8	6C	4	2 1/4
48	3/4	1 1/4	8C	5	3

COLORS

LEGEND - BLACK (NON-REFL)
BACKGROUND - YELLOW (REFL)

W5-4

11/97

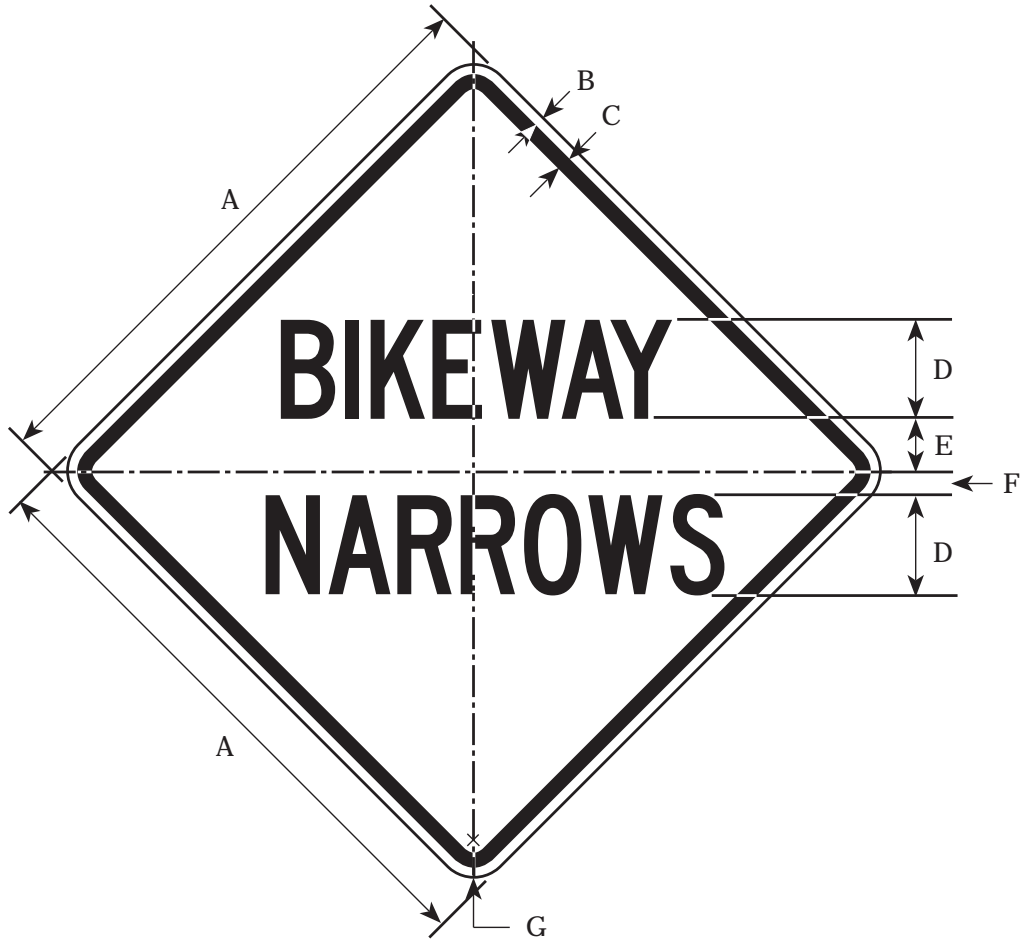

DIMENSIONS (MILLIMETERS)						
A	B	C	D	E	F	G
450	9	16	75C	25	16	38

DIMENSIONS (INCHES)						
A	B	C	D	E	F	G
18	3/8	5/8	3C	1	5/8	1 1/2

COLORS

SYMBOL - BLACK (NON-REFL)
 BACKGROUND - YELLOW (REFL)

W6-1

11/97

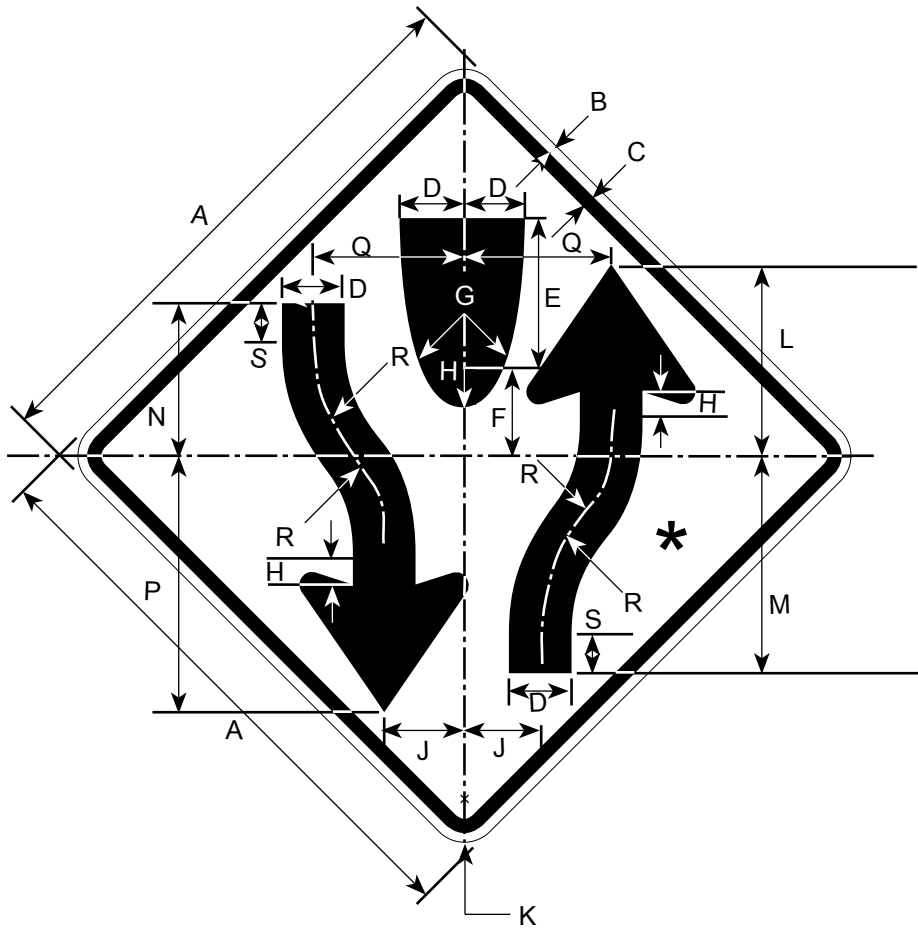

* SEE APPENDIX FOR ARROW DETAILS

DIMENSIONS (MILLIMETERS)															
A	B	C	D	E	F	G	H	K	L	M	N	P	Q	R	S
750	13	19	83	208	103	625	42	47	250	291	199	325	197	208	52
900	16	22	100	250	125	750	50	56	300	350	238	413	238	250	63
1200	19	31	131	328	174	983	66	75	400	467	317	550	31	328	83

DIMENSIONS (INCHES)															
A	B	C	D	E	F	G	H	K	L	M	N	P	Q	R	S
30	1/2	3/4	3 5/16	8 5/16	4 1/8	25	1	1 7/8	10	11	7 15/16	13	7 7/8	8 5/16	2 1/16
36	5/8	7/8	4	10	5	30	2	2 1/4	12	14	9 1/2	16 1/2	9 1/2	10	2 1/2
48	3/4	1 1/4	5 1/4	13 1/8	6 9/16	39 5/16	2 5/8	3	16	18	12	22	12 7/16	13 1/8	3 5/16

COLORS

LEGEND — BLACK (NON-REFL)
 BACKGROUND — YELLOW (REFL)

W6-2

11/97

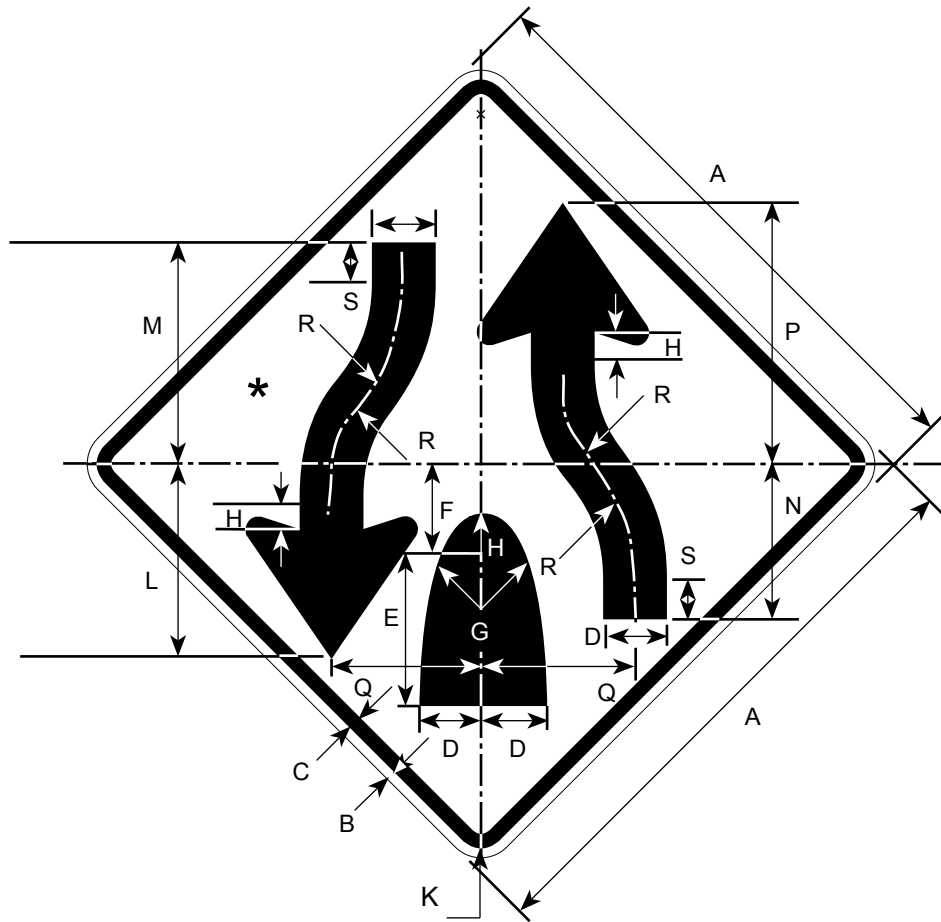

* SEE APPENDIX FOR STANDARD ARROW DETAIL

DIMENSIONS (MILLIMETERS)															
A	B	C	D	E	F	G	H	K	L	M	N	P	Q	R	S
750	13	19	83	208	103	625	42	47	250	291	199	325	197	208	52
900	16	22	100	250	125	750	50	56	300	350	238	413	238	250	63
1200	19	31	131	328	174	983	66	75	400	467	317	550	31	328	83

DIMENSIONS (INCHES)															
A	B	C	D	E	F	G	H	K	L	M	N	P	Q	R	S
30	1/2	3/4	3 5/16	8 5/16	4 1/8	25	1	1 7/8	10	11	7 15/16	13	7 7/8	8 5/16	2 1/16
36	5/8	7/8	4	10	5	30	2	2 1/4	12	14	9 1/2	16 1/2	9 1/2	10	2 1/2
48	3/4	1 1/4	5 1/4	13 1/8	6 9/16	39 5/16	2 5/8	3	16	18	12	22	12 7/16	13 1/8	3 5/16

COLORS

LEGEND — BLACK (NON-REFL)
BACKGROUND — YELLOW (REFL)

W6-3

11/97

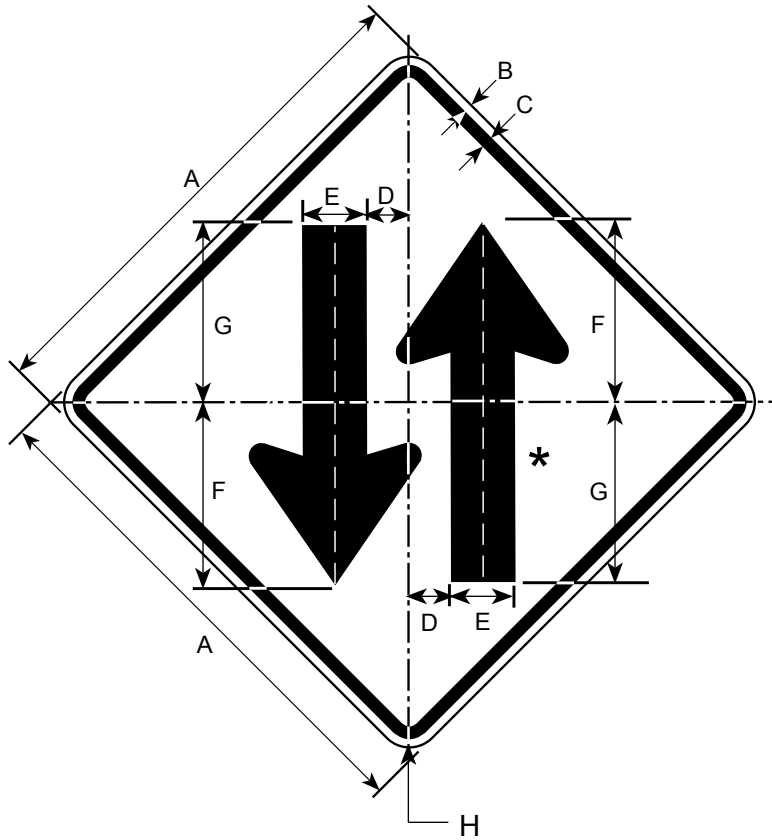

* SEE APPENDIX FOR STANDARD ARROW DETAILS

DIMENSIONS (MILLIMETERS)							
A	B	C	D	E	F	G	H
600	13	19	50	75	225	213	38
750	16	22	61	94	281	266	47
900	19	31	73	111	338	319	56
1200	31	44	97	150	450	425	75

DIMENSIONS (INCHES)							
A	B	C	D	E	F	G	H
24	1/2	3/4	2	3	9	8 1/2	1 1/2
30	5/8	7/8	2 7/16	3 3/4	11	10 5/8	1 7/8
36	3/4	1 1/4	2 15/16	4 1/2	13 1/2	12 3/4	2 1/4
48	1 1/4	1 3/4	3 7/8	6	18	17	3

COLORS

LEGEND—BLACK (NON-REFL)
BACKGROUND—YELLOW (REFL)

W6-401

11/97



ALTERNATE MESSAGE: DIVIDED HIGHWAY ENDS-----MILE

DIMENSIONS (MILLIMETERS)						
A	B	C	D	E	F	G
3300	1200	25	38	250E	250	150

DIMENSIONS (INCHES)						
A	B	C	D	E	F	G
132	48	1	1 1/2	10E	10	6

COLORS

LEGEND - BLACK (NON-REFL)
BACKGROUND - YELLOW (REFL)

W7-1

11/97

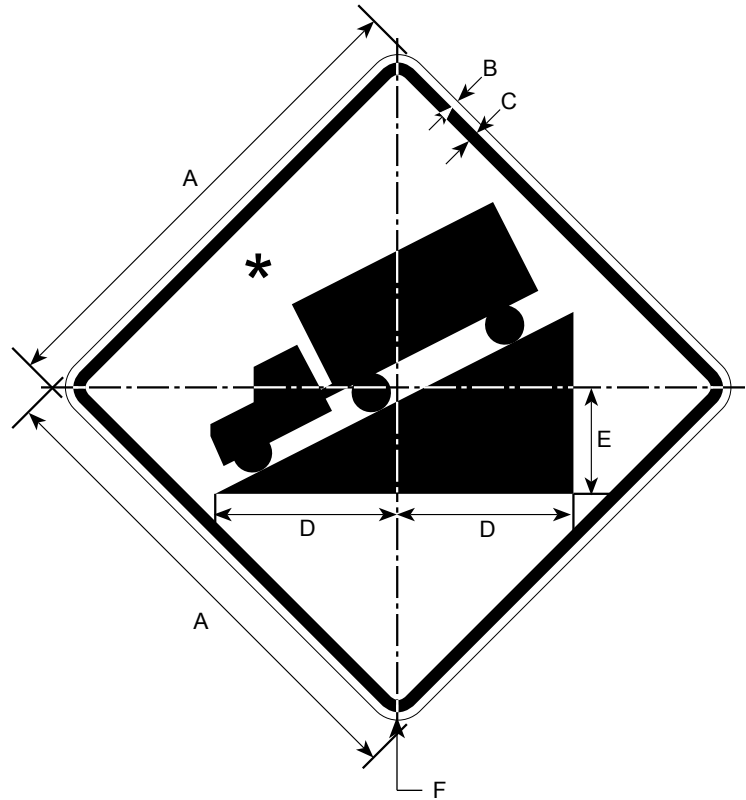

* SEE APPENDIX FOR SYMBOL DESIGN

DIMENSIONS (MILLIMETERS)					
A	B	C	D	E	F
600	9	16	219	150	31
750	13	19	275	188	47
900	16	22	331	225	56
1200	19	31	438	300	75

DIMENSIONS (INCHES)					
A	B	C	D	E	F
24	3/8	5/8	8 3/4	6	1 1/2
30	1/2	3/4	1	7 1/2	1 7/8
36	5/8	7/8	13 1/4	9	2 1/4
48	3/4	1 1/4	17 1/2	12	3

COLORS

LEGEND — BLACK (NON-REFL)
 BACKGROUND — YELLOW (REFL)

W7-101

11/97

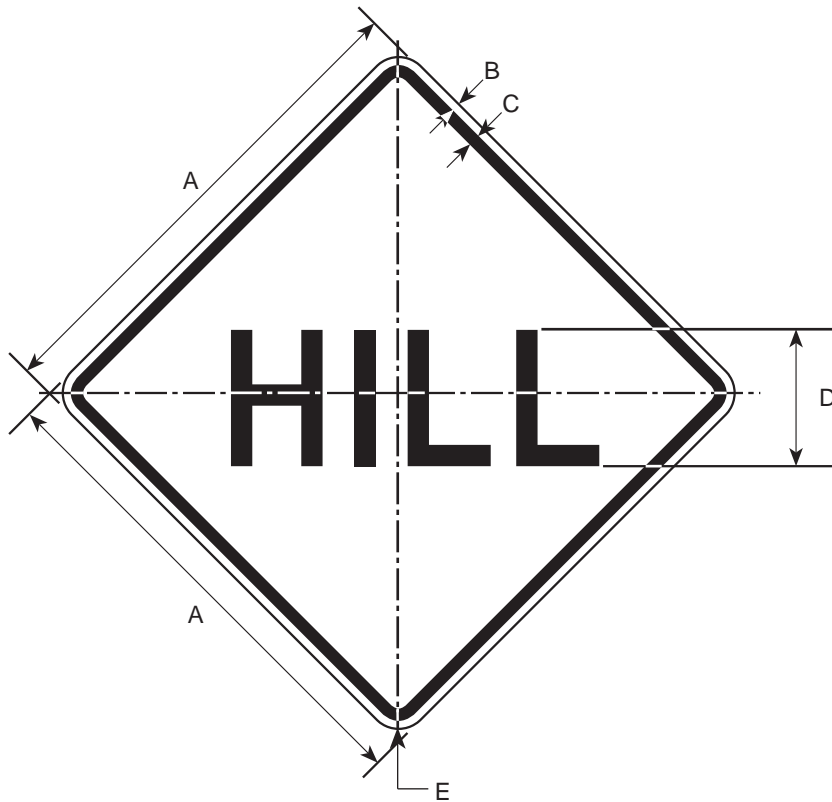

DIMENSIONS (MILLIMETERS)				
A	B	C	D	E
600	9	16	150-D	31
750	13	19	200-D	47
900	16	22	250-D	56
1200	19	31	300-D	75

DIMENSIONS (INCHES)				
A	B	C	D	E
24	3/8	5/8	6-D	1 1/2
30	1/2	3/4	8-D	1 7/8
36	5/8	7/8	10-D	2 1/4
48	3/4	1 1/4	12-D	3

COLORS

LEGEND - BLACK (NON-REFL)
 BACKGROUND - YELLOW (REFL)

W7-2B

11/97

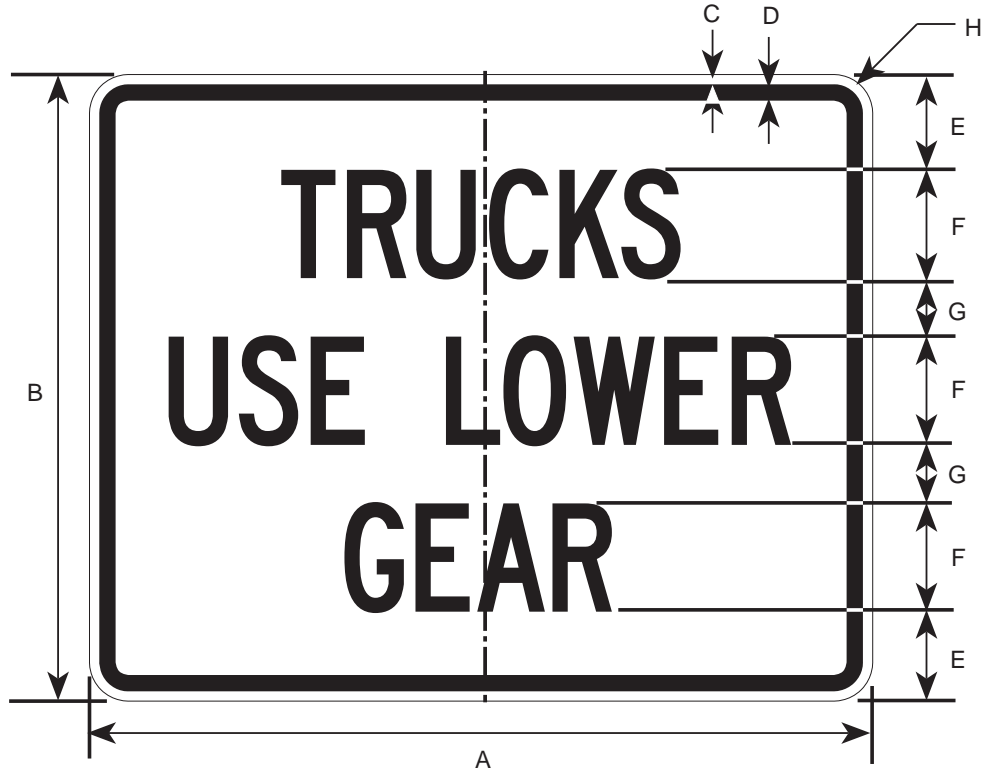

DIMENSIONS (MILLIMETERS)							
A	B	C	D	E	F	G	H
600	450	9	16	75	75C	38	38

DIMENSIONS (INCHES)							
A	B	C	D	E	F	G	H
24	18	3/8	5/8	3	3C	1 1/2	1 1/2

COLORS

LEGEND - BLACK (NON-REFL)
 BACKGROUND - YELLOW (REFL)

W7-3

12/97

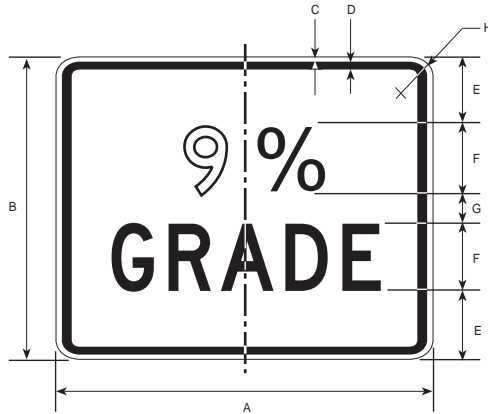

DIMENSIONS (MILLIMETERS)							
A	B	C	D	E	F	G	H
600	450	9	16	100	100D	50	38

DIMENSIONS (INCHES)							
A	B	C	D	E	F	G	H
24	18	3/8	5/8	4	4D	2	1 1/2

W7-3A

12/97

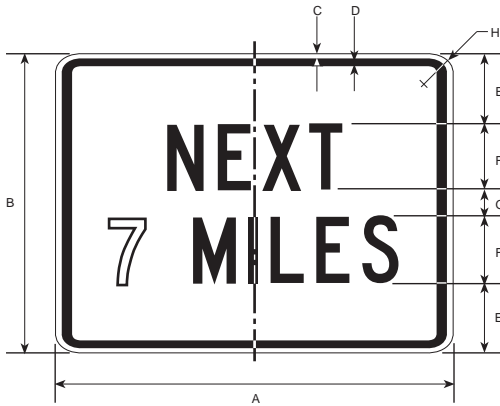

DIMENSIONS (MILLIMETERS)							
A	B	C	D	E	F	G	H
600	450	9	16	100	100C	50	38

DIMENSIONS (INCHES)							
A	B	C	D	E	F	G	H
24	18	3/8	5/8	4	4C	2	1 1/2

W7-3B

12/97

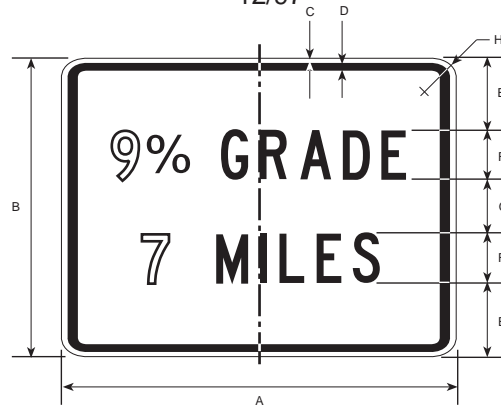

DIMENSIONS (MILLIMETERS)							
A	B	C	D	E	F	G	H
600	450	9	16	100	75C	100	38

DIMENSIONS (INCHES)							
A	B	C	D	E	F	G	H
24	18	3/8	5/8	4	3C	4	1 1/2

COLORS

LEGEND - BLACK (NON-REFL)
BACKGROUND - YELLOW (REFL)

W 7-4

4/06

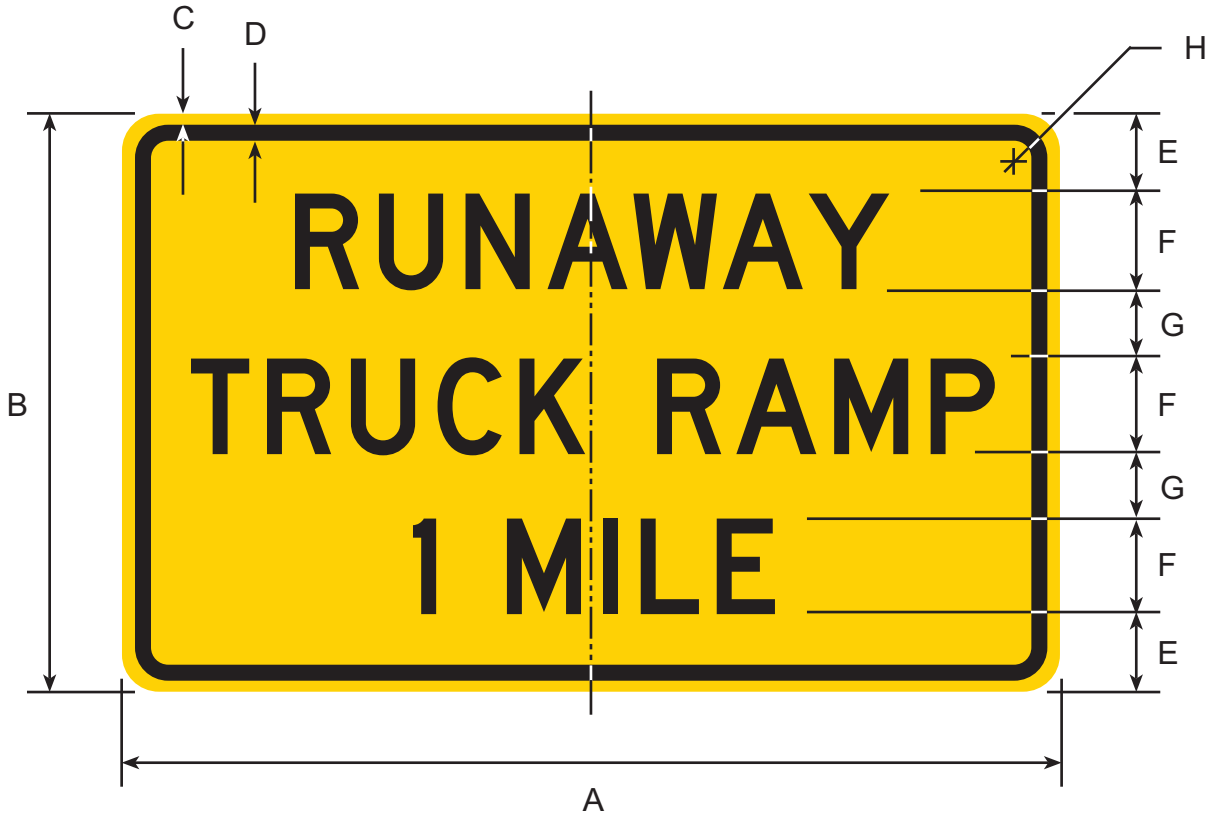

DIMENSIONS (MILLIMETERS)							
A	B	C	D	E	F	G	H
1950	1200	19	31	175	200D	125	75

DIMENSIONS (INCHES)							
A	B	C	D	E	F	G	H
78	48	3/4	1 1/4	7	8D	5	3

COLORS

LEGEND & BORDER - BLACK (NON-REFL)
 BACKGROUND - YELLOW (REFL)

W7-4A

12/97

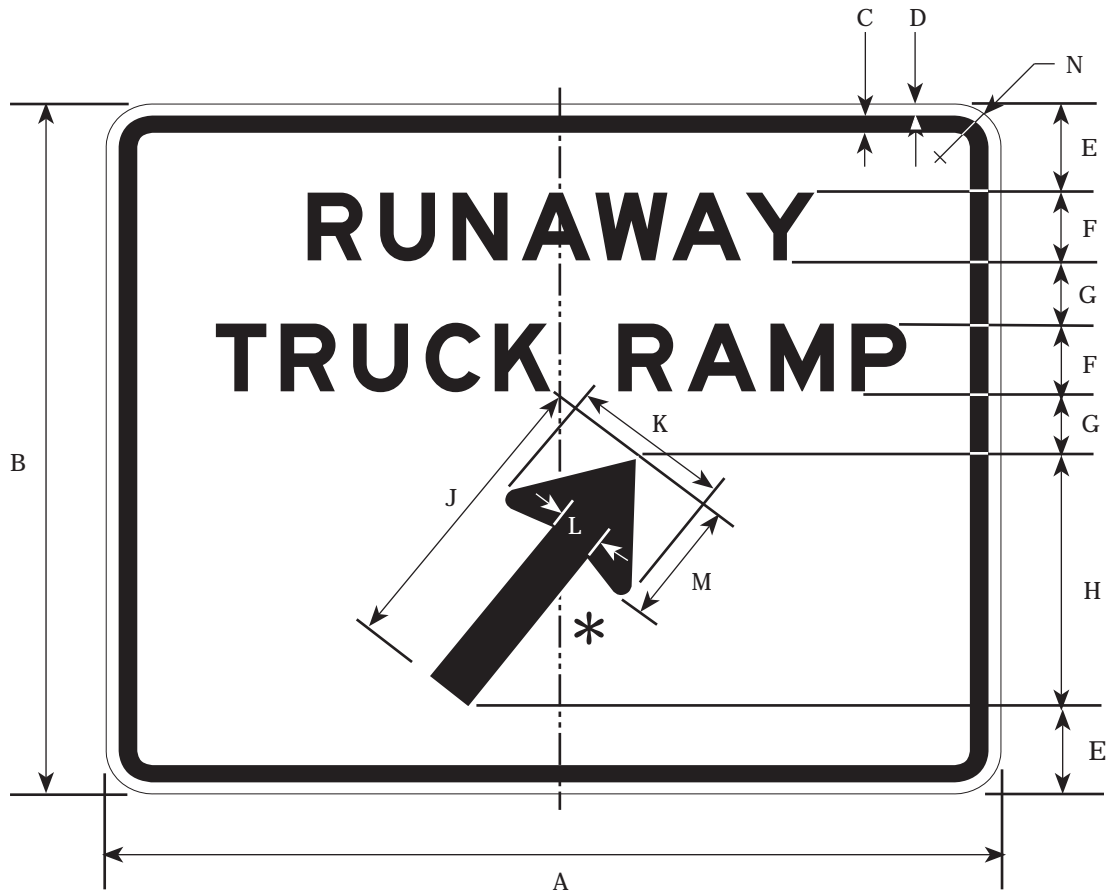

* SEE APPENDIX FOR STANDARD ARROW DETAILS

DIMENSIONS (MILLIMETERS)												
A	B	C	D	E	F	G	H	J	K	L	M	N
1950	1500	31	19	175	200C	125	500	675	378	94	289	75

DIMENSIONS (INCHES)												
A	B	C	D	E	F	G	H	J	K	L	M	N
78	60	1 1/4	3/4	7	8-C	5	20	27	15 1/8	3 3/4	11 9/16	3

COLORS

LEGEND - BLACK (NON-REFL.)
 BACKGROUND - YELLOW (REFL.)

W 7-4B

4/06

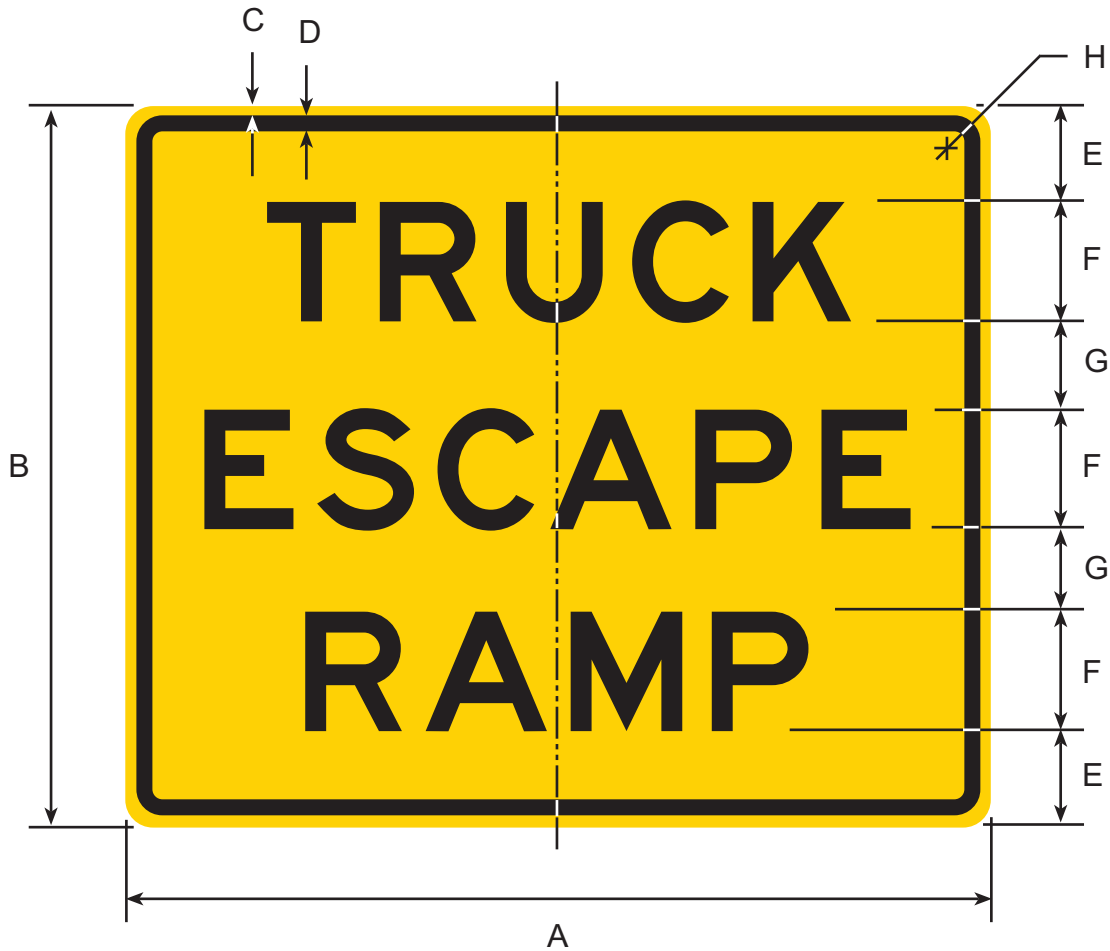

DIMENSIONS (MILLIMETERS)							
A	B	C	D	E	F	G	H
1800	1500	25	31	200	250E	175	75

DIMENSIONS (INCHES)							
A	B	C	D	E	F	G	H
72	60	1	1 1/4	8	10E	7	3

COLORS

LEGEND & BORDER - BLACK (NON-REFL)
 BACKGROUND - YELLOW (REFL)

W7-4C, W7-4D, & W7-4E

4/06

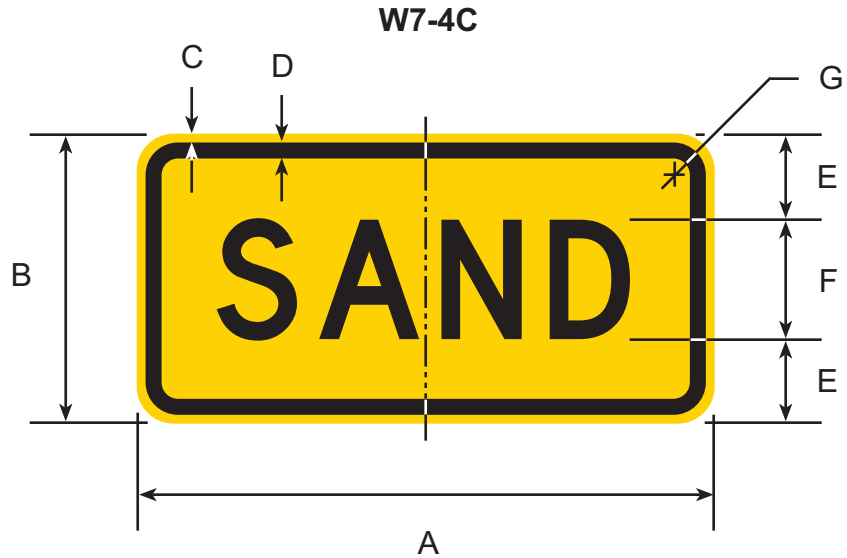

W7-4D*



W7-4E



* Use letter series C for GRAVEL message

DIMENSIONS (MILLIMETERS)						
A	B	C	D	E	F	G
600	300	9	16	88	125D	38

DIMENSIONS (INCHES)						
A	B	C	D	E	F	G
24	12	3/8	5/8	3 1/2	5C	1 1/2

COLORS

LEGEND & BORDER - BLACK (NON-REFL)
BACKGROUND - YELLOW (REFL)

W7-5

12/97

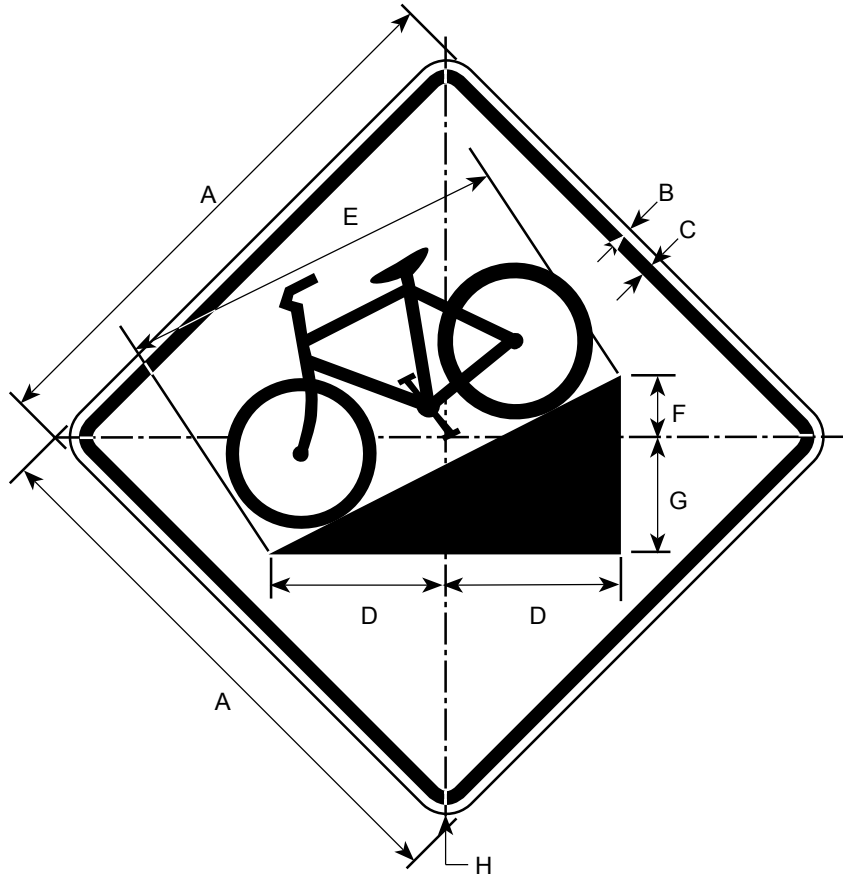

* SEE APPENDIX FOR STANDARD SYMBOL DETAILS

DIMENSIONS (MILLIMETERS)							
A	B	C	D	E	F	G	H
450	9	16	141	316	44	100	38

DIMENSIONS (INCHES)							
A	B	C	D	E	F	G	H
18	3/8	5/8	5 5/8	12 5/8	1 3/4	4	1 1/2

COLORS

LEGEND, SYMBOL, BORDER - BLACK (NON-REFL.)
 BACKGROUND - YELLOW (REFL.)

W8-1

12/97

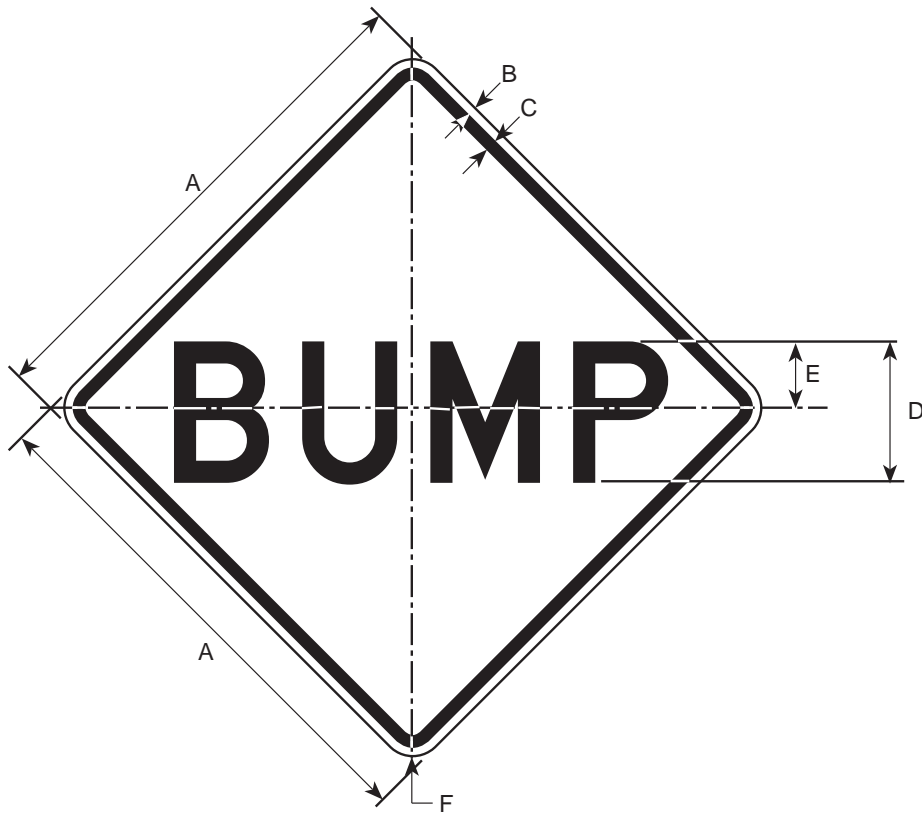

DIMENSIONS (MILLIMETERS)					
A	B	C	D	E	F
600	9	16	150D	75	38
750	13	19	200D	100	47
900	16	22	250D	125	56
1200	19	31	300D	150	75

DIMENSIONS (INCHES)					
A	B	C	D	E	F
24	3/8	5/8	6D	3	1 1/2
30	1/2	3/4	8D	4	1 7/8
36	5/8	7/8	10D	5	2 1/4
48	3/4	1 1/4	12D	6	3

COLORS

LEGEND - BLACK (NON-REFL)
 BACKGROUND - YELLOW (REFL)

W8-2

12/97

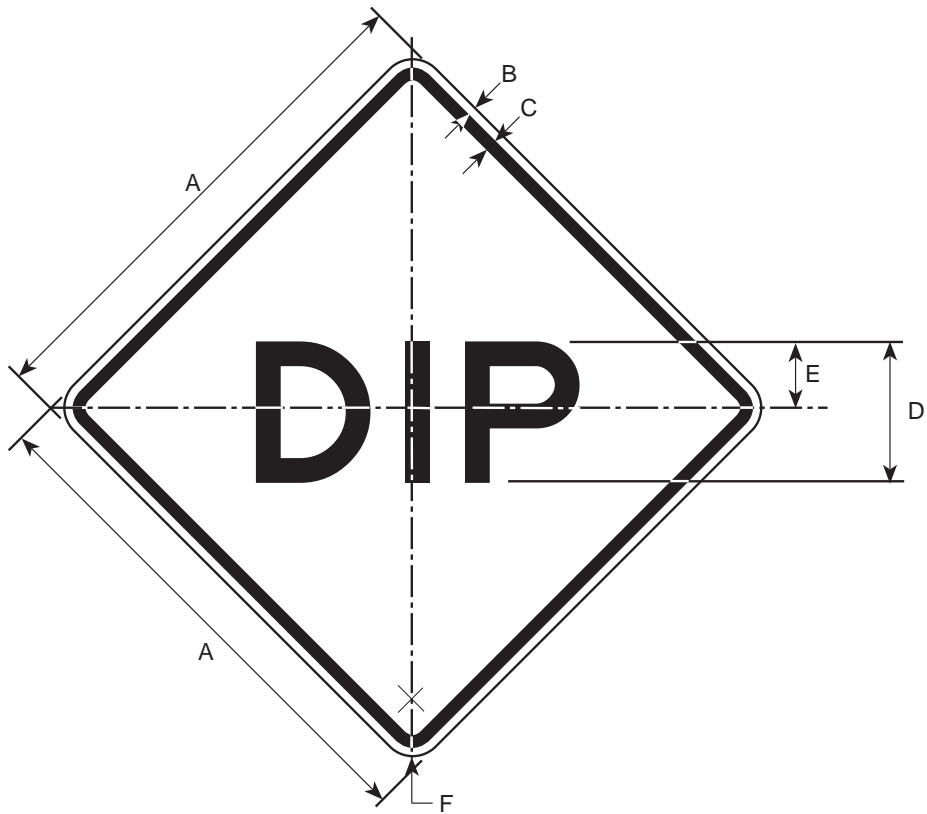

DIMENSIONS (MILLIMETERS)					
A	B	C	D	E	F
600	9	16	150E	75	38
750	13	19	200E	100	47
900	16	22	250E	125	56
1200	19	31	300E	150	75

DIMENSIONS (INCHES)					
A	B	C	D	E	F
24	3/8	5/8	6E	3	1 1/2
30	1/2	3/4	8E	4	1 7/8
36	5/8	7/8	10E	5	2 1/4
48	3/4	1 1/4	12E	6	3

COLORS

LEGEND - BLACK (NON-REFL)
BACKGROUND - YELLOW (REFL)

W8-3

12/97

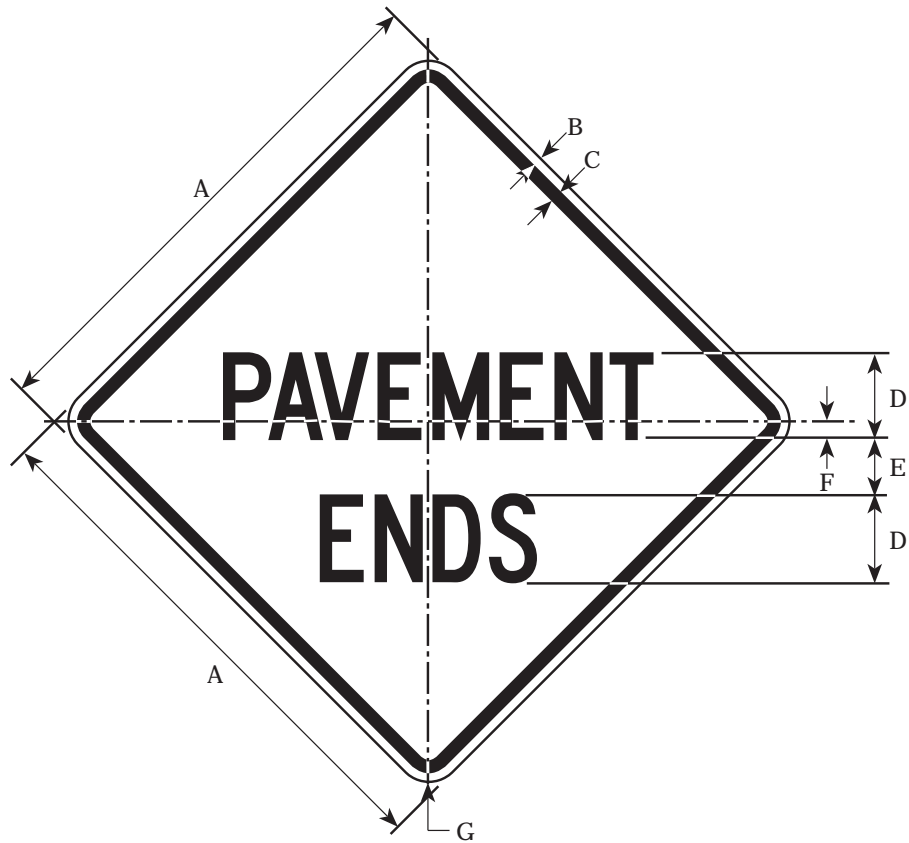

DIMENSIONS (MILLIMETERS)						
A	B	C	D	E	F	G
600	9	16	100C	56	13	38
750	12	19	125C	75	19	47
900	16	22	150C	88	25	56
1200	19	31	200C	111	47	75

DIMENSIONS (INCHES)						
A	B	C	D	E	F	G
18	3/8	5/8	4C	2 1/2	1/2	1 1/2
24	1/2	3/4	5C	3	3/4	1 7/8
36	5/8	7/8	6C	3 1/2	1	2 1/4
48	3/4	1 1/4	8C	4 1/2	1 1/2	3

COLORS

LEGEND - BLACK (NON-REFL)
BACKGROUND - YELLOW (REFL)

W8-4

12/97

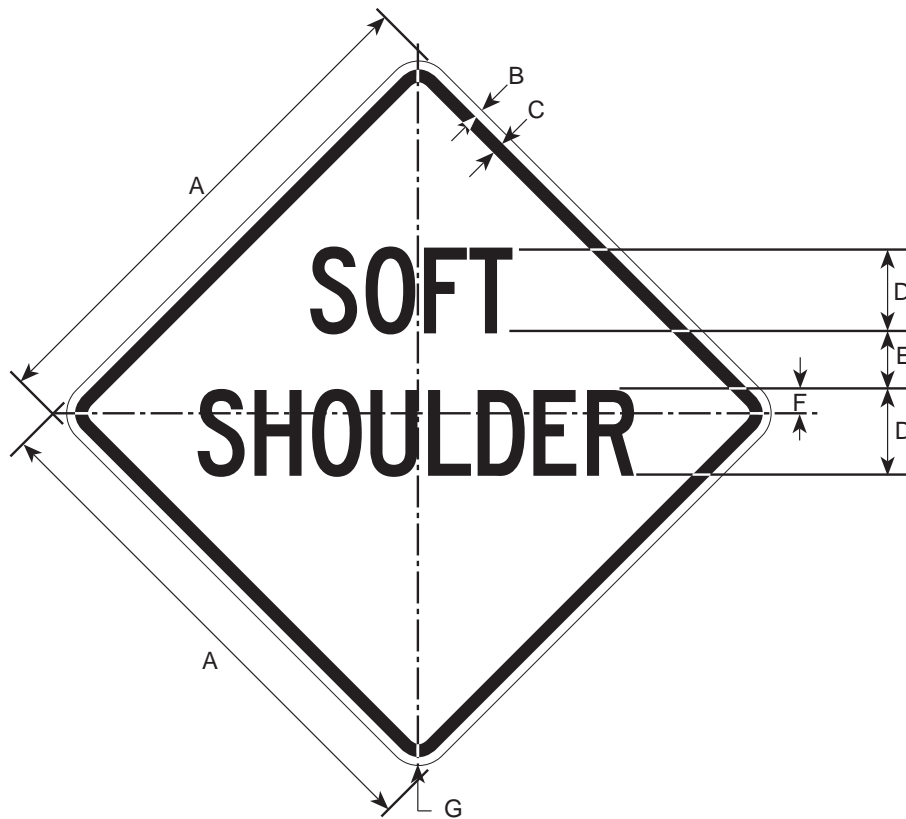

DIMENSIONS (MILLIMETERS)						
A	B	C	D	E	F	G
600	9	16	100C	63	13	38
750	13	19	125C	75	19	47
900	16	22	150C	88	25	56
1200	19	31	200C	125	31	75

DIMENSIONS (INCHES)						
A	B	C	D	E	F	G
24	3/8	5/8	4C	2 1/2	1/2	1 1/2
30	1/2	3/4	5C	3	3/4	1 7/8
36	5/8	7/8	6C	3 1/2	1	2 1/4
48	3/4	1 1/4	8C	5	1 1/4	3

COLORS

LEGEND - BLACK (NON-REFL)
 BACKGROUND - YELLOW (REFL)

W8-5

12/97

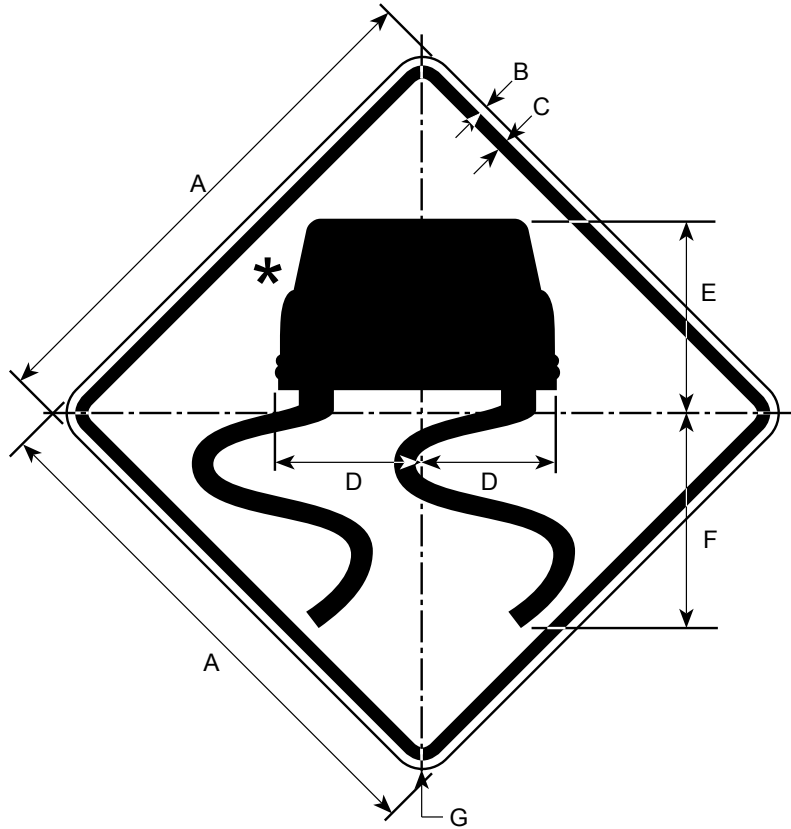

* SEE APPENDIX FOR SYMBOL DESIGN

DIMENSIONS (MILLIMETERS)						
A	B	C	D	E	F	G
600	9	16	158	217	247	38
750	13	19	200	275	313	47
900	16	22	238	325	371	56
1200	19	31	316	434	494	75

DIMENSIONS (INCHES)						
A	B	C	D	E	F	G
24	3/8	5/8	6 5/16	8 11/16	9 7/8	1 1/2
30	1/2	3/4	8	1	12 1/2	1 7/8
36	5/8	7/8	9 1/2	13	14 13/16	2 1/4
48	3/4	1 1/4	12 5/8	17 3/8	19 3/4	3

COLORS

LEGEND — BLACK (NON-REFL)
 BACKGROUND — YELLOW (REFL)

W8-6

12/97

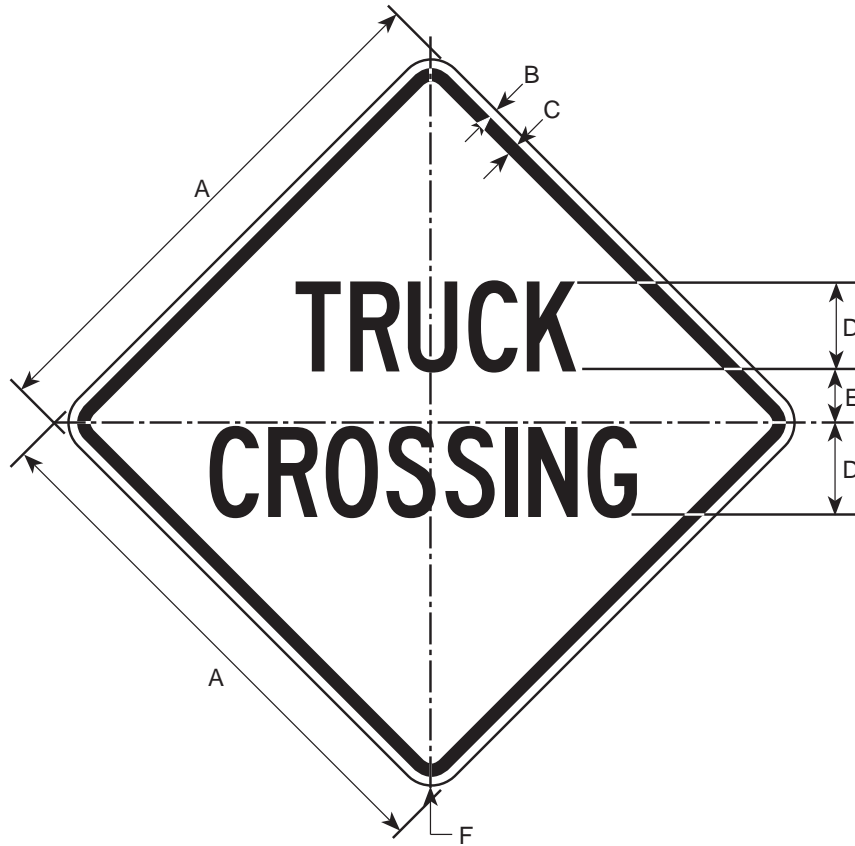

DIMENSIONS (MILLIMETERS)					
A	B	C	D	E	F
600	9	16	100C	63	38
750	13	19	125C	75	47
900	16	22	150C	88	56
1200	19	31	200C	125	75

DIMENSIONS (INCHES)					
A	B	C	D	E	F
24	3/8	5/8	4C	2 1/2	1 1/2
30	1/2	3/4	5C	3	1 7/8
36	5/8	7/8	6C	3 1/2	2 1/4
48	3/4	1 1/4	8C	5	3

COLORS

LEGEND - BLACK (NON-REFL)
BACKGROUND - YELLOW (REFL)

W8-7

12/97

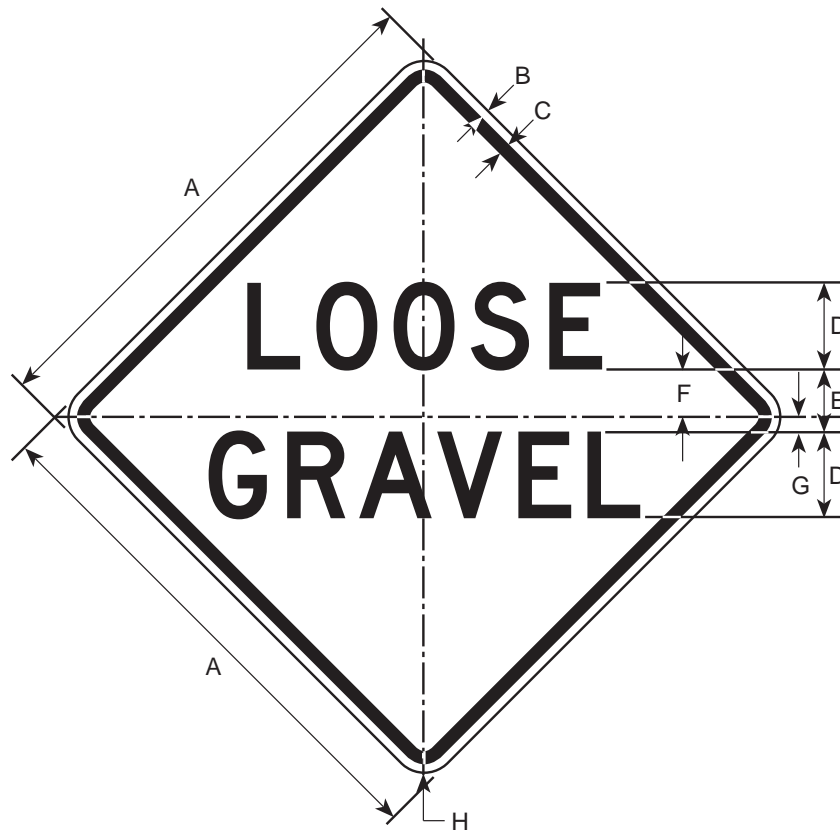

DIMENSIONS (MILLIMETERS)							
A	B	C	D	E	F	G	H
600	9	16	100D	69	56	13	38
750	12	19	125D	86	71	16	47
900	16	22	150D	103	84	19	56
1200	19	31	200D	138	111	25	75

DIMENSIONS (INCHES)							
A	B	C	D	E	F	G	H
24	3/8	5/8	4D	2 3/4	2 3/4	1/2	1 1/2
30	1/2	3/4	5D	3 7/16	3 7/16	5/8	1 7/8
36	5/8	7/8	6D	4 1/8	4 1/8	3/4	2 1/4
48	3/4	1 1/4	8D	5 1/2	5 1/2	1	3

COLORS

LEGEND - BLACK (NON-REFL)
BACKGROUND - YELLOW (REFL)

W8-8

12/97

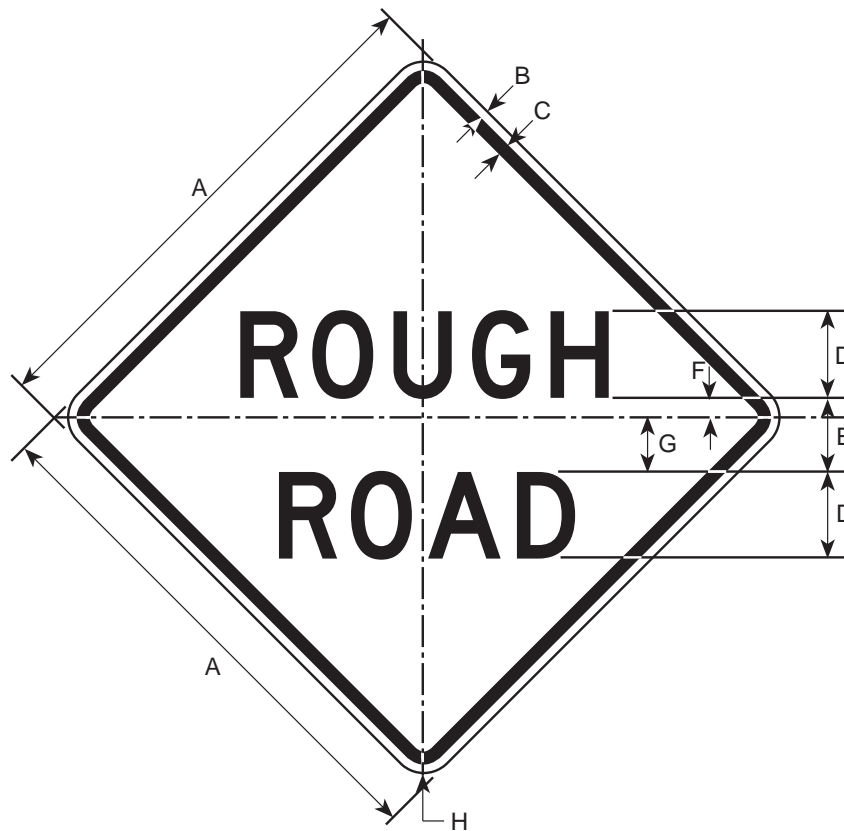

DIMENSIONS (MILLIMETERS)							
A	B	C	D	E	F	G	H
600	9	16	100D	75	19	56	38
750	13	19	125D	100	22	78	47
900	16	22	150D	125	25	100	56
1200	19	31	200D	150	38	113	75

DIMENSIONS (INCHES)							
A	B	C	D	E	F	G	H
24	3/8	5/8	4D	3	3/4	2 1/4	1 1/2
30	1/2	3/4	5D	4	7/8	3 1/8	1 7/8
36	5/8	7/8	6D	5	1	4	2 1/4
48	3/4	1 1/4	8D	6	1 1/2	4 1/2	3

COLORS

LEGEND - BLACK (NON-REFL)
BACKGROUND - YELLOW (REFL)

W8-9

12/97

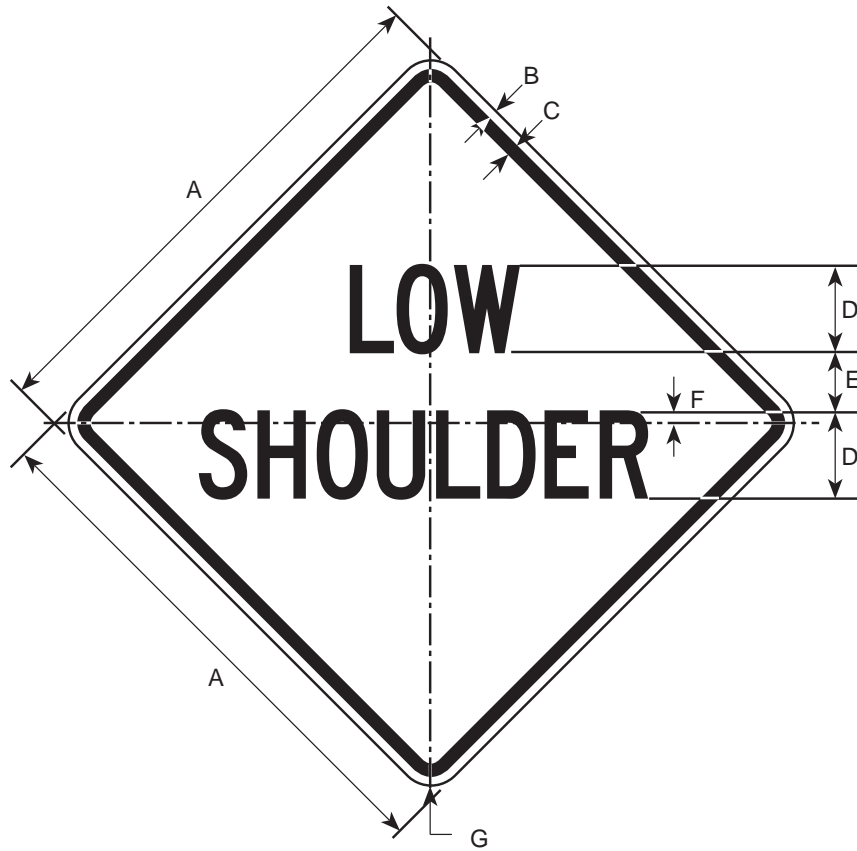

DIMENSIONS (MILLIMETERS)						
A	B	C	D	E	F	G
600	9	16	100C	63	13	38
750	13	19	125C	75	19	47
900	16	22	150C	88	25	56
1200	19	31	200C	125	31	75

DIMENSIONS (INCHES)						
A	B	C	D	E	F	G
24	3/8	5/8	4C	2 1/2	1/2	1 1/2
30	1/2	3/4	5C	3	3/4	1 7/8
36	5/8	7/8	6C	3 1/2	1	2 1/4
48	3/4	1 1/4	8C	5	1 1/4	3

COLORS

LEGEND - BLACK (NON-REFL)
BACKGROUND - YELLOW (REFL)

W8-10

12/97

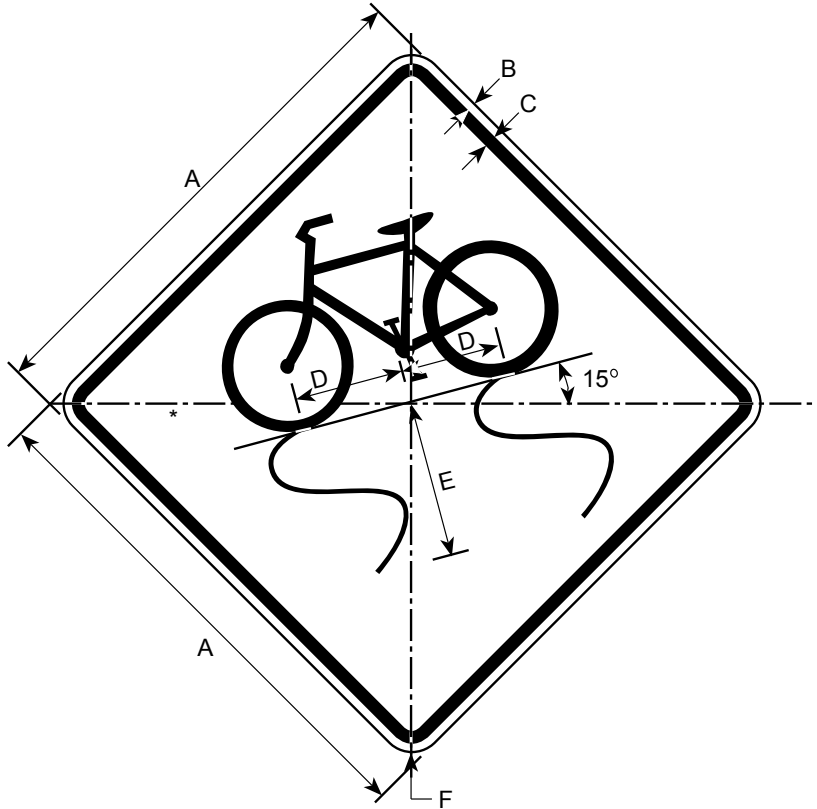

* SEE APPENDIX FOR STANDARD SYMBOL DETAILS

DIMENSIONS (MILLIMETERS)					
A	B	C	D	E	F
450	9	16	241	144	38
750	13	19	150	241	47

DIMENSIONS (INCHES)					
A	B	C	D	E	F
18 3/8	5/8	3 5/8	5 3/4	1 1/2	
30 1/2	3/4	6	9 5/8	1 7/8	

COLORS

LEGEND, SYMBOL, BORDER - BLACK (NON-REFL)
 BACKGROUND — YELLOW (REFL)

W8-11

12/97

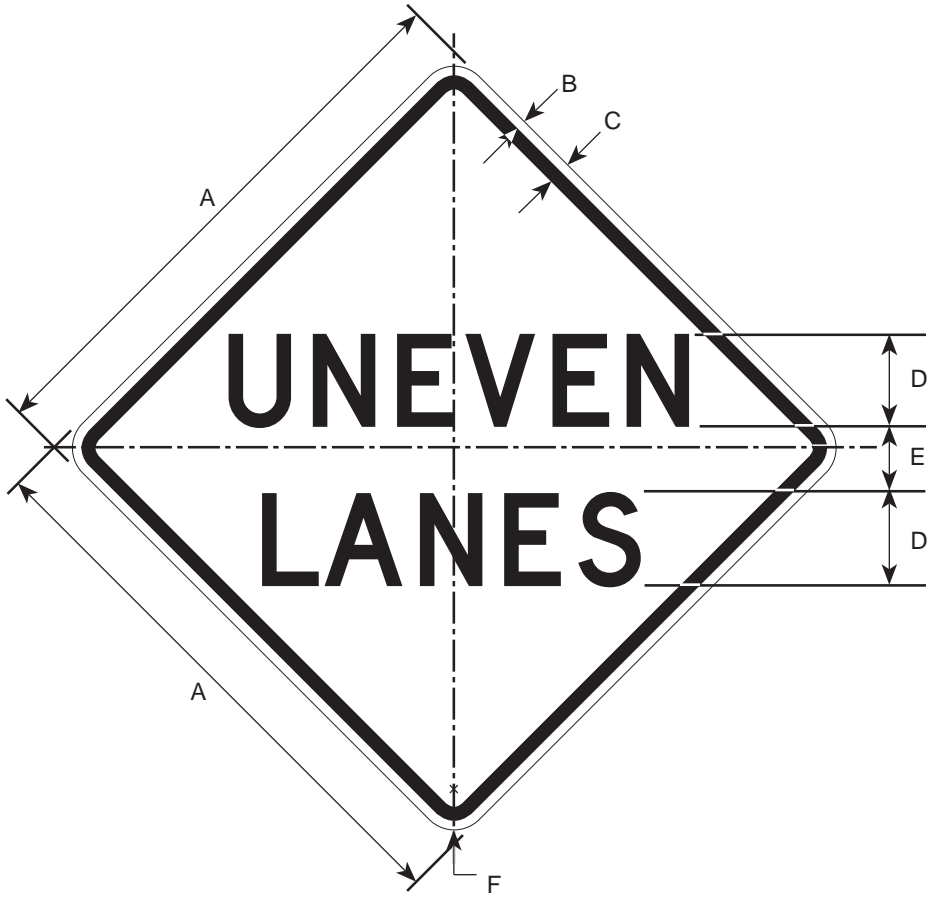

DIMENSIONS (MILLIMETERS)					
A	B	C	D	E	F
900	16	22	150D	4 1/2	1 1/2
1200	19	31	175D	150	50

DIMENSIONS (INCHES)					
A	B	C	D	E	F
36	5/8	7/8	6D	4 1/2	1 1/2
48	3/4	1 1/4	7D	6	2

COLORS

LEGEND - BLACK (NON-REFL)
 BACKGROUND - ORANGE (REFL)

W8-12

12/97

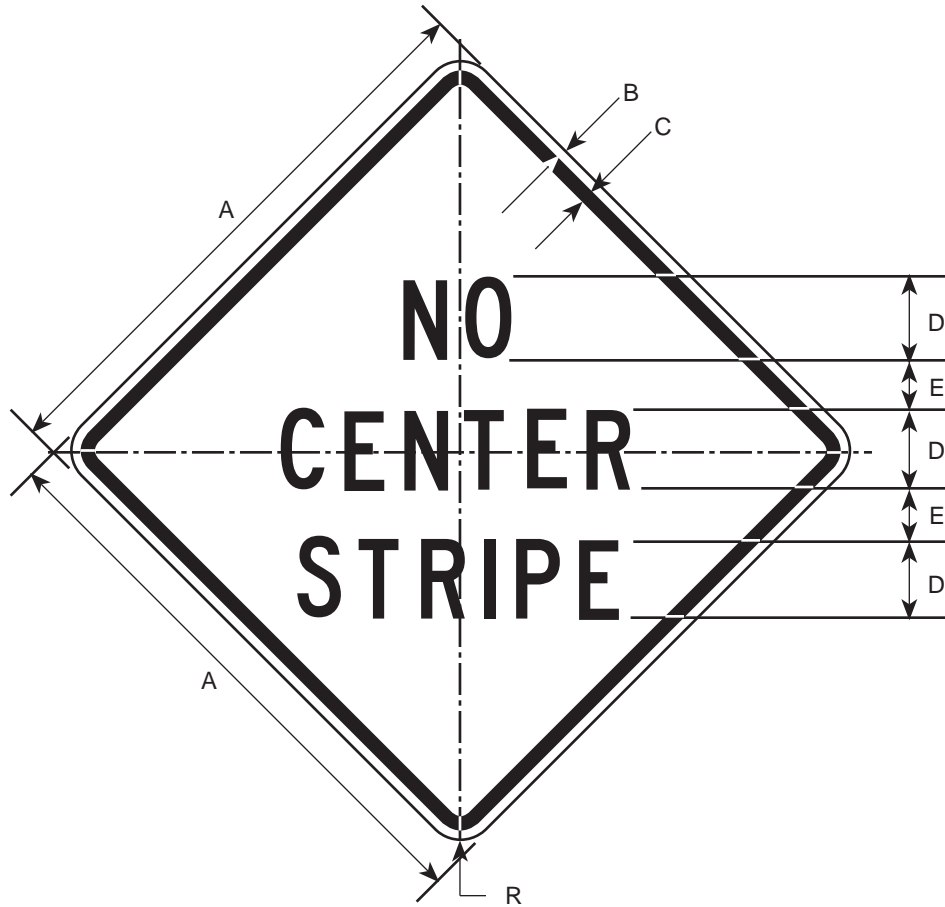

DIMENSIONS (MILLIMETERS)					
A	B	C	D	E	R
750	13	19	100C	56	47
900	16	22	125C	88	56
1200	19	31	175C	113	75

DIMENSIONS (INCHES)					
A	B	C	D	E	R
30	1/2	3/4	4-C	2 1/2	1 7/8
36	5/8	7/8	5-C	3 1/4	2 1/4
48	3/4	1 1/4	7-C	4 1/2	3

COLORS

LEGEND - BLACK (NON-REFL)
BACKGROUND - ORANGE (REFL.)

W8-1501

12/97

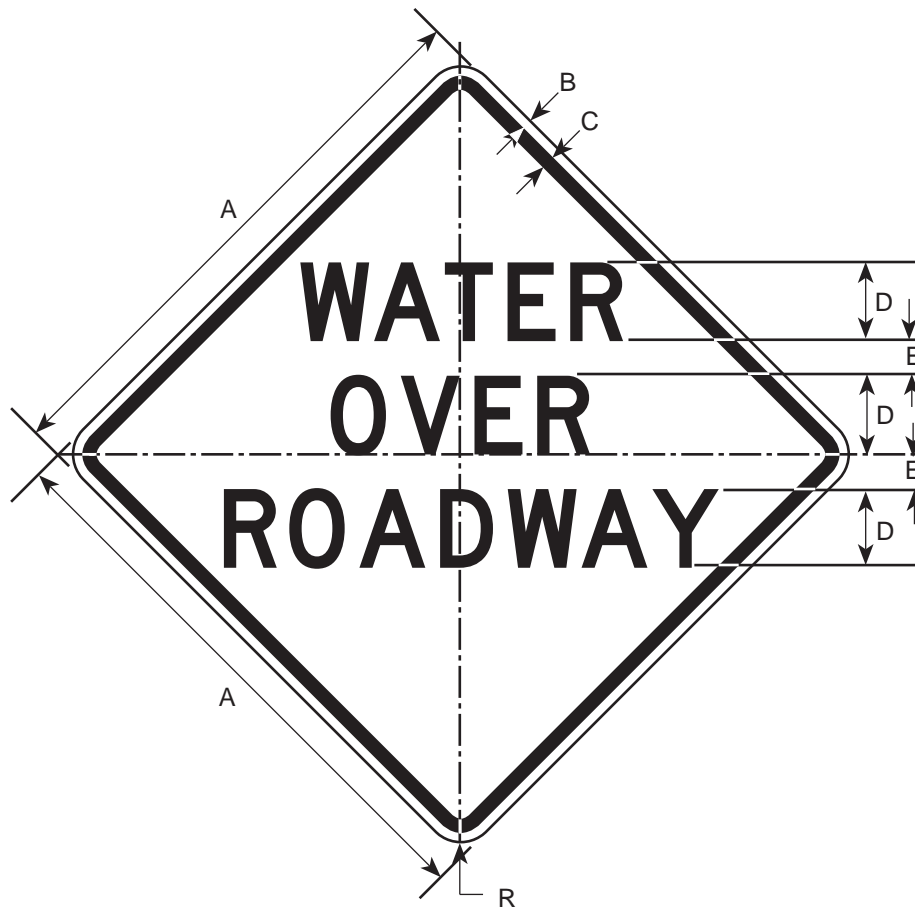

DIMENSIONS (MILLIMETERS)					
A	B	C	D	E	R
750	13	19	100-D	37	47
900	16	22	125-D	44	56
1200	19	37	175-D	56	75

DIMENSIONS (INCHES)					
A	B	C	D	E	R
30	1/2	3/4	4-D	1 1/4	1 7/8
36	5/8	7/8	5-D	1 3/4	2 1/4
48	3/4	1 1/4	7-D	2 1/4	3

COLORS

LEGEND - BLACK (NON-REFL)
 BACKGROUND - YELLOW (REFL)

W8-1601

12/97



DIMENSIONS (MILLIMETERS)					
A	B	C	D	E	R
750	13	19	125-D	75	47
900	16	22	125-D	100	56
1200	19	37	175-D	131	75

DIMENSIONS (INCHES)					
A	B	C	D	E	R
30	1/2	3/4	5-D	3	1 7/8
36	5/8	7/8	6-D	4	2 1/4
48	3/4	1 1/4	8-D	5 1/4	3

COLORS

LEGEND - BLACK (NON-REFL)
 BACKGROUND - YELLOW (REFL)

W8-1701

12/97

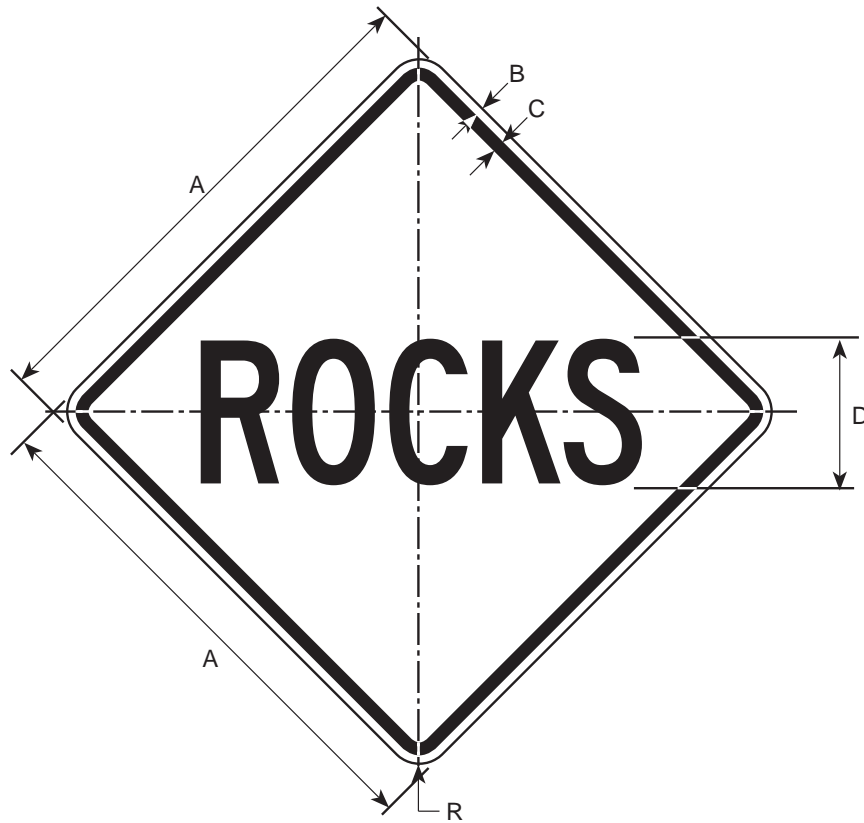

DIMENSIONS (MILLIMETERS)				
A	B	C	D	R
600	9	16	150-C	38
750	13	19	200-C	47
900	16	22	250-C	56
1200	19	31	300-C	75

DIMENSIONS (INCHES)				
A	B	C	D	R
24	3/8	5/8	6-C	1 1/2
30	1/2	3/4	8-C	1 7/8
36	5/8	7/8	10-C	2 1/4
48	3/4	1 1/4	12-C	3

COLORS

LEGEND - BLACK (NON-REFL)
BACKGROUND - YELLOW (REFL)

W8-1801

12/97

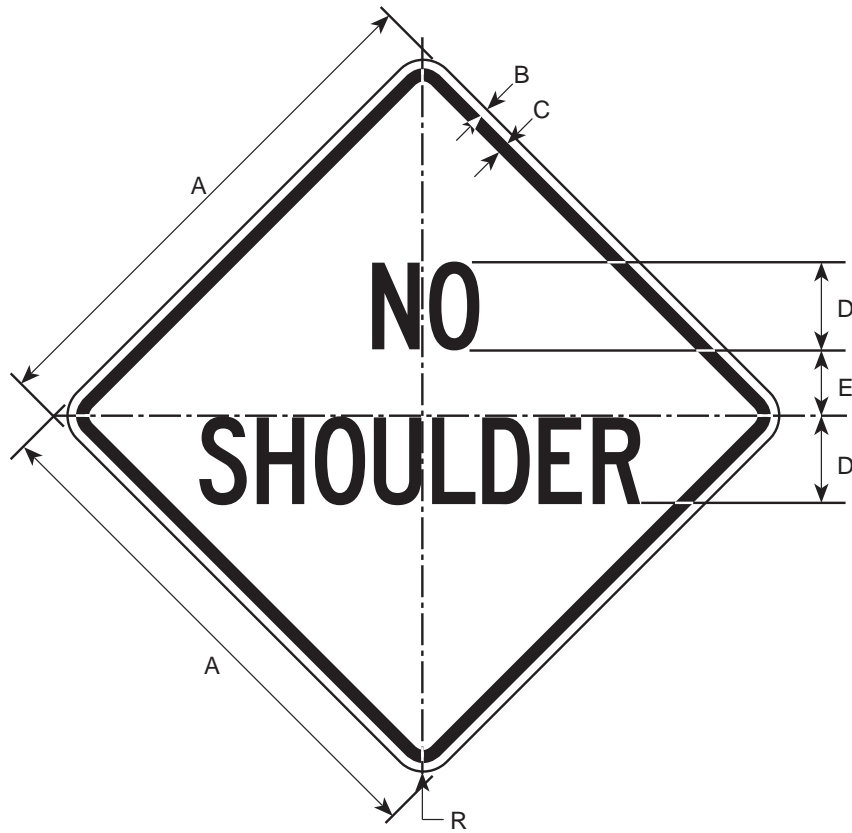

DIMENSIONS (MILLIMETERS)					
A	B	C	D	E	R
600	9	16	100-C	69	38
750	13	19	125-C	94	47
900	16	22	150-C	11	56
1200	19	31	175-C	150	75

DIMENSIONS (INCHES)					
A	B	C	D	E	R
24	3/8	5/8	4-C	2 3/4	1 1/2
30	1/2	3/4	5-C	3 3/4	1 7/8
36	5/8	7/8	6-C	4 1/2	2 1/4
48	3/4	1 1/4	7-C	6	3

COLORS

LEGEND - BLACK (NON-REFL.)
 BACKGROUND - YELLOW (REFL.)

W8-1901

12/97

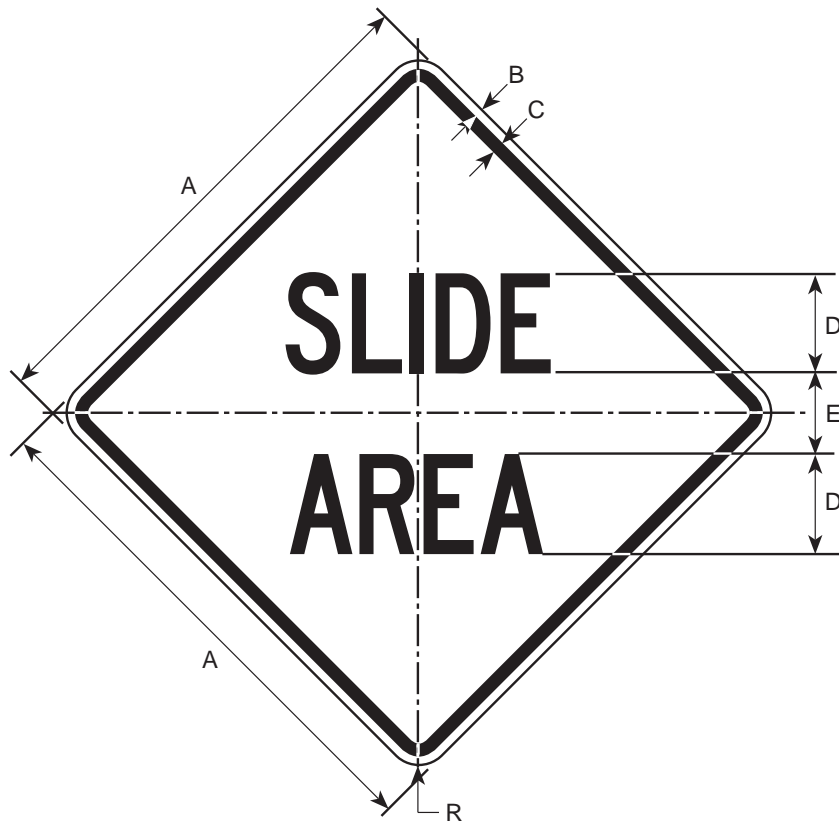

DIMENSIONS (MILLIMETERS)					
A	B	C	D	E	R
600	9	16	125-C	88	38
750	13	19	150-C	11	47
900	16	22	175-C	138	56
1200	19	31	250-C	175	75

DIMENSIONS (INCHES)					
A	B	C	D	E	R
24	3/8	5/8	5-C	3 1/2	1 1/2
30	1/2	3/4	6-C	4 1/2	1 7/8
36	5/8	7/8	7-C	5 1/2	2 1/4
48	3/4	1 1/4	10-C	7	3

COLORS

LEGEND - BLACK (NON-REFL.)
BACKGROUND - YELLOW (REFL.)

W8-2001

12/97

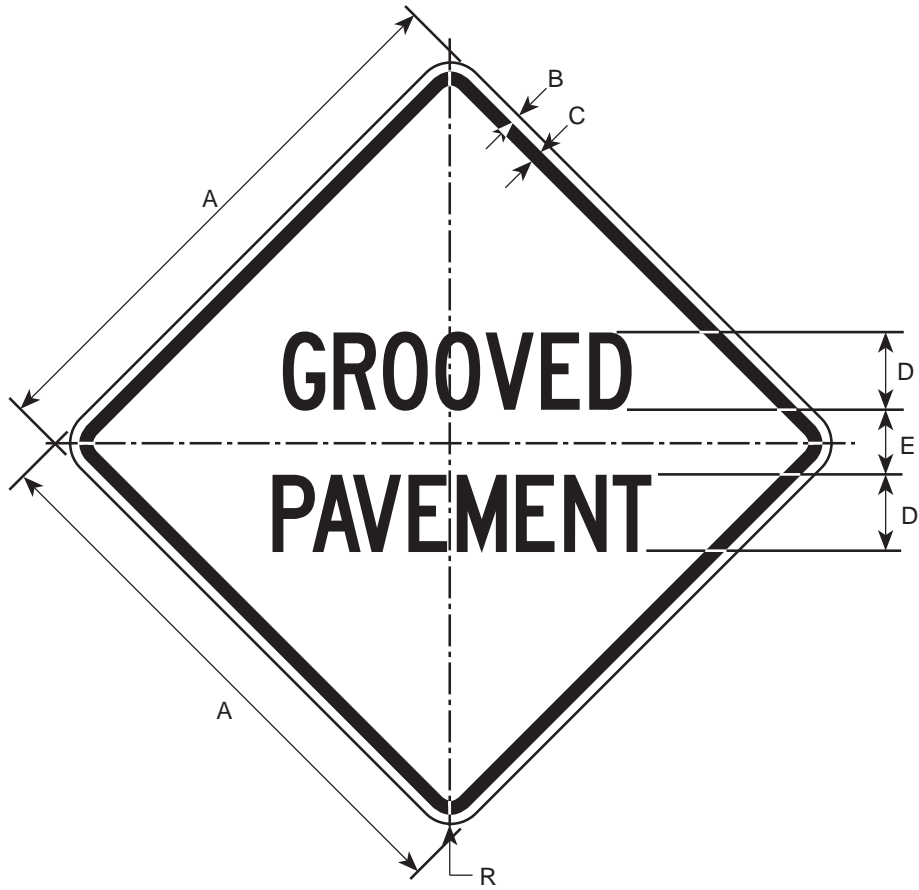

DIMENSIONS (MILLIMETERS)					
A	B	C	D	E	R
750	13	19	100-C	75	47
900	16	22	125-C	88	56
1200	19	31	175-C	11	75

DIMENSIONS (INCHES)					
A	B	C	D	E	R
30	1/2	3/4	4-C	3	1 7/8
36	5/8	7/8	5-C	3 1/2	2 1/4
48	3/4	1 1/4	7-C	4 1/2	3

COLORS

LEGEND - BLACK (NON-REFL.)
BACKGROUND - YELLOW (REFL.)

W8-2101

11/97

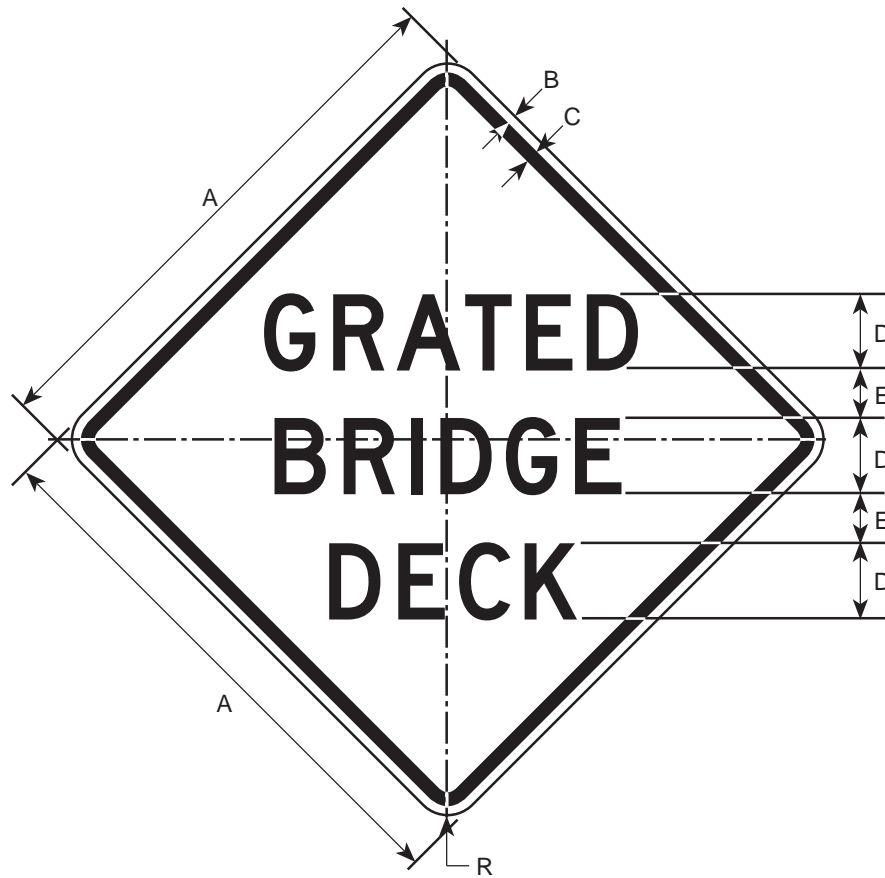

DIMENSIONS (MILLIMETERS)					
A	B	C	D	E	R
750	13	19	100-D	50	47
900	16	22	125-D	56	56
1200	19	31	175-D	75	75

DIMENSIONS (INCHES)					
A	B	C	D	E	R
30	1/2	3/4	4-D	2	1 7/8
36	5/8	7/8	5-D	2 1/2	2 1/4
48	3/4	1 1/4	7-D	3 1/4	3

COLORS

LEGEND - BLACK (NON-REFL.)
BACKGROUND - YELLOW (REFL.)

W8-2201

11/97

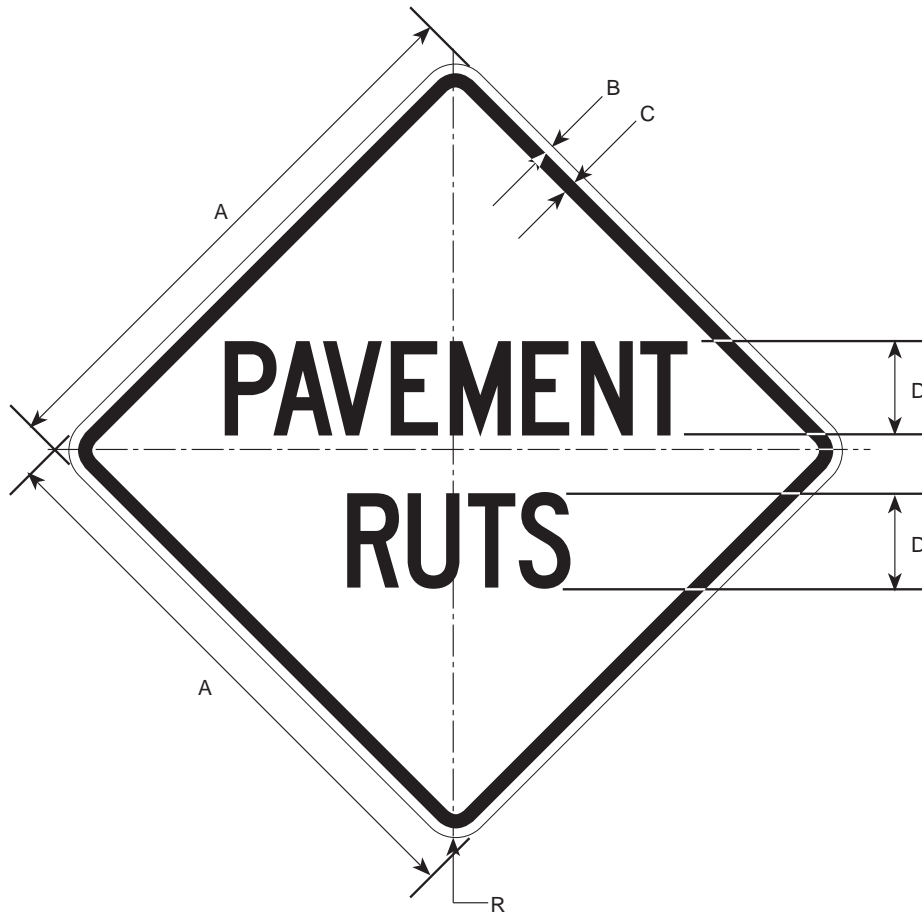

DIMENSIONS (MILLIMETERS)				
A	B	C	D	R
1200	19	31	200C	75

DIMENSIONS (INCHES)				
A	B	C	D	R
48	3/4	1 1/4	8C	3

COLORS

LEGEND - BLACK (NON-REFL)
BACKGROUND - YELLOW (REFL)

W9 -1L & W9-1R

11/97

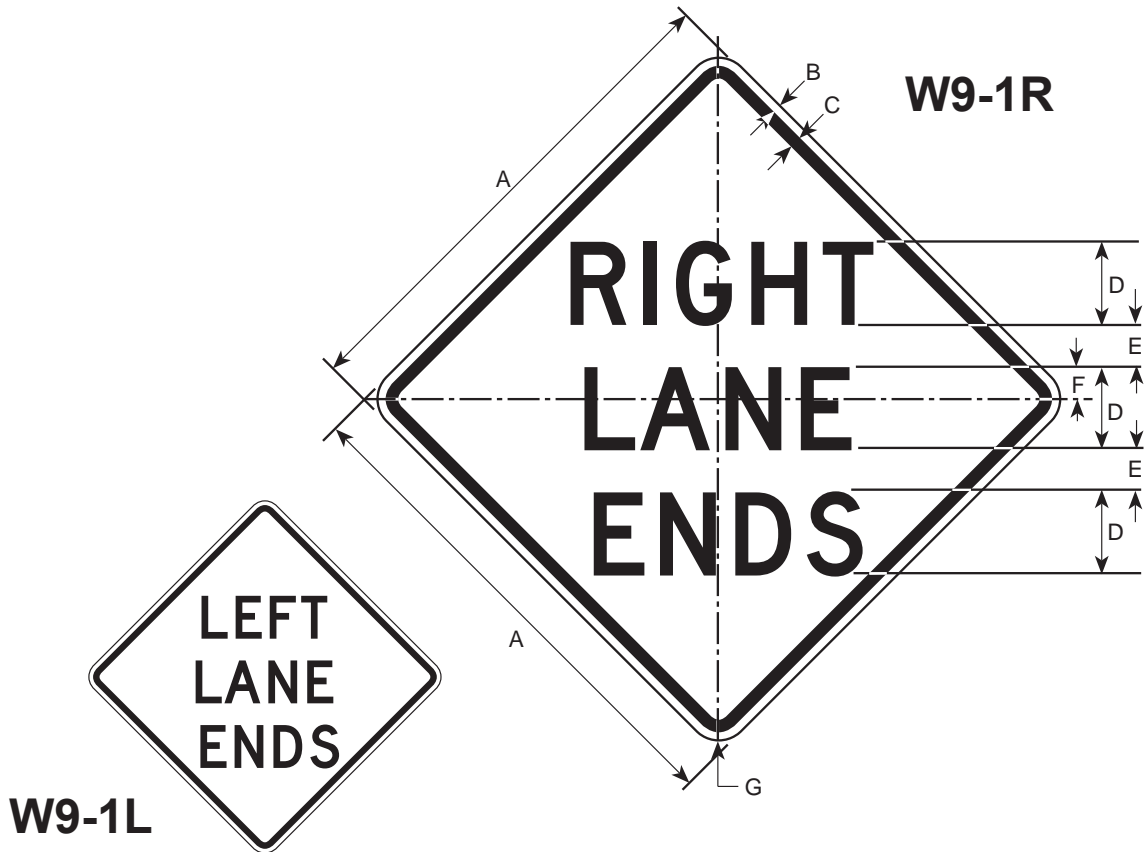

DIMENSIONS (MILLIMETERS)						
A	B	C	D	E	F	G
750	13	19	125D	63	37	47
900	16	22	150D	75	50	56
1200	19	31	200D	100	75	75

DIMENSIONS (INCHES)						
A	B	C	D	E	F	G
30	1/2	3/4	5D	2 1/2	1 1/2	1 7/8
36	5/8	7/8	6D	3	2	2 1/4
48	3/4	1 1/4	8D	4	3	3

COLORS

LEGEND - BLACK (NON-REFL.)
BACKGROUND - YELLOW (REFL.)

W9-2L & W9-2R

11/97

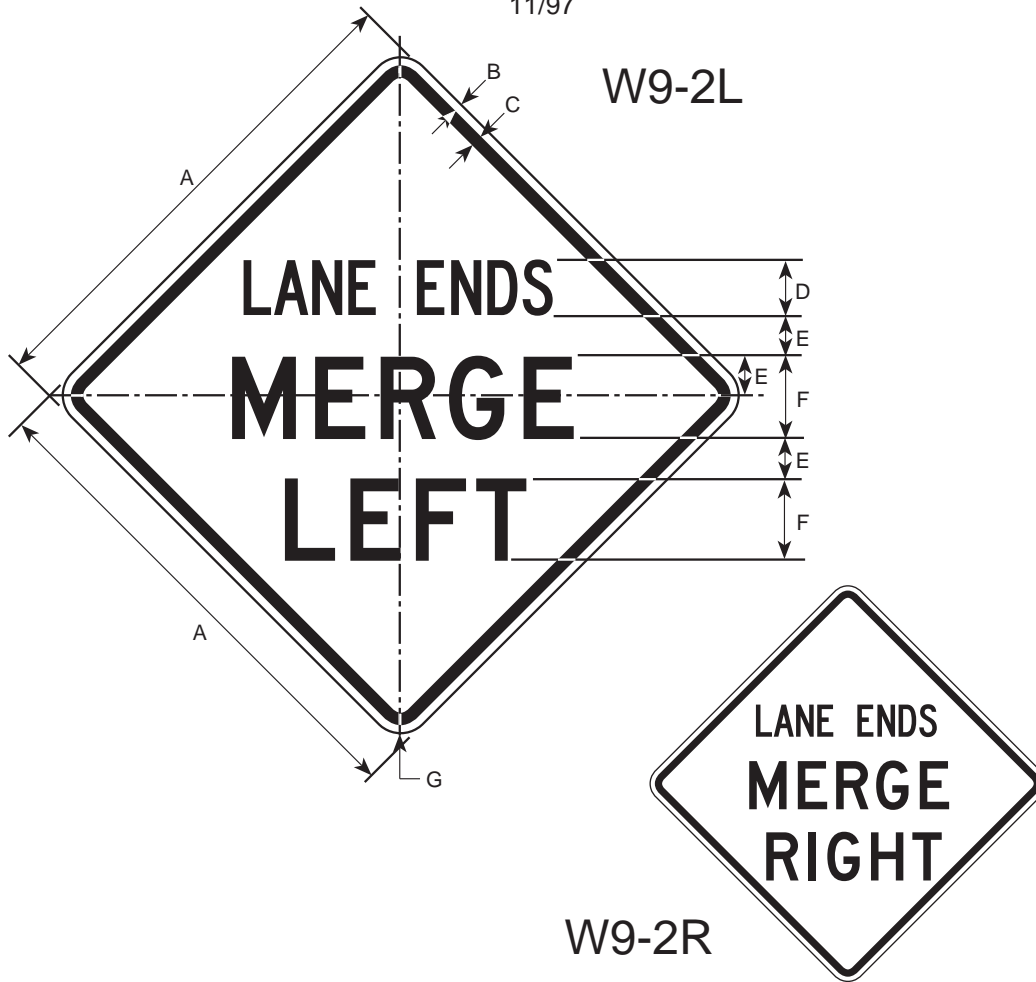

DIMENSIONS (MILLIMETERS)						
A	B	C	D	E	F	G
700	13	19	75C	63	125D	47
900	16	22	100C	75	125	56
1200	19	31	99	100	156	75

DIMENSIONS (INCHES)						
A	B	C	D	E	F	G
30	1/2	3/4	3C	2 1/2	5D	1 7/8
36	5/8	7/8	4C	3	6D	2 1/4
48	3/4	1 1/4	6C	4	8D	3

COLORS

LEGEND - BLACK (NON-REFL.)
 BACKGROUND - YELLOW (REFL.)

W10-1

4/99

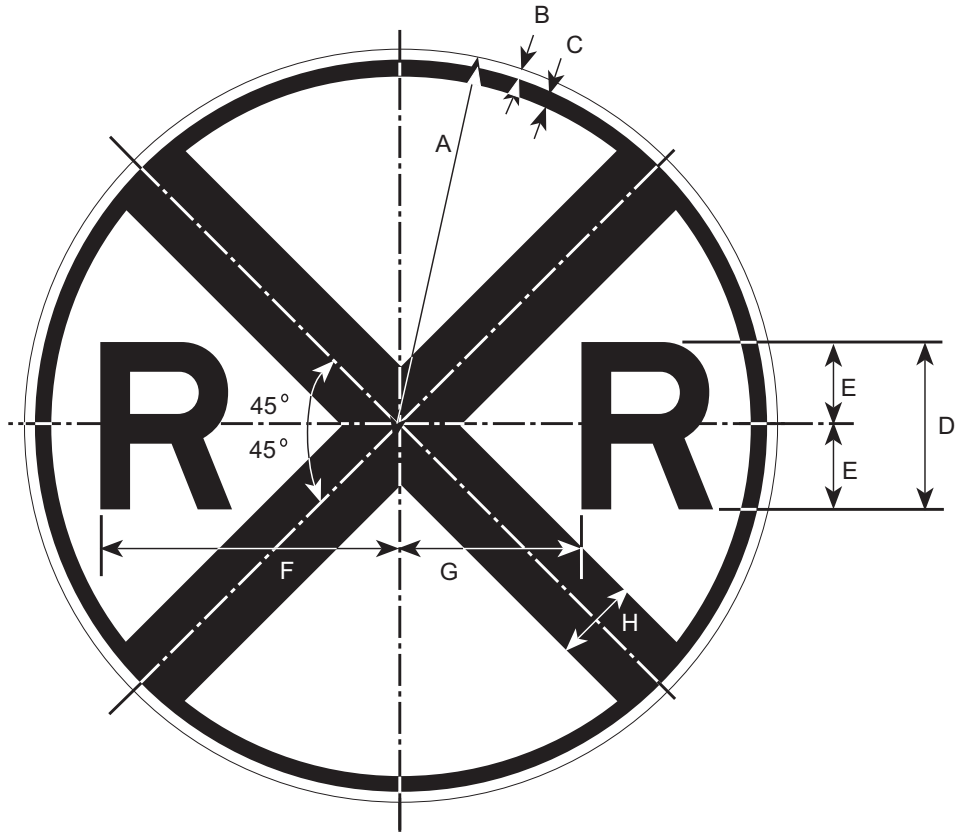

DIMENSIONS (MILLIMETERS)							
A	B	C	D	E	F	G	H
375	9	16	175E	88	309	178	75
450	13	19	200E	100	359	216	100
600	19	22	250E	125	459	297	125

DIMENSIONS (INCHES)							
A	B	C	D	E	F	G	H
15	3/8	5/8	7E	3 1/2	12 3/8	7 1/8	3
18	1/2	3/4	8E	4	14 3/8	8 5/8	4
24	3/4	1 1/4	10E	5	18 3/8	11	5

COLORS

LEGEND — BLACK (NON-REFL)
 BACKGROUND — YELLOW (REFL)

W10-1A

7/06

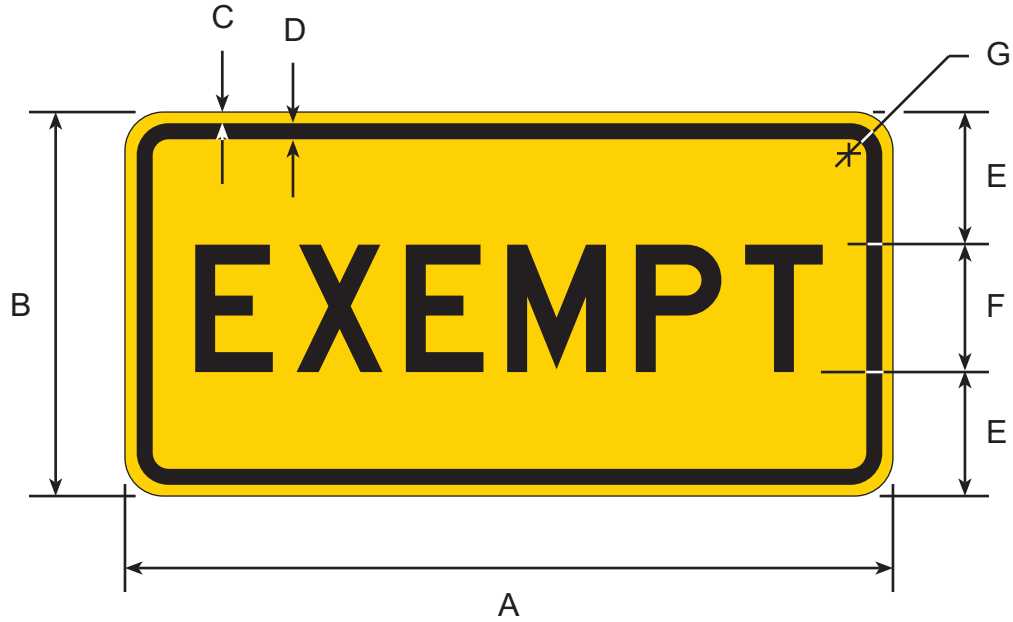

DIMENSIONS (MILLIMETERS)						
A	B	C	D	E	F	G
600	300	9	16	100	100D	38

DIMENSIONS (INCHES)						
A	B	C	D	E	F	G
24	12	3/8	5/8	4	4D	1 1/2

COLORS

LEGEND & BORDER - BLACK (NON-REFL)
BACKGROUND - YELLOW (REFL)

W10-101

11/97

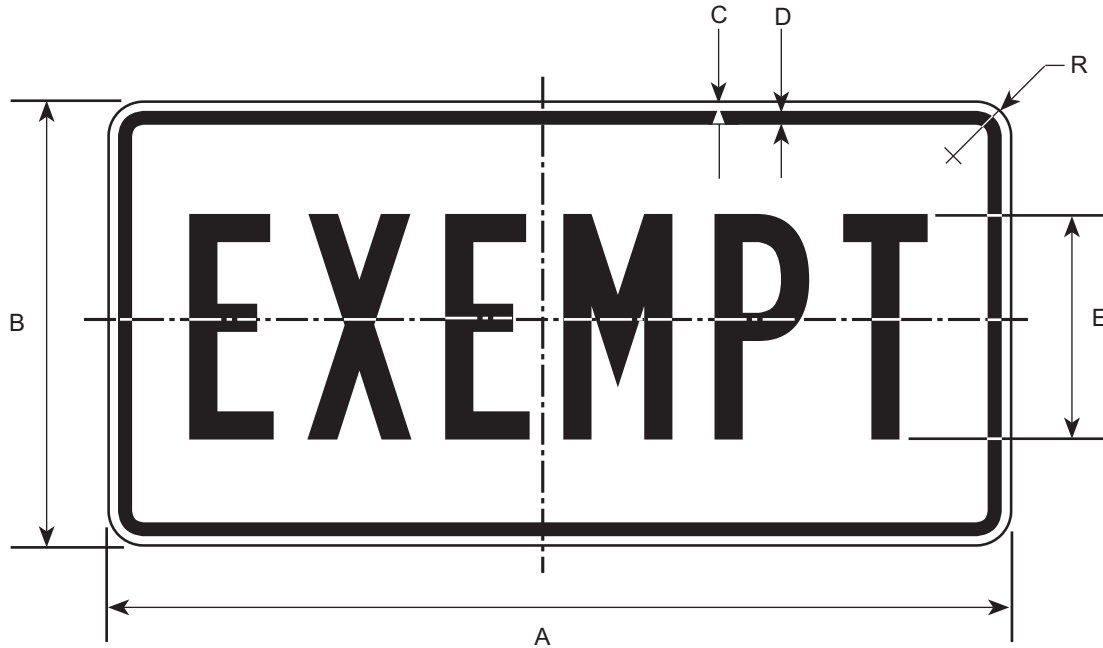

DIMENSIONS (MILLIMETERS)					
A	B	C	D	E	R
600	300	9	16	150-B	38
750	375	9	16	200-B	38

DIMENSIONS (INCHES)					
A	B	C	D	E	R
24	12	3/8	5/8	6-B	1 1/2
30	15	3/8	5/8	8-B	1 1/2

COLORS

LEGEND — BLACK (NON-REFL)
BACKGROUND — YELLOW (REFL)

W10-2

11/97

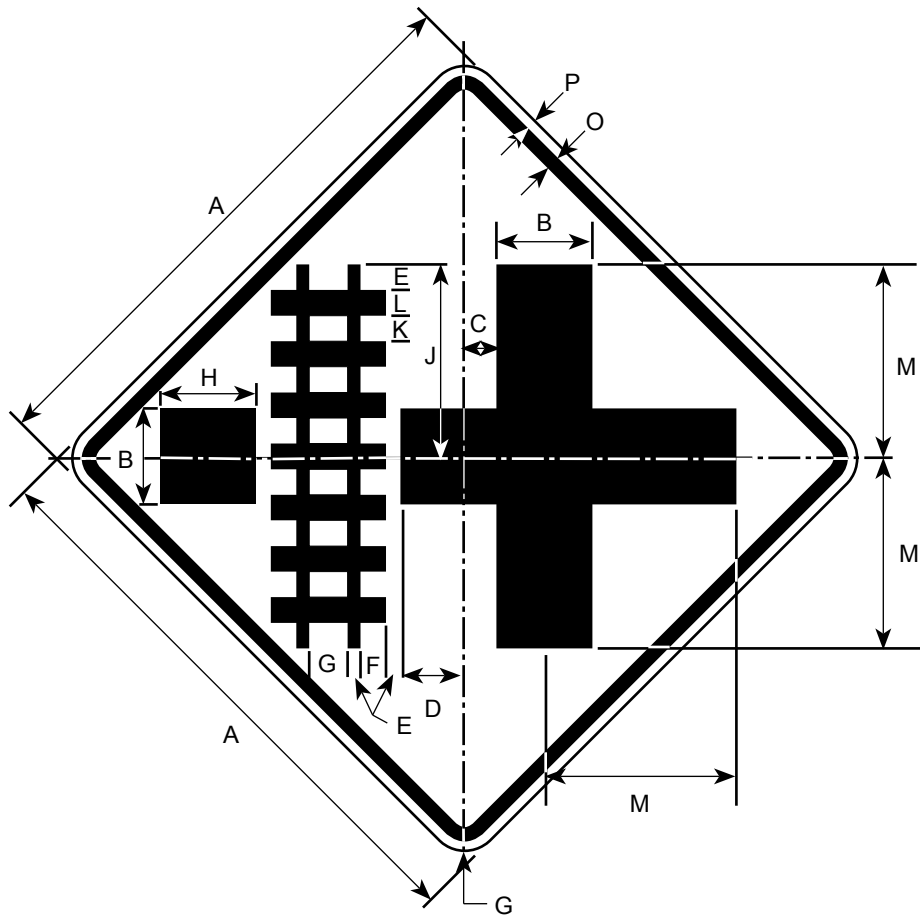

DIMENSIONS (MILLIMETERS)

A	B	C	D	E	F	G	H	J	K	L	M	O	P
750	103	88	11	16	22	47	72	209	28	31	259	19	13
900	125	106	144	19	28	56	88	252	34	38	313	22	16
1200	166	141	197	22	38	75	11	328	44	50	414	31	19

DIMENSIONS (INCHES)

A	B	C	D	E	F	G	H	J	K	L	M	O	P
30	4 1/8	3 1/2	4 3/4	5/8	7/8	1 7/8	2 7/8	8 3/8	1 1/8	1 1/4	10 3/8	3/4	1/2
36	5	4 1/4	5 3/4	3/4	1 1/8	2 1/4	3 1/2	10 1/16	1 3/8	1 1/2	12 1/2	7/8	5/8
48	6 5/8	5 5/8	7 7/8	1	1 1/2	3	4 5/8	13 1/8	1 3/4	2	16 9/16	1 1/4	3/4

COLORS

LEGEND - BLACK (NON-REFL.)
 BACKGROUND - YELLOW (REFL.)

W10-3

11/97

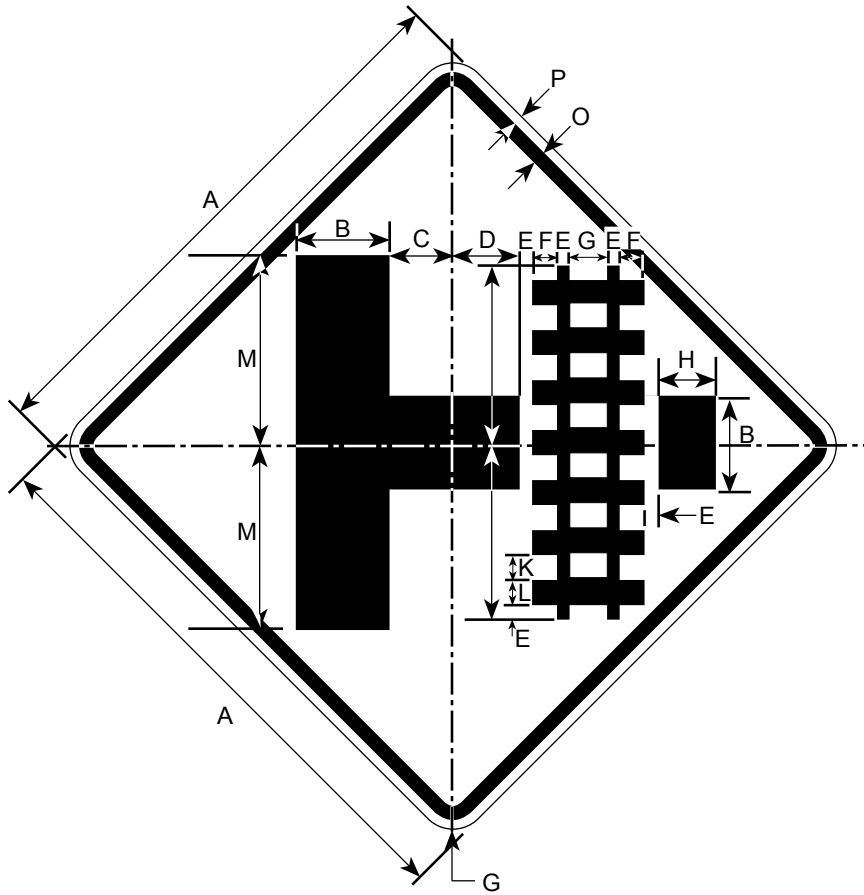

DIMENSIONS (MILLIMETERS)													
A	B	C	D	E	F	G	H	J	K	L	M	O	P
750	103	88	11	16	22	47	72	209	28	31	259	19	13
900	125	106	144	19	28	56	88	252	34	38	313	22	16
1200	166	141	197	22	38	75	11	328	44	50	414	31	19

DIMENSIONS (INCHES)													
A	B	C	D	E	F	G	H	J	K	L	M	O	P
30	4 1/8	3 1/2	4 3/4	5/8	7/8	1 7/8	2 7/8	8 3/8	1 1/8	1 1/4	10 3/8	3/4	1/2
36	5	4 1/4	5 3/4	3/4	1 1/8	2 1/4	3 1/2	10 1/16	1 3/8	1 1/2	12 1/2	7/8	5/8
48	6 5/8	5 5/8	7 7/8	1	1 1/2	3	4 5/8	13 1/8	1 3/4	2	16 9/16	1 1/4	3/4

COLORS

LEGEND - BLACK (NON-REFL.)
BACKGROUND - YELLOW (REFL.)

W10-4

11/97

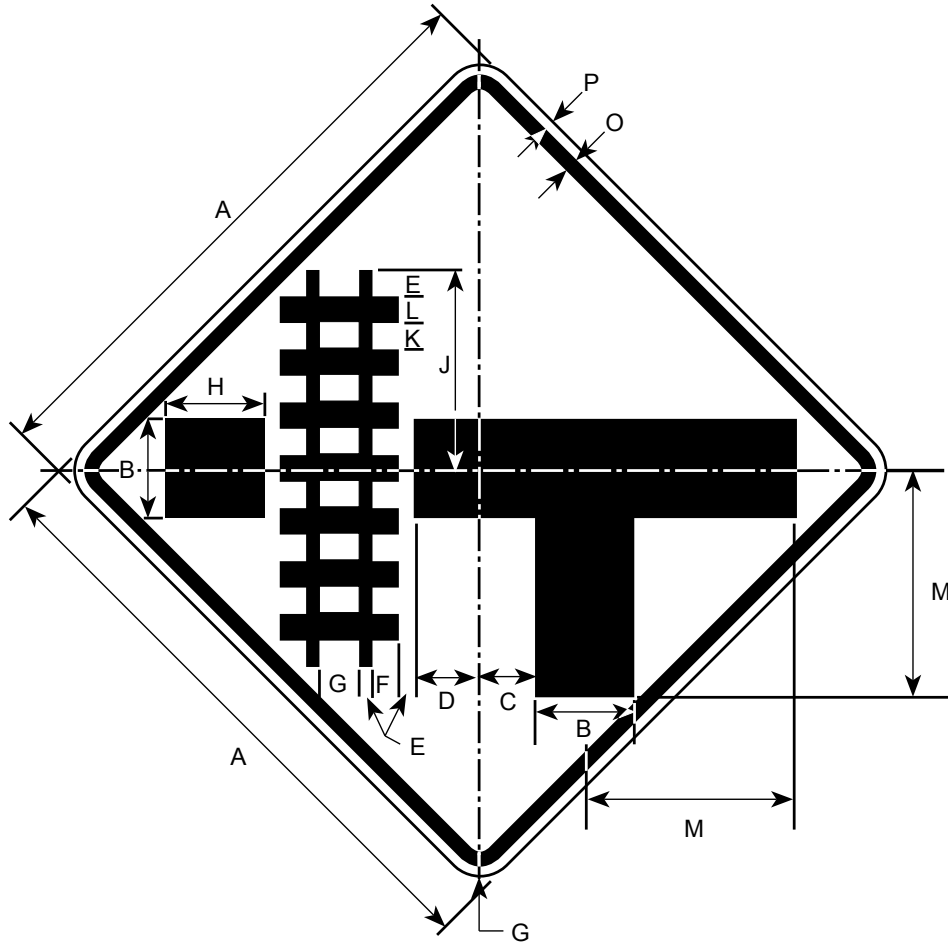

DIMENSIONS (MILLIMETERS)													
A	B	C	D	E	F	G	H	J	K	L	M	O	P
750	103	88	11	16	22	47	72	209	28	31	259	19	13
900	125	106	144	19	28	56	88	252	34	38	313	22	16
1200	166	141	197	22	38	75	11	328	44	50	414	31	19

DIMENSIONS (INCHES)													
A	B	C	D	E	F	G	H	J	K	L	M	O	P
30	4 1/8	3 1/2	4 3/4	5/8	7/8	1 7/8	2 7/8	8 3/8	1 1/8	1 1/4	10 3/8	3/4	1/2
36	5	4 1/4	5 3/4	3/4	1 1/8	2 1/4	3 1/2	10 1/16	1 3/8	1 1/2	12 1/2	7/8	5/8
48	6 5/8	5 5/8	7 7/8	1	1 1/2	3	4 5/8	13 1/8	1 3/4	2	16 9/16	1 1/4	3/4

COLORS

LEGEND - BLACK (NON-REFL.)

BACKGROUND - YELLOW (REFL.)

W10-9

6/03



DIMENSIONS (MILLIMETERS)						
A	B	C	D	E	F	G
750	225	13	19	75	75C	47
900	225	16	22	69	88C	56

DIMENSIONS (INCHES)						
A	B	C	D	E	F	G
30	9	1/2	3/4	3	3C	1 7/8
36	9	5/8	7/8	2 3/4	3 1/2C	2 1/4

W10-10

6/03

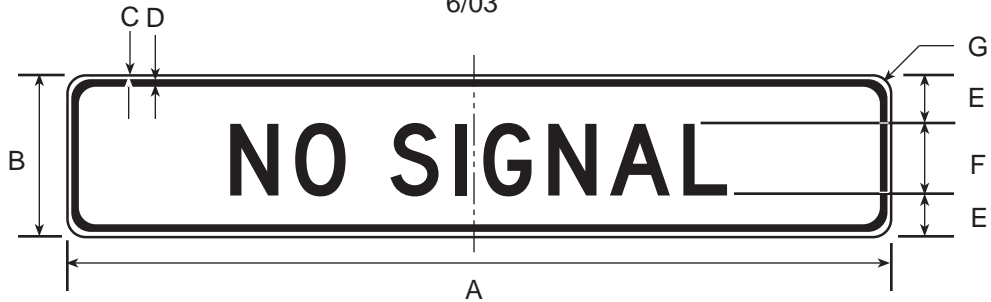

DIMENSIONS (MILLIMETERS)						
A	B	C	D	E	F	G
750	225	13	19	75	75D	47
900	225	16	22	69	88D	56

DIMENSIONS (INCHES)						
A	B	C	D	E	F	G
30	9	1/2	3/4	3	3D	1 7/8
36	9	5/8	7/8	2 3/4	3 1/2D	2 1/4

COLORS
 LEGEND - BLACK (NON-REFL)
 BACKGROUND - YELLOW (REFL)

W10-101P

11/97

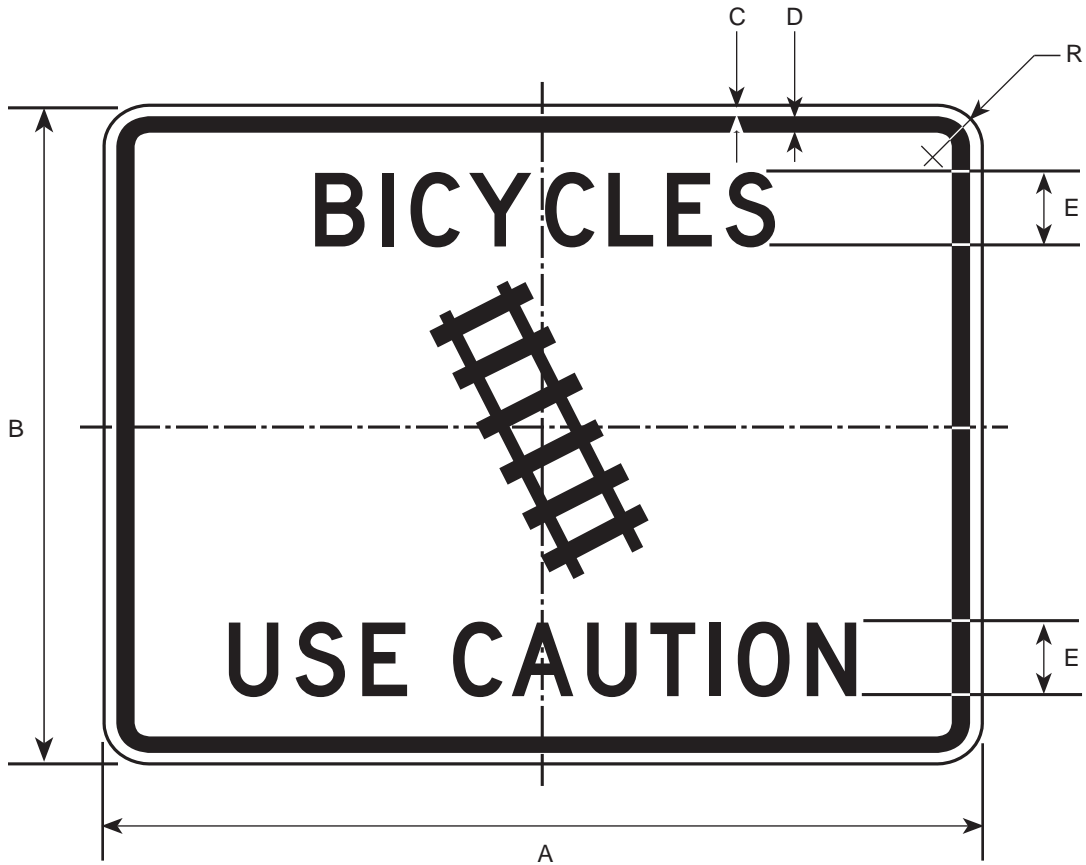

DIMENSIONS (MILLIMETERS)					
A	B	C	D	E	R
600	450	9	16	50-D	38

DIMENSIONS (INCHES)					
A	B	C	D	E	R
24	18	3/8	5/8	2-D	1 1/2

COLORS

LEGEND - BLACK (NON-REFL)
BACKGROUND - YELLOW (REFL)

W10-11A

6/03

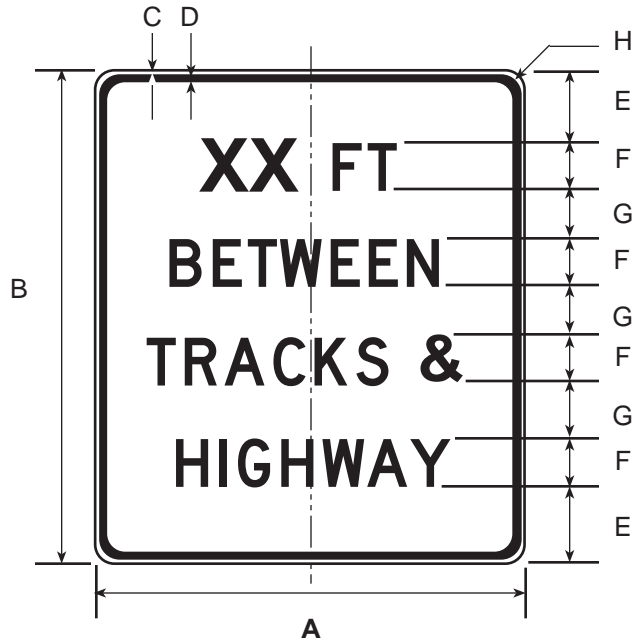

DIMENSIONS (MILLIMETERS)							
A	B	C	D	E	F	G	H
750	900	13	19	128	100C	81	47

DIMENSIONS (INCHES)							
A	B	C	D	E	F	G	H
30	360	1/2	3/4	5 1/8	4C	3 1/4	1 7/8

COLORS
 LEGEND - BLACK (NON-REFL)
 BACKGROUND - YELLOW (REFL)

W10-12

4/06

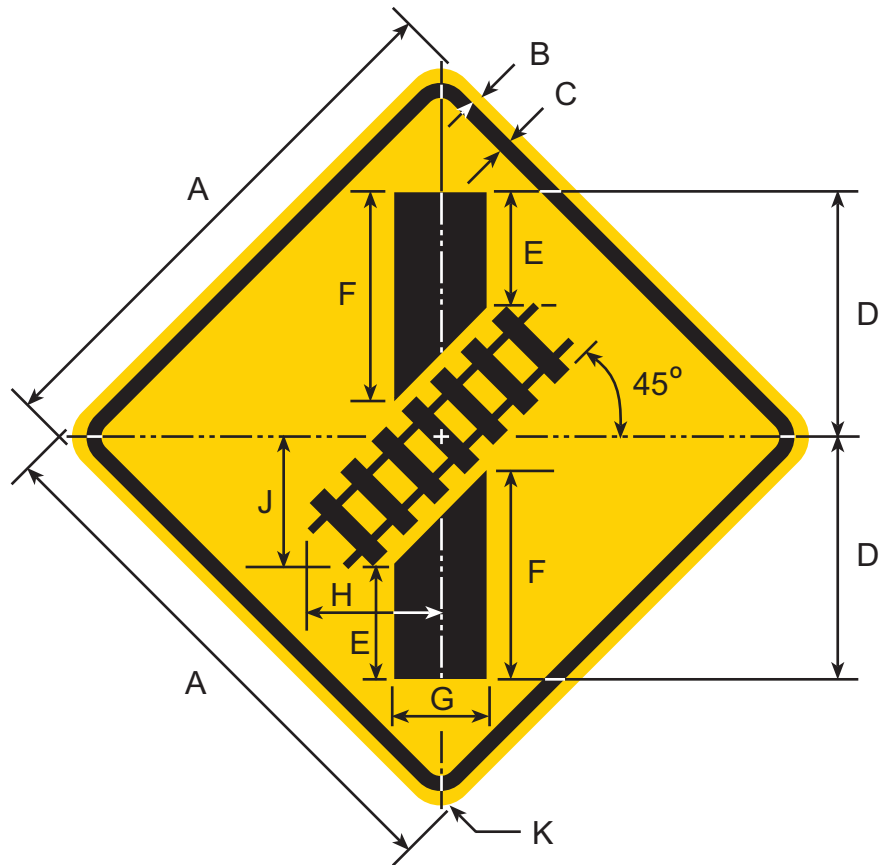

DIMENSIONS (MILLIMETERS)									
A	B	C	D	E	F	G	H	J	K
750	13	19	360	160	284	125	205	207	47
900	16	22	432	191	341	150	246	248	56
1200	19	31	577	254	454	200	328	331	75

DIMENSIONS (INCHES)									
A	B	C	D	E	F	G	H	J	K
30	1/2	3/4	14 13/32	6 3/8	11 3/8	5	8 13/64	8 9/32	1 7/8
36	5/8	7/8	17 9/32	7 41/64	13 21/32	6	9 27/32	9 59/64	2 1/4
48	3/4	1 1/4	23 1/16	10 11/64	18 11/64	8	13 1/8	13 1/4	3

COLORS

SYMBOL & BORDER - BLACK (NON-REFL)
 BACKGROUND - YELLOW (REFL)

W10-13

5/06

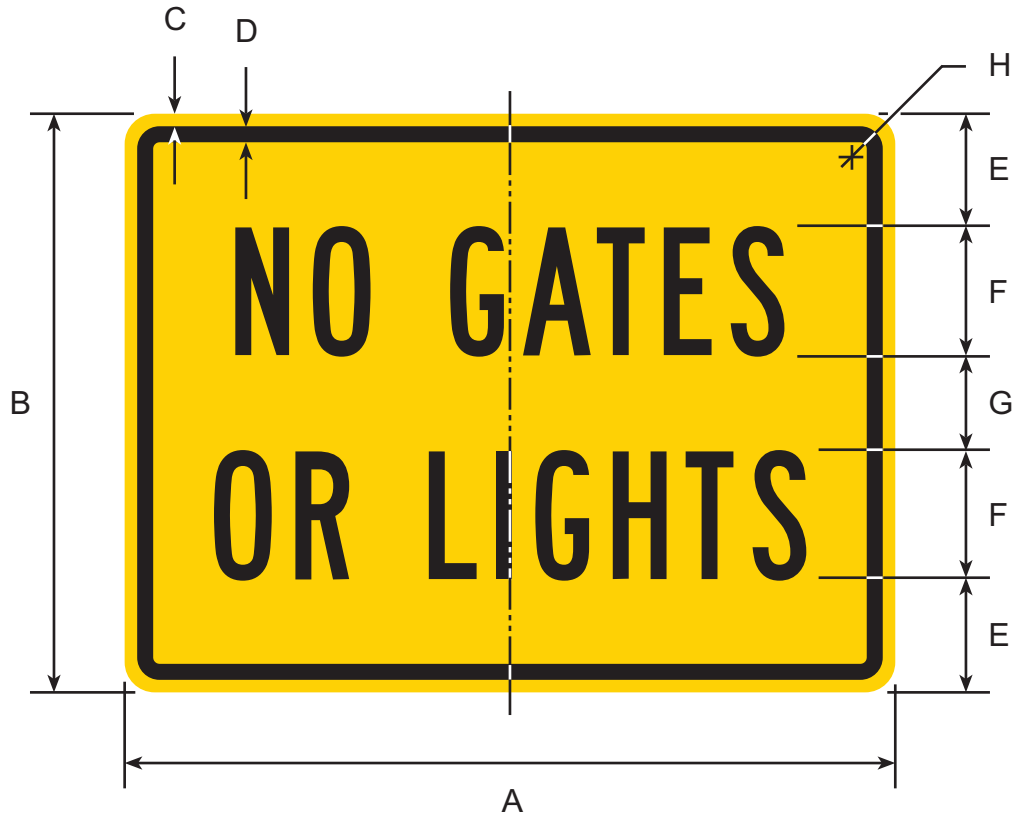

DIMENSIONS (MILLIMETERS)							
A	B	C	D	E	F	G	H
600	450	9	16	88	100B	75	38

DIMENSIONS (INCHES)							
A	B	C	D	E	F	G	H
24	18	3/8	5/8	3 1/2	4B	3	1 1/2

COLORS

LEGEND & BORDER - BLACK (NON-REFL)
 BACKGROUND - YELLOW (REFL)

W11A-301

11/97

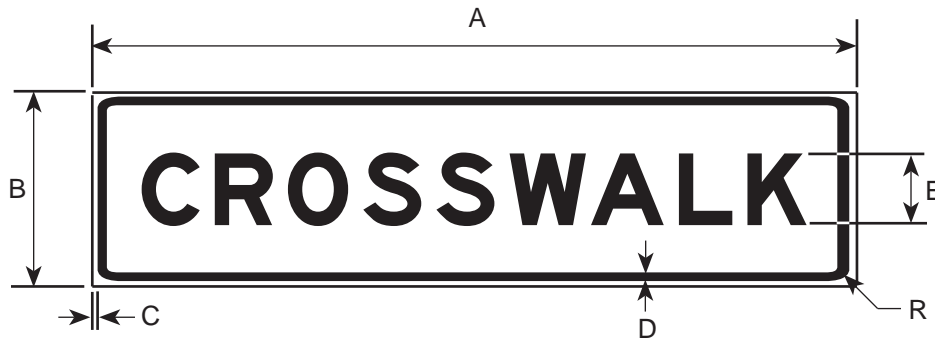

DIMENSIONS (MILLIMETERS)					
A	B	C	D	E	F
2400	600	13	19	250-E	50

DIMENSIONS (INCHES)					
A	B	C	D	E	R
96	24	1/2	3/4	10-E	2

COLORS

LEGEND - BLACK (NON-REFL.)
BACKGROUND - YELLOW (REFL.)

W11A-401

11/97



* SEE APPENDIX FOR STANDARD ARROW DETAILS

DIMENSIONS (MILLIMETERS)							
A	B	C	D	E	F	G	R
600	750	9	16	100-D	75	150 × 225	38
900	1200	16	22	150-D	125	231 × 250	56

DIMENSIONS (INCHES)							
A	B	C	D	E	F	G	R
24	30	3/8	5/8	4-D	3	6 × 9	1 1/2
36	48	5/8	7/8	6-D	5	8 1/2 × 10	1 7/8

COLORS

LEGEND - BLACK (NON-REFL.)
 BACKGROUND - YELLOW (REFL.)

W11A-501

11/97

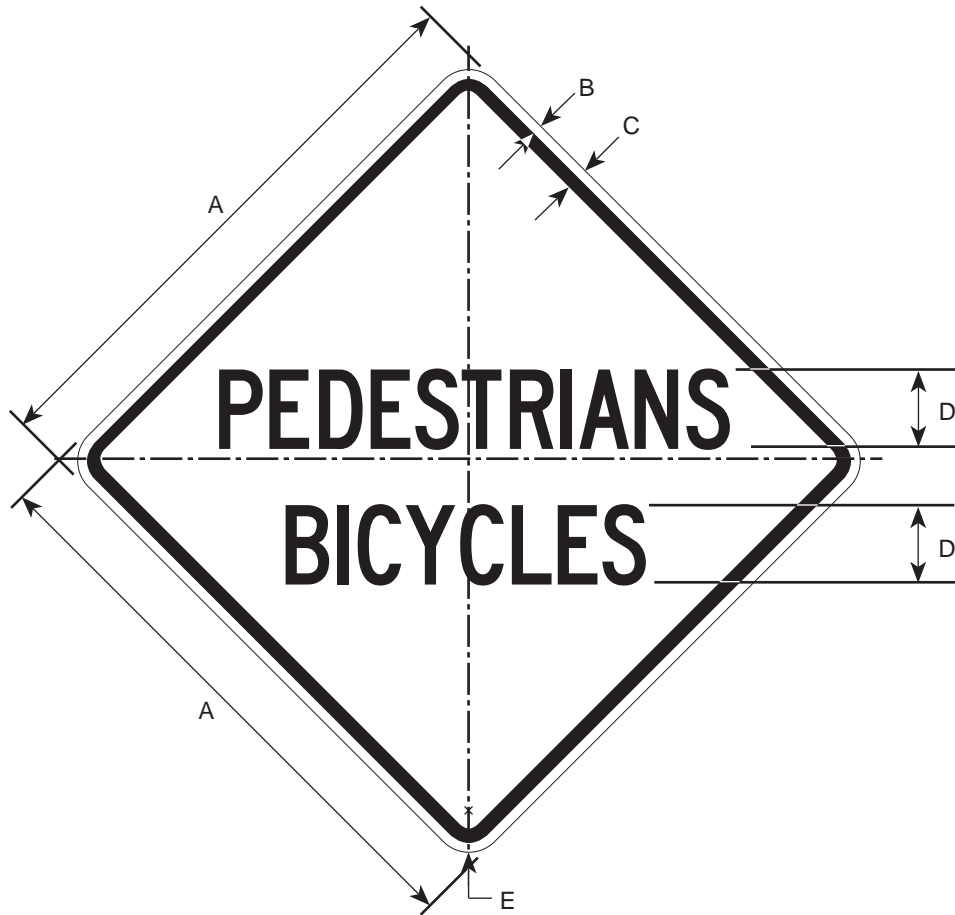

DIMENSIONS (MILLIMETERS)				
A	B	C	D	E
900	16	22	125C	56
1200	19	31	150C	75

DIMENSIONS (INCHES)				
A	B	C	D	E
36	5/8	7/8	5C	2 1/4
48	3/4	1 1/4	6C	3

COLORS

LEGEND - BLACK (NON-REFL)
 BACKGROUND - YELLOW (REFL)

W11-1

11/97

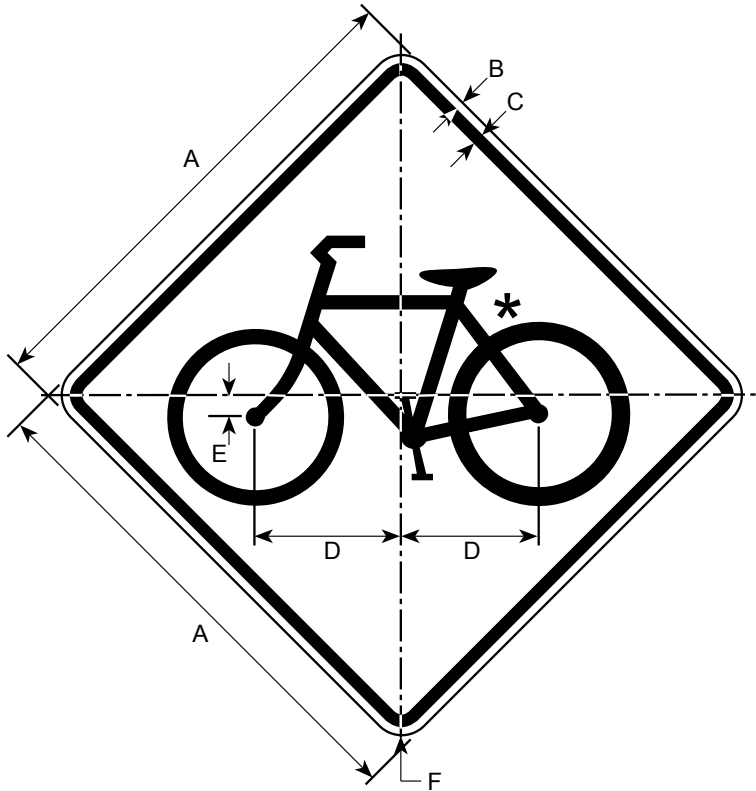

* SEE APPENDIX FOR SYMBOL DESIGN

DIMENSIONS (MILLIMETERS)

A	B	C	D	E	F
600	9	16	167	21	38
750	13	19	213	25	47
900	16	22	250	46	56
1200	19	31	334	41	75

DIMENSIONS (INCHES)

A	B	C	D	E	F
24	3/8	5/8	6	13/16	1 1/2
30	1/2	3/4	8 1/2	1	1 7/8
36	5/8	7/8	10	1 3/16	2 1/4
48	3/4	1 1/4	13 3/8	1 5/8	3

COLORS

LEGEND - BLACK (NON-REFL.)
BACKGROUND - YELLOW (REFL.)

W11-2

11/97

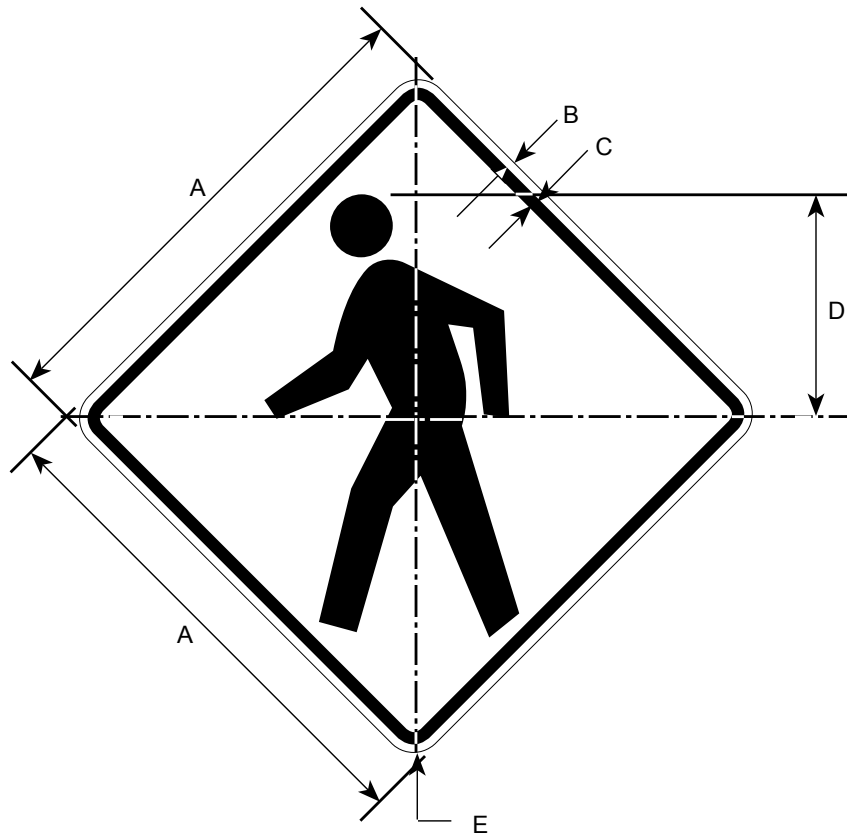

* SEE APPENDIX FOR SYMBOL DESIGN

DIMENSIONS (MILLIMETERS)				
A	B	C	D	E
600	9	16	275	38
750	13	19	338	47
900	16	22	400	56
1200	19	31	550	75

DIMENSIONS (INCHES)				
A	B	C	D	E
24	3/8	5/8	1	1 1/2
30	1/2	3/4	13 1/2	1 7/8
36	5/8	7/8	16	2 1/4
48	3/4	1 1/4	22	3

COLORS

LEGEND - BLACK (NON-REFL.)
BACKGROUND - YELLOW (REFL.)

W11-3

11/97

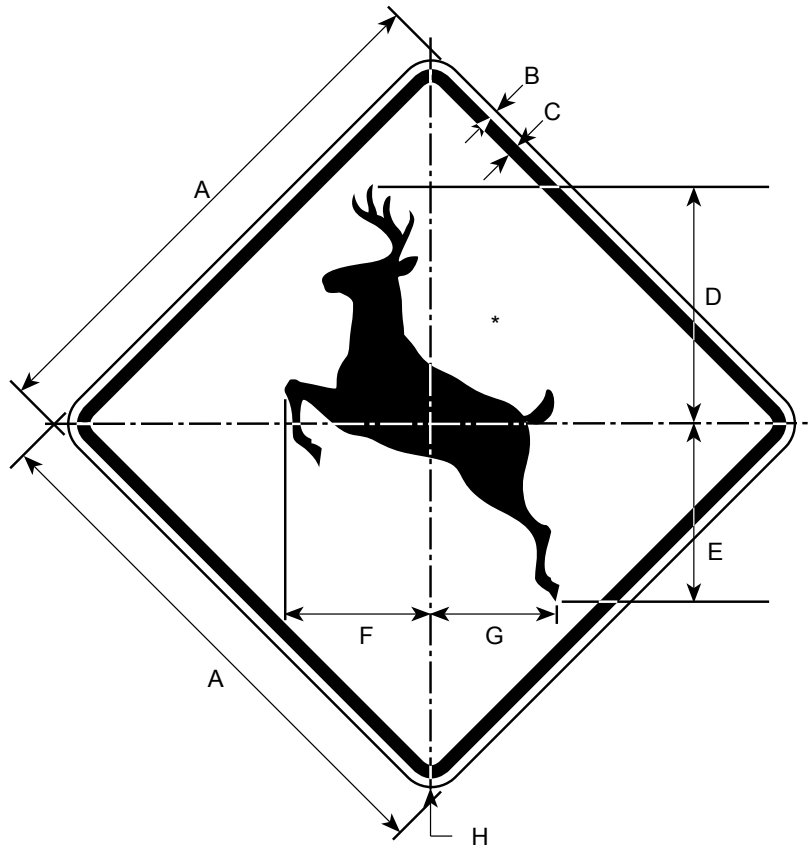

* SEE APPENDIX FOR SYMBOL DESIGN

DIMENSIONS (MILLIMETERS)							
A	B	C	D	E	F	G	H
600	9	16	266	197	163	147	38
750	13	19	338	250	206	188	47
900	16	22	406	300	247	225	56
1200	19	31	531	394	325	294	75

DIMENSIONS (INCHES)							
A	B	C	D	E	F	G	H
24	3/8	5/8	10 5/8	7 7/8	6 1/2	5 7/8	1 1/2
30	1/2	3/4	13 1/2	10	7 1/2	7 1/2	1 7/8
36	5/8	7/8	16 1/4	12	9 7/8	9	2 1/4
48	3/4	1 1/4	21 1/4	15 3/4	11	11	3

COLORS

LEGEND - BLACK (NON-REFL.)

BACKGROUND - YELLOW (REFL.)

W11-4

11/97

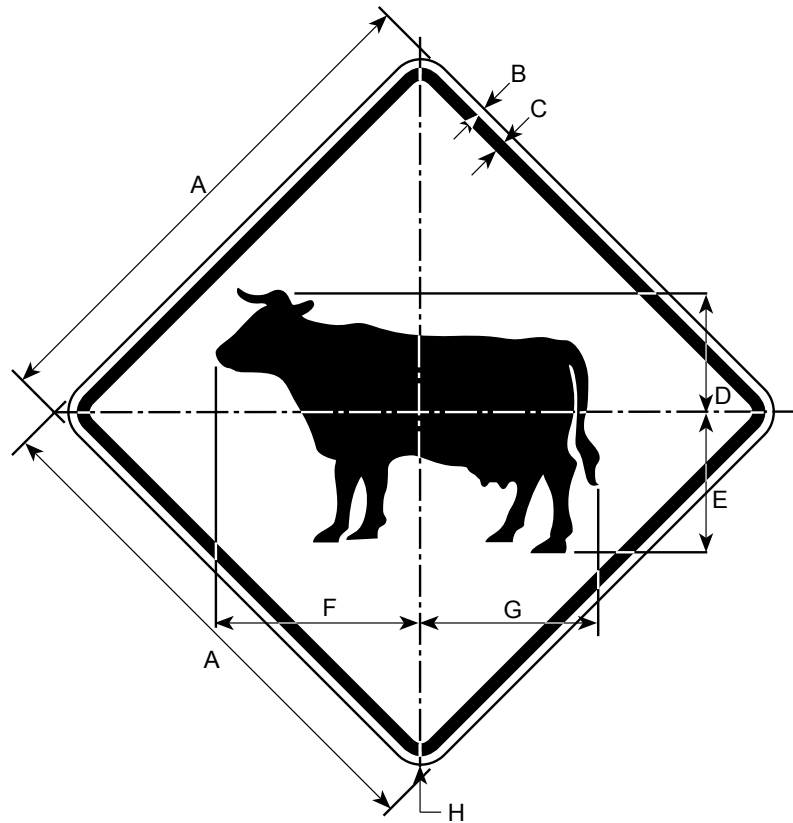

* SEE APPENDIX FOR SYMBOL DESIGN

DIMENSIONS (MILLIMETERS)							
A	B	C	D	E	F	G	H
600	9	16	122	158	231	208	38
750	13	19	150	200	294	263	47
900	16	22	181	241	353	316	56
1200	19	31	238	316	463	416	75

DIMENSIONS (INCHES)							
A	B	C	D	E	F	G	H
24	3/8	5/8	4 3/4	6 5/16	9 1/4	8 5/16	1 1/2
30	1/2	3/4	6	8	11	10 1/2	1 7/8
36	5/8	7/8	7 1/4	9 5/8	14 1/8	12 5/8	2 1/4
48	3/4	1 1/4	9 1/2	12 5/8	18 1/2	16 5/8	3

COLORS

LEGEND - BLACK (NON-REFL.)

BACKGROUND - YELLOW (REFL.)

W11-5

11/97

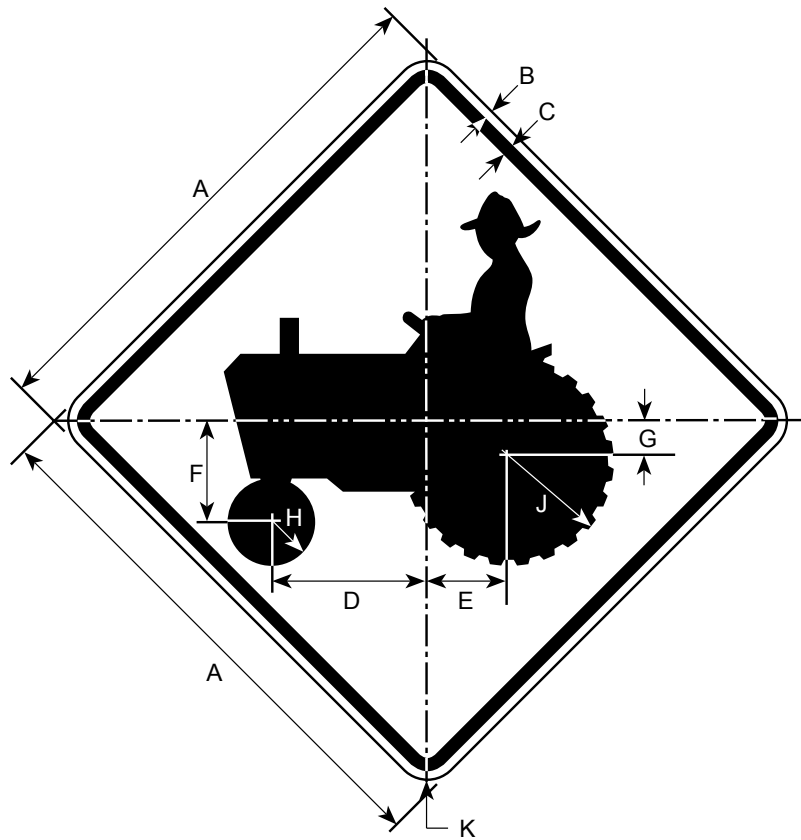

* SEE APPENDIX FOR SYMBOL DESIGN DETAILS

DIMENSIONS (MILLIMETERS)									
A	B	C	D	E	F	G	H	J	K
600	9	16	172	94	109	34	50	11	38
750	13	19	219	111	138	44	63	150	47
900	16	22	263	144	166	35	75	181	56
1200	19	31	344	188	219	69	100	238	75

DIMENSIONS (INCHES)									
A	B	C	D	E	F	G	H	J	K
18	3/8	5/8	5/8	3 3/4	4 3/8	1 3/8	2	4 3/4	1 1/2
30	1/2	3/4	3/4	4 3/4	5 1/2	1 3/4	2 1/2	6	1 7/8
36	5/8	7/8	10 1/2	5 3/4	6 5/8	2 1/8	3	7 1/4	2 1/4
48	3/4	1 1/4	13 3/4	7 1/2	8 3/4	2 3/4	4	9 1/2	3

COLORS

LEGEND - BLACK (NON-REFL.)
 BACKGROUND - YELLOW (REFL.)

W11-6

11/97

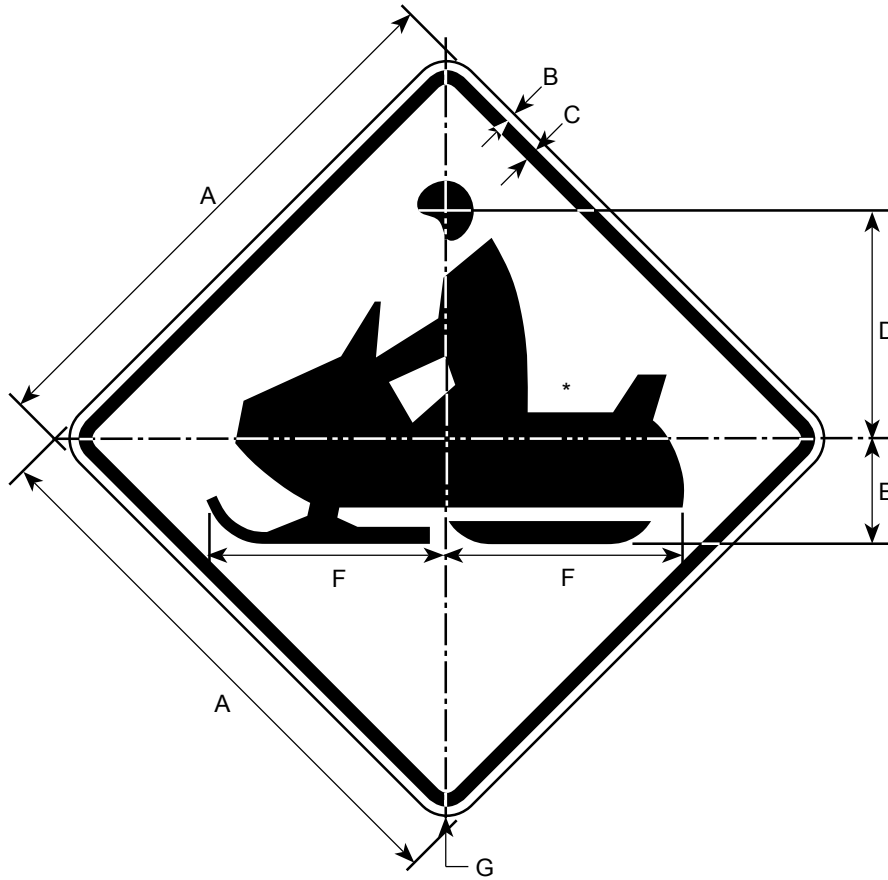

* SEE APPENDIX FOR SYMBOL DESIGN

DIMENSIONS (MILLIMETERS)						
A	B	C	D	E	F	G
600	9	16	236	11	255	38
750	13	19	286	139	317	47
900	16	22	353	172	381	56

DIMENSIONS (INCHES)						
A	B	C	D	E	F	G
24	3/8	5/8	9 7/16	4 7/16	10 3/16	1 1/2
30	1/2	3/4	11	5 9/16	12	1 7/8
36	5/8	7/8	14 1/8	6 3/4	15 1/4	2 1/4

COLORS

LEGEND - BLACK (NON-REFL.)
 BACKGROUND - YELLOW (REFL.)

W11-7

11/97

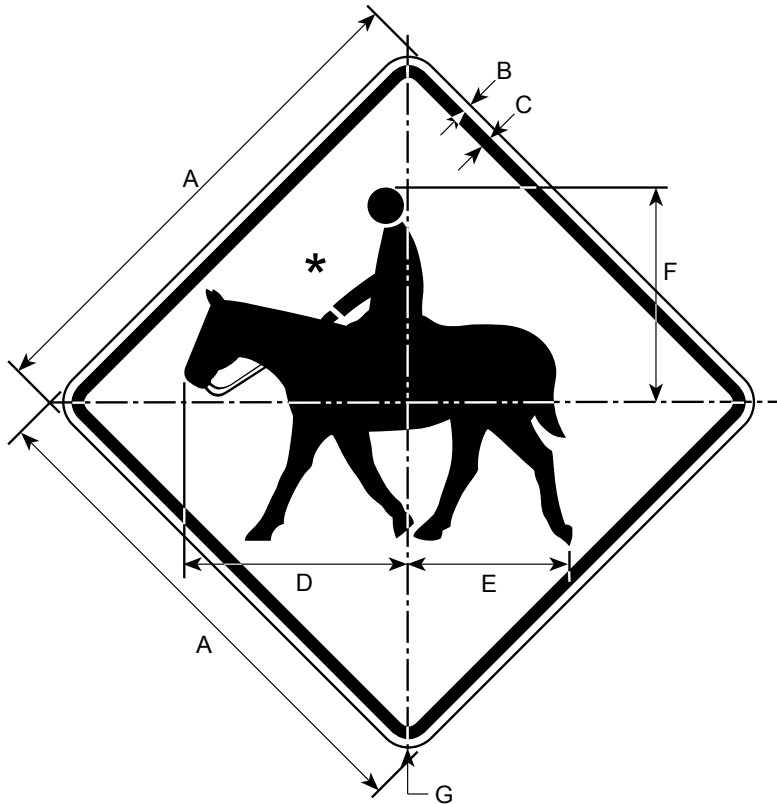

* SEE APPENDIX FOR SYMBOL DESIGN

DIMENSIONS (MILLIMETERS)						
A	B	C	D	E	F	G
600	9	16	263	200	266	38
750	13	19	325	250	325	47
900	16	22	388	300	391	56
1200	19	31	525	400	525	75

DIMENSIONS (INCHES)						
A	B	C	D	E	F	G
24	3/8	5/8	10 1/2	8	10 5/8	1 1/2
30	1/2	3/4	13	10	13	1 7/8
36	5/8	7/8	15 1/2	12	15 5/8	2 1/4
48	3/4	1 1/4	21	16	21	3

COLORS

LEGEND - BLACK (NON-REFL.)
BACKGROUND - YELLOW (REFL.)

W11-8

11/97

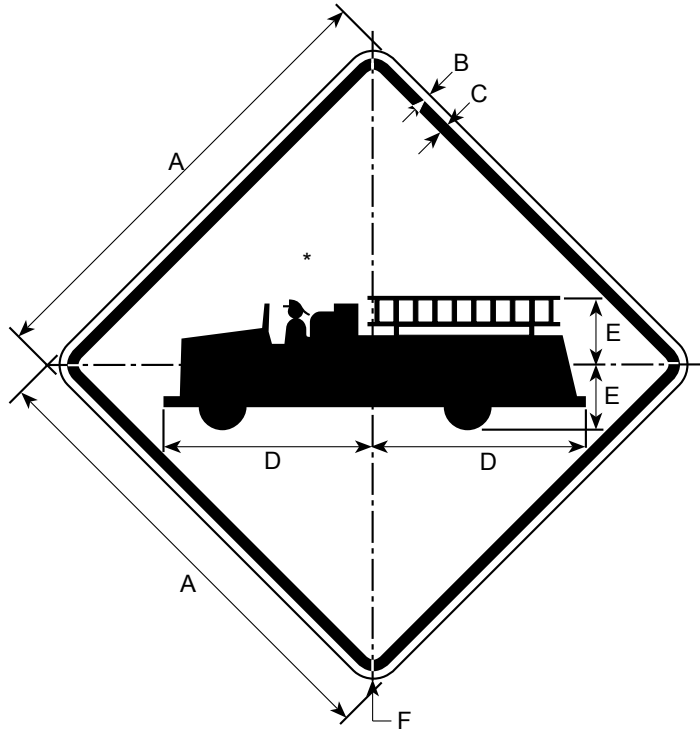

* SEE APPENDIX FOR SYMBOL DESIGN

DIMENSIONS (MILLIMETERS)					
A	B	C	D	E	F
750	13	19	344	109	47
900	16	22	413	131	56
1200	19	31	550	175	75

DIMENSIONS (INCHES)					
A	B	C	D	E	F
30	1/2	3/4	13 3/4	4 3/8	1 7/8
36	5/8	7/8	16 1/2	5 1/4	2 1/4
48	3/4	1 1/4	22	7	3

COLORS

LEGEND - BLACK (NON-REFL.)
BACKGROUND - YELLOW (REFL.)

W11-9

11/97

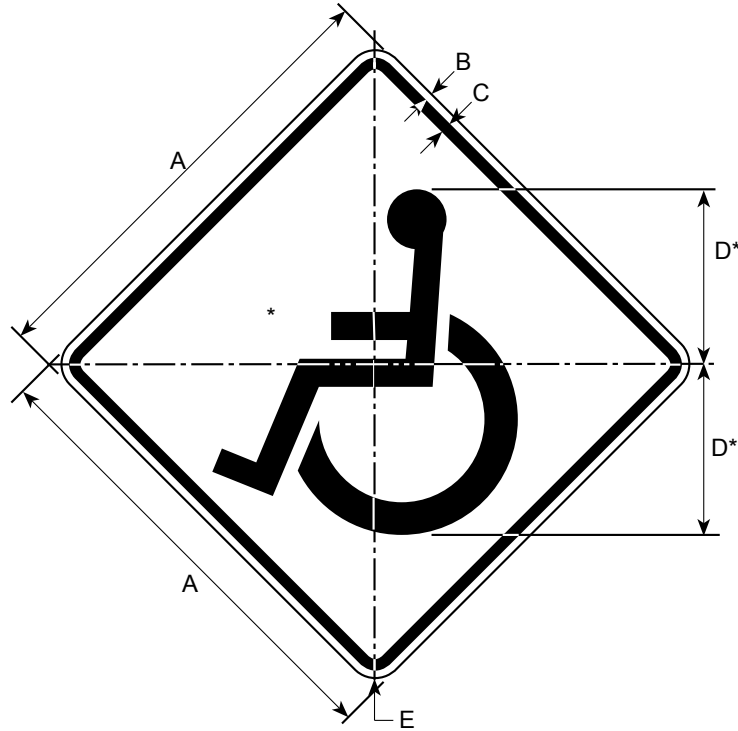

* SEE APPENDIX FOR SYMBOL DESIGN

DIMENSIONS (MILLIMETERS)				
A	B	C	D	E
750	13	19	281	47
900	16	22	338	56
1200	22	31	450	75

DIMENSIONS (INCHES)				
A	B	C	D	E
30	1/2	3/4	11	1 7/8
36	5/8	7/8	13 1/2	2 1/4
48	3/4	1 1/4	18	3

COLORS

LEGEND - BLACK (NON-REFL.)
BACKGROUND - YELLOW (REFL.)

W11-10

11/97

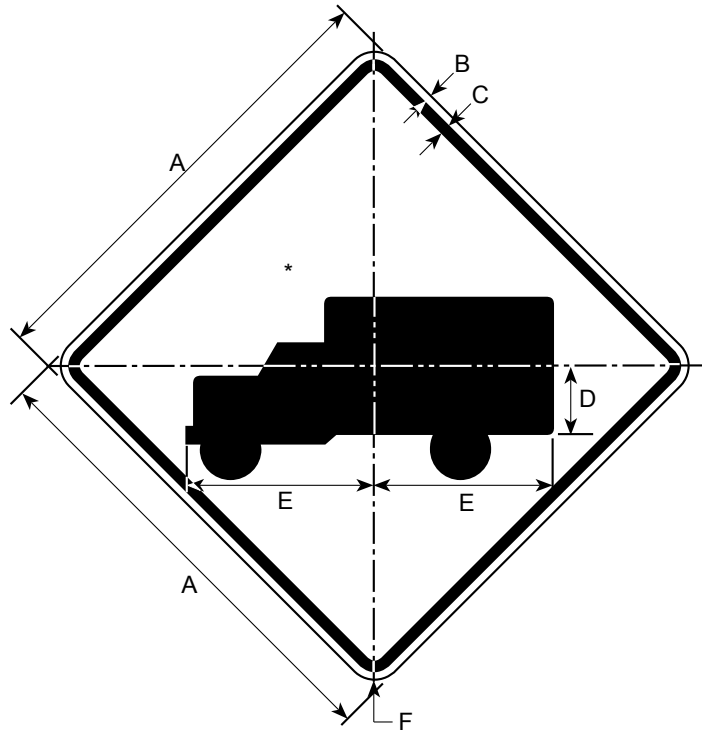

* SEE APPENDIX FOR SYMBOL DESIGN

DIMENSIONS (MILLIMETERS)					
A	B	C	D	E	F
750	13	19	225	300	47
900	16	22	250	350	56
1200	19	31	350	475	75

DIMENSIONS (INCHES)					
A	B	C	D	E	F
30	1/2	3/4	9	12	1 7/8
36	5/8	7/8	10	14	2 1/4
48	3/4	1 1/4	14	19	3

COLORS

LEGEND - BLACK (NON-REFL.)
BACKGROUND - YELLOW (REFL.)

W11-101

3/98

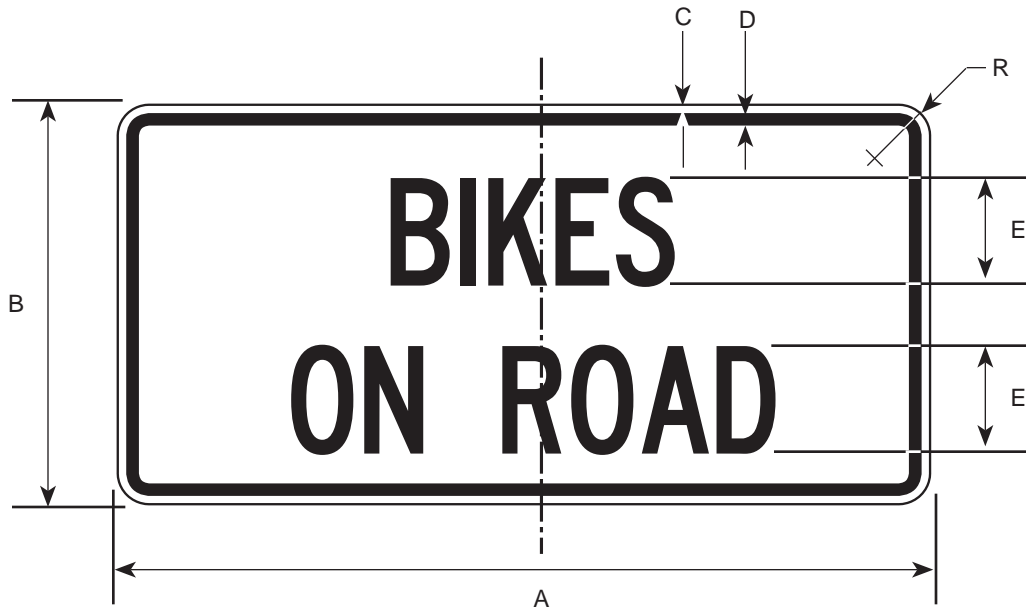

DIMENSIONS (MILLIMETERS)					
A	B	C	D	E	R
750	450	9	16	125C	38

DIMENSIONS (INCHES)					
A	B	C	D	E	R
30	18	3/8	5/8	5C	1 1/2

COLORS

LEGEND - BLACK (NON-REFL)
BACKGROUND - YELLOW (REFL)

W11-12P

9/03

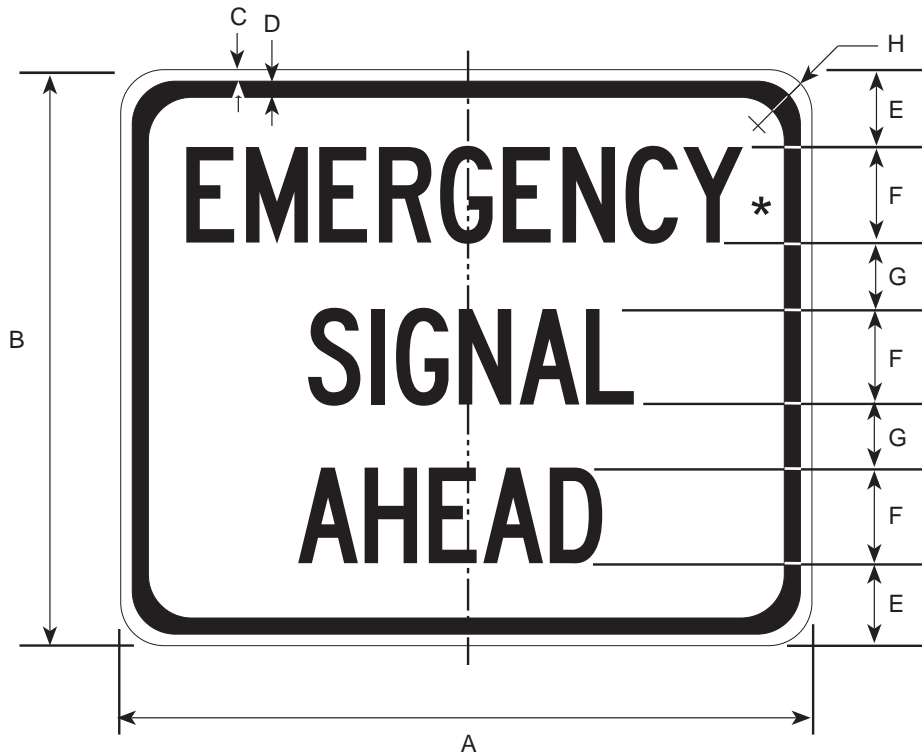

* - 30% REDUCE SPACING

DIMENSIONS (MILLIMETERS)							
A	B	C	D	E	F	G	H
600	450	9	16	75	75C	38	38
750	600	13	19	100	100C	50	47
900	750	13	19	113	5C *	75	56

DIMENSIONS (INCHES)							
A	B	C	D	E	F	G	H
24	18	3/8	5/8	3	3C	1 1/2	1 1/2
30	24	1/2	3/4	4	4C	2	1 7/8
36	30	1/2	3/4	4 1/2	5C *	3	2 1/4

COLORS

LEGEND - BLACK (NON REFL)
BACKGROUND - YELLOW (REFL)

W11-1301

11/97

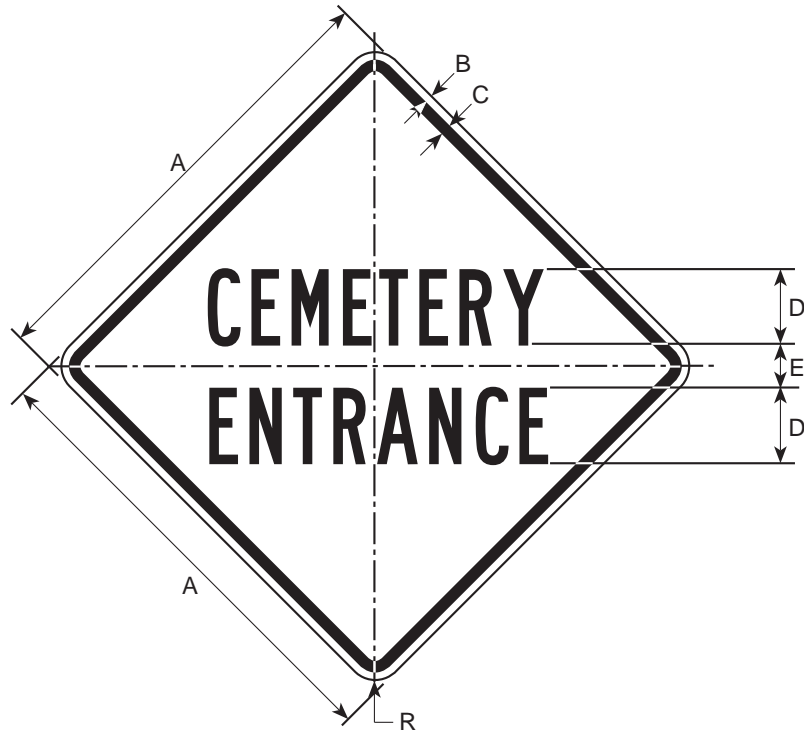

DIMENSIONS (MILLIMETERS)					
A	B	C	D	E	R
600	9	16	100-B	75	38
750	13	19	125-B	94	47
900	16	22	150-B	111	56
1200	19	31	200-B	150	75

DIMENSIONS (INCHES)					
A	B	C	D	E	R
24	3/8	5/8	4-B	3	1 1/2
30	1/2	3/4	5-B	3 3/4	1 7/8
36	5/8	7/8	6-B	4 1/2	2 1/4
48	3/4	1 1/4	8-B	6	3

COLORS

LEGEND - BLACK (NON-REFL.)
 BACKGROUND - YELLOW (REFL.)

W12-1

11/97

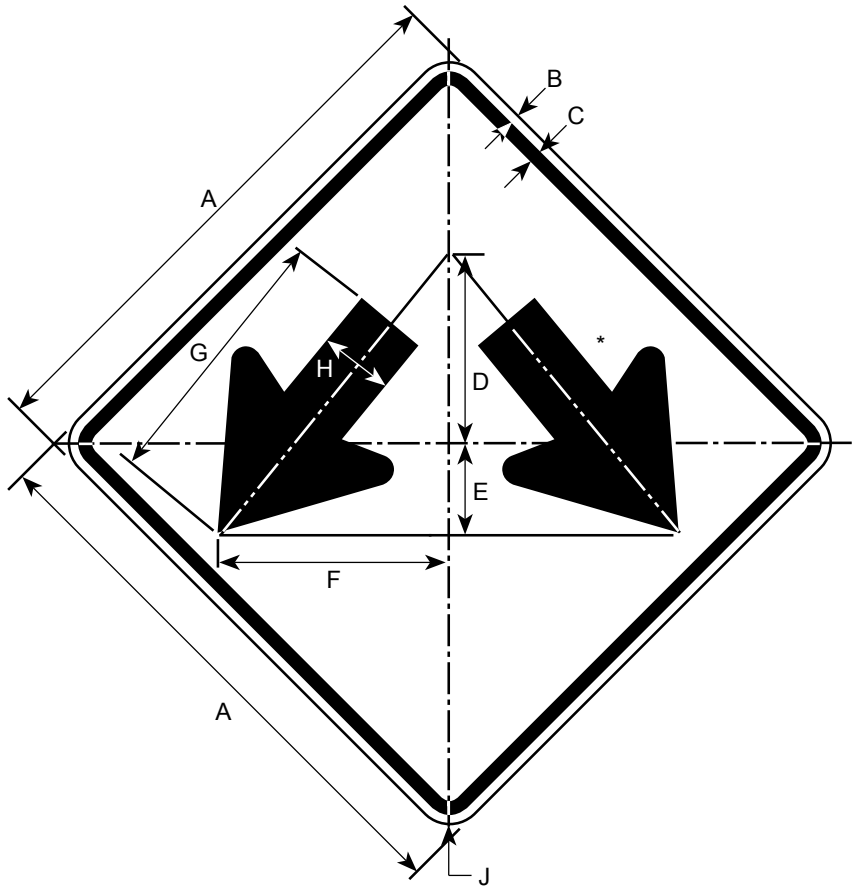

* SEE APPENDIX FOR STANDARD ARROW

DIMENSIONS (MILLIMETERS)								
A	B	C	D	E	F	G	H	J
600	9	16	200	103	225	291	78	38
750	13	19	250	131	309	367	100	47
900	16	22	300	153	366	438	111	56

DIMENSIONS (INCHES)								
A	B	C	D	E	F	G	H	J
24	3/8	5/8	8	4 1/8	9 3/4	11	3 1/8	1 1/2
30	1/2	3/4	10	5 1/4	12 3/8	14	4	1 7/8
36	5/8	7/8	12	6 1/8	14 5/8	17 1/2	4 3/4	2 1/4

COLORS

LEGEND - BLACK (NON-REFL.)
BACKGROUND - YELLOW (REFL.)

W12-2

11/97

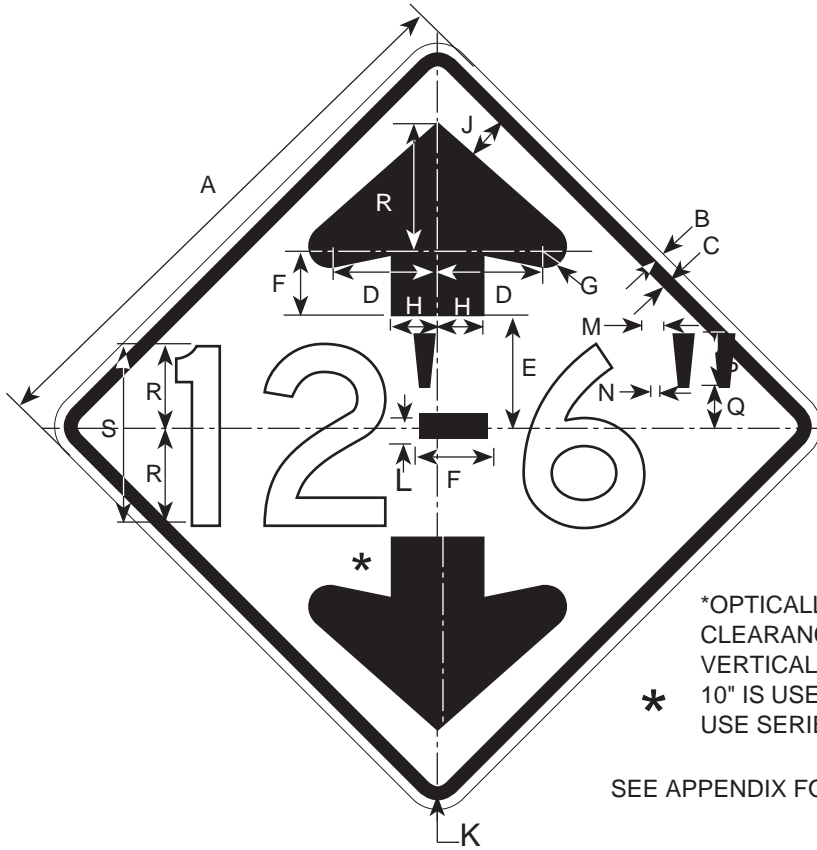

*OPTICALLY SPACE VERTICAL CLEARANCE NUMBERS ABOUT VERTICAL CENTERLINE (WHERE 10" IS USED IN VERT. CLEARANCE, USE SERIES "C" NUMERALS)

SEE APPENDIX FOR STANDARD ARROW DETAILS

DIMENSIONS (MILLIMETERS)															
A	B	C	D	E	F	G	H	K	L	M	N	P	Q	R	S
750	13	19	144	166	97	19	56	47	39	25	1	56	83	208	250D
900	16	22	172	200	11	25	75	56	47	31	13	69	100	250	300D
1200	19	31	230	266	147	33	100	75	61	41	16	91	131	328	400D

DIMENSIONS (INCHES)															
A	B	C	D	E	F	G	H	K	L	M	N	P	Q	R	S
30	1/2	3/4	5 3/4	6 5/8	3 3/4	3/4	2 1/2	1 7/8	19/16	1	7/16	2 1/4	35/16	5	10D
36	5/8	7/8	6 7/8	8	4 1/2	251	3	2 1/4	1 7/8	1 1/4	1/2	2 3/4	4	6	12D
48	3/4	1 1/4	9 3/16	10 5/8	5 7/8	15/16	4	3	27/16	1 5/8	5/8	3 5/8	5 1/2	8	16D

COLORS

LEGEND - BLACK (NON-REFL)
BACKGROUND - YELLOW (REFL)

W12-301

4/06

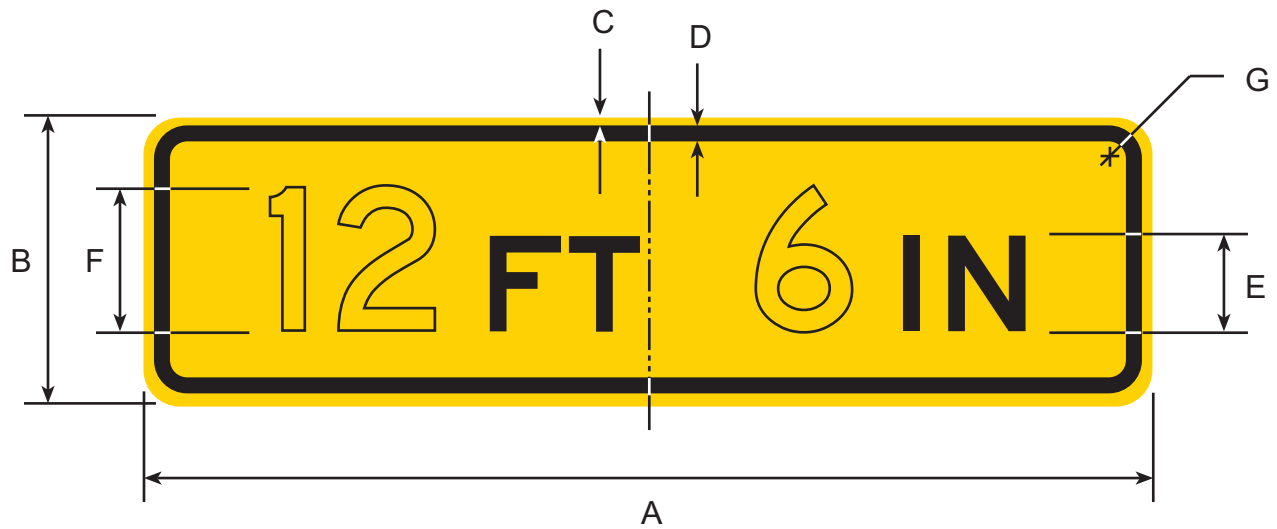

DIMENSIONS (MILLIMETERS)						
A	B	C	D	E	F	G
2100	600	19	31	200E	300E	75

DIMENSIONS (INCHES)						
A	B	C	D	E	F	G
84	24	3/4	1 1/4	8E	12E	3

COLORS

LEGEND & BORDER - BLACK (NON-REFL)
BACKGROUND - YELLOW (REFL)

W12-302 L/R

11/97

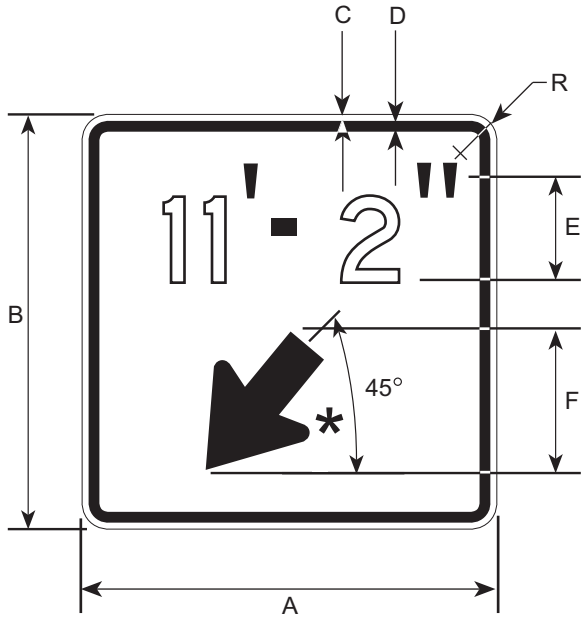

W12-302 L

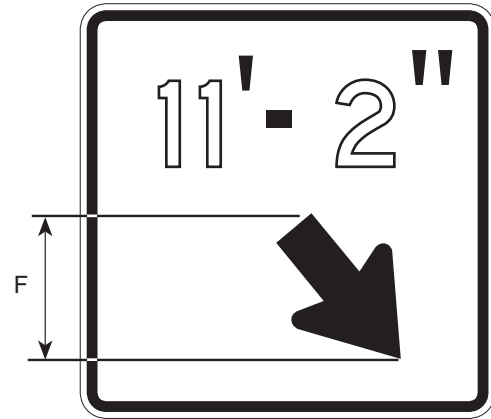

W12-302 R

* SEE APPENDIX FOR STANDARD ARROW

DIMENSIONS (MILLIMETERS)						
A	B	C	D	E	F	R
750	750	13	19	150-D	NO. 2	47
1200	1200	19	31	250-D	NO. 4	75

DIMENSIONS (INCHES)						
A	B	C	D	E	F	R
30	30	1/2	3/4	6-D	NO. 2	1 7/8
48	48	3/4	1 1/4	10-D	NO. 4	3

COLORS

LEGEND - BLACK (NON-REFL.)
 BACKGROUND - YELLOW (REFL.)

W12-401L/R

11/97

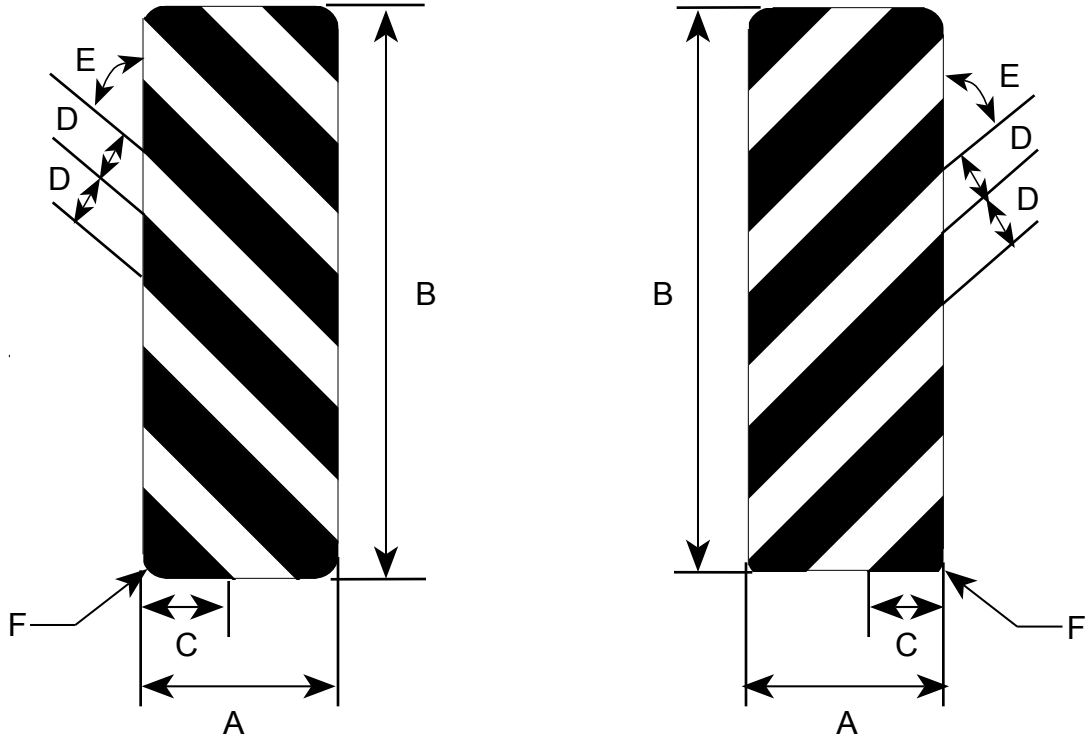

W12-401L

W12-401R

DIMENSIONS (MILLIMETERS)					
A	B	C	D	E	F
300	900	125	75	45°	16

DIMENSIONS (INCHES)					
A	B	C	D	E	F
12	36	5	3	45°	5/8

COLORS

LEGEND — BLACK (NON-REFL)
 BACKGROUND — YELLOW (REFL)

W12-501

11/97

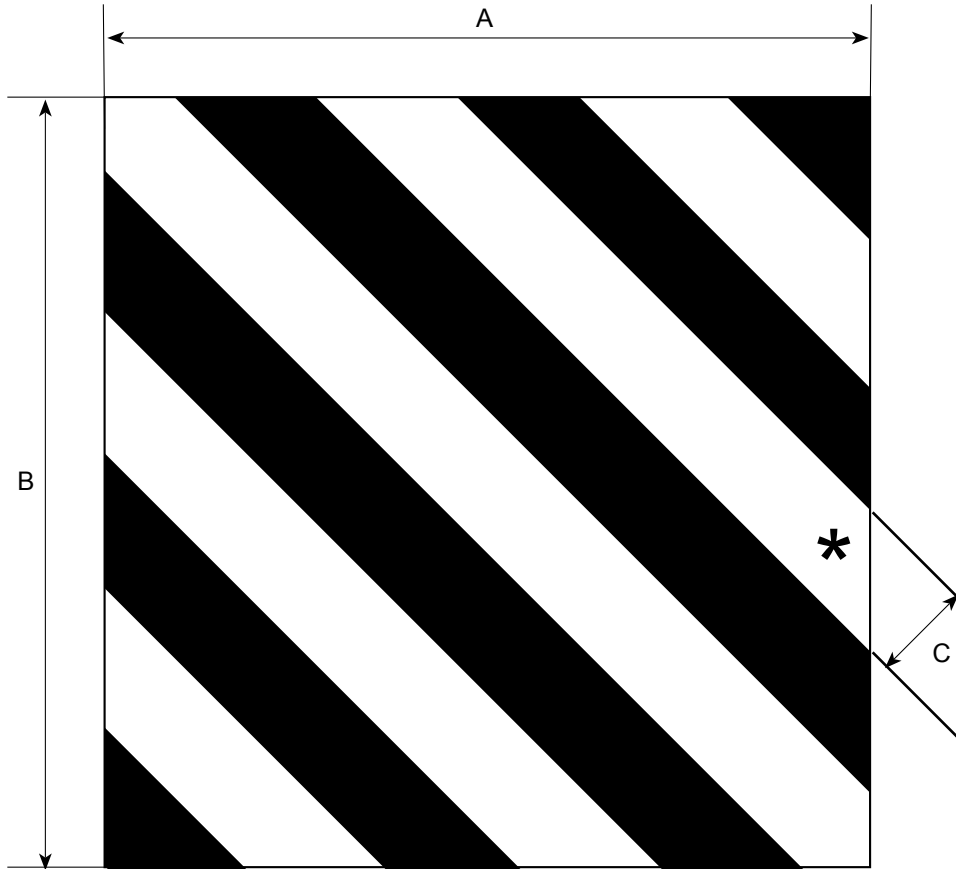

* 4"

DIMENSIONS (MILLIMETERS)		
A	B	C
75	75	10

DIMENSIONS (INCHES)		
A	B	C
30	30	4

COLOR
LEGEND— BLACK
BACKGROUND— YELLOW

W12-502

11/97

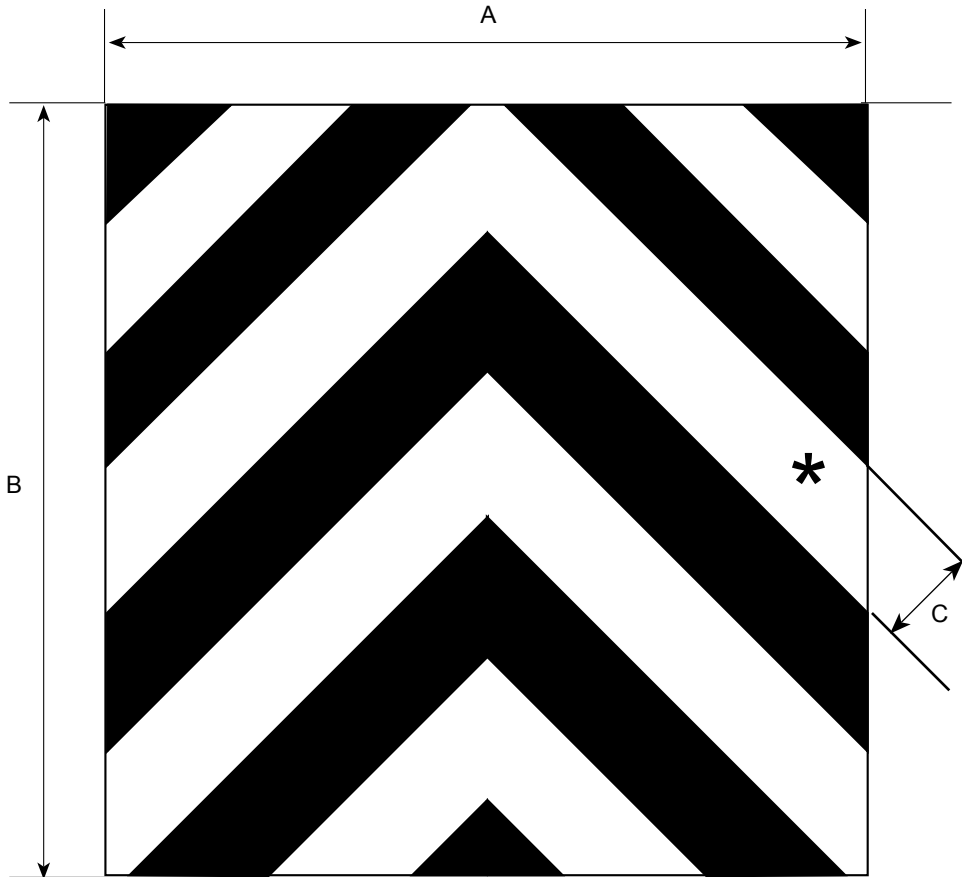

* 4" STRIPE

DIMENSIONS (MILLIMETERS)		
A	B	C
750	750	100

DIMENSIONS (INCHES)		
A	B	C
30	30	4

COLORS

LEGEND— BLACK (NON-REFL)
BACKGROUND— YELLOW (REFL)

W13-1

6/99

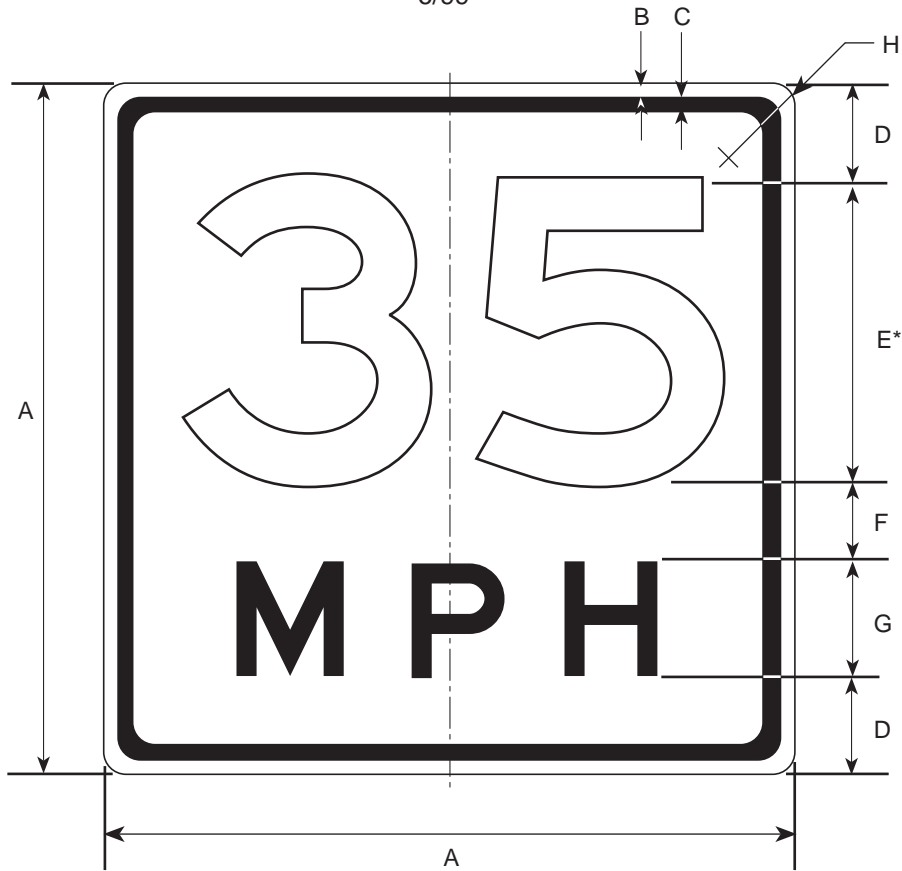

* OPTICALLY SPACE NUMBERS ABOUT VERT. CENTERLINE

DIMENSIONS (MILLIMETERS)							
A	B	C	D	E	F	G	H
450	9	9	56	200E	50	75E	38
600	9	16	91	250E	56	100E	38

DIMENSIONS (INCHES)							
A	B	C	D	E	F	G	H
18	3/8	3/8	2 1/2	8E	2	3E	1 1/2
24	3/8	5/8	3 1/2	10E	2 3/4	4E	1 1/2

COLORS

LEGEND - BLACK (NON-REFL)
BACKGROUND - YELLOW (REFL)

W13-2

11/97

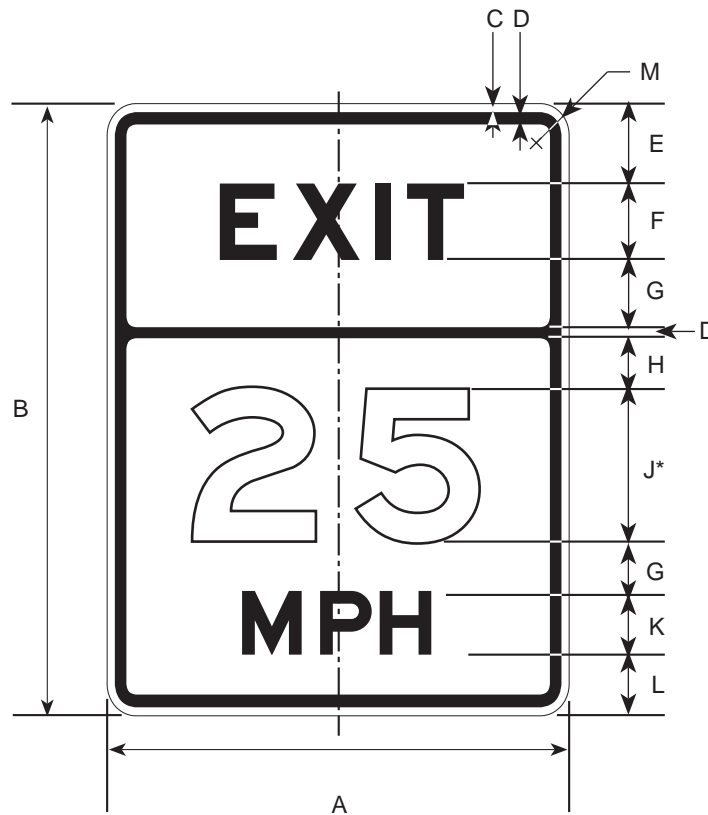

* OPTICALLY SPACE NUMERALS ABOUT VERTICAL CENTERLINE

DIMENSIONS (MILLIMETERS)											
A	B	C	D	E	F	G	H	J	K	L	M
600	750	16	16	88	100E	56	72	200E	75E	75	38
900	1200	16	22	150	150E	100	128	300E	100E	150	56
1200	1500	19	31	175	200E	125	144	400E	258	150	75

DIMENSIONS (INCHES)											
A	B	C	D	E	F	G	H	J	K	L	M
24	30	3/8	5/8	3 1/2	4E	2 1/2	2 7/8	8E	3E	3	1 1/2
36	48	5/8	7/8	6	6E	4	5 1/8	12E	4E	6	2 1/2
48	60	3/4	1 1/4	7	8E	5	5 3/4	16E	6E	6	3

COLORS

LEGEND - BLACK (NON-REFL)
BACKGROUND - YELLOW (REFL)

W13-3

11/97

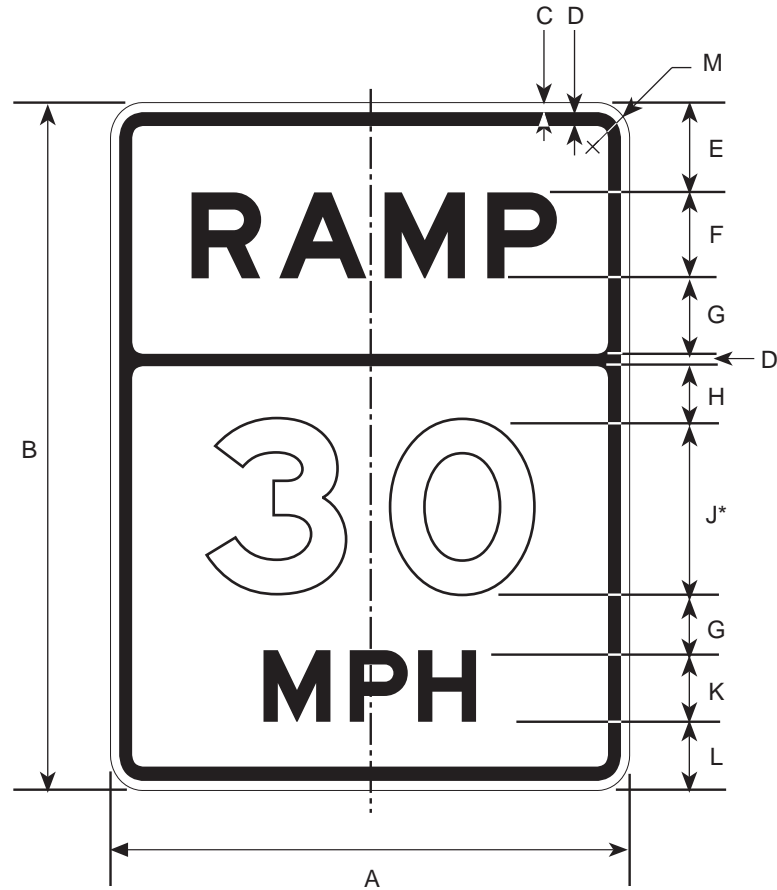

* OPTICALLY SPACE NUMERALS ABOUT VERTICAL CENTERLINE

DIMENSIONS (MILLIMETERS)											
A	B	C	D	E	F	G	H	J	K	L	M
600	750	16	16	88	100E	56	72	200E	75E	75	38
900	1200	16	22	150	150E	100	128	300E	100E	150	56
1200	1500	19	31	175	200E	125	144	400E	258	150	75

DIMENSIONS (INCHES)											
A	B	C	D	E	F	G	H	J	K	L	M
24	30	3/8	5/8	3 1/2	4E	2 1/2	2 7/8	8E	3E	3	1 1/2
36	48	5/8	7/8	6	6E	4	5 1/8	12E	4E	6	2 1/2
48	60	3/4	1 1/4	7	8E	5	5 3/4	16E	6E	6	3

COLORS

LEGEND - BLACK (NON-REFL)
BACKGROUND - YELLOW (REFL)

W13-4

6/03

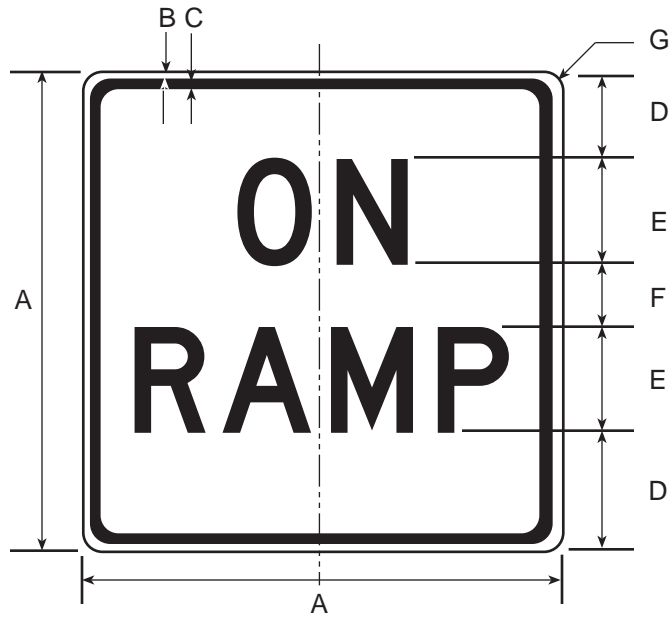

DIMENSIONS (MILLIMETERS)						
A	B	C	D	E	F	G
900	16	22	181	200D	138	56

DIMENSIONS (INCHES)						
A	B	C	D	E	F	G
36	5/8	7/8	7 1/4	8D	5 1/2	2 1/4

COLORS
 LEGEND - BLACK
 BACKGROUND - WHITE (REFL)

W13-401

11/97



DIMENSIONS (MILLIMETERS)						
A	B	C	D	E	F	R
450	300	9	9	100-E	25	38
600	450	9	16	150-E	50	38

DIMENSIONS (INCHES)						
A	B	C	D	E	F	R
18	12	3/8	3/8	4-E	1	1 1/2
24	18	3/8	5/8	6-E	2	1 1/2

COLORS

LEGEND - BLACK (NON-REFL.)
BACKGROUND - YELLOW (REFL.)

W13-501

11/97

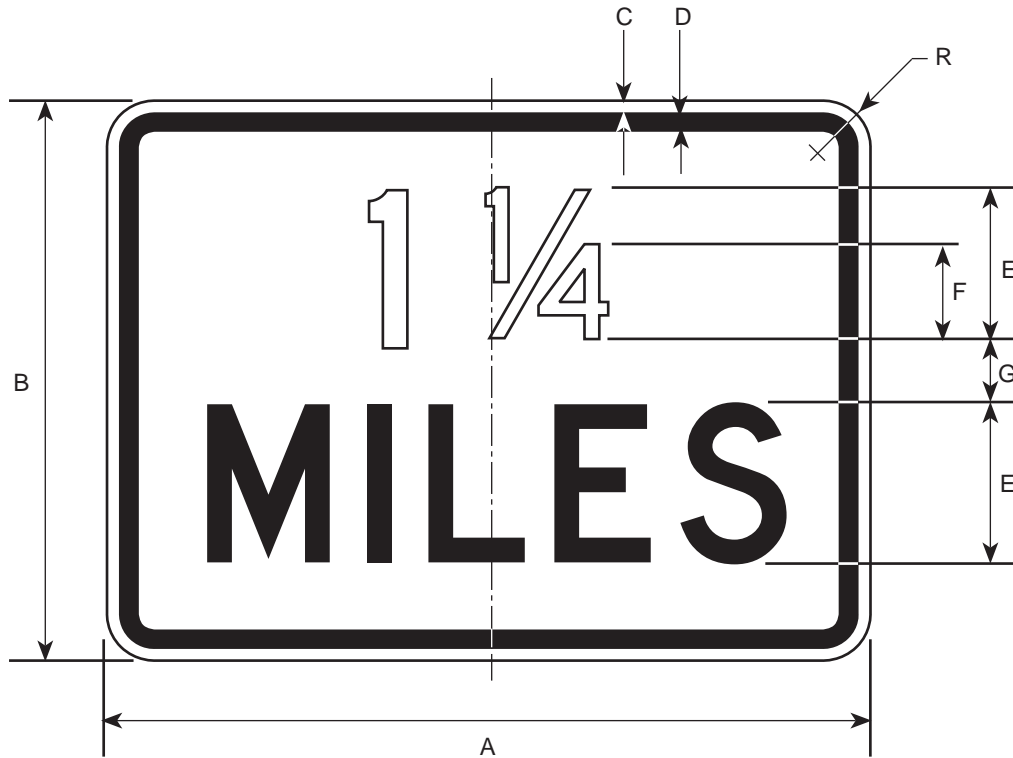

DIMENSIONS (MILLIMETERS)							
A	B	C	D	E	F	G	R
600	450	9	16	125D	100D	50	38

DIMENSIONS (INCHES)							
A	B	C	D	E	F	G	R
24	18	3/8	5/8	5D	4D	2	1 1/2

COLORS

LEGEND - BLACK (NON-REFL.)
 BACKGROUND - YELLOW (REFL.)

W14-1

11/97

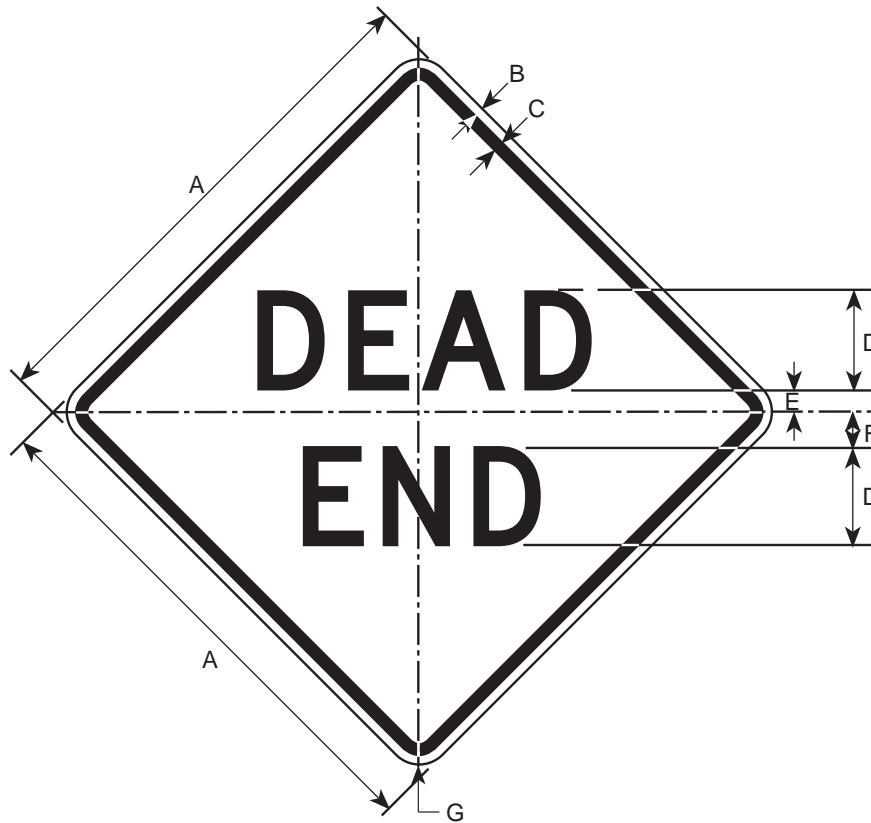

DIMENSIONS (MILLIMETERS)						
A	B	C	D	E	F	G
600	9	16	125D	25	50	38
750	13	19	150D	38	63	47
900	16	22	175D	50	75	56

DIMENSIONS (INCHES)						
A	B	C	D	E	F	G
24	3/8	5/8	5D	1	2	1 1/2
30	1/2	3/4	6D	1 1/2	2 1/2	1 7/8
36	5/8	7/8	7D	2	3	2 1/4

COLORS

LEGEND - BLACK (NON-REFL.)
 BACKGROUND - YELLOW (REFL.)

W14-1P

4/99

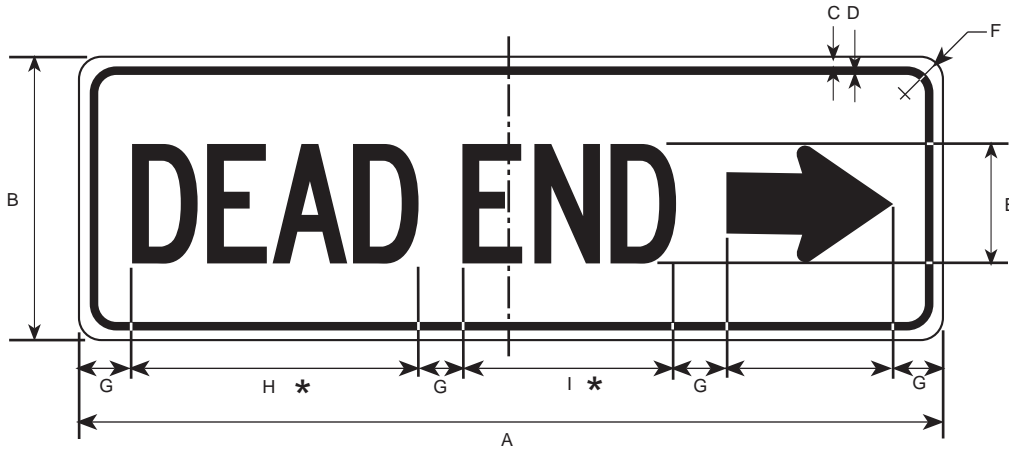

- * SEE APPENDIX FOR STANDARD ARROW DETAILS
- * SPACING HAS BEEN REDUCED TO 50%

DIMENSIONS (MILLIMETERS)									
A	B	C	D	ARROW	E	F	G	H	I
900	300	12.5	18.75	100 X 125	125C	37.5	50	325	250

DIMENSIONS (INCHES)									
A	B	C	D	ARROW	E	F	G	H	I
36	12	1/2	3/4	4 X 5	5C	1 1/2	2	13	10

COLORS

LEGEND - BLACK (NON-REFL)
 BACKGROUND - YELLOW (REFL)

W14-2

11/97

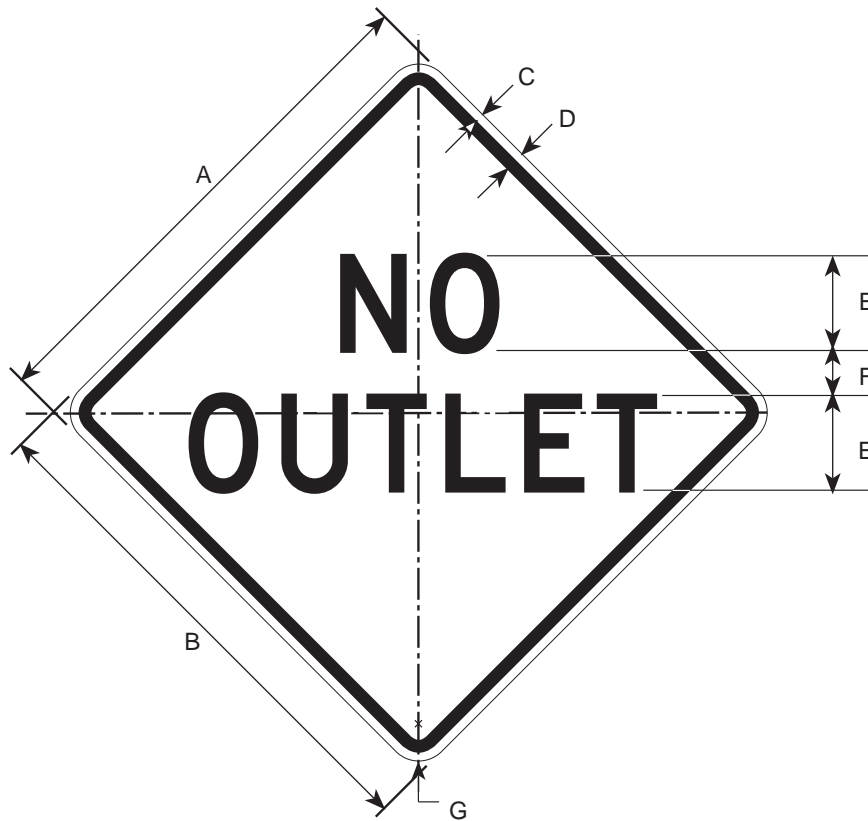

DIMENSIONS (MILLIMETERS)						
A	B	C	D	E	F	G
600	600	9	16	125D	25	38
750	750	13	19	150D	38	47
900	900	16	22	175D	50	56

DIMENSIONS (INCHES)						
A	B	C	D	E	F	G
24	24	3/8	5/8	5D	1	1 1/2
30	30	1/2	3/4	6D	1 1/2	1 7/8
36	36	5/8	7/8	7D	2	2 1/4

COLORS

LEGEND - BLACK (NON-REFL)
 BACKGROUND - YELLOW (REFL)

W14-2P

11/97

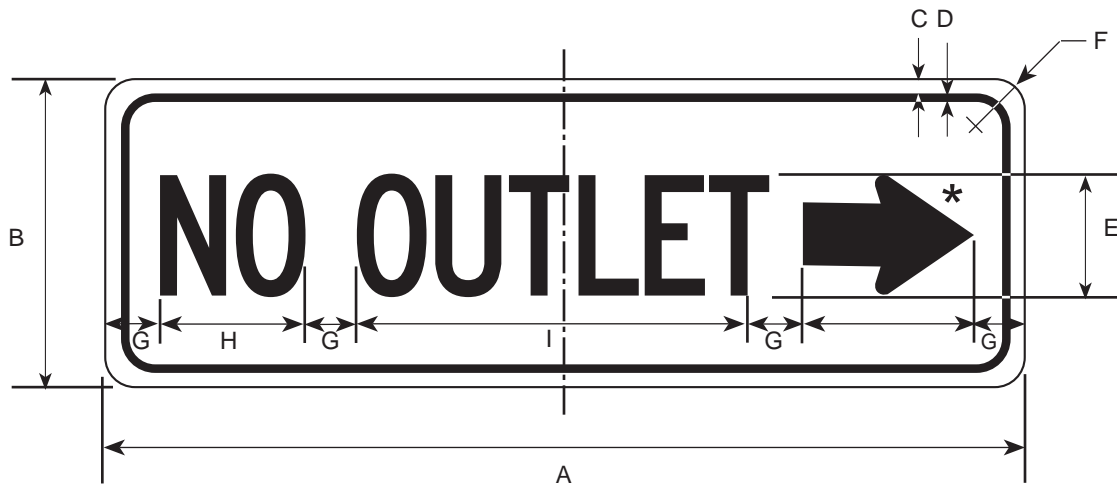

* SEE APPENDIX FOR STANDARD ARROW DETAILS
SPACING HAS BEEN REDUCED TO 50%

DIMENSIONS (MILLIMETERS)									
A	B	C	D	ARROW	E	F	G	H	I
900	300	18.75	12.5	100 X 125	125C	37.5	43.75	153.1	442.2

DIMENSIONS (INCHES)									
A	B	C	D	ARROW	E	F	G	H	I
36	12	3/4	1/2	4 X 5	5C	1 1/2	1 3/4	6 1/8	17

COLORS

LEGEND - BLACK (NON-REFL)
BACKGROUND - YELLOW (REFL)

W14-3

11/97

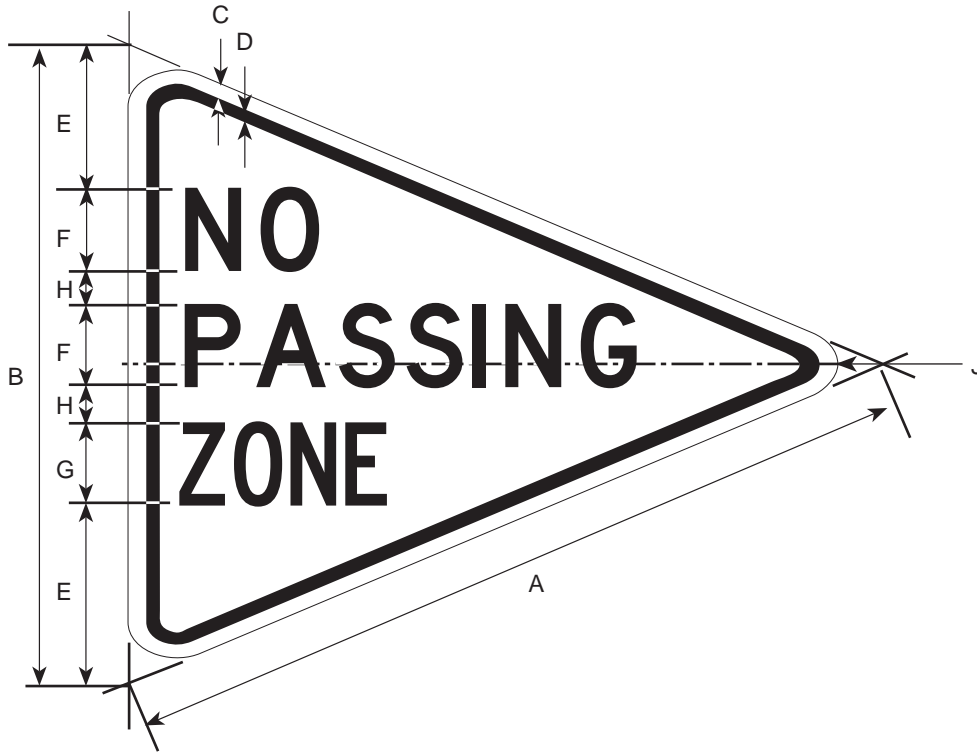

DIMENSIONS (MILLIMETERS)								
A	B	C	D	E	F	G	H	J
1000	750	13	19	181	100D	100C	44	47
1200	900	16	22	213	125D	125C	50	56
1600	1200	19	31	300	150D	150C	75	75

DIMENSIONS (INCHES)								
A	B	C	D	E	F	G	H	J
40	30	1/2	3/4	7 1/4	4D	4C	1 3/4	1 7/8
48	36	5/8	7/8	8 1/2	5D	5C	2	2 1/4
64	48	3/4	1 1/4	12	6D	6C	3	3

COLORS

LEGEND - BLACK (NON-REFL)
 BACKGROUND - YELLOW (REFL)

W14-501

11/97

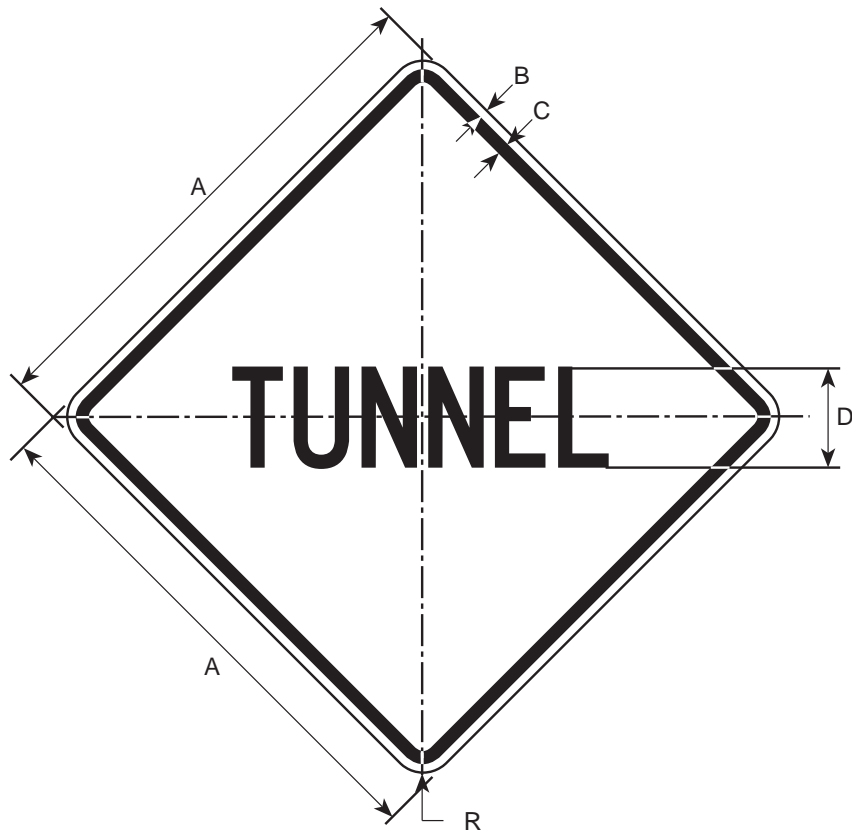

DIMENSIONS (MILLIMETERS)				
A	B	C	D	R
600	9	16	125-C	38
750	13	19	150-C	47
900	16	22	175-C	56
1200	19	31	250-C	75

DIMENSIONS (INCHES)				
A	B	C	D	R
24	3/8	5/8	5-C	1 1/2
30	1/2	3/4	6-C	1 7/8
36	5/8	7/8	7-C	2 1/4
48	3/4	1 1/4	10-C	3

COLORS

LEGEND - BLACK (NON-REFL.)
BACKGROUND - YELLOW (REFL.)

W14-601

11/97

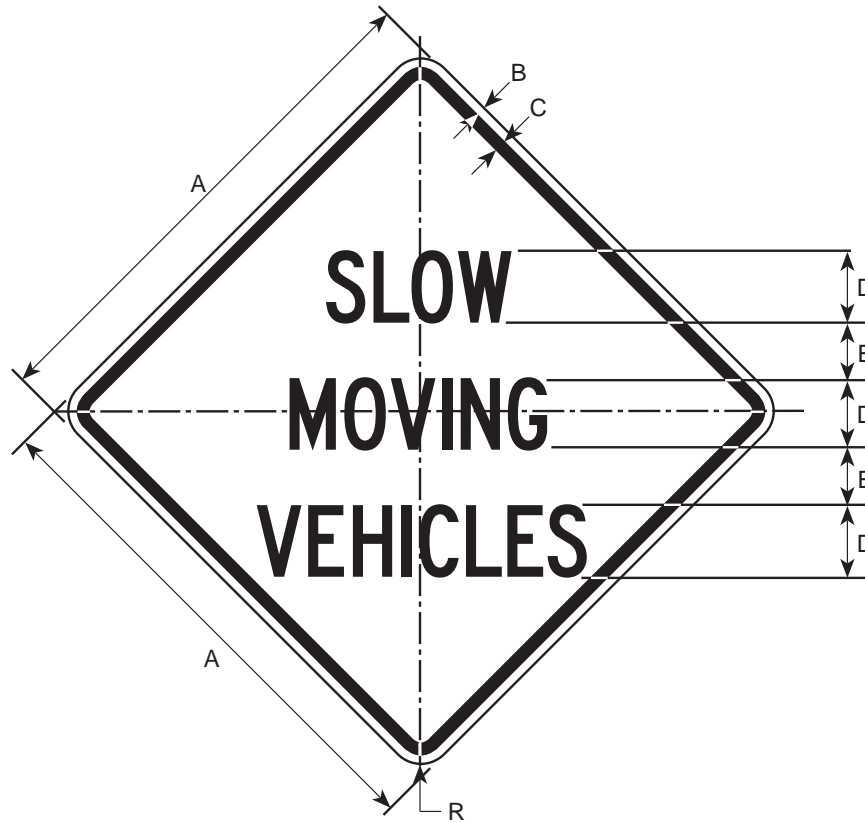

DIMENSIONS (MILLIMETERS)					
A	B	C	D	E	R
750	13	19	100-C	75	47
900	16	22	125-C	88	56
1200	19	31	175-C	31	75

DIMENSIONS (INCHES)					
A	B	C	D	E	R
30	1/2	3/4	4-C	3	1 7/8
36	5/8	7/8	5-C	3 1/2	2 1/4
48	3/4	1 1/4	7-C	1 1/4	3

COLORS

LEGEND - BLACK (NON-REFL.)
BACKGROUND - YELLOW (REFL.)

W14-701

11/97

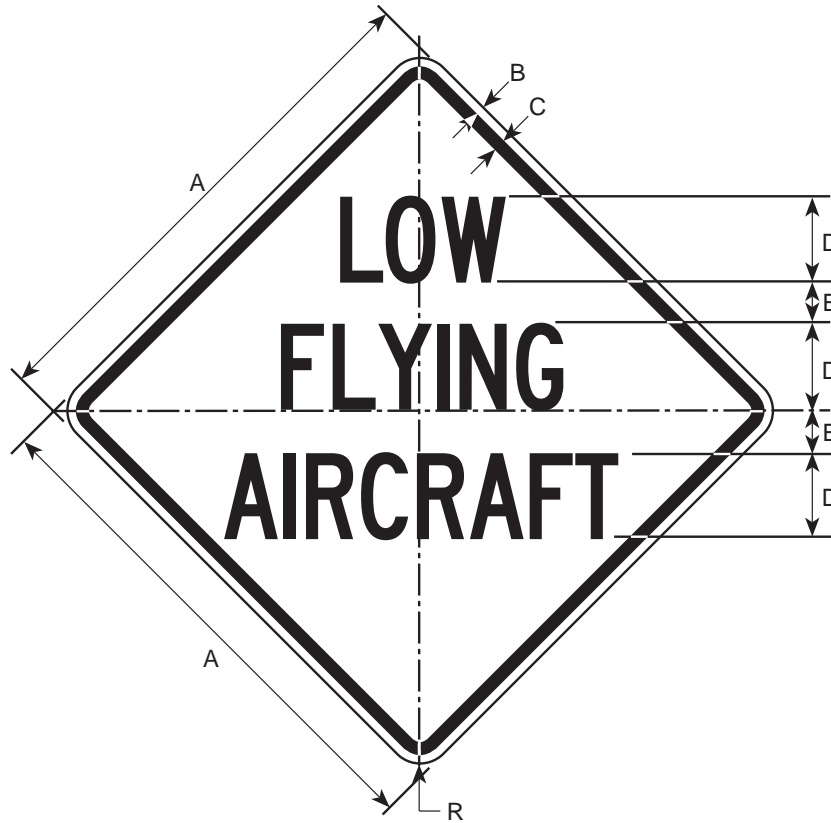

DIMENSIONS (MILLIMETERS)					
A	B	C	D	E	R
750	13	19	125-C	56	47
900	16	22	150-C	69	56
1200	19	31	200-C	88	75

DIMENSIONS (INCHES)					
A	B	C	D	E	R
30	1/2	3/4	5-C	2 1/4	1 7/8
36	5/8	7/8	6-C	2 3/4	2 1/4
48	3/4	1 1/4	8-C	3 1/2	3

COLORS

LEGEND - BLACK (NON-REFL.)
 BACKGROUND - YELLOW (REFL.)

W14-801

11/97

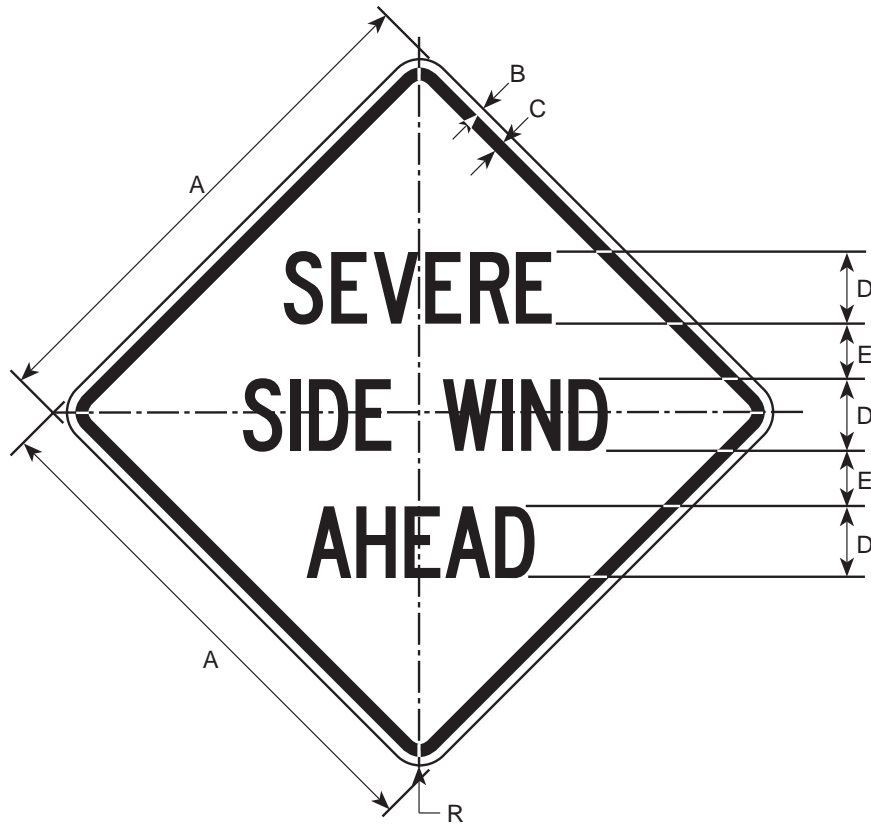

DIMENSIONS (MILLIMETERS)					
A	B	C	D	E	R
750	13	19	100-C	56	47
900	16	22	125-C	57	56
1200	19	31	175-C	100	75

DIMENSIONS (INCHES)					
A	B	C	D	E	R
30	1/2	3/4	4-C	2 1/2	1 7/8
36	5/8	7/8	5-C	3	2 1/4
48	3/4	1 1/4	7-C	4	3

COLORS

LEGEND - BLACK (NON-REFL.)
BACKGROUND - YELLOW (REFL.)

W14-901

11/97

SLOW MOVING VEHICLE EMBLEM

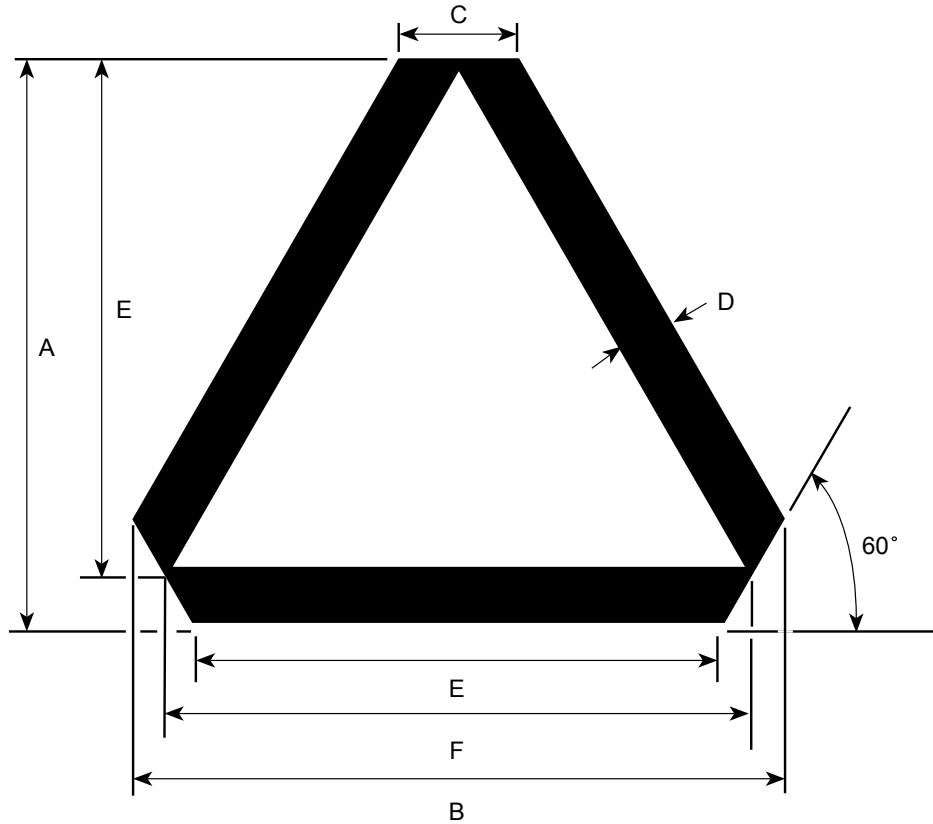

DIMENSIONS (MILLIMETERS)					
A	B	C	D	E	F
350	325	100	47	313	356
700	800	200	88	613	706

DIMENSIONS (INCHES)					
A	B	C	D	E	F
14	16	4	1 3/4	12 1/2	14 1/8
28	32	8	3 1/2	24 1/2	28 1/4

COLORS

LEGEND - ORANGE (FLUORESCENT)

BACKGROUND - RED (REFL.)

W14-1001

11/97

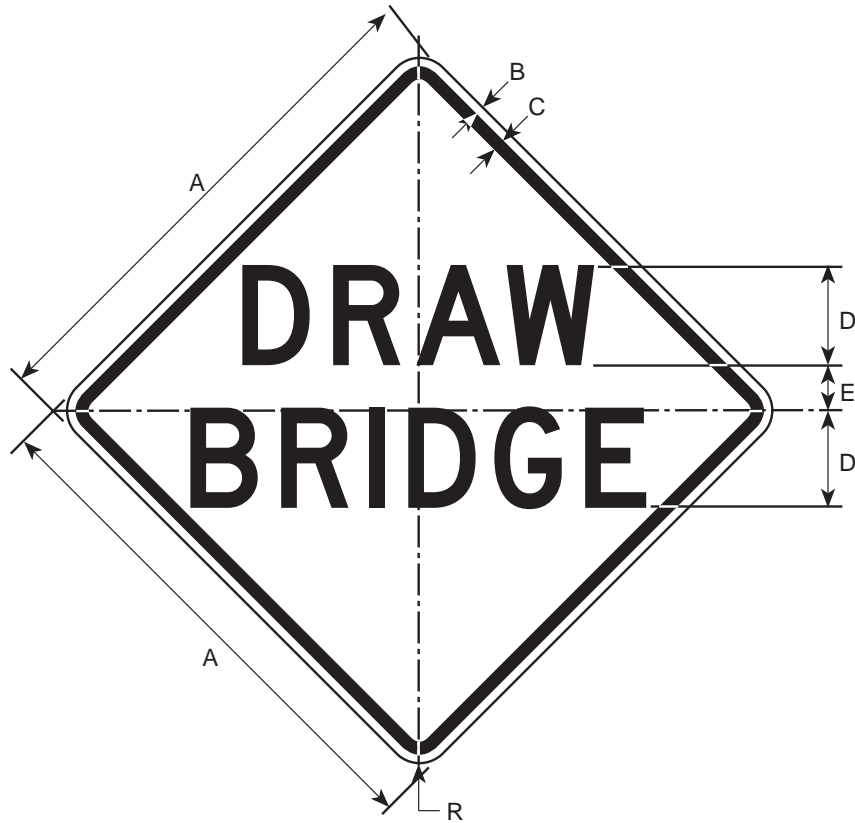

DIMENSIONS (MILLIMETERS)					
A	B	C	D	E	R
600	9	16	125-D	50	38
750	13	19	150-D	56	47
900	16	22	175-D	75	56
1200	19	31	250-D	100	75

DIMENSIONS (INCHES)					
A	B	C	D	E	R
24	3/8	5/8	5-D	2	1 1/2
30	1/2	3/4	6-D	2 1/2	1 7/8
36	5/8	7/8	7-D	3	2 1/4
48	3/4	1 1/4	10-D	4	3

COLORS

LEGEND - BLACK (NON-REFL.)
 BACKGROUND - YELLOW (REFL.)

W14-1002

11/97

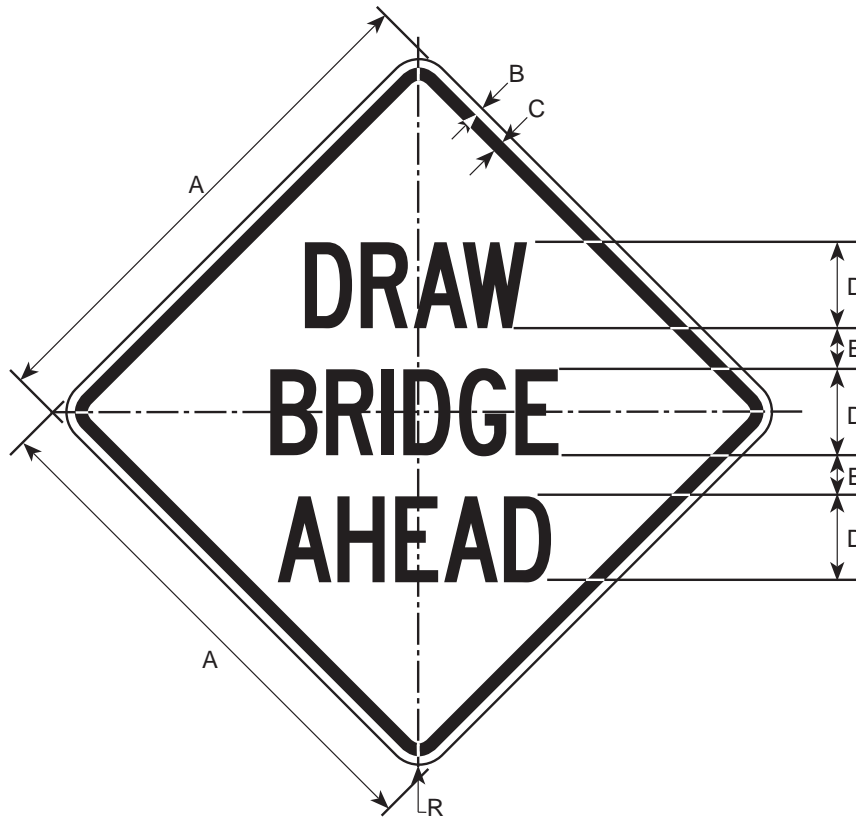

DIMENSIONS (MILLIMETERS)					
A	B	C	D	E	R
600	9	16	100-C	44	38
750	13	19	125-C	56	47
900	16	22	150-C	72	56
1200	19	31	200-C	88	75

DIMENSIONS (INCHES)					
A	B	C	D	E	R
24	3/8	5/8	4-C	1 3/4	1 1/2
30	1/2	3/4	5-C	2 1/4	1 7/8
36	5/8	7/8	6-C	2/34	2 1/4
48	3/4	1 1/4	8-C	3 1/2	3

COLORS

LEGEND - BLACK (NON-REFL.)
BACKGROUND - YELLOW (REFL.)

W14-1101

11/97

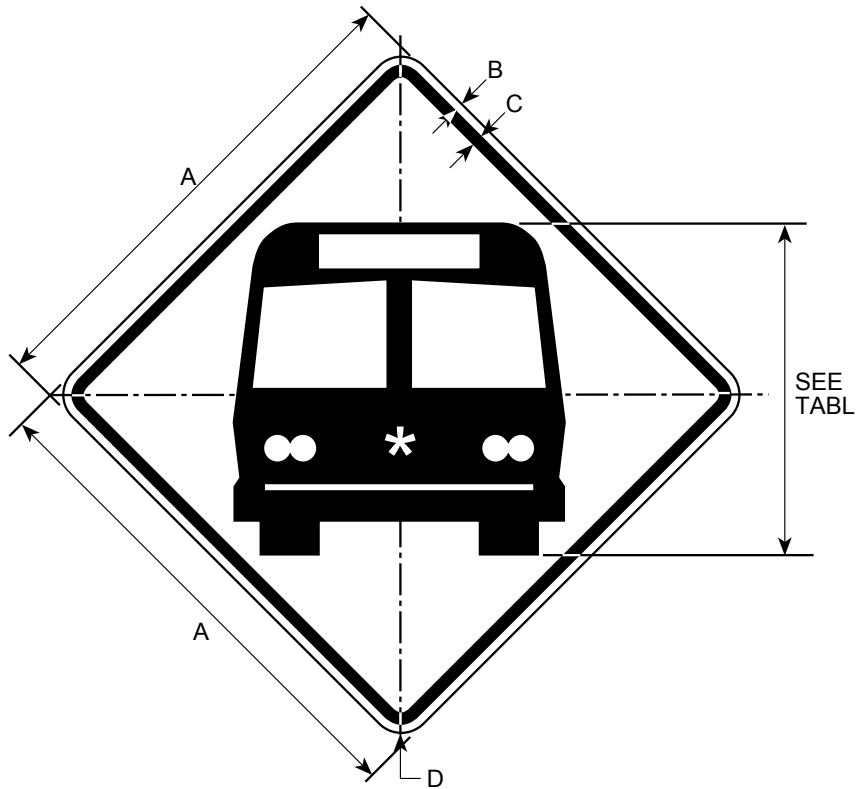

* SEE APPENDIX FOR SYMBOL DESIGN

DIMENSIONS (MILLIMETERS)					
A	B	C	SYMBOL HEIGHT	SYMBOL WIDTH	D
750	13	19	500	500	47
900	16	22	600	600	56
1200	19	31	800	800	75

DIMENSIONS (INCHES)					
A	B	C	SYMBOL HEIGHT	SYMBOL WIDTH	D
30	1/2	3/4	20	20	1 7/8
36	5/8	7/8	24	24	2 1/4
48	3/4	1 1/4	32	32	3

COLORS

LEGEND - BLACK (NON-REFL.)
BACKGROUND - YELLOW (REFL.)

W14-1601

11/97

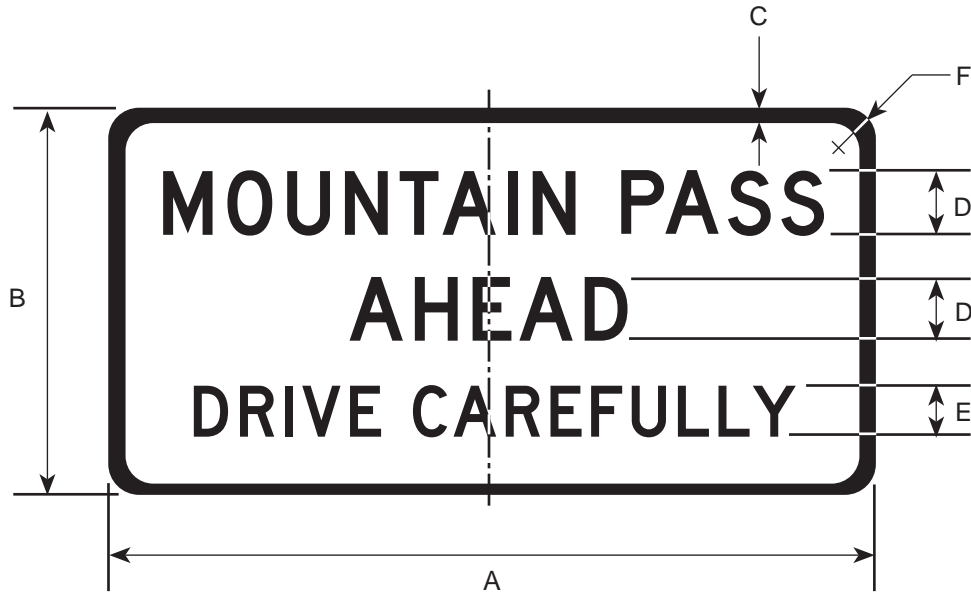

DIMENSIONS (MILLIMETERS)					
A	B	C	D	E	F
3000	1500	37.5	250D	200D	100

DIMENSIONS (INCHES)					
A	B	C	D	E	F
120	60	1 1/2	10D	8D	4

COLORS

LEGEND - BLACK (NON-REFL)
BACKGROUND - YELLOW (REFL)

W14-2202

11/97

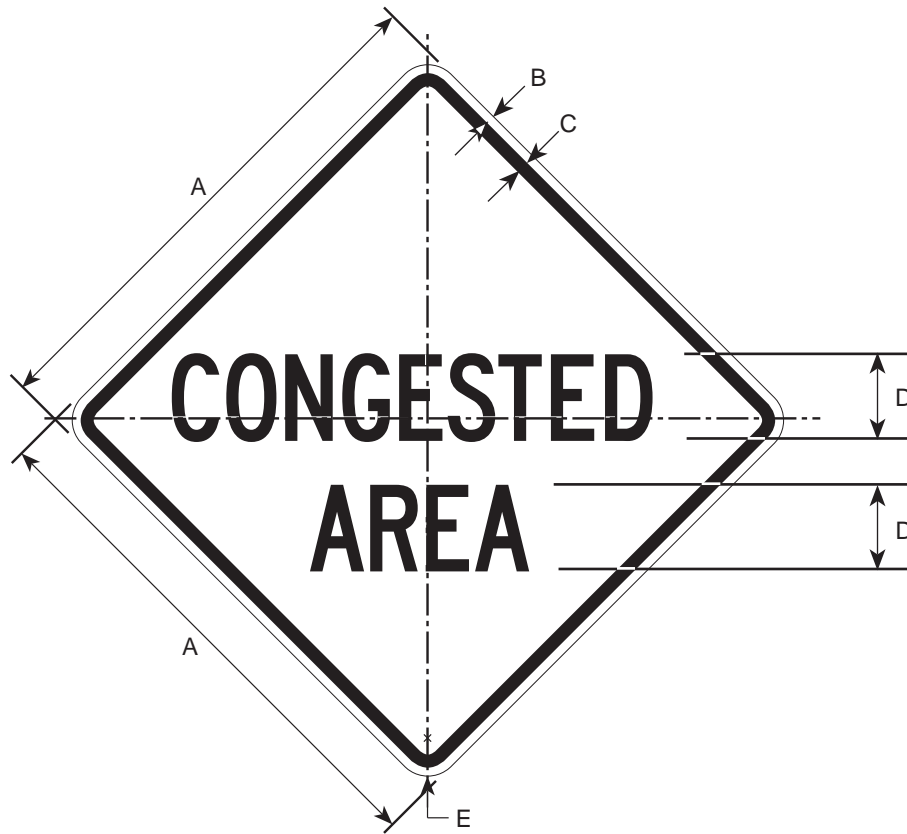

DIMENSIONS (MILLIMETERS)				
A	B	C	D	E
900	16	22	150C	56
1200	19	31	175C	75

DIMENSIONS (INCHES)				
A	B	C	D	E
36	5/8	7/8	6C	2 1/4
48	3/4	1 1/4	7C	3

COLORS

LEGEND - BLACK (NON-REFL)
BACKGROUND - YELLOW (REFL)

W14-2203

11/97

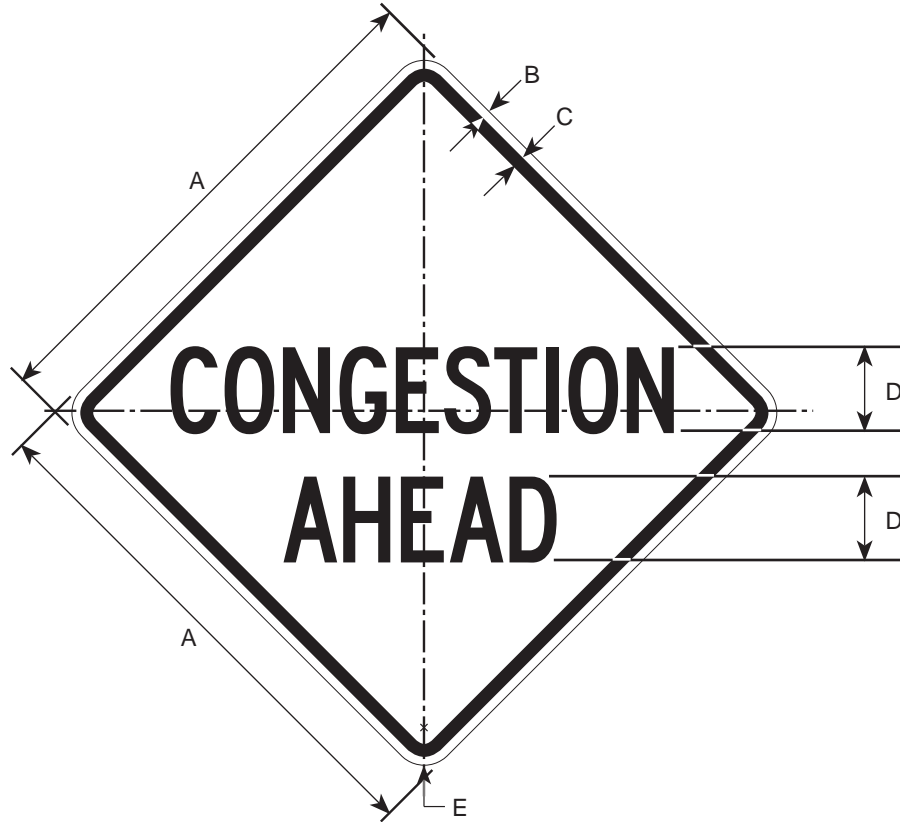

DIMENSIONS (MILLIMETERS)				
A	B	C	D	E
900	16	22	150C	56
1200	19	31	175C	75

DIMENSIONS (INCHES)				
A	B	C	D	E
36	5/8	7/8	6C	2 1/4
48	3/4	1 1/4	7C	3

COLORS

LEGEND - BLACK (NON-REFL)
BACKGROUND - YELLOW (REFL)

W15-1

11/97

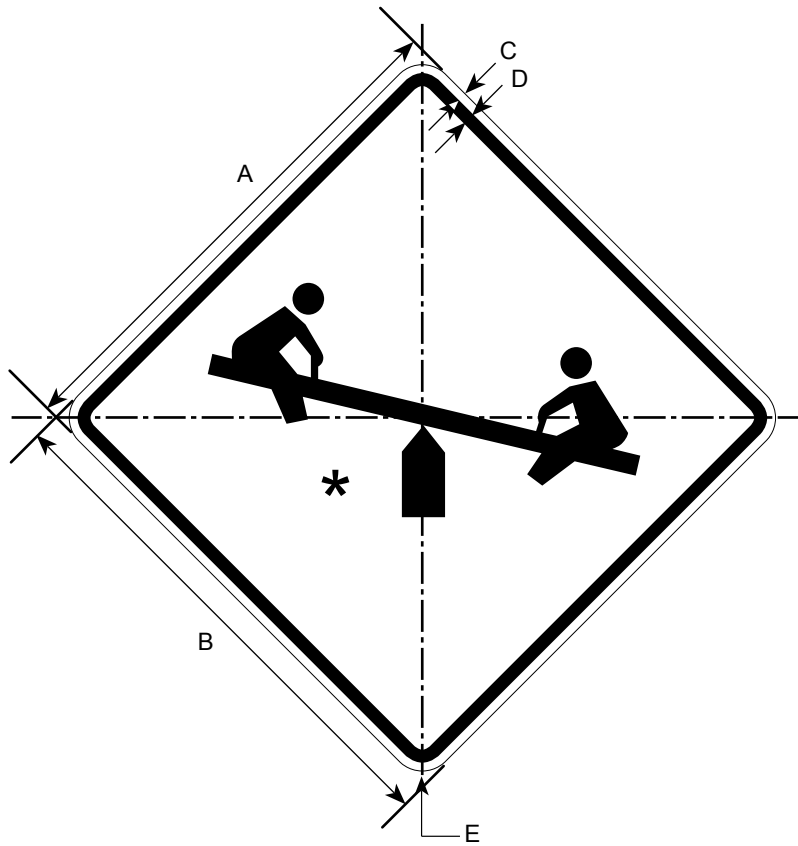

* SEE APPENDIX FOR SYMBOL DESIGN

DIMENSIONS (MILLIMETERS)				
A	B	C	D	E
750	750	13	19	47
900	900	16	22	56

DIMENSIONS (INCHES)				
A	B	C	D	E
30	30	1/2	3/4	1 7/8
36	36	5/8	7/8	2 1/4

COLORS

LEGEND— BLACK (NON-REFL)
BACKGROUND— YELLOW (REFL)

W15-201

11/97

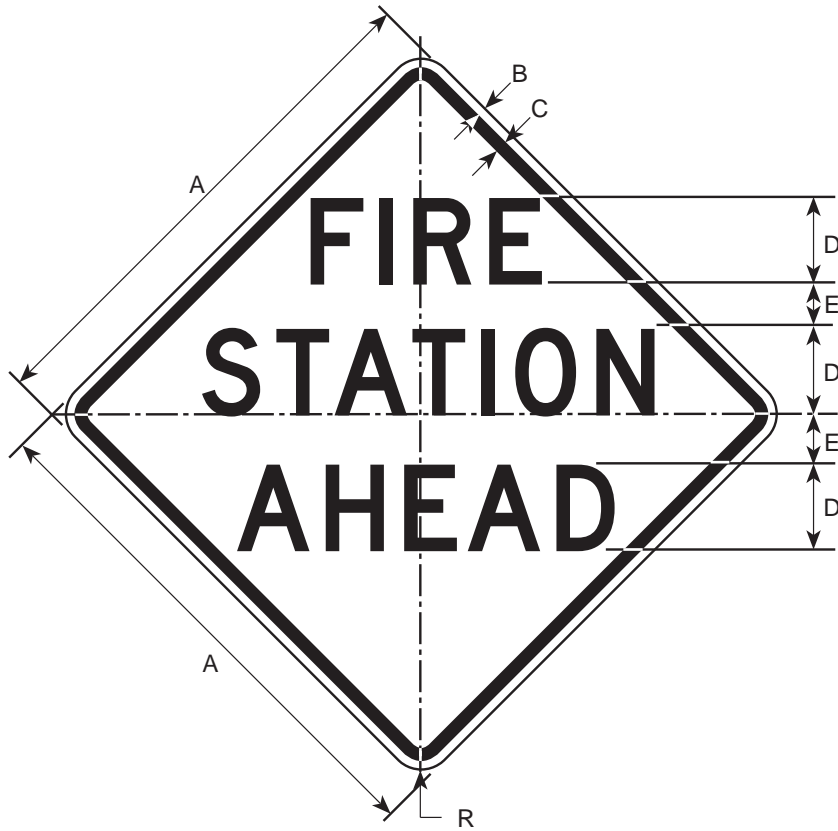

DIMENSIONS (MILLIMETERS)					
A	B	C	D	E	R
600	9	16	100-D	47	38
750	13	19	125-D	56	47
900	16	22	150-D	69	56
1200	19	31	200-D	100	75

DIMENSIONS (INCHES)					
A	B	C	D	E	R
24	3/8	5/8	4-D	1 3/4	1 1/2
30	1/2	3/4	5-D	2 1/4	1 7/8
36	5/8	7/8	6-D	2 3/4	2 1/4
48	3/4	1 1/4	8-D	4	3

COLORS

LEGEND - BLACK (NON-REFL.)
BACKGROUND - YELLOW (REFL.)

W15-301

11/97

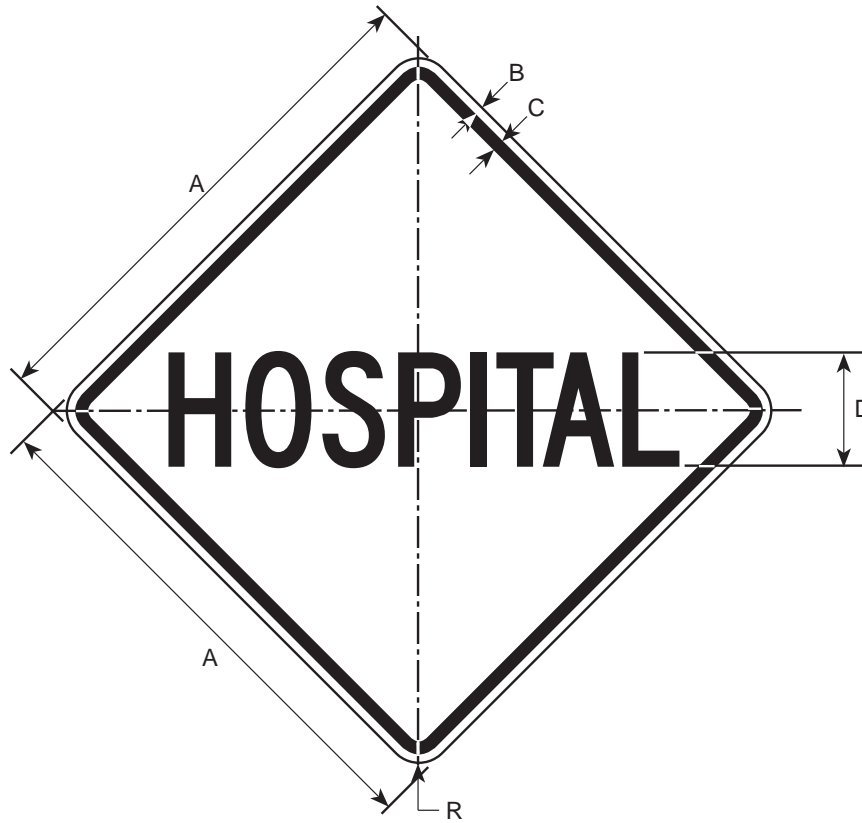

DIMENSIONS (MILLIMETERS)				
A	B	C	D	R
600	9	16	125-C	38
750	13	19	150-C	47
900	16	22	200-C	56
1200	19	31	250-C	75

DIMENSIONS (INCHES)				
A	B	C	D	R
24	3/8	5/8	5-C	1 1/2
30	1/2	3/4	6-C	1 7/8
36	5/8	7/8	8-C	2 1/4
48	3/4	1 1/4	10-C	3

COLORS

LEGEND - BLACK (NON-REFL.)
BACKGROUND - YELLOW (REFL.)

W16-101 & W16-102

11/97

W16-101

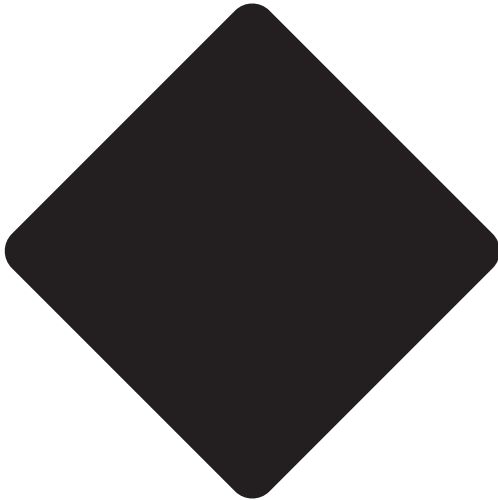

W16-102

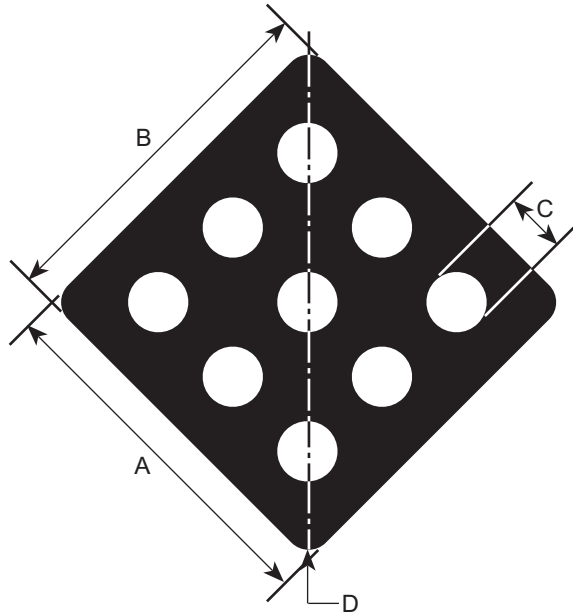

DIMENSIONS (MILLIMETERS)			
A	B	C	D
450	450	75	38

DIMENSIONS (INCHES)			
A	B	C	D
18	18	3	1 1/2

COLORS

W16-101— RED (REFL)
W16-102— RED OR BLACK (NON REFL)
WITH NINE 3" DIA. RED REFLECTORS

W16-5PR

6/03

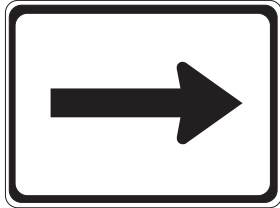

W16-5PL

6/03

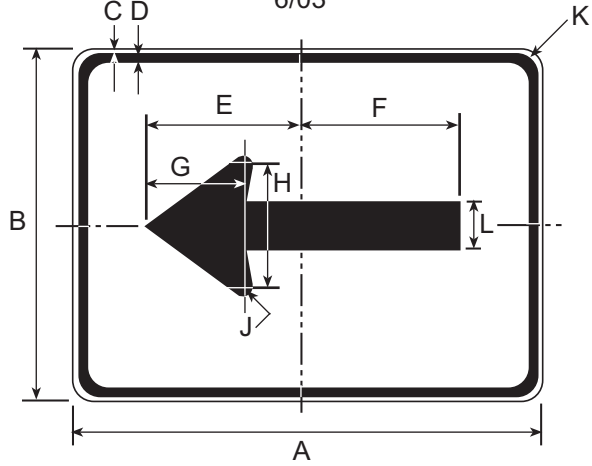

W16-6PR

6/03

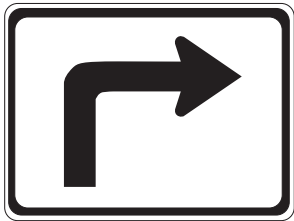

W16-6PL

6/03

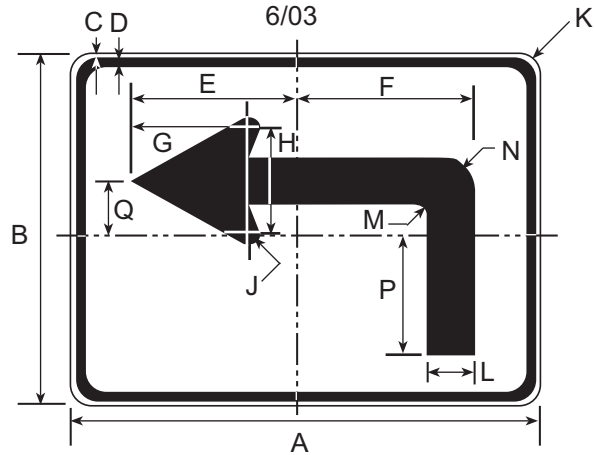

DIMENSIONS (MILLIMETERS)							
A	B	C	D	E	F	G	H
600	450	9	16	206	188	153	175

J	K	L	M	N	P	Q
14	38	75	19	25	148	72

DIMENSIONS (INCHES)							
A	B	C	D	E	F	G	H
24	18	3/8	5/8	8 1/4	7 1/2	6 1/8	7

J	K	L	M	N	P	Q
9/16	1 1/2	3	3/4	1	5 15/16	2 7/8

COLORS
 LEGEND - BLACK (NON-REFL)
 BACKGROUND - YELLOW (REFL)

W16-7PL & R

8/02

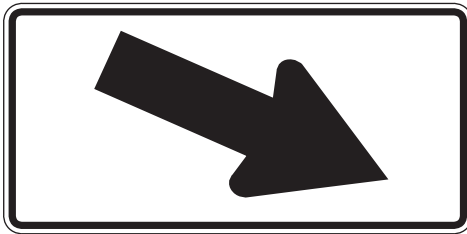
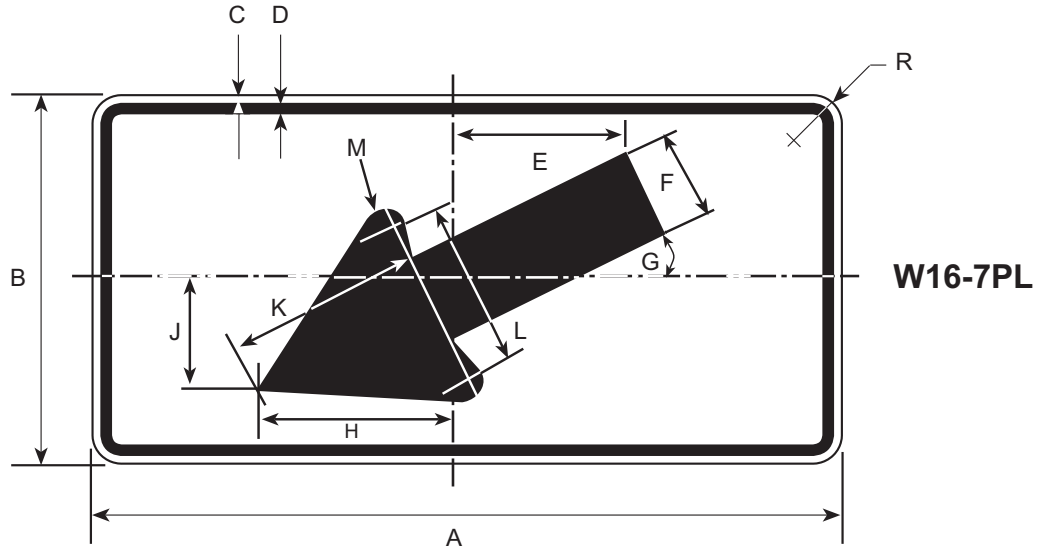

W16-7PR

NOTE: SIGN DESIGNERS SPECIFY SIGN COLOR

DIMENSIONS (MILLIMETERS)												
A	B	C	D	E	F	G	H	J	K	L	M	R
600	300	9	16	105	75	30°	147	81	147	173	14	38
750	450	13	19	163	113	30°	219	123	219	259	23	38

DIMENSIONS (INCHES)												
A	B	C	D	E	F	G	H	J	K	L	M	R
24	12	3/8	5/8	4 3/16	3	30°	5 7/8	3 1/4	5 7/8	6 15/16	9/16	1 1/2
30	18	1/2	3/4	6 1/2	4 1/2	30°	8 3/4	4 15/16	8 3/4	10 3/8	15/16	1 1/2

COLORS

LEGEND — BLACK (NON-REFL)
 BACKGROUND — YELLOW (REFL)
 OR FLUORESCENT
 YELLOW GREEN (REFL)

W16-9P

4/03

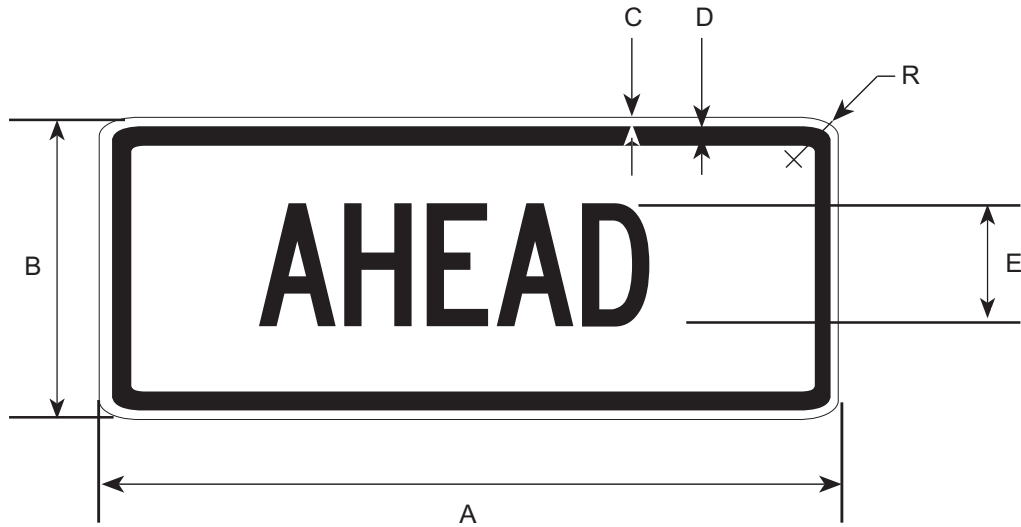

DIMENSIONS (MILLIMETERS)					
A	B	C	D	E	R
600	250	9	16	100-C	38
900	375	16	22	200-C	57
1200	500	19	31	300-C	75

DIMENSIONS (INCHES)					
A	B	C	D	E	R
24	10	3/8	5/8	4-C	1 1/2
36	15	5/8	7/8	8-C	2 1/4
48	20	3/4	1 1/4	10-C	3

COLORS

LEGEND — BLACK (NON-REFL)
 BACKGROUND — YELLOW (REFL)
 OR
 FLUORESCENT YELLOW GREEN (REFL)

W16-10

5/06

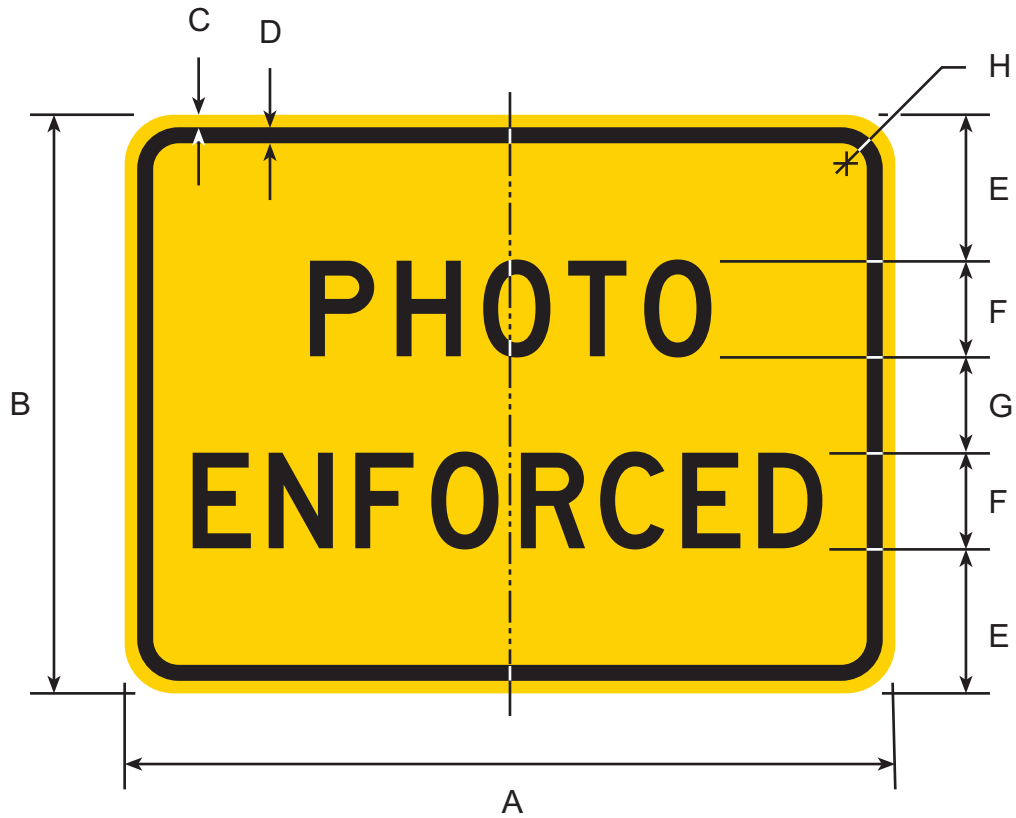

DIMENSIONS (MILLIMETERS)							
A	B	C	D	E	F	G	H
600	450	9	16	88	100B	75	38
900	600	16	22	150	100D	100	56
1200	900	19	31	175	150D	150	75

DIMENSIONS (INCHES)							
A	B	C	D	E	F	G	H
24	18	3/8	5/8	3 1/2	4B	3	1 1/2
36	24	5/8	7/8	6	4D	4	2 1/4
48	36	3/4	1 1/4	9	6D	6	3

COLORS

LEGEND & BORDER - BLACK (NON-REFL)
BACKGROUND - YELLOW (REFL)

W17-1

6/03

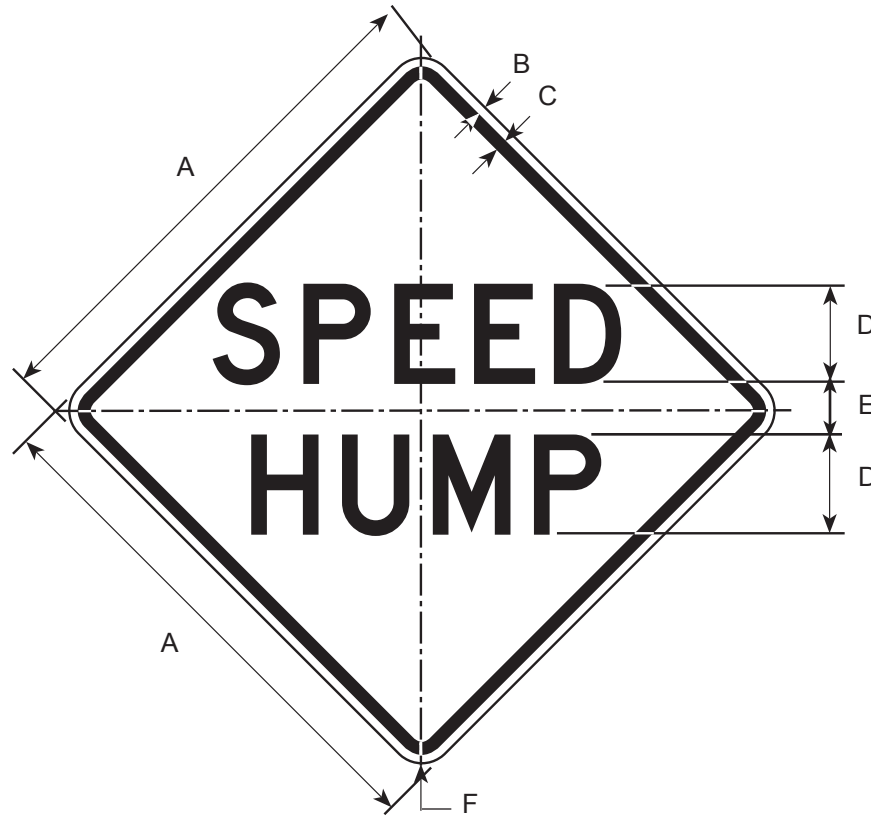

DIMENSIONS (MILLIMETERS)					
A	B	C	D	E	F
600	9	16	100D	50	38
750	13	19	125D	63	47
900	16	22	150D	75	56

DIMENSIONS (INCHES)					
A	B	C	D	E	F
24	3/8	5/8	4D	2	1 1/2
30	1/2	3/4	5D	2 1/2	1 7/8
36	5/8	7/8	6D	3	2 1/4

COLORS
 LEGEND - BLACK (NON-REFL)
 BACKGROUND - YELLOW (REFL)

W20-1

11/97

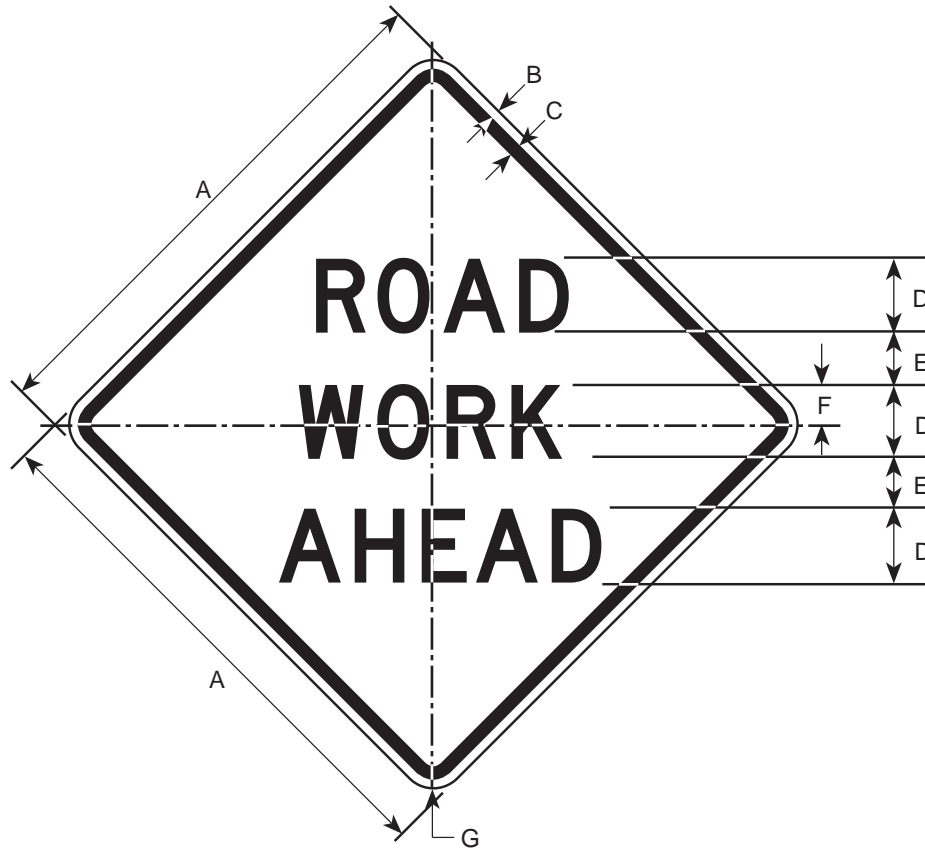

DIMENSIONS (MILLIMETERS)						
A	B	C	D	E	F	G
750	13	19	100D	72	66	47
900	16	22	125D	88	81	56
1200	22	31	175D	11	11	75

DIMENSIONS (INCHES)						
A	B	C	D	E	F	G
30	1/2	3/4	4D	2 7/8	2 5/8	1 7/8
36	5/8	7/8	5D	3 1/2	3 1/4	2 1/4
48	3/4	1 1/4	7D	4 3/4	4 1/2	3

COLORS

LEGEND - BLACK (NON-REFL.)
BACKGROUND - ORANGE (REFL.)

W20-2

11/97

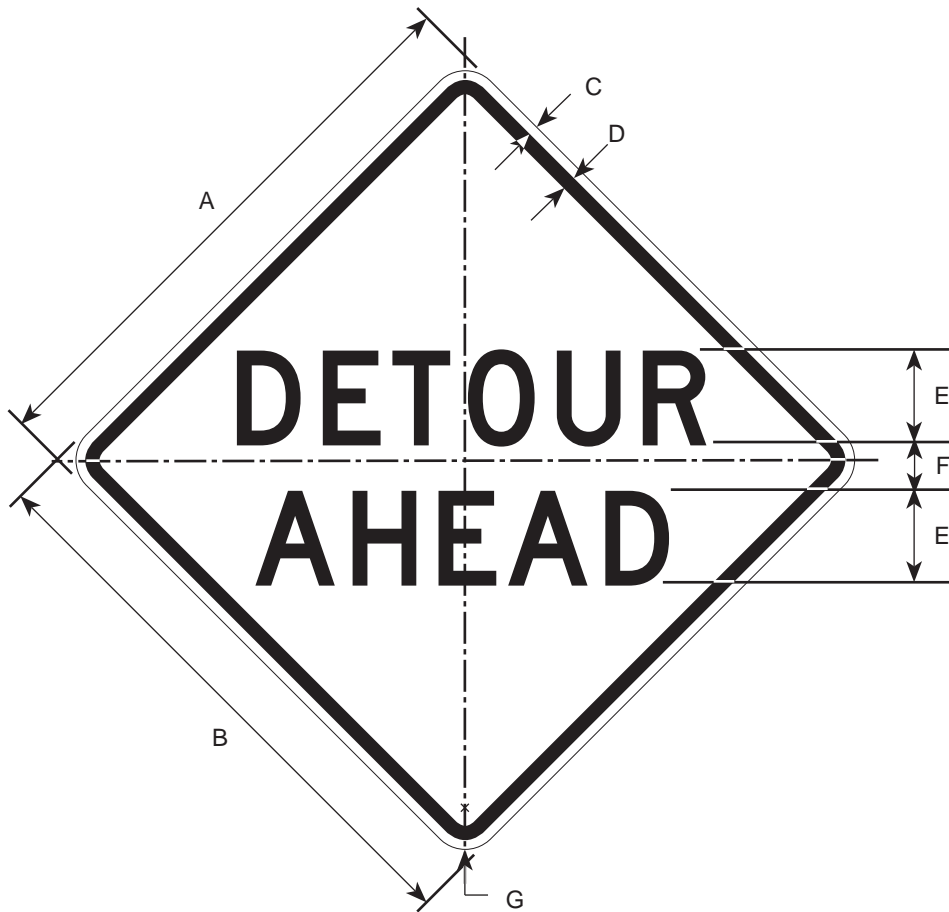

DIMENSIONS (MILLIMETERS)						
A	B	C	D	E	F	G
900	900	16	22	150D	88	56
1200	1200	19	31	200D	11	75

DIMENSIONS (INCHES)						
A	B	C	D	E	F	G
36	36	5/8	7/8	6D	3 1/2	2 1/4
48	48	3/4	1 1/4	8D	4 1/4	3

COLORS

LEGEND - BLACK (NON-REFL)
 BACKGROUND - ORANGE (REFL)

W20-3

11/03

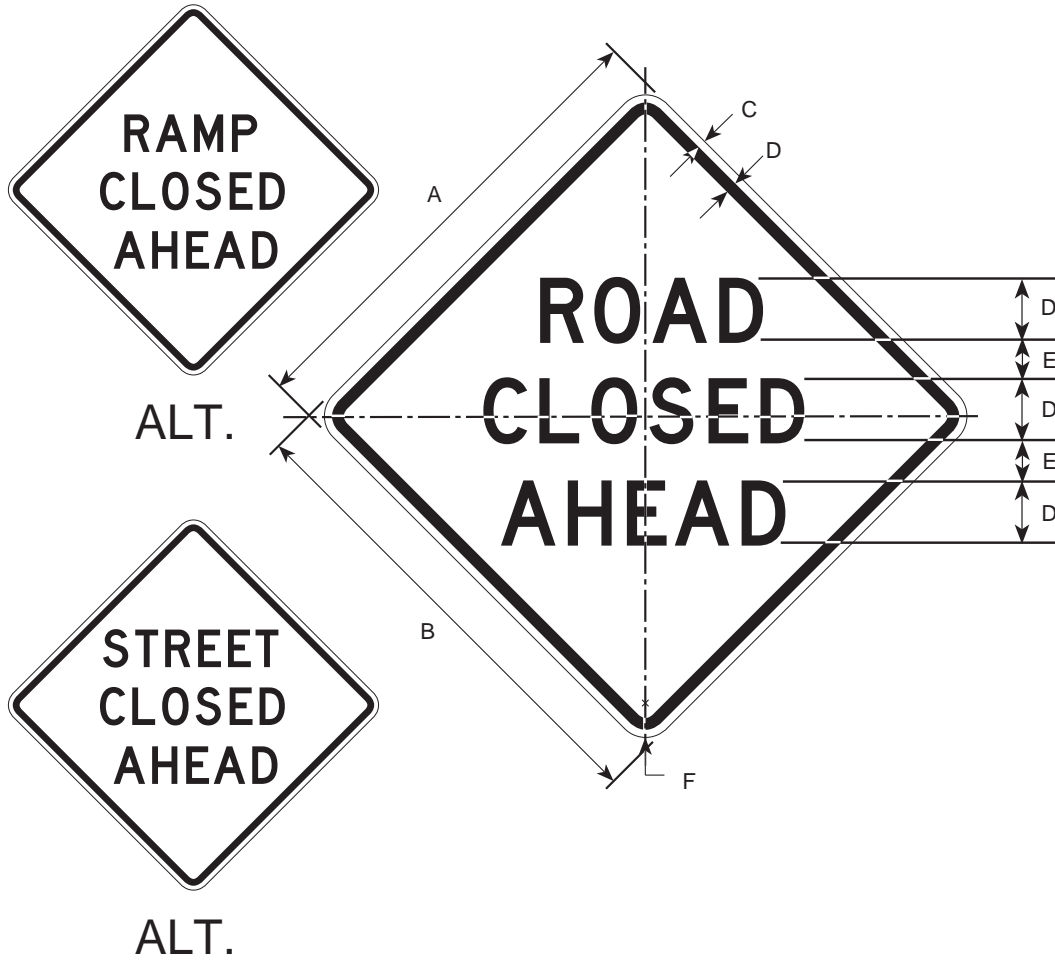

DIMENSIONS (MILLIMETERS)					
A	B	C	D	E	F
900	900	16	22	125D	56
1200	1200	19	31	175D	75

DIMENSIONS (INCHES)					
A	B	C	D	E	F
36	36	5/8	7/8	5D	2 1/4
48	48	3/4	1 1/4	7D	3

COLORS

LEGEND - BLACK (NON-REFL)
BACKGROUND - ORANGE (REFL)

W20-301

11/97

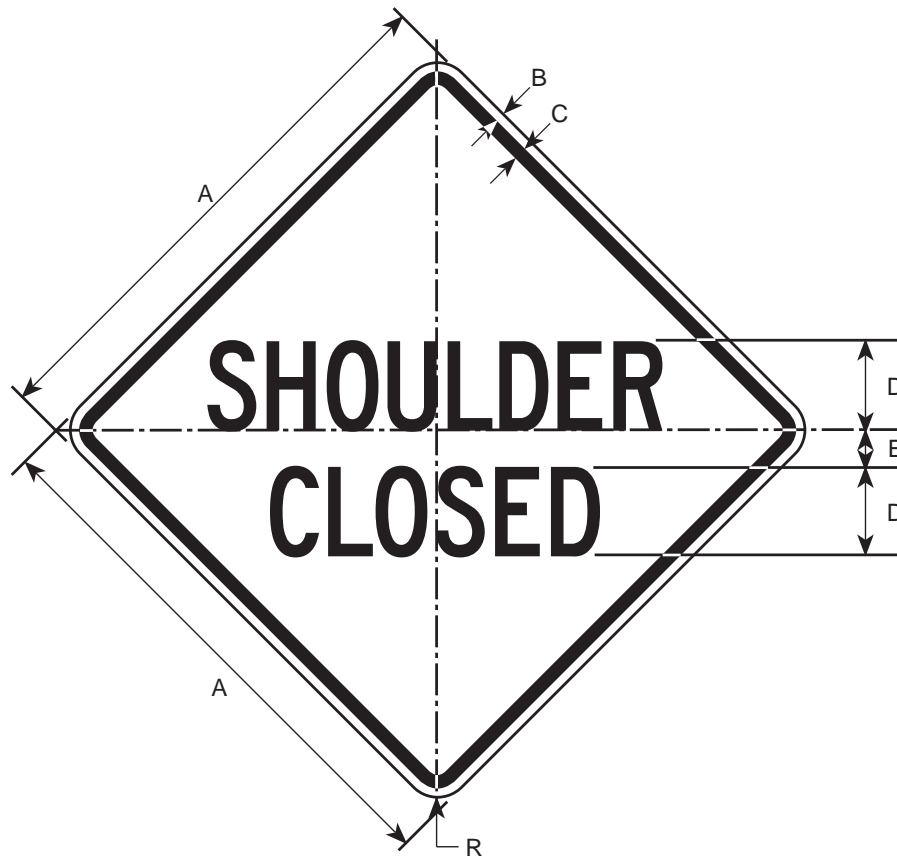

DIMENSIONS (MILLIMETERS)					
A	B	C	D	E	R
600	9	16	100C	34	38
750	13	19	125C	47	47
900	16	22	150C	56	56
1200	19	31	175C	75	75

DIMENSIONS (INCHES)					
A	B	C	D	E	R
24	3/8	5/8	4C	1 3/8	1 1/2
30	1/2	3/4	5C	1 7/8	1 7/8
36	5/8	7/8	6C	2 1/4	2 1/4
48	3/4	1 1/4	7C	3	3

COLORS

LEGEND - BLACK (NON-REFL.)
BACKGROUND - ORANGE (REFL.)

W20-303

11/97

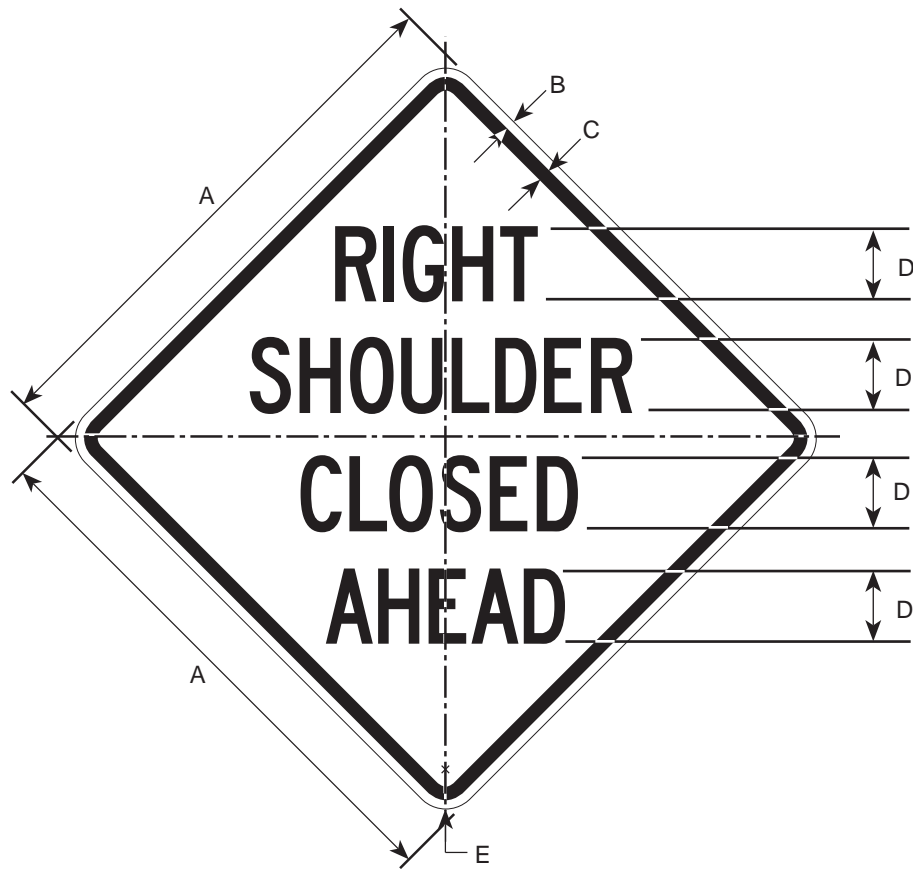

DIMENSIONS (MILLIMETERS)				
A	B	C	D	E
900	16	22	125C	56
1200	19	31	150C	75

DIMENSIONS (INCHES)				
A	B	C	D	E
36	5/8	7/8	5C	2 1/4
48	3/4	1 1/4	6C	3

COLORS

LEGEND - BLACK (NON-REFL)
BACKGROUND - ORANGE (REFL)

W20-4

11/97

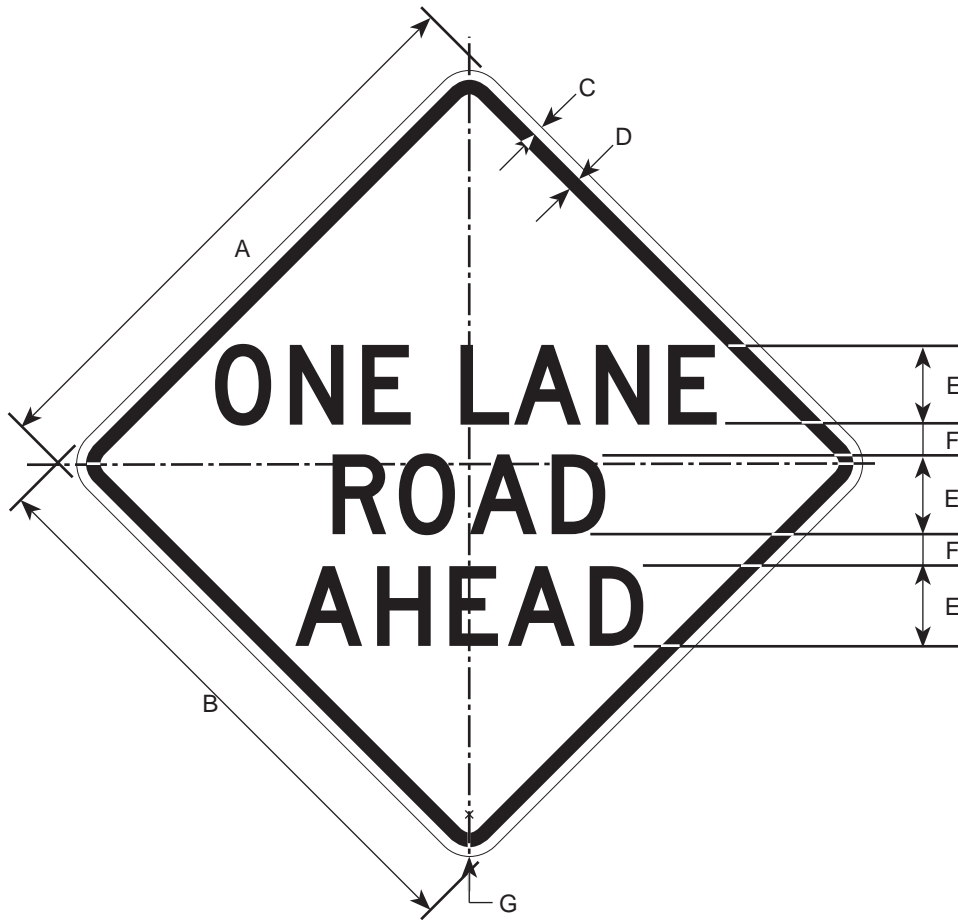

DIMENSIONS (MILLIMETERS)						
A	B	C	D	E	F	G
900	900	22	125C	56	31	56
1200	1200	31	175C	109	44	75

DIMENSIONS (INCHES)						
A	B	C	D	E	F	G
36	36	5/8	7/8	5C	2 1/4	2 1/4
48	48	3/4	1 1/4	7C	4 3/8	3

COLORS

LEGEND - BLACK (NON-REFL)
 BACKGROUND - ORANGE (REFL)

W20-5

11/97

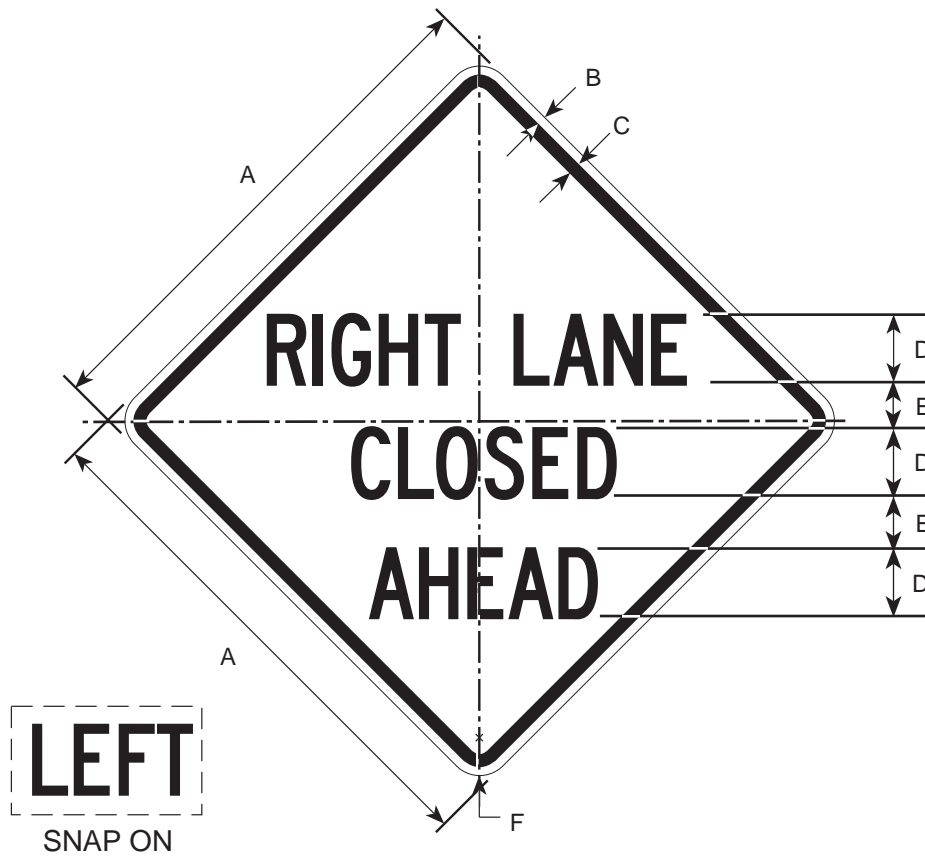

LINE 1 ALTERNATIVES

LEFT LANE CENTER LANE

DIMENSIONS (MILLIMETERS)					
A	B	C	D	E	F
900	16	22	125C	69	56
1200	19	31	150C	84	97

DIMENSIONS (INCHES)					
A	B	C	D	E	F
36	5/8	7/8	5C	2 3/4	2 1/4
48	3/4	1 1/4	6C	3 3/8	3

COLORS

LEGEND - BLACK (NON-REFL)

BACKGROUND - ORANGE (REFL)

W20-501

11/97

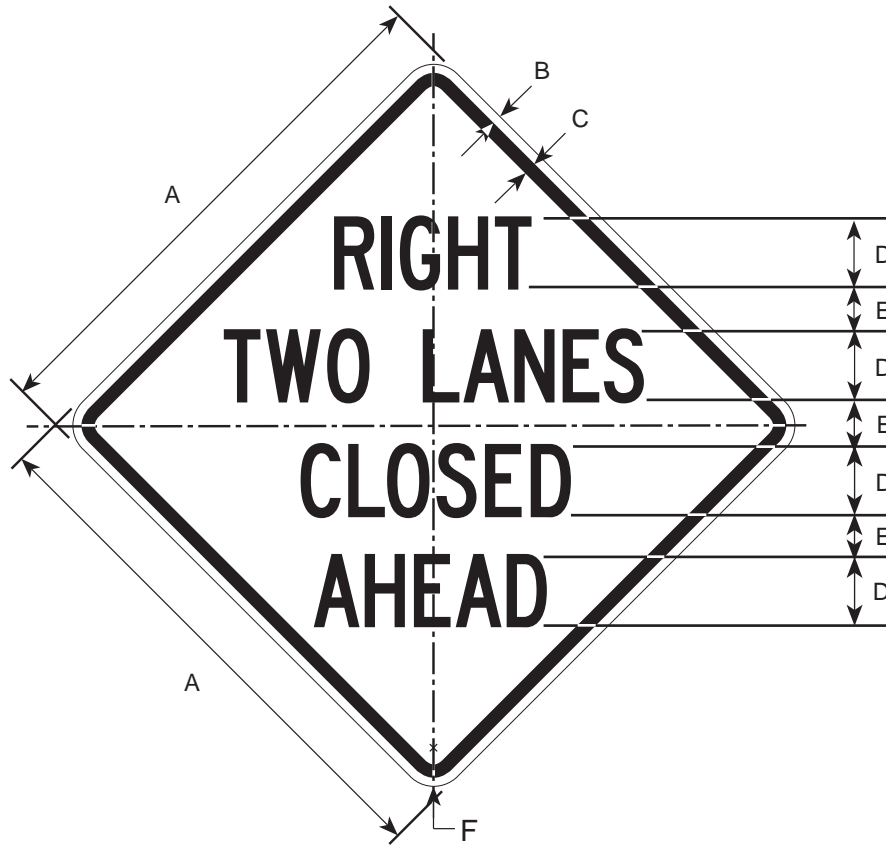

DIMENSIONS (MILLIMETERS)					
A	B	C	D	E	F
750	13	19	100C	50	38
900	16	22	125C	59	47
1200	19	31	175C	75	56

DIMENSIONS (INCHES)					
A	B	C	D	E	F
30	1/2	3/4	4C	2	1 7/8
36	5/8	7/8	5C	2 3/8	2 1/4
48	3/4	1 1/4	7C	3	3

COLORS

LEGEND - BLACK (NON-REFL)
BACKGROUND - ORANGE (REFL)

W20-7A

11/97

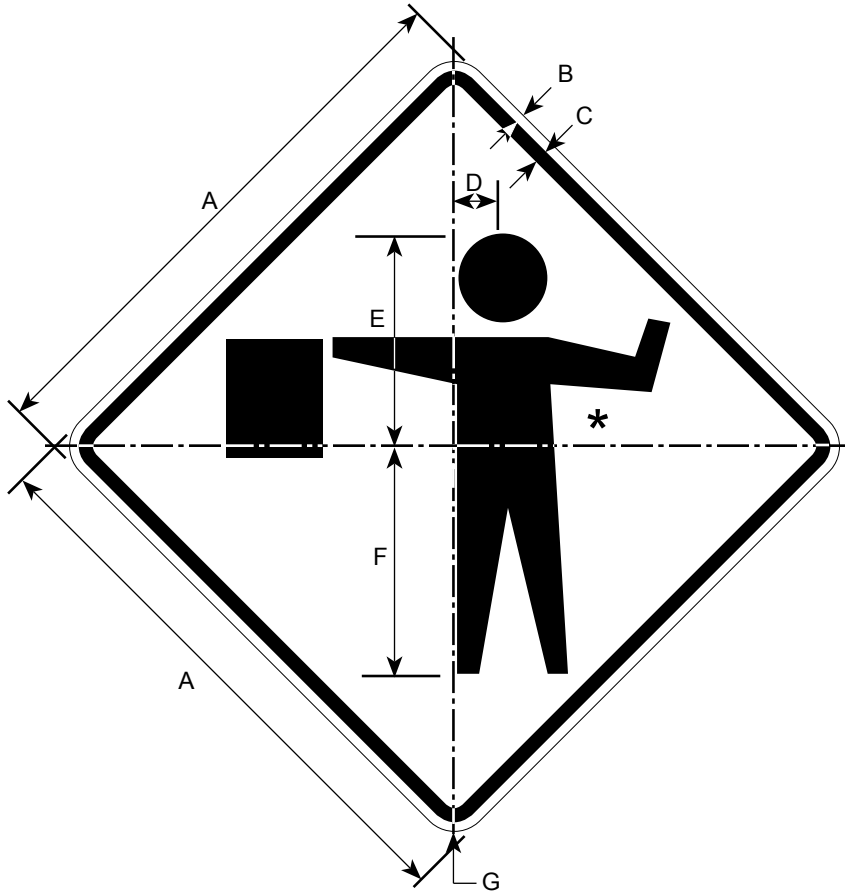

* SEE APPENDIX FOR SYMBOL DETAILS

DIMENSIONS (MILLIMETERS)						
A	B	C	D	E	F	G
750	13	19	56	281	303	47
900	16	22	72	338	366	56
1200	19	31	97	450	488	75

DIMENSIONS (INCHES)						
A	B	C	D	E	F	G
30	1/2	3/4	2 1/4	11 12 1/8	12 1/8	1 7/8
36	5/8	7/8	2 3/4	13 1/2	14 5/8	2 1/4
48	3/4	1 1/4	3 3/4	18	19 1/2	3

COLORS

LEGEND - BLACK (NON-REFL.)
 BACKGROUND - ORANGE (REFL.)

W20-7B

11/97

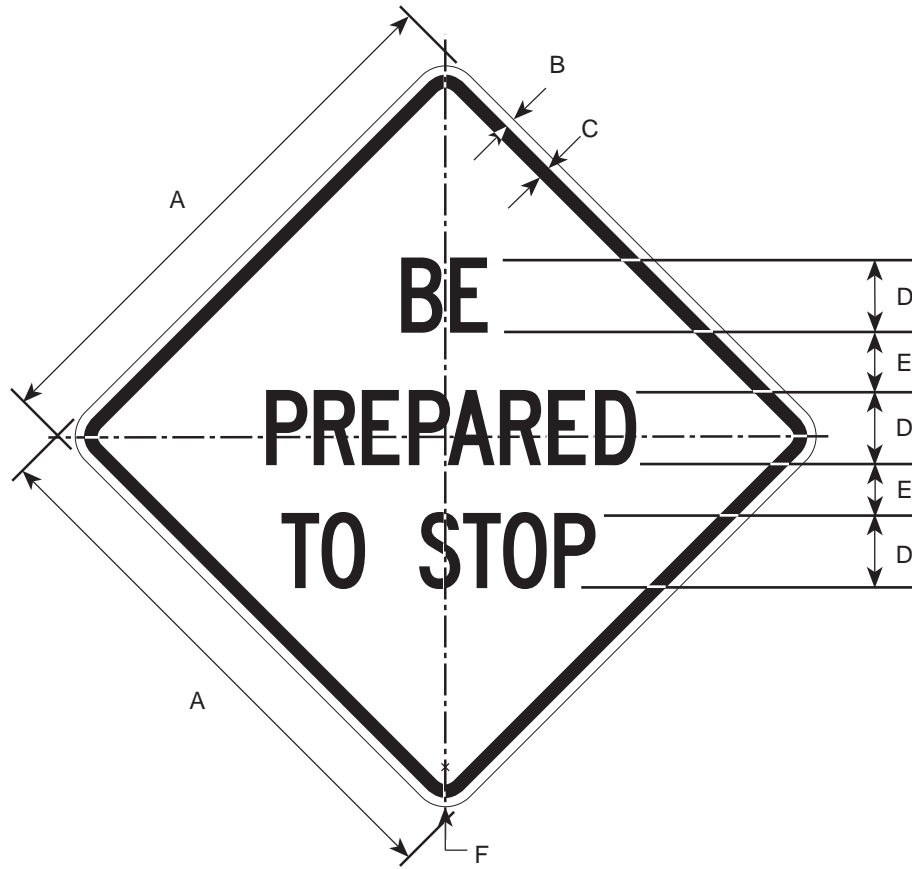

DIMENSIONS (MILLIMETERS)					
A	B	C	D	E	F
750	13	19	125C	50	38
900	16	22	150C	59	47
1200	19	31	200C	75	56

DIMENSIONS (INCHES)					
A	B	C	D	E	F
30	1/2	3/4	5C	2	1 7/8
36	5/8	7/8	6C	2 3/8	2 1/4
48	3/4	1 1/4	8C	3	3

COLORS

LEGEND - BLACK (NON-REFL)
 BACKGROUND - ORANGE (REFL)

W20-901

11/97

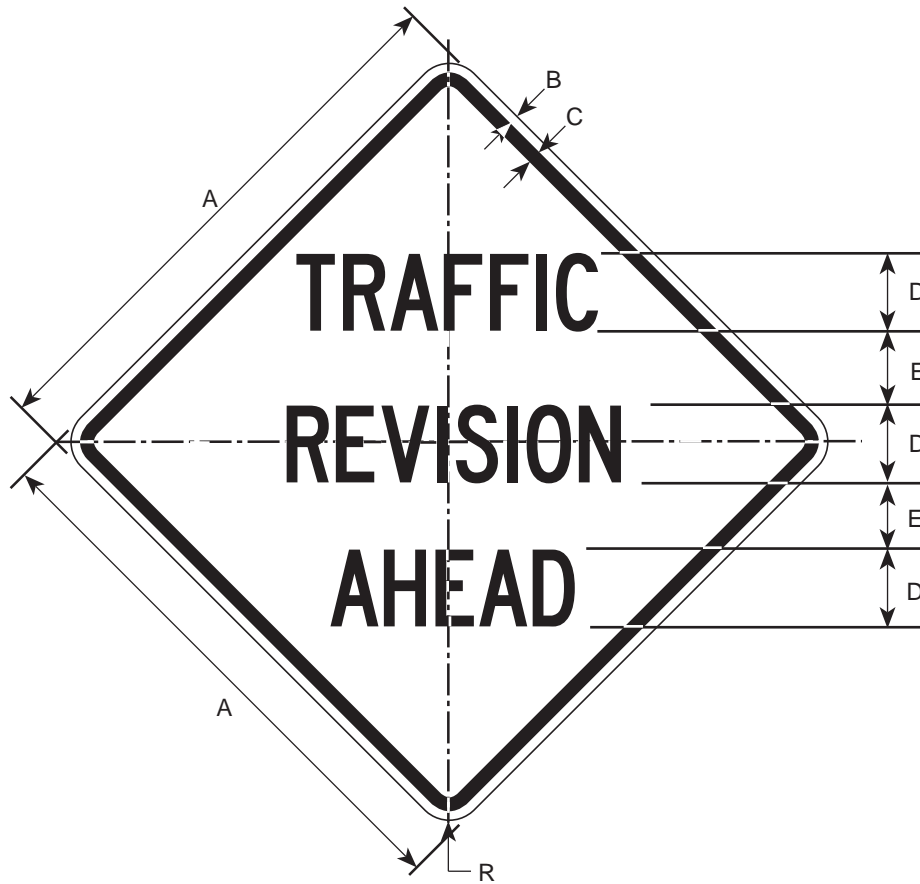

DIMENSIONS (MILLIMETERS)					
A	B	C	D	E	R
750	13	19	100C	63	47
900	16	22	125C	81	56
1200	19	31	175C	11	75

DIMENSIONS (INCHES)					
A	B	C	D	E	R
30	1/2	3/4	4-C	2 1/2	1 7/8
36	5/8	7/8	5-C	3 1/4	2 1/4
48	3/4	1 1/4	7-C	4 1/2	3

COLORS

LEGEND - BLACK (NON-REFL.)
BACKGROUND - ORANGE (REFL.)

W20-902

11/97

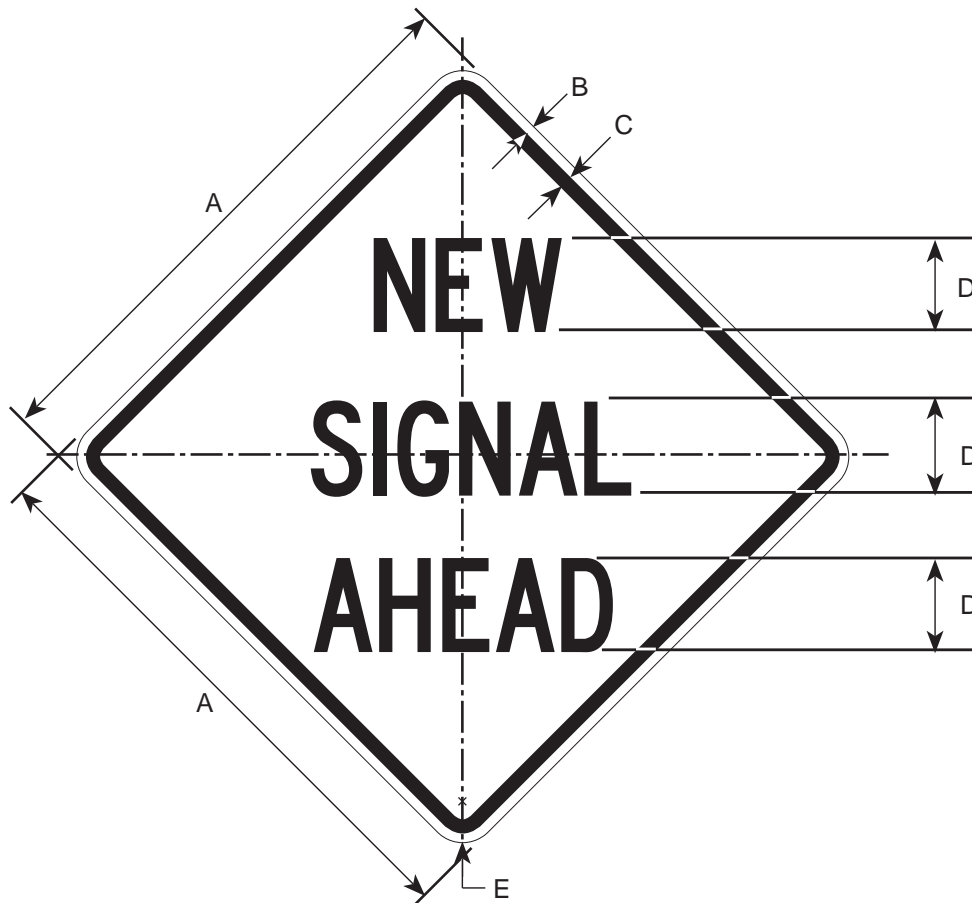

DIMENSIONS (MILLIMETERS)				
A	B	C	D	E
900	16	22	150C	56
1200	19	31	175C	75

DIMENSIONS (INCHES)				
A	B	C	D	E
36	5/8	7/8	6C	2 1/4
48	3/4	1 1/4	7C	3

COLORS

LEGEND - BLACK (NON-REFL)
BACKGROUND - ORANGE (REFL)

W20-903

11/97

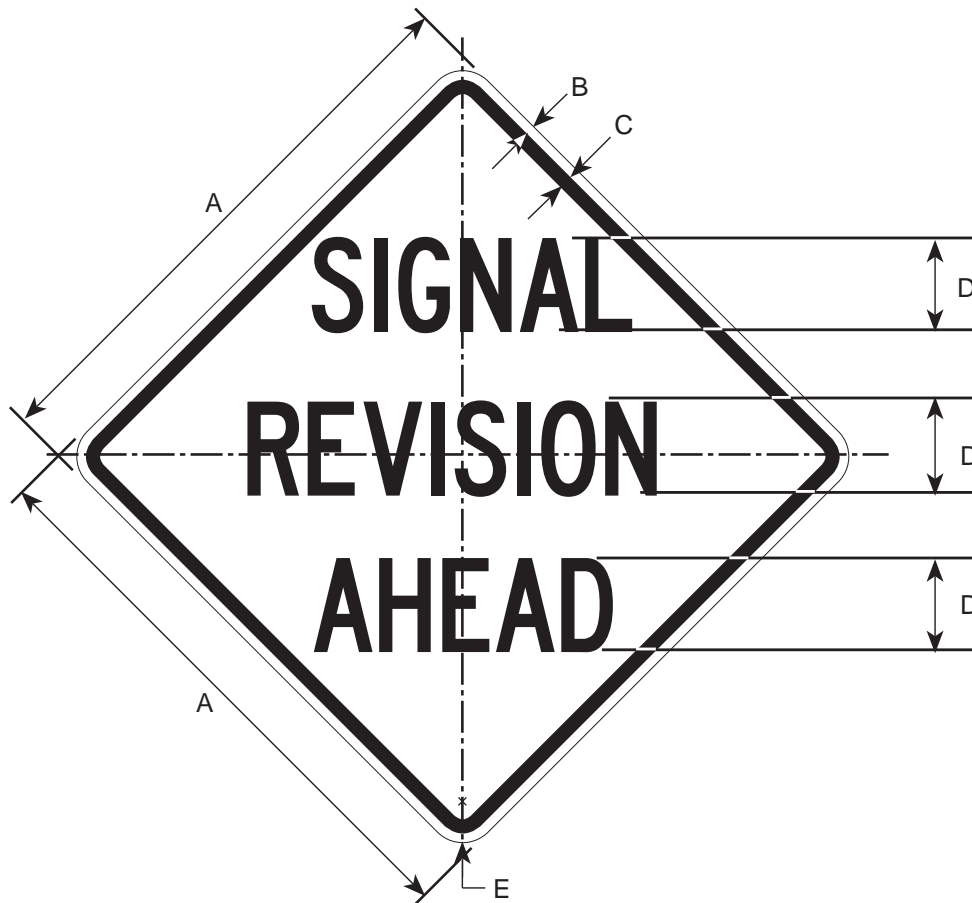

DIMENSIONS (MILLIMETERS)				
A	B	C	D	E
900	16	22	150C	56
1200	19	31	175C	75

DIMENSIONS (INCHES)				
A	B	C	D	E
36	5/8	7/8	6C	2 1/4
48	3/4	1 1/4	7C	3

COLORS

LEGEND - BLACK (NON-REFL)
BACKGROUND - ORANGE (REFL)

W21-1A

11/97

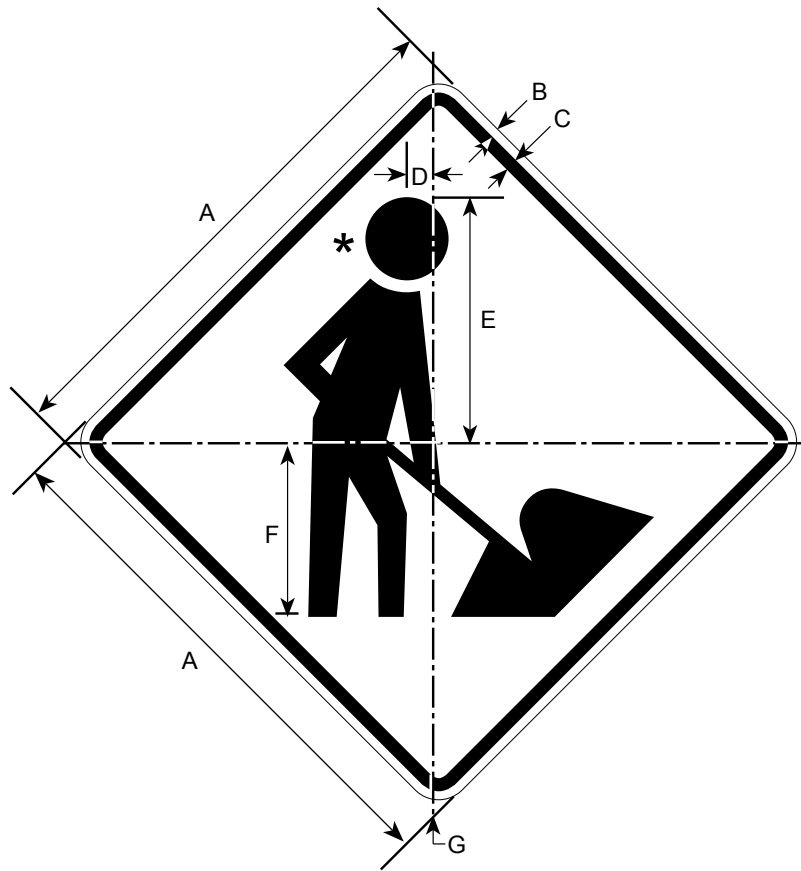

* SEE APPENDIX FOR SYMBOL DESIGN

DIMENSIONS (MILLIMETERS)						
A	B	C	D	E	F	G
900	13	19	47	350	250	47
750	16	22	56	422	300	56
1200	19	31	75	559	400	75

DIMENSIONS (INCHES)						
A	B	C	D	E	F	G
30	1/2	3/4	1 7/8	14	10	1 7/8
36	5/8	7/8	2 1/4	16 7/8	12	2 1/4
48	3/4	1 1/4	3	22 3/8	16	3

COLORS

LEGEND - BLACK (NON-REFL.)
BACKGROUND - ORANGE (REFL.)

W21-2

11/97

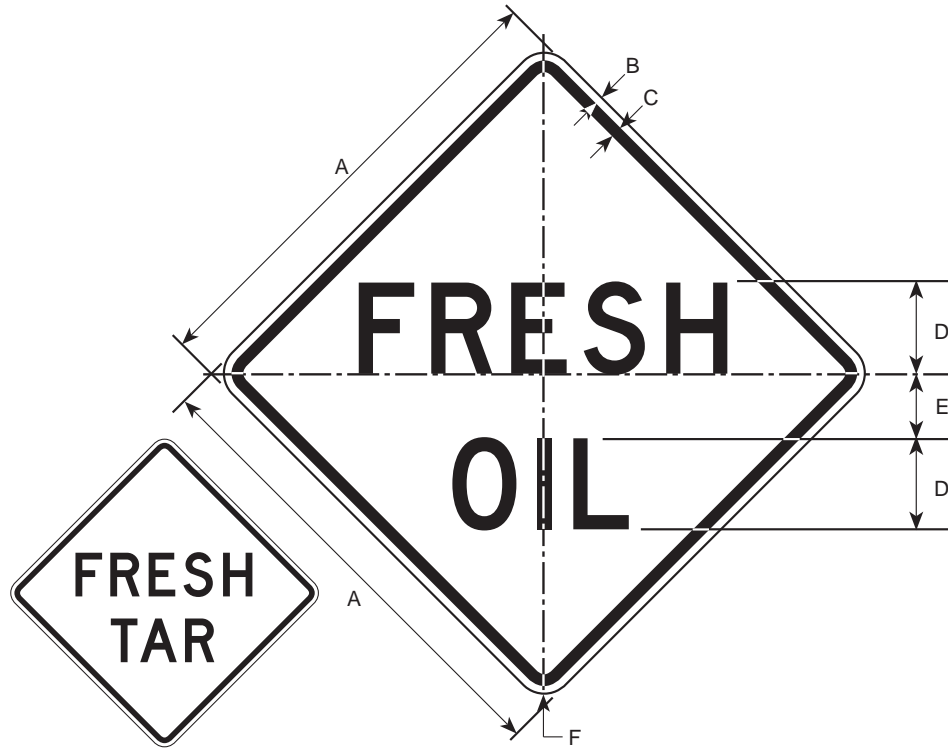

ALTERNATE

DIMENSIONS (MILLIMETERS)					
A	B	C	D	E	F
600	9	16	125D	75	38
750	13	19	150D	100	47
900	16	22	175D	125	56
1200	22	28	225D	175	75

DIMENSIONS (INCHES)					
A	B	C	D	E	F
24	3/8	5/8	5D	3	1 1/2
30	1/2	3/4	6D	4	1 7/8
36	5/8	7/8	7D	5	2 1/4
48	7/8	1 1/8	9D	7	3

COLORS

LEGEND - BLACK (NON-REFL.)
BACKGROUND - ORANGE (REFL.)

W21-3

11/97

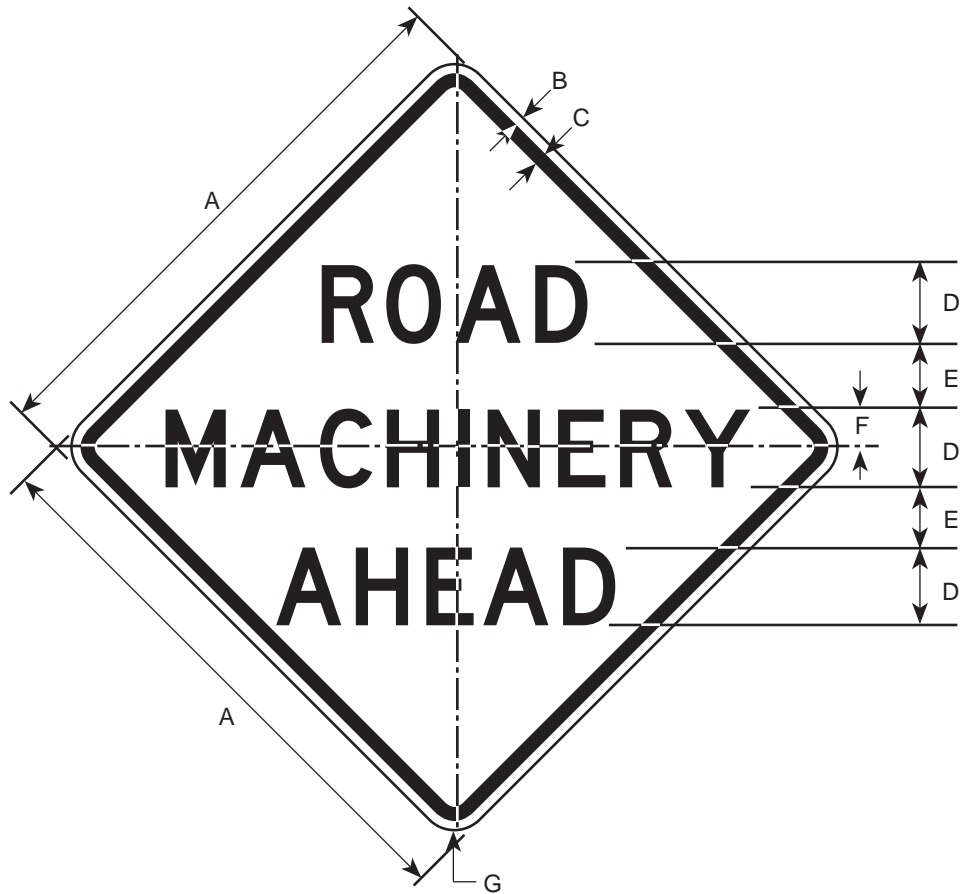

DIMENSIONS (MILLIMETERS)						
A	B	C	D	E	F	G
750	13	19	100D	88	50	47
900	16	22	125D	100	56	56
1200	19	31	175D	125	88	75

DIMENSIONS (INCHES)						
A	B	C	D	E	F	G
30	1/2	3/4	4D	3 1/2	2	1 7/8
36	5/8	7/8	5D	4	2 1/2	2 1/4
48	3/4	1 1/4	7D	5	3 1/2	3

COLORS

LEGEND - BLACK (NON-REFL)
 BAKCGROUND - ORANGE (REFL)

W21-30

11/97

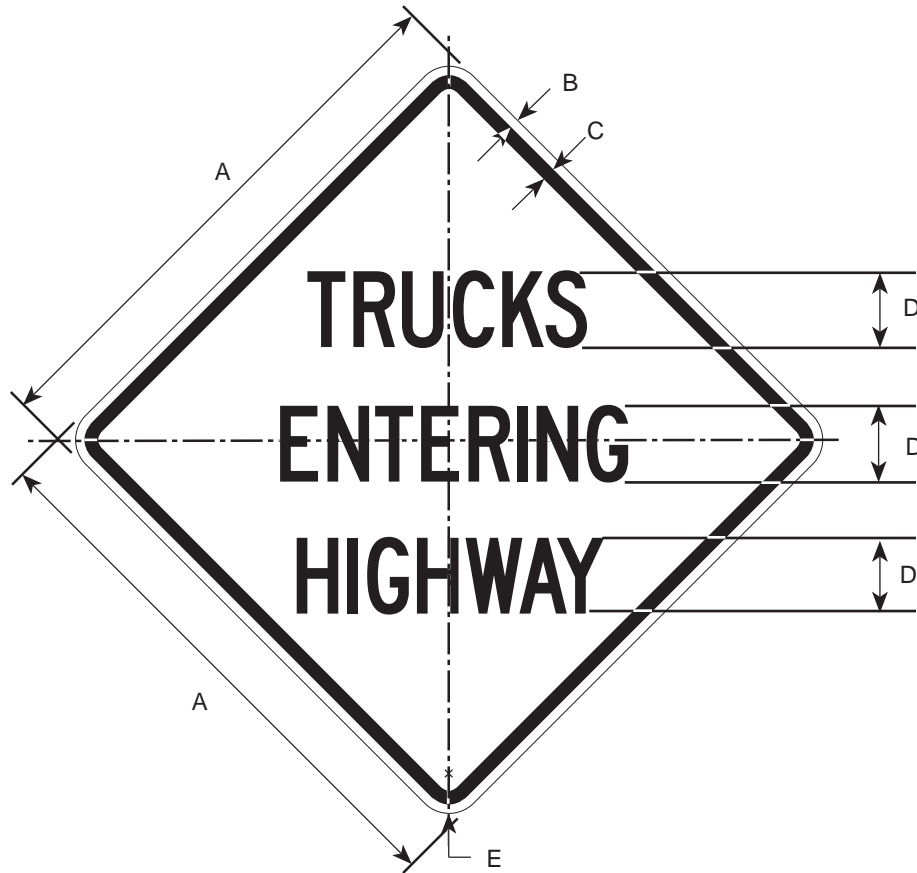

DIMENSIONS (MILLIMETERS)				
A	B	C	D	E
900	16	22	125C	63
1200	19	31	175C	88

DIMENSIONS (INCHES)				
A	B	C	D	E
36	5/8	7/8	5C	2 1/4
48	3/4	1 1/4	7C	3

COLORS

LEGEND - BLACK (NON-REFL)
BACKGROUND - ORANGE (REFL)

W21-30A

11/97

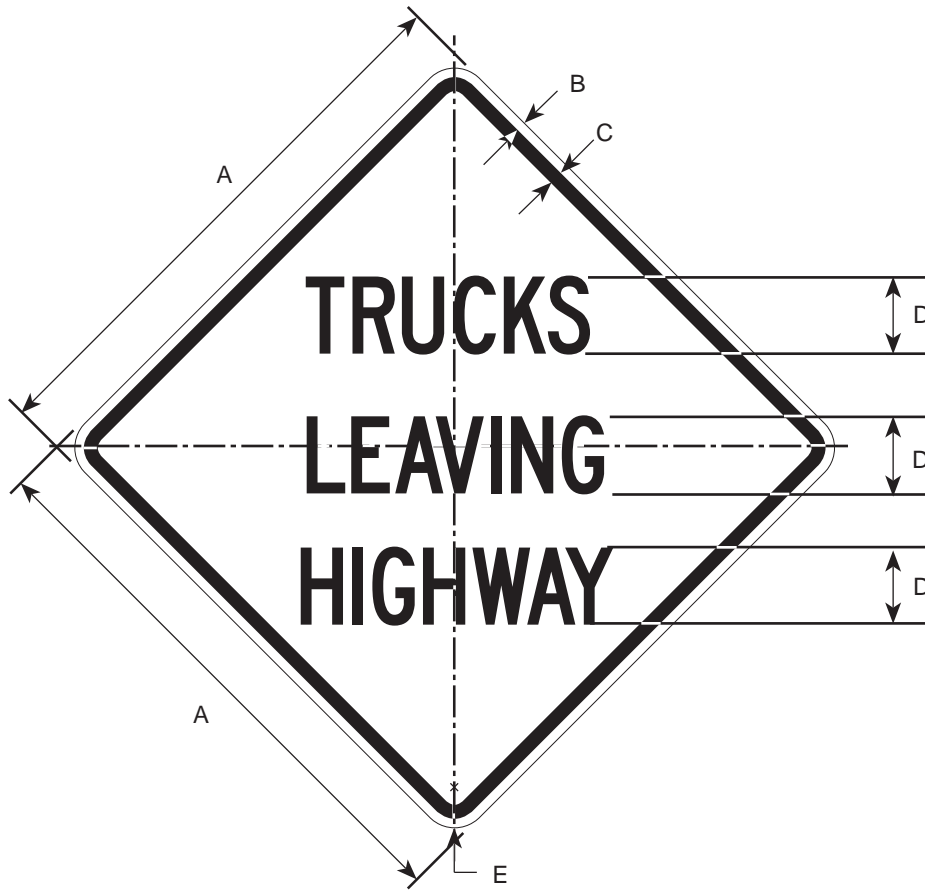

DIMENSIONS (MILLIMETERS)				
A	B	C	D	E
900	16	22	125C	63
1200	19	31	175C	88

DIMENSIONS (INCHES)				
A	B	C	D	E
36	5/8	7/8	5C	2 1/4
48	3/4	1 1/4	7C	3

COLORS

LEGEND - BLACK (NON-REFL)
 BACKGROUND - ORANGE (REFL)

W21-5

11/97

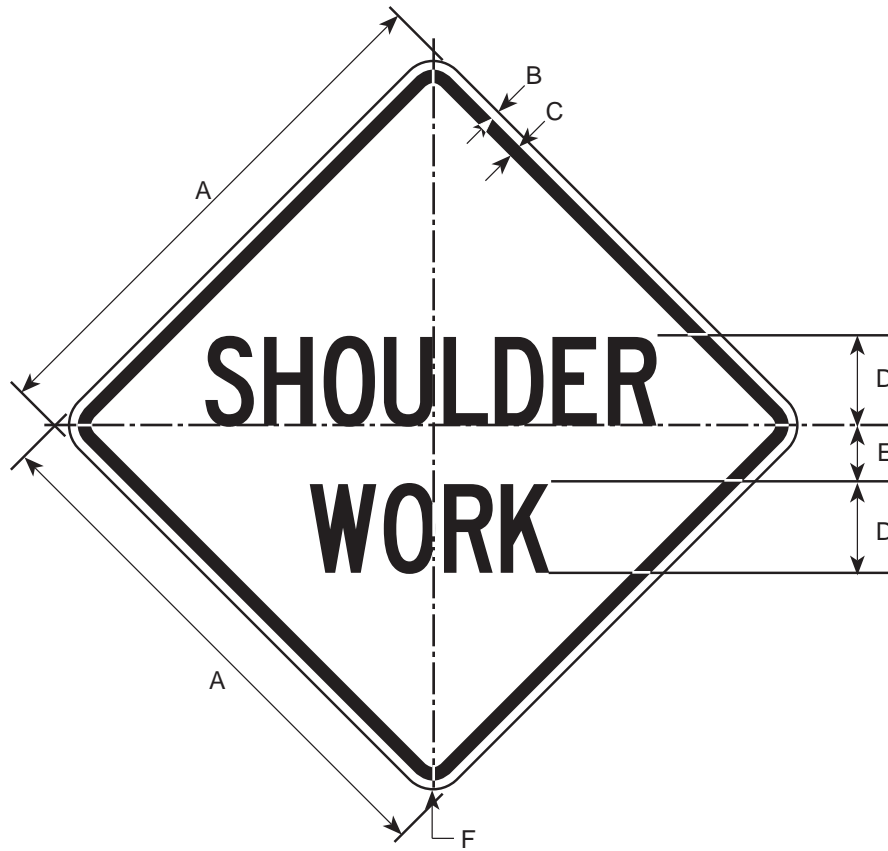

DIMENSIONS (MILLIMETERS)					
A	B	C	D	E	F
600	9	16	100C	63	38
750	13	19	125C	75	47
900	16	22	150C	88	56
1200	19	31	200C	11	75

DIMENSIONS (INCHES)					
A	B	C	D	E	F
24	3/8	5/8	4C	2 1/2	1 1/2
30	1/2	3/4	5C	3	1 7/8
36	5/8	7/8	6C	3 1/2	2 1/4
48	3/4	1 1/4	8C	4 1/2	3

COLORS

LEGEND - BLACK (NON-REFL.)
 BAKCGROUND - ORANGE (REFL.)

W21-6

11/97

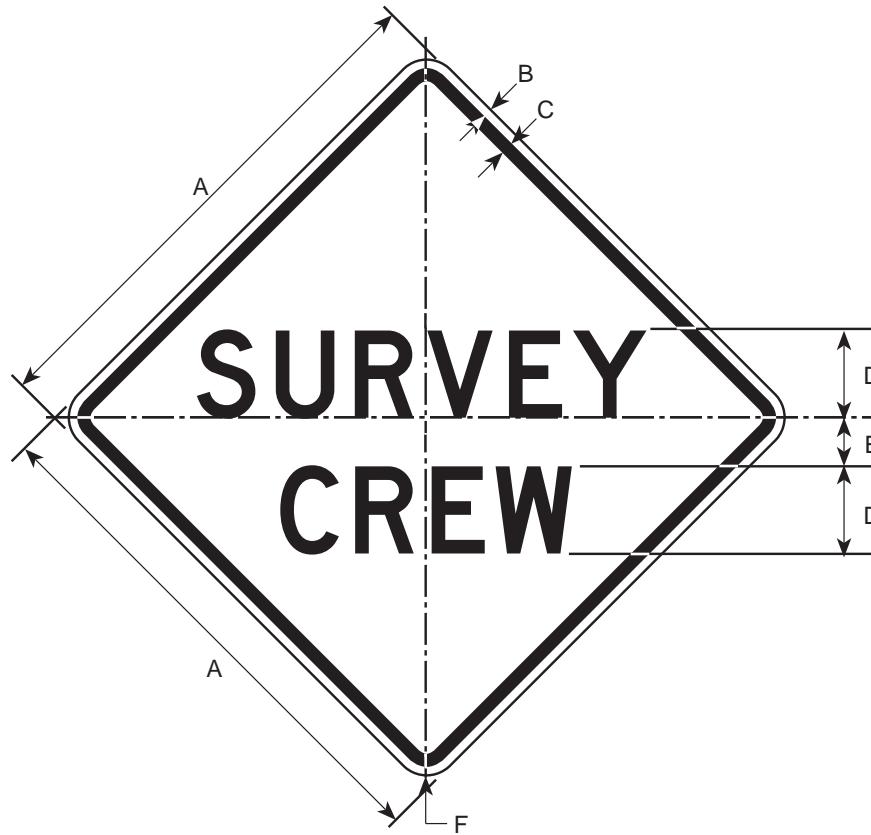

DIMENSIONS (MILLIMETERS)					
A	B	C	D	E	F
600	9	16	100D	63	38
750	13	19	125D	75	47
900	16	22	150D	88	56
1200	19	31	200D	11	75

DIMENSIONS (INCHES)					
A	B	C	D	E	F
24	3/8	5/8	4D	2 1/2	1 1/2
30	1/2	3/4	5D	3	1 7/8
36	5/8	7/8	6D	3 1/2	2 1/4
48	3/4	1 1/4	8D	4 1/2	3

COLORS

LEGEND - BLACK (NON-REFL.)
 BACKGROUND - ORANGE (REFL.)

W21-701

11/97

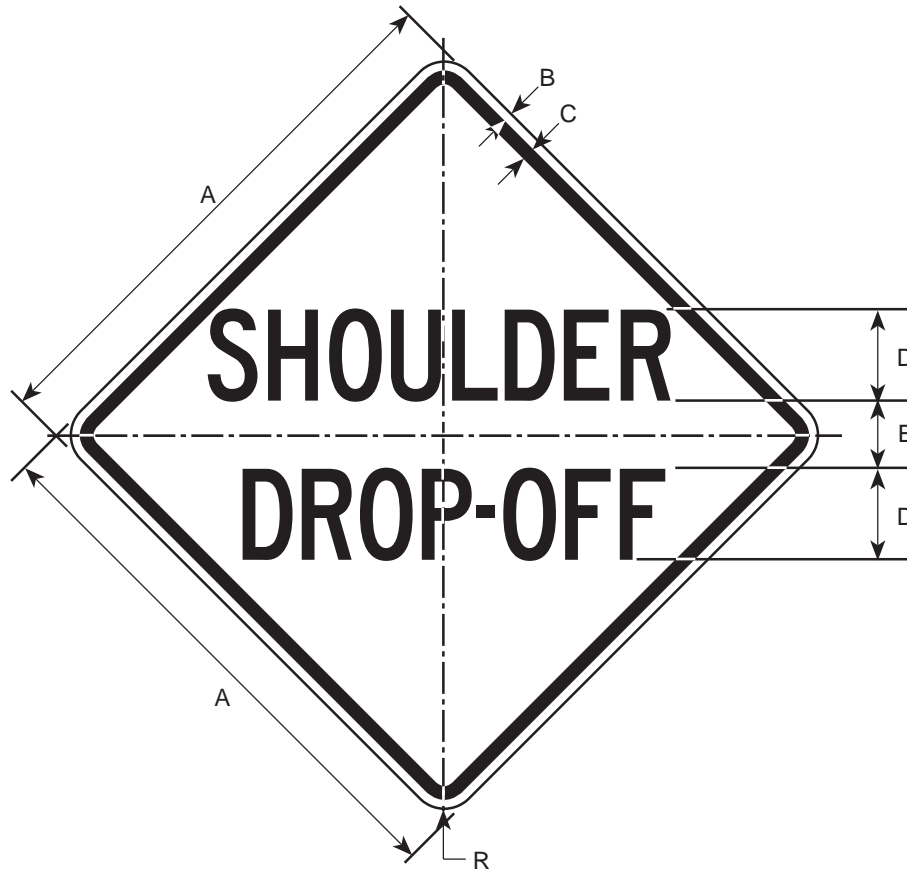

DIMENSIONS (MILLIMETERS)					
A	B	C	D	E	R
600	9	16	100C	69	38
750	13	19	125C	94	47
900	16	22	150C	111	56
1200	19	31	175C	150	75

DIMENSIONS (INCHES)					
A	B	C	D	E	R
24	3/8	5/8	4C	2 3/4	1 1/2
30	1/2	3/4	5C	3 3/4	1 7/8
36	5/8	7/8	6C	4 1/2	2 1/4
48	3/4	1 1/4	7C	6	3

COLORS

LEGEND - BLACK (NON-REFL.)
BACKGROUND - ORANGE (REFL.)

W21-801

11/97

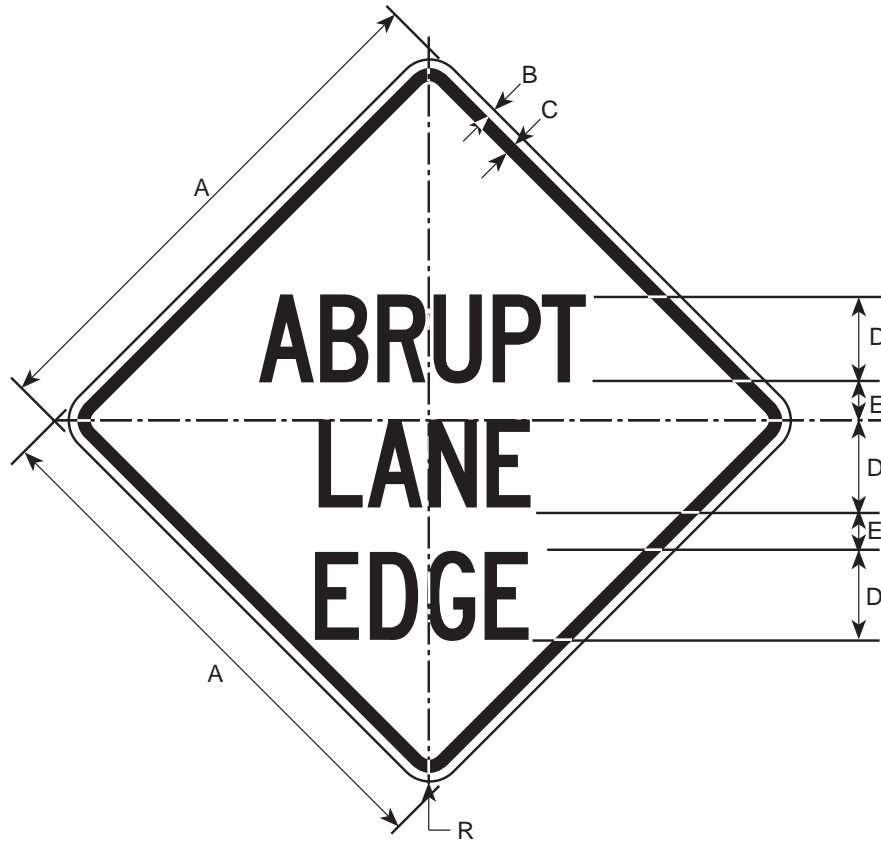

DIMENSIONS (MILLIMETERS)					
A	B	C	D	E	R
600	9	16	100C	44	38
750	13	19	125C	47	47
900	16	22	150C	69	56
1200	19	31	200C	88	75

DIMENSIONS (INCHES)					
A	B	C	D	E	R
24	3/8	5/8	4C	1 3/4	1 1/2
30	1/2	3/4	5C	2 1/4	1 7/8
36	5/8	7/8	6C	2 3/4	2 1/4
48	3/4	1 1/4	8C	3 1/2	3

COLORS

LEGEND - BLACK (NON-REFL.)
BACKGROUND - ORANGE (REFL.)

W21-901

11/97

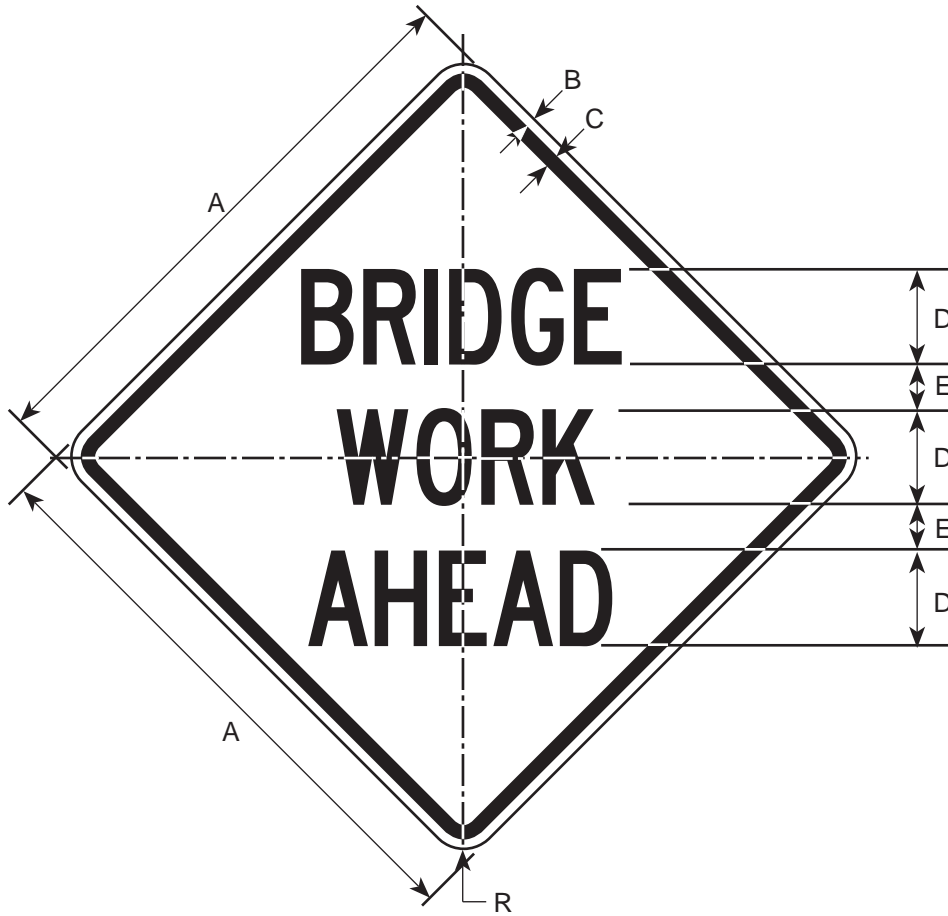

DIMENSIONS (MILLIMETERS)					
A	B	C	D	E	R
900	16	22	150C	69	56
1200	19	31	200C	88	75

DIMENSIONS (INCHES)					
A	B	C	D	E	R
36	5/8	7/8	6-C	2 3/4	2 1/4
48	3/4	1 1/4	8-C	3 1/2	3

COLORS

LEGEND - BLACK (NON-REFL.)
BACKGROUND - ORANGE (REFL.)

W21-1001

11/97

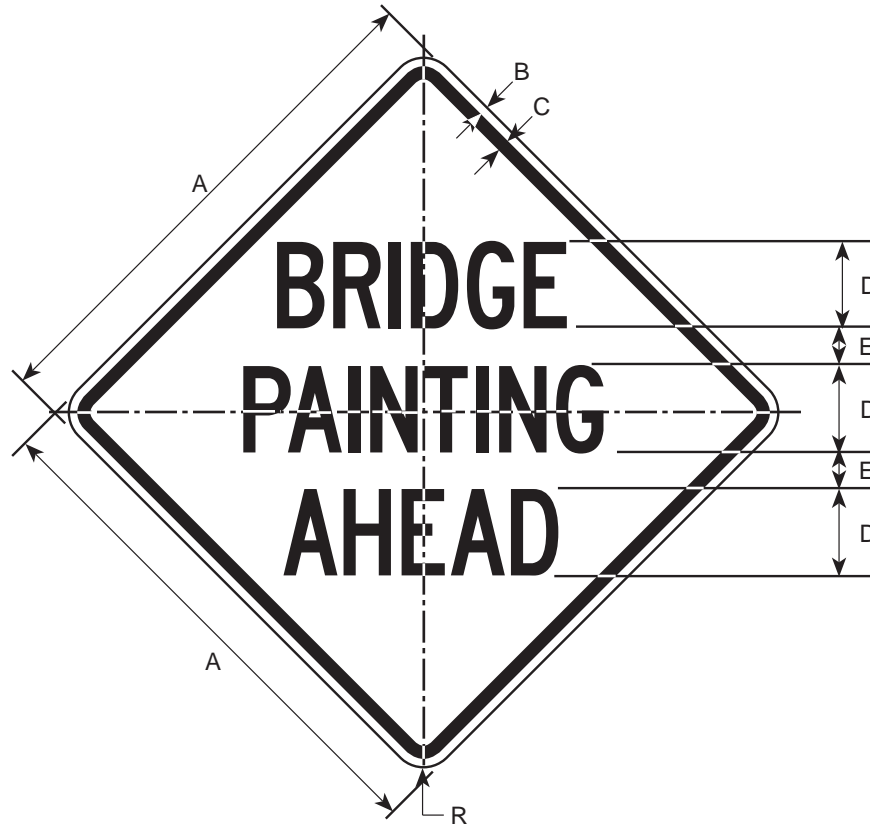

DIMENSIONS (MILLIMETERS)					
A	B	C	D	E	R
600	9	16	100C	44	38
750	13	19	125C	47	47
900	16	22	150C	69	56
1200	19	31	200C	88	75

DIMENSIONS (INCHES)					
A	B	C	D	E	R
24	3/8	5/8	4C	1 3/4	1 1/2
30	1/2	3/4	5C	2 1/4	1 7/8
36	5/8	7/8	6C	2 3/4	2 1/4
48	3/4	1 1/4	8C	3 1/2	3

COLORS

LEGEND - BLACK (NON-REFL.)
BACKGROUND - ORANGE (REFL.)

W21-1201

6/03

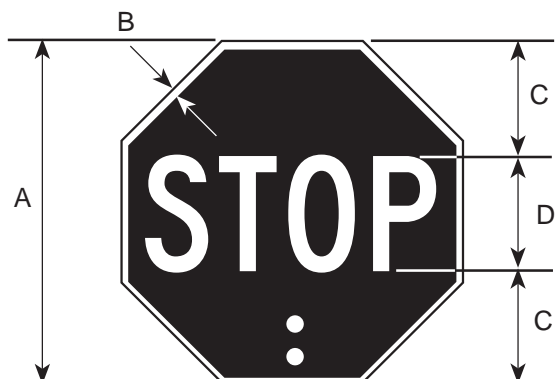

DIMENSIONS (MILLIMETERS)									
A	B	C	D	E	F	G	H	J	PADDLE THICKNESS
450	9	150	150C	350	150B	9	75	50	1
650	16	200	200C	450	150C	9	75	50	2

DIMENSIONS (INCHES)									
A	B	C	D	E	F	G	H	J	PADDLE THICKNESS
18	3/8	6	6C	14	6B	3/8	3	2	0.040
26	5/8	8	8C	18	6C	3/8	3	2	0.063

COLORS

STOP FACE - WHITE (REFL) ON RED (REFL)
 SLOW FACE - BLACK (NON-REFL) ON ORANGE (REFL)
 Type II grade sheeting is recommended.

. The area around the STOP face may be any non-reflective light color or black and the area around the SLOW face should be black.

Aluminum of the depth shown shall be used for the paddle material. Other material, when approved, may be used and shall exhibit comparable rigidity and durability values.

NOTE; Flagmans paddles shall have reflectorized faces unless otherwise requested or indicated.

W21-1202

11/97

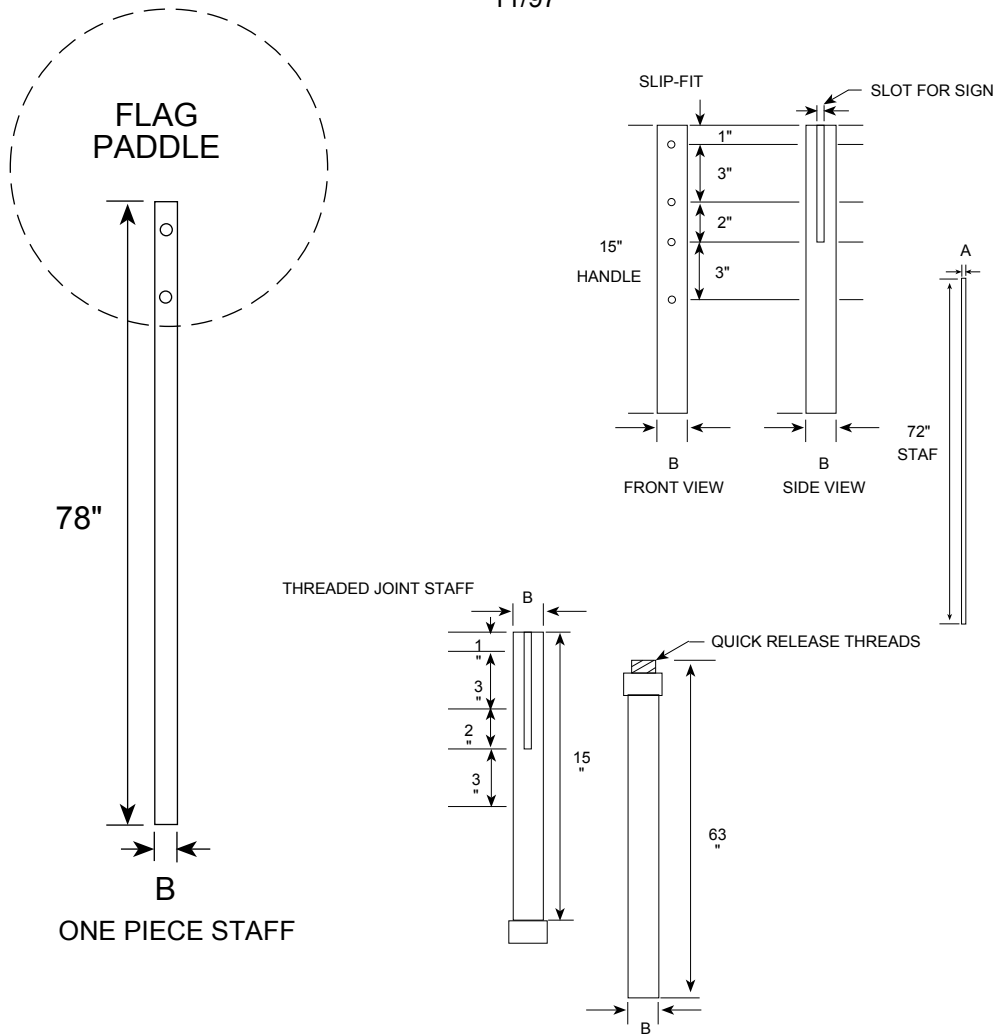

MILLIMETERS

ALUMINUM TUBING SLIP-FIT STAFF		STD. ALUMINUM PIPE SLIP-FIT STAFF		TYPE II 40 PVC COND. SLIP-FIT STAFF THREADED JT. STAFF			
A	B	A	B	A	B	A	B
31	38	25	31	25	31	N.A.	31

INCHES

ALUMINUM TUBING SLIP-FIT STAFF		STD. ALUMINUM PIPE SLIP-FIT STAFF		TYPE II 40 PVC COND. SLIP-FIT STAFF THREADED JT. STAFF			
A	B	A	B	A	B	A	B
1 1/4	1 1/2	1	1 1/4	1	1 1/4	N.A.	1 1/4

W21-1601

11/97

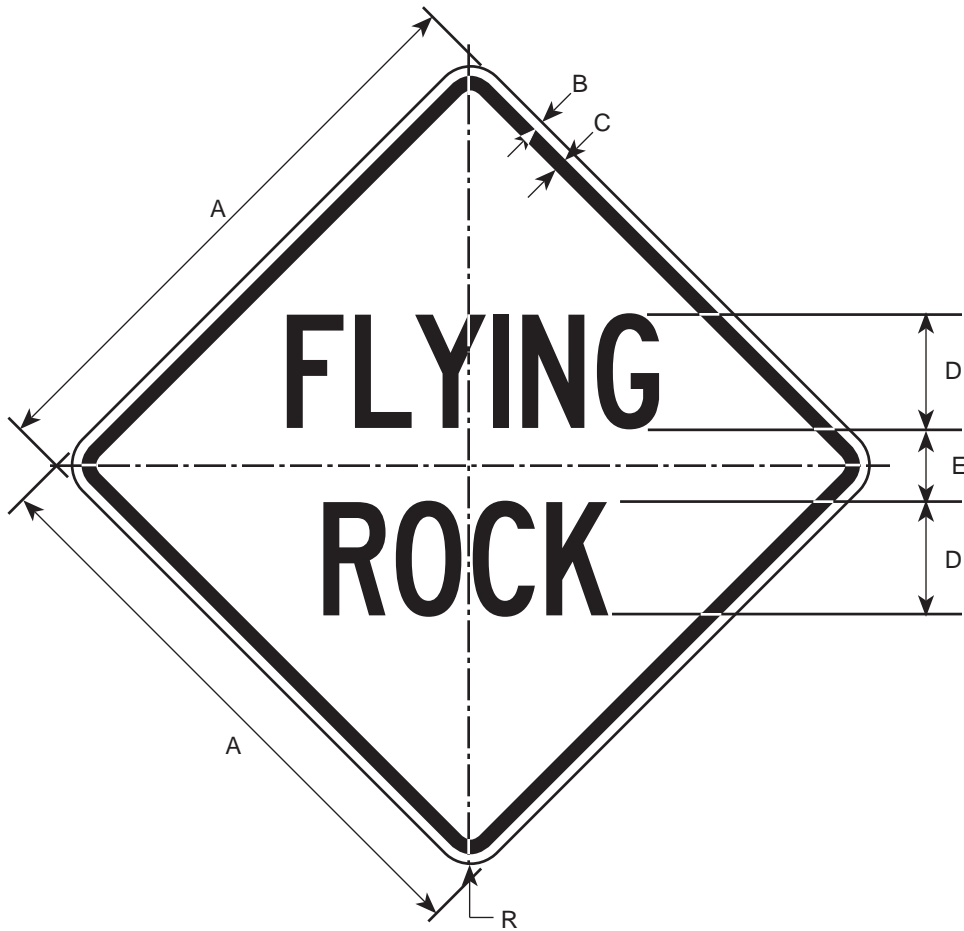

DIMENSIONS (MILLIMETERS)					
A	B	C	D	E	R
750	13	19	150C	100	47
900	16	22	175C	11	56
1200	19	31	200C	150	75

DIMENSIONS (INCHES)					
A	B	C	D	E	R
30	1/2	3/4	6C	4	1 7/8
36	5/8	7/8	7C	4 3/4	2 1/4
48	3/4	1 1/4	8C	6	3

COLORS

LEGEND - BLACK (NON-REFL.)
BACKGROUND - ORANGE (REFL.)

W21-1701

5/06

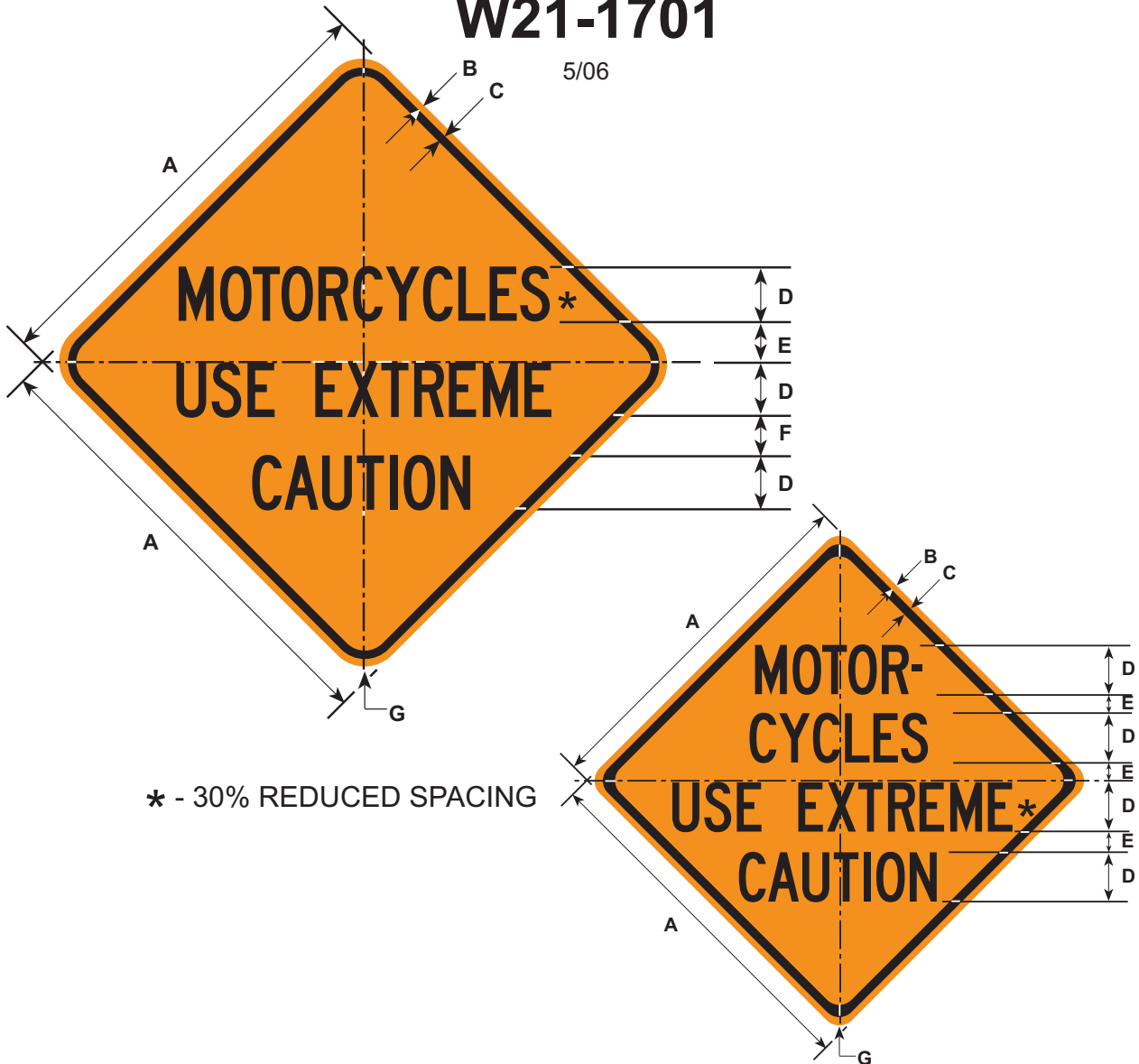

* - 30% REDUCED SPACING

DIMENSIONS (MILLIMETERS)						
A	B	C	D	E	F	G
900	16	22	125C	50	-	56
1200	19	31	150C	100	38	75

DIMENSIONS (INCHES)						
A	B	C	D	E	F	G
36	5/8	7/8	5C	2	-	2 1/4
48	3/4	1 1/4	6C	2 1/4	3 3/8	3

COLORS

LEGEND—BLACK (NON-REFL)
BACKGROUND—ORANGE (REFL)

W22-1

12/94

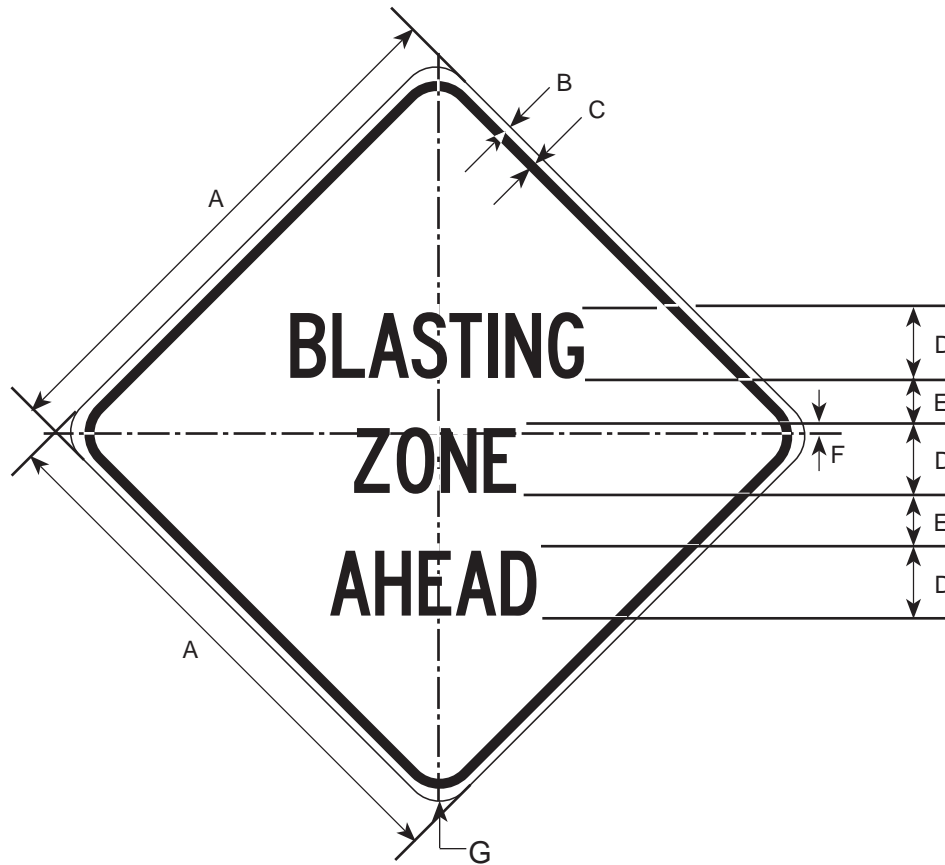

DIMENSIONS (MILLIMETERS)						
A	B	C	D	E	F	G
900	16	22	125C	75	25	56
1200	19	31	175C	100	38	75

DIMENSIONS (INCHES)						
A	B	C	D	E	F	G
36	5/8	7/8	5C	3	1	2 1/4
48	3/4	1 1/4	7C	4	1 1/2	3

COLORS

LEGEND - BLACK (NON-REFL)

BACKGROUND - ORANGE (REFL)

W22-2

11/97

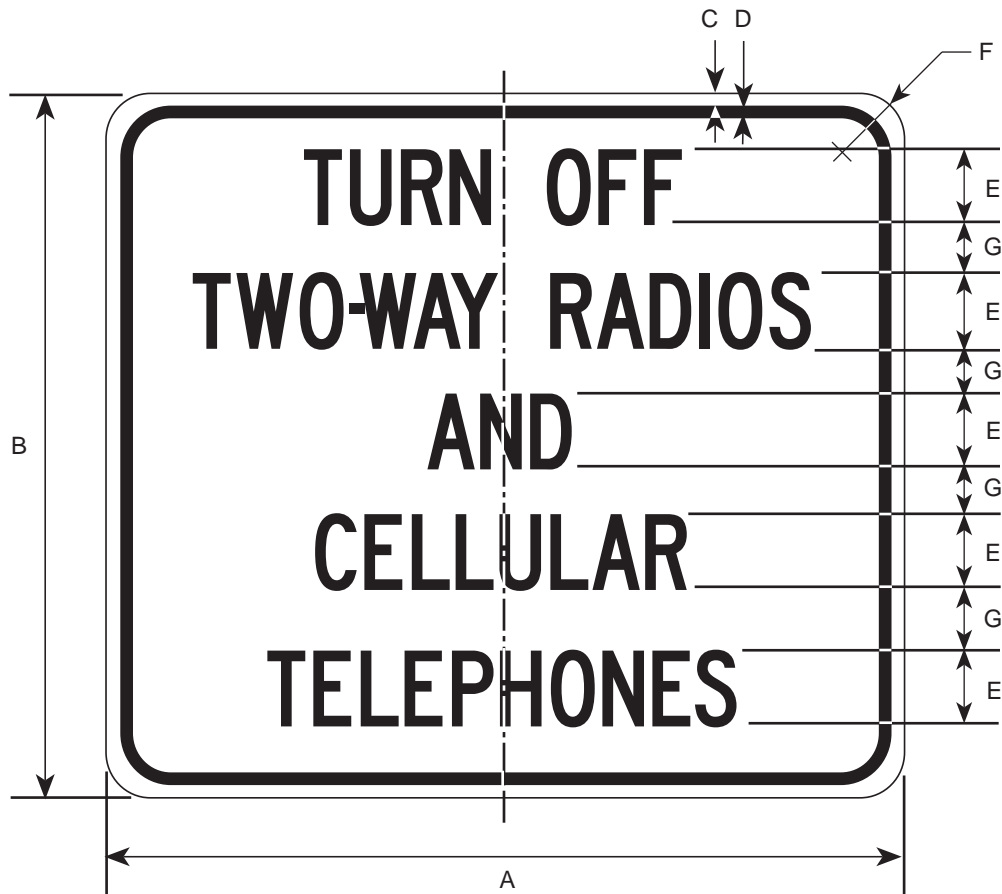

DIMENSIONS (MILLIMETERS)						
A	B	C	D	E	F	G
1050	900	16	22	100C	75	50

DIMENSIONS (INCHES)						
A	B	C	D	E	F	G
48	36	5/8	7/8	4C	3	2

COLORS

LEGEND - BLACK (NON-REFL)
BACKGROUND - ORANGE (REFL)

W22-3

11/97



DIMENSIONS (MILLIMETERS)						
A	B	C	D	E	F	G
900	750	13	19	109	125C	47
1050	900	16	22	11	175C	56

DIMENSIONS (INCHES)						
A	B	C	D	E	F	G
36	30	1/2	3/4	4 3/8	5C	1 7/8
42	36	5/8	7/8	4 1/2	7C	2 1/4

COLORS

LEGEND - BLACK (NON-REFL)
BACKGROUND - ORANGE (REFL)

W24-101

11/97

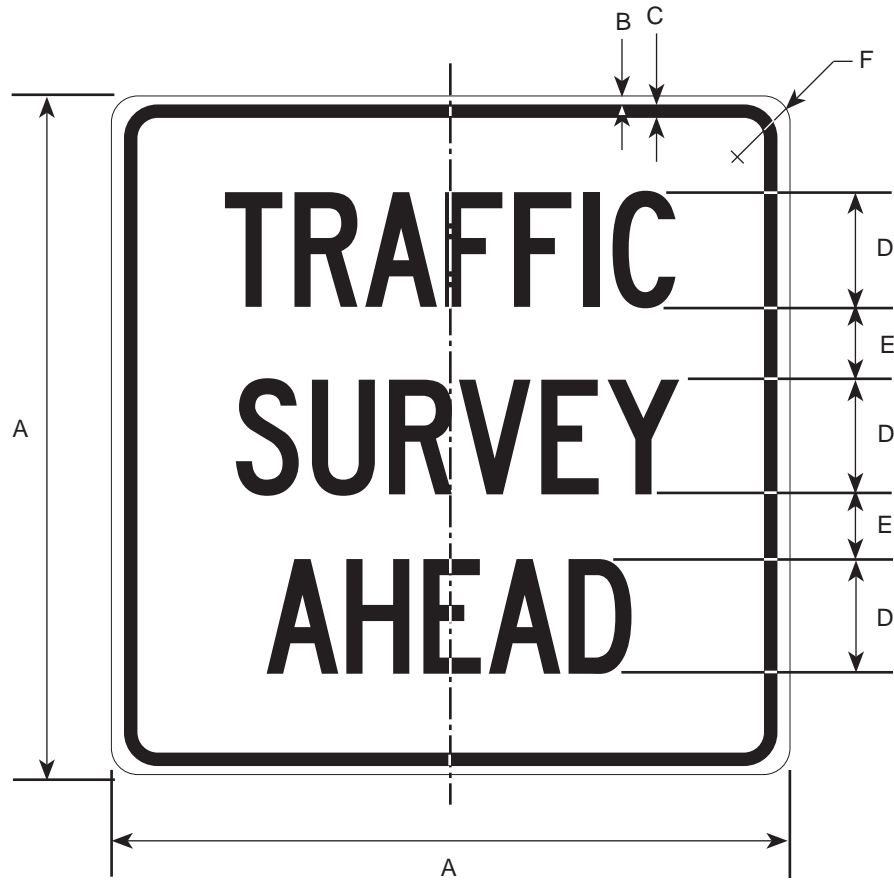

DIMENSIONS (MILLIMETERS)					
A	B	C	D	E	F
750	13	19	125C	78	47
900	16	22	150C	94	56
1200	19	31	175C	125	75

DIMENSIONS (INCHES)					
A	B	C	D	E	F
30	1/2	3/4	5C	3 1/8	1 7/8
36	5/8	7/8	6C	3 3/4	2 1/4
48	3/4	1 1/4	7C	5	3

COLORS

LEGEND - BLACK (NON-REFL)
BACKGROUND - ORANGE (REFL)

APPENDIX A-1

4/99

SIZING THE SIGN

General.

After the message length has been calculated and the desired layout determined, the designer must calculate the sign background size required for that display.

The following SPACING RULES for horizontal and vertical inter-line spacing conform to accepted practices, although some adjustment may be permitted in order to round off to the nearest whole foot. As stated before, legibility is dependent on letter size and optimum spacing so the sign size should be based on the optimum spacing.

Grade separation mounted signs should not project above the bridge rail. In order to reduce the vertical dimension of the sign it may be necessary to use a modified layout such as mounting the shield beside the destination name. From the aesthetic standpoint, the Department's policy is to make adjacent overhead signs facing the same direction all the same height.

While not a critical factor in determining sign size, the designer should take into consideration the commercial availability of background materials. Plywood and aluminum sheeting is available in sizes up to 5'0" x 12'0". Where the sign height exceeds 12'0" it will be necessary for the sign fabricator to utilize a horizontal splice.

By modifying the layout it may be possible to reduce the sign height to 12'0" and thereby avoid the horizontal splice.

If it is not possible to reduce the sign height, the designer must illustrate on the plan sheet where the splice is to be located. The desirable location is at the upper edge of a horizontal border strip separating two messages of the sign. Unless noted otherwise on the plans, the fabricator will use the longest panels in stock and shear additional panels to provide the necessary sign height.

Spacing Rules.

Five general categories of spacing formulae have been developed to ensure adequate legibility.

1. Between letters in a word.
2. Between words in a line.
3. Between lines of copy.
4. Edge spacing.
5. Fractions.

Letters in a word.

The amount of space that should be provided between two letters in a word is not constant, but varies with the shapes, sizes and series of the letters that are

APPENDIX A-2

11/03

involved. Tables F, G, and H provide letter spacing data as well as letter widths for highway signs. The space between the preceding letter and a period in an abbreviated word should be equal to the stroke width of that letter size and series, except that in the case of letters F, P, T, V, W and Y the left edge of the period shall be tangent to the widest part of the letter.

Words in a line.

Optimum spacing between words in a line should be equal to the height of the upper-case or capital letter in that line. The spacing between symbols such as arrows, shields, etc. and adjacent words should be equal to the capital letter height or 3/4 of the upper-case letter height in that line. The minimum shall not be less than 2/3 of the optimum.

The space between two letters used as initials, such as N.W., should be equal to that letter height. The period is then mounted within that space in accordance with the formula for abbreviated words.

The space between two hyphenated words should be $1\frac{1}{2}$ times the maximum letter height of the two words. The hyphen, which is 0.4 times the upper-case letter height, is centered between the words.

The space between letters of a destination such as "Coeur d'Alene" should be equal to the lower-case letter height with the apostrophe installed within that space.

Lines of copy.

The optimum spacing between two lines of copy, whether destination names, shields or arrows should be equal to the upper-case or capital letter height of the sign message.

The minimum shall not be less than 2/3 of the optimum.

Edge spacing.

The optimum edge spacing shall be equal to the upper-case or capital letter height, whichever is greater, in that line.

The minimum shall not be less than 2/3 of the optimum.

Fractions.

Fractions should be treated as a unit and not as separate characters. This unit is called the "fraction rectangle" which consists of the numerals and diagonal.

The diagonal length is 1.7 times the fraction numeral height; its width is equal to the stroke width of the numeral and is mounted at an angle of 60° from the horizontal.

The width of the fraction rectangle is $2\frac{1}{2}$ times the fraction numeral height except when the upper numeral is "1", in which case its width is 2 times the numeral height.

APPENDIX A-3

01/95

The spacing between a preceding or following letter and the fraction rectangle or a whole number should be equal to the fraction numeral height.

For guide sign action messages, the fraction numeral size is equal to the capital letter size in the adjacent action message while the "rectangle" height is $1\frac{1}{2}$ times the fraction numeral size. The whole number height is 15" for a 16"u.c./12"l.c. destination; 12" for a 13-1/3"/10" legend; 10" for a 10-2/3"/8" legend and 8" for a 8"/6" legend. For mileage signs the numeral series and size shall be upper-case numerals of the same size used in the destination name. For interchange sequence signs the whole number size shall be the same as the upper-case letter size in the destination while the fraction numeral size shall be equal to the lower-case letter height. Numeral series on mileage and sequence signs shall be series-E modified.

Border Widths

Borders are required on all signs for aesthetic considerations. The border width is dependent on the general sign type; whether control or guide. Sign borders have been more or less standardized and are approximately equal to the letter stroke width.

Margin Widths

The use of margins between the border and the sign edge is also generally dependent on sign type. Specifically, margins are not used where the border is lighter in color than the sign background. Signs with darker borders are normally made by silk screen painting and the margin acts as a buffer to prevent overspill of the paint. Margin widths, when required, are about 3/4 of the border width.

Corner Radii

Since control signs are quite often located in areas accessible to pedestrians it is mandatory to round all corners (except STOP signs) in order to prevent injury. Control sign corner radii has been standardized according to sign size. Guide signs are normally above pedestrian traffic and rounded corners are not necessary. However, the border at each corner is rounded for aesthetics and the border radius is approximately equal to 1/8 of the sign height. The radius is then established to the nearest 3" with a maximum of 12"

Border, Margin and Corner Radius Dimensions

Sign Size	Border	Margin	Cor. Rad.	Sign Letter Size	Border
12"x18"	3/8"	3/8"		6" caps	3/4"
18"x18"	3/8"	3/8"	1 1/2"	6"u.c./4 1/2"l.c.	1"
18"x24"	5/8"	3/8"	1 1/2"	8"u.c./6"l.c.	1 1/2"
24"x24"	5/8"	3/8"	1 1/2"	10 2/3"u.c./8"l.c.	1 1/2"
24"x30"	5/8"	3/8"	1 1/2"	13 1/3"u.c./10"l.c.	2"
30"x30"	3/4"	1/2"	1 1/2"	16"u.c./12"l.c.	2"
30"x36"	3/4"	1/2"	1 7/8"		
36"x36"	7/8"	5/8"	1 7/8"	Sign Height	Cor. Rad.
36"x48"	7/8"	5/8"	2 1/4"	2'	3"
48"x48"	1 1/4"	3/4"	2 1/4"	4'	6"
48"x60"	1 1/4"	3/4"	3"	6'	9"
				8'	

APPENDIX A-4

01/95

SIGN LEGEND LAYOUT

Word Placement.

Messages should generally be centered about the vertical axis of the sign background. Exceptions include mileage and interchange sequence signs which have equal margins left and right for all lines of copy regardless of message length.

Insofar as practical, the layout and placement of messages on advance and exit direction signs shall be similar.

The arrangement of messages depends on the type of sign. For mileage signs the correct order places the nearest destination at the top and the furthestmost destination at the bottom of the sign. Directional sign message placement depends on destination direction. Through destination at the top, left destinations next and right destinations at the bottom.

Route shields may be located either above or beside the destination. Words such as TO, JCT and cardinal directions may be placed either above or beside the route shields. When placed above the shield the word shall be centered about the vertical axis of the shield. When placed beside the shield the top of the word shall be on the same horizontal line as the top of the shield. The words TO and JCT shall be located to the left of the shield while cardinal directions and BUSINESS shall be located to the right of the shield to which it applies.

Arrow Placement.

Arrow placement is critical since it implies the direction and, as a consequence, the navigational maneuver to be taken by the driver. Arrow placement angle should point approximately at the same angle as the ramp or turn departure, i.e. horizontal arrows for right angle connections.

To indicate a direction straight ahead, the arrow should be mounted vertically and to the left of the copy on a ground mounted sign.

To indicate a left turn, the arrow should be mounted horizontally and to the left of or below the destination.

To indicate a right turn, the arrow should be mounted horizontally and to the right of or below the destination.

For overhead signs straight ahead directions may be indicated by either an up arrow or a down arrow. Down arrows should be used only where specific lane assignment is necessary or where horizontal or vertical alignment or interchange complexity prevents the motorist from readily distinguishing the through direction.

The desired location of arrows on exit direction signs is beside the destination, whether ground mounted or overhead, although it is permissible to mount the arrow below the destination.

APPENDIX A-5

01/95

Separation of Messages.

In a multi-direction sign, the distinction between the directions must be defined sharply. A common source of confusion can arise when a two direction guide sign lacks proper separation, since a surprisingly large number of people read the sign vertically, i.e. they read the upper line arrow with the bottom line of copy.

Separation of directions should be accomplished by the use of horizontal border strips. Certain destination names when located without proper consideration may be interpreted incorrectly by the unfamiliar motorist. For example "Vancouver Mall Drive" when installed on two lines, "Vancouver" on the first and "Mall Drive" on the second, could be read as two destinations "Vancouver" and "Mall Drive" when it was intended to be one destination. In this example, the proper arrangement would be to install "Vancouver Mall" on the first line and "Drive" on the second line.

Conversely, the motorist may read a sign message as a single destination when it was intended to be two destinations, for example, "Chehalis Fairgrounds". In this example, the proper layout would include a border strip between the two destinations. The length of this border strip should be approximately equal to the length of the shorter destination message.

APPENDIX A-6

10/03

MINIMUM SPACINGS FOR GUIDE SIGN

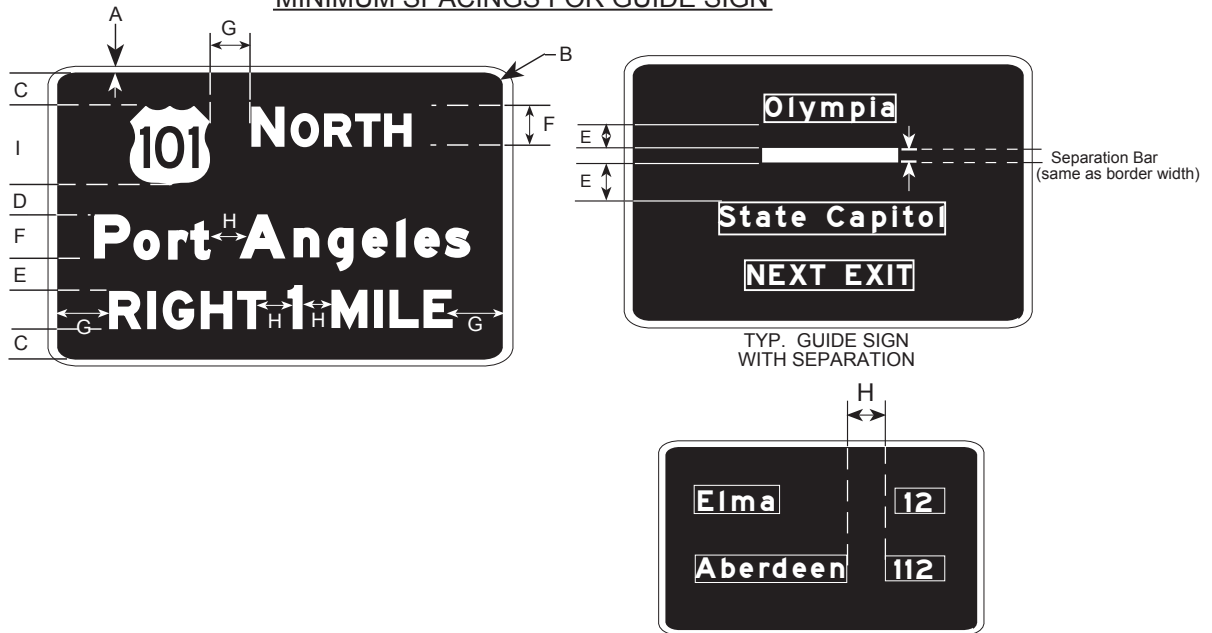

TYP. GUIDE SIGN WITH SEPARATION

SEE E 7-1 FOR VERTICAL SPACING

GENERAL

A. The border gives the sign a finished appearance and makes it more conspicuous. If the background is a darker color than the copy and border, the border should be positioned on the edge of the sign. The width of the border should be approximately 1/3 to 3/4 the width of the stroke of the largest letter.

B. Corner radii of the sign borders should be approximately 1/8 of the lesser side dimension but should not exceed 12". When prefabricated reflective border and corner sections are employed, sizes should be selected that reasonably conform to the sign size requirements. The sign area outside the corner radius need not be trimmed.

HEIGHT OF SIGN FACE:

C. Spacing to the top and bottom borders should be approximately equal to the average letter height of the adjacent line of copy.

D. The spacing between route markers or arrows and tops of capital or upper case letters in the adjacent line of copy, should be approximately equal to 1/2 the height of the largest capital or upper case letters on the sign.

E. The interline spacing between tops and bottoms of capital or upper case letters should be approximately 3/4 of the average of the heights of the capital or upper case letters in adjacent lines of copy.

F. Letter Height of capital letters as prescribed in the MUTCD or the state sign fabrication manual.

LENGTH OF SIGN:

To obtain length of sign, first determine letter size to be used in the longest line of copy, then figure length of that line by referring to appropriate tables.

G. Each line of copy should be "Visually Centered" within the sign borders. The spacing between the left border and the left letter, numeral or arrow of the longest line of copy and right border and right letter, numeral or arrow of the same line of copy is to be approximately equal to the height of the upper case letter in that line of copy. Shorter lines of copy should be "Visually Centered" on the sign. "Visual Spacing" the letter shapes at each end of a line of copy determine the position that gives visual balance. A line of copy with open, curved or slanted letter side at each end should be centered in the sign face (Ex; JACKS) . If the line has straight side letters at each end, it is also centered (Ex; BARTON) . A line of copy with open, curved or slanted letters at one end and straight side letters at the other end should be shifted toward the open, curved or slanted letter side until the line of copy appears "Visually Balanced" in the sign face (Ex; ISLE) .

H. Spacing between words and arrow, or a word and a numeral, in a line of copy should be approximately equal to the capital or upper case letter height used in that line of copy.

I. Shield size as per the Sign Fabrication Manual.

APPENDIX A-7

6/06

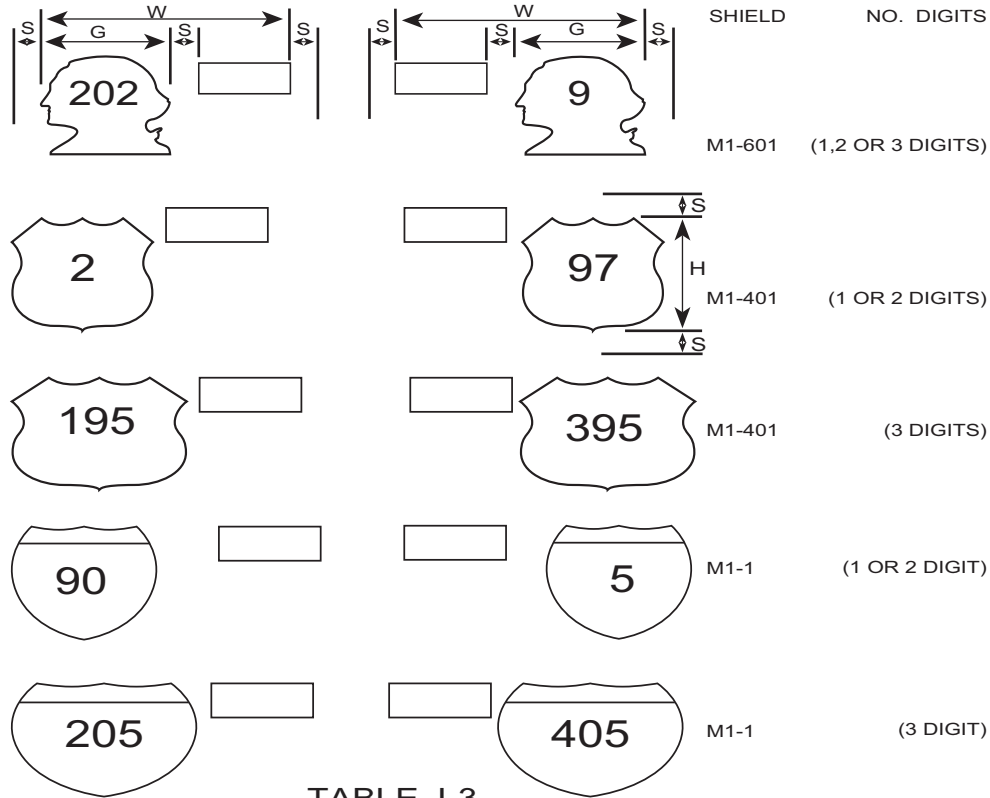

TABLE J-3

SHIELD CODE	SIZE CODE	SHIELD SIZE G X H	DIMENSIONS (MILLIMETERS) "W"							" S "
			NORTH	SOUTH	EAST	WEST	JCT	T		
M1-602	A	408 X 450	1300	1300	1150	1200	975	800	150	
	B	544 X 600	1775	1775	1575	1600	1300	1050	200	
	C	830 X 900	2325	2325	2100	2125	1725	1425	250	
	D OR E	830 X 900	2650	2650	2375	2400	1925	1575	300	
M1-1 M1-401	A	450 X 450	1375	1375	1225	1250	1050	875	150	
	A	563 X 450	1500	1500	1350	1375	117	1000	150	
	B	600 X 600	1825	1825	1625	1650	1400	115	200	
	B	750 X 600	1975	1975	1775	1800	1550	1300	200	
	C	900 X 900	2425	2425	2175	2200	1900	1600	250	
	C	1125 X 900	2650	2650	2400	2425	2125	1825	250	
	D OR E	900 X 900	2750	2750	2425	2475	2100	1750	300	
	D OR E	1125 X 900	2975	2975	2650	2700	2325	1975	300	

SHIELD CODE	SIZE CODE	SHIELD SIZE G X H	DIMENSIONS (INCHES) "W"							" S "
			NORTH	SOUTH	EAST	WEST	JCT	TO		
M1-602	A	16 5/16 X 18	52	52	46	48	39	32	6	
	B	21 3/4 X 24	71	71	63	64	52	42	8	
	C	33 3/16 X 36	93	93	84	85	69	57	10	
	D OR E	33 3/16 X 36	106	106	95	96	77	63	12	
M1-1 M1-401	A	18 X 18	55	55	49	50	42	35	6	
	A	22 1/2 X 18	60	60	54	55	47	40	6	
	B	24 X 24	73	73	65	66	56	46	8	
	B	30 X 24	79	79	71	72	62	52	8	
	C	36 X 36	97	97	87	88	76	64	10	
	C	45 X 36	106	106	96	97	85	73	10	
	D OR E	36 X 36	110	110	97	99	84	70	12	
	D OR E	45 X 36	119	119	106	108	93	79	12	

APPENDIX A-8

10/03

Exit Gore Widths.

Table J-5 illustrates four possible sign layouts for exit gore signs on the Interstate system or where exit numbers are to be provided. The first layout is the most common and is used where there is a single exit within that milepost. The second layout is used where there are multiple exits within that milepost.

The third and fourth layouts are reserved for those extremely narrow gore areas where it is impossible to install the first two configurations. These signs will be treated as the exception and are included herewith only to make the designer aware of this layout.

The dimensions indicated are the actual sign width upon which the 12"/15" legend is installed.

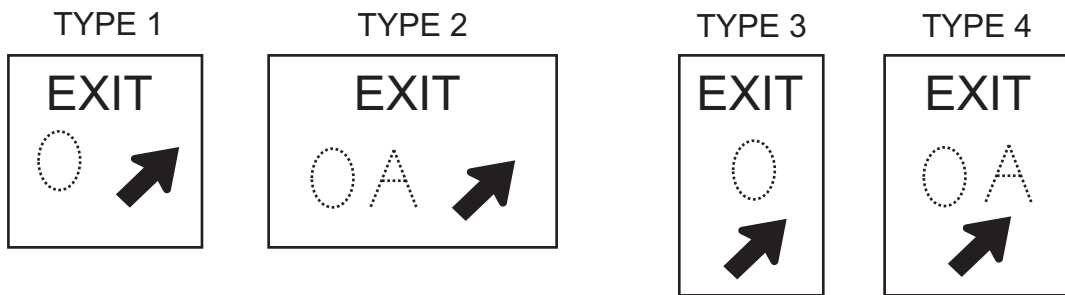

	SIGN WIDTH feet								
Numeral Shape	1	0	1	10	00	11	11	100	000
TYPE 1	5	5	5	5.5	6	6	6.5	7	7
TYPE 2	5.5	6	6.5	7	7.5	7.5	8	8.5	9
TYPE 3	4	4	4	4	4	4	4	4.5	5
TYPE 4	4	4	4	4.5	5	5	5.5	6	6.5

TABLE J-5

	SIGN WIDTH mm								
Numeral Shape	1	0	1	10	00	11	11	100	000
TYPE 1	1500	1500	1500	1650	1800	1800	1950	2100	2100
TYPE 2	1650	1800	1950	2100	2250	2250	2400	2550	2700
TYPE 3	1200	1200	1200	1200	1200	1200	1200	1350	1500
TYPE 4	1200	1200	1200	1350	1500	1500	1650	1800	1950

APPENDIX B-1

4/97

GUIDE SIGN ARROW

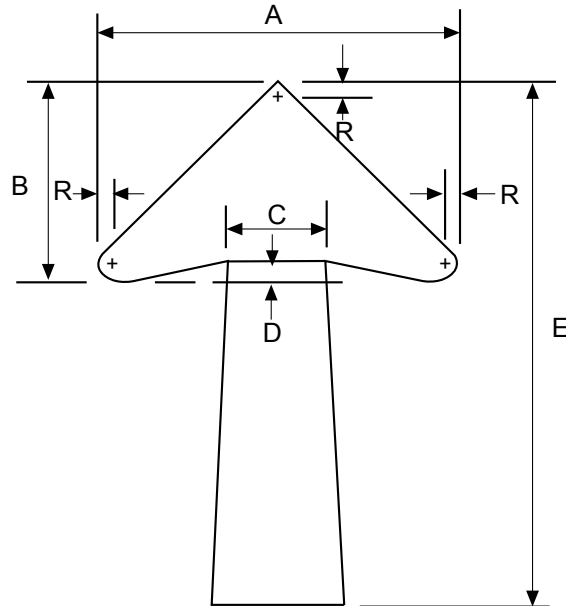

"UP" ARROW, "DIAGONAL" ARROW OR "HORIZONTAL"

DIMENSIONS (MILLIMETERS)								
ARROW NO.	LETTER SIZE(U.C.)	LINES OF COPY	ARROW DIMENSIONS IN MILLIMETERS					
			A	B	C	D	*E	R
1	200 U.C. OR 200 CAPS	1	278.125	212.25	68.75	21.875	325	12.5
2	200 CAPS	2	278.125	212.25	68.75	21.875	450	12.5
3	266.75 - 333.25 U.C	1	456.25	350	112.	37.5	500	18.75
4	OR 250 CAPS	2	456.25	350	112.	37.5	750	18.75
5	400 U.C. OR	1	556.25	425	134.375	43.75	625	25
6	300 CAPS	2	556.25	425	134.375	43.75	875	25

DIMENSIONS (INCHES)								
ARROW NO.	LETTER SIZE(U.C.)	LINES OF COPY	ARROW DIMENSIONS IN INCHES					
			A	B	C	D	*E	R
1	8" U.C. OR 8" CAPS.	1	11	8 1/2	2 3/4	7/8	13	1/2
2	8" CAPS.	2	11	8 1/2	2 3/4	7/8	18	1/2
3	10.67" - 13.33" U.C	1	18 1/4	14	4 1/2	1 1/2	20	3/4
4	OR 10" CAPS.	2	18 1/4	14	4 1/2	1 1/2	30	3/4
5	16" U.C. OR	1	22 1/4	17	5 3/8	1 3/4	25	1
6	12" CAPS.	2	22 1/4	17	5 3/8	1 3/4	35	1

TAPER OF 1/2" PER FOOT SHALL BE HELD CONSTANT FOR LONGER OR SHORTER SHAFT LENGTHS.

APPENDIX B-1A

GUIDE SIGN ARROW

12/94

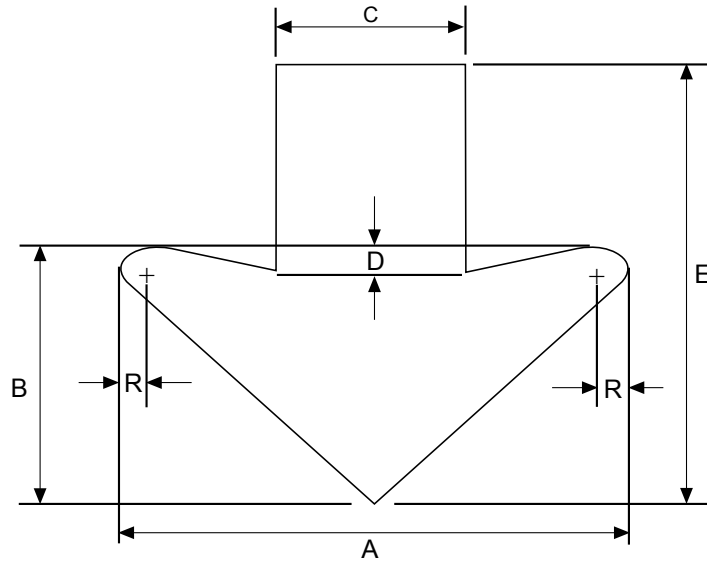

"DOWN" ARROW

DIMENSIONS (MILLIMETERS)							
ARROW NO.	SIZE	ARROW DIMENSIONS IN MILLIMETERS					
		A	B	C	D	E	R
7	266.75 U.C. OR 200	562.5	281.25	125	56.25	412.5	18.75
8	333.25 - 400 U.C. 250 TO 300 C.	800	400	162.5	75	550	25

DIMENSIONS IN INCHES							
ARROW NO.	SIZE	ARROW DIMENSIONS IN INCHES					
		A	B	C	D	E	R
7	10.67 U.C. OR 8 CAPS.	22 1/2	11 1/4	5	2 1/4	16 1/2	3/4
8	13.33 - 16 U.C. OR 10 TO 12 CAPS	32	16	6 1/2	3	22	1

APPENDIX B-2

GUIDE SIGN ARROW
12/94

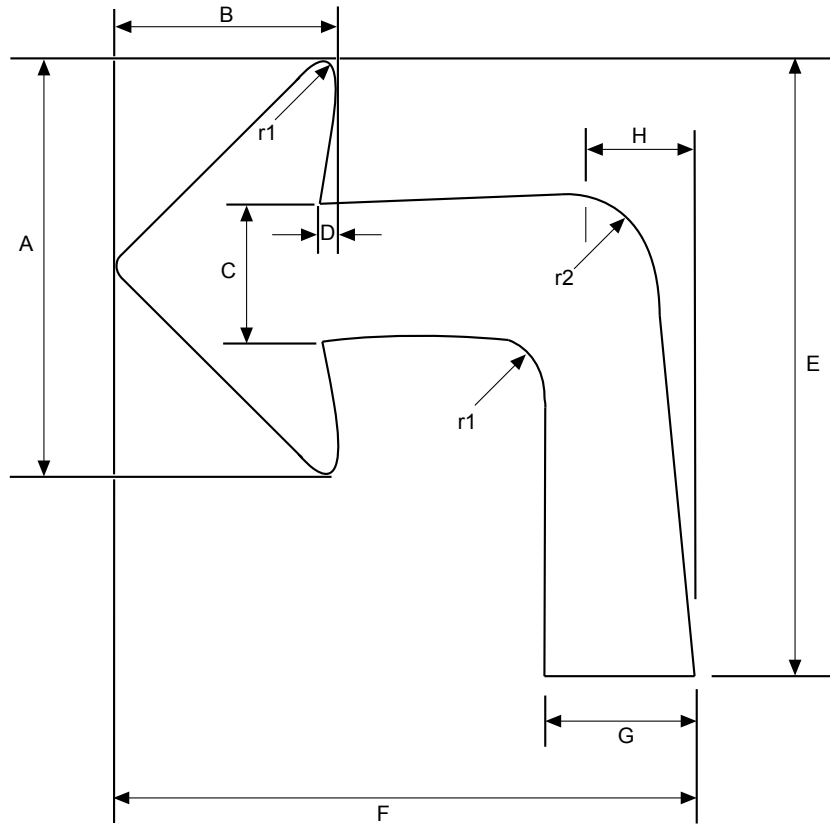

DIMENSIONS IN (MILLIMETERS)										
LETTER SIZE	A	B	C	D	E	F	G	H	r1	r2
150 U.C. 112.5 L.C.	212.5	143.75	50	15.625	337.5	325	87.5	62.5	9.375	50
200 U.C. 150 L.C.	356.25	246.88	84.375	31.25	356.25	356.25	125	87.5	18.75	68.75
266.75 U.C. 200 L.C.	456.25	350	112.5	37.5	600	575	150	100	18.75	75

DIMENSIONS IN (INCHES)										
LETTER SIZE	A	B	C	D	E	F	G	H	r1	r2
6 U.C. 4 1/2 L.C.	8 1/2	5 3/4	2	5/8	13 1/2	13	3 1/2	2 1/2	3/8	2
8 U.C. 6 L.C.	14 1/4	9 7/8	3 3/8	1 1/4	17 1/4	17 1/4	5	3 1/2	3/4	2 3/4
10 2/3 U.C. 8 L.C.	18 1/4	14	4 1/2	1 1/2	24	23	6	4	3/4	3

APPENDIX B-2A

GUIDE SIGN ARROW
12/94

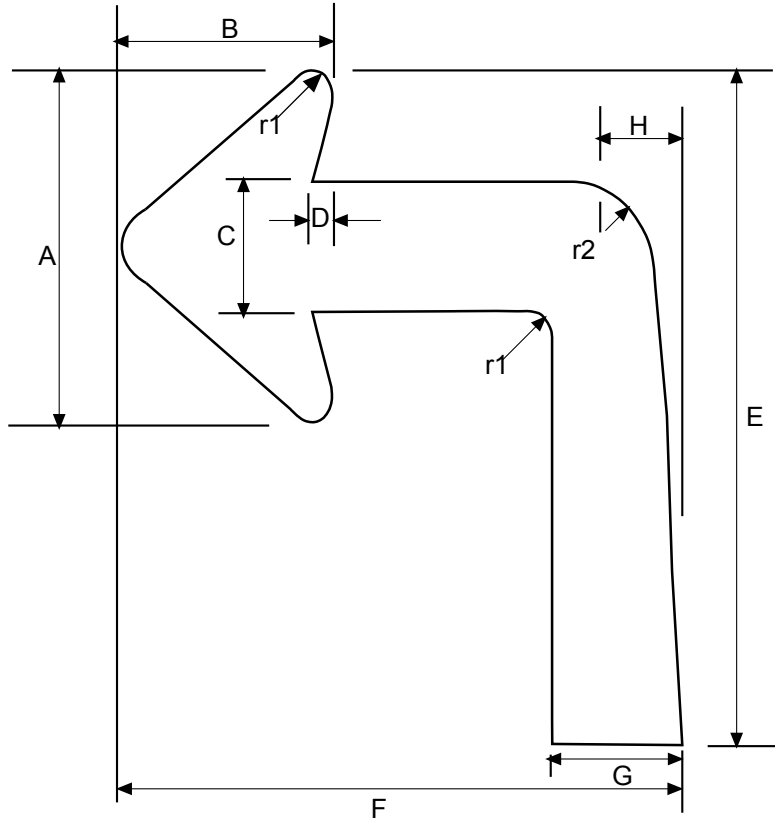

DIMENSIONS IN (MILLIMETERS)										
LETTER SIZE	A	B	C	D	E	F	G	H	r1	r2
150 U.C. 112.5 L.C.	212.5	143.75	50	15.625	450	325	87.5	62.5	9.375	50
200 U.C. 150 L.C.	356.25	246.88	84.375	31.25	600	356.25	125	87.5	18.75	68.75
266.75 U.C. 200 L.C.	456.25	350	112.	37.5	750	575	150	100	18.75	75

DIMENSIONS IN (INCHES)										
LETTER SIZE	A	B	C	D	E	F	G	H	r1	r2
6 U.C. 4 1/2 L.C.	8 1/2	5 3/4	2	5/8	18	13	3 1/2	2 1/2	3/8	2
8 U.C. 6 L.C.	14 1/4	9 7/8	3 3/8	1 1/4	24	17 1/4	5	3 1/2	3/4	2 3/4
10 2/3 U.C. 8 L.C.	18 1/4	14	4 1/2	1 1/2	30	23	6	4	3/4	3

APPENDIX B-3

10/97

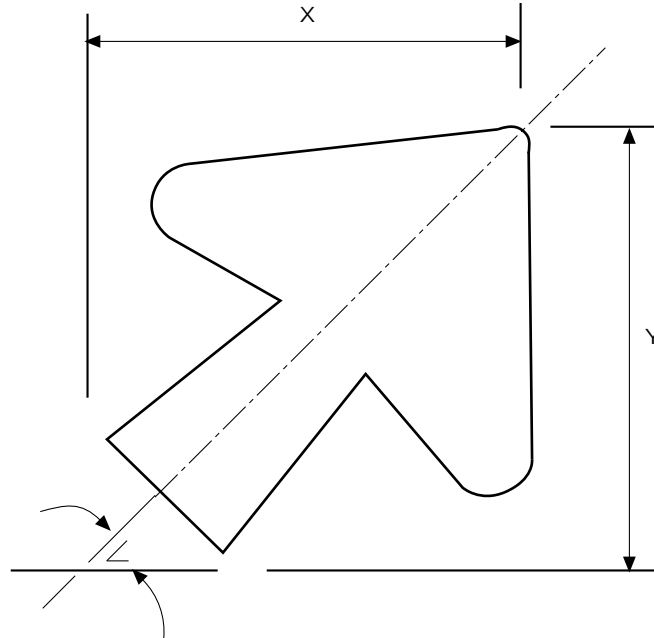

ROTATION DIMENSION FOR GUIDE

ARROW NO.	DIMENSIONS IN (MILLIMETERS)					
	ANGLE OF ARROW (ζ)					
	30°		45°		60°	
	X	Y	X	Y	X	Y
1	306.2	246.8	271.8	271.8	246.8	306.2
2	421.8	306.2	368.7	368.7	306.2	421.8
3	468.7	400	409.3	409.3	400	468.7
4	693.7	506.2	590.6	590.6	506.2	693.7
5	587.	443.7	506.2	506.2	443.7	587.5
6	806.2	565.6	687.5	687.5	565.6	806.2

ARROW NO.	DIMENSIONS IN (INCHES)					
	ANGLE OF ARROW (ζ)					
	30°		45°		60°	
	X	Y	X	Y	X	Y
1	12 1/4	9 7/8	10 7/8	10 7/8	9 7/8	12 1/4
2	16 7/8	12 1/4	14 3/4	14 3/4	12 1/4	16 7/8
3	18 3/4	16	16 3/8	16 3/8	16	18 3/4
4	27 3/4	20 1/4	23 5/8	23 5/8	20 1/4	27 3/4
5	23 1/2	17 3/4	20 1/4	20 1/4	17 3/4	23 1/2
6	32 1/4	22 5/8	27 1/2	27 1/2	22 5/8	32 1/4

Arrow as per SIGN FABRICATION

APPENDIX B-4A

5/06

STANDARD 6" X 9" ARROW DETAILS

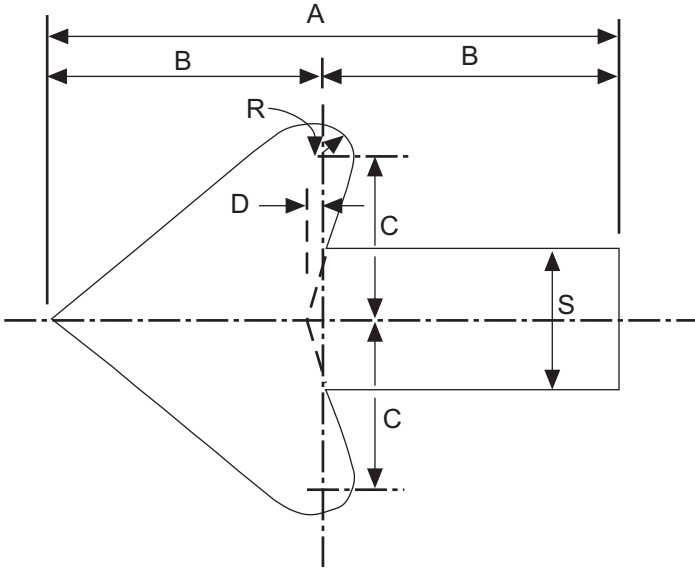

DIMENSIONS IN (MILLIMETERS)					
A	B	C	D	R	S
225	112	64	8	11	56

DIMENSIONS IN (INCHES)					
A	B	C	D	R	S
9	4 1/2	2 9/16	5/16	7/16	2 1/4

APPENDIX B-4B

10/97

8 1/2 " X 10" ARROW DETAILS

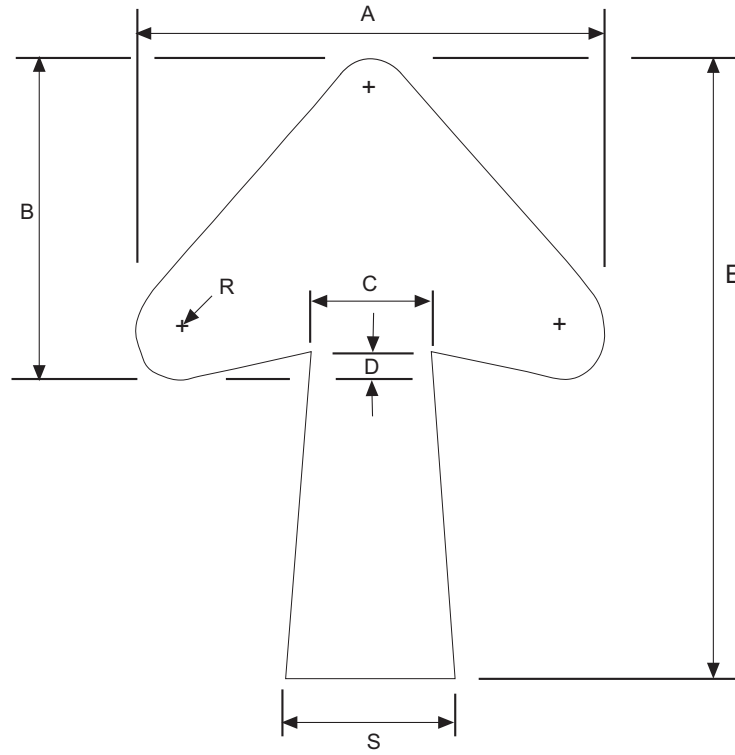

DIMENSIONS IN (MILLIMETERS)						
A	B	C	D	E	R	S
213	144	50	15.63	250	9.38	62.5

DIMENSIONS IN (INCHES)						
A	B	C	D	E	R	S
8 1/2	5 3/4	2	5/8	10	3/8	2 1/2

APPENDIX B-5

10/97

STANDARD ARROW DETAILS

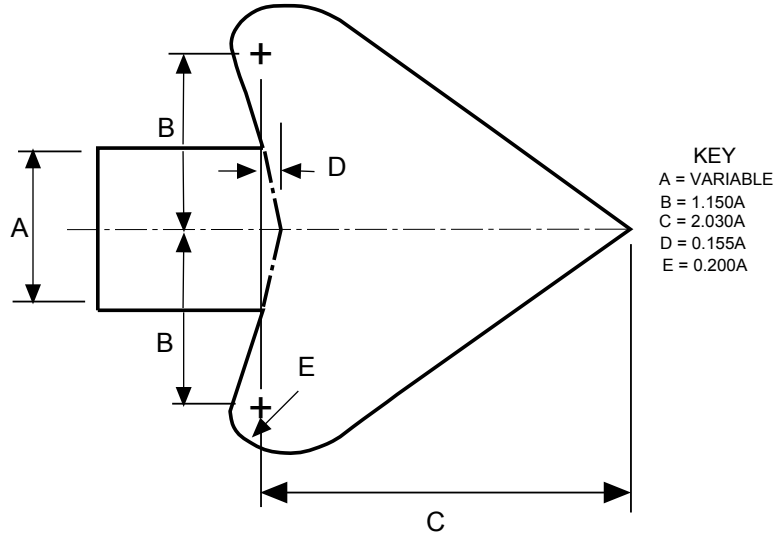

DIMENSIONS IN (MILLIMETERS)				
A	B	C	D	E
50	57.81	101.56	7.81	9.38
56.25	65.63	112.	9.38	10.94
62.5	71.88	126.56	9.38	12.5
65.63	75	131.25	9.38	12.5
68.75	75	139.06	10.94	14.06
75	87.5	153.13	10.94	14.06
78.13	90.63	159.38	12.5	15.63
81.25	93.75	165.63	12.5	15.63
82.81	95.31	171.88	12.5	17.19

DIMENSIONS IN (MILLIMETERS)				
A	B	C	D	E
87.5	100	178.13	14.06	17.09
93.75	107.81	190.63	14.06	18.75
100	115.6	203.12	15.63	20.31
101.56	118.7	206.25	15.63	20.31
106.25	121.88	215.63	15.63	20.31
109.38	125	221.88	17.19	21.88
112.	129.69	228.13	17.19	21.88
118.7	135.94	240.63	18.75	25
121.88	140.63	246.88	18.75	25

DIMENSIONS IN (MILLIMETERS)				
A	B	C	D	E
125	143.75	253.13	18.75	25
131.25	150	265.63	20.31	25.56
137.5	159.38	278.13	21.88	28.13
143.75	163.63	292.19	21.88	28.13
150	171.88	304.69	23.44	29.69
162.5	187.5	329.69	25	32.81
175	200	354.69	26.56	34.38
187.5	215.63	375.69	28.13	37.5
200	229.69	406.25	31.25	40.63

DIMENSIONS IN (INCHES)				
A	B	C	D	E
2	2 5/16	4 1/16	5/16	3/8
2 1/4	2 5/8	4 1/2	3/8	7/16
2 1/2	2 7/8	5 1/16	3/8	1/2
2 5/8	3	5 1/4	3/8	1/2
2 3/4	3	5 9/16	7/16	9/16
3	3 1/2	6 1/8	7/16	9/16
3 1/8	3 5/8	6 3/8	1/2	5/8
3 1/4	3 3/4	6 5/8	1/2	5/8
3 5/16	3 3/16	6	1/2	11/16

DIMENSIONS IN (INCHES)				
A	B	C	D	E
3 1/2	4	7 1/8	9/16	11/16
3 3/4	4 5/16	7 5/8	9/16	3/4
4	4 5/8	8 1/8	5/8	13/16
4 1/16	4 3/4	8 1/4	5/8	13/16
4 1/4	4 7/8	9 5/8	5/8	13/16
4 3/8	5	9 7/8	11/16	7/8
4 1/2	5 3/16	9 1/8	11/16	7/8
4 3/4	5 7/16	9 5/8	3/4	1
4 7/8	5 5/8	9 7/8	3/4	1

DIMENSIONS IN (INCHES)				
A	B	C	D	E
5	5 3/4	10 1/8	3/4	1
5 1/4	6	10 5/8	13/16	1 1/16
5 1/2	6 3/8	11	7/8	1 1/8
5 3/4	6 5/8	11	7/8	1 1/8
6	6 7/8	12 3/16	15/16	1 3/16
6 1/2	7 1/2	13 3/16	1	1 5/16
7	8	14 3/16	1 1/16	1 3/8
7 1/2	8 5/8	15 3/16	1 1/8	1 1/2
8	9 3/16	16 1/4	1 1/4	1 5/8

APPENDIX B-6A

12/94

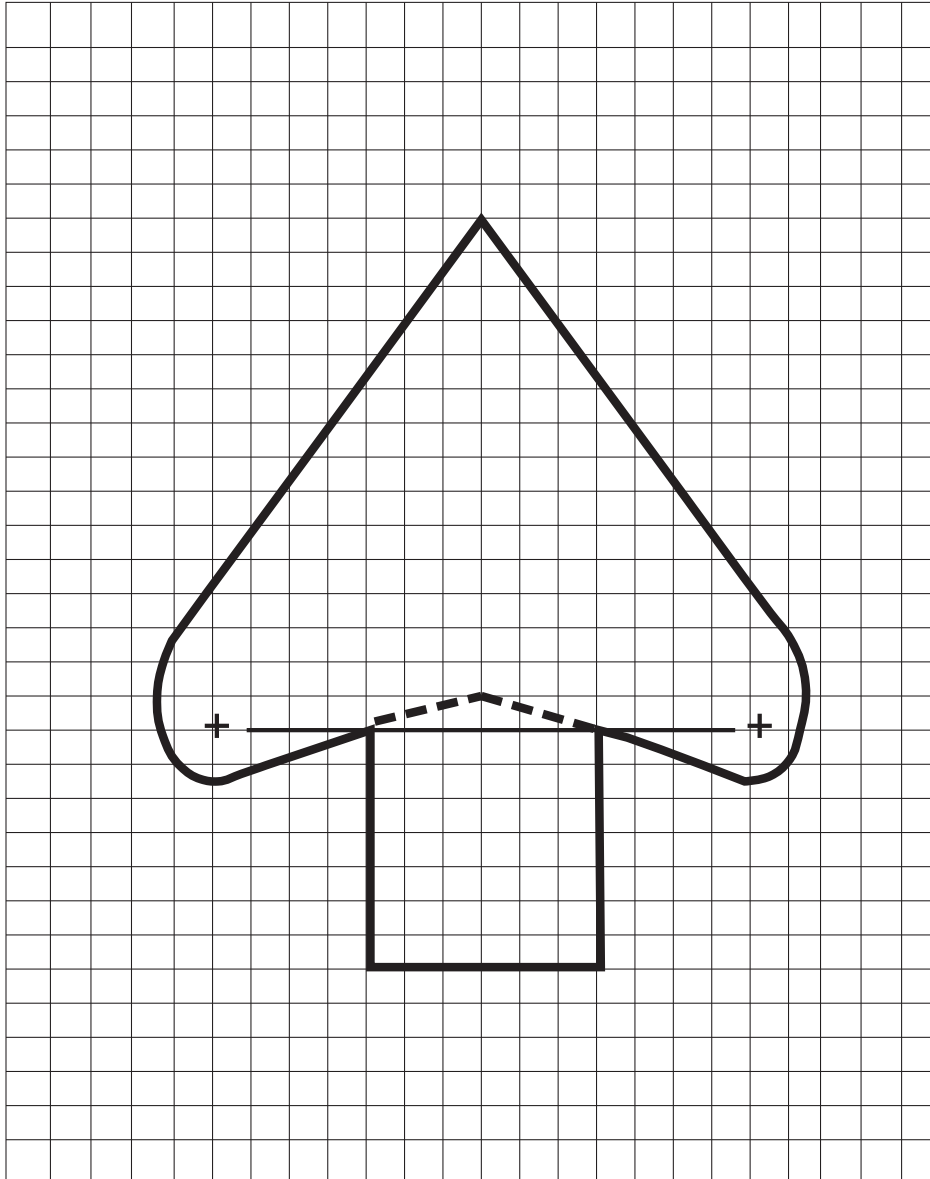

STANDARD ARROW

APPENDIX B-7

5/06

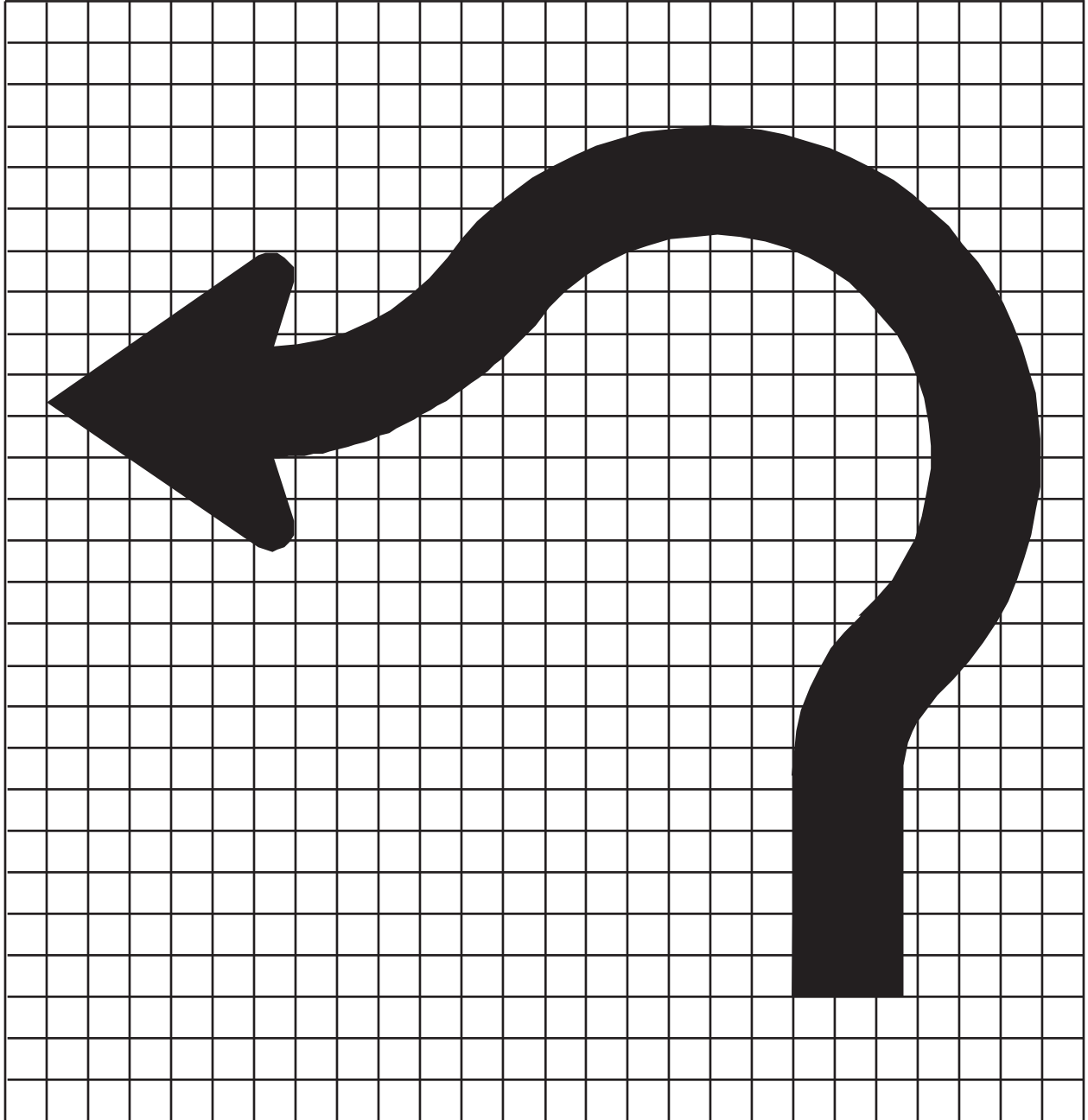

APPENDIX C-3

SERIES B

10/97

LETTER & NUMERAL WIDTHS AND SPACE BETWEEN LETTERS AND NUMERAL (IN INCHES)

To determine the proper space between letters or numerals, obtain the code number from table I or II and enter table VI for that code number to the desired letter or numeral height.

TABLE I LETTER TO LETTER CODE NUMBER			
PRECEDING LETTER	FOLLOWING LETTER		
	BDEFHIK LMNPRU	CGO OSXZ	AJT VWY
A	2	2	4
B	1	2	2
C	2	2	3
D	1	2	2
E	2	2	3
F	2	2	3
G	1	2	2
H	1	1	2
I	1	1	2
J	1	1	2
K	2	2	3
L	2	2	4
M	1	1	2
N	1	1	2
O	1	2	2
P	1	2	2
Q	1	2	2
R	1	2	2
S	1	2	2
T	2	2	4
U	1	1	2
V	2	2	4
W	2	2	4
X	2	2	3
Y	2	2	4
Z	2	2	3

TABLE IV WIDTH OF LETTER							
LETTER HEIGHT	4"	5"	6"	8"	10"	12"	18"
A	2.12	2.66	3.19	4.25	5.31	6.38	9.56
B	1.69	2.11	2.53	3.38	4.22	5.06	7.59
C	1.69	2.11	2.53	3.38	4.22	5.06	7.59
D	1.69	2.11	2.53	3.38	4.22	5.06	7.59
E	1.50	1.88	2.25	3.00	3.75	4.50	6.75
F	1.50	1.88	2.25	3.00	3.75	4.50	6.75
G	1.69	2.11	2.53	3.38	4.22	5.06	7.59
H	1.69	2.11	2.53	3.38	4.22	5.06	7.59
I	0.50	0.62	0.75	1.00	1.25	1.50	2.25
J	1.75	2.19	2.62	3.50	4.38	5.25	7.88
K	1.75	2.19	2.62	3.50	4.38	5.25	7.88
L	1.50	1.88	2.25	3.00	3.75	4.50	6.75
M	1.94	2.42	2.91	3.88	4.84	5.81	8.72
N	1.69	2.11	2.53	3.38	4.22	5.06	7.59
O	1.81	2.27	2.72	3.62	4.53	5.44	8.16
P	1.69	2.11	2.53	3.38	4.22	5.06	7.59
Q	1.81	2.27	2.72	3.62	4.53	5.44	8.16
R	1.69	2.11	2.53	3.38	4.22	5.06	7.59
S	1.69	2.11	2.53	3.38	4.22	5.06	7.59
T	1.50	1.88	2.25	3.00	3.75	4.50	6.75
U	1.69	2.11	2.53	3.38	4.22	5.06	7.59
V	1.84	2.30	2.77	3.69	4.61	5.53	8.31
W	2.50	3.12	3.75	5.00	6.25	7.50	11.25
X	1.84	2.30	2.77	3.69	4.61	5.53	8.31
Y	2.12	2.66	3.19	4.25	5.31	6.38	9.56
Z	1.69	2.11	2.53	3.38	4.22	5.06	7.59

TABLE II NUMERAL TO NUMERAL CODE NUMBER			
PRECEDING LETTER	FOLLOWING LETTER		
	1 5	2 3 6 8 9 0	4 7
1	1	1	2
2	1	2	2
3	1	2	2
4	2	2	4
5	1	2	2
6	1	2	2
7	2	2	4
8	1	2	2
9	1	2	2
0	1	2	2

TABLE V WIDTH OF NUMERALS							
NUMERAL HEIGHT	4"	5"	6"	8"	10"	12"	18"
1	0.81	1.02	1.22	1.62	2.03	2.44	3.66
2	1.69	2.11	2.53	3.38	4.22	5.06	7.59
3	1.69	2.11	2.53	3.38	4.22	5.06	7.59
4	1.94	2.42	2.91	3.88	4.84	5.81	8.72
5	1.69	2.11	2.53	3.38	4.22	5.06	7.59
6	1.69	2.11	2.53	3.38	4.22	5.06	7.59
7	1.69	2.11	2.53	3.38	4.22	5.06	7.59
8	1.69	2.11	2.53	3.38	4.22	5.06	7.59
9	1.69	2.11	2.53	3.38	4.22	5.06	7.59
0	1.81	2.27	2.72	3.62	4.53	5.44	8.16

TABLE III WIDTH OF STROKE	
PRECEDING LETTER	STROKE WIDTH IN INCHES
4"	0.50
5"	0.62
6"	0.75
8"	1.00
10"	1.25
12"	1.50
18"	2.25

TABLE VI WIDTH OF NUMERALS							
CODE NUMBER	4"	5"	6"	8"	10"	12"	18"
1	0.75	0.94	1.13	1.50	1.88	2.25	3.37
2	0.60	0.75	0.90	1.20	1.50	1.80	2.70
3	0.40	0.50	0.60	0.80	1.00	1.20	1.80
4	0.20	0.25	0.30	0.50	0.50	0.60	0.90
SPACE { }							

APPENDIX C-3A

SERIES B

4/97

LETTER & NUMERAL WIDTHS AND SPACE BETWEEN LETTERS AND NUMERAL (IN MILLIMETERS)

To determine the proper space between letters or numerals, obtain the code number from table I or II and enter table VI for that code number to the desired letter or numeral height.

TABLE I LETTER TO LETTER CODE NUMBER			
PRECEDING LETTER	FOLLOWING LETTER		
	BDEFHI K	CGO Q SX	AJT VW
A	2	2	4
B	1	2	2
C	2	2	3
D	1	2	2
E	2	2	3
F	2	2	3
G	1	2	2
H	1	1	2
I	1	1	2
J	1	1	2
K	2	2	3
L	2	2	4
M	1	1	2
N	1	1	2
O	1	2	2
P	1	2	2
Q	1	2	2
R	1	2	2
S	1	2	2
T	2	2	4
U	1	1	2
V	2	2	4
W	2	2	4
X	2	2	3
Y	2	2	4
Z	2	2	3

TABLE IV WIDTH OF LETTER IN MILLIMETERS										
LETTER	HEIGHT 75	100	125	150	175	200	225	250	300	400
A	40	54	68	81	94	108	122	135	162	216
B	32	43	54	64	75	86	96	107	128	172
C	32	43	54	64	75	86	96	107	128	172
D	32	43	54	64	75	86	96	107	128	172
E	28	38	48	57	66	76	86	95	114	152
F	28	38	48	57	66	76	86	95	114	152
G	32	43	54	64	75	86	96	107	128	172
H	32	43	54	64	75	86	96	107	128	172
I	10	13	16	19	22	25	28	32	38	50
J	33	44	56	66	78	89	100	111	133	178
K	33	44	56	66	78	89	100	111	133	178
L	28	38	48	57	66	76	86	95	114	152
M	37	49	62	74	86	99	111	123	148	198
N	32	43	54	64	75	86	96	107	128	172
O	34	46	58	69	80	92	104	115	138	184
P	32	43	54	64	75	86	96	107	128	172
Q	34	46	58	69	80	92	104	115	138	184
R	32	43	54	64	75	86	96	107	128	172
S	32	43	54	64	75	86	96	107	128	172
T	28	38	48	57	66	76	86	95	114	152
U	32	43	54	64	75	86	96	107	128	172
V	35	47	58	70	82	94	106	117	140	188
W	48	64	79	95	111	127	143	159	190	254
X	35	47	58	70	82	94	106	117	140	188
Y	40	54	68	81	94	108	122	135	162	216
Z	32	43	54	64	75	86	96	107	128	172

TABLE II NUMERAL TO NUMERAL CODE NUMBER			
PRECEDING LETTER	FOLLOWING LETTER		
	1 5	2 3 6 8 9 0	4 7
1	1	1	2
2	1	2	2
3	1	2	2
4	2	2	4
5	1	2	2
6	1	2	2
7	2	2	4
8	1	2	2
9	1	2	2
0	1	2	2

TABLE V WIDTH OF NUMERAL IN MILLIMETERS										
Numeral Height	75	100	125	150	175	200	225	250	300	400
1	16	21	26	31	36	41	46	52	62	82
2	32	43	54	64	75	86	96	107	128	172
3	32	43	54	64	75	86	96	107	128	172
4	37	49	61	74	86	99	111	123	148	198
5	32	43	54	64	75	86	96	107	128	172
6	32	43	54	64	75	86	96	107	128	172
7	32	43	54	64	75	86	96	107	128	172
8	32	43	54	64	75	86	96	107	128	172
9	32	43	54	64	75	86	96	107	128	172
0	34	46	58	69	80	92	104	115	138	184

TABLE III WIDTH OF STROKE	
LETTER OR NUMERAL HEIGHT	STROKE WIDTH IN MILLIMETERS
74	10
100	13
125	16
150	19
175	22
200	25
225	28
250	32
300	38
400	50

TABLE VI WIDTH OF NUMERALS IN MILLIMETERS										
CODE NUMBER	75	100	125	150	175	200	225	250	300	400
1	14	19	24	29	34	38	43	48	57	76
2	12	15	19	23	26	30	34	38	46	60
3	8	10	13	15	18	20	22	25	30	40
4	4	5	6	8	9	10	12	13	15	20

Space in millimeters measured horizontally from the extreme right edge of the preceding letter (or numeral) to the extreme left edge of the following letter (or numeral).

APPENDIX C-4

SERIES C

10/97

LETTER & NUMERAL WIDTHS AND SPACE BETWEEN LETTERS AND NUMERAL (IN INCHES)

To determine the proper space between letters or numerals, obtain the code number from table I or II and enter table VI for that code number to the desired letter or numeral height.

TABLE I LETTER TO LETTER CODE NUMBER			
PRECEDING LETTER	FOLLOWING LETTER		
	BDFHI K	CGO Q SX	AJT VW
A	2	2	4
B	1	2	2
C	2	2	3
D	1	2	2
E	2	2	3
F	2	2	3
G	1	2	2
H	1	1	2
I	1	1	2
J	1	1	2
K	2	2	3
L	2	2	4
M	1	1	2
N	1	1	2
O	1	2	2
P	1	2	2
Q	1	2	2
R	1	2	2
S	1	2	2
T	2	2	4
U	1	1	2
V	2	2	4
W	2	2	4
X	2	2	3
Y	2	2	4
Z	2	2	3

TABLE IV WIDTH OF LETTER							
LETTER HEIGHT	4	5	6	8	10	12	18
A	2.50	3.12	3.75	5.00	6.25	7.50	11.25
B	2.19	2.73	3.28	4.38	5.47	6.56	9.84
C	2.19	2.73	3.28	4.38	5.47	6.56	9.84
D	2.19	2.73	3.28	4.38	5.47	6.56	9.84
E	2.00	2.50	3.00	4.00	5.00	6.00	9.00
F	2.00	2.50	3.00	4.00	5.00	6.00	9.00
G	2.19	2.73	3.28	4.38	5.47	6.56	9.84
H	2.19	2.73	3.28	4.38	5.47	6.56	9.84
I	0.56	0.70	0.84	1.12	1.41	1.69	2.53
J	2.00	2.50	3.00	4.00	5.00	6.00	9.00
K	2.19	2.73	3.28	4.38	5.47	6.56	9.84
L	2.00	2.50	3.00	4.00	5.00	6.00	9.00
M	2.59	3.23	3.89	5.19	6.48	7.78	11.67
N	2.19	2.73	3.28	4.38	5.47	6.56	9.84
O	2.31	2.89	3.47	4.62	5.78	6.94	10.41
P	2.19	2.73	3.28	4.38	5.47	6.56	9.84
Q	2.31	2.89	3.47	4.62	5.78	6.94	10.41
R	2.19	2.73	3.28	4.38	5.47	6.56	9.84
S	2.19	2.73	3.28	4.38	5.47	6.56	9.84
T	2.00	2.50	3.00	4.00	5.00	6.00	9.00
U	2.19	2.73	3.28	4.38	5.47	6.56	9.84
V	2.44	3.05	3.66	4.88	6.09	7.31	10.97
W	3.00	3.75	4.50	6.00	7.50	9.00	13.50
X	2.34	2.92	3.52	4.69	5.86	7.03	10.56
Y	2.50	3.12	3.75	5.00	6.25	7.50	11.25
Z	2.19	2.73	3.28	4.38	5.47	6.56	9.84

TABLE II NUMERAL TO NUMERAL CODE NUMBER			
PRECEDING LETTER	FOLLOWING LETTER		
	1 5	2 3 6 8 9 0	4 7
1	1	1	2
2	1	2	2
3	1	2	2
4	2	2	4
5	1	2	2
6	1	2	2
7	2	2	4
8	1	2	2
9	1	2	2
0	1	2	2

TABLE V WIDTH OF NUMERALS							
NUMERAL HEIGHT	4	5	6	8	10	12	18
1	0.81	1.02	1.22	1.62	2.03	2.44	3.66
2	2.19	2.73	3.28	4.38	5.47	6.56	9.84
3	2.19	2.73	3.28	4.38	5.47	6.56	9.84
4	2.44	3.05	3.66	4.88	6.09	7.31	10.97
5	2.19	2.73	3.28	4.38	5.47	6.56	9.84
6	2.19	2.73	3.28	4.38	5.47	6.56	9.84
7	2.19	2.73	3.28	4.38	5.47	6.56	9.84
8	2.19	2.73	3.28	4.38	5.47	6.56	9.84
9	2.19	2.73	3.28	4.38	5.47	6.56	9.84
0	2.31	2.89	3.47	4.62	5.78	6.94	10.41

TABLE II WIDTH OF STROKE	
PRECEDING LETTER	STROKE WIDTH
4"	0.56
5"	0.70
6"	0.84
8"	1.12
10	1.41
"	1.69
12	2.53

TABLE VI WIDTH OF NUMERALS							
CODE NUMBER	4	5	6	8	10	12	18
1	0.84	1.05	1.26	1.68	2.11	2.53	3.79
2	0.67	0.84	1.01	1.34	1.69	2.03	3.04
3	0.45	0.56	0.68	0.90	1.12	1.36	2.04
4	0.22	0.28	0.34	0.44	0.56	0.68	1.02

SPACE in inches measured horizontally from the extreme right edge of the preceding letter to the extreme left edge of the following letter (numeral).

APPENDIX C-4A

SERIES C

10/97

LETTER & NUMERAL WIDTHS AND SPACE BETWEEN LETTERS AND NUMERAL (IN MILLIMETERS)

To determine the proper space between letters or numerals, obtain the code number from table I or II and enter table VI for that code number to the desired letter or numeral height.

TABLE I LETTER TO LETTER CODE NUMBER			
PRECEDING LETTER	FOLLOWING LETTER		
	BDEFHI K	CGO Q SX	AJT VW
A	2	2	4
B	1	2	2
C	2	2	3
D	1	2	2
E	2	2	3
F	2	2	3
G	1	2	2
H	1	1	2
I	1	1	2
J	1	1	2
K	2	2	3
L	2	2	4
M	1	1	2
N	1	1	2
O	1	2	2
P	1	2	2
Q	1	2	2
R	1	2	2
S	1	2	2
T	2	2	4
U	1	1	2
V	2	2	4
W	2	2	4
X	2	2	3
Y	2	2	4
Z	2	2	3

TABLE IV WIDTH OF LETTER IN MILLIMETERS										
LETTER	HEIGHT 75	100	125	150	175	200	225	250	300	400
A	48	64	79	95	111	127	143	159	190	254
B	42	56	69	83	97	111	125	139	167	222
C	42	56	69	83	97	111	125	139	167	222
D	42	56	69	83	97	111	125	139	167	222
E	38	51	64	76	89	102	114	127	152	204
F	38	51	64	76	89	102	114	127	152	204
G	42	56	69	83	97	111	125	139	167	222
H	42	56	69	83	97	111	125	139	167	222
I	10	14	18	21	24	28	32	36	43	56
J	38	51	64	76	89	102	114	127	152	204
K	42	56	69	83	97	111	125	139	167	222
L	38	51	64	76	89	102	114	127	152	204
M	50	66	82	99	116	132	148	165	198	264
N	42	56	69	83	97	111	125	139	167	222
O	44	59	73	88	102	117	132	147	176	234
P	42	56	69	83	97	111	125	139	167	222
Q	44	59	73	88	102	117	132	147	176	234
R	42	56	69	83	97	111	125	139	167	222
S	42	56	69	83	97	111	125	139	167	222
T	38	51	64	76	89	102	114	127	152	204
U	42	56	69	83	97	111	125	139	167	222
V	46	62	77	93	108	124	140	155	186	248
W	57	76	95	114	133	152	171	190	229	304
X	44	59	74	89	104	119	134	149	179	238
Y	48	64	79	95	111	127	143	159	190	254
Z	42	56	69	83	97	111	125	139	167	222

TABLE II NUMERAL TO NUMERAL CODE NUMBER			
PRECEDING LETTER	FOLLOWING LETTER		
	1 5	2 3 6 8 9 0	4 7
1	1	1	2
2	1	2	2
3	1	2	2
4	2	2	4
5	1	2	2
6	1	2	2
7	2	2	4
8	1	2	2
9	1	2	2
0	1	2	2

TABLE V WIDTH OF NUMERAL IN MILLIMETERS										
Numeral Height	75	100	125	150	175	200	225	250	300	400
1	16	21	26	31	36	41	46	52	62	82
2	42	56	69	83	97	111	125	139	167	222
3	42	56	69	83	97	111	125	139	167	222
4	46	62	77	93	108	124	140	155	186	248
5	42	56	69	83	97	111	125	139	167	222
6	42	56	69	83	97	111	125	139	167	222
7	42	56	69	83	97	111	125	139	167	222
8	42	56	69	83	97	111	125	139	167	222
9	42	56	69	83	97	111	125	139	167	222
0	44	59	73	88	102	117	132	147	176	234

TABLE III WIDTH OF STROKE	
LETTER OR NUMERAL HEIGHT	STROKE WIDTH IN
75	10
100	14
125	18
150	21
175	24
200	28
225	32
250	36
300	43
400	57

TABLE VI WIDTH OF NUMERALS IN MILLIMETERS										
CODE NUMBER	75	100	125	150	175	200	225	250	300	400
1	16	21	27	32	38	43	48	54	64	85
2	13	17	21	26	30	34	38	43	52	69
3	8	11	14	17	20	23	26	28	34	45
4	4	6	7	9	10	11	12	14	17	23

Space in millimeters measured horizontally from the extreme right edge of the preceding letter (or numeral) to the extreme left edge of the following letter (or numeral).

APPENDIX C-5

SERIES D

10/97

LETTER & NUMERAL WIDTHS AND SPACE BETWEEN LETTERS AND NUMERAL (IN INCHES)

To determine the proper space between letters or numerals, obtain the code number from table I or II and enter table VI for that code number to the desired letter or numeral height.

TABLE I LETTER TO LETTER CODE NUMBER			
PRECEDING LETTER	FOLLOWING LETTER		
	BDFHI K	CGO Q SX	AJT VW
A	2	2	4
B	1	2	2
C	2	2	3
D	1	2	2
E	2	2	3
F	2	2	3
G	1	2	2
H	1	1	2
I	1	1	2
J	1	1	2
K	2	2	3
L	2	2	4
M	1	1	2
N	1	1	2
O	1	2	2
P	1	2	2
Q	1	2	2
R	1	2	2
S	1	2	2
T	2	2	4
U	1	1	2
V	2	2	4
W	2	2	4
X	2	2	3
Y	2	2	4
Z	2	2	3

TABLE IV WIDTH OF LETTER							
LETTER	LETTER HEIGHT						
	4	5	6	8	10	12	18
A	3.34	4.19	5.02	6.69	8.36	10.03	15.06
B	2.69	3.36	4.03	5.38	6.72	8.06	12.09
C	2.69	3.36	4.03	5.38	6.72	8.06	12.09
D	2.69	3.36	4.03	5.38	6.72	8.06	12.09
E	2.44	3.05	3.66	4.88	6.09	7.31	10.97
F	2.44	3.05	3.66	4.88	6.09	7.31	10.97
G	2.69	3.36	4.03	5.38	6.72	8.06	12.09
H	2.69	3.36	4.03	5.38	6.72	8.06	12.09
I	0.62	0.78	0.94	1.25	1.56	1.88	2.81
J	2.50	3.12	3.75	5.00	6.25	7.50	11.25
K	2.75	3.44	4.12	5.50	6.88	8.25	12.38
L	2.44	3.05	3.66	4.88	6.09	7.31	10.97
M	3.09	3.86	4.64	6.19	7.73	9.28	13.94
N	2.69	3.36	4.03	5.38	6.72	8.06	12.09
O	2.81	3.50	4.22	5.62	7.03	8.44	12.66
P	2.69	3.36	4.03	5.38	6.72	8.06	12.09
Q	2.81	3.50	4.22	5.62	7.03	8.44	12.66
R	2.69	3.36	4.03	5.38	6.72	8.06	12.09
S	2.69	3.36	4.03	5.38	6.72	8.06	12.09
T	2.44	3.05	3.66	4.88	6.09	7.31	10.97
U	2.69	3.36	4.03	5.38	6.72	8.06	12.09
V	3.00	3.75	4.50	6.00	7.50	9.00	13.50
W	3.50	4.38	5.25	7.00	8.75	10.50	15.75
X	2.69	3.36	4.03	5.38	6.72	8.06	12.09
Y	3.38	4.22	5.06	6.75	8.44	10.12	15.19
Z	2.69	3.36	4.03	5.38	6.72	8.06	12.09

TABLE II NUMERAL TO NUMERAL CODE NUMBER			
PRECEDING LETTER	FOLLOWING LETTER		
	15	2 3 6 8 9 0	4 7
1	1	1	2
2	1	2	2
3	1	2	2
4	2	2	4
5	1	2	2
6	1	2	2
7	2	2	4
8	1	2	2
9	1	2	2
0	1	2	2

TABLE V WIDTH OF NUMERALS							
NUMERAL HEIGHT	NUMERAL						
	4	5	6	8	10	12	18
1	0.97	1.20	1.45	1.94	2.42	2.91	4.38
2	2.69	3.36	4.03	5.38	6.72	8.06	12.09
3	2.69	3.36	4.03	5.38	6.72	8.06	12.09
4	2.94	3.67	4.41	5.88	7.34	8.81	13.22
5	2.69	3.36	4.03	5.38	6.72	8.06	12.09
6	2.69	3.36	4.03	5.38	6.72	8.06	12.09
7	2.69	3.36	4.03	5.38	6.72	8.06	12.09
8	2.69	3.36	4.03	5.38	6.72	8.06	12.09
9	2.69	3.36	4.03	5.38	6.72	8.06	12.09
0	2.81	3.50	4.22	5.62	7.03	8.44	12.66

TABLE III WIDTH OF STROKE	
PRECEDING LETTER	STROKE WIDTH
4"	0.62
5"	0.78
6"	0.94
8"	1.25
10	1.56
"	1.88
12	2.81

TABLE VI WIDTH OF NUMERALS							
CODE NUMBER	LETTER HEIGHT						
	4	5	6	8	10	12	18
1	0.94	1.17	1.41	1.88	2.34	2.81	4.22
2	0.75	0.94	1.12	1.50	1.88	2.25	3.38
3	0.50	0.62	0.75	1.00	1.25	1.50	2.25
4	0.25	0.31	0.38	0.50	0.62	0.75	1.12

SPACE in inches measured horizontally from the extreme right edge of the preceding letter to the extreme left edge of the following letter (numeral).

APPENDIX C-5A

SERIES D

10/97

LETTER & NUMERAL WIDTHS AND SPACE BETWEEN LETTERS AND NUMERAL (IN MILLIMETERS)

To determine the proper space between letters or numerals, obtain the code number from table I or II and enter table VI for that code number to the desired letter or numeral height.

TABLE I LETTER TO LETTER CODE NUMBER			
PRECEDING LETTER	FOLLOWING LETTER		
	BDEFHI K	CGO QX	AJT VW
A	2	2	4
B	1	2	2
C	2	2	3
D	1	2	2
E	2	2	3
F	2	2	3
G	1	2	2
H	1	1	2
I	1	1	2
J	1	1	2
K	2	2	3
L	2	2	4
M	1	1	2
N	1	1	2
O	1	2	2
P	1	2	2
Q	1	2	2
R	1	2	2
S	1	2	2
T	2	2	4
U	1	1	2
V	2	2	4
W	2	2	4
X	2	2	3
Y	2	2	4
Z	2	2	3

TABLE IV WIDTH OF LETTER IN MILLIMETERS										
LETTER	HEIGHT 75	100	125	150	175	200	225	250	300	400
A	64	85	106	128	149	170	191	212	255	340
B	51	68	85	102	120	137	154	171	205	274
C	51	68	85	102	120	137	154	171	205	274
D	51	68	85	102	120	137	154	171	205	274
E	46	62	77	93	108	124	140	155	186	248
F	46	62	77	93	108	124	140	155	186	248
G	51	68	85	102	120	137	154	171	205	274
H	51	68	85	102	120	137	154	171	205	274
I	12	16	20	24	28	32	36	40	48	64
J	48	64	79	95	111	127	143	159	190	254
K	52	70	87	105	122	140	158	175	210	280
L	46	62	77	93	108	124	140	155	186	248
M	59	78	98	118	138	157	176	196	236	314
N	51	68	85	102	120	137	154	171	205	274
O	54	71	89	107	125	143	161	179	214	286
P	51	68	85	102	120	137	154	171	205	274
Q	54	71	89	107	125	143	161	179	214	286
R	51	68	85	102	120	137	154	171	205	274
S	51	68	85	102	120	137	154	171	205	274
T	46	62	77	93	108	124	140	155	186	248
U	51	68	85	102	120	137	154	171	205	274
V	57	76	95	114	133	152	171	190	229	304
W	66	89	111	133	156	178	200	222	267	356
X	51	68	85	102	120	137	154	171	205	274
Y	64	86	107	128	150	171	192	214	257	342
Z	51	68	85	102	120	137	154	171	205	274

TABLE II NUMERAL TO NUMERAL CODE NUMBER			
PRECEDING LETTER	FOLLOWING LETTER		
	1 5	2 3 6 8 9 0	4 7
1	1	1	2
2	1	2	2
3	1	2	2
4	2	2	4
5	1	2	2
6	1	2	2
7	2	2	4
8	1	2	2
9	1	2	2
0	1	2	2

TABLE V WIDTH OF NUMERAL IN MILLIMETERS										
Numeral Height	75	100	125	150	175	200	225	250	300	400
1	18	25	30	37	44	50	56	61	74	98
2	51	68	85	102	120	137	154	171	205	274
3	51	68	85	102	120	137	154	171	205	274
4	56	75	93	112	130	149	168	186	224	298
5	51	68	85	102	120	137	154	171	205	274
6	51	68	85	102	120	137	154	171	205	274
7	51	68	85	102	120	137	154	171	205	274
8	51	68	85	102	120	137	154	171	205	274
9	51	68	85	102	120	137	154	171	205	274
0	54	71	89	107	125	143	161	179	214	286

TABLE II WIDTH OF STROKE	
LETTER OR NUMERAL HEIGHT	STROKE WIDTH IN MILLIMETERS
75	12
100	16
125	20
150	24
175	28
200	32
225	36
250	40
300	48
400	64

TABLE VI WIDTH OF NUMERALS IN MILLIMETERS										
CODE NUMBER	75	100	125	150	175	200	225	250	300	400
1	18	24	30	36	42	48	54	59	71	96
2	14	19	24	28	33	38	43	48	57	76
3	10	13	16	19	22	25	28	32	38	50
4	5	6	8	10	12	13	14	16	19	26

Space in millimeters measured horizontally from the extreme right edge of the preceding letter (or numeral) to the extreme left edge of the following letter (or numeral).

APPENDIX C-6

SERIES E

10/97

LETTER & NUMERAL WIDTHS AND SPACE BETWEEN LETTERS AND NUMERAL (IN INCHES)

To determine the proper space between letters or numerals, obtain the code number from table I or II and enter table VI for that code number to the desired letter or numeral height.

TABLE I LETTER TO LETTER CODE NUMBER			
PRECEDING LETTER	FOLLOWING LETTER		
	BDFHI K	CGO Q SX	AJT VW
A	2	2	4
B	1	2	2
C	2	2	3
D	1	2	2
E	2	2	3
F	2	2	3
G	1	2	2
H	1	1	2
I	1	1	2
J	1	1	2
K	2	2	3
L	2	2	4
M	1	1	2
N	1	1	2
O	1	2	2
P	1	2	2
Q	1	2	2
R	1	2	2
S	1	2	2
T	2	2	4
U	1	1	2
V	2	2	4
W	2	2	4
X	2	2	3
Y	2	2	4
Z	2	2	3

TABLE IV WIDTH OF LETTER							
LETTER HEIGHT	4	5	6	8	10	12	18
A	4.00	5.00	6.00	8.00	10.00	12.00	18.00
B	3.19	3.98	4.78	6.38	7.97	9.56	14.34
C	3.19	3.98	4.78	6.38	7.97	9.56	14.34
D	3.19	3.98	4.78	6.38	7.97	9.56	14.34
E	2.94	3.67	4.41	5.88	7.34	8.81	13.22
F	2.94	3.67	4.41	5.88	7.34	8.81	13.22
G	3.19	3.98	4.78	6.38	7.97	9.56	14.34
H	3.19	3.98	4.78	6.38	7.97	9.56	14.34
I	0.69	0.86	1.03	1.38	1.72	2.06	3.09
J	3.00	3.75	4.50	6.00	7.50	9.00	13.50
K	3.25	4.06	4.88	6.50	8.12	9.75	14.62
L	2.94	3.67	4.41	5.88	7.34	8.81	13.22
M	3.69	4.61	5.53	7.38	9.22	11.06	16.59
N	3.19	3.98	4.78	6.38	7.97	9.56	14.34
O	3.31	4.14	4.97	6.62	8.28	9.94	14.91
P	3.19	3.98	4.78	6.38	7.97	9.56	14.34
Q	3.31	4.14	4.97	6.62	8.28	9.94	14.91
R	3.19	3.98	4.78	6.38	7.97	9.56	14.34
S	3.19	3.98	4.78	6.38	7.97	9.56	14.34
T	2.94	3.67	4.41	5.88	7.34	8.81	13.22
U	3.19	3.98	4.78	6.38	7.97	9.56	14.34
V	3.62	4.53	5.44	7.25	9.06	10.88	16.31
W	4.19	5.23	6.28	8.38	10.47	12.56	18.84
X	3.44	4.30	5.16	6.88	8.59	10.31	15.47
Y	4.00	5.00	6.00	8.00	10.00	12.00	18.00
Z	3.19	3.98	4.78	6.38	7.97	9.56	14.34

TABLE II NUMERAL TO NUMERAL CODE NUMBER			
PRECEDING LETTER	FOLLOWING LETTER		
	1 5	2 3 6 8 9 0	4 7
1	1	1	2
2	1	2	2
3	1	2	2
4	2	2	4
5	1	2	2
6	1	2	2
7	2	2	4
8	1	2	2
9	1	2	2
0	1	2	2

TABLE V WIDTH OF NUMERALS							
NUMERAL HEIGHT	4	5	6	8	10	12	18
1	1.19	1.48	1.78	2.38	2.97	3.56	5.34
2	3.19	3.98	4.78	6.38	7.97	9.56	14.34
3	3.19	3.98	4.78	6.38	7.97	9.56	14.34
4	3.69	4.61	5.53	7.38	9.22	11.06	16.59
5	3.19	3.98	4.78	6.38	7.97	9.56	14.34
6	3.19	3.98	4.78	6.38	7.97	9.56	14.34
7	3.19	3.98	4.78	6.38	7.97	9.56	14.34
8	3.19	3.98	4.78	6.38	7.97	9.56	14.34
9	3.19	3.98	4.78	6.38	7.97	9.56	14.34
0	3.31	4.14	4.97	6.62	8.28	9.94	14.91

TABLE II WIDTH OF STROKE	
PRECEDING LETTER	STROKE WIDTH
4"	0.69
5"	0.86
6"	1.03
8"	1.38
10	1.72
"	2.06
12	3.09

TABLE VI WIDTH OF NUMERALS							
CODE NUMBER	4	5	6	8	10	12	18
1	1.03	1.29	1.55	2.05	2.58	3.09	4.64
2	0.82	1.03	1.24	1.65	2.06	2.48	3.71
3	0.55	0.69	0.82	1.10	1.37	1.65	2.47
4	0.28	0.34	0.41	0.55	0.68	0.82	1.24

SPACE in inches measured horizontally from the extreme right edge of the preceding letter to the extreme left edge of the following letter (numeral).

APPENDIX C-6A

SERIES E

10/97

LETTER & NUMERAL WIDTHS AND SPACE BETWEEN LETTERS AND NUMERAL (IN MILLIMETERS)

To determine the proper space between letters or numerals, obtain the code number from table I or II and enter table VI for that code number to the desired letter or numeral height.

TABLE I LETTER TO LETTER CODE NUMBER			
PRECEDING LETTER	FOLLOWING LETTER		
	BDFHI K	CGO QSX	AJT VW
A	2	2	4
B	1	2	2
C	2	2	3
D	1	2	2
E	2	2	3
F	2	2	3
G	1	2	2
H	1	1	2
I	1	1	2
J	1	1	2
K	2	2	3
L	2	2	4
M	1	1	2
N	1	1	2
O	1	2	2
P	1	2	2
Q	1	2	2
R	1	2	2
S	1	2	2
T	2	2	4
U	1	1	2
V	2	2	4
W	2	2	4
X	2	2	3
Y	2	2	4
Z	2	2	3

TABLE IV WIDTH OF LETTER IN MILLIMETERS										
LETTER	HEIGHT 75	100	125	150	175	200	225	250	300	400
A	76	102	127	152	178	203	228	254	305	406
B	60	81	101	121	142	162	182	202	243	324
C	60	81	101	121	142	162	182	202	243	324
D	60	81	101	121	142	162	182	202	243	324
E	56	75	93	112	130	149	168	186	224	298
F	56	75	93	112	130	149	168	186	224	298
G	60	81	101	121	142	162	182	202	243	324
H	60	81	101	121	142	162	182	202	243	324
I	13	18	22	26	30	35	40	44	52	70
J	57	76	95	114	133	152	171	190	229	304
K	62	83	103	124	144	165	186	206	248	330
L	56	75	93	112	130	149	168	186	224	298
M	70	94	117	140	164	187	210	243	281	374
N	60	81	101	121	142	162	182	202	243	324
O	63	84	105	126	147	168	189	210	252	336
P	60	81	101	121	142	162	182	202	243	324
Q	63	84	105	126	147	168	189	210	252	336
R	60	81	101	121	142	162	182	202	243	324
S	60	81	101	121	142	162	182	202	243	324
T	56	75	93	112	130	149	168	186	224	298
U	60	81	101	121	142	162	182	202	243	324
V	69	92	115	138	161	184	207	230	276	368
W	80	106	133	160	186	213	240	266	319	426
X	66	87	109	131	153	175	196	218	262	350
Y	76	102	127	152	178	203	228	254	305	406
Z	60	81	101	121	142	162	182	202	243	324

TABLE II NUMERAL TO NUMERAL CODE NUMBER			
PRECEDING LETTER	FOLLOWING LETTER		
	1 5	2 3 6 8 9 0	4 7
1	1	1	2
2	1	2	2
3	1	2	2
4	2	2	4
5	1	2	2
6	1	2	2
7	2	2	4
8	1	2	2
9	1	2	2
0	1	2	2

TABLE V WIDTH OF NUMERAL IN MILLIMETERS										
Numeral Height	75	100	125	150	175	200	225	250	300	400
1	22	30	38	45	52	60	68	75	90	120
2	60	81	101	121	142	162	182	202	243	324
3	60	81	101	121	142	162	182	202	243	324
4	70	94	117	140	164	187	210	234	281	374
5	60	81	101	121	142	162	182	202	243	324
6	60	81	101	121	142	162	182	202	243	324
7	60	81	101	121	142	162	182	202	243	324
8	60	81	101	121	142	162	182	202	243	324
9	60	81	101	121	142	162	182	202	243	324
0	63	84	105	126	147	168	189	210	252	336

TABLE III WIDTH OF STROKE	
LETTER OR NUMERAL HEIGHT	STROKE WIDTH IN MILLIMETERS
75	13
100	18
125	22
150	26
175	30
200	35
225	40
250	44
300	52
400	70

TABLE VI WIDTH OF NUMERALS IN MILLIMETERS										
CODE NUMBER	75	100	125	150	175	200	225	250	300	400
1	20	26	33	39	46	52	59	66	78	104
2	16	21	26	32	37	42	47	52	63	84
3	10	14	18	21	24	28	32	35	42	56
4	5	7	9	10	12	14	16	17	21	28

Space in millimeters measured horizontally from the extreme right edge of the preceding letter (or numeral) to the extreme left edge of the following letter (or numeral).

APPENDIX C-6B

SERIES E(M)

10/97

LETTER & NUMERAL WIDTHS AND SPACE BETWEEN LETTERS AND NUMERAL (IN MILLIMETERS)

To determine the proper space between letters or numerals, obtain the code number from table I or II and enter table VI for that code number to the desired letter or numeral height.

TABLE I LETTER TO LETTER CODE NUMBER			
PRECEDING LETTER	FOLLOWING LETTER		
	BDEFHI K	CGO QX	AJT VW
A	2	2	4
B	1	2	2
C	2	2	3
D	1	2	2
E	2	2	3
F	2	2	3
G	1	2	2
H	1	1	2
I	1	1	2
J	1	1	2
K	2	2	3
L	2	2	4
M	1	1	2
N	1	1	2
O	1	2	2
P	1	2	2
Q	1	2	2
R	1	2	2
S	1	2	2
T	2	2	4
U	1	1	2
V	2	2	4
W	2	2	4
X	2	2	3
Y	2	2	4
Z	2	2	3

TABLE IV WIDTH OF LETTER IN MILLIMETERS					
LETTER HEIGHT	200	265	330	400	500
A	203	271	338	406	508
B	162	216	270	324	405
C	162	216	270	324	405
D	162	216	270	324	405
E	149	199	248	298	372
F	149	199	248	298	372
G	162	216	270	324	405
H	162	216	270	324	405
I	40	53	66	80	100
J	152	203	253	304	380
K	165	220	275	330	412
L	149	199	248	298	372
M	187	249	312	374	468
N	162	216	270	324	405
O	168	224	280	336	420
P	162	216	270	324	405
Q	168	224	280	336	420
R	162	216	270	324	405
S	162	216	270	324	405
T	149	199	248	298	372
U	162	216	270	324	405
V	184	245	307	368	460
W	213	284	355	426	532
X	175	233	292	350	438
Y	203	271	338	406	508
Z	162	216	270	324	405

TABLE II NUMERAL TO NUMERAL CODE NUMBER			
PRECEDING LETTER	FOLLOWING LETTER		
	1 5	2 3 6 8 9 0	4 7
1	1	1	2
2	1	2	2
3	1	2	2
4	2	2	4
5	1	2	2
6	1	2	2
7	2	2	4
8	1	2	2
9	1	2	2
0	1	2	2

TABLE V WIDTH OF NUMERAL IN MILLIMETERS					
Numeral Height	200	265	330	400	500
1	60	80	100	120	150
2	162	216	270	324	405
3	162	216	270	324	405
4	187	249	312	374	468
5	162	216	270	324	405
6	162	216	270	324	405
7	162	216	270	324	405
8	162	216	270	324	405
9	162	216	270	324	405
0	168	224	280	336	420

TABLE III WIDTH OF STROKE	
LETTER OR NUMERAL HEIGHT	STROKE WIDTH IN MILLIMETERS
200	40
265	53
330	66
400	80
500	100

TABLE VI WIDTH OF NUMERALS IN MILLIMETERS					
CODE NUMBER	200	265	330	400	500
1	52	69	87	104	130
2	42	56	70	84	105
3	28	37	47	56	70
4	14	19	23	28	35

Space in millimeters measured horizontally from the extreme right edge of the preceding letter (or numeral) to the extreme left edge of the following letter (or numeral).

APPENDIX C-7

SERIES F

10/97

LETTER & NUMERAL WIDTHS AND SPACE BETWEEN LETTERS AND NUMERAL (IN INCHES)

To determine the proper space between letters or numerals, obtain the code number from table I or II and enter table VI for that code number to the desired letter or numeral height.

TABLE I LETTER TO LETTER CODE NUMBER			
PRECEDING LETTER	FOLLOWING LETTER		
	BDFHI K	CGO QSX	AJT VW
A	2	2	4
B	1	2	2
C	2	2	3
D	1	2	2
E	2	2	3
F	2	2	3
G	1	2	2
H	1	1	2
I	1	1	2
J	1	1	2
K	2	2	3
L	2	2	4
M	1	1	2
N	1	1	2
O	1	2	2
P	1	2	2
Q	1	2	2
R	1	2	2
S	1	2	2
T	2	2	4
U	1	1	2
V	2	2	4
W	2	2	4
X	2	2	3
Y	2	2	4
Z	2	2	3

TABLE IV WIDTH OF LETTER							
LETTER HEIGHT	WIDTH OF LETTER						
	4	5	6	8	10	12	18
A	4.50	5.62	6.75	9.00	11.25	13.50	20.25
B	3.69	4.61	5.53	7.38	9.22	11.06	16.59
C	3.69	4.61	5.53	7.38	9.22	11.06	16.59
D	3.69	4.61	5.53	7.38	9.22	11.06	16.59
E	3.19	3.98	4.78	6.38	7.97	9.56	14.34
F	3.19	3.98	4.78	6.38	7.97	9.56	14.34
G	3.69	4.61	5.53	7.38	9.22	11.06	16.59
H	3.69	4.61	5.53	7.38	9.22	11.06	16.59
I	0.75	0.94	1.12	1.50	1.88	2.25	3.38
J	3.25	4.06	4.88	6.50	8.12	9.75	14.62
K	3.69	4.61	5.53	7.38	9.22	11.06	16.59
L	3.38	4.22	5.06	6.75	8.44	10.12	15.19
M	4.25	5.31	6.38	8.50	10.62	12.75	19.12
N	3.69	4.61	5.53	7.38	9.22	11.06	16.59
O	4.12	5.16	6.19	8.25	10.32	12.38	18.56
P	3.69	4.61	5.53	7.38	9.22	11.06	16.59
Q	4.12	5.16	6.19	8.25	10.32	12.38	18.56
R	3.69	4.61	5.53	7.38	9.22	11.06	16.59
S	3.69	4.61	5.53	7.38	9.22	11.06	16.59
T	3.38	4.22	5.06	6.75	8.44	10.12	15.19
U	3.69	4.61	5.53	7.38	9.22	11.06	16.59
V	4.12	5.16	6.19	8.25	10.32	12.38	18.56
W	4.62	5.78	6.94	9.25	11.56	13.88	20.81
X	4.00	5.00	6.00	8.00	10.00	12.00	18.00
Y	4.50	5.62	6.75	9.00	11.25	13.50	20.25
Z	3.69	4.61	5.53	7.38	9.22	11.06	16.59

TABLE II NUMERAL TO NUMERAL CODE NUMBER			
PRECEDING LETTER	FOLLOWING LETTER		
	1 5	2 3 6 8 9 0	4 7
1	1	1	2
2	1	2	2
3	1	2	2
4	2	2	4
5	1	2	2
6	1	2	2
7	2	2	4
8	1	2	2
9	1	2	2
0	1	2	2

TABLE V WIDTH OF NUMERALS							
NUMERAL HEIGHT	WIDTH OF NUMERALS						
	4	5	6	8	10	12	18
1	1.31	1.64	1.97	2.62	3.28	3.94	5.91
2	3.69	4.61	5.53	7.38	9.22	11.06	16.59
3	3.69	4.61	5.53	7.38	9.22	11.06	16.59
4	4.00	5.00	6.00	8.00	10.00	12.00	18.00
5	3.69	4.61	5.53	7.38	9.22	11.06	16.59
6	3.69	4.61	5.53	7.38	9.22	11.06	16.59
7	3.69	4.61	5.53	7.38	9.22	11.06	16.59
8	3.69	4.61	5.53	7.38	9.22	11.06	16.59
9	3.69	4.61	5.53	7.38	9.22	11.06	16.59
0	3.81	4.77	5.72	7.62	9.53	11.44	17.16

TABLE II WIDTH OF STROKE	
PRECEDING LETTER	STROKE WIDTH IN INCHES
4"	0.75
5"	0.94
6"	1.12
8"	1.50
10	1.88
"	2.25
12	3.38

TABLE VI WIDTH OF NUMERALS							
CODE NUMBER	WIDTH OF NUMERALS						
	4	5	6	8	10	12	18
1	1.13	1.41	1.69	2.25	2.71	3.37	5.06
2	0.90	1.13	1.35	1.80	2.25	2.70	4.05
3	0.60	0.75	0.90	1.20	1.50	1.80	2.70
4	0.30	0.38	0.45	0.60	0.75	0.90	1.35

SPACE in inches measured horizontally from the extreme right edge of the preceding letter to the extreme left edge of the following letter (numeral).

APPENDIX C-7A

SERIES F

10/97

LETTER & NUMERAL WIDTHS AND SPACE BETWEEN LETTERS AND NUMERAL (IN MILLIMETERS)

To determine the proper space between letters or numerals, obtain the code number from table I or II and enter table VI for that code number to the desired letter or numeral height.

TABLE I LETTER TO LETTER CODE NUMBER			
PRECEDING LETTER	FOLLOWING LETTER		
	BDFHI K	CGO QSX	AJT VW
A	2	2	4
B	1	2	2
C	2	2	3
D	1	2	2
E	2	2	3
F	2	2	3
G	1	2	2
H	1	1	2
I	1	1	2
J	1	1	2
K	2	2	3
L	2	2	4
M	1	1	2
N	1	1	2
O	1	2	2
P	1	2	2
Q	1	2	2
R	1	2	2
S	1	2	2
T	2	2	4
U	1	1	2
V	2	2	4
W	2	2	4
X	2	2	3
Y	2	2	4
Z	2	2	3

TABLE IV WIDTH OF LETTER IN MILLIMETERS										
LETTER	75	100	125	150	175	200	225	250	300	400
A	86	114	143	171	200	229	258	286	343	458
B	70	94	117	140	164	187	210	234	281	374
C	70	94	117	140	164	187	210	234	281	374
D	70	94	117	140	164	187	210	234	281	374
E	60	81	101	121	142	162	182	202	243	324
F	60	81	101	121	142	162	182	202	243	324
G	70	94	117	140	164	187	210	234	281	374
H	70	94	117	140	164	187	210	234	281	374
I	14	19	24	28	33	38	43	48	57	76
J	62	83	103	124	144	165	186	206	248	330
K	70	94	117	140	164	187	210	234	281	374
L	64	86	107	128	150	171	192	214	257	342
M	81	108	135	162	189	216	243	270	324	432
N	70	94	117	140	164	187	210	234	281	374
O	78	105	131	157	184	210	236	262	314	420
P	70	94	117	140	164	187	210	234	281	374
Q	78	105	131	157	184	210	236	262	314	420
R	70	94	117	140	164	187	210	234	281	374
S	70	94	117	140	164	187	210	234	281	374
T	64	86	107	128	150	171	192	214	257	342
U	70	94	117	140	164	187	210	234	281	374
V	78	105	131	157	184	210	236	262	314	420
W	88	117	147	176	206	235	264	294	353	470
X	76	102	127	152	178	203	228	254	305	406
Y	86	114	143	171	200	229	258	286	343	458
Z	70	94	117	140	164	187	210	234	281	374

TABLE II NUMERAL TO NUMERAL CODE NUMBER			
PRECEDING LETTER	FOLLOWING LETTER		
	1 5	2 3 6 8 9 0	4 7
1	1	1	2
2	1	2	2
3	1	2	2
4	2	2	4
5	1	2	2
6	1	2	2
7	2	2	4
8	1	2	2
9	1	2	2
0	1	2	2

TABLE V WIDTH OF NUMERAL IN MILLIMETERS										
Numeral Height	75	100	125	150	175	200	225	250	300	400
1	25	33	42	50	58	67	75	83	100	134
2	70	94	117	140	164	187	211	234	281	376
3	70	94	117	140	164	187	211	234	281	376
4	76	102	127	152	178	203	228	254	305	406
5	70	94	117	140	164	187	211	234	281	376
6	70	94	117	140	164	187	211	234	281	376
7	70	94	117	140	164	187	211	234	281	376
8	70	94	117	140	164	187	211	234	281	376
9	70	94	117	140	164	187	211	234	281	376
0	72	97	121	145	170	194	218	242	291	388

TABLE III WIDTH OF STROKE	
LETTER OR NUMERAL HEIGHT	STROKE WIDTH IN MILLIMETERS
75	14
100	19
125	24
150	28
175	33
200	38
225	43
250	48
300	57
400	76

TABLE VI WIDTH OF NUMERALS IN MILLIMETERS										
CODE NUMBER	75	100	125	150	175	200	225	250	300	400
1	22	29	36	43	50	57	63	69	86	114
2	17	23	29	34	40	46	52	57	69	92
3	12	15	19	23	26	30	34	38	46	60
4	6	8	10	11	13	15	17	19	23	30

Space in millimeters measured horizontally from the extreme right edge of the preceding letter (or numeral) to the extreme left edge of the following letter (or numeral).

APPENDIX C-8

10/97

SERIES E-MODIFIED AND LOWER CASE

The E-modified and lower-case spacing charts are used in determining destination message lengths. The charts may also be used in determining message lengths comprised of all series E-modified letters or numerals (For example in calculating the width of the mileage message on a distance sign the numerals are E-modified).

EXAMPLE:

To determine the length of the word "Kelso" in 10.67" upper-case, (u.c.) E-modified and 8" lower-case (l.c.), first go to table H-1 to find the width of the upper-case letter "K" and then to table H-2 to find widths of the lower case letters "elso". For this example, under the column 10.67"

Table	Col. 1		Col. 2
TABLE H-1	K	=	7-3/4"
TABLE H-2	e	=	6-7/8"
TABLE H-2	l	=	2-1/8"
TABLE H-2	s	=	6-7/8"
TABLE H-2	o	=	6-7/8"
			<u>30-1/2"</u>

Now go to Table H-3 (10.67) to determine letter to letter spacing since we are calculating for 10-2/3" u.c. and 8" l.c.

Col. 1		Col. 2		Space
K	to	e	=	2-1/8"
e	to	l	=	3-3/8"
l	to	s	=	3"
s	to	o	=	2-3/8"
				<u>10-7/8"</u>

Adding letter and spacing we get:

$30-1/2" + 10-7/8" = 41-3/8"$ which can be rounded off to 41" in determining the sign background width.

IN ALL CASES DO NOT FORGET END SPACES AND BORDER WIDTHS.

APPENDIX C-9

10/97

Neat Width of Upper Case Letters and Digits

COL. 1	COLUMN 2						
LETTER	6"	8"	10.67"	13.33"	16"	20"	24"
A	6 1/8	8 1/8	9 3/8	13 1/2	16 3/8	20 3/8	24 1/2
B	4 7/8	6 1/2	7 1/2	10 3/4	13	16 1/4	19 1/2
C	4 3/4	6 3/8	7 1/2	10 5/8	12 3/4	16	19 1/4
D	4 7/8	6 1/2	7 1/2	10 3/4	13	16 1/4	19 1/2
E	4 5/8	6 1/8	7 1/8	10 1/4	12 3/8	15 3/8	18 1/2
F	4 3/8	5 7/8	7 1/8	9 7/8	11 7/8	14 3/4	17 3/4
G	4 3/4	6 3/8	7 1/2	10 5/8	12 3/4	16	19 1/4
H	5	6 5/8	7 3/4	11	13 1/8	16 5/8	19 3/4
I	1 1/4	1 5/8	2	2 5/8	3 1/8	3 7/8	4 3/4
J	4 5/8	6 1/8	7 1/8	10 1/4	12 3/8	15 3/8	18 1/2
K	5	6 3/4	7 3/4	11 1/4	13 1/2	16 7/8	20
L	3 7/8	5 1/8	7 1/8	8 1/2	10 1/8	12 7/8	15
M	6 1/4	8 3/8	8 3/4	13 7/8	16 5/8	21	25
N	5	6 3/4	7 1/2	11 1/4	13 1/2	16 7/8	20
O	5	6 3/4	7 7/8	11 1/4	13 1/2	16 7/8	20
P	4 3/8	5 7/8	7 1/2	9 3/4	11 5/8	14 3/4	17 1/2
Q	5	6 3/4	7 7/8	11 1/4	13 1/2	16 7/8	20
R	5	6 5/8	7 1/2	11	13 1/8	16 5/8	19 3/4
S	5	6 5/8	7 1/2	11	13 1/8	16 5/8	19 3/4
T	4 1/2	6	7 1/8	10	12	15	18
U	5	6 5/8	7 1/2	11	13 1/4	16 5/8	20
V	5 1/2	7 3/8	8 3/8	12 1/4	14 3/4	18 1/2	22
W	6 1/2	8 5/8	9 3/4	14 3/8	17 1/4	21 5/8	26
X	6 1/8	8 1/8	8 1/8	13 1/2	16 1/8	20 3/8	24 1/4
Y	6 1/8	8 1/8	9 3/8	13 1/2	16 1/8	20 3/8	24 1/4
Z	5	6 5/8	7 5/8	11	13 1/8	16 5/8	19 3/4
1	2 1/8	2 3/4	3 1/4	4 1/8	5 3/8	6 3/4	8
2	4 7/8	6 1/2	8 5/8	9 3/4	13	16 1/4	17 1/2
3	4 7/8	6 1/2	8 5/8	9 3/4	13	16 1/4	18 1/4
4	5 3/8	7 1/8	10	10 1/2	14 1/4	17 3/4	21
5	4 7/8	6 1/2	8 5/8	9 3/4	13	16 1/4	18 1/2
6	4 7/8	6 1/2	8 3/4	9 3/4	13	16 1/2	18 1/4
7	4 7/8	6 1/2	8 5/8	9 3/4	13	16 1/4	18 1/4
8	4 7/8	6 1/2	8 5/8	10	13	16 1/4	18 1/2
9	4 7/8	6 1/2	8 3/4	9 3/4	13	16 1/2	18 1/4
0	5	6 3/4	7 7/8	11 1/4	13 1/2	16 7/8	20

TABLE H - 1

APPENDIX C-10

10/97

Neat Width of Lower Case Letters

COL. 1	COLUMN 2						
LETTER	4 1/2"	6"	8"	10"	12"	15"	18"
a	3 7/8	5 1/8	6 7/8	8 5/8	10 3/8	12 7/8	15 1/2
b	3 7/8	5 1/8	6 7/8	8 5/8	10 1/4	12 7/8	15 1/2
c	3 7/8	5 1/8	6 7/8	8 5/8	10 1/4	12 7/8	15 1/2
d	3 7/8	5 1/8	6 7/8	8 5/8	10 1/4	12 7/8	15 1/2
e	3 7/8	5 1/8	6 7/8	8 5/8	10 1/4	12 7/8	15 1/2
f	2 7/8	3 3/4	5	6 1/4	7 1/2	9 3/8	11 1/4
g	3 7/8	5 1/8	6 7/8	8 5/8	10 1/4	12 7/8	15 1/2
h	3 7/8	5 1/8	6 3/4	8 1/2	10 1/8	12 7/8	15 1/4
i	1 1/4	1 5/8	2 1/8	2 5/8	3 1/4	4	4 3/4
j	2 1/2	3 1/4	4 1/4	5 1/4	6 3/8	8 1/8	9 1/2
k	3 7/8	5 1/8	6 7/8	8 5/8	10 3/8	12 7/8	15 1/2
l	1 1/4	1 5/8	2 1/8	2 5/8	3 1/4	3 3/4	4 3/4
m	6 1/2	8 5/8	11 1/2	14 1/4	17 1/4	21 5/8	25 7/8
n	3 7/8	5 1/8	6 3/4	8 1/2	10 1/8	12 7/8	15 1/8
o	3 7/8	5 1/8	6 7/8	8 5/8	10 3/8	12 7/8	15 1/2
p	3 7/8	5 1/8	6 7/8	8 5/8	10 1/4	12 7/8	15 1/2
q	3 7/8	5 1/8	6 7/8	8 5/8	10 1/4	12 7/8	15 1/8
r	3 1/8	4 1/8	5 1/2	6 7/8	8 1/4	10 3/8	12 3/8
s	3 7/8	5 1/8	6 7/8	8 5/8	10 3/8	12 7/8	15 1/2
t	2 7/8	3 3/4	5	6 3/8	7 1/2	9 3/8	11 1/4
u	3 7/8	5 1/8	6 3/4	8 1/2	10 1/8	12 7/8	15 1/8
v	4 3/4	6 3/8	8 1/2	10 5/8	12 3/4	16	19 1/8
w	6 1/4	8 1/4	11	13 3/4	16 1/2	20 5/8	24 3/4
x	4 7/8	6 3/8	8 1/2	10 5/8	12 3/4	16	19
y	4 3/4	6 3/8	8 1/2	10 5/8	12 3/4	16	19 1/8
z	4 1/4	5 5/8	7 1/2	9 1/2	11 1/4	14	17

The digits used with the above alphabets are upper case digits of the same size as the initial upper case letter being used. (see preceding page.)

TABLE H - 2

APPENDIX C-11

5/98

Spacing of 6" Upper Case Letters and Digits with 4 1/2" Lower Case Letters

COLUMN 1	COLUMN 2										
	AVW Xac deg oq 5	BDE FHI KLM NPR U	bhi klm npr u	CG OQS Z 24 890	J	j	T stv 7	Y wf	xy	Z 1	36
A VWX ce 56	1 3/8	2	1 7/8	1 1/2	1 1/4	7/8	1 1/4	1 3/8	1 3/8	1 7/8	1 1/2
a d g h i j l m n q u	1 3/4	2 1/2	2 1/4	1 7/8	1 5/8	1 1/4	1 5/8	1 3/4	1 3/4	2 3/8	1 7/8
B 3	1 1/2	2 1/4	2 1/8	1 5/8	1 3/8	1 1/8	1 1/2	1 1/2	1 1/2	2 1/8	1 5/8
b f k o p s	1 1/4	2	1 3/4	1 3/8	1 1/8	3/4	1 1/8	1 1/4	1 1/4	1 7/8	1 3/8
C E G	1 1/2	2 1/8	2	1 1/2	1 3/8	1	1 3/8	1 1/2	1 1/2	2	1 5/8
D O P Q R 8 9 0	1 1/2	2 1/8	2	1 1/2	1 1/4	1	1 3/8	1 3/8	1 3/8	2	1 1/2
F T x 7	1 1/4	1 7/8	1 3/4	1 3/8	1 1/8	3/4	1 1/8	1 1/4	1 1/4	1 3/4	1 3/8
H I J M N U 1	2	2 3/4	2 1/2	2 1/8	1 7/8	1 1/2	1 7/8	2	2	2 5/8	2 1/8
K L w	1 1/4	1 7/8	1 3/4	1 1/4	1	3/4	1 1/8	1 1/8	1 1/8	1 3/4	1 3/8
r v y	1 1/8	1 7/8	1 5/8	1 1/4	1	5/8	1	1 1/8	1 1/8	1 3/4	1 1/4
S Y t z 2	1 3/8	2	1 7/8	1 3/8	1 1/8	7/8	1 1/4	1 1/4	1 1/4	1 7/8	1 1/2
Z	1 7/8	2 5/8	2 3/8	2	1 3/4	1 1/2	1 3/4	1 7/8	1 7/8	2 1/2	2
4	1 7/8	2 5/8	2 3/8	1 7/8	1 5/8	1 3/8	1 3/4	1 3/4	1 7/8	2 3/8	2

INSTRUCTION FOR USING THE ABOVE TABULATION

Locate the initial letter of the word being spaced in the left hand or "key" column. Locate the following letter in one of the column under the heading "Column 2" to ascertain the spacing between those two letters; then assume the second letter to be the "Key" letter and locate the third letter "Column 2." Proceed in this fashion until spacing for all the letters has been determined.

TABLE H-3 (6)

APPENDIX C-12

5/98

Spacing of 8" Upper Case Letters and Digits with 6" Lower Case Letters

COLUMN 1	COLUMN 2										
	AVW Xac deg oq 5	BDE FHI KLM NPR U	bhi klm npr u	CG OQS z 24 890	J	j	T stv 7	Y wf	xy	Z 1	36
A VWX ce 5 6	1 7/8	2 3/4	2 1/2	2	1 5/8	1 1/4	1 3/4	1 3/4	1 7/8	2 5/8	1 1/2
a d g h i j l m n q u	2 3/8	3 1/4	3	2 1/2	2 1/4	1 3/4	2 1/4	2 1/4	2 3/8	3 1/8	2 1/2
B 3	2 1/8	3	2 3/4	2 1/4	1 7/8	1 1/2	2	2	2	2 7/8	2 1/4
b f k o p s	1 3/4	2 5/8	2 3/8	1 7/8	1 1/2	1 1/8	1 5/8	1 5/8	1 3/4	2 1/2	1 7/8
C E G	2	3	2 3/4	2 1/8	1 7/8	1 3/8	1 7/8	2	2	2 3/4	2 1/4
D O P Q R 8 9 0	2	2 7/8	2 5/8	2	1 3/4	1 1/4	1 3/4	1 7/8	1 7/8	2 5/8	2
F T x 7	1 3/4	2 5/8	2 3/8	1 3/4	1 1/2	1	1 1/2	1 5/8	1 5/8	2 3/8	1 7/8
H I J M N U 1	2 3/4	3 5/8	3 3/8	2 7/8	2 1/2	2 1/8	2 5/8	2 5/8	2 3/4	3 1/2	2 7/8
K L w	1 5/8	2 1/2	2 1/4	1 3/4	1 3/8	1	1 1/2	1 1/2	1 5/8	2 3/8	1 7/8
r v y	1 5/8	2 1/2	2 1/4	1 3/4	1 3/8	7/8	1 3/8	1 1/2	1 1/2	2 1/4	1 3/4
S Y t z 2	1 7/8	2 3/4	2 1/2	1 7/8	1 5/8	1 1/8	1 5/8	1 3/4	1 3/4	2 1/2	2
Z	2 5/8	3 1/2	3 1/4	2 5/8	2 3/8	2	2 3/8	2 1/2	2 1/2	3 1/4	2 3/4
4	2 1/2	3 3/8	3 1/8	2 5/8	2 1/4	1 7/8	2 3/8	2 3/8	2 1/2	3 1/4	2 5/8

INSTRUCTION FOR USING THE ABOVE TABULATION

Locate the initial letter of the word being spaced in the left hand or "key" column. Locate the following letter in one of the column under the heading "Column 2" to ascertain the spacing between those two letters; then assume the second letter to be the "Key" letter and locate the third letter "Column 2." Proceed in this fashion until spacing for all the letters has been determined.

TABLE H-3 (8)

APPENDIX C-13

5/98

Spacing of 10.67" Upper Case Letters and Digits with 8" Lower Case Letters

COLUMN 1	COLUMN 2										
	AVW Xac deg oq 5	BDE FHI KLM NPR U	bhi klm npr u	CG OQS Z 24 890	J	j	T stv 7	Y wf	xy	Z 1	36
A V W X c e 5 6	2 1/2	3 5/8	3 3/8	2 1/2	2 1/8	1 5/8	2 1/4	2 3/8	2 3/8	3 1/2	2 5/8
a d g h i j l m n q u	3 1/4	4 3/8	4 1/8	3 1/4	2 7/8	2 3/8	3	3	3 1/8	4 1/8	3 3/8
B 3	2 3/4	4	3 5/8	2 7/8	2 1/2	1 7/8	2 1/2	2 5/8	2 3/4	3 3/4	3
b f k o p s	2 3/8	3 1/2	3 1/4	2 3/8	2	1 1/2	2	2 1/8	2 1/4	3 1/4	2 1/2
C E G	2 3/4	4	3 5/8	2 3/4	2 3/8	1 7/8	2 1/2	2 1/2	2 5/8	3 5/8	2 7/8
D O P Q R 8 9 0	2 1/2	3 3/4	3 1/2	2 5/8	2 1/4	1 3/4	2 3/8	2 3/8	2 1/2	3 1/2	2 3/4
F T x 7	2 1/4	3 1/2	3 1/8	2 3/8	1 7/8	1 3/8	2	2	2 1/8	3 1/4	2 3/8
H I J M N U 1	3 5/8	4 7/8	4 1/2	3 3/4	3 3/8	2 3/4	3 1/2	3 1/2	3 5/8	4 5/8	3 7/8
K L w	2 1/8	3 3/8	3	2 1/4	1 7/8	1 1/4	1 7/8	2	2	3 1/8	2 3/8
r v y	2	3 1/4	3	2 1/8	1 3/4	1 1/4	1 7/8	1 7/8	2	3	2 1/4
S Y t z	2 3/8	3 5/8	3 1/4	2 1/2	2	1 1/2	2 1/8	2 1/4	2 3/8	3 3/8	2 1/2
Z	3 1/2	4 5/8	4 3/8	3 1/2	3 1/8	2 1/2	3 1/4	3 1/4	3 3/8	4 3/8	3 5/8
4	3 3/8	4 1/2	4 1/4	4 1/4	3 1/2	3	2 1/2	3 1/8	3 1/4	4 3/8	3 1/2

INSTRUCTION FOR USING THE ABOVE TABULATION

Locate the initial letter of the word being spaced in the left hand or "key" column. Locate the following letter in one of the column under the heading "Column 2" to ascertain the spacing between those two letters; then assume the second letter to be the "Key" letter and locate the third letter "Column 2." Proceed in this fashion until spacing for all the letters has been determined.

TABLE H-3 (10.67)

APPENDIX C-14

5/98

Spacing of 13.33" Upper Case Letters and Digits with 10" Lower Case Letters

COLUMN 1	COLUMN 2										
	AVW Xac deg oq 5	BDE FHI KLM NPR U	bhi klm npr u	CG OQS z 24 890	J	j	T stv 7	Y wf	xy	Z 1	36
A V W X c e 5 6	3 1/8	4 5/8	4 1/4	3 1/4	2 3/4	2	2 7/8	3	3	4 3/8	3 3/8
a d g h i j l m n q u	4	5 1/2	5 1/8	4 1/8	3 5/8	3	3 3/4	3 7/8	4	5 1/4	4 1/4
B 3	3 1/2	5	4 5/8	3 5/8	3 1/8	2 3/8	3 1/4	3 3/8	3 3/8	4 3/4	3 3/4
b f k o p s	3	4 1/2	4	3	2 1/2	1 7/8	2 5/8	2 3/4	2 7/8	4 1/8	3 1/8
C E G	3 3/8	5	4 1/2	3 1/2	3	2 3/8	3 1/8	3 1/4	3 3/8	4 5/8	3 5/8
D O P Q R 8 9 0	3 1/4	4 3/4	4 3/8	3 3/8	2 7/8	2 1/8	3	3	3 1/8	4 1/2	3 3/8
F T x 7	2 7/8	4 3/8	4	3	2 3/8	1 3/4	2 1/2	2 5/8	2 3/4	4	3
H I J M N U 1	4 5/8	6 1/8	5 3/4	4 3/4	4 1/4	3 1/2	4 3/8	4 1/2	4 1/2	5 7/8	4 7/8
K L w	2 3/4	4 1/4	3 7/8	2 7/8	2 3/8	1 5/8	2 3/8	2 1/2	2 5/8	4	3
r v y	2 5/8	4 1/8	3 3/4	2 3/4	2 1/4	1 1/2	2 3/8	2 3/8	2 1/2	3 7/8	2 7/8
S Y t z 2	3	4 1/2	4 1/8	3 1/8	2 5/8	2	2 3/4	2 7/8	3	4 1/4	3 1/4
Z	3 1/2	5 3/4	5 3/8	4 1/2	4	3 1/4	4	4 1/8	4 1/4	5 1/2	4 1/2
4	4 1/4	5 3/4	5 3/8	4 3/8	3 7/8	3 1/8	4	4	4 1/8	5 3/8	4 1/2

INSTRUCTION FOR USING THE ABOVE TABULATION

Locate the initial letter of the word being spaced in the left hand or "key" column. Locate the following letter in one of the column under the heading "Column 2" to ascertain the spacing between those two letters; then assume the second letter to be the "Key" letter and locate the third letter "Column 2." Proceed in this fashion until spacing for all the letters has been determined.

TABLE H-3 (13.33)

APPENDIX C-15

5/98

Spacing of 16" Upper Case Letters and Digits with 12" Lower Case Letters

COLUMN 1	COLUMN 2										
	AVW Xac deg oq 5	BDE FHI KLM NPR U	bhi klm npr u	CG OQS z 24 890	J	j	T stv 7	Y wf	xy	Z 1	36
A V W X c e 5 6	3 3/4	5 1/2	5	3 7/8	3 1/4	2 3/8	3 3/8	3 1/2	3 5/8	5 1/8	4
a d g h i j l m n q u	4 7/8	6 5/8	6 1/8	5	4 3/8	3 1/2	4 1/2	4 5/8	4 3/4	6 1/4	5
B 3	4 1/4	6	5 1/2	4 3/8	3 3/4	2 7/8	3 7/8	4	4 1/8	5 5/8	4 1/2
b f k o p s	3 1/2	5 1/4	4 7/8	3 5/8	3	2 1/8	3 1/8	3 1/4	3 3/8	5	3 3/4
C E G	4 1/8	5 7/8	5 3/8	4 1/4	3 5/8	2 3/4	3 3/4	3 7/8	4	5 1/2	4 3/8
D O P Q R 8 9 0	3 7/8	5 5/8	5 1/8	4	3 3/8	2 1/2	3 1/2	3 5/8	3 3/4	5 1/4	4 1/8
F T x 7	3 3/8	5 1/8	4 3/4	3 1/2	2 7/8	2	3	3 1/8	3 1/4	4 7/8	3 5/8
H I J M N U 1	5 1/2	7 3/8	6 7/8	5 5/8	5	4 1/4	5 1/8	5 1/4	5 3/8	7	5 3/4
K L w	3 1/4	5	4 5/8	3 3/8	2 3/4	1 7/8	2 7/8	3	3 1/8	4 3/4	3 1/2
r v y	3 1/8	5	4 1/2	3 1/4	2 5/8	1 3/4	2 3/4	2 7/8	3	4 5/8	3 3/8
S Y t z 2	3 5/8	5 3/8	5	3 3/4	3 1/8	2 1/4	3 1/4	3 3/8	3 1/2	5	3 7/8
Z	5 1/8	7	6 1/2	5 1/4	4 3/4	3 7/8	4 7/8	5	5	6 5/8	5 3/8
4	5	6 7/8	6 3/8	5 1/8	4 5/8	3 3/4	4 3/4	4 7/8	5	6 1/2	5 1/4

INSTRUCTION FOR USING THE ABOVE TABULATION

Locate the initial letter of the word being spaced in the left hand or "key" column. Locate the following letter in one of the column under the heading "Column 2" to ascertain the spacing between those two letters; then assume the second letter to be the "Key" letter and locate the third letter "Column 2." Proceed in this fashion until spacing for all the letters has been determined.

TABLE H-3 (16)

APPENDIX C-16

5/98

Spacing of 20" Upper Case Letters and Digits with 15" Lower Case Letters

COLUMN 1	COLUMN 2										
	AVW Xac deg oq 5	BDE FHI KLM NPR U	bhi klm npr u	CG OQS z 24 890	J	j	T stv 7	Y wf	xy	Z 1	36
A V W X c e 5 6	4 5/8	6 7/8	6 1/4	4 3/4	4	3	4 1/4	4 3/8	4 1/2	6 1/2	5
a d g h i j l m n q u	6	8 1/4	7 5/8	6 1/8	5 3/8	4 3/8	5 1/2	5 3/4	5 7/8	7 3/4	6 1/4
B 3	5 1/4	7 1/2	6 7/8	5 3/8	4 5/8	3 5/8	4 3/4	5	5 1/8	7	5 1/2
b f k o p s	4 3/8	6 5/8	6	4 1/2	3 3/4	2 3/4	3 7/8	4	4 1/4	6 1/8	4 5/8
C E G	5 1/8	7 3/8	6 3/4	5 1/4	4 1/2	3 1/2	4 5/8	4 3/4	5	6 7/8	5 3/8
D O P Q R 8 9 0	4 3/4	7	6 1/2	5	4 1/4	3 1/8	4 3/8	4 1/2	4 5/8	6 5/8	5 1/8
F T x 7	4 1/4	6 1/2	5 7/8	4 3/8	3 5/8	2 1/2	3 3/4	3 7/8	4	6	4 1/2
H I J M N U 1	6 7/8	9 1/8	8 1/2	7	6 1/4	5 1/4	6 1/2	6 5/8	6 3/4	8 3/4	7 1/4
K L w	4	6 1/4	5 3/4	4 1/4	3 1/2	2 3/8	3 5/8	3 3/4	3 7/8	5 7/8	4 3/8
r v y	3 7/8	6 1/8	5 1/2	4	3 1/4	2 1/4	3 1/2	3 5/8	3 3/4	5 3/4	4 1/4
S Y t z 2	4 1/2	6 3/4	6 1/8	4 5/8	3 7/8	2 7/8	4	4 1/4	4 3/8	6 1/4	4 3/4
Z	6 1/2	8 3/4	8 1/8	6 5/8	5 7/8	4 3/4	6	6 1/8	6 1/4	8 1/4	6 3/4
4	6 1/4	8 1/2	8	6 1/2	5 3/4	4 5/8	5 7/8	6	6 1/8	8 1/8	6 5/8

INSTRUCTION FOR USING THE ABOVE TABULATION

Locate the initial letter of the word being spaced in the left hand or "key" column. Locate the following letter in one of the column under the heading "Column 2" to ascertain the spacing between those two letters; then assume the second letter to be the "Key" letter and locate the third letter "Column 2." Proceed in this fashion until spacing for all the letters has been determined.

TABLE H-3 (20)

APPENDIX C-17

5/98

Spacing of 24" Upper Case Letters and Digits with 18" Lower Case Letters

COLUMN 1	COLUMN 2										
	AVW Xac deg oq 5	BDE FHI KLM NPR U	bhi klm npr u	CG OQS z 24 890	J	j	T stv 7	Y wf	xy	Z 1	36
A V W X c e 5 6	5 5/8	8 1/4	7 1/2	5 3/4	4 7/8	3 5/8	5	5 1/4	5 3/8	7 3/4	6
a d g h i j l m n q u	7 1/4	9 7/8	9 1/4	7 3/8	6 1/2	5 1/4	6 3/4	6 7/8	7	9 3/8	7 1/2
B 3	6 1/4	9	8 1/4	6 1/2	5 5/8	4 3/8	5 3/4	6	6 1/8	8 1/2	6 3/4
b f k o p s	5 1/4	7 7/8	7 1/4	5 3/8	4 1/2	3 1/4	4 5/8	4 7/8	5	7 3/8	5 5/8
C E G	6 1/8	8 7/8	8	6 1/4	5 3/8	4 1/8	5 5/8	5 3/4	6	8 1/4	6 1/2
D O P Q R 8 9 0	5 3/4	8 1/2	7 3/4	6	5	3 3/4	5 1/4	5 3/8	5 5/8	7 7/8	6 1/8
F T x 7	5	7 3/4	7	5 1/4	4 3/8	3	4 1/2	4 5/8	4 7/8	7 1/4	5 3/8
H I J M N U 1	8 1/4	1	10 1/4	8 1/2	7 1/2	6 1/4	7 3/4	7 7/8	8 1/8	10 1/2	8 5/8
K L w	4 7/8	7 1/2	6 7/8	5	4 1/8	2 7/8	4 3/8	4 1/2	4 5/8	7	5 1/4
r v y	4 5/8	7 3/8	6 3/4	4 7/8	4	2 3/4	4 1/8	4 3/8	4 1/2	6 7/8	5
S Y t z 2	5 3/8	8	7 3/8	5 5/8	4 5/8	3 3/8	4 7/8	5	5 1/4	7 1/2	5 3/4
Z	7 3/4	10 1/2	9 3/4	7 7/8	7	5 3/4	7 1/4	7 3/8	7 1/2	9 7/8	8
4	7 1/2	10 1/4	9 1/2	7 3/4	6 7/8	5 5/8	7	7 1/4	7 3/8	9 3/4	7 7/8

INSTRUCTION FOR USING THE ABOVE TABULATION

Locate the initial letter of the word being spaced in the left hand or "key" column. Locate the following letter in one of the column under the heading "Column 2" to ascertain the spacing between those two letters; then assume the second letter to be the "Key" letter and locate the third letter "Column 2." Proceed in this fashion until spacing for all the letters has been determined.

TABLE H-3 (24)

APPENDIX D-1

10/97

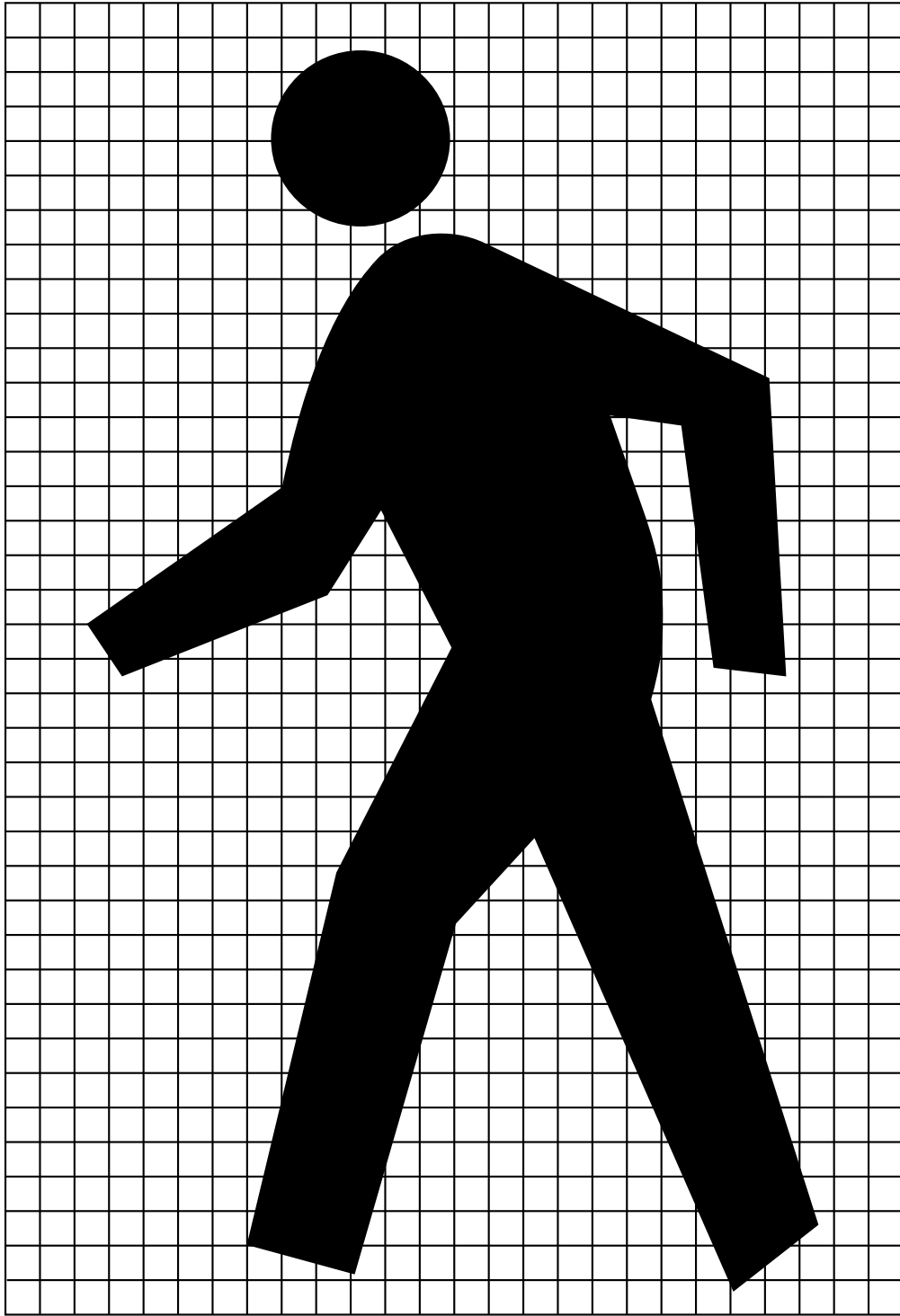

APPENDIX D-2

10/97

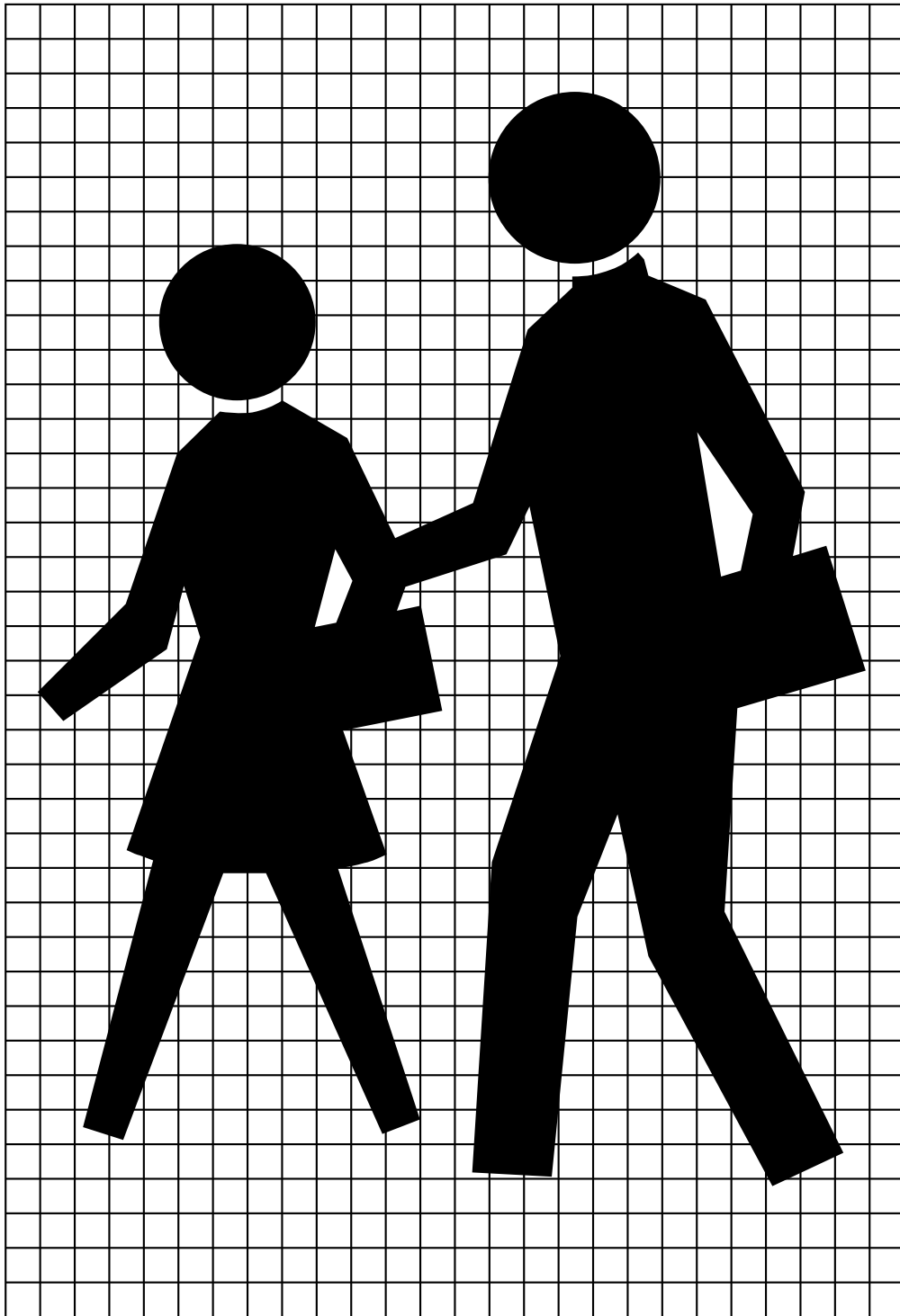

APPENDIX D-3

10/97

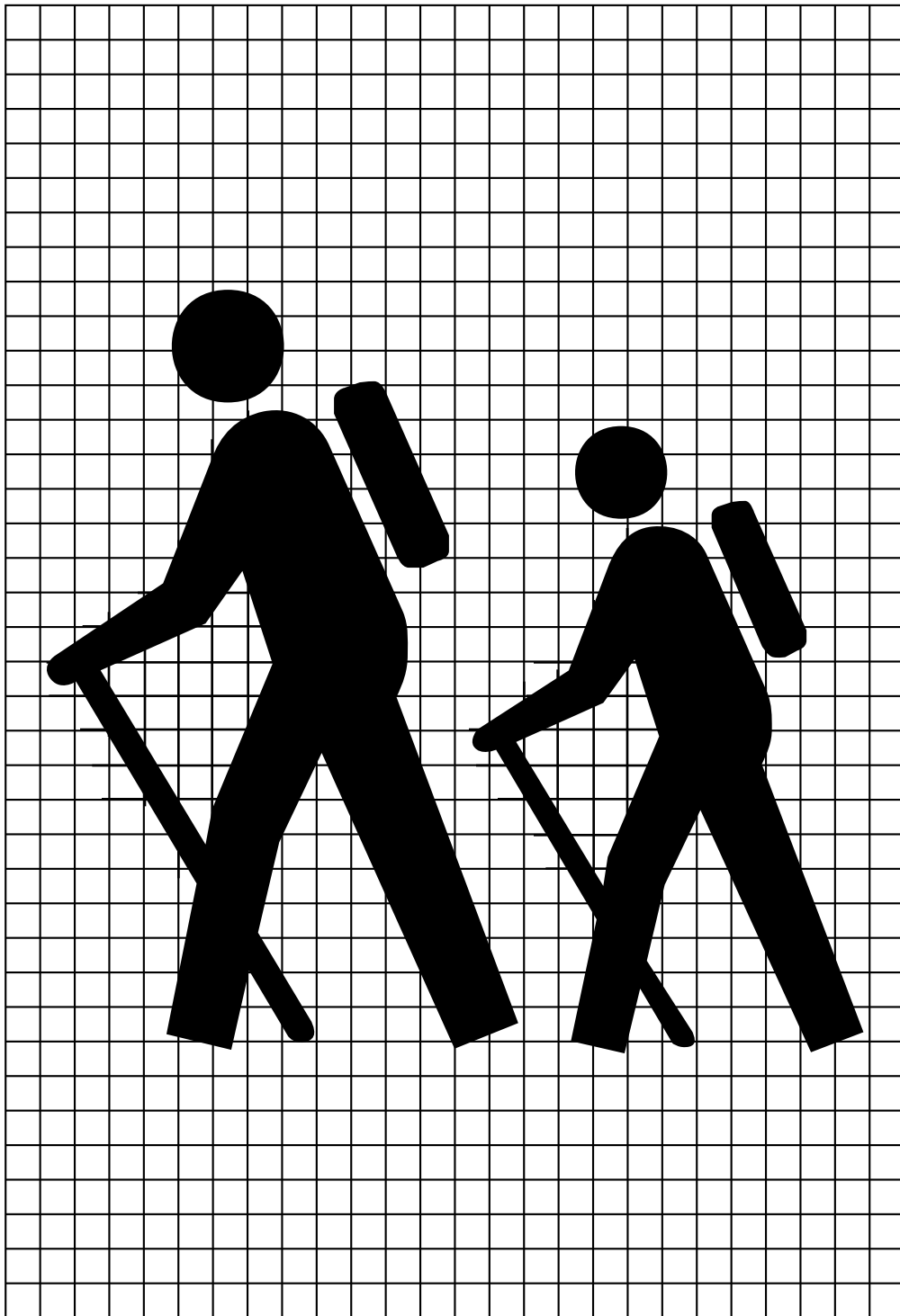

APPENDIX D-4

10/97

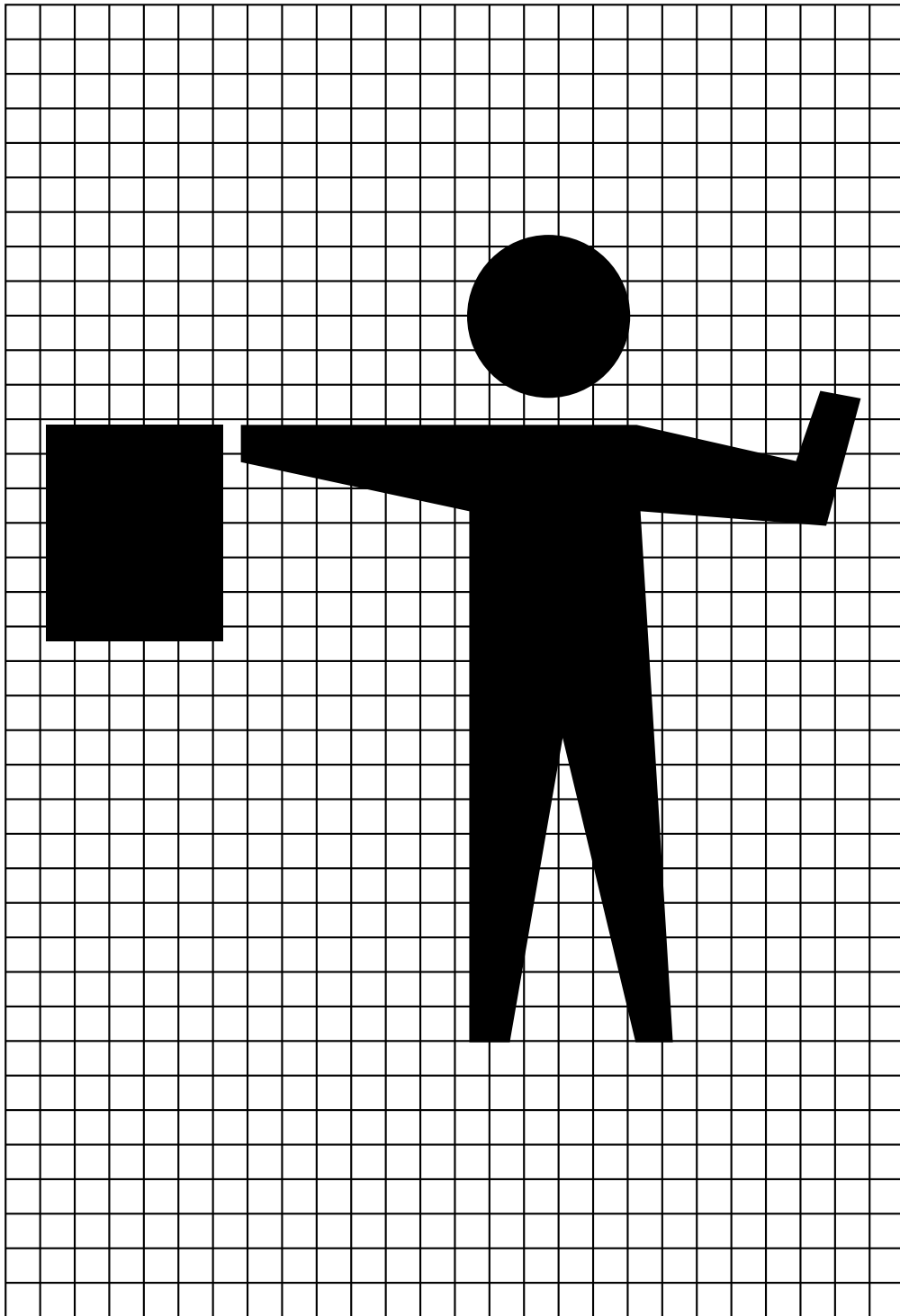

APPENDIX D-5

10/97

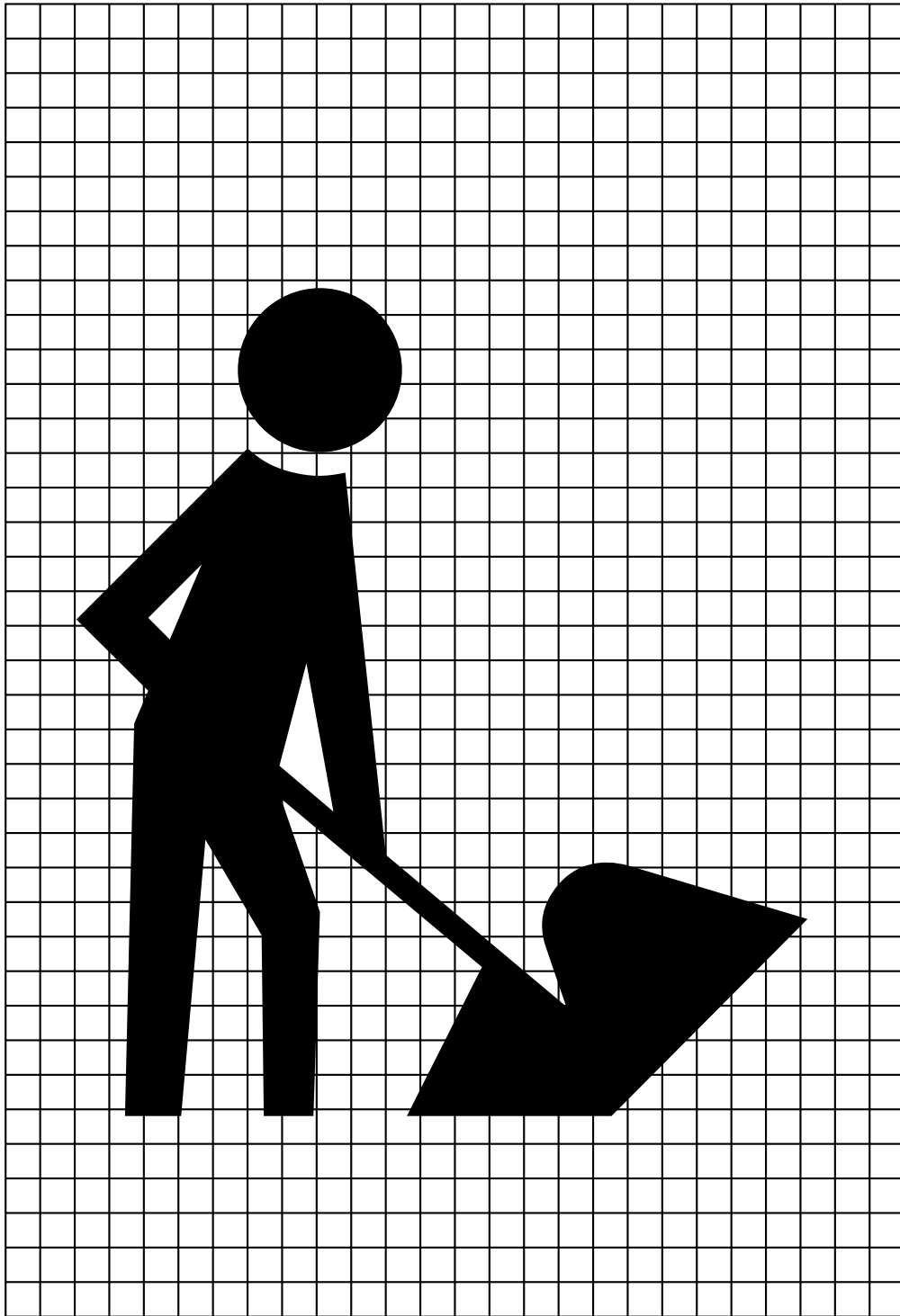

APPENDIX D-6

10/97

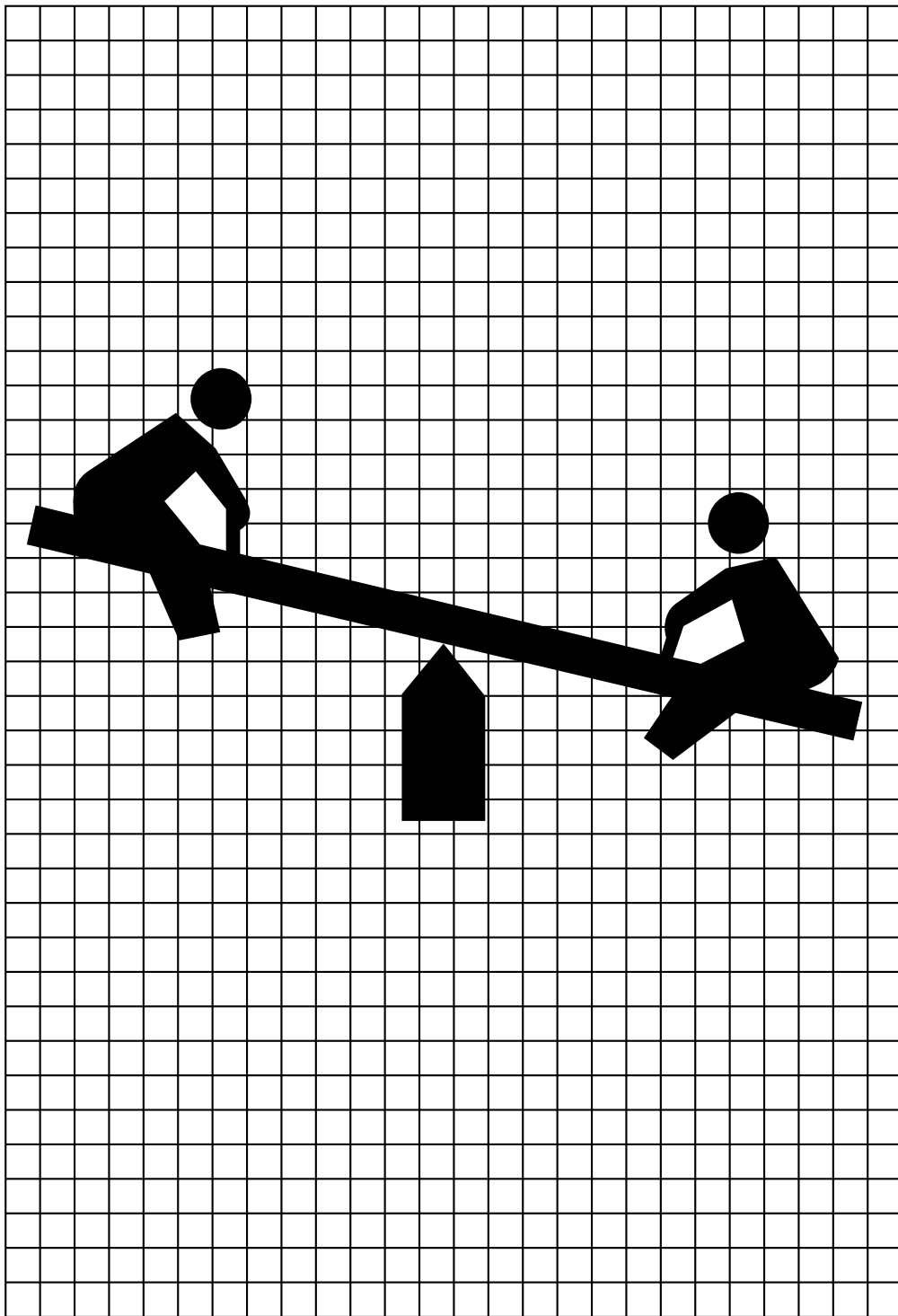

APPENDIX D-7

10/97

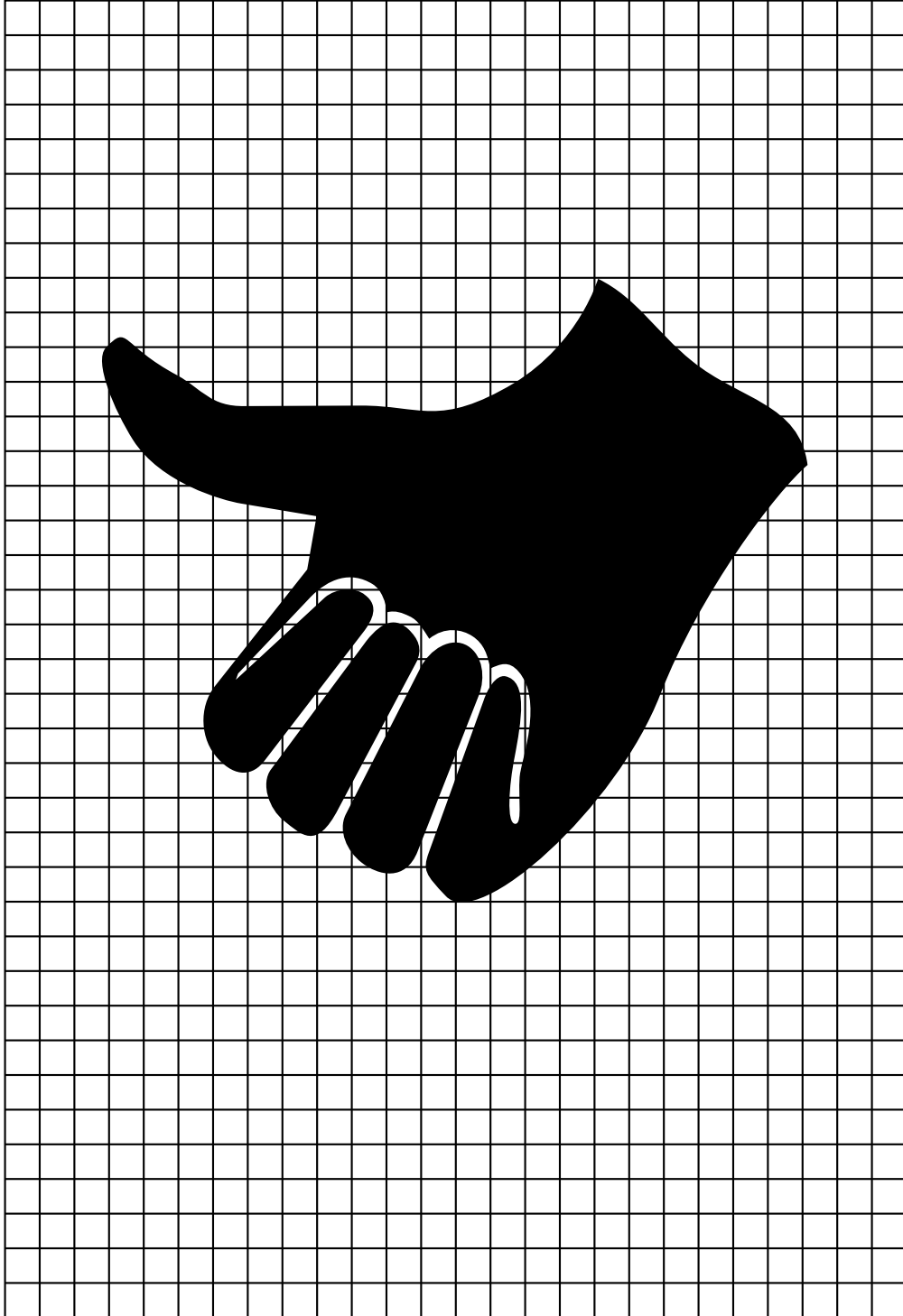

APPENDIX D-8

10/97

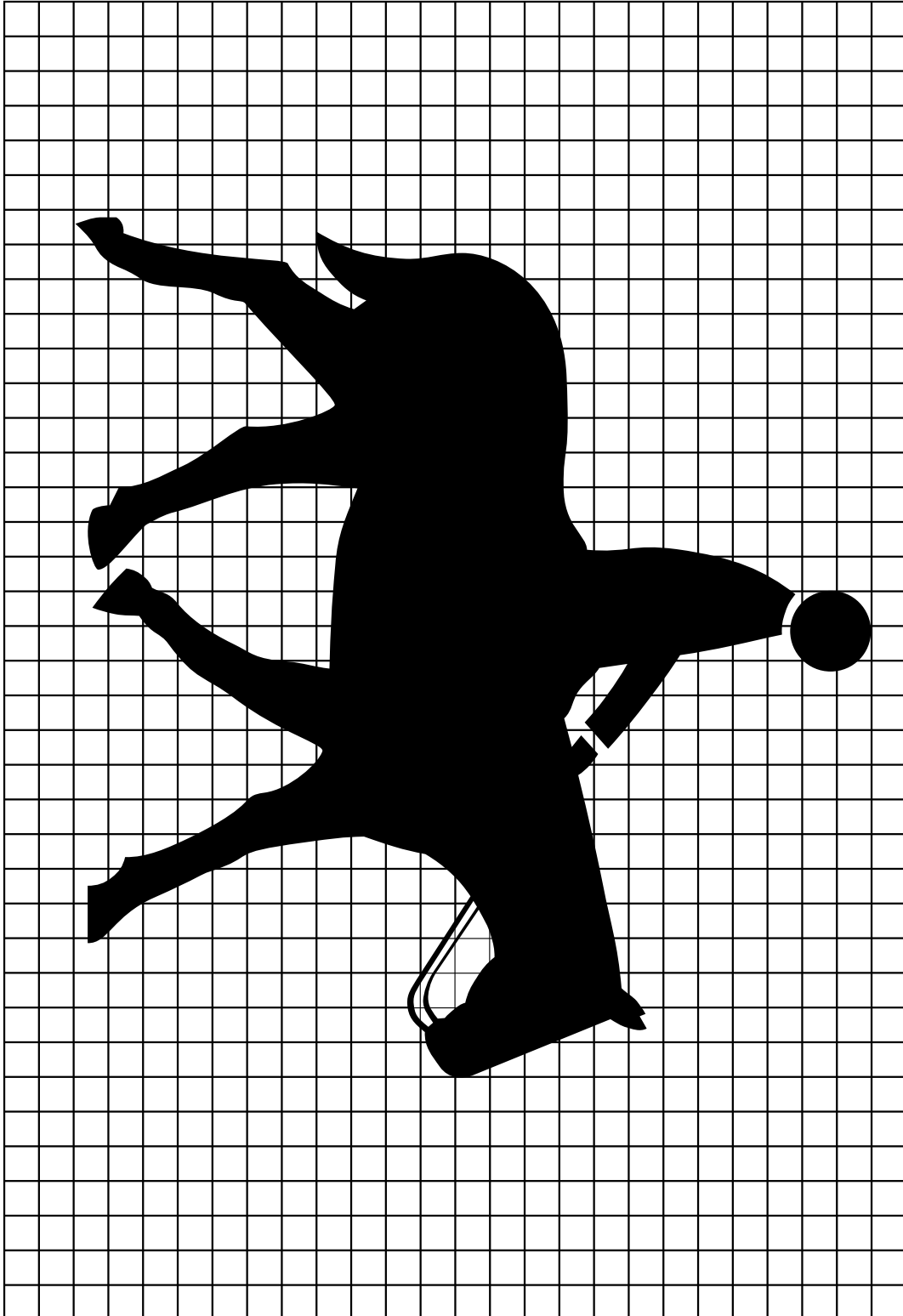

APPENDIX D-9

10/97

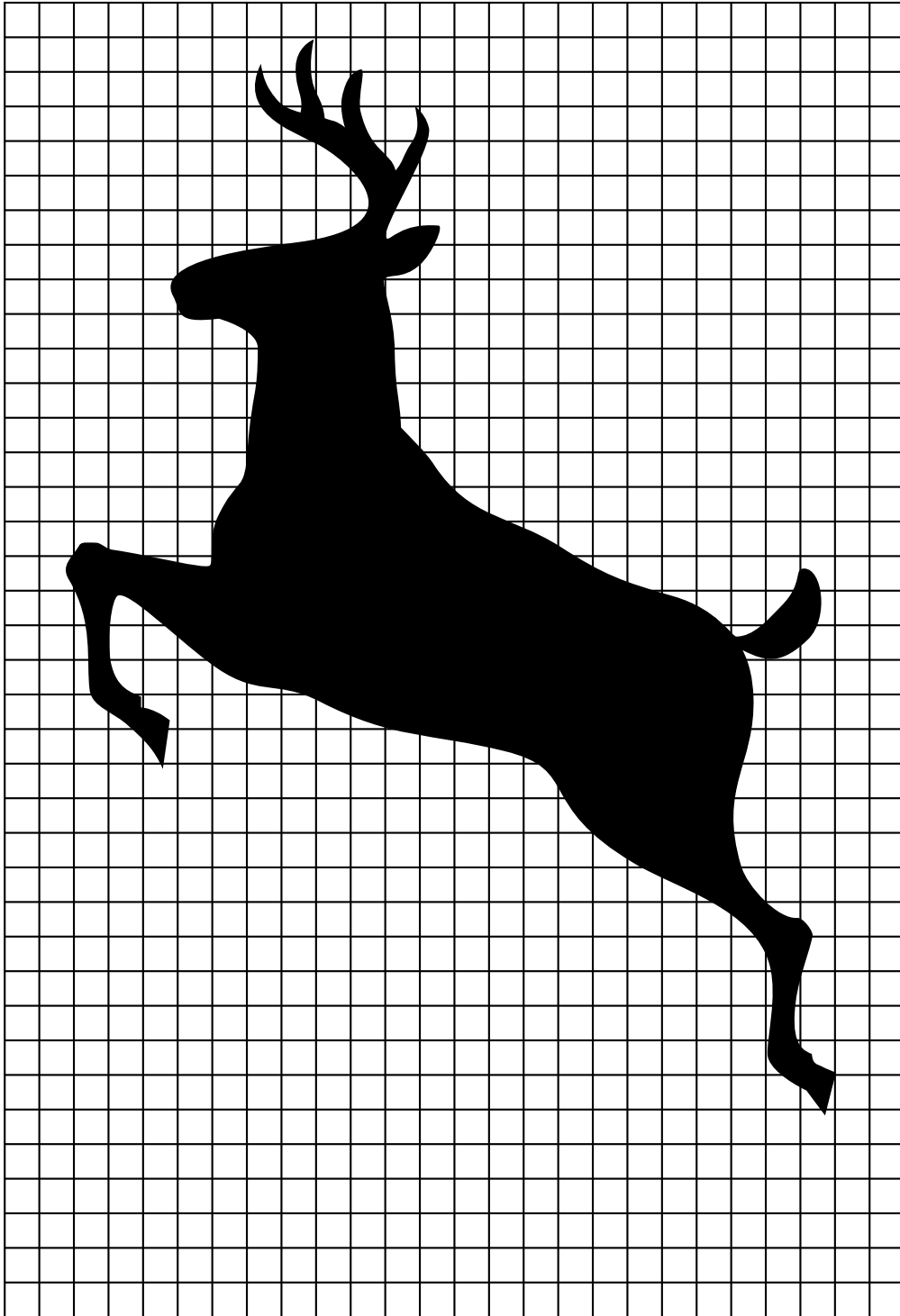

APPENDIX D-10

10/97

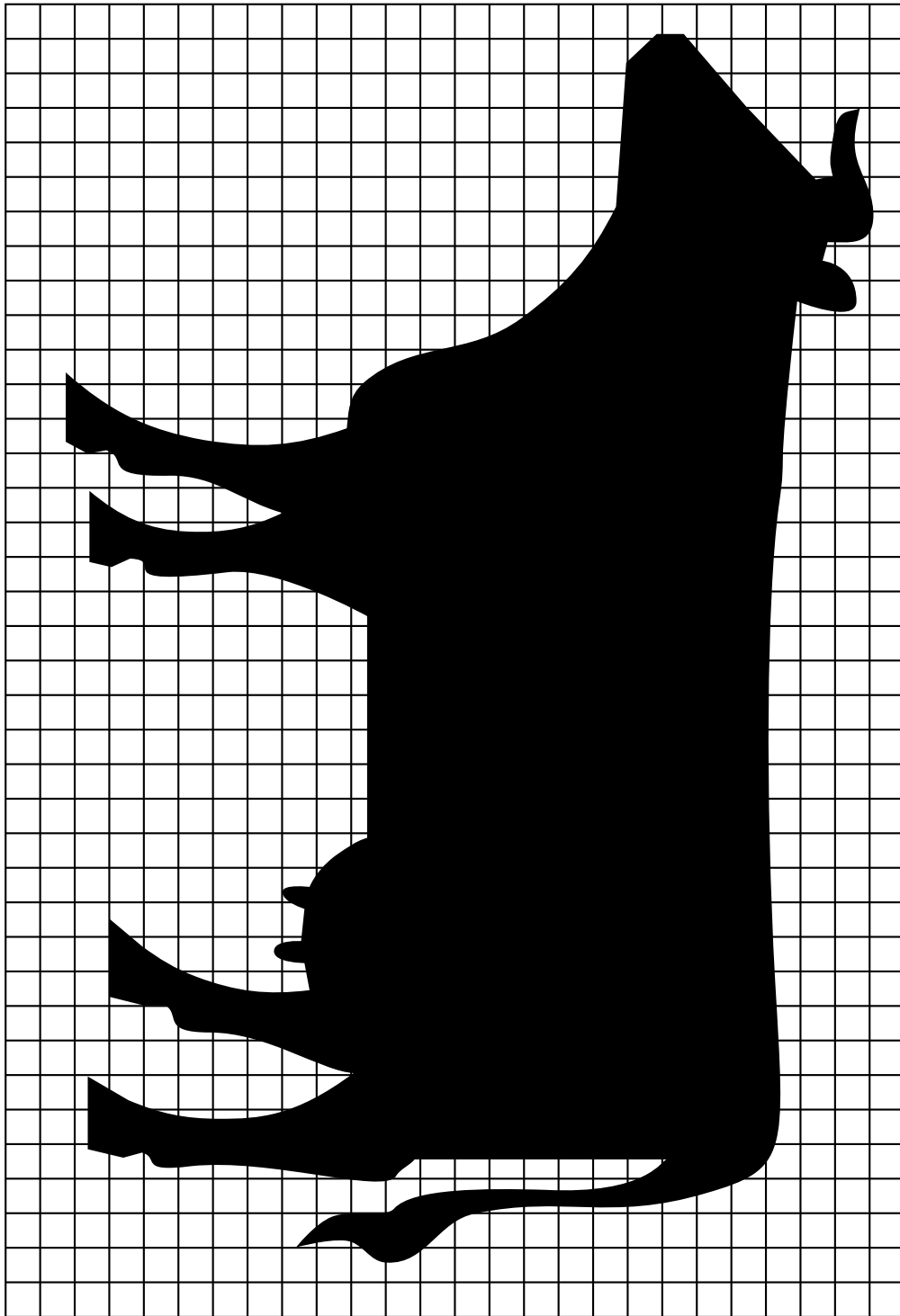

APPENDIX D-11

10/97

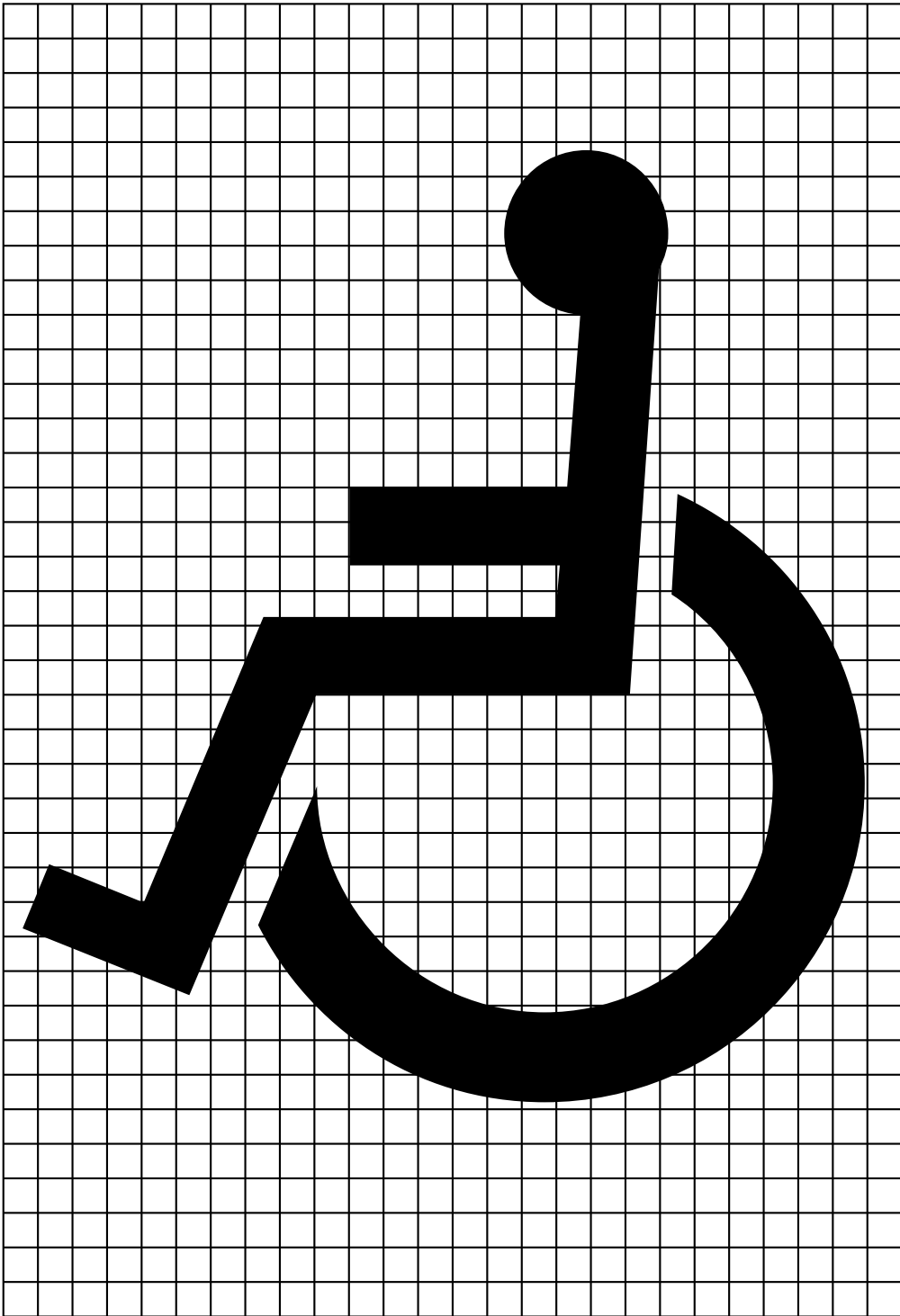

APPENDIX D-12

10/97

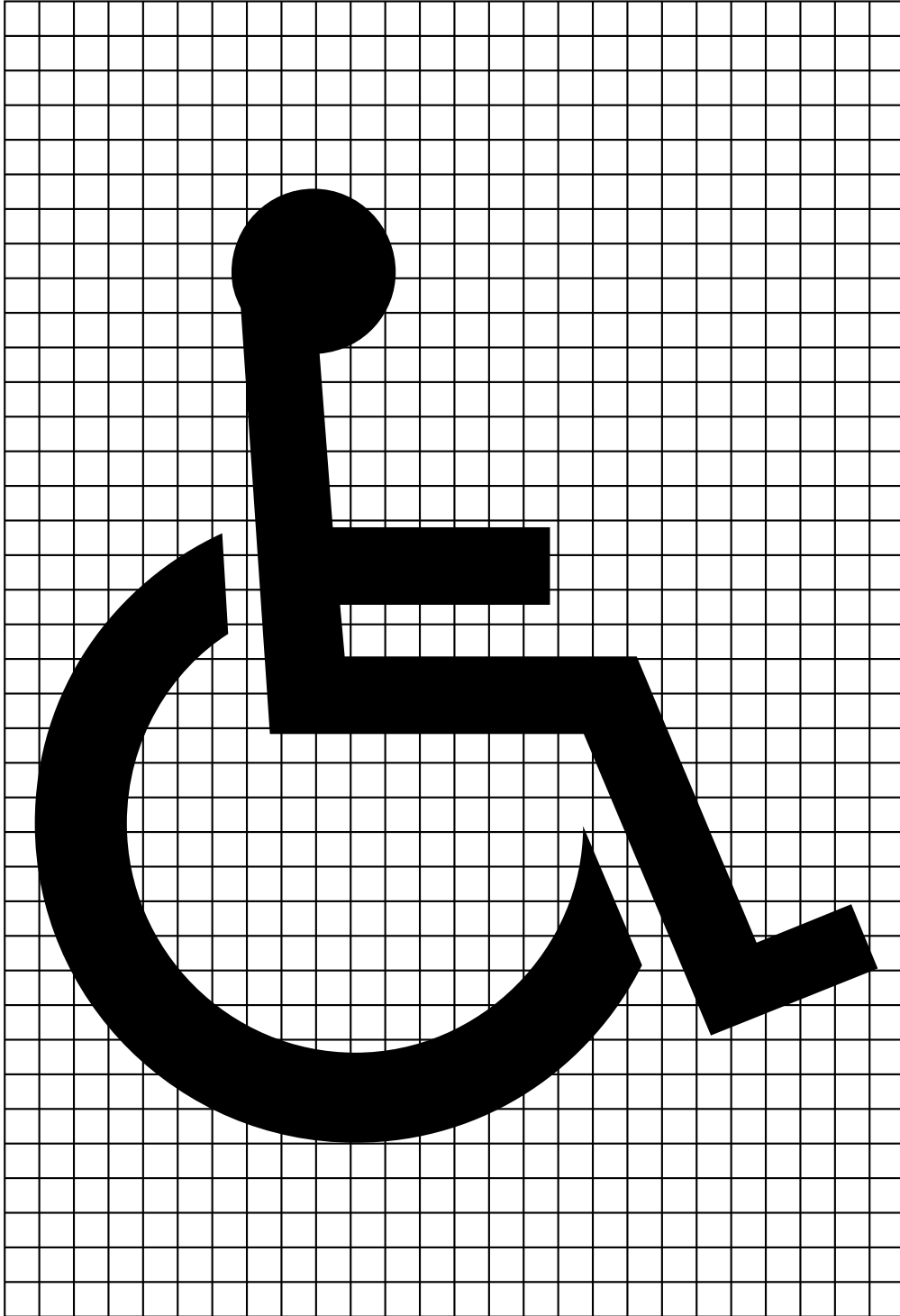

APPENDIX D-13

10/97

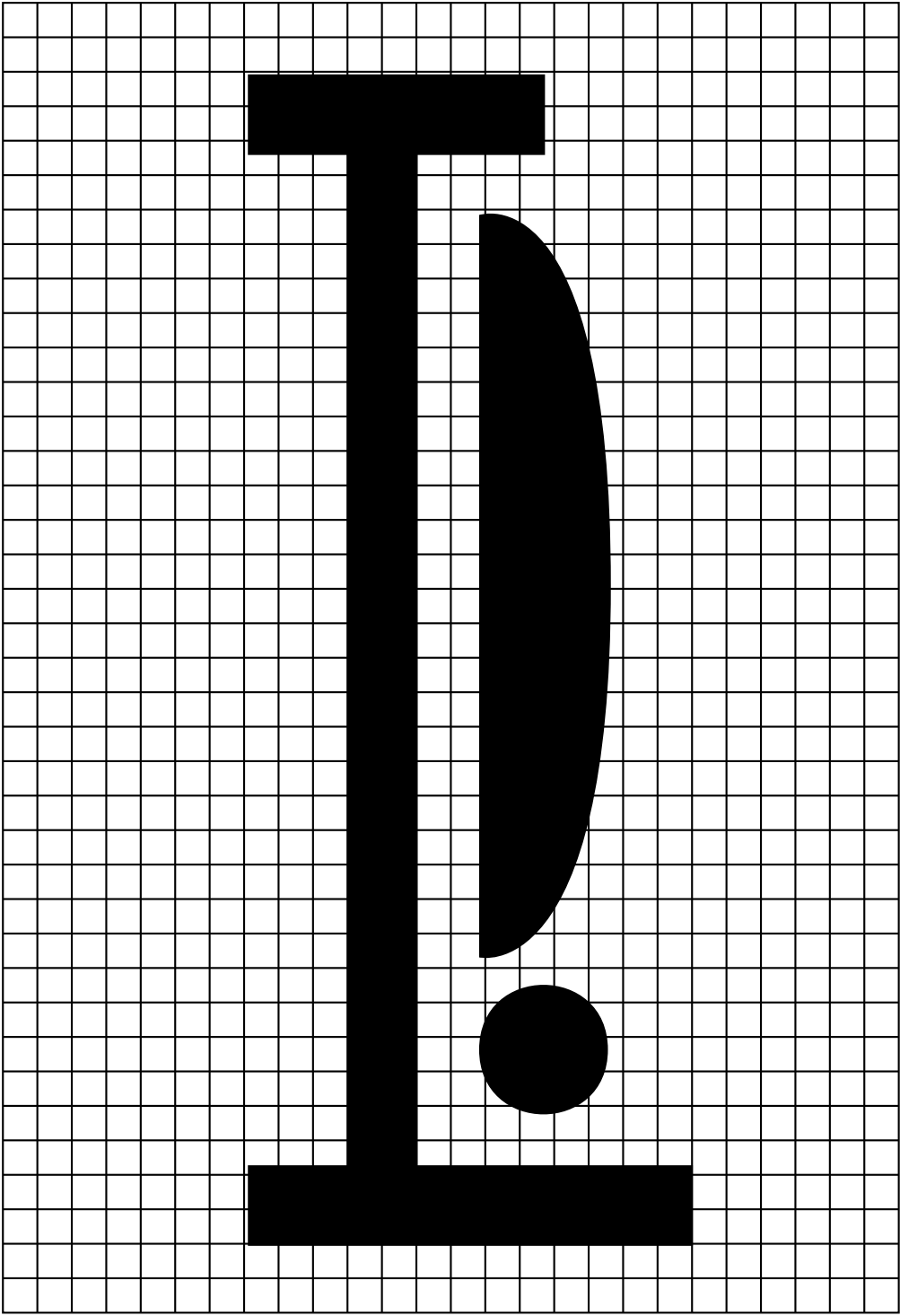

APPENDIX D-14

10/97

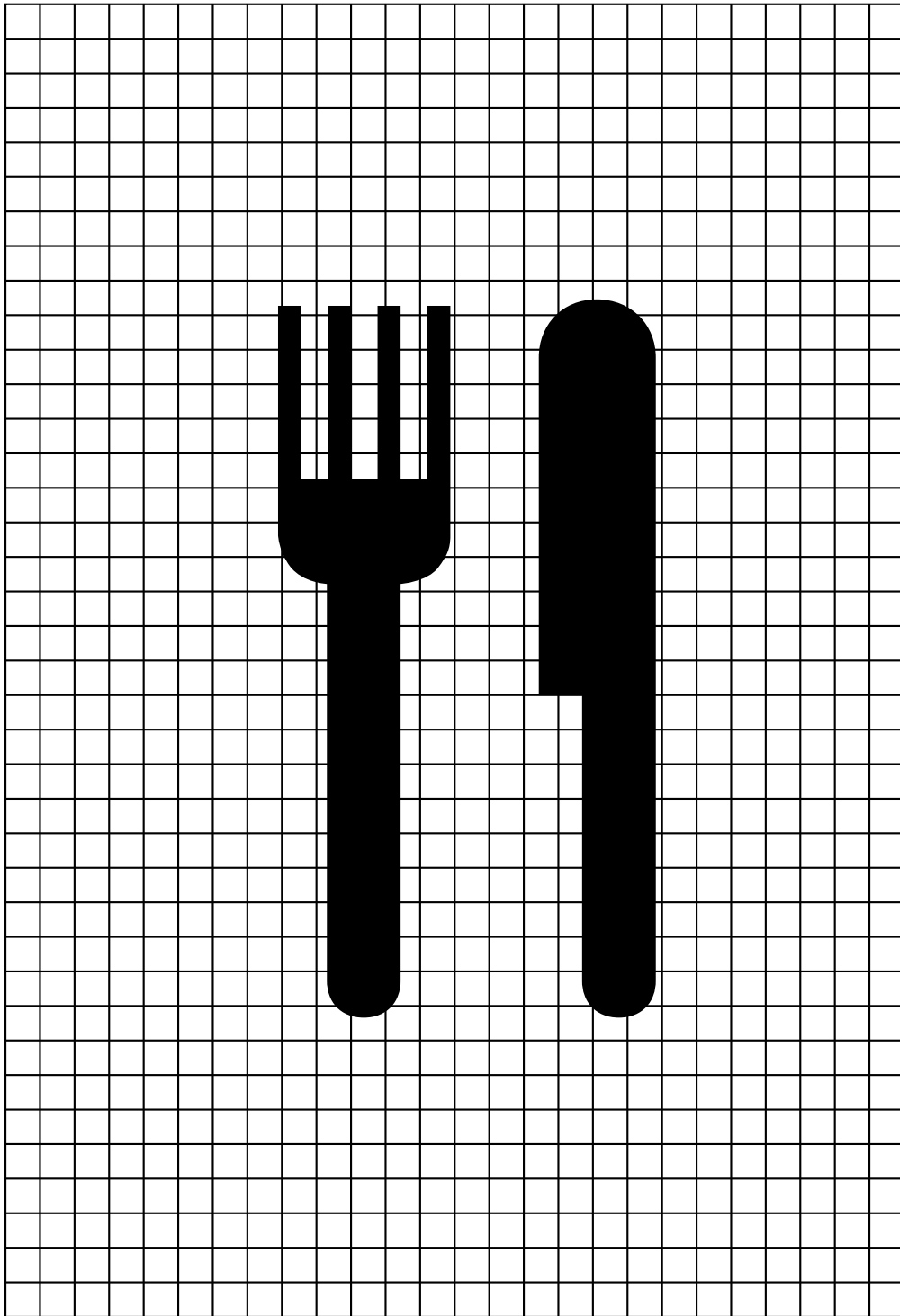

APPENDIX D-15

10/97

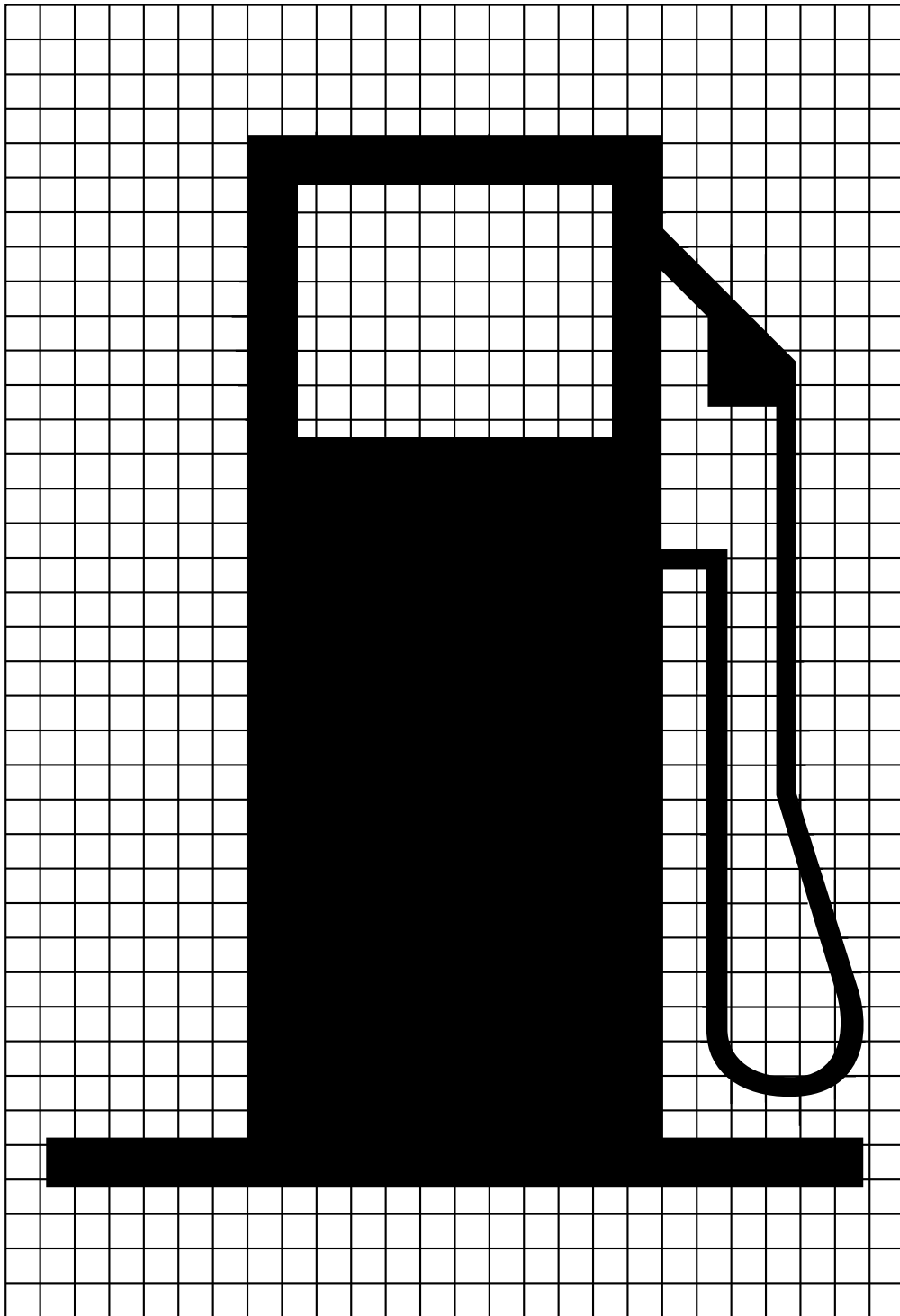

APPENDIX D-16

10/97

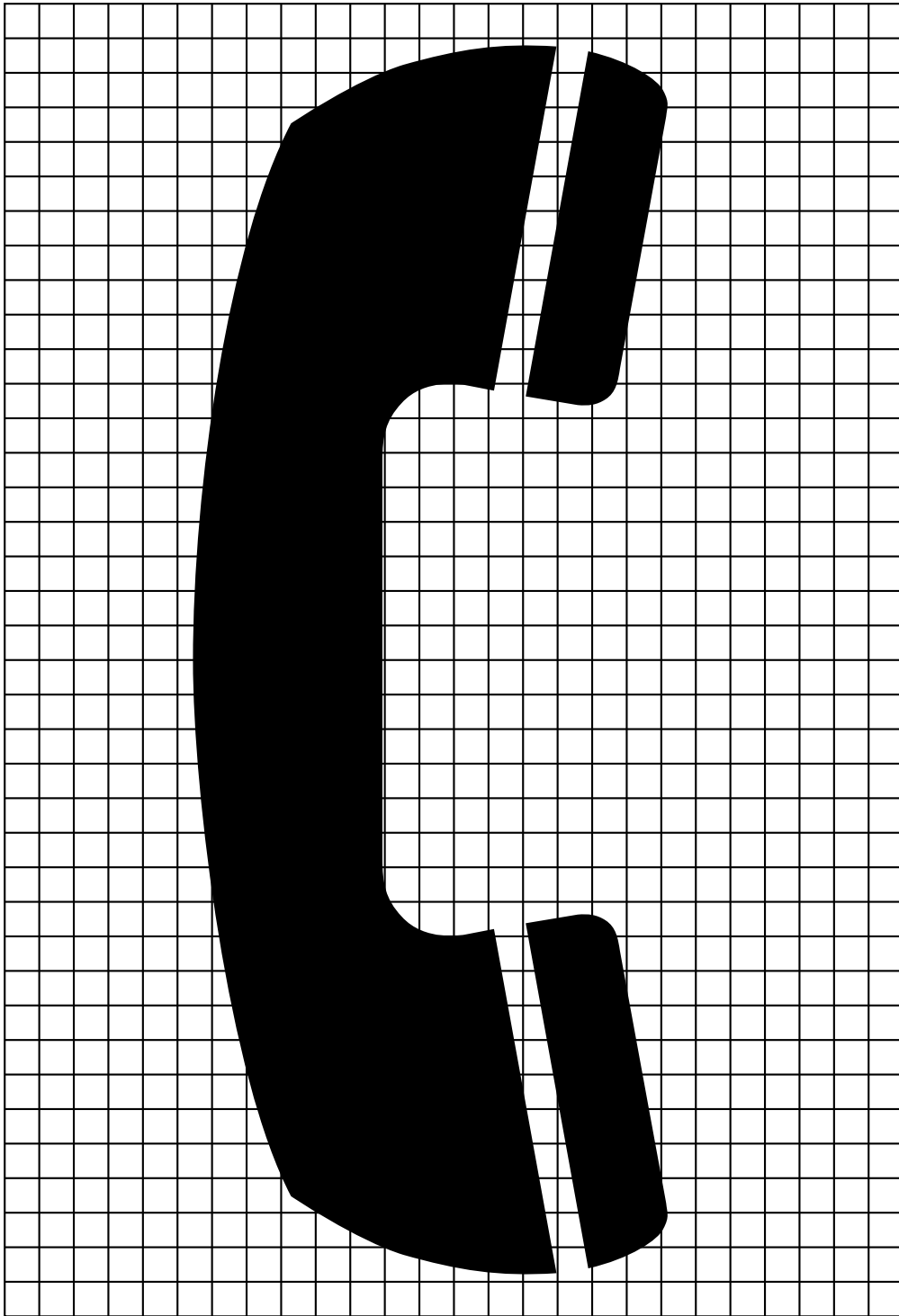

APPENDIX D-17

11/03

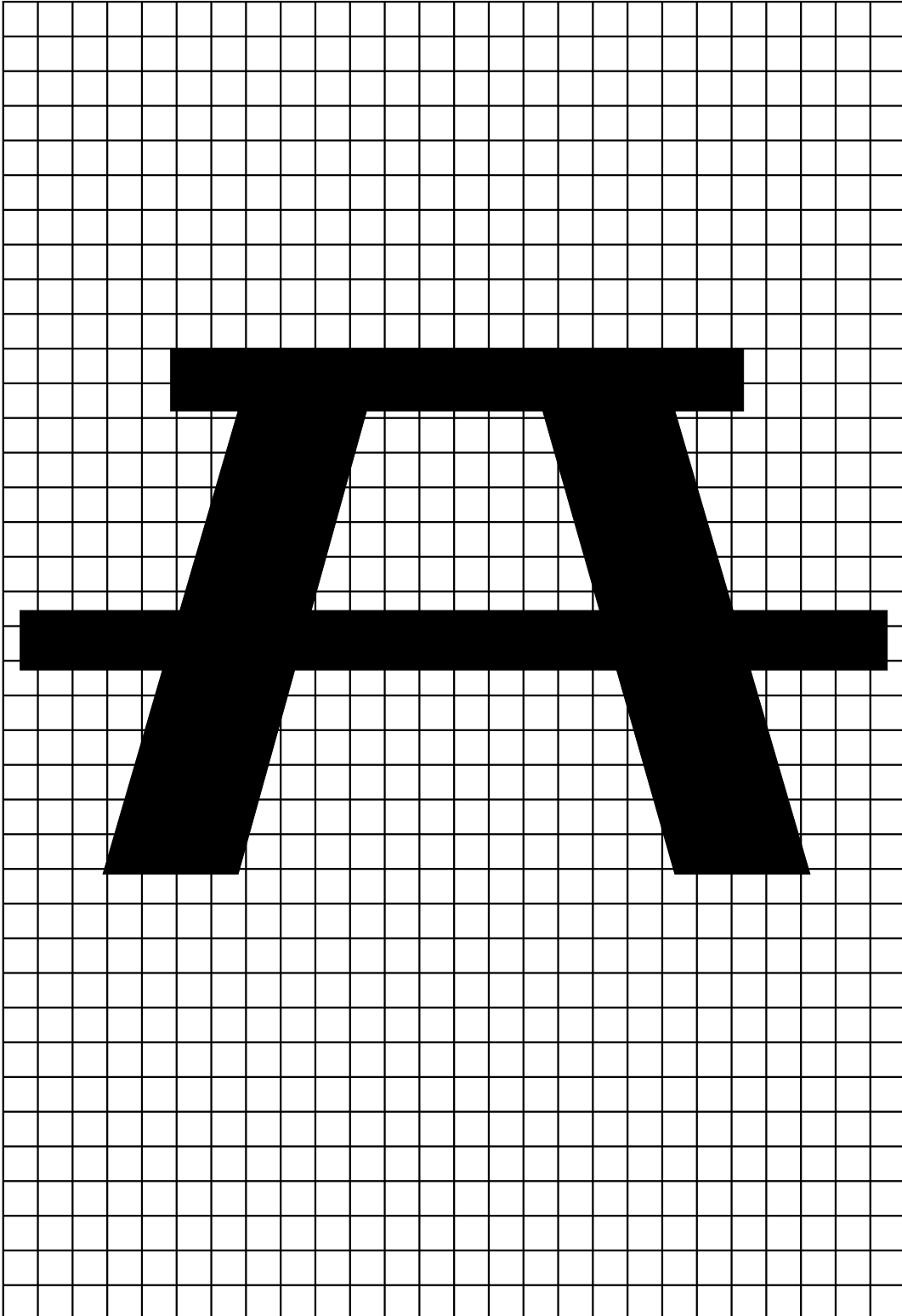

APPENDIX D-18

10/97

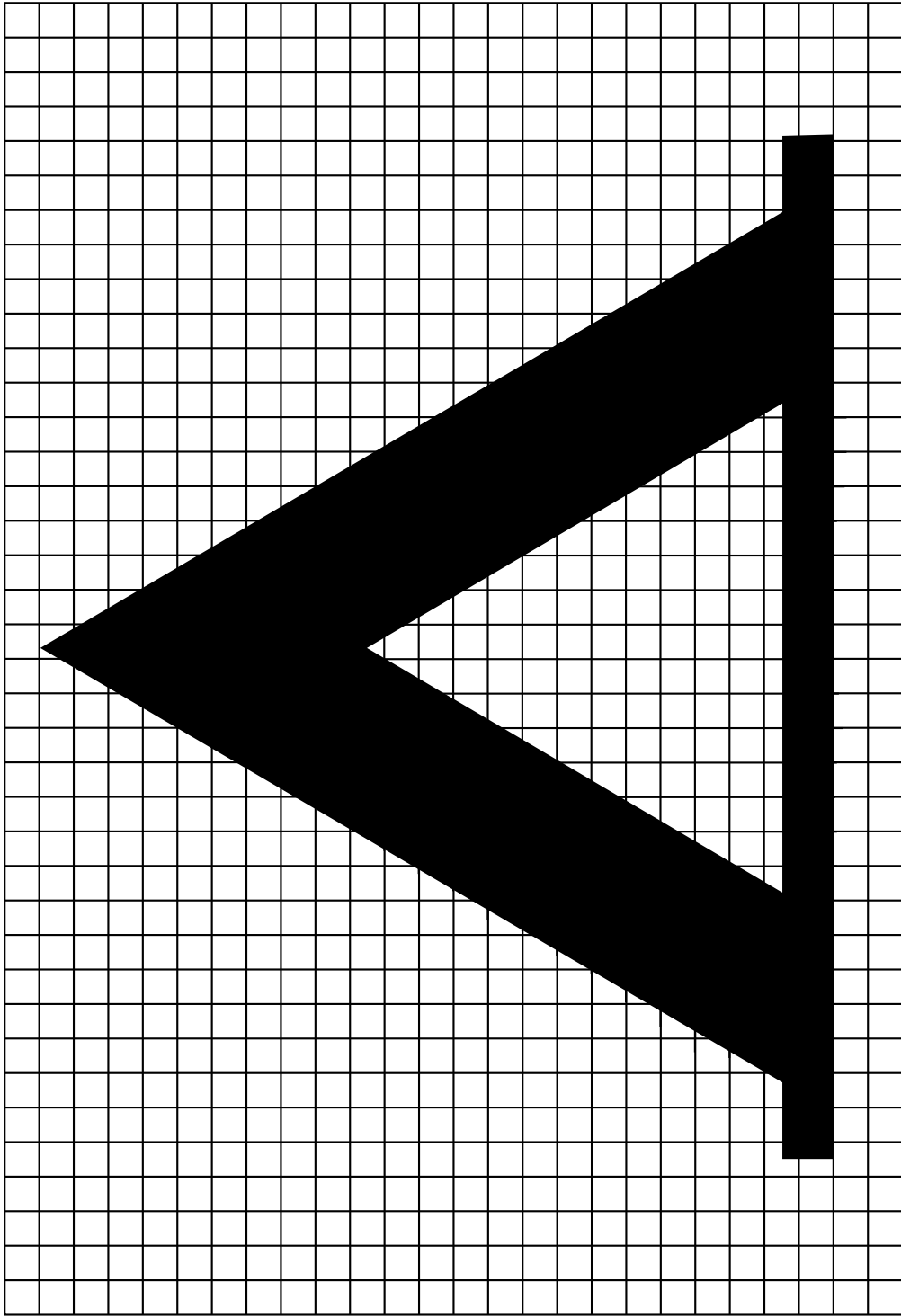

APPENDIX D-19

10/97

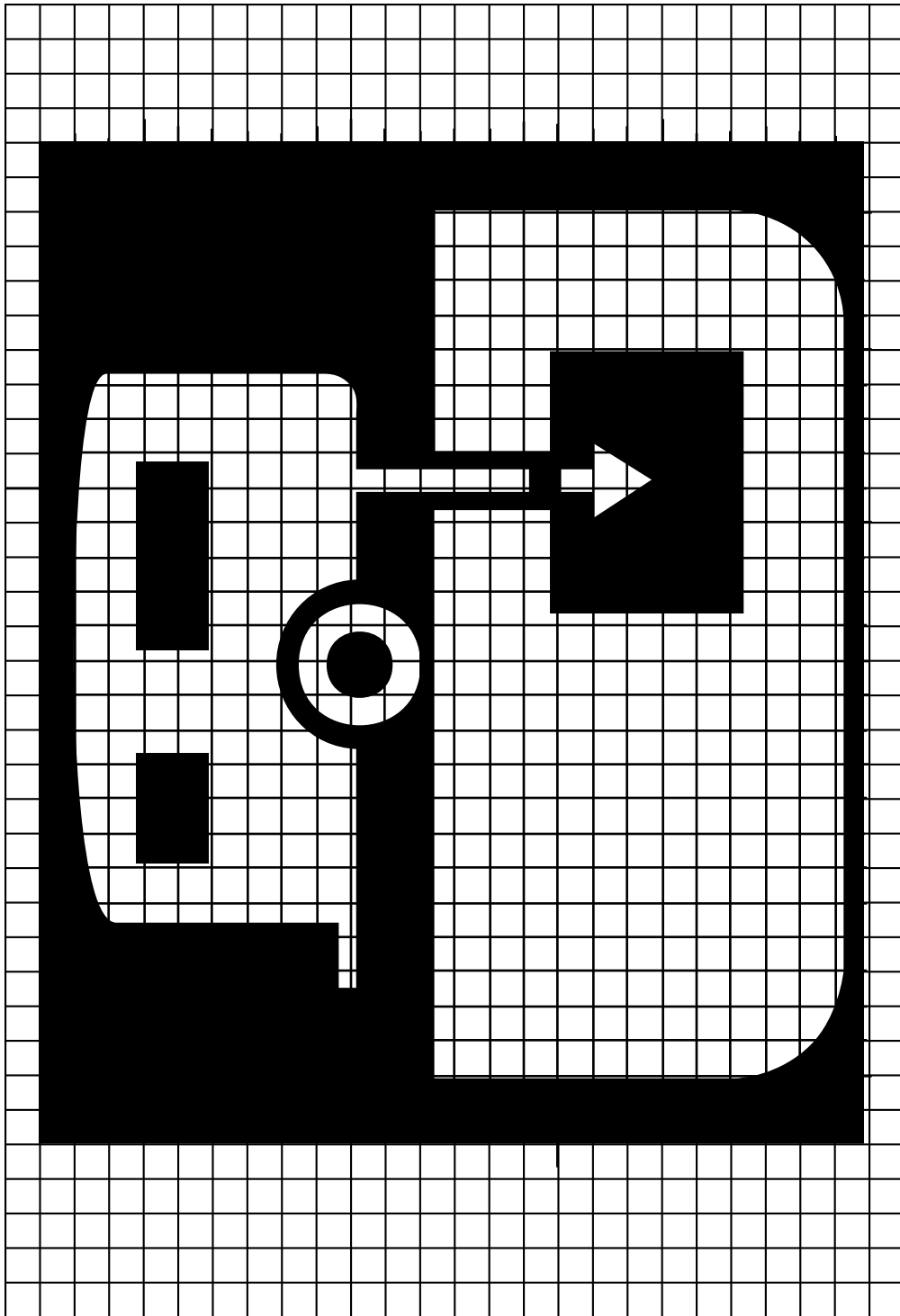

APPENDIX D-20

10/97

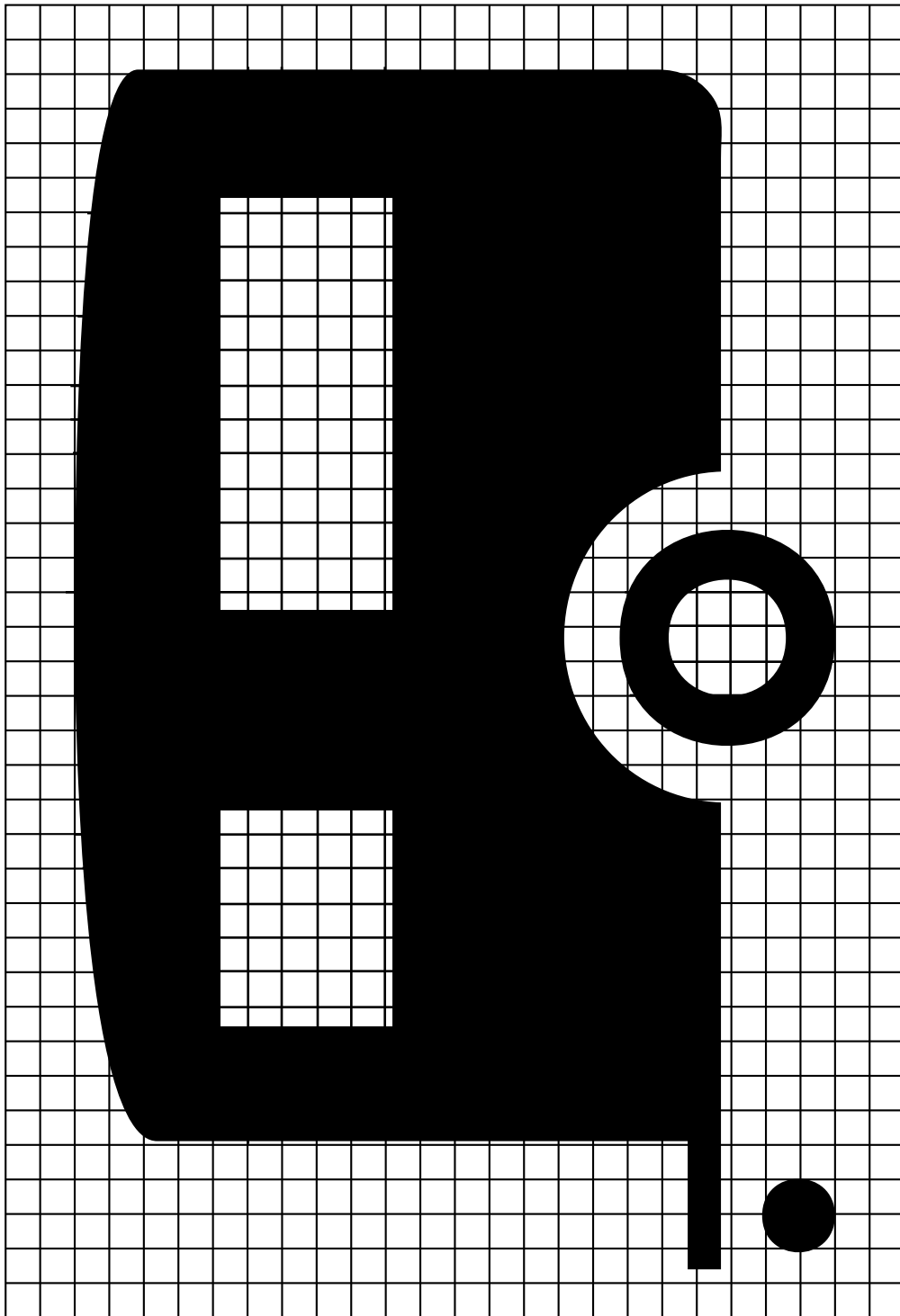

APPENDIX D-21

10/97

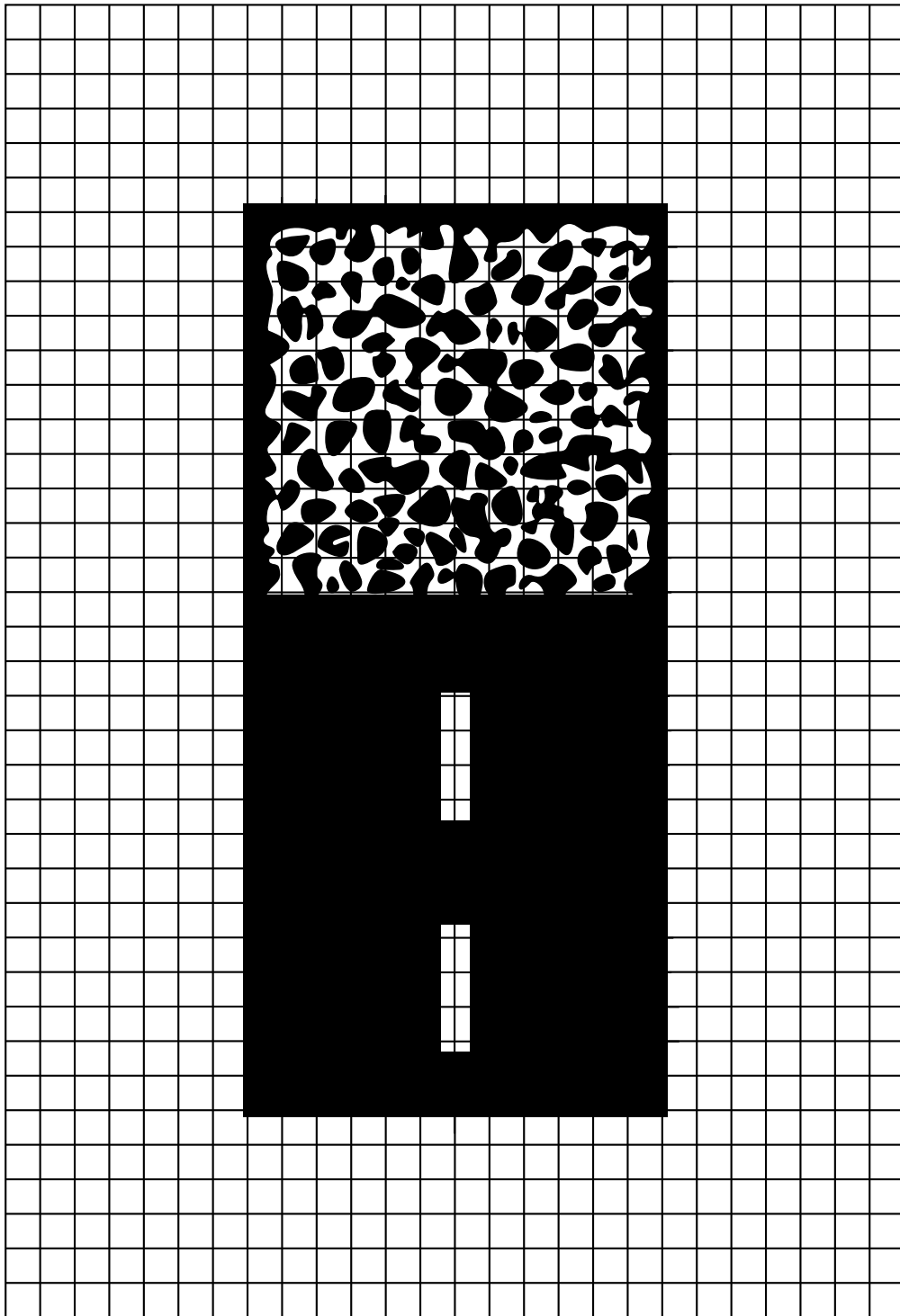

APPENDIX D-22

10/97

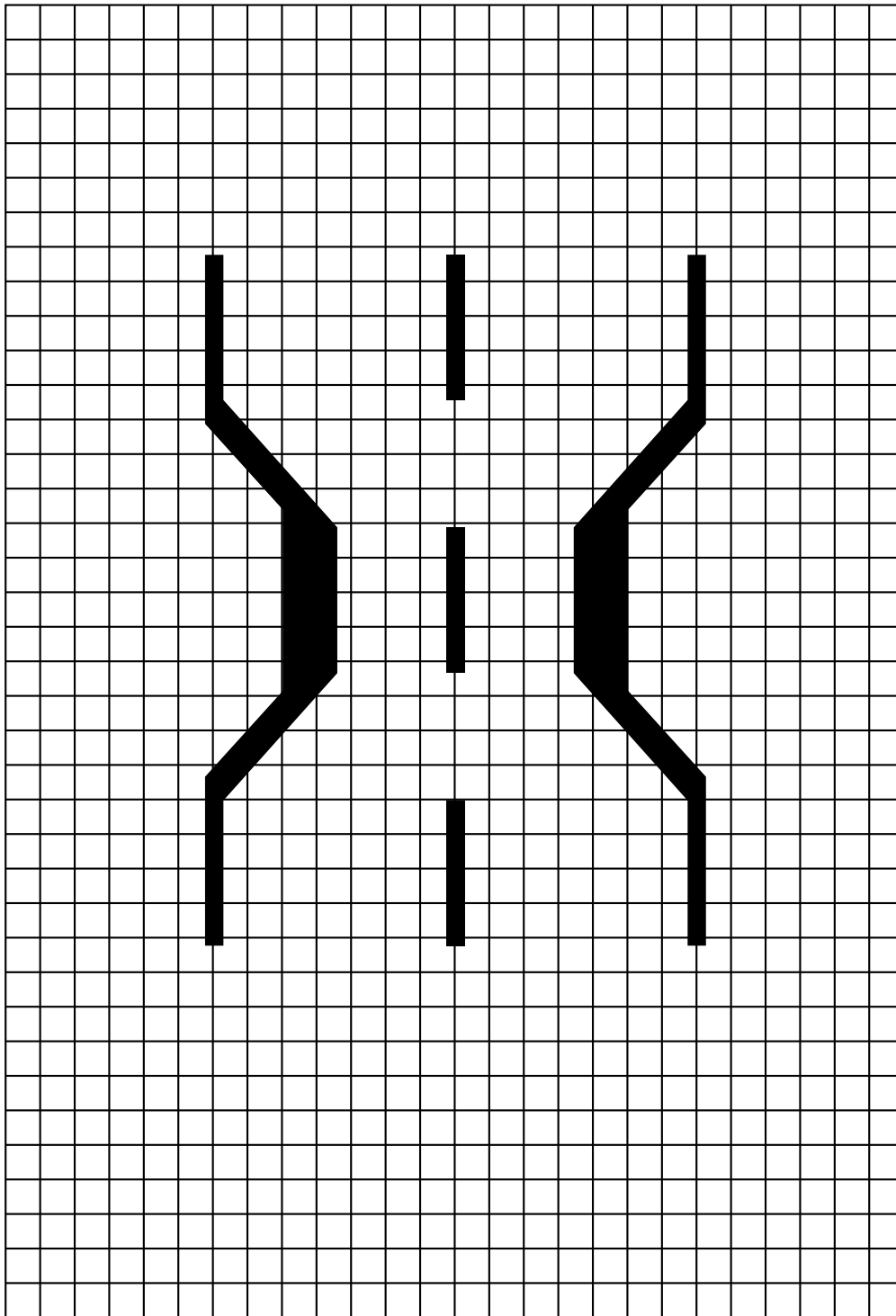

APPENDIX D-23

10/97

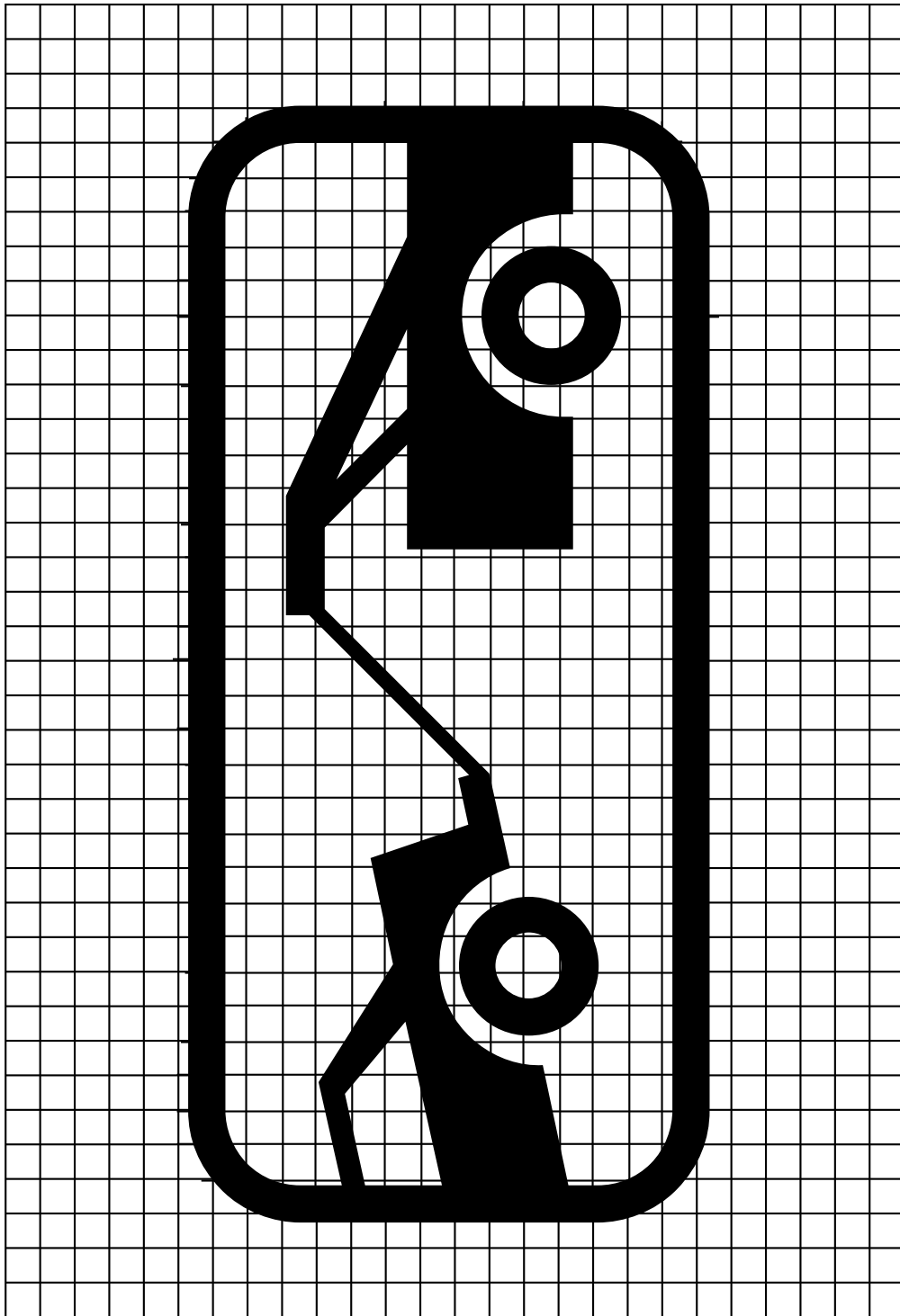

APPENDIX D-24

10/97

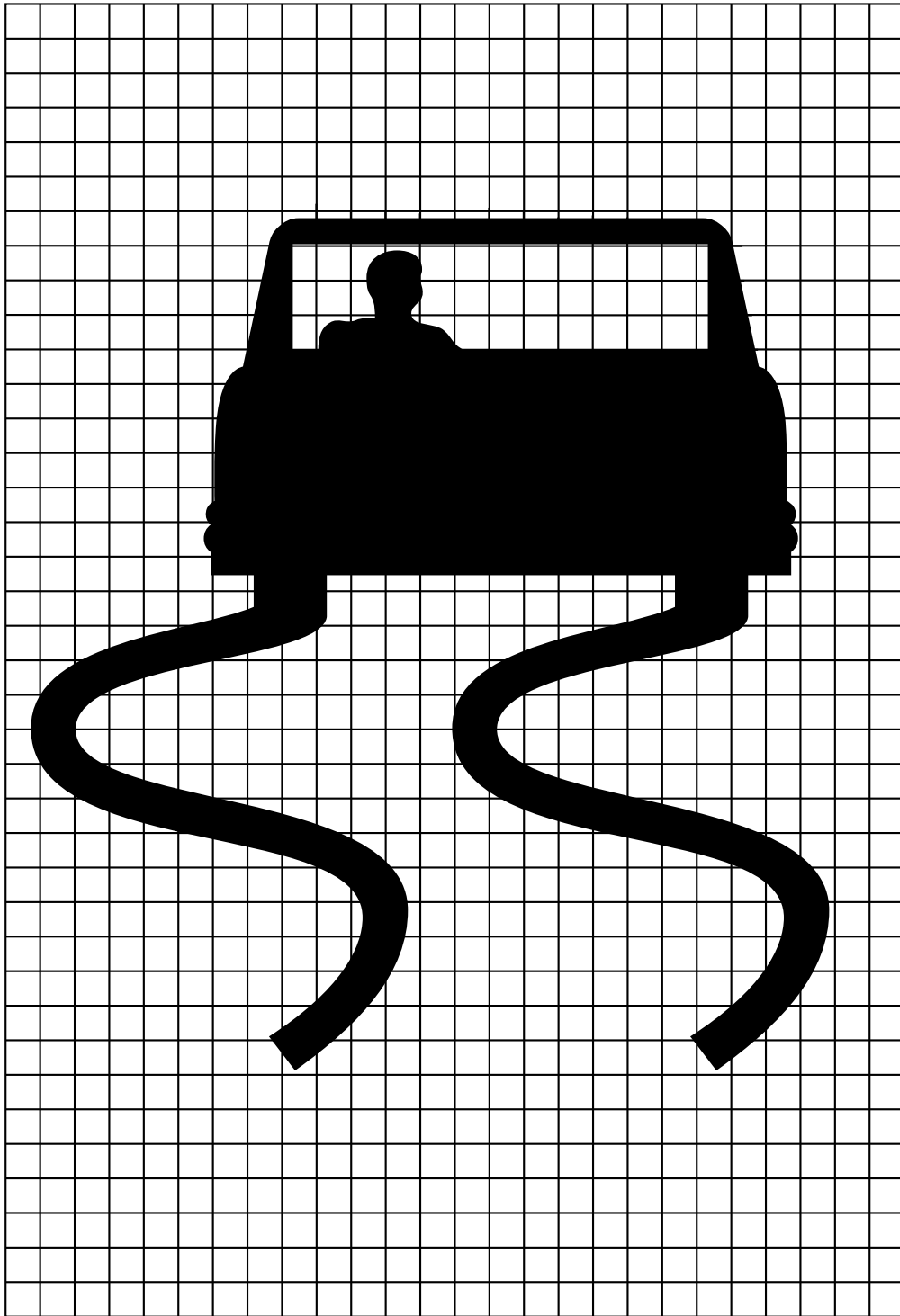

APPENDIX D-25

10/97

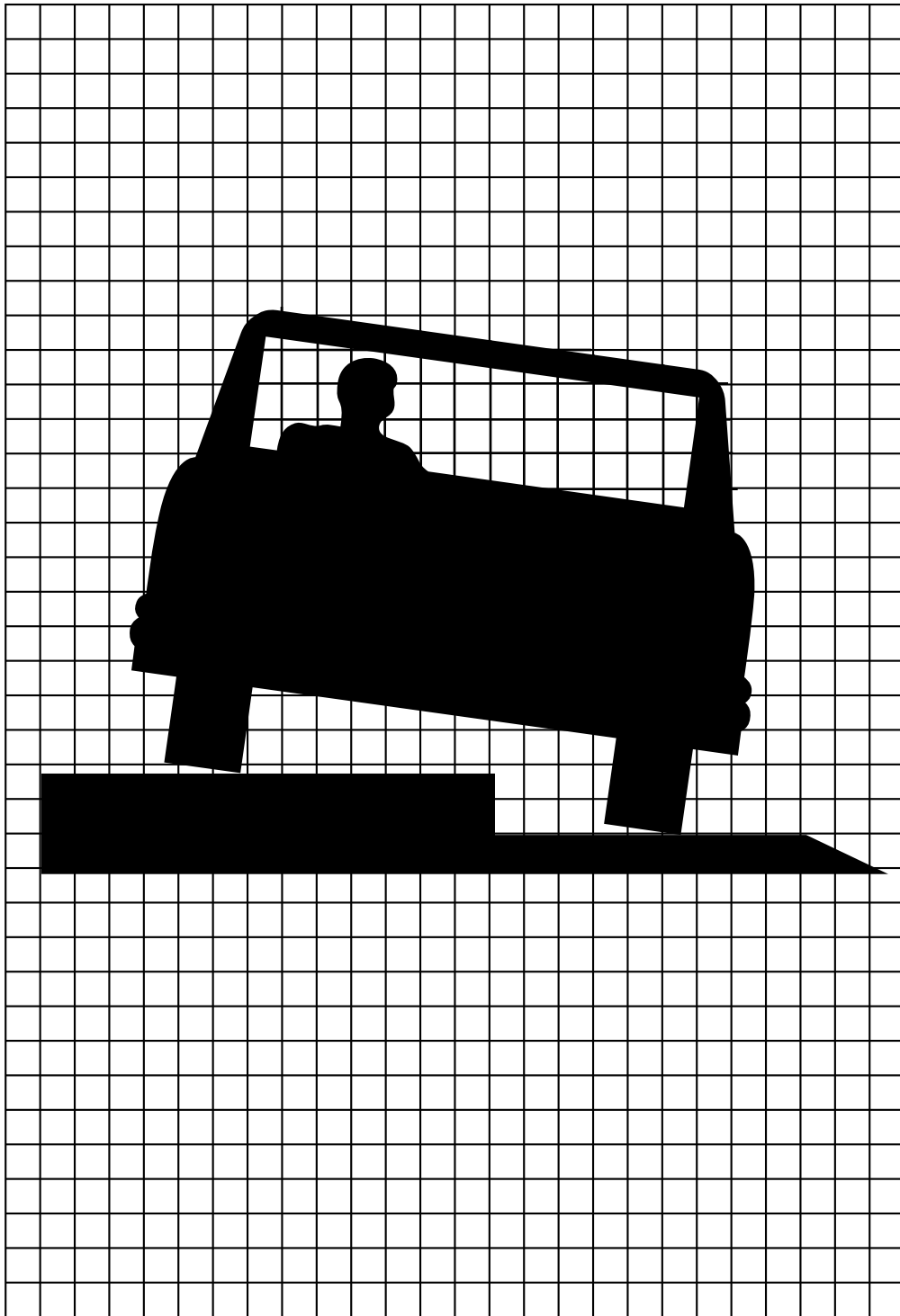

APPENDIX D-26

10/97

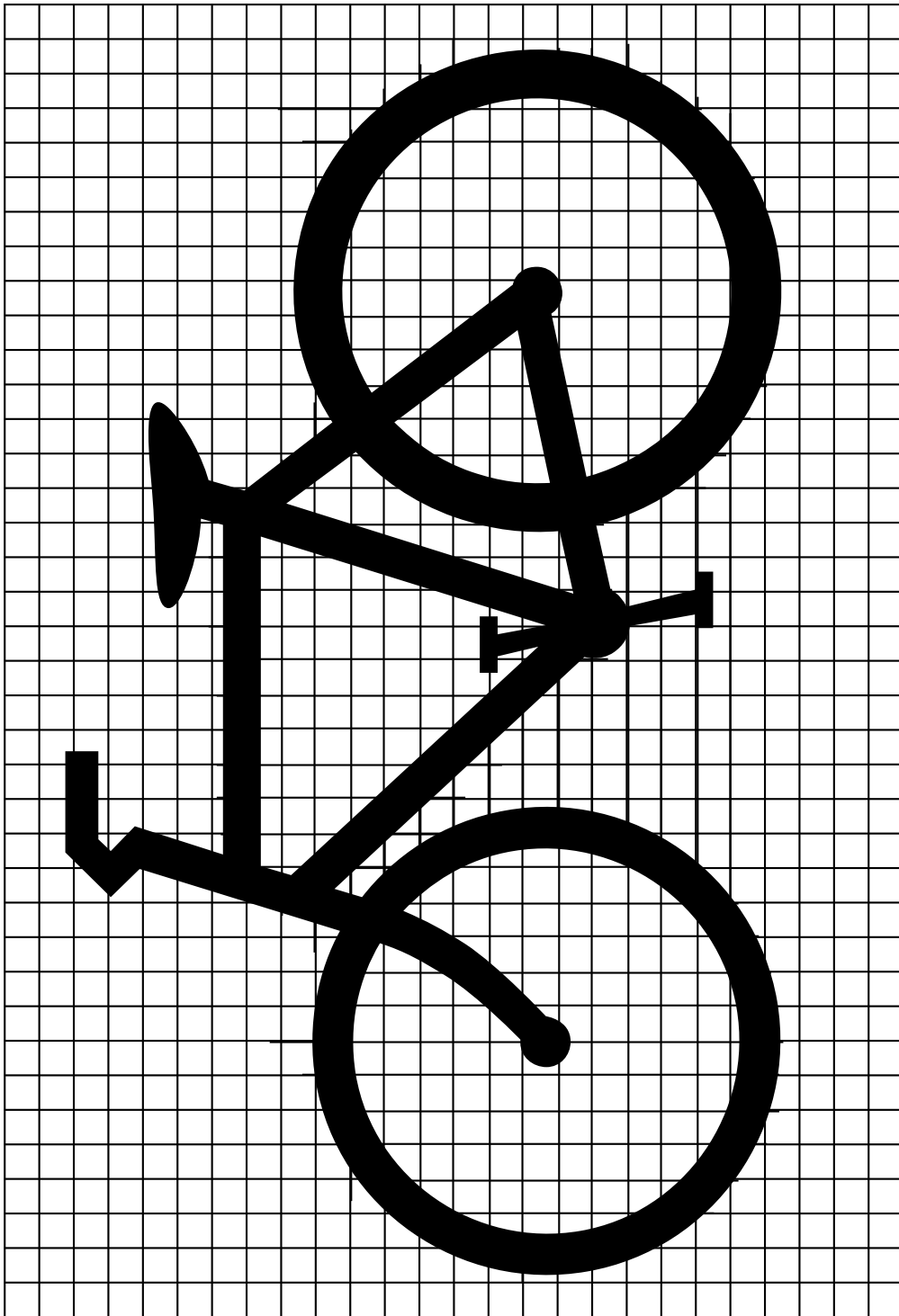

APPENDIX D-26A

3/06

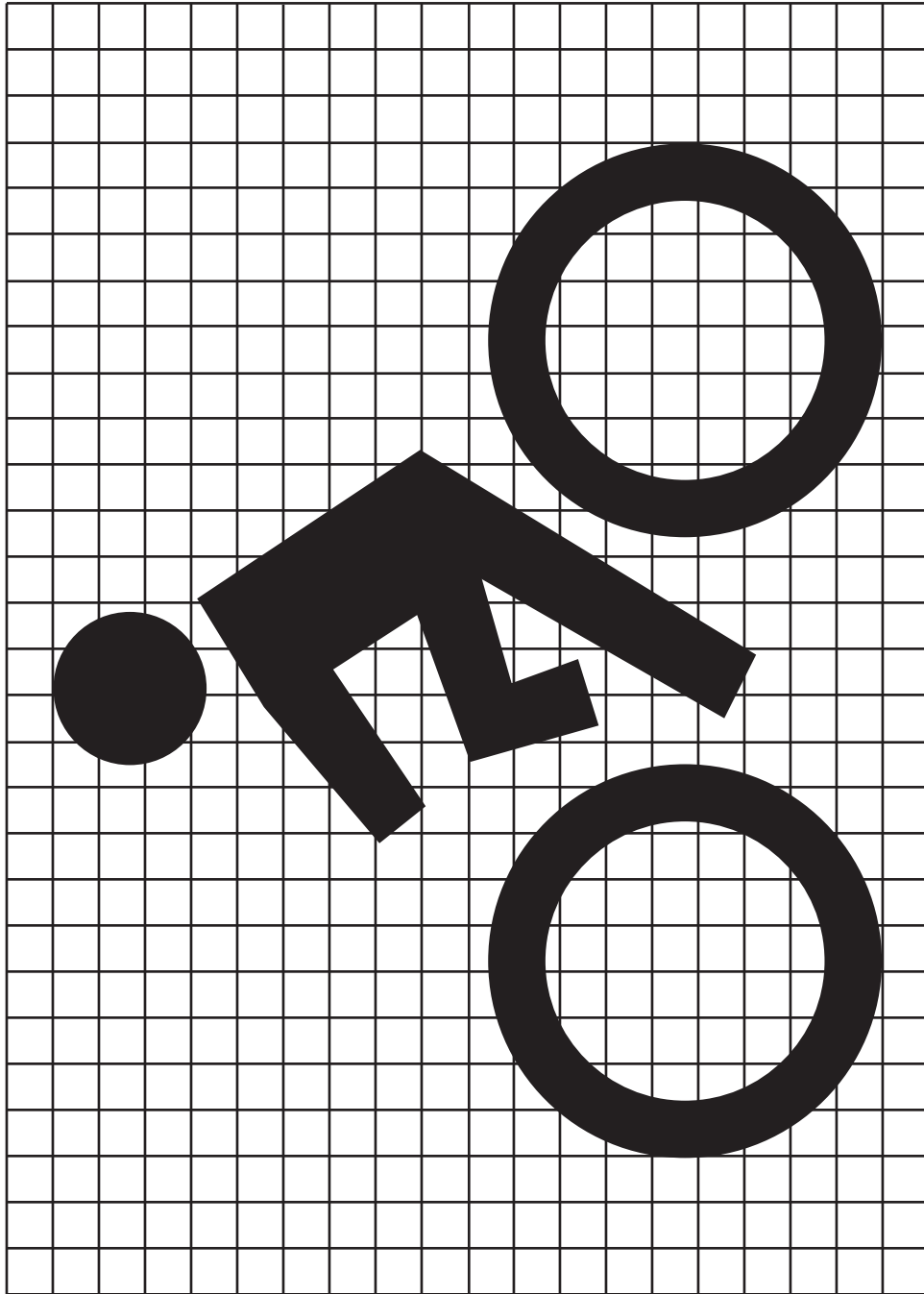

APPENDIX D-27

10/97

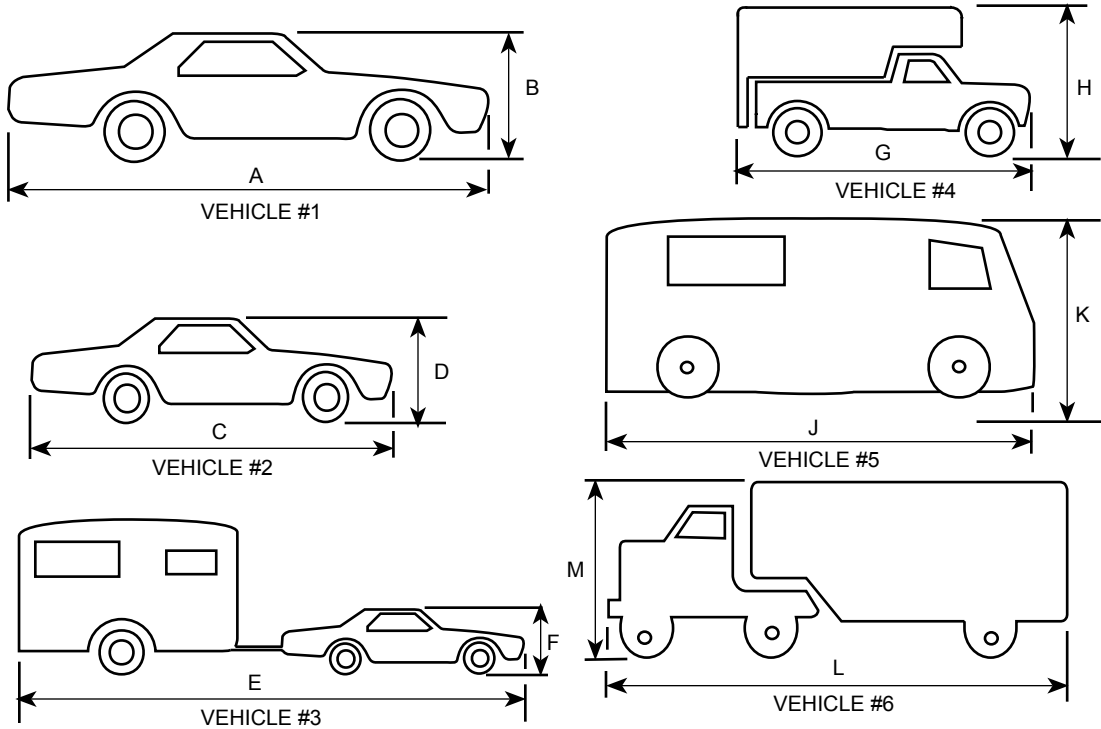

#1L ---- Vehicle #1 faces left
 #3R ---- Vehicle #3 faces right
 #6R ---- Vehicle #6 faces right

EXAMPLES OF SIGN PLAN LAYOUTS

#2L ---- Vehicle #2 faces left
 #4L ---- Vehicle #4 faces left
 #3R ---- Vehicle #3 faces right
 #5R ---- Vehicle #5 faces right

EXAMPLE

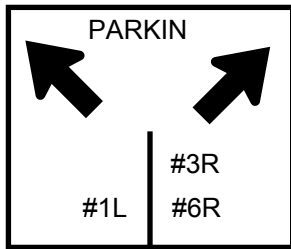

EXAMPLE B

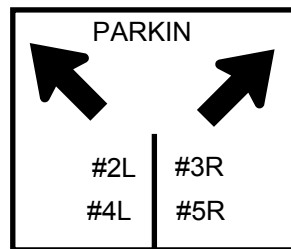

TO BE USED WITH REST AREA PARKING SYMBOL SIGN D4-401

SIGN SIZE	DIMENSIONS (MILLIMETERS)											
	A	B	C	D	E	F	G	H	J	K	L	M
1500 X 1200	600	200	300	125	600	175	375	225	425	225	600	200
2400 X 1800	950	325	475	200	950	275	600	350	675	350	950	325

SIGN SIZE	DIMENSIONS (INCHES)											
	A	B	C	D	E	F	G	H	J	K	L	M
60 X 48	24	8	12	5	24	7	15	9	17	9	24	8
96 X 72	38	13	19	8	38	1	24	14	27	14	38	13

VEHICLE NO. 1 IS INTENDED FOR USE ALONE AS SHOWN ON ABOVE SIGN. VEHICLE NO. 2 IS TO BE USED WHEN AUTOMOBILES AND ANOTHER VEHICLE TYPE ARE SIGNED IN THE SAME DIRECTION.

APPENDIX D-28

10/97

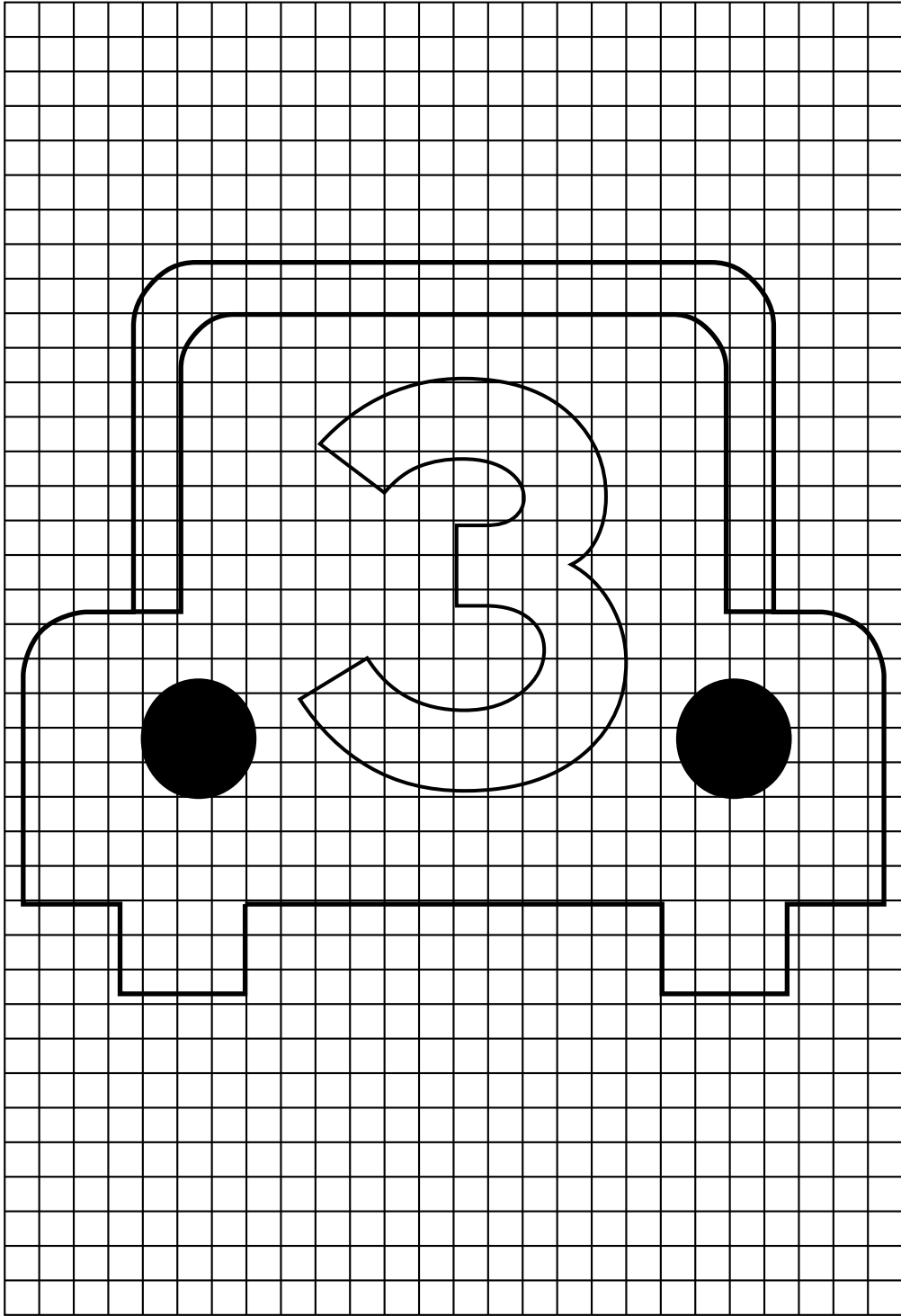

APPENDIX D-29

10/97

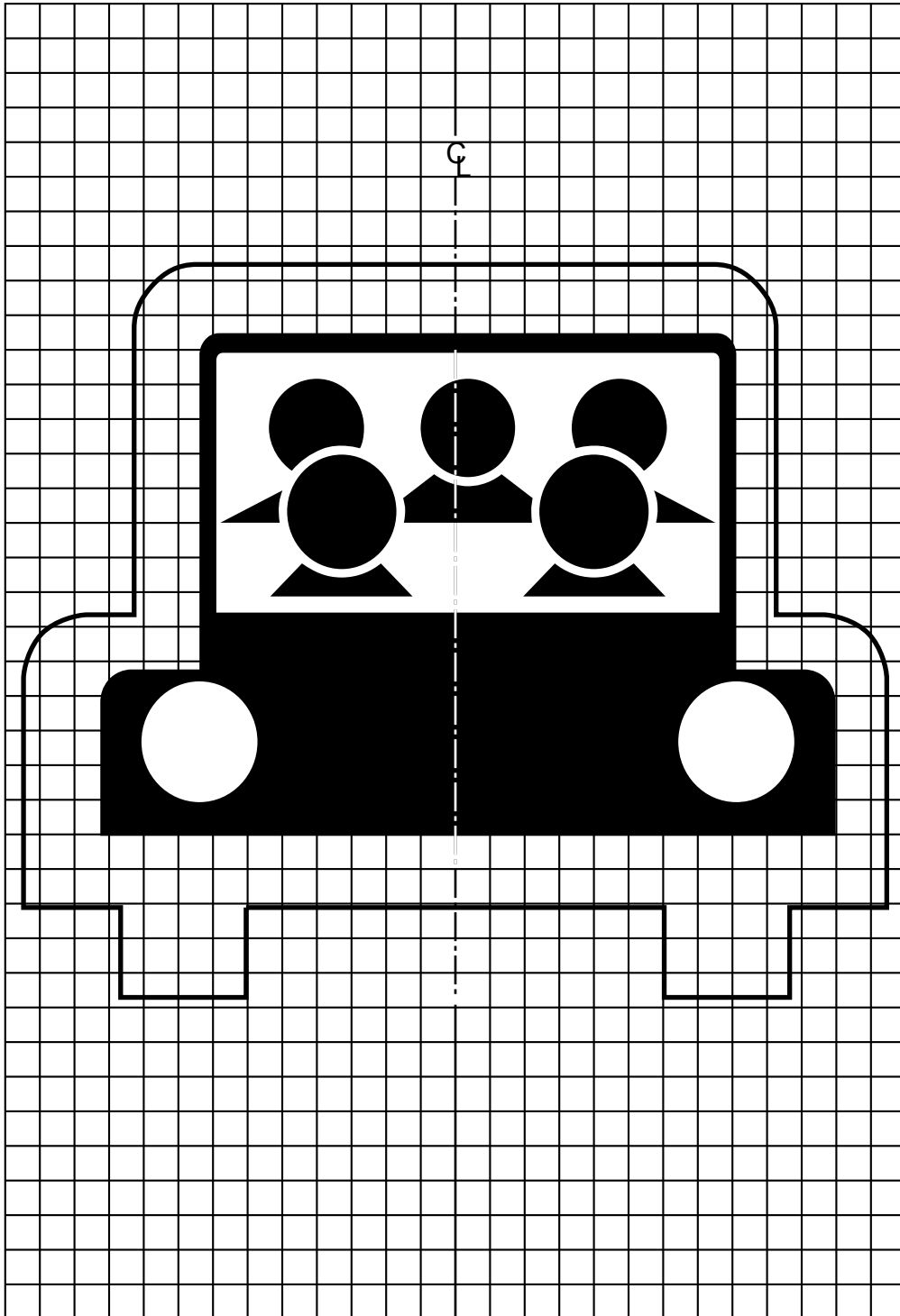

APPENDIX D-30

10/97

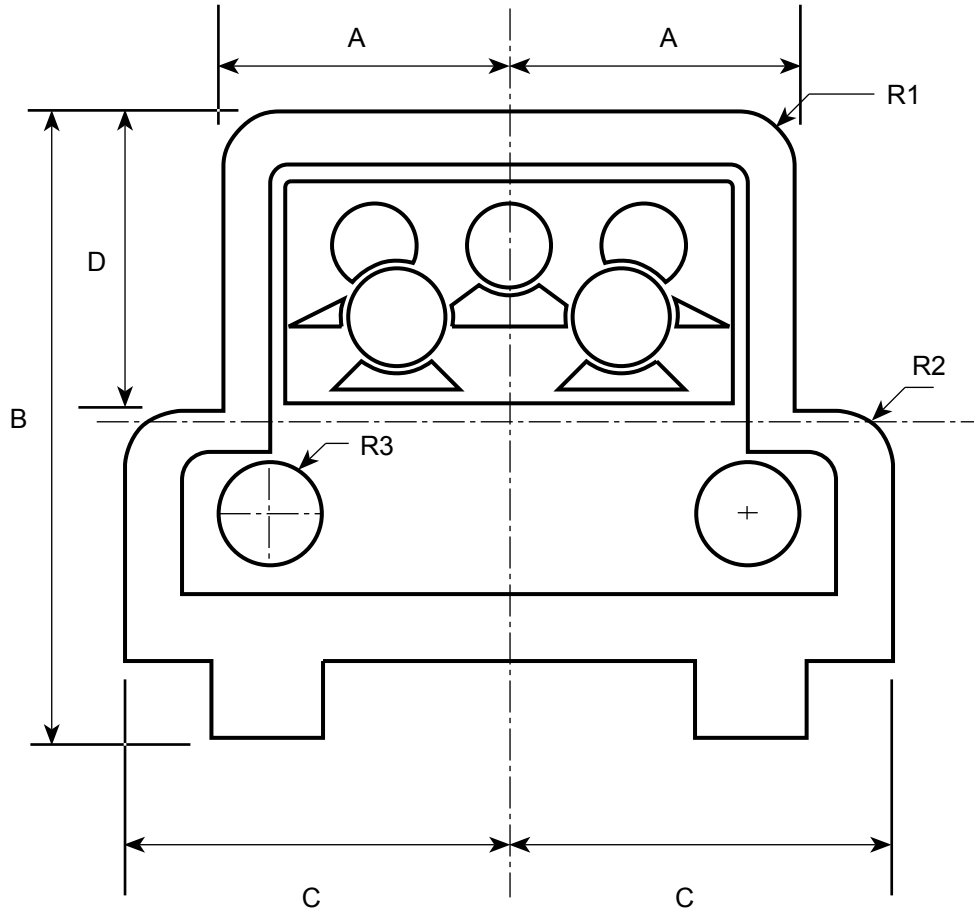

SIGN	DIMENSIONS (MILLIMETERS)						
	A	B	C	D	R1	R2	R3
STD.	144	300	191	139	38	30	25

SIGN	DIMENSIONS (MILLIMETERS)						
	A	B	C	D	R1	R2	R3
STD.	5 3/4	12	7 5/8	5 9/16	1 1/2	1 3/16	1

COLORS

BLACK ON WHITE
 WHITE (REFL.)
 BLACK (NON-REFL.)

APPENDIX D-31

10/97

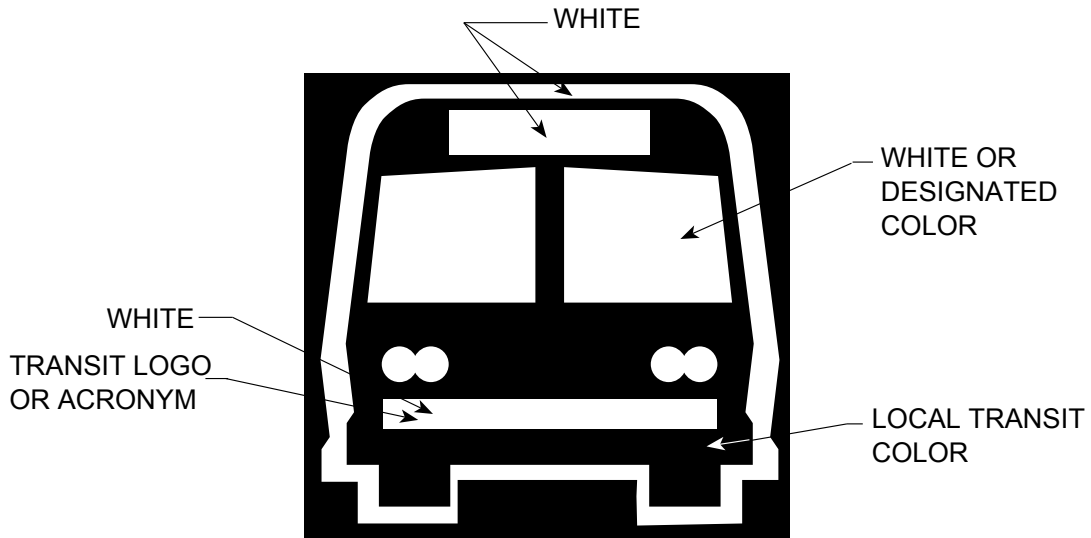

NOTE: FULL SIZE PRINTS ARE AVAILABLE FROM HEADQUARTERS TRAFFIC SECTION

SIG	LOGO SIZE	
	CARPOO	BU
D4-2	237.5	300
D4-3	112.5	150
E13-1	237.5	300
E13-2	350	450

SIG	LOGO SIZE	
	CARPOO	BU
D4-2	9 1/2	12
D4-3	4 1/2	6
E13-1	9 1/2	12
E13-2	14	18

COLORS— PER LOCAL AGENCY

APPENDIX D-32

10/97

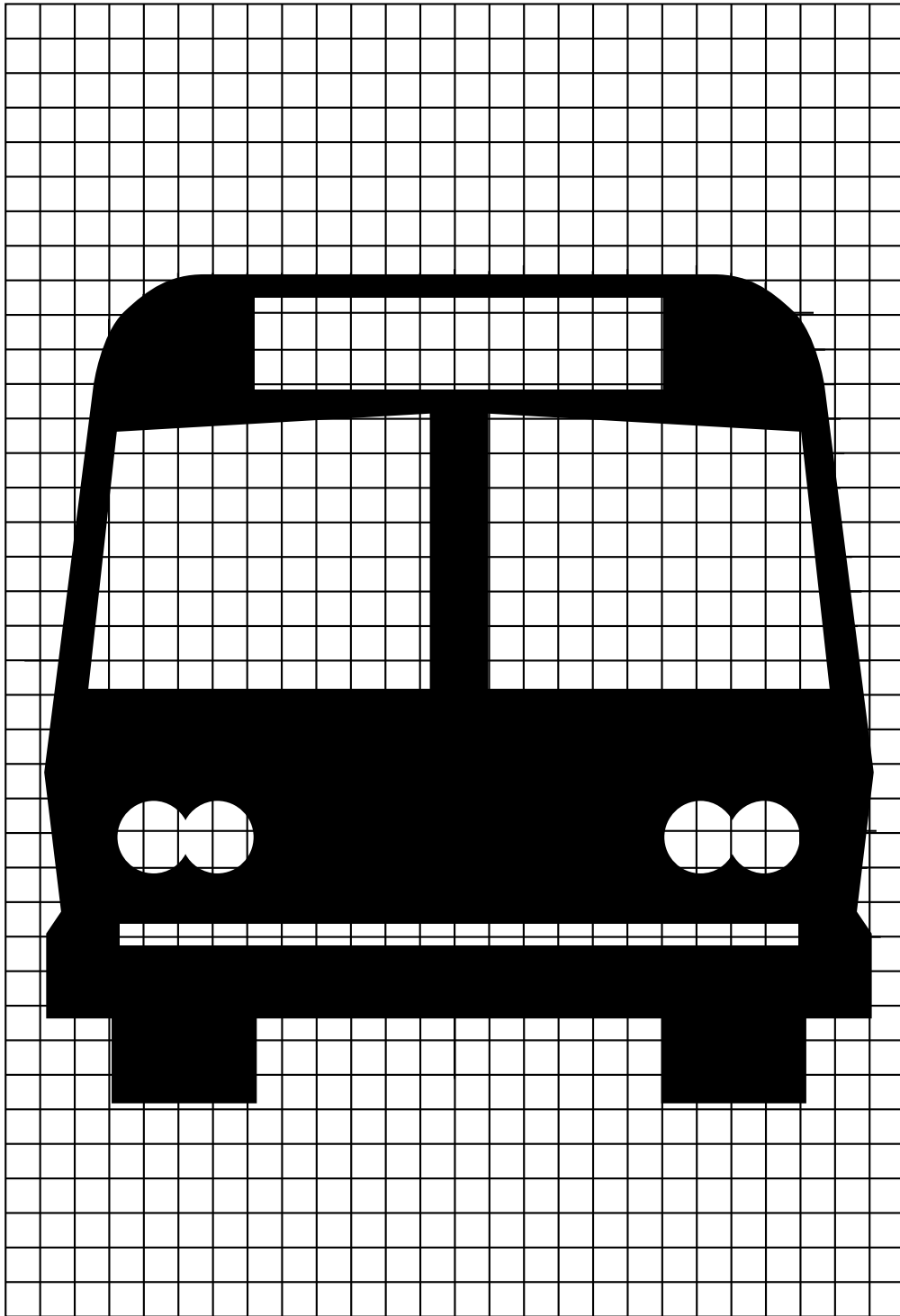

APPENDIX D-33

10/97

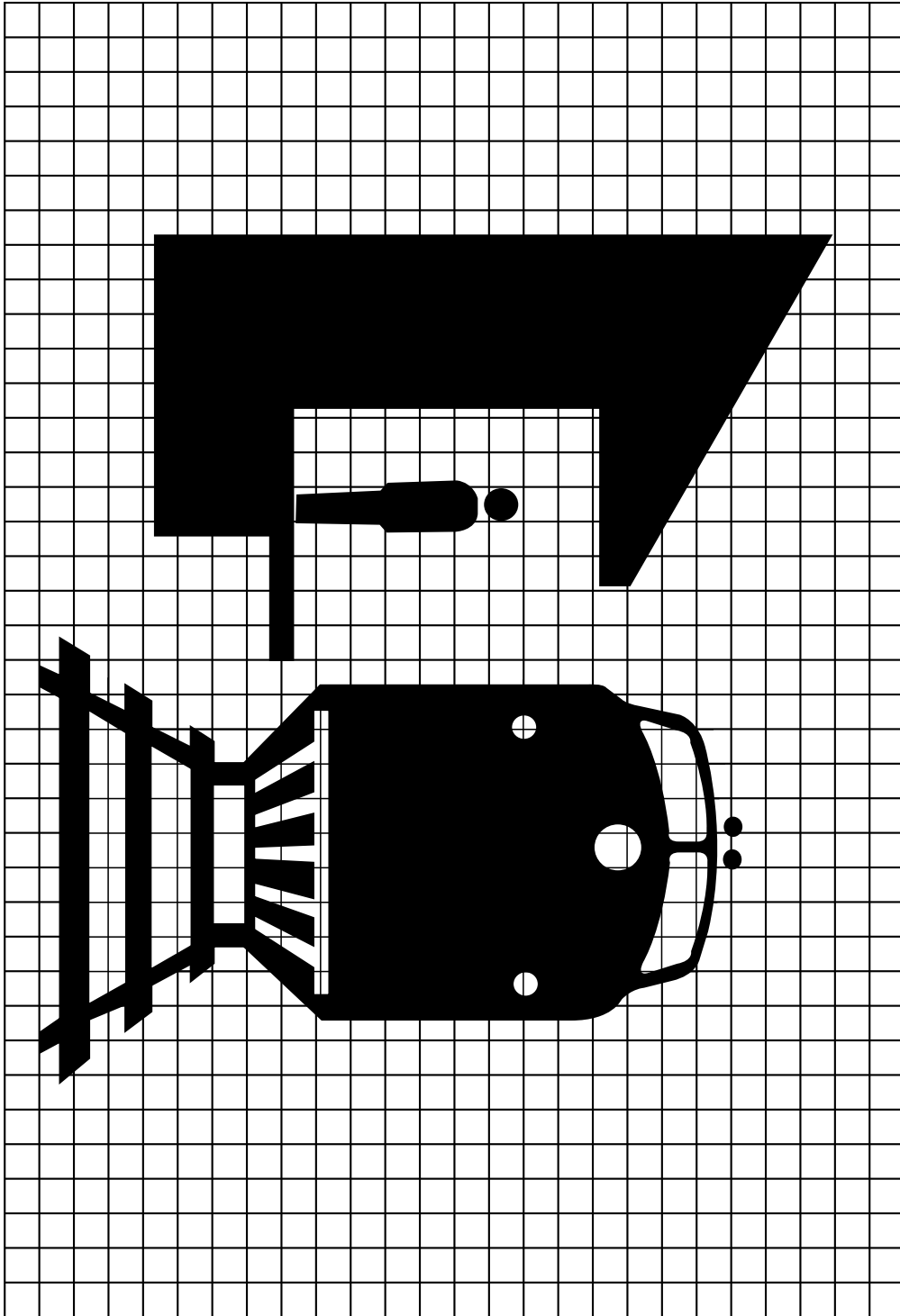

APPENDIX D-34

10/97

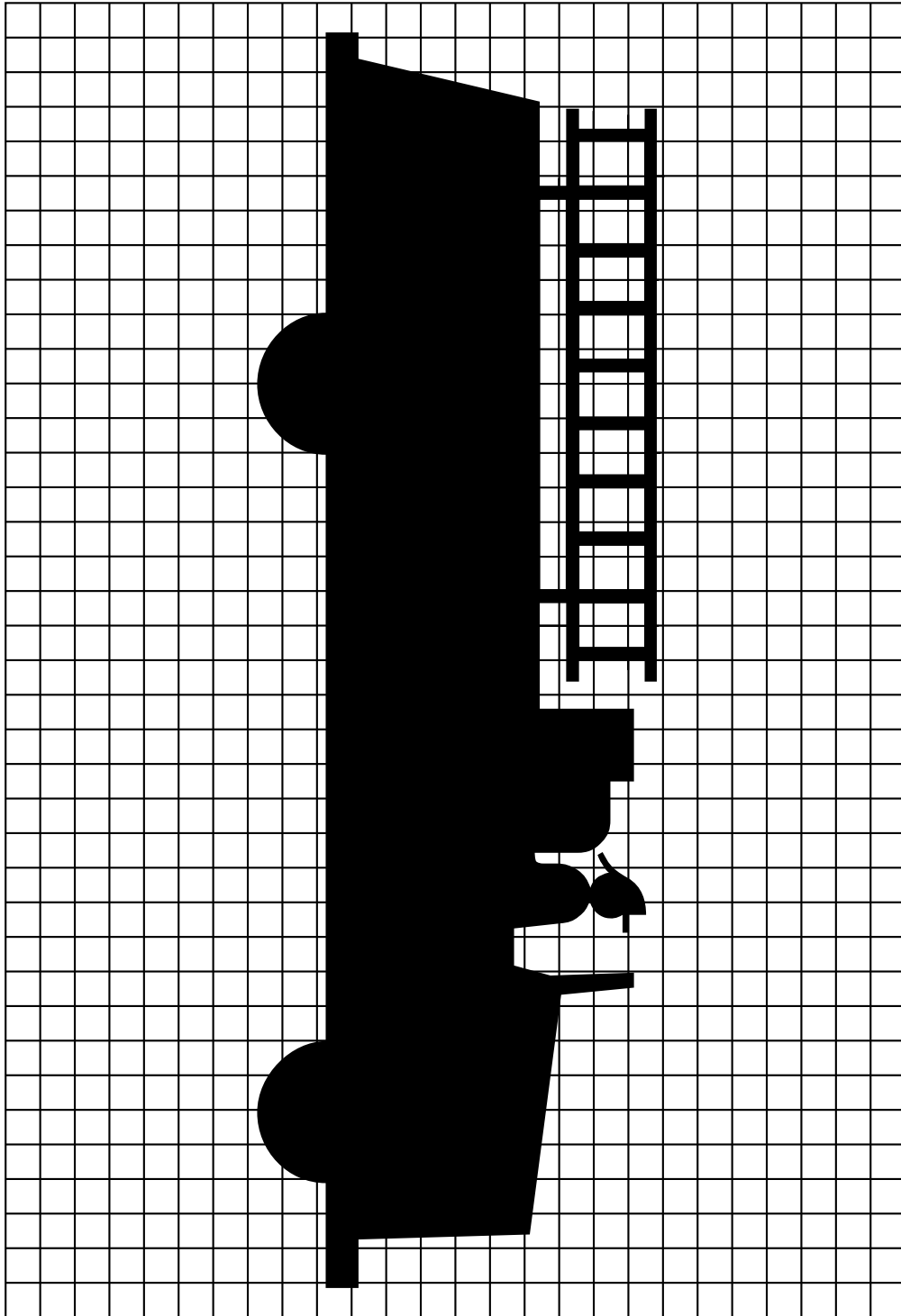

APPENDIX D-35

10/97

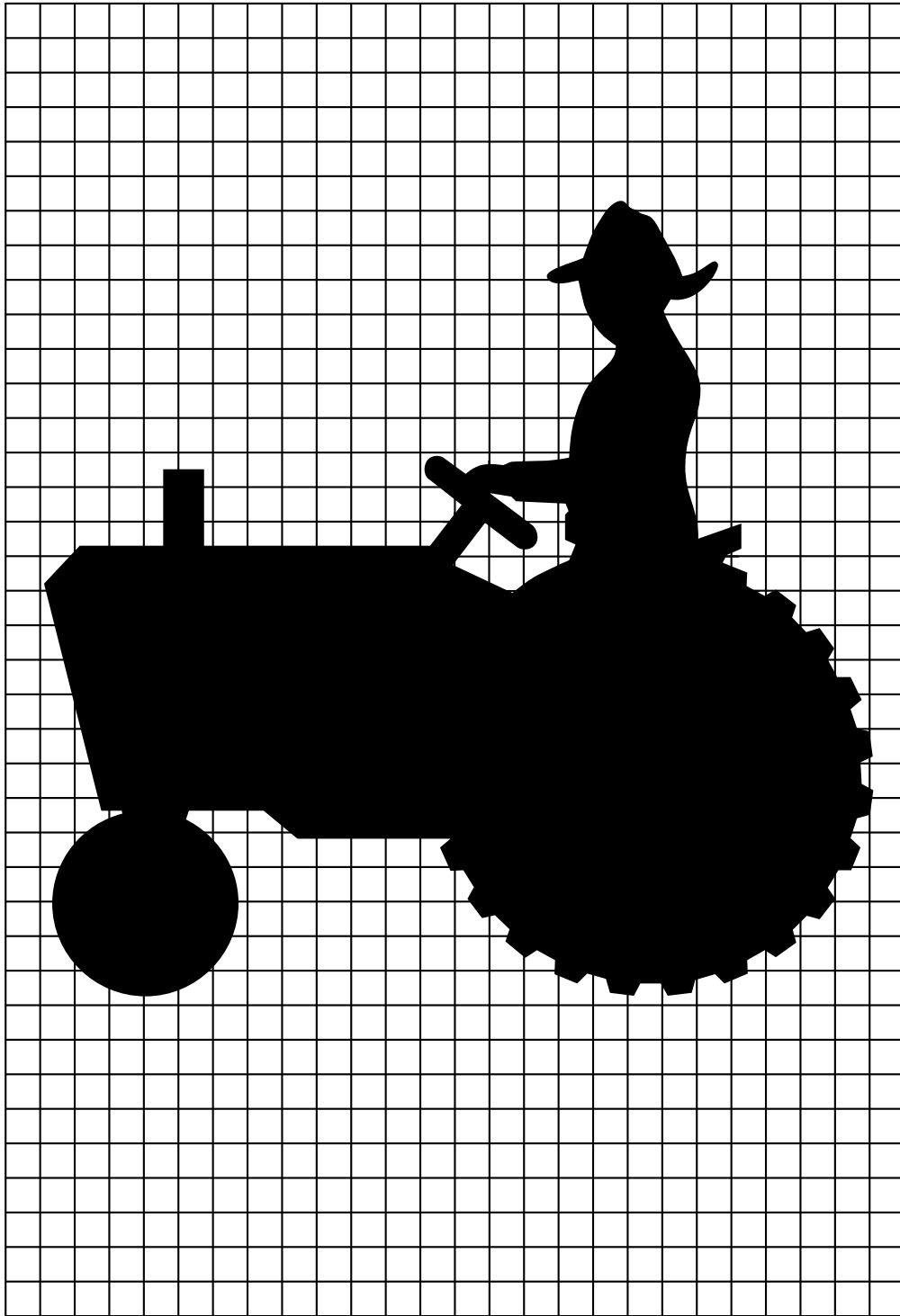

APPENDIX D-36

10/97

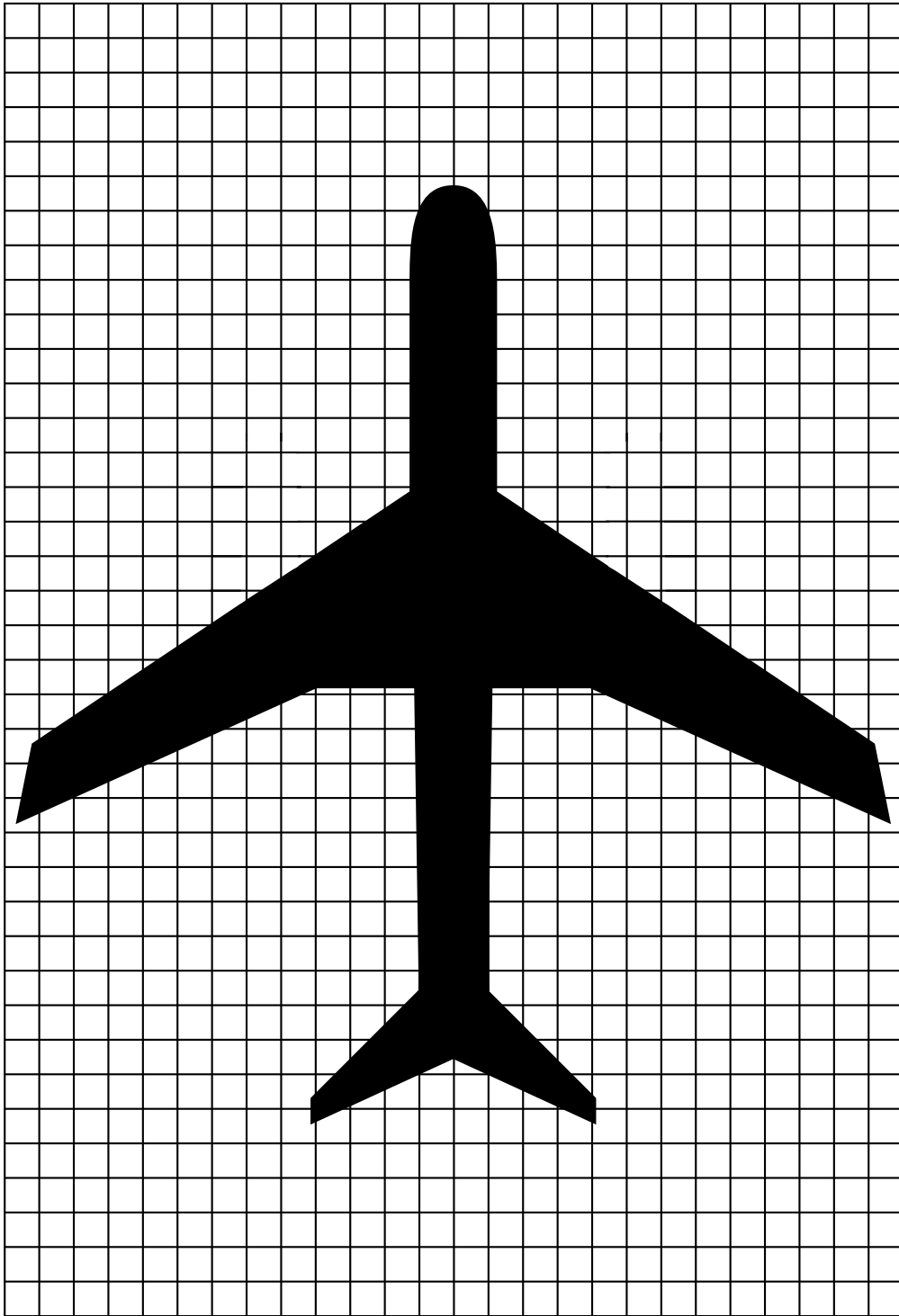

APPENDIX D-37

10/97

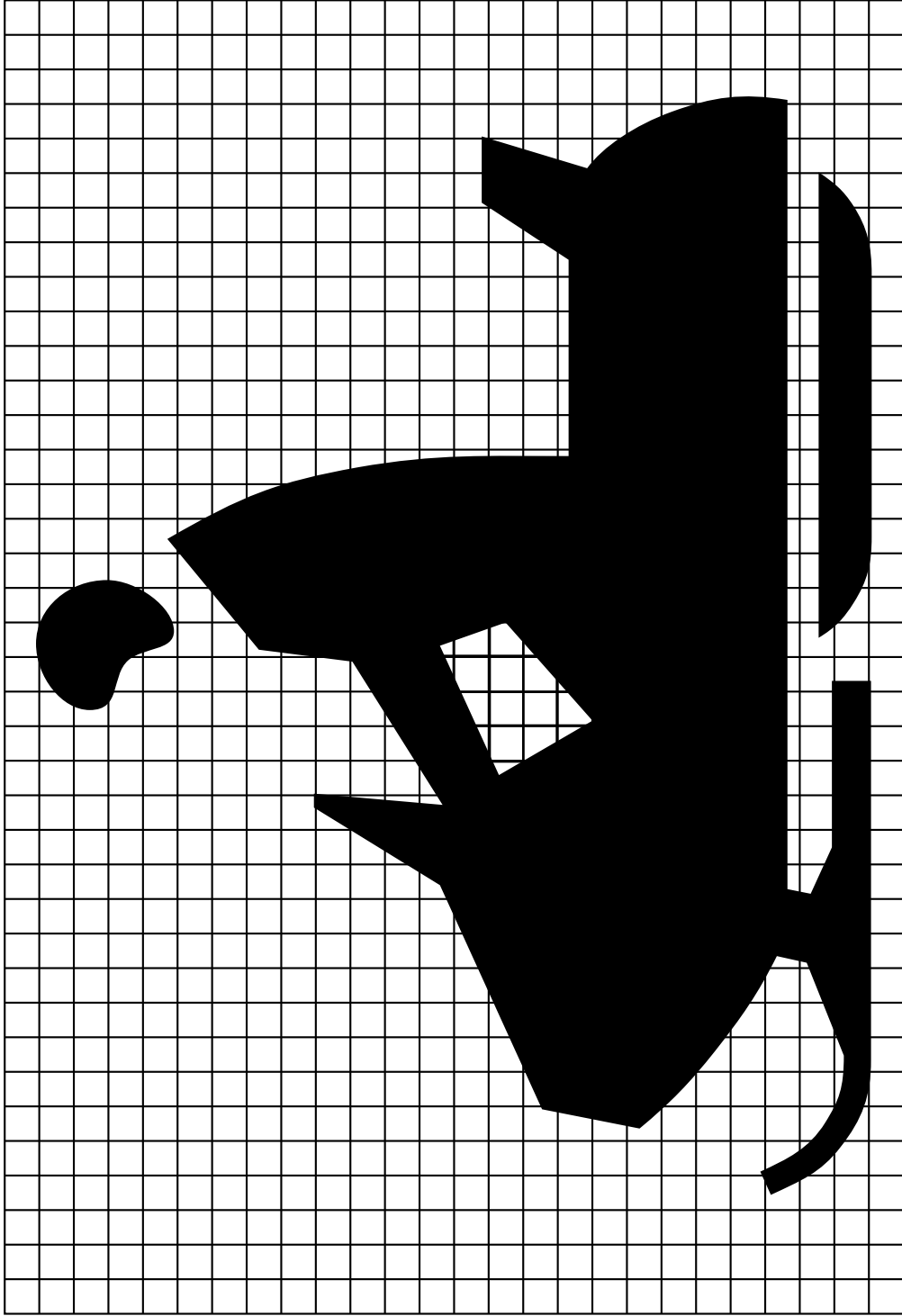

APPENDIX D-38

10/97

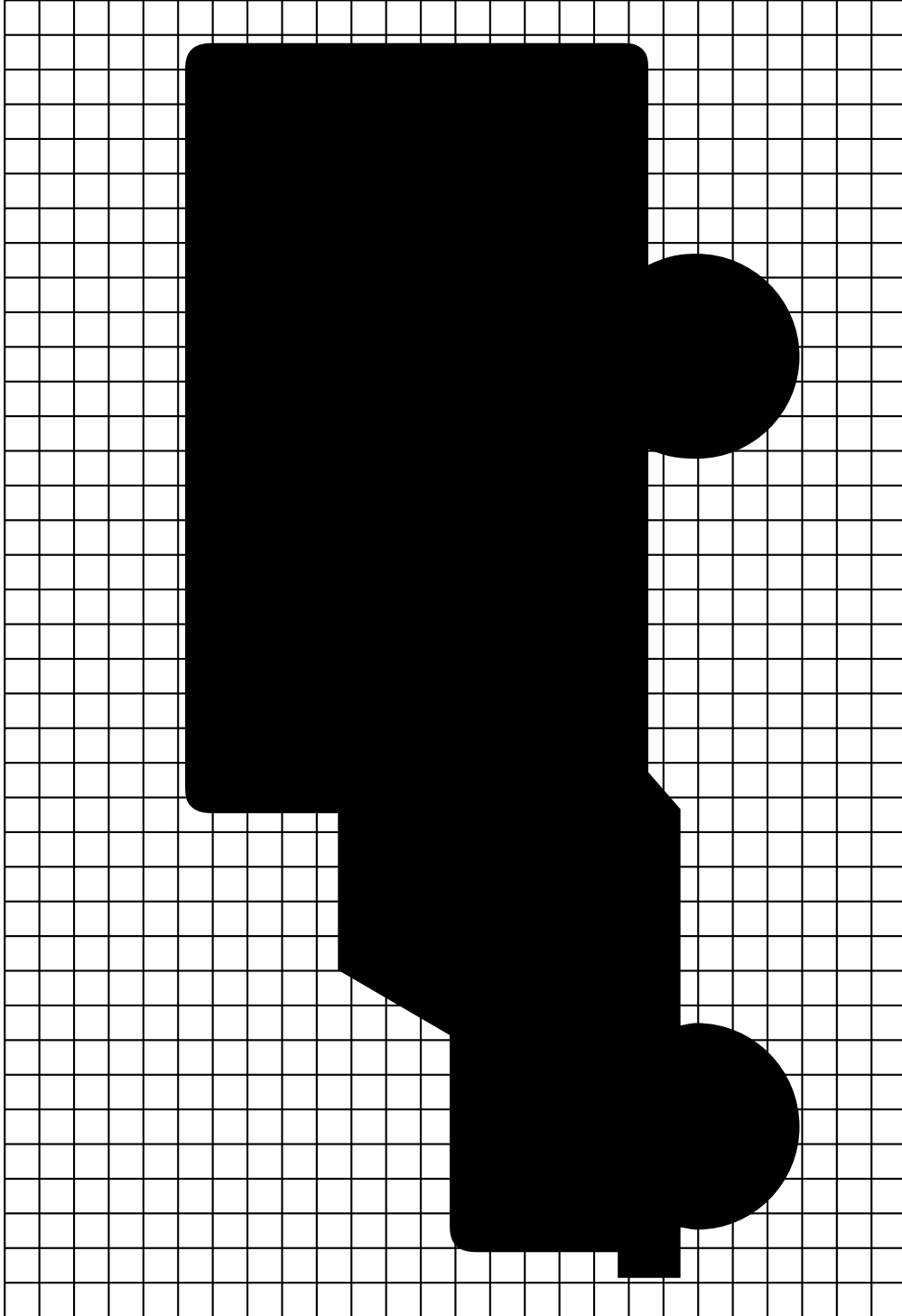

APPENDIX D-39

10/97

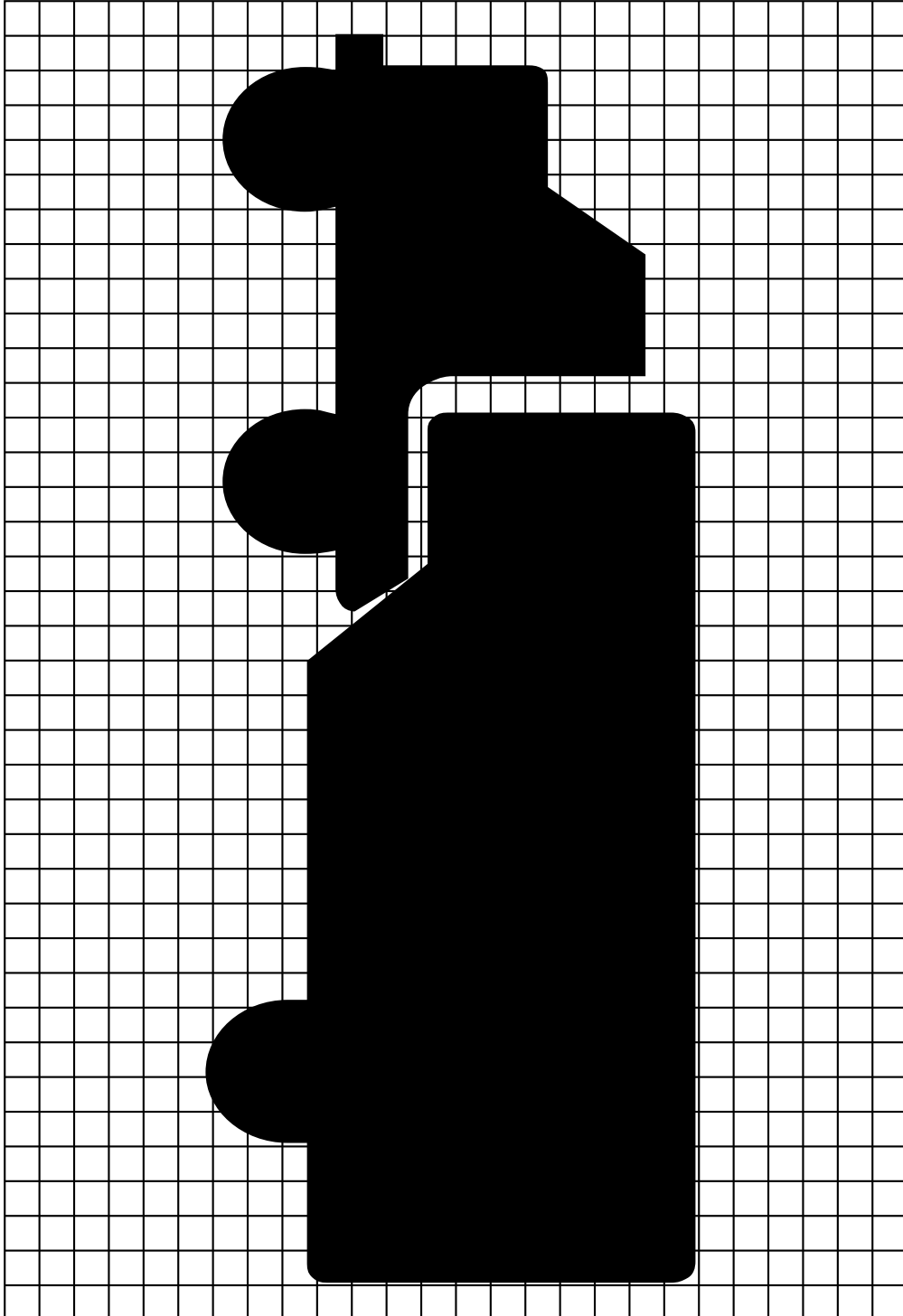

APPENDIX D-40

10/97

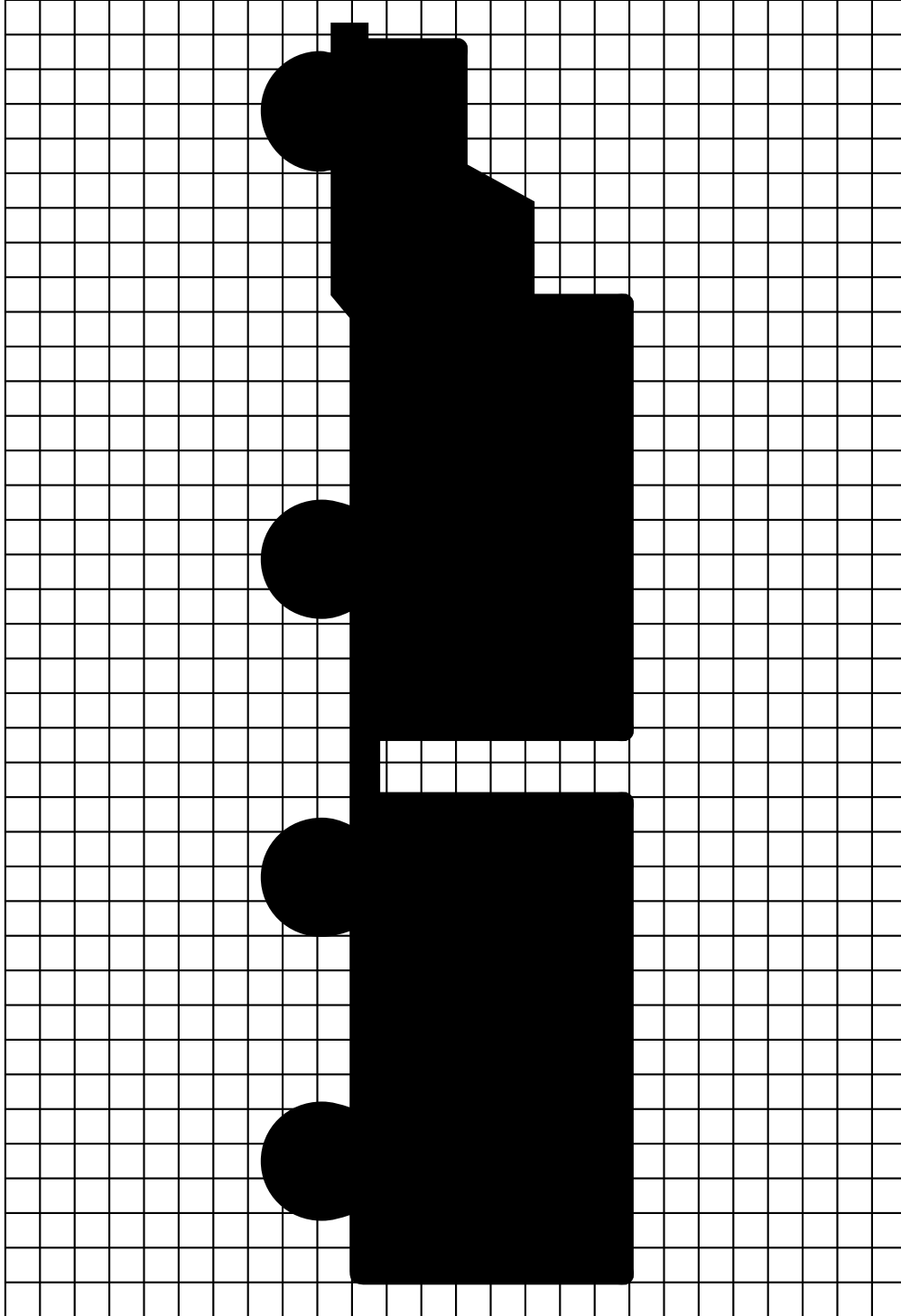

APPENDIX D-41

10/97

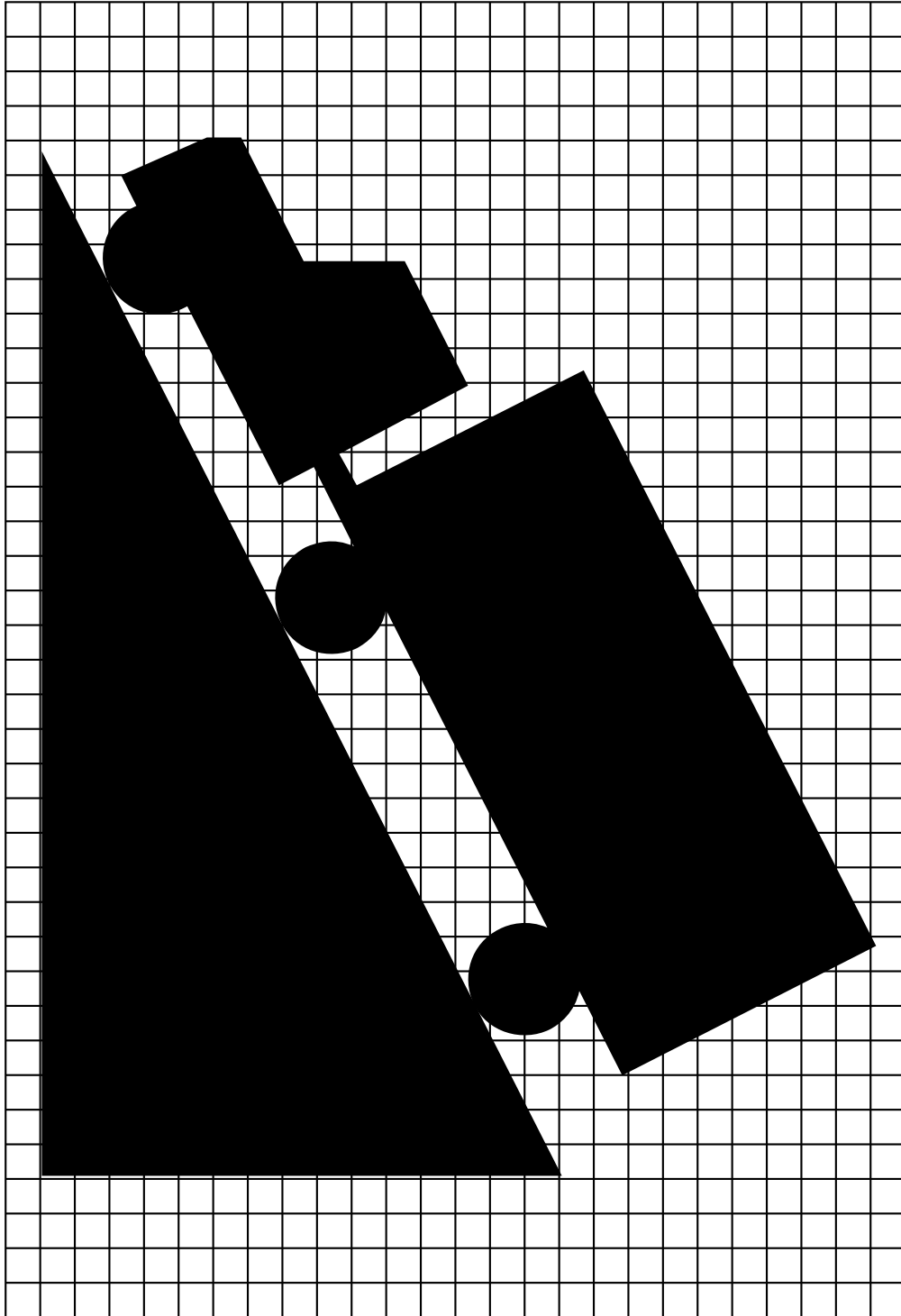

APPENDIX D-42

10/97

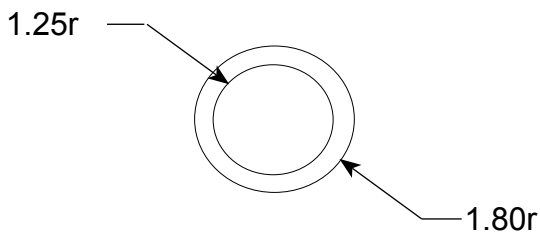
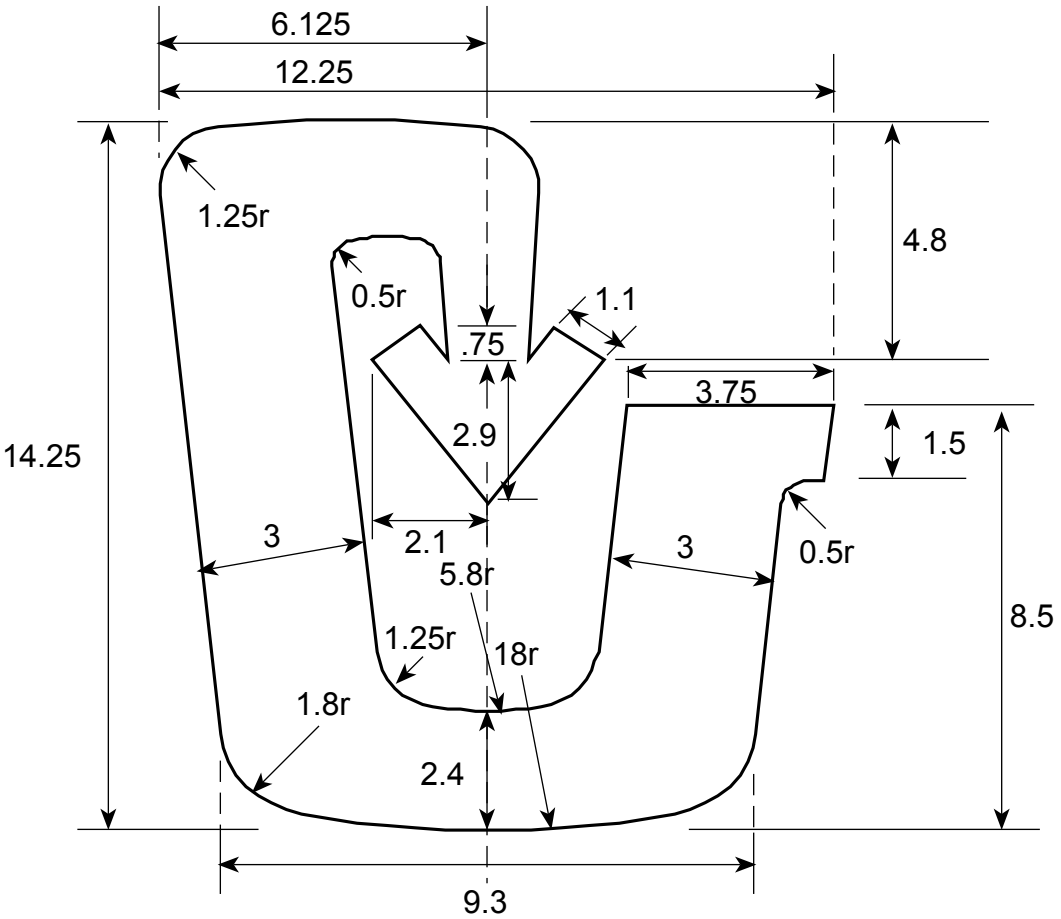

NOTE: MEASUREMENTS SHOWN IN DECIMAL INCHES

LITTER SYMBOL DETAILS
(REFLECTORIZED BLUE)

APPENDIX D-43

10/97

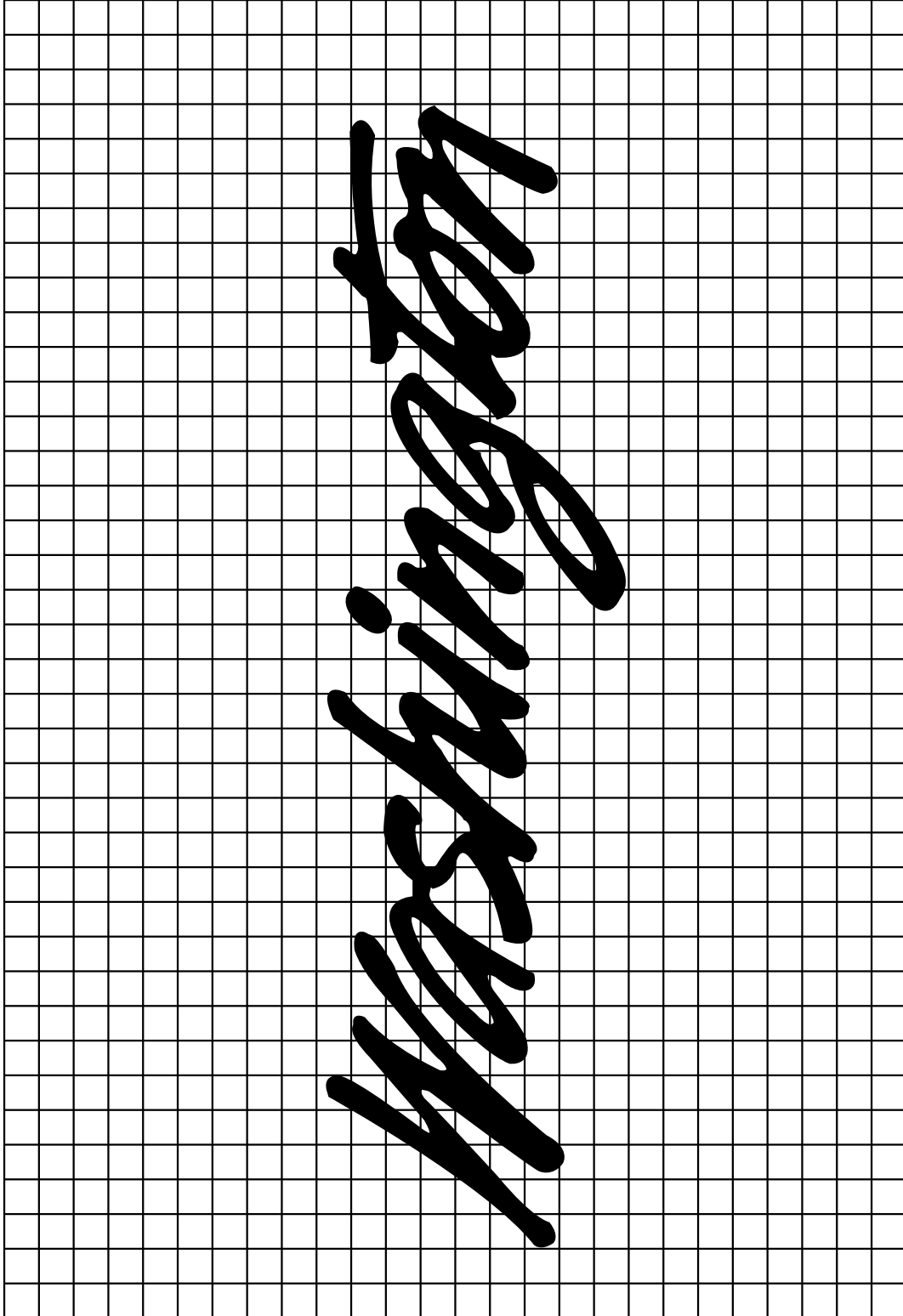

APPENDIX D-44

10/97

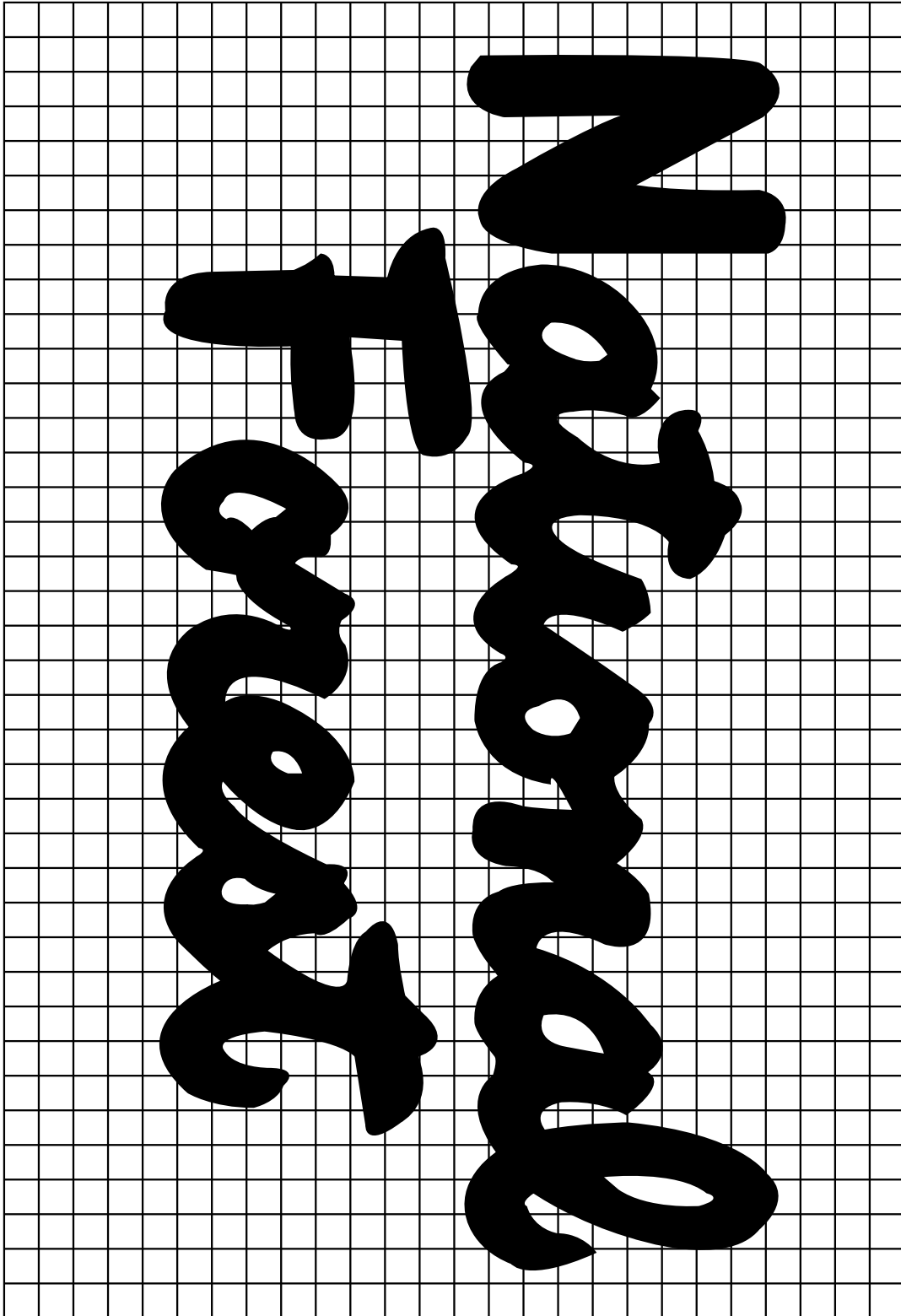

APPENDIX D-45

10/97

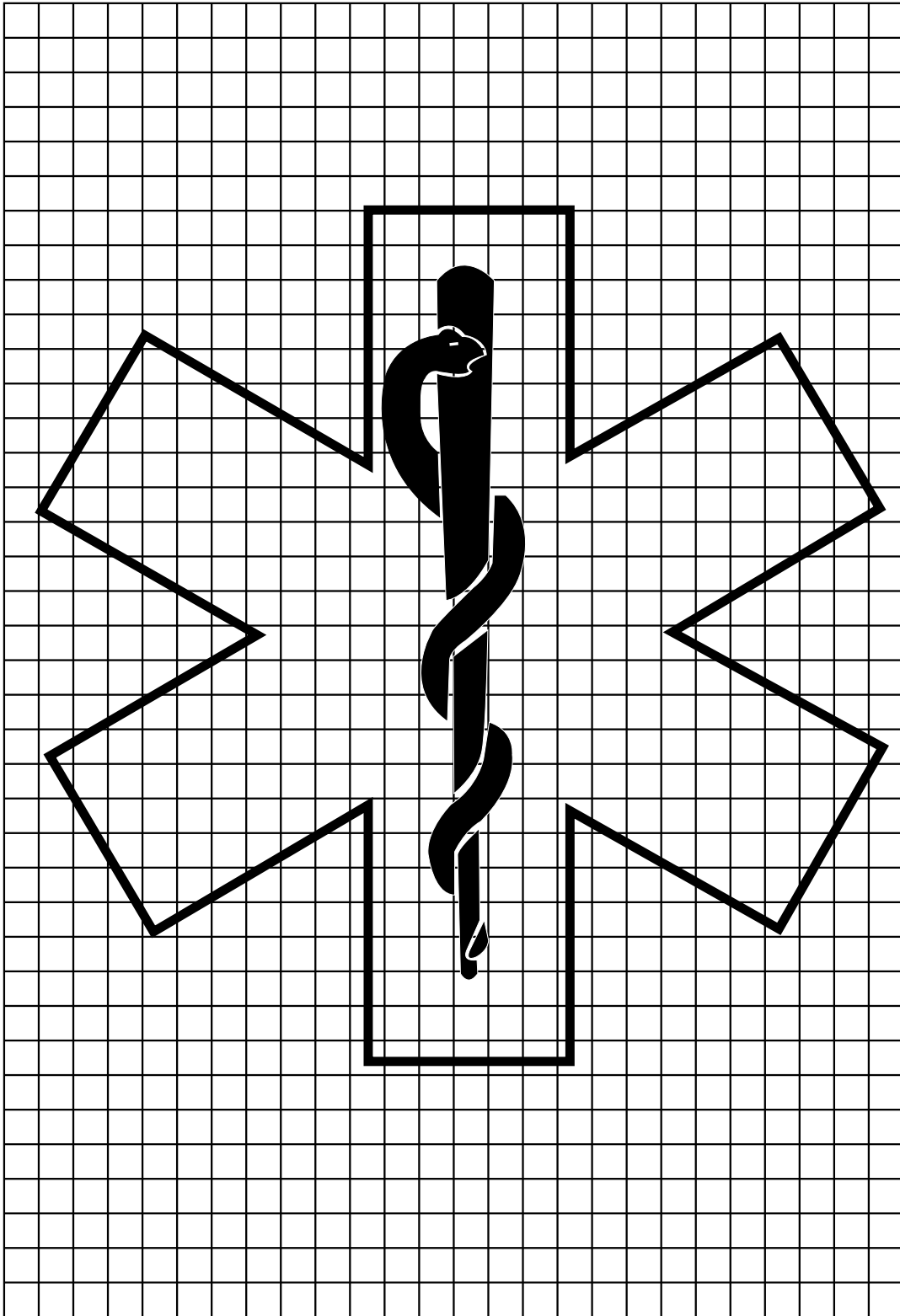

APPENDIX D-46

10/97

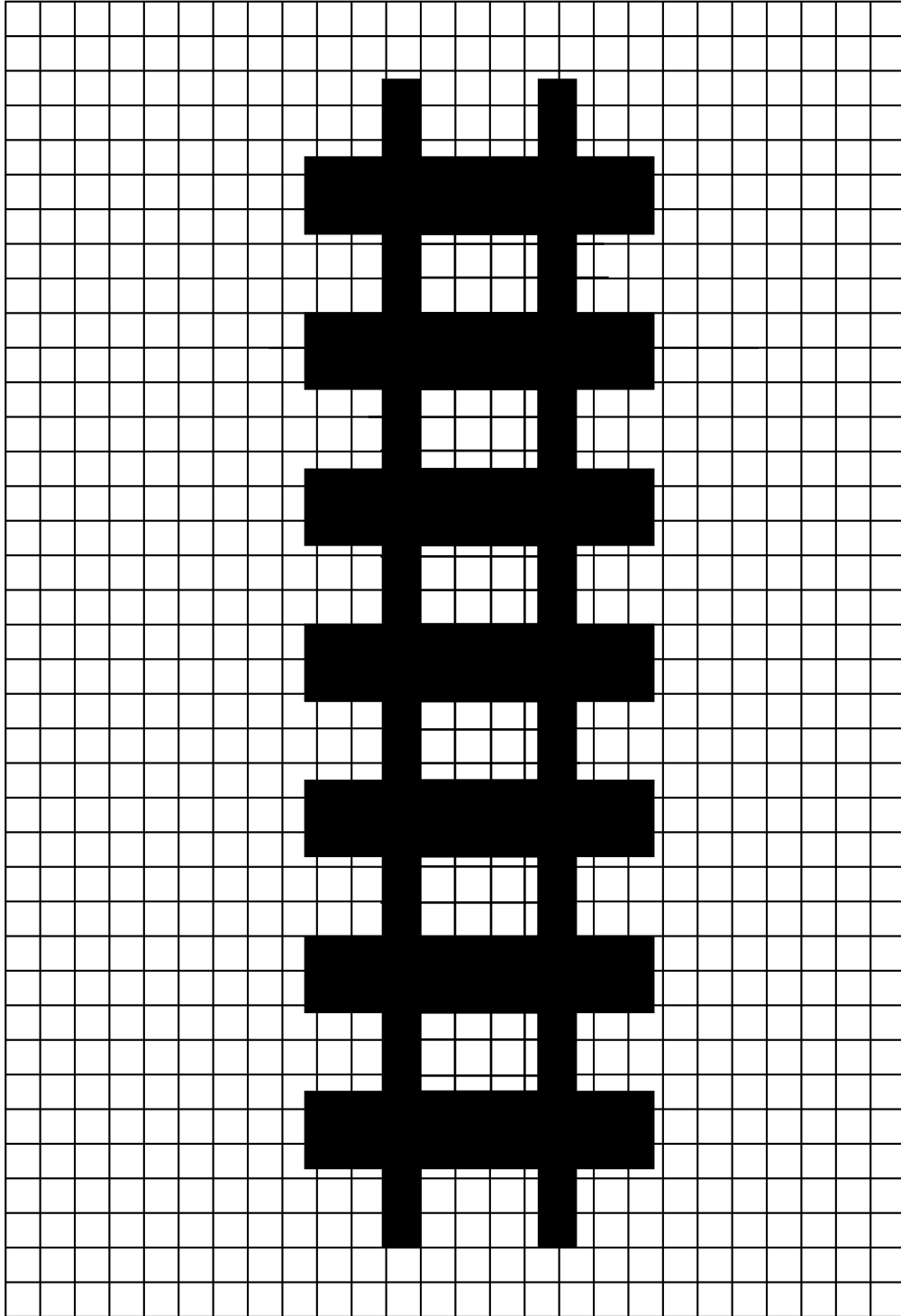

APPENDIX D-47

10/97

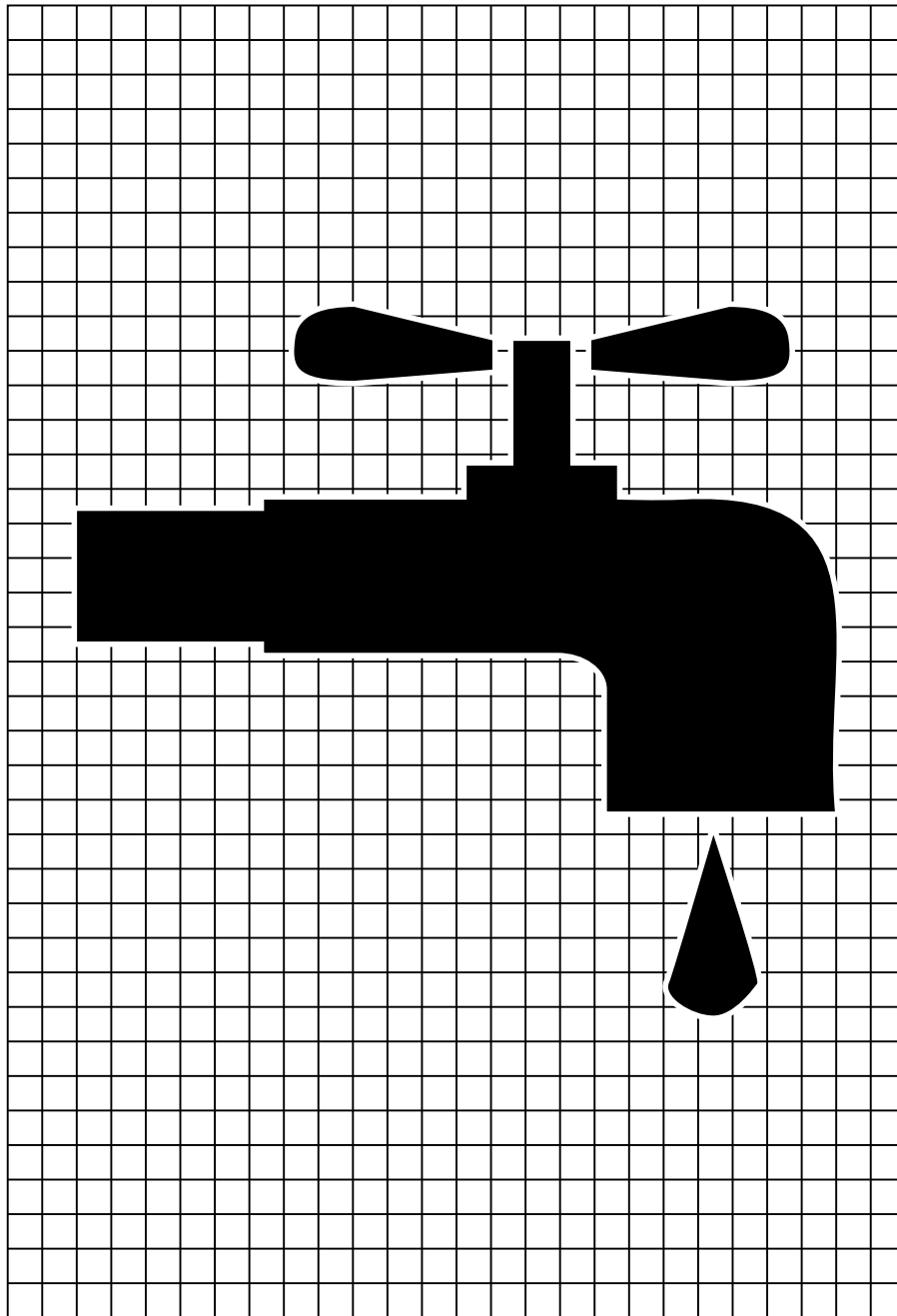

APPENDIX D-48

10/03

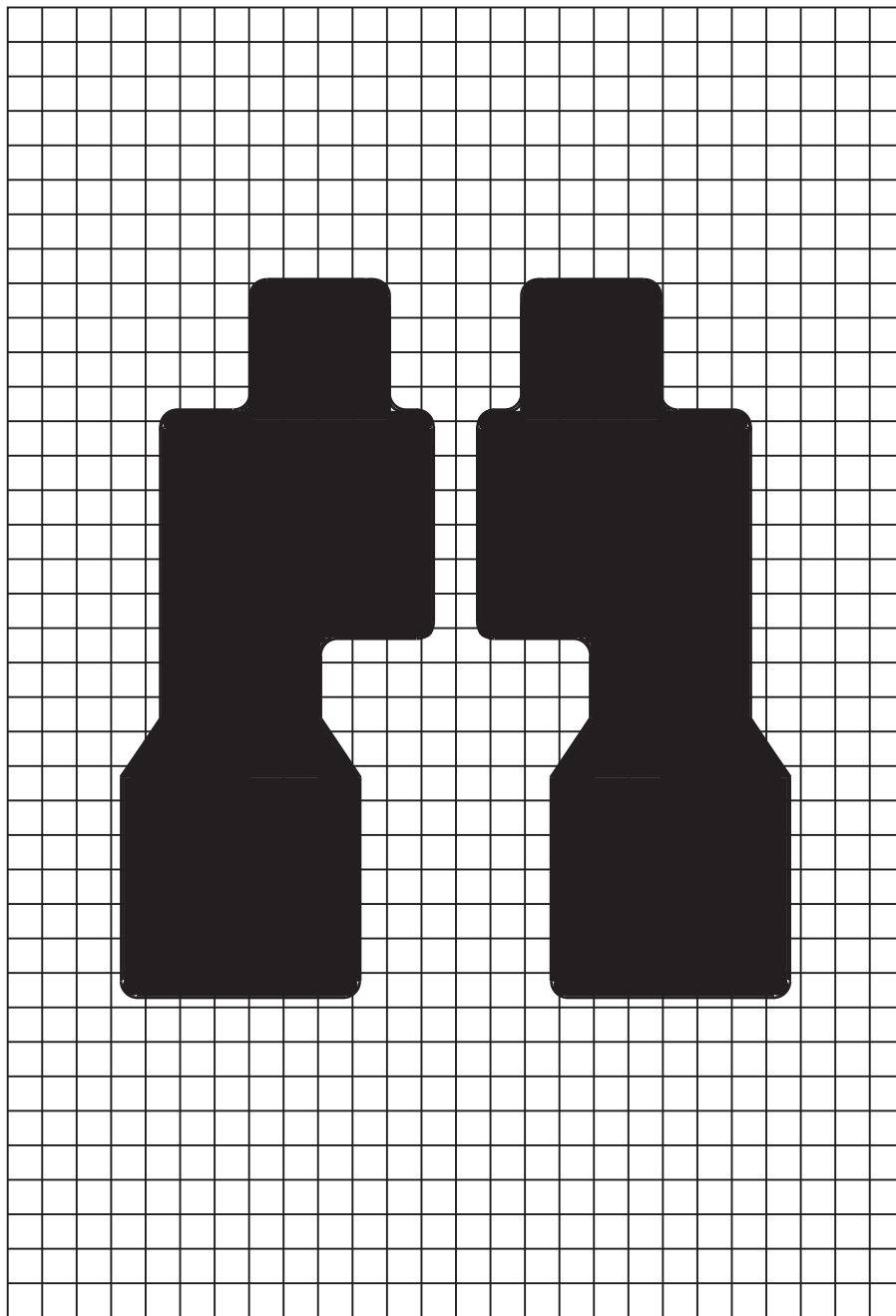

APPENDIX E-1

10/00

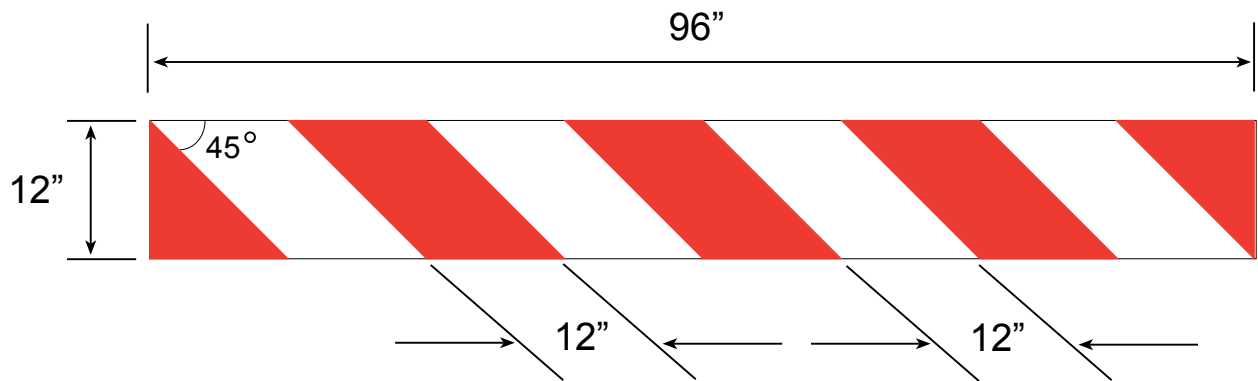

COLORS
WHITE (REFL)
RED (REFL)