

**NOTES:**

1. The contractor will provide necessary control points required during preliminary spotting for striping, stop lines, legends, crosswalks, traffic arrows, and signs. Crosswalk bars typically align with lane lines and mid-lane, placed to avoid wheel path. Crosswalk bars shall be parallel to the lanes' direction of travel.
2. Partial length crosswalk bars are not allowed. A single bar, as opposed to the double bar pattern may be used when space is limited adjacent to gutter, curb or intersecting crosswalk.
3. Typical stop line width is 12".
4. Stop line placement may require adjustment to account for signal detection equipment.

DCS

PUBLIC WORKS

NA

TACOMA POWER

REVIEWED BY

GMS

ENVIRONMENTAL SERVICES

NA

TACOMA WATER



APPROVED FOR PUBLICATION

*[Signature]* 8/16/16

CITY ENGINEER

DATE

CITY OF TACOMA  
TYPICAL CROSSWALK AND  
STOP LINE LAYOUT FOR  
VARIOUS CURB RAMP COMBINATIONS

STANDARD PLAN NO. CH-02

**NOTES:**

1. The Contractor will provide necessary control points for striping, stop lines, legends, crosswalks, traffic arrows, and signs. City inspection required before striping or associated sign installation begins.
2. Use of RPMs as shown correspond with paint striping. If striping consists of thermoplastic (or similar) then Type 1Y/W-RPMs are omitted.
3. RPMs shall not be placed over longitudinal or transverse joints of the pavement surface.

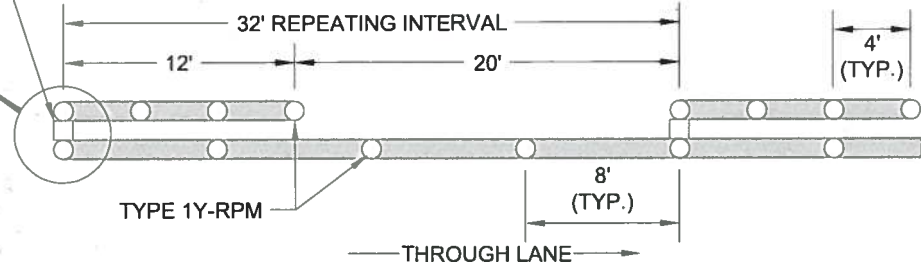
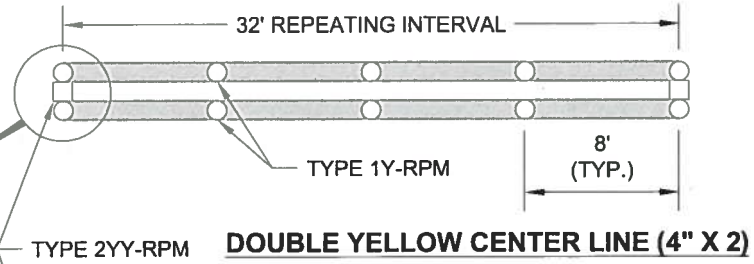
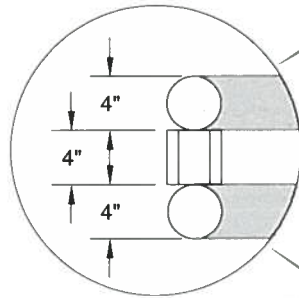

**YELLOW TWO WAY LEFT TURN LINE (4" X 2)**

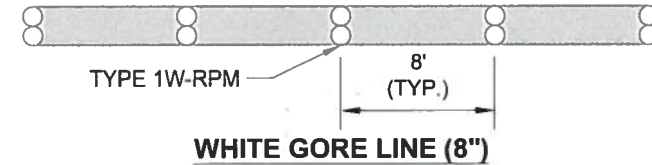

**WHITE GORE LINE (8")**

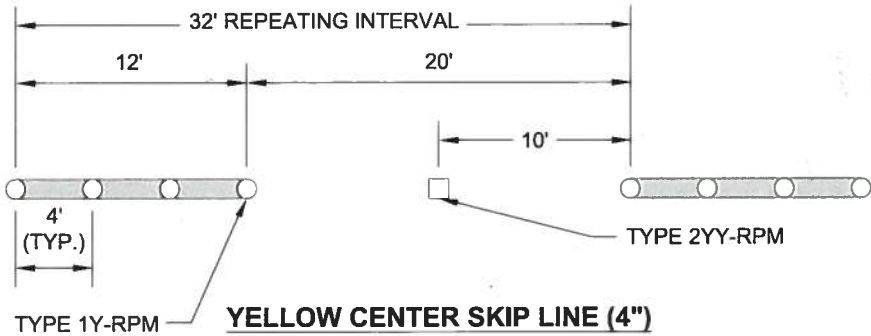

**YELLOW CENTER SKIP LINE (4")**

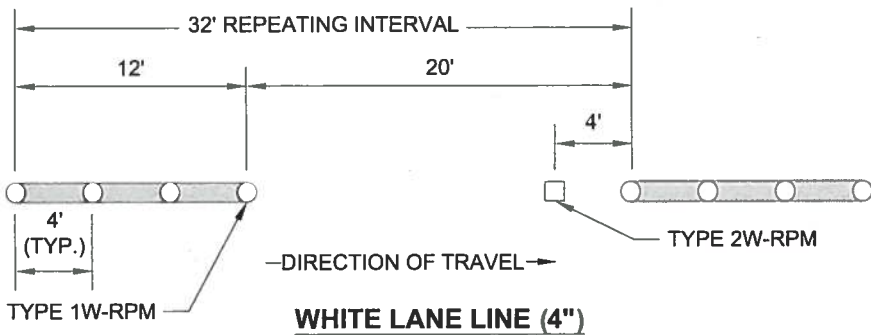

**WHITE LANE LINE (4")**

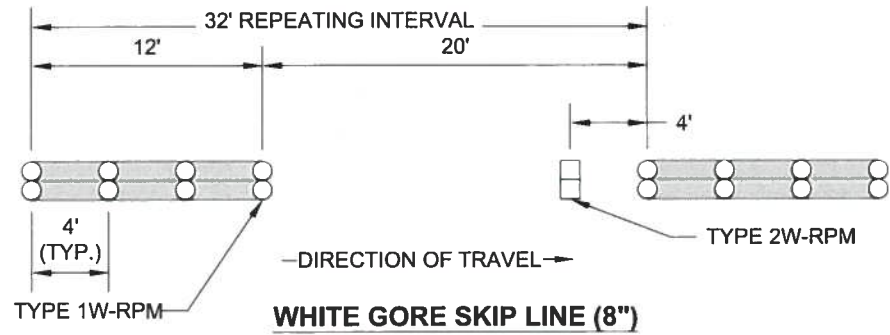

**WHITE GORE SKIP LINE (8")**

DCS

PUBLIC WORKS

NA

TACOMA POWER

REVIEWED BY

ENVIRONMENTAL SERVICES

TACOMA WATER



APPROVED FOR PUBLICATION

CITY ENGINEER

DATE

CITY OF TACOMA

LONGITUDINAL PAVEMENT MARKINGS

STANDARD PLAN NO. CH-03A

**NOTE:**

1. The Contractor will provide necessary control points for striping, stop lines, legends, crosswalks, traffic arrows, and signs. City inspection required before striping or associated sign installation begins.

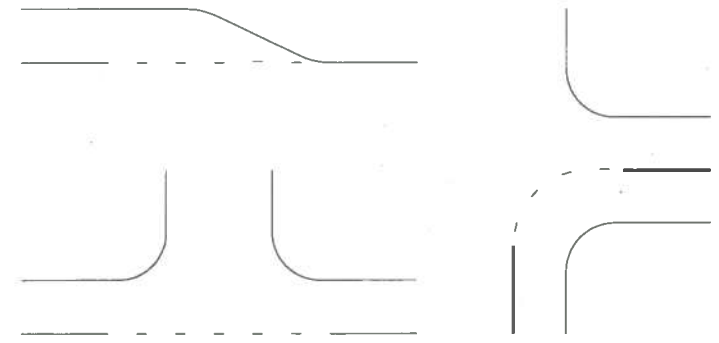
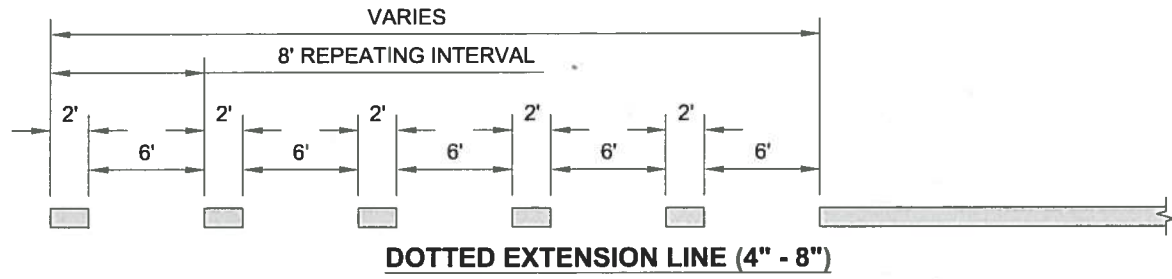

EXAMPLE APPLICATIONS OF DOTTED EXTENSION LINE

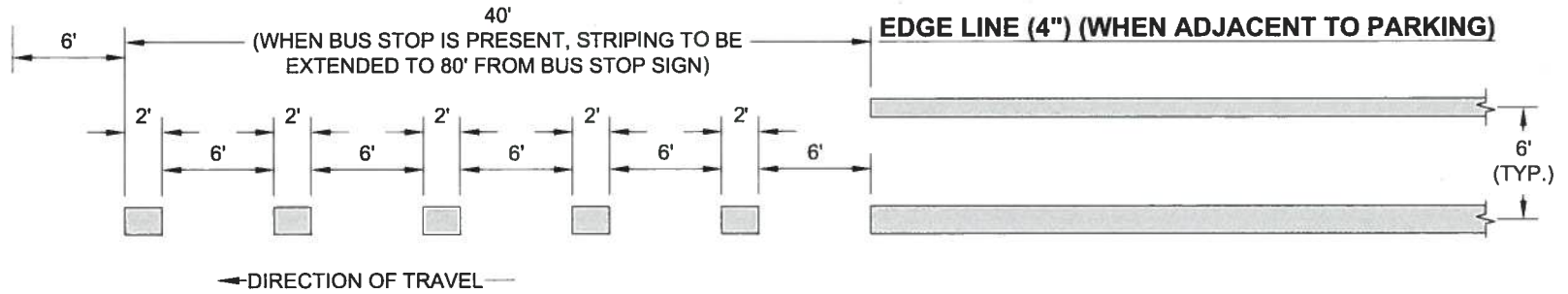

BIKE LANE SKIP LINE (6")

BIKE LANE LINE (6")

DCS PUBLIC WORKS	REVIEWED BY <i>[Signature]</i> ENVIRONMENTAL SERVICES
N/A TACOMA POWER	NA TACOMA WATER



APPROVED FOR PUBLICATION

*[Signature]*  
CITY ENGINEER

4/4/16  
DATE

CITY OF TACOMA

LONGITUDINAL PAVEMENT MARKINGS

STANDARD PLAN NO. CH-03B

**NOTES:**

1. Contractor will provide necessary control points to assist in preliminary spotting for striping, stop lines, legends, crosswalks, traffic arrows, and signs.
2. Refer to Standard Plan No. SU-05A (curb ramp details) for specifications of detectable warning patterns.

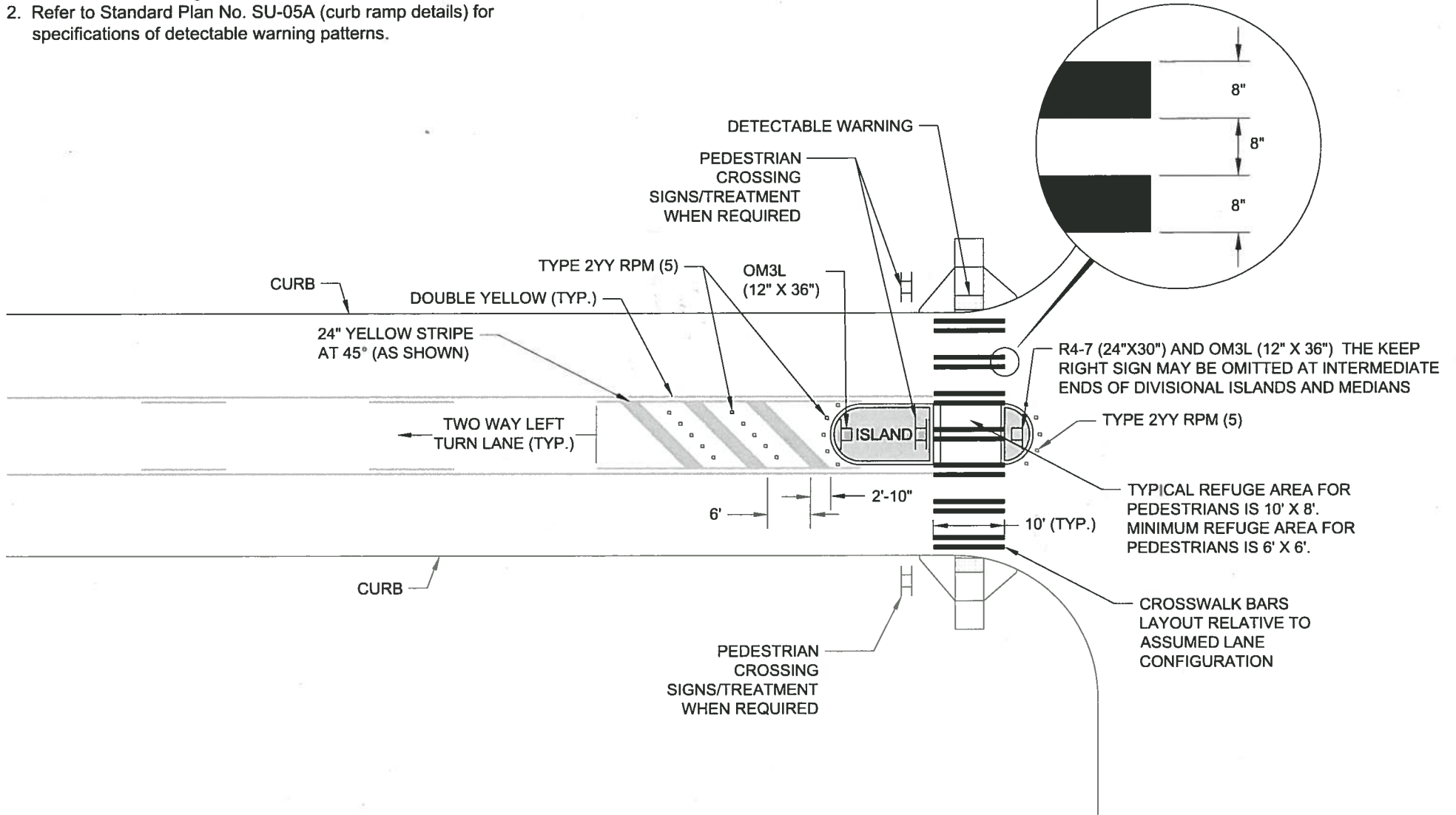

<p>DCS PUBLIC WORKS</p> <p>NA TACOMA POWER</p>	<p>REVIEWED BY <i>GMS</i></p> <p>ENVIRONMENTAL SERVICES NA TACOMA WATER</p>		<p>APPROVED FOR PUBLICATION</p> <p><i>[Signature]</i> CITY ENGINEER</p> <p><i>4/4/10</i> DATE</p>	<p>CITY OF TACOMA</p> <p>PAVEMENT MARKINGS AND SIGN LOCATIONS FOR PEDESTRIAN ISLAND</p> <p>STANDARD PLAN NO. CH-07</p>
--	---	--	---	--

**NOTES:**

1. Contractor will provide necessary control points to assist in preliminary spotting for striping, stop line, legends, crosswalks, traffic arrows, and associated signs.
2. If storage length is 100 feet or greater, then a second arrow, (without "only"), to be placed at 22 feet from stop line to near edge of the arrow.
3. Use of RPMs as shown correspond with paint striping. If striping consists of thermoplastic (or similar) then type 1Y/W-RPMs are omitted.

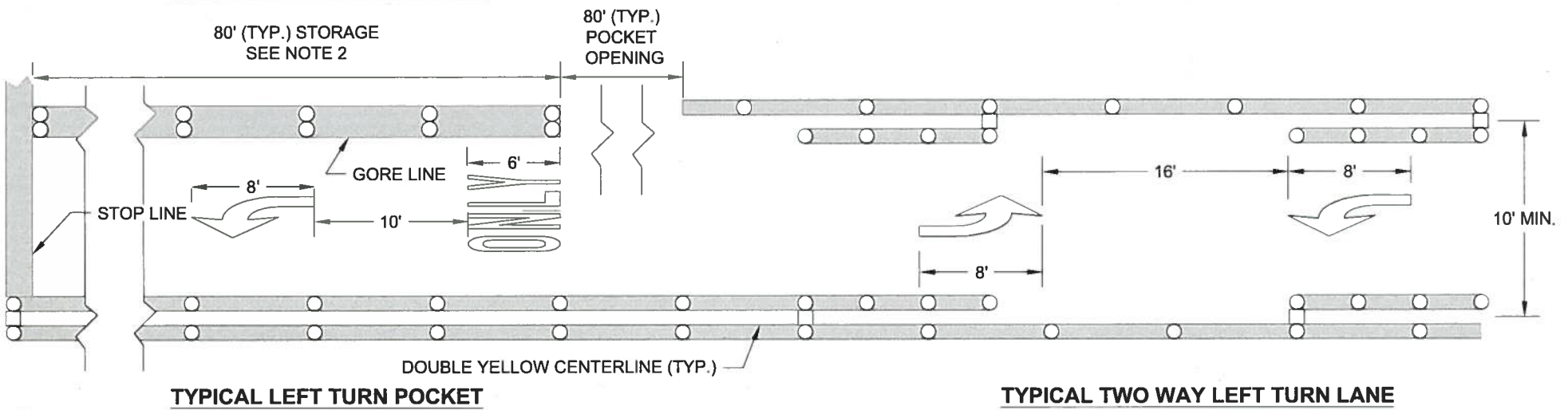
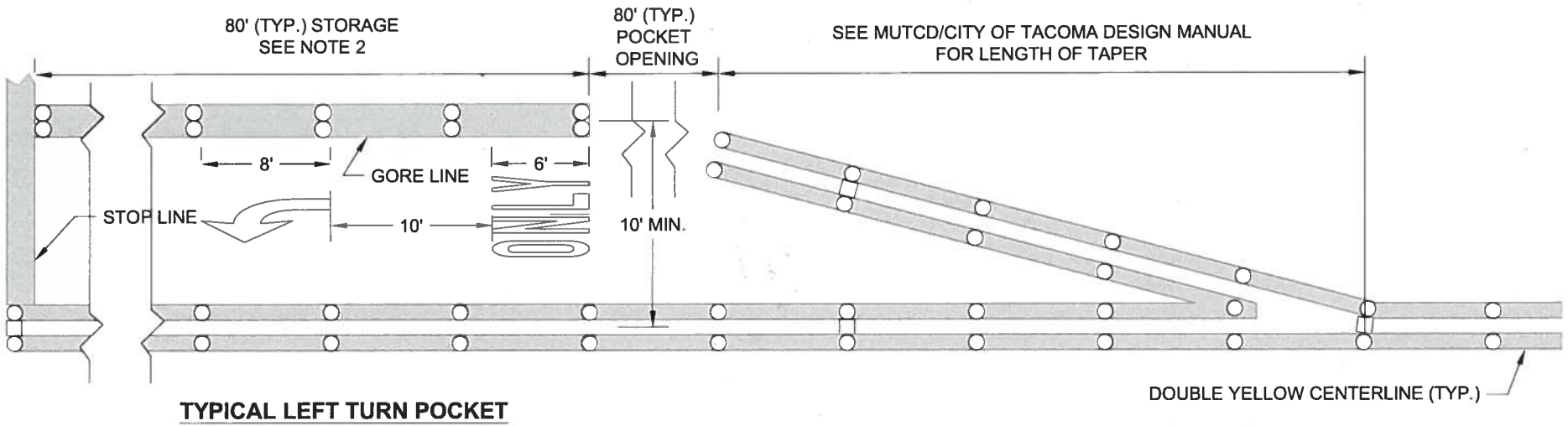

REVIEWED BY

DCS  
PUBLIC WORKS

NA  
TACOMA POWER

GMS  
ENVIRONMENTAL SERVICES

NA  
TACOMA WATER



APPROVED FOR PUBLICATION

[Signature]  
CITY ENGINEER

4/4/16  
DATE

CITY OF TACOMA

LEFT TURN POCKET  
PAVEMENT MARKINGS

STANDARD PLAN NO. CH-09

**NOTES:**

1. Contractor will provide necessary control points to assist in preliminary spotting for stripe, stop line, legends, crosswalks, traffic arrows, and associated signs.
2. Typical letter width is 11½".
3. Typical letter spacing is 8".
4. Letter stroke is 3½".
5. Refer to WSDOT M24.40-02 for more specific traffic arrow dimensions.
6. Arrows shown may be mirrored about their centerline as applicable to design.

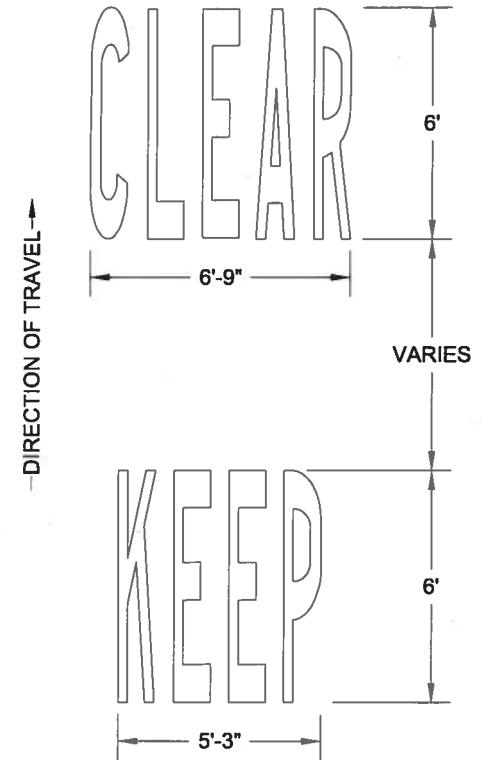
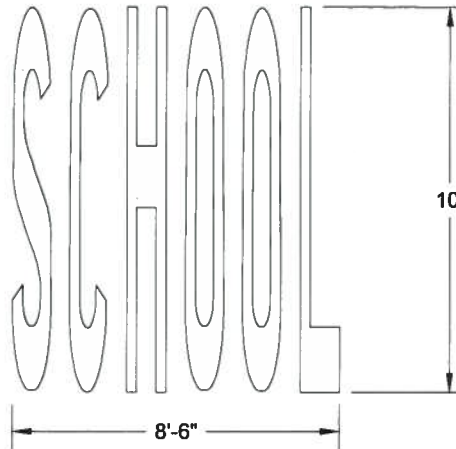
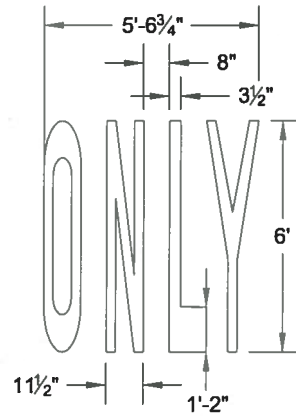
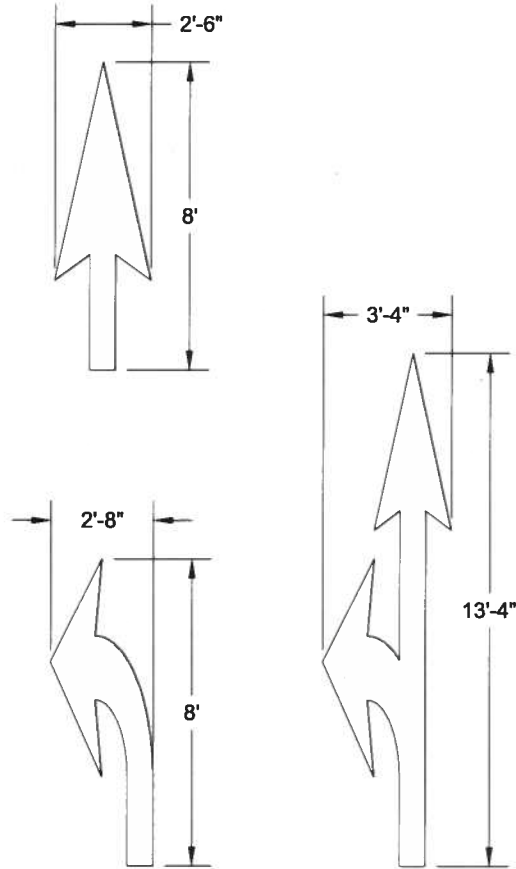

DCS  
PUBLIC WORKS  
NA  
TACOMA POWER

REVIEWED BY *Gang*  
ENVIRONMENTAL SERVICES  
NA  
TACOMA WATER



APPROVED FOR PUBLICATION

*Kurtis M. Kingsolver*  
CITY ENGINEER  
4/4/10  
DATE

CITY OF TACOMA

PAVEMENT WORDS AND ARROWS

STANDARD PLAN NO. CH-10