

Appendix K Transportation Impact Study

Appendices

This page intentionally left blank.



IBI GROUP
18401 Von Karman Avenue – Suite 300
Irvine CA 92612 USA
tel 949 833 5588 fax 949 833 5511
ibigroup.com

Memorandum

To/Attention Placeworks **Date** October 7, 2020
From IBI Group **Project No** 119772
cc
Subject Santa Ana General Plan Traffic Analysis Updates

This memo summarizes changes made to the Traffic Analysis prepared in support of the Santa Ana General Plan DEIR. The traffic analysis was circulated among relevant stakeholders in order to solicit input regarding the proposed reclassifications and analysis methodology. The major changes incorporated into the traffic analysis based on the comments received are summarized below:

- Adjustment of volumes in northeast corner for select intersections along Grand Avenue and Tustin Avenue. Volume changes at the intersection of Tustin Avenue and Santa Clara Avenue were highlighted by the City of Tustin as being excessive. Volumes were adjusted at intersections 74-76 and 91-93 in order to improve trip balance.
- Language for LOS impacts and mitigations updated to better address improvements.
- Fair –share added for non-City of Santa Ana intersections.
- LOS worksheets for the 2045 WP AM were added; they were missing in original appendix.
- V/C and LOS updated for intersection #98 at Red Hill and Warner. An impact was caused as part of the update. Mitigation was developed.
- Additional roadway segments added to analysis.
- Mitigation measure for intersection #3 at Euclid Street and Edinger Avenue expanded.
- Mitigation measure for intersection #62 at Santa Ana Boulevard and Santiago Street modified.
- Mitigation at intersection #100 at Red Hill Avenue and Alton Parkway modified.
- Updates to Figure 2.1 through 2.7.

**Santa Ana General Plan Update
Traffic Impact Study
FINAL Report**

Prepared for:

*City of Santa Ana
Public Works Agency
20 Civic Center Plaza, M-36
Santa Ana, CA 92701*



By:

*IBI Group
18401 Von Karman Ave, Suite 300
Irvine, CA 92612
(949) – 833 – 5588*

October 2020

DOCUMENT HISTORY

Version	Date	Originator	Revisions By	Status
1	06/05/20	Y. Esquivel		Initial draft.
2	07/21/20	Y. Esquivel	Y. Esquivel	Draft revision.
3	08/24/20	Y. Esquivel	Y. Esquivel	Draft revision.
4	10/20/20	Y. Esquivel	Y. Esquivel	Final Draft.
5				
6				
7				
8				

Table of Contents

1.0	Introduction.....	1
	1.1 Study Purpose.....	1
	1.2 Report Organization.....	1
2.0	Project Description	4
	2.1 Background.....	4
	2.2 Study Area.....	4
	2.3 Circulation Element Roadway Classifications	8
	2.4 Scenario Summary.....	9
	2.5 Existing Year (2020)	9
	2.6 Future Year (2045) No Project	9
	2.7 Future Year (2045) With Project.....	13
3.0	Analysis Methodology.....	17
	3.1 Vehicle Miles traveled (VMT) Analysis	17
	3.2 Roadway Level of Service Analysis	19
	3.3 Intersection Level of Service.....	20
	3.4 Intersection LOS and Significant Impact Criteria.....	23
	3.5 Traffic Volumes.....	24
4.0	Existing Year (2020) Conditions	30
	4.1 Existing Roadway Network	30
	4.2 Study Intersection Geometry and Peak Hour Volumes.....	33
	4.3 Existing Year (2020) Vehicle Miles Traveled (VMT)	42
	4.4 Existing Year (2020) Roadway Segment Level of Service.....	42
	4.5 Existing Year (2020) Intersection Level of Service.....	46
5.0	Future Year 2045 Forecast Modeling	50
	5.1 Orange County Transportation Authority Model (OCTAM)	50
	5.2 Peak Hour Forecasts	50
6.0	Future Year (2045) No Project.....	52
	6.1 Future Year (2045) No Project Vehicle Miles Traveled (VMT)	61
	6.2 Roadway Segment Level of Service	61
	6.3 Intersection Level of Service	64
7.0	Future Year (2045) With Project.....	69
	7.1 Future Year (2045) With Project Vehicle Miles Traveled (VMT)	78
	7.2 Roadway Segment Level of Service	78
	7.3 Intersection Level of Service	81
8.0	VMT and LOS Analysis.....	86
	8.1 VMT Impact Analysis.....	86
	8.2 Level of Service Assessment	87
9.0	Conclusions	107
	9.1 VMT Impact Analysis.....	107
	9.2 Intersection LOS Analysis	107
	9.3 Roadway LOS	108

10.0 Appendices 109

- APPENDIX A – Lane Geometries 109
- APPENDIX B – Intersection Volumes 109
- APPENDIX C – OCTAM Volume Plots 109
- APPENDIX D – Analysis Worksheets 109
- APPENDIX E – Mitigation Worksheets 109
- APPENDIX F – VMT Calculations 109
- APPENDIX G – OCTAM 2045 Volume Comparison Plots 109
- APPENDIX H - COUNTS 109

Page intentionally left blank

1.0 Introduction

1.1 STUDY PURPOSE

This traffic analysis report has been prepared in support of the General Plan Update (GPU) Draft Program Environmental Impact Report (PEIR) for the City of Santa Ana and to assess requested changes to the Orange County Transportation Authority's (OCTA) Master Plan of Arterial Highways (MPAH) by the City of Santa Ana. This traffic analysis report reviews existing and future traffic conditions under the current General Plan and with the proposed Land Use Element and Circulation Element Updates.

This report is used as part of the Program EIR prepared for the General Plan Update. The Program EIR includes the results and findings of this traffic study report and identifies the significant impacts of the proposed project. The draft Program EIR will be available to the public for review and comment.

1.2 REPORT ORGANIZATION

This report consists of 11 sections.

- 1.0 Introduction
- 2.0 Project Description
- 3.0 Circulation Element Roadway Classifications
- 4.0 Analysis Methodology
- 5.0 Existing Year (2020) Conditions
- 6.0 Future Year 2045 Forecast Modeling
- 7.0 Future Year (2045) No Project
- 8.0 Future Year (2045) With Project
- 9.0 Significant Impacts and Mitigation Measures
- 10.0 Conclusions
- 11.0 Appendices

Section 1 provides a brief introduction to the study area and report organization. Section 2 provides a summary of the project description, background history, and project alternatives. Section 3 describes the various roadway classifications within the Circulation Element. Section 4 includes the methodology utilized in the analysis and the referenced standards. The study area roadways and Existing Year (2020) intersection geometry, turning movement volumes, and level of service are presented in Section 5. The Future Year (2045) forecast modeling methodology is provided in Section 6. Section 7 describes the Future Year (2045) No Project condition and provides the roadway segment and intersection level of service results. Section 8 describes the Future Year (2045) With Project Network Alternative condition and provides the roadway segment and intersection level of service results. Section 9 presents the mitigation measures to address facilities operating at an unacceptable level of service. Findings and conclusions from this study are presented in Section 10. Appendices are provided in Section 11.

The City boundaries/project study area is shown in Exhibits 1.1 and 1.2.

Exhibit 1.1 Project Location

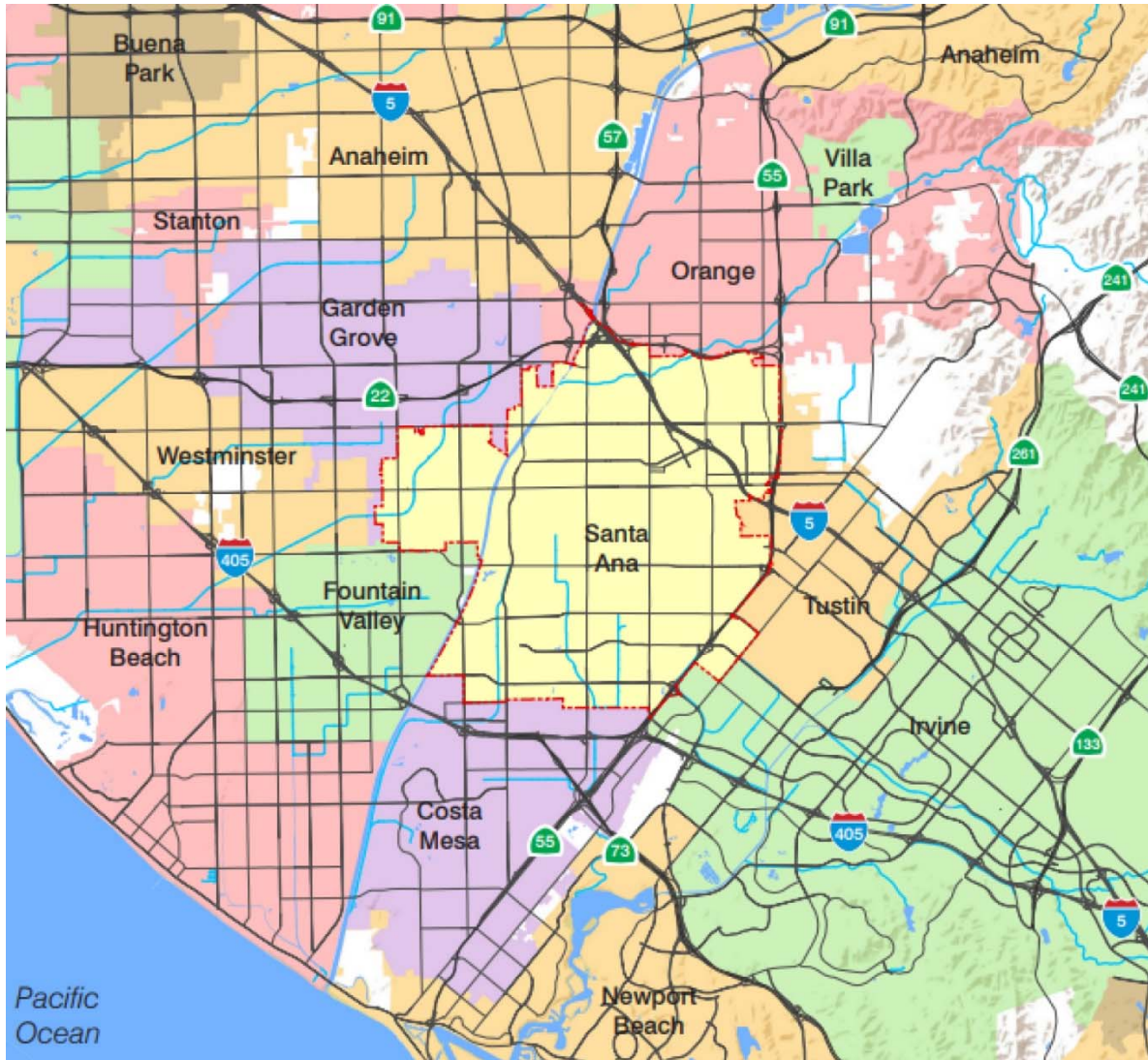
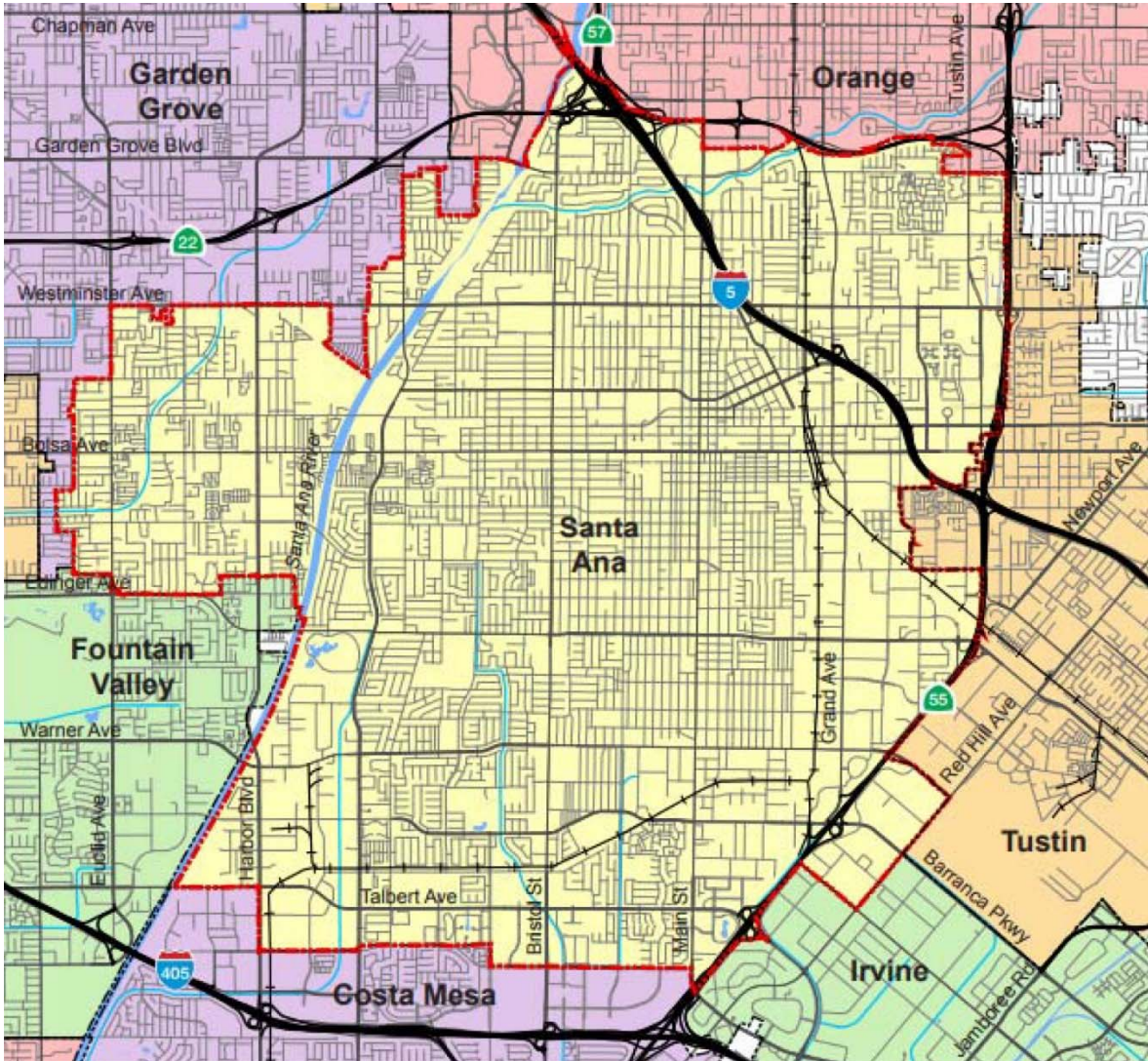

Exhibit 1.2 Project Study Area



2.0 Project Description

This section provides an overview of the project background and traffic study for the General Plan Update. This section also includes a description of the land use and Circulation Element network derived throughout the public outreach and planning process.

2.1 BACKGROUND

The City of Santa Ana's General Plan is comprised of 16 elements, serving as the principal long-range policy and planning document guiding the development, conservation, and enhancement of the City. Each element contains goals and policies related to the physical development of the City. The General Plan was adopted by City Council in 1998 and has been partially amended several times since then. For this analysis, the Land Use and Circulation Elements are of particular interest.

The Land Use Element serves as a long-range guide for land use and development within the City. The primary objective is to manage future growth, minimize land use conflicts, and facilitate growth and development as part of the City's overall vision.

The Circulation Element of the Santa Ana General Plan serves as the City's primary guide for transportation planning. The Circulation Element focuses on roadways and other transportation modes including public transit, railroads, pedestrian and bicycle paths that provide a full range of travel options.

The most recent update to the City of Santa Ana Circulation Element was authorized by City Council in 2011. The project was initiated to update the Circulation Element in its entirety to include the following key components:

- A Complete Streets Policy compliant with the requirements of Assembly Bill (AB) 1358
- OC Streetcar – a proposed streetcar service that would link the Santa Ana Regional Transportation Center (SARTC) with the Civic Center and Garden Grove. The project is currently under construction (at the time this report was written).

Over the last six years, the draft Circulation Element has gone through significant changes, including a new vision, completion of the Santa Ana Safe Mobility Plan, changes to the policy framework and roadway designations, OCTA modeling updates, work by the City on two separate Complete Street studies, advancement of a fixed-guideway/streetcar system and BRT routes, and incorporation of Complete Street Principals.

The updates to both the Circulation Element and the EIR are based on a proposed new roadway network scenario, updated OCTA modeling and new modal split, work on the Bikeway Master Plan and Pedestrian Opportunity Area Plan, regulatory changes (e.g., air quality/GHG requirements per 2015 Climate Action Plan, SB743, etc.), integrating related plans (Safe Mobility Santa Ana Plan, and complete street plans (Downtown and Central Santa Ana Transit Zone plans).

2.2 STUDY AREA

As noted, the project consists of changes to both land uses and the transportation network within the City of Santa Ana. The study area was chosen such that the direct and indirect effects of the project could be assessed, within the City of Santa Ana as well as in the adjacent cities. Study intersections were developed based on the locations of the proposed changes as well as in consideration of input provided by OCTA, Caltrans, and neighboring cities during outreach for the Circulation Element Update. Prior to merging with the GPU, the CEU was in the process of evaluating various transportation network

scenarios. The transportation network proposed in this study is a result of those efforts. Study roadway segments and intersections are shown in Exhibit 2.1 and 2.2, respectively.

Exhibit 2.1 Study Intersections

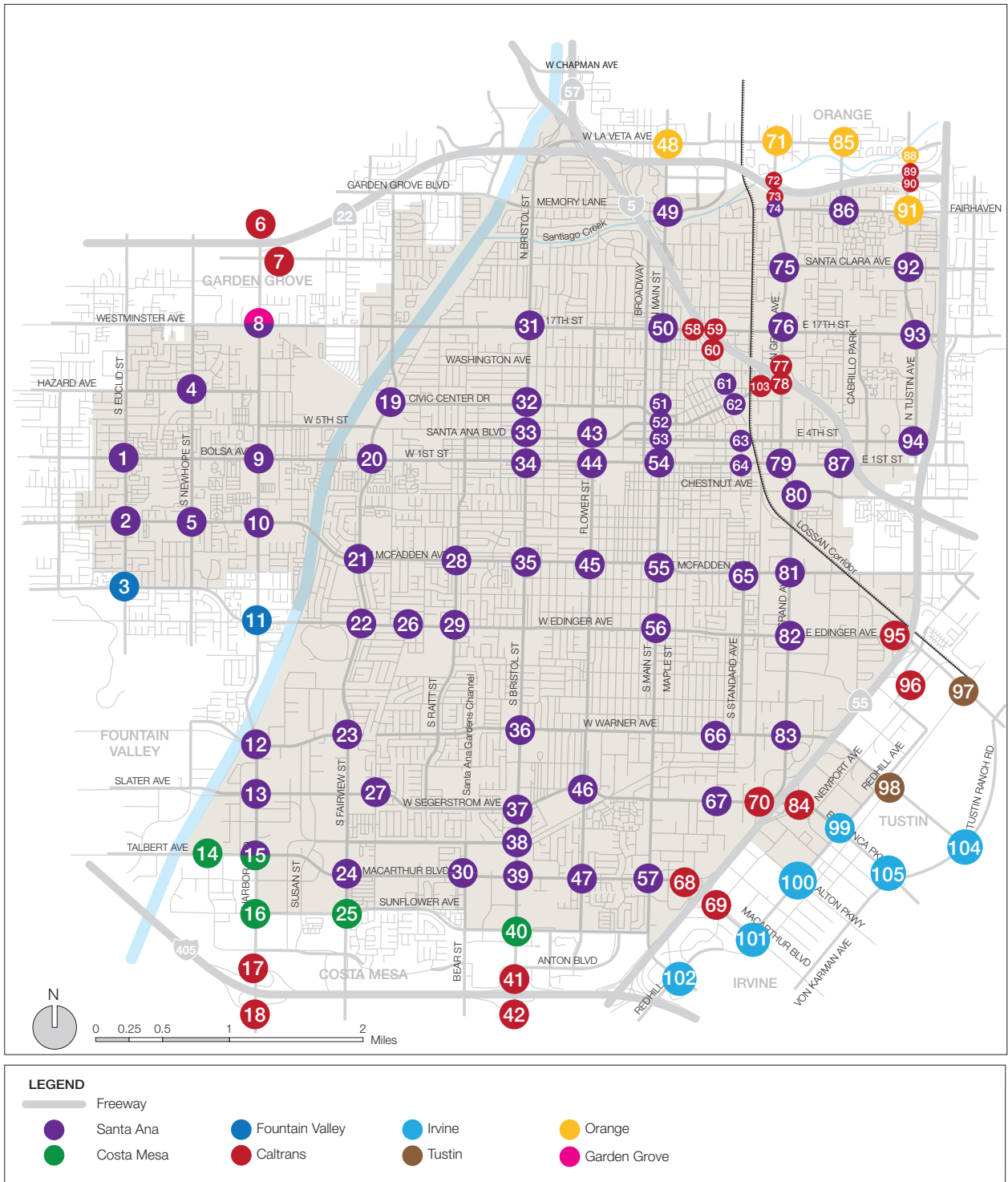
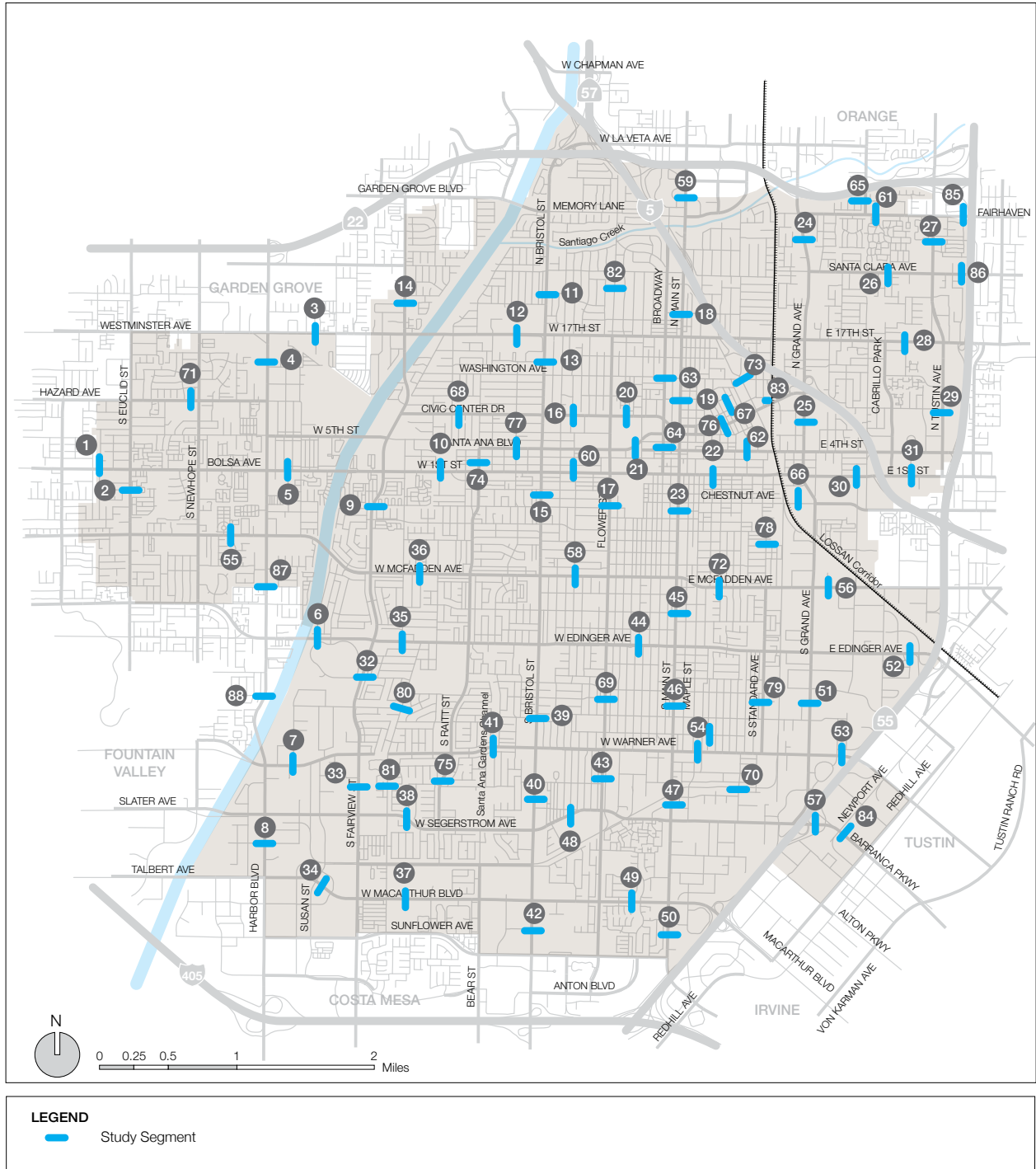

Exhibit 2.2 Study Roadway Segments



2.3 CIRCULATION ELEMENT ROADWAY CLASSIFICATIONS

The Circulation Element contains a Master Plan of Streets and Highways (MPSH) that uses a hierarchy of roadway classifications. Each roadway classification is described by size and function and has specific physical dimensions and characteristics. The MPSH contains regional arterials that connect to the countywide arterial network. OCTA's Master Plan of Arterial Highways (MPAH) is the County's planning document to ensure that the regional arterial highway network is maintained and developed in a coordinated manner between local jurisdictions to support mobility and future growth in the region. Consistency between the MPSH and MPAH is essential in order to maintain a functional regional arterial network and to receive funding from Measure M2 for street improvement projects.

Freeways

Freeways are multi-lane, limited-access, high-volume, high-speed roadways constructed for regional and interregional vehicular travel. Access to these facilities is restricted to interchange ramps at selected roadways along their route. Freeways are under the jurisdiction of the California Department of Transportation (Caltrans).

Principal Arterial

Typically, an eight-lane, divided roadway designed to accommodate between 45,000 to 67,500 vehicle trips daily. The typical right of way width is 144 feet.

Major Arterial

Generally consists of six-travel lanes, and is also divided. Typically, the right-of-way width for this type of roadway is 120 feet. A major arterial is designed to accommodate between 33,900 and 50,600 vehicle trips daily.

Primary Arterial

Generally consists of a four-lane, divided roadway. Typically, the right-of-way width is 100 feet. A primary arterial is designed to accommodate between 22,500 and 33,800 vehicle trips daily.

Secondary Arterial

Generally a four-lane, undivided roadway. The typical right-of-way width for this category of roadway is 80 feet. A secondary arterial is typically designed to accommodate between 15,000 and 22,500 vehicle trips daily.

Divided Collector Arterial

Generally a two-lane roadway with a continuous center two-way left-turn lane. The typical right-of-way width is 80 feet, for the purpose of allocating right-of-way to bicycle and pedestrian use. A divided collector arterial is designed to accommodate up to 22,000 vehicle trips per day.

Collector Street

A two-lane, undivided roadway. The right-of way width for this roadway classification is 60 feet. Collector Streets are also two-lane undivided roadways with a right-of-way width of 56 feet. A divided collector arterial is designed to accommodate up to 11,300 vehicle trips per day.

2.4 SCENARIO SUMMARY

This report presents the baseline analysis results for the existing year (2020) and future year (2045) baseline scenarios as well as future year (2045) project alternative scenario. These scenarios are listed below and described in the following sections:

- Existing Year (2020)
- Future Year (2045) No Project
- Future Year (2045) With Project – Proposed GPU

2.5 EXISTING YEAR (2020)

This scenario is representative of on-the-ground conditions for the transportation network and socio-economic makeup of the city for the year 2020. This scenario serves as a point of reference for future baseline and project alternative scenarios. The network and land use assumptions are as follows:

- The transportation network is reflective of configurations as of April 2020.
- Socio-economic data is representative of December 2019 conditions.

2.6 FUTURE YEAR (2045) NO PROJECT

This scenario serves as the baseline for future year (2045) analysis and consists of the following key assumptions:

- Transportation network and socio-economic data for OCTAM 5.0 Year 2045 Baseline scenario.
- Buildout of roadways consistent with the City of Santa Ana Master Plan of Streets and Highways map (MPSH) as shown in the Circulation Element (1998).
- Buildout of the Orange County Transportation Authority's (OCTA) Master Plan of Arterial Highways (MPAH)
- Freeway and transit improvements considered in the Preferred Alternative of OCTA's LRTP
 - OC Streetcar – The OC Streetcar Project is a proposed streetcar service that would travel between the Santa Ana Regional Transportation Center (SARTC) and Garden Grove. The streetcar is proposed to travel along an exclusive guideway or path on rails that are embedded in the pavement. The streetcar is proposed to travel primarily along Santa Ana Boulevard and along the Pacific Electric Right-of-Way.
 - Bus Rapid Transit (BRT) - These improvements include the Bus Rapid Transit projects along Harbor Boulevard, Bristol Street, and Westminster Avenue/17th Street.
- Modification of mode split for automobile, bicycle, and pedestrians to reflect new bicycle/pedestrian trips.

Exhibit 2.3 presents the current MPSH, which is consistent with the No Project Alternative. Exhibit 2.4 shows current MPAH designations. Exhibit 2.5 shows the Santa Ana Fixed Guideway (OC Streetcar) alignment.

Exhibit 2.3 Master Plan of Streets and Highways (MPSH)

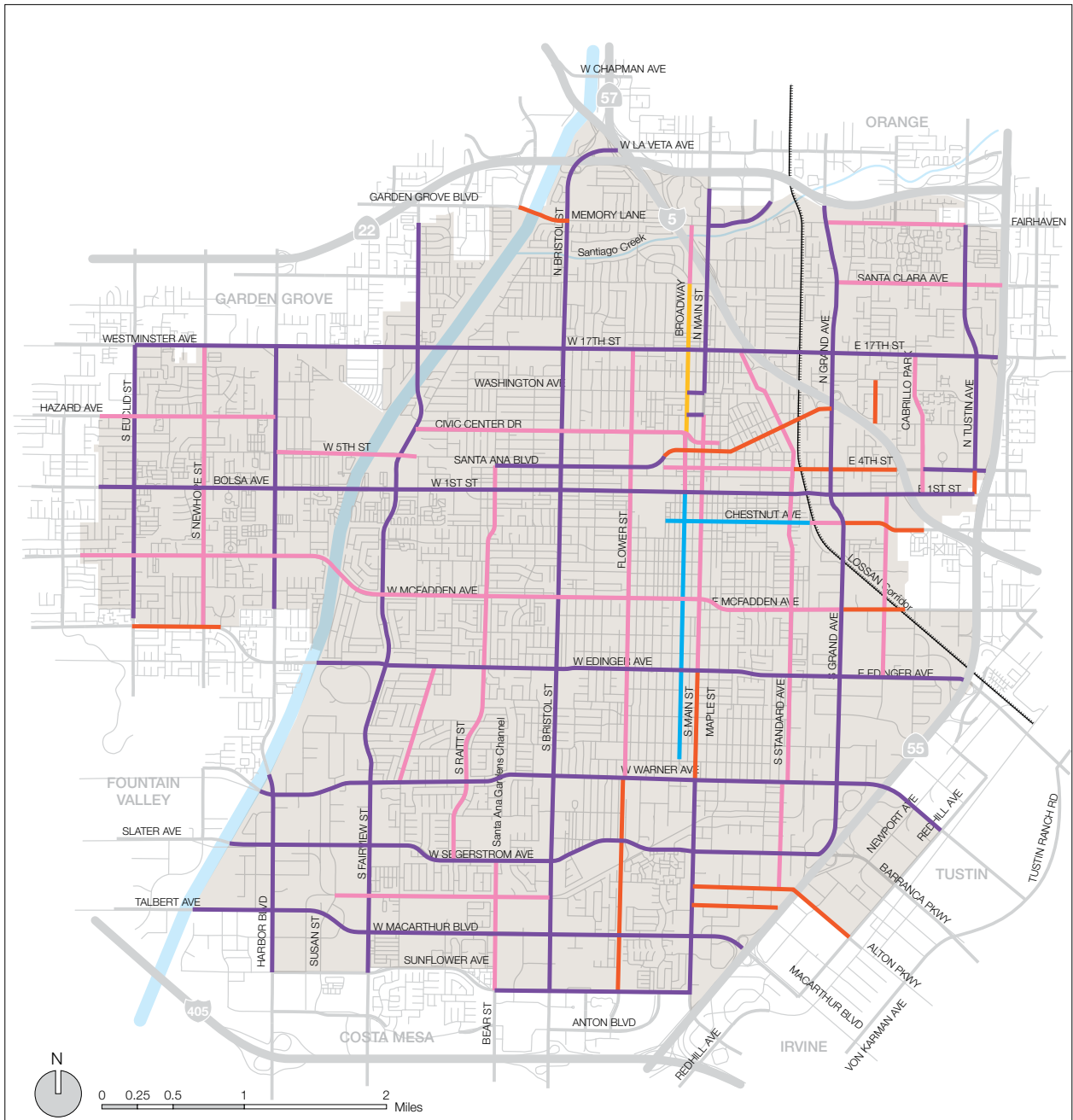

LEGEND	
	Freeway
	Principal
	Major Arterial
	Primary Arterial
	Secondary Arterial
	Commuter
	Local Commercial

Exhibit 2.4 OCTA Master Plan of Arterial Highways (MPAH)

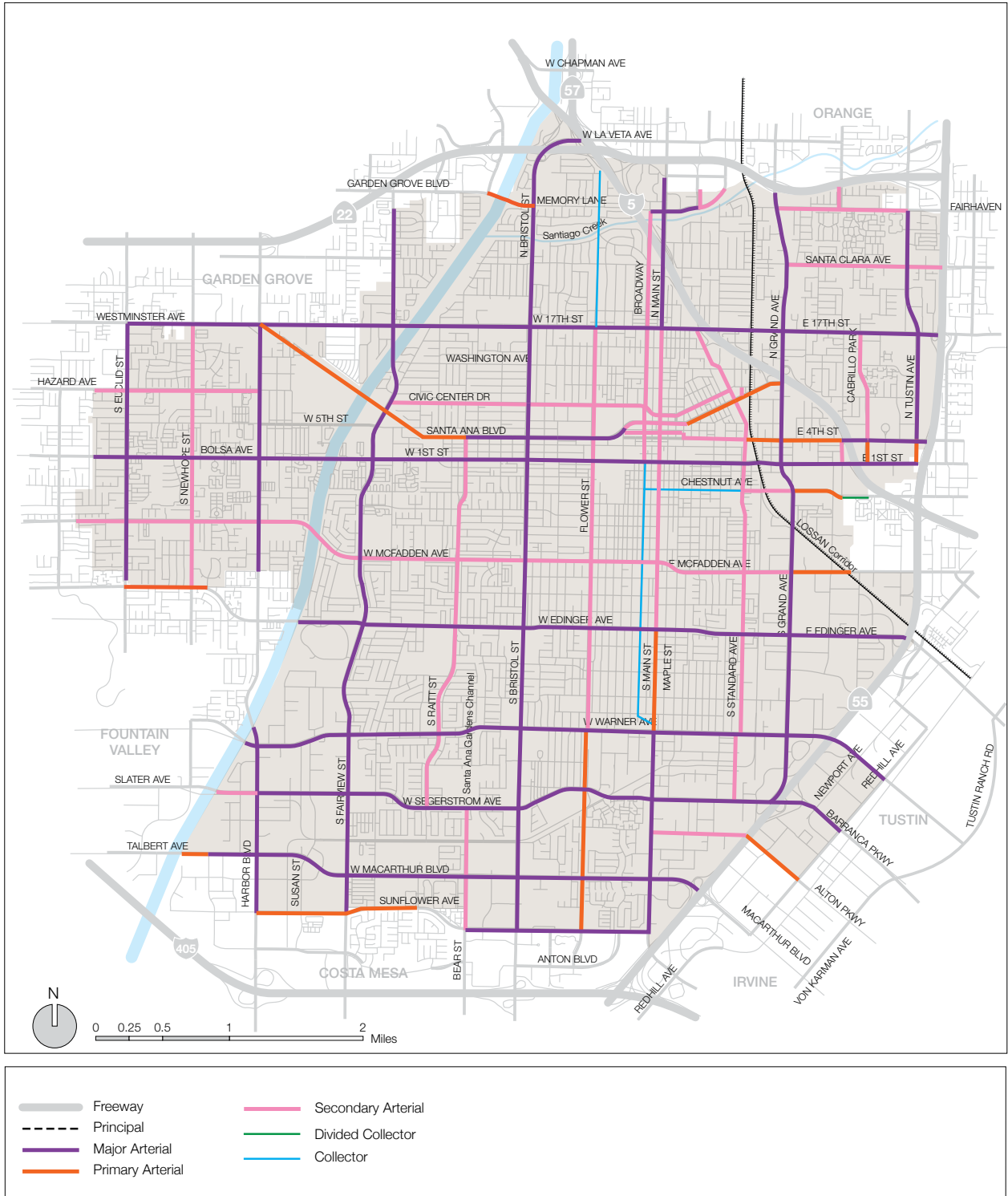

Exhibit 2.5 OC Streetcar Alignment



Source: Orange County Transportation Authority

2.7 FUTURE YEAR (2045) WITH PROJECT

This scenario is based on the Future Year (2045) No Project scenario, with modifications to both the transportation network and socio-economic data. Reclassifications to some roadways are proposed to facilitate the implementation of Complete Streets throughout the City as well as reconcile inconsistencies between the MPSH and MPAH. Additionally, this scenario considers the buildout of an updated Land Use Element for the General Plan.

The transportation network was developed through the evaluation of alternatives in the Circulation Element Update and in consideration of input provided by OCTA, Caltrans, and neighboring cities during outreach. This network is based on that of the No Project scenario, with the addition of the following modifications.

Classify the following streets as Divided Collector Arterials

- Santa Clara between Grand Avenue and SR-55 Freeway (currently Secondary)
- Flower Street between Warner Avenue and First Street (currently Secondary)
- Chestnut Avenue between Standard Avenue and East City Limit (currently Secondary/Primary)
- Raitt Street between Segerstrom and Santa Ana Boulevard (currently Secondary)
- Civic Center Drive between Fairview Street and Bristol Street (currently Secondary)
- Penn Way between I-5 on/off ramps and Washington Avenue (currently a secondary)
- Santiago Street between Washington Avenue and 6th Street (currently a secondary)
- Standard Avenue between 6th Street and Warner Avenue (currently a Secondary Arterial)
- Santa Ana Boulevard between French Street and Santiago Street (currently a Primary Arterial)
- Santa Ana Boulevard between Raitt and Flower (currently a Major)
- Cambridge Street between Fairhaven and SR-22 Freeway (currently Secondary)
- Hazard Avenue between Euclid and Harbor (currently Secondary)
- Halladay Avenue between Warner and Dyer (currently Secondary)
- McFadden Avenue between Harbor Blvd and Grand Ave (currently Secondary)
- Broadway between 1st and 17th (currently Secondary)
- 4th Street between French and Grand (currently Secondary/Primary)
- Fairhaven Avenue from Grand to Tustin (currently Secondary)

Classify the following streets as Primary Arterials

- Santa Ana Boulevard between Flower and Ross (currently a Major)
- 1st Street between Bristol Street and Tustin Avenue (currently Major)

Classify the following streets as Collector Arterials

- Civic Center Drive between French and Santiago (currently a Secondary Arterial)

Add the following streets to the MPAH as Divided Collector Arterials

- Greenville Street between Segerstrom Avenue and Warner Avenue

Add the following streets to the MPAH as Collector Streets

- Greenville Street between Edinger Avenue and Warner Avenue

Remove the following streets from the MPAH

- Flower Street between 17th Street and its northern terminus
- Logan Street between Civic Center Drive and Santa Ana Boulevard

Exhibit 2.6 presents the proposed street reclassifications. Exhibit 2.7 presents the With Project transportation network.

Exhibit 2.6 Proposed Arterial Roadway Reclassifications



Exhibit 2.7 Proposed Santa Ana Circulation Element Transportation Network



3.0 Analysis Methodology

The analysis methodology and impact criteria used in this analysis conform to the California Environmental Quality Act (CEQA) guidelines for a traffic impact analysis. CEQA identifies VMT as the preferred metric for identifying environmental impacts. Although VMT governs CEQA impacts, vehicle LOS is also assessed in order to address local operational performance and impacts. Additionally, roadway performance is assessed in order to monitor conformance with the Orange County Transportation Authority's (OCTA) Master Plan of Arterial Highways (MPAH) operational requirements.

Study intersections and roadway segments were assessed using the method specified by the City Santa Ana, Orange County Congestion Management Program (CMP) guidelines, and other governing agency guidelines. As such, intersections under the jurisdiction of the Cities of Santa Ana, Costa Mesa, Irvine, Tustin, Garden Grove, Fountain Valley, and Orange were assessed using the Intersection Capacity Utilization (ICU) method. Intersections under the jurisdiction of Caltrans were assessed using the Highway Capacity Manual 2000 method (HCM 2000).

3.1 VEHICLE MILES TRAVELED (VMT) ANALYSIS

The VMT analysis was prepared in conformance with the City of Santa Ana VMT Analysis Guidelines (VMT Guidelines; September 2019). The City's VMT Guidelines are based on the Office of Planning and Research's (OPR) Technical Advisory on Evaluating Transportation Impacts in CEQA (December 2018). A VMT analysis is to be conducted for land use and transportation projects that have the potential to increase the average VMT per service population (VMT/SP).

VMT is defined as the total miles traveled by vehicles (within a transportation network). Service population is described as the population generating the VMT of interest. A VMT analysis may be conducted for large-scale projects such as land use plans or individual transportation/development projects. For large-scale projects, it is appropriate to assess VMT impacts based on total VMT/SP. For individual projects, the VMT analysis may consider VMT and VMT/SP based on specific trip types (e.g. work-based trips) and the corresponding population which generates said VMT (e.g. employees).

VMT was generated with data from OCTAM 5.0 using the full-accounting, origin-destination (OD) methodology. The full-accounting, origin-destination methodology considers the VMT generated by all internal-internal (I-I), internal-external (I-X), and external-internal (X-I) trips. These trip types refer to trips that include an origin and/or destination within the study areas (City of Santa Ana and Orange County). For example, an internal-internal trip refers to a trip which begins in the City and also ends in the City; an internal-external trip refers to a trip which begins in the City but ends outside of the City; an external-internal trip refers to a trip which begins outside of the City but ends in the City. It should be noted that while the majority of trips are captured in their entirety, a small portion are cut off at the OCTAM 5.0 boundaries. Thus, while the number of trips to and from the City of Santa Ana which cross the model boundary are known at various locations along major access points (highways, freeways, etc.) the trip length past the OCTAM 5.0 boundary is not.

In order to account for the VMT generated by the portions of trips outside the model boundaries, trip length assumptions were developed. These assumptions are based on the destinations/attractions near the model boundary as well as likely attractions/destinations beyond the immediate developments near the boundary limits. For example, northbound and southbound trips along I-5 at the San Diego County Line were assigned a trip length of 20 miles past the model's southern boundary (the San Diego County Line). This assumption is intended to provide a general account for VMT which considers trips to various locations such as Camp Pendleton, the US-Mexico Border, and various cities within San Diego County. Trip lengths of zero (0) miles are assigned to those trips which are not considered to extend further than 5 miles past the OCTAM boundary; due to the approximate boundary of the model, it would not be appropriate to pursue such a level of accuracy. A summary of the trip length assumptions to/from major OCTAM 5.0 boundary access points is provided below:

- SR-101 near Ventura (20 miles)
- SR-150 near Ojai (0 miles)
- SR-33 near Ventura (0 miles)
- I-5 near Santa Clarita (50 miles)
- SR-14 near Santa Clarita (20 miles)
- I-15 north of I-215 (50 miles)
- I-10 near Banning (30 miles)
- SR-243 south of Banning (10 miles)
- SR-74 east of Hemet (20 miles)
- SR-79 near Temecula (20 miles)
- I-15 near Temecula (0 miles)
- I-5 at San Diego County Line (20 miles)

Due to the nature and scale of the proposed project, the analysis considers the total VMT and service population which consists of the aggregate of total employees and population within the study area. When aggregating employees and residents, an employee reduction factor was applied to account for overlaps in the two (employees who are also residents). Reduction factors were applied to both the City of Santa Ana and County of Orange employees then aggregated to the resident population. Reduction factors are based on employment data within the Southern California Association of Governments (SCAG) Local Profiles Reports (2019) for the City of Santa Ana and Orange County. The SCAG reports show that 20.8% of employees within the City are also residents of the City and that 65.3% of employees within the County are also residents of the County.

VMT and VMT/SP is provided for all scenarios. Existing year (2020) VMT, SP, and VMT/SP values were developed through linear interpolation of 2016 and 2045 baseline OCTAM scenarios. This method was chosen due to the availability of consistent VMT and socio-economic data (SED) used to derive VMT/SP. Although existing year (2020) SED is available, it does not have an accompanying VMT dataset since there is no baseline OCTAM roadway/highway network for existing year (2020) conditions. Therefore, the traffic study uses both interpolated VMT and SED based on OCTAM 2016 baseline and the 2045 forecasts to develop the existing year (2020) values.

Per the City of Santa Ana Traffic Impact Study Guidelines (2019), the project should be screened to determine the need for a full VMT analysis based on the following screening criteria. Firstly, two conditions should be considered:

- Does the project have the potential to reduce VMT/SP?
- Is the project consistent with the Regional Transportation Plan (RTP) / Sustainable Communities Strategy's (SCS)?

If both conditions are met, then a project may be precluded from a full VMT analysis if any of the following criteria are met:

- Projects which serve the local community and have the potential to reduce VMT, such as neighborhood K-12 schools and local-serving retail less than 50,000 square feet (Charter schools are excluded from this criteria).
- Projects that generate less than 110 net daily trips.
- Projects located within Transit Priority Areas (TPAs)
- Projects located in a low-VMT generating Traffic Analysis Zone (TAZ).
 - Proposed land use shall be consistent with the existing land use generating the low VMT/SP.
 - Proposed land use shall be consistent with the RTP/SCS assumptions or decreases VMT/SP compared to RTP/SCS.

The criteria above are presented in a compact manner. Detailed criteria descriptions and supporting material are provided in the City of Santa Ana Traffic Impact Study Guidelines (2019).

VMT impacts are assessed for the Future Year (2045) With Project scenario, based on changes from both the Existing Year (2020) and Future Year (2045) No Project scenarios. VMT impact thresholds for land use plans (such as General Plans and Specific Plans) are listed below:

- Project Level Impact
 - A project is considered to have a significant impact if the project VMT/SP (for the land use plan) exceeds 15% below the existing total daily VMT/SP for the County; or
- Cumulative Impact
 - A project is considered to have a significant impact if the project results in a negative effect on VMT/SP at the citywide level (City VMT/SP is higher with the project than without it).

Where an impact is identified, the project's VMT/SP should be mitigated to be at or less than 15% below the existing Countywide VMT/SP. Mitigation measures may include changes to the project, implementation of transportation demand management (TDM) measures, impact fees, a mitigation exchange, or any other measure approved by the City's Traffic Engineering Division and Planning Department.

3.2 ROADWAY LEVEL OF SERVICE ANALYSIS

Roadway performance was assessed based on the volume-to-capacity (V/C) ratio, as specified in the Santa Ana Circulation Element (1998). The V/C ratio is calculated by dividing the roadway volume by the capacity of the roadway. Roadway capacities are presented in Table 3-1 and resemble those presented in the Santa Ana Circulation Element. The Santa Ana Circulation Element, however, does not provide roadway capacities for the Divided Collector and five-lane divided arterial roadway types. Capacities for the Divided Collector roadway were taken from the Orange County Master Plan of Arterial and Highways (OC MPAH); capacities for the five-lane divided arterial roadway were developed by averaging the capacities of the Major and Primary Arterial roadway types. The capacities shown

correspond to the maximum volume that can be experienced in order to achieve the corresponding level of service (LOS). Therefore, a volume greater than that listed in the column labeled “LOS E” will result in LOS F. The minimum level of service for roadways in the City of Santa Ana is LOS D, per the Circulation Element (1998). The OC MPAH suggests a minimum LOS of C be maintained for roadways, with the intent of maintaining LOS D through intersections. Descriptions of operation and the range of volume-to-capacity ratios for each LOS grade are presented in Table 3-2.

Table 3-1 Roadway Capacity and LOS

CLASSIFICATION	LANES	LOS A	LOS B	LOS C	LOS D	LOS E
Principal Arterial	8D	45,000	52,500	60,000	67,500	75,000
Major Arterial	6D	33,900	39,400	45,000	50,600	56,300
Major / Primary Arterial	5D	28,200	32,850	37,500	42,200	46,900
Primary Arterial	4D	22,500	26,300	30,000	33,800	37,500
Secondary Arterial	4U	15,000	17,500	20,000	22,500	25,000
Divided Collector	2D	9,000	12,000	15,000	20,000	22,000
Collector	2U	7,500	8,800	10,000	11,300	12,500

Sources: City of Santa Ana, General Plan – Circulation Element (1998); Orange County Master Plan of Arterials and Highways (2017).

3.3 INTERSECTION LEVEL OF SERVICE ANALYSIS

Study intersections were assessed using the methodology described in the governing agency’s traffic impact analysis guidelines. As such, intersections were assessed using the Intersection Capacity Utilization (ICU) methodology or the Highway Capacity Manual 2000 method (HCM 2000). A description of each as well as the level of service criteria is provided in the following sections.

3.3.1 ICU Methodology

Signalized intersections under the jurisdiction of the Cities of Santa Ana, Costa Mesa, Orange, Irvine, Tustin, and Fountain Valley were assessed using the ICU methodology. The ICU methodology is based on intersection V/C ratio. The V/C ratio value for each movement is the observed volume divided by the saturation flow volume. The intersection ICU value is the sum of the V/C values for the critical movement on each leg, where critical movements are the pairs of conflicting movements with the highest combined V/C values. ICU is expressed as a decimal value (e.g. 0.74), where 1.00 represents the saturated condition where the volume of traffic flow is equal to the capacity. LOS descriptions and their corresponding ranges of V/C ratios are provided in Table 3-2.

This study uses maximum saturation volumes of 1,600 vehicles per hour per lane (VPHPL) for turn lanes and 1,700 VPHPL for through lanes. A 5% loss time per cycle length was applied.

Table 3-2 ADT / ICU Level of Service Descriptions

LOS	V/C	Definition
A	0.00 – 0.60	Free Flow. Individual users are virtually unaffected by the presence of others in the traffic stream. Freedom to select desired speeds and to maneuver within the traffic stream is extremely high. The general level of comfort and convenience provided to the motorist, passenger, or pedestrian is excellent.
B	0.61 – 0.70	Stable flow. The presence of other users in the traffic stream begins to be noticeable. Freedom to select desired speeds is relatively unaffected, but there is a slight decline in the freedom to maneuver within the traffic stream with LOS A. The general level of comfort and convenience provided is somewhat less than that of LOS A, because the presence of others in the traffic stream begins to affect individual behavior.
C	0.71 – 0.80	Stable flow. This LOS marks the beginning of the range of flow in which the operation of individual users becomes significantly affected by interactions with others in the traffic stream. The selection of speed is affected by the presence of others, and maneuvering within the traffic stream requires substantial vigilance on the part of the user. The general level of comfort and convenience declines noticeably at this level.
D	0.81 – 0.90	High density, but stable flow. Speed and freedom to maneuver are severely restricted, and the driver or pedestrian experiences a generally poor level of comfort and convenience. Small increases in traffic flow will generally cause operational problems at this level.
E	0.91 – 1.00	Operating conditions at or near the capacity level. All speeds are reduced to a slow but relatively uniform value. Freedom to maneuver within the traffic stream is extremely difficult, and generally accomplished by forcing a vehicle or pedestrian to “give way” to accommodate such maneuvers. Comfort and convenience levels are extremely poor, and drivers or pedestrian frustration is generally high. Operations at this level are usually unstable because small increases in flow or minor variations within the stream will cause a breakdown.
F	> 1.00	Forced or breakdown flow. This condition exists wherever the amount of traffic approaching a point exceeds the amount which can traverse that point. Queues form up behind such locations as arrival flow exceeds discharge flow.

Source: City of Santa Ana, General Plan – Circulation Element, 1998

3.3.2 Highway Capacity Manual (HCM) Methodology

Study intersections that are Caltrans operated intersections were evaluated using the Highway Capacity Manual 2000 (HCM 2000) Operations methodology consistent with Caltrans guidelines. Chapter 16 of the Highway Capacity Manual (HCM) 2000 contains the operations methodology for signalized intersections, which evaluates LOS based on controlled delay per vehicle. Controlled delay is defined as the portion of the total delay attributed to the traffic signal operation including deceleration delay, queue move-up time, stopped delay, and final acceleration delay. Consistent with HCM 2000 methodology the maximum saturation flow rate for intersections analyzed using HCM 2000 is 1,900 VPHPL. The relationship between controlled delay per vehicle and LOS for signalized intersections is summarized in Table 3-3.

Table 3-3 HCM 2000 Level of Service Descriptions

LOS	Description of Traffic Conditions	Delay (sec/veh)
A	Insignificant delays: no approach phase is fully utilized and no vehicle waits longer than one red indication.	≤ 10
B	Minimal delays: an occasional approach phase is fully utilized. Drivers begin to feel restricted.	> 10 – 20
C	Acceptable delays: major approach phase may become fully utilized. Most drivers feel somewhat restricted.	> 20 – 35
D	Tolerable delays: drivers may wait through more than one red indication. Queues may develop but dissipate rapidly, without excessive delays.	> 35 – 55
E	Significant delays: volumes approaching capacity. Vehicles may wait through several cycles and long vehicle queues form upstream.	> 55 – 80
F	Excessive delays: represents conditions at capacity, with extremely long delays. Queues may block upstream intersections.	> 80

Source: Highway Capacity Manual, Transportation Research Board, 2000.

Unsignalized intersections were evaluated using the methodology described in Chapter 17 of the HCM. The criteria for unsignalized intersections have different threshold values than do those for signalized intersections because drivers expect signalized intersections to carry higher traffic volumes, so higher levels of control delay are acceptable. The relationship between controlled delay per vehicle and LOS for unsignalized intersections is summarized in Table 3-4.

Table 3-4 Level of Service for Unsignalized Intersections

LOS	Control Delay (sec/veh)
A	≤ 10
B	> 10 – 15
C	> 15 – 25
D	> 25 – 35
E	> 35 – 50
F	> 50

Source: Highway Capacity Manual, Transportation Research Board, 2000. Exhibit 17-22

The intersection Level of Service analysis for this report was performed using TRAFFIX software. TRAFFIX is a network-based interactive computer program that enables calculation of levels of service at signalized and unsignalized intersections for multiple locations and scenarios. TRAFFIX also calculates signal timing (green times and cycle lengths) and maximum queue lengths to assist in evaluating signalized intersections.

3.4 INTERSECTION LOS AND SIGNIFICANT IMPACT CRITERIA

3.4.1 Cities of Santa Ana, Costa Mesa, Fountain Valley, and Orange

The minimum LOS for intersections in the Cities of Santa Ana, Costa Mesa, and Fountain Valley is LOS D. Impacts are considered significant if:

- An intersection degrades from an acceptable LOS (LOS D or better) to an unacceptable LOS (LOS E or F) during the peak hours; or
- The project increases traffic demand at the study intersection by 1% of capacity (0.01) if the intersection already operates at an unacceptable level (LOS E or F).

3.4.2 City of Tustin

The minimum LOS for intersections in the City of Tustin is LOS D. Significant impacts are not explicitly outlined, but the preservation of the minimum LOS with and without the project is required. Therefore, a significant impact can be assumed to occur if:

- An intersection is expected to operate at an unacceptable LOS (LOS E or F) in the With Project scenario; an effort to return the intersection LOS to an acceptable level is to be made.

3.4.3 City of Irvine

The minimum LOS for intersections in the City of Irvine is LOS D. Impacts are considered significant if:

- An intersection degrades from an acceptable LOS (LOS D or better) to an unacceptable LOS (LOS E or F) during the peak hours; or
- An intersection is operating at an unacceptable LOS (LOS E or F) and experiences an increase in V/C of 0.02 or more.

3.4.4 Orange County Congestion Management Program

The minimum LOS for intersections part of the Orange County Congestion Management Program (OC CMP) establishes LOS E as the minimum level of operation for CMP roadways (freeways and Smart Streets). Impacts are considered significant if:

- An intersection degrades from an acceptable LOS (LOS E or better) to an unacceptable LOS (LOS F) during the peak hours; or
- The project increases traffic demand at the study intersection by 10% of capacity (0.10) if the intersection already operates at an unacceptable level (LOS F)

OC CMP intersections included in this analysis are:

- INT 6 – Harbor Boulevard and SR-22 WB Off-Ramp / Banner Drive
- INT 9 – Harbor Boulevard and 1st Street
- INT 12 – Harbor Boulevard and Warner Avenue
- INT 17 – Harbor Boulevard and I-405 NB Off-Ramp
- INT 18 – Harbor Boulevard and I-405 SB Off-Ramp
- INT 87 – Mabury Street and 1st Street
- INT 95 – SR-55 SB Ramps / Auto Mall Drive and Edinger Avenue

3.4.5 Caltrans

The minimum LOS for Caltrans intersections is LOS C. Impacts are considered significant if:

- An intersection degrades from an acceptable LOS (LOS C or better) to an unacceptable LOS (LOS D or worse) during the peak hours; or
- Any increase in delay is expected at an intersection already operating at an unacceptable LOS.

3.5 TRAFFIC VOLUMES

This study assesses both roadway and intersection performance for all existing and future year scenarios. Roadway and intersection counts were utilized to determine existing year (2020) average daily traffic (ADT) on study roadway segments and peak hour turning movement counts at study intersections. To determine future year (2045) volumes, an annual growth rate applied to existing traffic volumes was developed through the Orange County Transportation Analysis Model (OCTAM). The traffic volume development procedure is further detailed in the following sections.

3.5.1 Traffic Count Data

Roadway ADT was taken from the City of Santa Ana count database, with counts conducted in September and October 2019. A compound annual growth rate of 1% was applied to the ADT volumes to bring them to levels consistent with those expected in the year 2020.

Intersection turning movement volumes are provided by recent count data and supplemented with historical count data. Updated traffic counts for the year 2020 were in the process of being scheduled and conducted when widespread closures of schools, businesses, and other facilities were ordered due to the onset of the COVID-19 pandemic, disrupting normal traffic patterns. As a result, updated counts were only partially conducted and were supplemented with historic count data. Where they were able to be conducted, updated counts were conducted during the morning peak period (6:00 AM to 9:00 AM) and the afternoon peak period (4:00 PM to 7:00 PM). The AM and PM peak hour analyses are based on the hour of highest total intersection volume during the morning and afternoon peak periods. A compound annual growth rate (CAGR) of 1% was applied to the volumes for traffic counts conducted prior to 2020 to bring them to levels consistent with those expected in the year 2020. The CAGR 1% was selected based on comparisons of historical ADT data for various locations throughout the City. An inventory of intersection count data is provided in Table 3-5.

3.5.2 Travel Demand Forecasting

The horizon year 2045 volumes were derived based on existing peak hour count data and forecast link volumes obtained from the Orange County Transportation Analysis Model (OCTAM) version 5.0. OCTAM 5.0 is the accepted sub-regional model for forecasting travel demand in Orange County, and is based on socioeconomic data from Orange County Projections 2018. Growth factors for each intersection approach and departure were interpolated from OCTAM forecast for the 2016 and 2045 baseline scenarios. These growth factors were then applied to existing counts to forecast future turning movement volumes. OCTAM 5.0 was recently updated by OCTA and this traffic analysis update utilizes this new TransCad version of the model.

Table 3-5 Intersection Count Inventory

ID	INTERSECTION	COUNT YEAR
1	Euclid Street and Bolsa Avenue	2019
2	Euclid Street and McFadden Avenue	2016
3	Euclid Street and Edinger Avenue	2019
4	Newhope Street and Hazard Avenue	2016
5	Newhope Street and McFadden Avenue	2016
6	Harbor Boulevard and SR-22 WB Off-Ramp / Banner Drive	2016
7	Trask Avenue and SR-22 EB On-Ramp	2013
8	Harbor Boulevard and Westminster Avenue	2019
9	Harbor Boulevard and 1st Street	2019
10	Harbor Boulevard and McFadden Avenue	2016
11	Harbor Boulevard and Edinger Avenue	2019
12	Harbor Boulevard and Warner Avenue	2019
13	Harbor Boulevard and Segerstrom Avenue	2016
14	Hyland Avenue / OCTA Bus Base and MacArthur Boulevard	2016
15	Harbor Boulevard and MacArthur Boulevard	2019
16	Harbor Boulevard and Sunflower Avenue	2016
17	Harbor Boulevard and I-405 NB Off-Ramp	2019
18	Harbor Boulevard and I-405 SB Off-Ramp	2019
19	Fairview Street and Civic Center Drive	2016
20	Fairview Street and 1st Street	2018
21	Fairview Street and McFadden Avenue	2016
22	Fairview Street and Edinger Avenue	2019
23	Fairview Street and Warner Avenue	2016
24	Fairview Street and MacArthur Boulevard	2019
25	Fairview Road and Sunflower Avenue	2016
26	Greenville Street and Edinger Avenue	2017
27	Greenville Street and Segerstrom Avenue	2017
28	Raitt Street and McFadden Avenue	2016
29	Raitt Street and Edinger Avenue	2016
30	Bear Street and MacArthur Boulevard	2017
31	Bristol Street and 17th Street	2019
32	Bristol Street and Civic Center Drive	2016

ID	INTERSECTION	COUNT YEAR
33	Bristol Street and Santa Ana Boulevard	2016
34	Bristol Street and 1st Street	2019
35	Bristol Street and McFadden Avenue	2017
36	Bristol Street and Warner Avenue	2019
37	Bristol Street and Segerstrom Avenue	2016
38	Bristol Street and Alton Avenue	2017
39	Bristol Street and MacArthur Boulevard	2017
40	Bristol Street and Sunflower Avenue	2016
41	Bristol Street and I-405 NB Ramps	2018
42	Bristol Street and I-405 SB Ramps	2018
43	Flower Street and Santa Ana Boulevard	2016
44	Flower Street and 1st Street	2017
45	Flower Street and McFadden Avenue	2016
46	Flower Street and Segerstrom Avenue	2016
47	Flower Street and MacArthur Boulevard	2016
48	Main Street and La Veta Avenue	2018
49	Main Street and Mainplace Drive / Memory Lane	2019
50	Main Street and 17th Street	2019
51	Main Street and Civic Center Drive	2016
52	Main Street and Santa Ana Boulevard	2016
53	Main Street and 4th Street	2016
54	Main Street and 1st Street	2019
55	Main Street and McFadden Avenue	2016
56	Main Street and Edinger Avenue	2019
57	Main Street and MacArthur Boulevard	2019
58	Penn Way and 17th Street	2017
59	Santiago Street / I-5 NB Ramps and 17th Street	2016
60	Penn Way and I-5 SB Ramps	2017
61	Santiago Street and Civic Center Drive	2017
62	Santiago Street and Santa Ana Boulevard	2016
63	Standard Avenue and 4th Street	-
64	Standard Avenue and 1st Street	2017
65	Standard Avenue and McFadden Avenue	2018

ID	INTERSECTION	COUNT YEAR
66	Halladay Street and Warner Avenue	2016
67	Halladay Street and Dyer Road	2019
68	SR-55 SB Ramps and MacArthur Boulevard	2019
69	SR-55 NB Ramps and MacArthur Boulevard	2019
70	SR-55 SB Ramps and Dyer Road	2019
71	Glassell Street and La Veta Avenue	2016
72	Glassell Street and SR-22 WB Ramps	2016
73	Glassell Street / Grand Avenue and SR-22 EB Ramps	2016
74	Grand Avenue and Fairhaven Avenue	2016
75	Grand Avenue and Santa Clara Avenue	2017
76	Grand Avenue and 17th Street	2019
77	Grand Avenue and I-5 NB Ramps	2017
78	Grand Avenue and Santa Ana Boulevard	2017
79	Grand Avenue and 1st Street	2019
80	Grand Avenue and Chestnut Avenue	2016
81	Grand Avenue and McFadden Avenue	2016
82	Grand Avenue and Edinger Avenue	2019
83	Grand Avenue and Warner Avenue	2019
84	SR-55 NB Ramps and Dyer Road	2019
85	Cambridge Street and La Veta Avenue	2016
86	Cambridge Street and Fairhaven Avenue	2020
87	Mabury Street and 1st Street	2020
88	Tustin Street and La Veta Avenue	2020
89	Tustin Street and SR-22 WB On-Ramp	2020
90	Tustin Street and SR-22 EB Off-Ramp / Seba Avenue	2020
91	Tustin Street and Fairhaven Avenue	2020
92	Tustin Avenue and Santa Clara Avenue	2020
93	Tustin Avenue and 17th Street	2020
94	Tustin Avenue and 4th Street	2020
95	SR-55 SB Ramps / Auto Mall Drive and Edinger Avenue	2020
96	SR-55 NB Ramps / Del Amo Avenue and Newport Avenue	2020
97	Red Hill Avenue and Edinger Avenue	2020
98	Red Hill Avenue and Warner Avenue	2020

ID	INTERSECTION	COUNT YEAR
99	Red Hill Avenue and Barranca Parkway	2020
100	Red Hill Avenue and Alton Parkway	2020
101	Red Hill Avenue and MacArthur Boulevard	2020
102	Red Hill Avenue and Main Street	2020
103	I-5 SB Ramps and Santa Ana Boulevard	2017
104	Tustin Ranch Road and Warner Avenue	2020
105	Von Karman Avenue and Barranca Parkway	2020

4.0 Existing Year (2020) Conditions

The project study area includes arterial roadways and signalized intersections in the vicinity of the project corridor. Descriptions of geometrical features and intersection level of service analysis results for the year 2020 are included in this section.

4.1 EXISTING ROADWAY NETWORK

Selected arterials that are located in the vicinity of the project corridor are described in this section. Items of note include existing geometry, pedestrian and bicycle facilities, and adjacent land uses.

Euclid Street is classified as a Major Arterial that travels north and south through the study area. Within the study area, there are three travel lanes in each direction with a striped center median functioning as a two-way left-turn lane. Euclid Street is five lanes (2 northbound and 3 southbound) south of Davit Avenue. The posted speed limit is 45 miles per hour. On-street parking is not permitted and no bike facilities are provided. OCTA provides service along this corridor via Route 37 at approximately 30 minute headways.

Newhope Street is classified as a Secondary Arterial that travels north and south on the west end of Santa Ana. Within the study area, there are two travel lanes in each direction with a striped center median functioning as a two-way left-turn lane. The posted speed limit is 40 miles per hour. On-street parking is generally not permitted north of McFadden Avenue, except between 1st Street and 5th Street. Class II bike lanes were recently implemented between Westminster Avenue and McFadden Avenue. There are currently no bus routes that serve this corridor.

Hazard Avenue is classified as a Secondary Arterial that travels east and west through the study area. Within the study area, there are two travel lanes in each direction with a striped center median functioning as a two-way left-turn lane. Hazard Avenue transitions to a Divided Collector west of Harbor Boulevard, and Undivided Collector east of Harbor Boulevard. Limited on-street parking is permitted adjacent to Rosita Park. The posted speed limit is 35 miles per hour and 25 miles per hour near the school zone. No bus routes or bike facilities are provided along this corridor.

McFadden Avenue is classified as a Secondary Arterial (between Euclid Street and Grand Avenue) and a Primary Arterial (east of Grand Avenue) that travels east and west through the study area. Within the study area, there are two travel lanes in each direction with a striped center median functioning as a two-way left-turn lane and a raised, landscaped median on occasion. McFadden Avenue narrows to a two-lane undivided roadway between Bristol Street and Standard Avenue. The posted speed limit is 30-45 miles per hour. On-street parking is permitted along parts of the corridor. Bike lanes are provided west of Harbor Boulevard. OCTA provides service along this corridor via Route 66 and Route 145 at approximately 15-45 minute headways.

Harbor Boulevard is classified as a Major Arterial that travels north and south through the study area. Within the study area, there are three travel lanes in each direction with a raised, landscaped median. The posted speed limit is 40-45 miles per hour. On-street parking is not permitted and limited bike facilities are provided. OCTA provides service along this corridor via Route 43 and Route 543 at approximately 15-20 minute headways.

Fairview Avenue is classified as a Major Arterial that travels north and south through the study area. Within the study area, there are three lanes in each direction with a raised, landscaped median. Fairview Avenue transitions to a five-lane divided roadway then a Primary Arterial north of Civic Center Drive. The posted speed limit is 45 miles per hour. On-street parking is not permitted and bike facilities are not provided. OCTA provides service along this corridor via Route 47 at approximately 15 minute headways.

Civic Center Drive is classified as a Secondary Arterial that travels east and west through the study area. Within the study area, Civic Center Drive is a four-lane undivided roadway; Civic Center Drive becomes a four-lane divided with bike facilities east of Bristol Street until Broadway. It is a four-lane

divided road until Minter Street and then becomes a two-lane undivided. The posted speed limit is 35 miles per hour, unless otherwise noted to be 25 miles per hour in a school zone. On-street parking is allowed along some sections of Civic Center Drive. On-street parking is permitted along certain segments. There are some bike lanes or bike routes provided along this roadway. OCTA provides service along this corridor via Routes 83, 145, and 862 with headways of approximately 30 minutes for each route.

MacArthur Boulevard is classified as a Major Arterial that travels east and west through the study area. Within the study area, there are three travel lanes in each direction with a raised, landscaped median. MacArthur Boulevard is classified as a Primary Arterial west of Hyland Avenue. The posted speed limit is 40 miles per hour. On-street parking is not permitted throughout the corridor and there are currently no bike facilities provided. OCTA operates four bus routes along this corridor via Routes 53, 55, 76 and 173. Headways range between every 10 minutes for Route 53, 30 minutes for Route 55, 60 minutes for Route 76, and 45 minutes for Route 173.

Raitt Street is classified as a Secondary Arterial that travels north and south through the study area. Between MacArthur Boulevard and Edinger Avenue, Raitt Street is a four-lane divided roadway. Between Edinger Avenue and Myrtle Street, Raitt Street is a four-lane undivided roadway. Then from Myrtle Street to 1st Street it is a two-lane divided roadway. Between First Street and Washington Avenue, Raitt Street narrows down to a two-lane undivided roadway. The speed limit is limited to 25 miles per hour in school zones and 35-40 miles per hour outside of the school zone. On-street parking is permitted along the west side of the street between McFadden Avenue and Edinger Avenue and on both sides of the street north of McFadden Avenue to Richland Avenue. Currently bike facilities are not provided along this roadway. OCTA operates Route 145 approximately every 45 minutes during peak operation.

1st Street is classified as a Major Arterial that travels east and west through the study area. Within the study area, there are three lanes in each direction with a raised, landscaped median. The posted speed limit is 40 miles per hour. On-street parking is not permitted along this corridor. There are currently no bike lanes or bike routes provided. OCTA provides service along this corridor via Route 64 at approximately 15 minute headways.

Bristol Street is classified as a Major Arterial that travels north and south through the study area. Within the study area, there are three travel lanes in each direction with a raised, landscaped median. The posted speed limit is 40 miles per hour. Bikeways exist between 17th Street and Edinger Avenue. On-street parking is not permitted along this corridor. OCTA provides service along this corridor via Route 57 at approximately 30 minute headways.

17th Street/ Westminster Avenue is classified as a Major Arterial traveling east and west through the northern region in Santa Ana. There are three lanes in each direction divided by a center median. The posted speed limit is 40 miles per hour. On-street parking is not permitted and there are currently no bike facilities provided along the corridor. Several OCTA bus routes serve this corridor, including Routes 51 and 60 with approximately 15-20 minute headways.

Santa Ana Boulevard is classified as a Major Arterial (between Raitt Street and Ross Street) and a Primary Arterial (between Ross Street and Grand Avenue). The roadway fluctuates between a four-lane undivided roadway (Raitt Street to Flower Street), six-lane divided roadway (Flower Street to Ross Street and Santiago Street to Grand Avenue), and a three-lane one-way roadway (Ross Street to French Street). On-street parking is permitted along certain segments of the corridor. There are currently no bike lanes or bike routes provided. The posted speed limit is 35 miles per hour. Several OCTA bus routes serve this corridor, including Routes 83, 145, and 206 with approximately 30-45 minute headways.

Seegerstrom Avenue is classified as a Major Arterial that travels east and west through the study area. Seegerstrom Avenue is a six-lane divided roadway between Susan Street and Harbor Boulevard and a four-lane divided roadway along the rest of the corridor. The posted speed limit is 40 miles per hour.

On-street parking is not permitted and there are currently no bike facilities provided along this corridor. There are currently no transit services that operate along Segerstrom Avenue within the study area.

Memory Lane is classified as a Major Arterial that travels east and west through the study area. There are three travel lanes in each direction with a raised, landscaped median. The posted speed limit is 40 miles per hour. On-street parking is not permitted along this roadway. Class II bike lanes are provided between Bristol Street and Flower Street. OCTA provides service along this corridor via Route 453 at approximately 30 minute headways.

Tustin Avenue is classified as a Major Arterial that travels north and south parallel to the SR-55 Freeway. There are three travel lanes in each direction with a striped center median. The posted speed limit is 40 miles per hour. On-street parking is not permitted and bike lanes are not available along Tustin Avenue. Two OCTA bus routes operate along Tustin Avenue. Routes 60 and 71 operate at frequencies of 45 minutes and 1 hour respectively.

Warner Avenue is classified as a Major Arterial that travels east and west through the study area. Within the study area, Warner Avenue is a four-lane undivided roadway. The posted speed limit is 40-45 miles per hour. On-street parking is not permitted and there are currently limited bike lanes provided along the corridor. There are two OCTA bus routes that serve Warner Avenue in the study area. Routes 72 and 463 operate with headways at approximately 20-60 minutes.

Edinger Avenue is classified as a Major Arterial that travels east and west through the study area. The roadway is a four-lane divided roadway between Euclid Street and Main Street and six-lane divided roadway between Main Street and SR-55 freeway. The posted speed limit is 40 miles per hour. On-street parking is not permitted throughout most of the corridor, with the exception of the eastbound direction between Main Street and Maple Street; and between Cedar Street and Evergreen Street. There are bike facilities provided along parts of the corridor. OCTA provides service along Edinger Avenue via Route 70 at approximately 30 minute headways.

Flower Street is classified as a Collector Street (north of 17th Street), Secondary Arterial (between 17th Street and Warner Avenue), and Primary Arterial (south of Warner Avenue) that travels north and south through the study area. The roadway fluctuates between a two-lane divided roadway (Warner Avenue to First Street and 17th Street to Memory Lane) and a four-lane divided roadway (Sunflower Avenue to Warner Avenue and First Street to 17th Street). On-street parking is permitted along residential areas. There are currently no bike facilities provided along the corridor. OCTA provides service along this corridor via Route 51 at approximately 30 minute headways.

Main Street is classified as a Major Arterial (north of Washington Avenue and south of Warner Avenue), Secondary Arterial (between Washington Avenue to Edinger Avenue), and a Primary Arterial (between Edinger Avenue and Warner Avenue) that travels north and south through the study area. There are two travel lanes in each direction, with a striped center median operating as a two-way left-turn lane. The posted speed limit is 35-40 miles per hour. Parking is permitted on the east side of the street between Goetz Avenue and Dyer Road, and prohibited on Main Street through the rest of the study area. South of Dyer Road, Main Street widens to a six-lane facility with a center two-way left-turn lane. OCTA provides service along this corridor via Route 53 at approximately 20 minute headways.

Grand Avenue is classified as a Major Arterial that travels north and south through the study area. From the SR-55 freeway to the northern study area boundary, Grand Avenue is a six-lane major arterial with a center two-way left-turn lane. Approximately 900 feet north of Warner Avenue, Grand Avenue narrows to two lanes in the southbound direction, and the third southbound lane is restored about 300 feet north of Warner Avenue. South of the SR-55 freeway, Grand Avenue has two northbound and three southbound lanes divided by a landscaped median. Parking is not permitted and there are currently no bike lanes or bike routes along Grand Avenue. The posted speed limit is 45 miles per hour. OCTA provides service along this corridor via Route 59 at approximately 30 minute headways.

4.2 STUDY INTERSECTION GEOMETRY AND PEAK HOUR VOLUMES

Intersections were selected in consultation with the City of Santa Ana based on expected traffic impacts and vehicle volumes. The existing study intersection lane geometries are provided in the Appendix. Year 2020 AM peak hour turning movement volumes are shown in Table 4-1, and the PM peak hour volumes are shown in Table 4-2.

Table 4-1 Existing Year 2020 Volumes – AM Peak Hour

ID	Intersection	Northbound			Southbound			Eastbound			Westbound		
		L	T	R	L	T	R	L	T	R	L	T	R
1	Euclid Street and Bolsa Avenue	124	1044	179	207	1844	104	218	811	153	184	586	188
2	Euclid Street and McFadden Avenue	145	1100	131	137	1906	158	227	463	287	166	368	140
3	Euclid Street and Edinger Avenue	134	845	72	127	1842	169	172	753	460	100	609	111
4	Newhope Street and Hazard Avenue	98	738	105	91	1341	123	78	199	147	51	170	68
5	Newhope Street and McFadden Avenue	110	491	173	119	1183	110	135	492	160	176	449	100
6	Harbor Boulevard and SR-22 WB Off-Ramp / Banner Drive	70	1274	0	0	1354	18	74	0	121	836	44	117
7	Trask Avenue and SR-22 EB On-Ramp	0	0	0	0	0	0	651	815	0	0	738	138
8	Harbor Boulevard and Westminster Avenue	178	1173	251	212	1663	95	176	927	33	212	574	156
9	Harbor Boulevard and 1st Street	117	935	202	227	1914	124	140	932	181	245	621	145
10	Harbor Boulevard and McFadden Avenue	104	1059	101	182	1919	64	167	435	130	190	430	123
11	Harbor Boulevard and Edinger Avenue	103	772	146	183	2105	61	107	644	323	221	491	204
12	Harbor Boulevard and Warner Avenue	115	701	178	457	2059	123	97	1385	364	151	792	134
13	Harbor Boulevard and Segerstrom Avenue	111	791	50	171	2299	86	88	737	297	117	362	82
14	Hyland Avenue / OCTA Bus Base and MacArthur Boulevard	69	3	19	8	2	19	7	1953	775	64	490	20
15	Harbor Boulevard and MacArthur Boulevard	128	898	92	316	1820	126	126	1141	344	133	443	132
16	Harbor Boulevard and Sunflower Avenue	217	1107	205	246	2324	57	9	109	42	130	166	94
17	Harbor Boulevard and I-405 NB Off-Ramp	0	1567	0	0	2327	0	0	0	0	508	0	894
18	Harbor Boulevard and I-405 SB Off-Ramp	0	1729	0	0	1504	0	385	0	429	0	0	0
19	Fairview Street and Civic Center Drive	6	1278	414	243	1402	6	6	23	23	300	9	155
20	Fairview Street and 1st Street	157	1206	227	241	1401	161	214	1233	191	163	732	245
21	Fairview Street and McFadden Avenue	121	1294	173	142	1727	125	221	522	120	194	500	40
22	Fairview Street and	188	831	116	215	1503	127	237	657	176	421	553	110

Santa Ana General Plan Update Traffic Impact Study – Final Draft

ID	Intersection	Northbound			Southbound			Eastbound			Westbound		
		L	T	R	L	T	R	L	T	R	L	T	R
	Edinger Avenue												
23	Fairview Street and Warner Avenue	215	952	125	205	1628	119	69	1010	301	307	926	300
24	Fairview Street and MacArthur Boulevard	248	771	89	307	1546	173	125	1019	150	235	494	140
25	Fairview Road and Sunflower Avenue	185	1071	163	204	1738	111	49	322	65	306	256	132
26	Greenville Street and Edinger Avenue	186	0	251	0	0	0	0	960	234	172	915	0
27	Greenville Street and Segerstrom Avenue	47	193	78	154	472	160	33	739	118	164	662	76
28	Raitt Street and McFadden Avenue	62	570	90	100	762	104	116	704	90	172	542	97
29	Raitt Street and Edinger Avenue	188	501	181	152	716	85	165	1008	145	117	916	54
30	Bear Street and MacArthur Boulevard	81	280	119	199	756	300	97	1663	114	70	1180	100
31	Bristol Street and 17th Street	192	988	167	335	1376	181	324	963	156	359	824	273
32	Bristol Street and Civic Center Drive	123	1087	96	318	1284	80	149	755	93	121	401	83
33	Bristol Street and Santa Ana Boulevard	65	1419	197	137	1507	41	83	403	35	96	240	41
34	Bristol Street and 1st Street	183	1278	162	275	1133	160	206	1268	128	108	813	119
35	Bristol Street and McFadden Avenue	118	1054	53	161	1571	162	275	472	232	155	432	50
36	Bristol Street and Warner Avenue	192	862	159	386	1307	148	206	1149	286	188	860	146
37	Bristol Street and Segerstrom Avenue	65	725	136	283	1011	119	189	913	84	122	554	71
38	Bristol Street and Alton Avenue	9	628	47	227	1571	36	190	117	244	41	87	31
39	Bristol Street and MacArthur Boulevard	92	478	120	326	1419	148	192	1394	283	191	910	132
40	Bristol Street and Sunflower Avenue	94	461	136	245	1388	104	114	942	381	246	400	138
41	Bristol Street and I-405 NB Ramps	0	1489	191	0	1967	8	0	0	34	121	73	665
42	Bristol Street and I-405 SB Ramps	113	1108	0	0	985	847	573	0	524	0	0	0
43	Flower Street and Santa Ana Boulevard	87	811	118	168	568	76	114	710	81	101	323	135
44	Flower Street and 1st Street	139	602	159	175	554	58	165	1514	60	209	861	123
45	Flower Street and McFadden Avenue	60	438	38	66	367	53	51	581	44	64	432	58
46	Flower Street and Segerstrom Avenue	63	331	73	98	544	120	155	1065	297	74	546	60
47	Flower Street and MacArthur Boulevard	22	142	73	163	352	264	165	1879	80	54	909	58
48	Main Street and La Veta Avenue	84	579	300	198	1034	173	350	495	215	316	276	230
49	Main Street and Mainplace Drive / Memory Lane	28	764	250	32	1244	260	148	233	16	198	226	15

Santa Ana General Plan Update Traffic Impact Study – Final Draft

ID	Intersection	Northbound			Southbound			Eastbound			Westbound		
		L	T	R	L	T	R	L	T	R	L	T	R
50	Main Street and 17th Street	128	760	163	195	1086	70	116	1225	61	325	1300	19
51	Main Street and Civic Center Drive	138	901	79	59	1042	159	90	545	99	43	566	34
52	Main Street and Santa Ana Boulevard	68	1083	0	0	1107	98	0	0	0	61	848	65
53	Main Street and 4th Street	0	977	23	0	1098	27	0	93	14	0	114	28
54	Main Street and 1st Street	116	596	60	88	882	65	119	1393	147	88	1097	61
55	Main Street and McFadden Avenue	89	838	42	175	1364	27	42	396	43	140	373	107
56	Main Street and Edinger Avenue	109	617	67	228	1052	55	75	971	131	122	709	87
57	Main Street and MacArthur Boulevard	54	311	264	645	848	192	240	1393	252	146	435	218
58	Penn Way and 17th Street	43	0	217	0	0	0	0	1238	631	214	1722	0
59	Santiago Street / I-5 NB Ramps and 17th Street	768	35	22	57	0	295	99	1040	376	0	1245	20
60	Penn Way and I-5 SB Ramps	0	158	140	799	165	0	0	0	0	179	0	100
61	Santiago Street and Civic Center Drive	206	143	20	5	303	74	121	46	246	72	66	13
62	Santiago Street and Santa Ana Boulevard	24	71	56	311	161	133	48	474	14	108	807	271
63	Standard Avenue and 4th Street	-	-	-	-	-	-	-	-	-	-	-	-
64	Standard Avenue and 1st Street	108	191	119	12	231	25	86	1317	214	64	1012	12
65	Standard Avenue and McFadden Avenue	74	284	128	220	531	37	17	589	71	138	366	82
66	Halladay Street and Warner Avenue	43	0	100	0	0	0	0	1283	145	160	607	0
67	Halladay Street and Dyer Road	11	18	49	183	37	39	41	1375	10	115	626	101
68	SR-55 SB Ramps and MacArthur Boulevard	0	0	0	961	0	870	0	1441	1027	0	1275	145
69	SR-55 NB Ramps and MacArthur Boulevard	908	0	976	0	0	0	0	1609	796	0	517	244
70	SR-55 SB Ramps and Dyer Road	221	26	505	50	242	60	35	1338	285	408	647	108
71	Glassell Street and La Veta Avenue	263	412	125	17	358	79	38	195	375	236	249	6
72	Glassell Street and SR-22 WB Ramps	500	561	0	0	743	346	0	0	0	285	5	426
73	Glassell Street / Grand Avenue and SR-22 EB Ramps	0	818	218	280	733	0	258	0	1012	0	0	0
74	Grand Avenue and Fairhaven Avenue	18	737	106	174	1444	32	99	60	59	254	28	229
75	Grand Avenue and Santa Clara Avenue	66	463	119	290	1418	319	143	233	48	120	231	211
76	Grand Avenue and 17th Street	163	476	327	286	1198	235	224	835	106	309	807	88
77	Grand Avenue and I-5 NB Ramps	0	831	480	58	1869	0	0	0	0	456	0	126
78	Grand Avenue and	71	1003	51	141	1166	1029	263	217	428	5	373	34

Santa Ana General Plan Update Traffic Impact Study – Final Draft

ID	Intersection	Northbound			Southbound			Eastbound			Westbound		
		L	T	R	L	T	R	L	T	R	L	T	R
	Santa Ana Boulevard												
79	Grand Avenue and 1st Street	213	751	35	99	1432	174	332	793	225	247	867	99
80	Grand Avenue and Chestnut Avenue	53	737	163	149	1788	49	60	419	110	118	347	216
81	Grand Avenue and McFadden Avenue	171	722	108	237	1590	155	186	601	182	117	420	106
82	Grand Avenue and Edinger Avenue	47	472	92	224	1146	224	319	1332	128	151	579	126
83	Grand Avenue and Warner Avenue	169	510	218	199	574	194	256	914	359	88	388	131
84	SR-55 NB Ramps and Dyer Road	557	0	456	0	0	0	0	1533	613	0	719	433
85	Cambridge Street and La Veta Avenue	160	204	0	0	480	245	117	0	187	0	0	0
86	Cambridge Street and Fairhaven Avenue	0	0	0	515	0	166	80	216	0	0	247	192
87	Mabury Street and 1st Street	10	0	244	238	141	533	0	1062	11	46	701	0
88	Tustin Street and La Veta Avenue	8	333	96	74	1452	4	9	11	35	447	2	69
89	Tustin Street and SR-22 WB On-Ramp	656	610	0	0	1395	833	0	0	0	0	0	0
90	Tustin Street and SR-22 EB Off-Ramp / Seba Avenue	0	996	5	22	1349	0	244	24	1051	6	0	43
91	Tustin Street and Fairhaven Avenue	89	514	90	235	2026	40	68	258	444	306	338	442
92	Tustin Avenue and Santa Clara Avenue	73	397	74	127	2600	82	101	255	186	118	244	122
93	Tustin Avenue and 17th Street	111	198	236	602	1737	19	187	738	126	488	770	188
94	Tustin Avenue and 4th Street	48	245	219	664	845	262	114	676	28	103	579	376
95	SR-55 SB Ramps / Auto Mall Drive and Edinger Avenue	421	63	498	50	30	8	28	1104	408	399	940	123
96	SR-55 NB Ramps / Del Amo Avenue and Newport Avenue	227	60	38	14	344	504	253	153	146	8	223	4
97	Red Hill Avenue and Edinger Avenue	81	299	85	226	960	450	190	611	130	224	1085	152
98	Red Hill Avenue and Warner Avenue	56	339	46	19	891	179	202	343	253	98	349	62
99	Red Hill Avenue and Barranca Parkway	127	316	104	199	876	115	118	710	281	578	645	126
100	Red Hill Avenue and Alton Parkway	174	512	321	251	1141	183	9	28	28	223	189	106
101	Red Hill Avenue and MacArthur Boulevard	64	569	10	208	537	492	1248	645	106	23	223	571
102	Red Hill Avenue and Main Street	162	556	361	67	313	108	139	1309	254	154	309	73
103	I-5 SB Ramps and Santa Ana Boulevard	0	0	0	367	0	36	323	554	0	0	1130	330
104	Tustin Ranch Road and Warner Avenue	0	0	0	265	0	33	18	238	0	0	1717	395

ID	Intersection	Northbound			Southbound			Eastbound			Westbound		
		L	T	R	L	T	R	L	T	R	L	T	R
105	Von Karman Avenue and Barranca Parkway	107	142	85	119	1164	509	130	488	163	769	1263	39

Table 4-2 Existing Year 2020 Volumes – PM Peak Hour

ID	Intersection	Northbound			Southbound			Eastbound			Westbound		
		L	T	R	L	T	R	L	T	R	L	T	R
1	Euclid Street and Bolsa Avenue	159	1477	119	185	1053	199	212	678	106	217	909	217
2	Euclid Street and McFadden Avenue	175	1426	92	110	1354	164	183	419	185	127	532	246
3	Euclid Street and Edinger Avenue	526	1572	112	122	803	204	161	622	186	91	840	136
4	Newhope Street and Hazard Avenue	116	1281	50	49	1038	124	108	214	131	32	202	58
5	Newhope Street and McFadden Avenue	202	1084	190	164	733	142	81	496	72	107	589	168
6	Harbor Boulevard and SR-22 WB Off-Ramp / Banner Drive	88	1992	0	0	1519	49	93	0	78	593	80	170
7	Trask Avenue and SR-22 EB On-Ramp	0	0	0	0	0	0	838	628	0	0	606	57
8	Harbor Boulevard and Westminster Avenue	276	1374	325	207	1430	165	187	667	32	230	797	181
9	Harbor Boulevard and 1st Street	287	1480	164	278	1218	164	188	766	145	230	1073	175
10	Harbor Boulevard and McFadden Avenue	167	1716	125	298	1273	115	214	520	65	211	506	146
11	Harbor Boulevard and Edinger Avenue	282	1773	214	283	822	75	134	564	100	140	813	271
12	Harbor Boulevard and Warner Avenue	774	3713	279	274	1525	182	241	1707	390	260	2700	862
13	Harbor Boulevard and Segerstrom Avenue	299	1881	60	91	1027	91	111	552	181	99	1074	390
14	Hyland Avenue / OCTA Bus Base and MacArthur Boulevard	1201	7	70	12	4	14	36	891	160	25	2350	12
15	Harbor Boulevard and MacArthur Boulevard	588	1519	88	213	1073	176	140	489	181	87	1467	276
16	Harbor Boulevard and Sunflower Avenue	178	1771	263	112	1393	42	67	182	189	254	533	199
17	Harbor Boulevard and I-405 NB Off-Ramp	0	1529	0	0	2475	0	0	0	0	701	0	1132
18	Harbor Boulevard and I-405 SB Off-Ramp	0	1861	0	0	2147	0	157	0	722	0	0	0
19	Fairview Street and Civic Center Drive	5	1430	402	144	1338	0	2	5	4	438	0	162
20	Fairview Street and 1st Street	149	1094	99	203	1264	251	215	870	151	159	1204	186
21	Fairview Street and McFadden Avenue	159	1462	127	155	1257	196	244	659	163	158	545	134
22	Fairview Street and Edinger Avenue	188	1793	110	198	616	151	230	703	188	373	789	173
23	Fairview Street and Warner Avenue	217	1728	161	188	951	96	197	955	148	188	1108	240
24	Fairview Street and MacArthur Boulevard	243	1672	91	171	955	88	280	731	246	179	1365	239
25	Fairview Road and Sunflower Avenue	201	1806	393	144	1196	83	203	430	95	265	664	173

Santa Ana General Plan Update Traffic Impact Study – Final Draft

ID	Intersection	Northbound			Southbound			Eastbound			Westbound		
		L	T	R	L	T	R	L	T	R	L	T	R
26	Greenville Street and Edinger Avenue	327	0	218	0	0	0	0	982	200	95	1128	0
27	Greenville Street and Segerstrom Avenue	57	476	36	61	200	61	108	823	47	27	1037	148
28	Raitt Street and McFadden Avenue	58	835	130	45	474	76	126	747	65	88	742	102
29	Raitt Street and Edinger Avenue	190	816	229	111	384	96	139	961	137	86	972	87
30	Bear Street and MacArthur Boulevard	200	962	251	112	271	82	97	910	94	93	1673	266
31	Bristol Street and 17th Street	236	1148	191	243	1293	220	336	750	136	284	1069	362
32	Bristol Street and Civic Center Drive	200	1399	73	136	1250	128	190	534	63	169	723	82
33	Bristol Street and Santa Ana Boulevard	75	1524	87	105	1402	53	59	163	38	233	371	100
34	Bristol Street and 1st Street	286	1235	182	206	1115	252	189	1062	136	217	1330	126
35	Bristol Street and McFadden Avenue	213	1566	85	84	1171	270	262	512	102	97	504	59
36	Bristol Street and Warner Avenue	309	1157	211	251	838	163	193	868	153	173	1021	299
37	Bristol Street and Segerstrom Avenue	179	1322	233	92	843	176	200	716	57	119	1074	54
38	Bristol Street and Alton Avenue	43	1681	158	119	896	56	75	105	195	91	150	29
39	Bristol Street and MacArthur Boulevard	335	1428	260	223	821	129	357	796	169	265	1536	290
40	Bristol Street and Sunflower Avenue	645	1363	220	201	750	215	293	573	222	263	1012	322
41	Bristol Street and I-405 NB Ramps	0	2094	183	0	2148	20	0	0	194	357	306	1184
42	Bristol Street and I-405 SB Ramps	127	1555	0	0	1506	880	740	0	331	0	0	0
43	Flower Street and Santa Ana Boulevard	124	754	62	104	530	48	134	386	63	146	510	151
44	Flower Street and 1st Street	132	625	149	170	466	135	139	1217	101	210	1415	147
45	Flower Street and McFadden Avenue	42	567	35	46	352	57	64	478	19	48	595	85
46	Flower Street and Segerstrom Avenue	120	843	80	66	369	106	158	786	83	75	1258	81
47	Flower Street and MacArthur Boulevard	133	634	74	85	205	197	209	994	63	62	1989	177
48	Main Street and La Veta Avenue	307	938	439	145	911	235	296	422	189	257	513	206
49	Main Street and Mainplace Drive / Memory Lane	90	945	179	51	1055	139	293	325	87	185	151	73
50	Main Street and 17th Street	197	1019	222	173	757	117	221	1237	73	178	1089	72
51	Main Street and Civic Center Drive	89	1126	94	61	995	63	159	881	105	38	384	39
52	Main Street and Santa Ana Boulevard	54	1229	0	0	1083	53	0	0	0	65	656	85
53	Main Street and 4th Street	0	1055	50	0	1037	47	0	98	55	0	181	46

Santa Ana General Plan Update Traffic Impact Study – Final Draft

ID	Intersection	Northbound			Southbound			Eastbound			Westbound		
		L	T	R	L	T	R	L	T	R	L	T	R
54	Main Street and 1st Street	169	826	72	175	671	143	120	1214	90	114	1275	89
55	Main Street and McFadden Avenue	146	1147	71	134	908	66	78	345	42	85	480	216
56	Main Street and Edinger Avenue	99	1050	48	122	609	83	127	752	84	97	1296	134
57	Main Street and MacArthur Boulevard	488	1169	321	283	368	278	298	613	59	198	1570	456
58	Penn Way and 17th Street	848	0	414	0	0	0	0	1590	513	123	1440	0
59	Santiago Street / I-5 NB Ramps and 17th Street	345	46	18	51	0	133	120	1099	722	0	1525	41
60	Penn Way and I-5 SB Ramps	0	363	238	550	127	0	0	0	0	175	0	150
61	Santiago Street and Civic Center Drive	97	299	30	13	187	48	266	76	269	14	19	18
62	Santiago Street and Santa Ana Boulevard	36	133	84	297	120	61	71	649	20	73	492	187
63	Standard Avenue and 4th Street	-	-	-	-	-	-	-	-	-	-	-	-
64	Standard Avenue and 1st Street	185	367	119	19	189	23	177	1218	129	91	1148	21
65	Standard Avenue and McFadden Avenue	169	667	82	137	300	52	53	351	60	117	712	206
66	Halladay Street and Warner Avenue	169	0	352	0	0	0	2	926	93	141	1121	0
67	Halladay Street and Dyer Road	41	180	208	114	15	32	150	1298	9	45	1451	116
68	SR-55 SB Ramps and MacArthur Boulevard	0	0	0	288	0	697	0	1167	1040	0	1532	602
69	SR-55 NB Ramps and MacArthur Boulevard	641	0	426	0	0	0	0	711	731	0	1501	1081
70	SR-55 SB Ramps and Dyer Road	319	10	240	103	226	110	65	1523	207	556	991	64
71	Glassell Street and La Veta Avenue	472	490	160	15	499	37	82	268	461	155	280	11
72	Glassell Street and SR-22 WB Ramps	557	910	0	0	878	255	0	0	0	201	7	357
73	Glassell Street / Grand Avenue and SR-22 EB Ramps	0	1202	307	381	681	0	229	4	503	0	0	0
74	Grand Avenue and Fairhaven Avenue	46	1214	243	222	894	82	79	45	33	255	48	181
75	Grand Avenue and Santa Clara Avenue	88	1185	246	220	868	220	159	194	36	136	244	260
76	Grand Avenue and 17th Street	246	877	221	270	582	128	346	886	149	300	1107	201
77	Grand Avenue and I-5 NB Ramps	0	1297	1001	48	1164	0	0	0	0	143	0	172
78	Grand Avenue and Santa Ana Boulevard	167	1888	31	34	750	532	328	200	316	20	134	97
79	Grand Avenue and 1st Street	165	1261	38	120	706	282	277	918	91	151	941	173
80	Grand Avenue and Chestnut Avenue	140	1050	182	149	664	112	93	285	62	107	333	194
81	Grand Avenue and McFadden Avenue	202	1150	198	138	626	168	128	476	83	86	686	151

Santa Ana General Plan Update Traffic Impact Study – Final Draft

ID	Intersection	Northbound			Southbound			Eastbound			Westbound		
		L	T	R	L	T	R	L	T	R	L	T	R
82	Grand Avenue and Edinger Avenue	242	1397	121	165	408	229	201	868	70	74	1333	173
83	Grand Avenue and Warner Avenue	242	873	193	146	471	217	342	656	142	151	964	316
84	SR-55 NB Ramps and Dyer Road	188	0	51	0	0	0	0	1339	681	0	1545	965
85	Cambridge Street and La Veta Avenue	191	266	0	0	196	181	219	0	144	0	0	0
86	Cambridge Street and Fairhaven Avenue	0	0	0	219	0	76	141	246	0	0	273	340
87	Mabury Street and 1st Street	25	0	256	207	88	390	0	1512	24	40	549	0
88	Tustin Street and La Veta Avenue	46	1033	245	90	801	15	13	5	20	183	5	112
89	Tustin Street and SR-22 WB On-Ramp	532	1529	0	0	711	365	0	0	0	0	0	0
90	Tustin Street and SR-22 EB Off-Ramp / Seba Avenue	0	1547	4	52	707	0	458	41	581	28	0	67
91	Tustin Street and Fairhaven Avenue	239	1275	113	327	862	99	80	180	147	94	208	196
92	Tustin Avenue and Santa Clara Avenue	163	789	121	183	1444	100	61	192	113	125	157	148
93	Tustin Avenue and 17th Street	216	926	476	346	371	37	444	872	118	229	753	419
94	Tustin Avenue and 4th Street	55	598	194	459	339	124	180	642	33	88	596	367
95	SR-55 SB Ramps / Auto Mall Drive and Edinger Avenue	377	30	398	110	50	37	35	1258	354	385	1003	120
96	SR-55 NB Ramps / Del Amo Avenue and Newport Avenue	583	174	34	8	97	373	104	36	21	23	348	16
97	Red Hill Avenue and Edinger Avenue	159	1146	182	145	289	234	327	838	102	62	803	392
98	Red Hill Avenue and Warner Avenue	382	1308	150	58	223	283	222	603	94	25	525	69
99	Red Hill Avenue and Barranca Parkway	356	1339	345	185	313	147	203	753	99	127	966	282
100	Red Hill Avenue and Alton Parkway	27	1499	217	124	528	4	132	324	166	433	74	267
101	Red Hill Avenue and MacArthur Boulevard	125	809	10	286	594	1042	597	275	42	39	818	574
102	Red Hill Avenue and Main Street	416	897	242	74	538	292	198	705	191	279	1589	89
103	I-5 SB Ramps and Santa Ana Boulevard	0	0	0	278	0	61	561	634	0	0	668	183
104	Tustin Ranch Road and Warner Avenue	0	0	0	653	0	45	54	1795	0	0	548	236
105	Von Karman Avenue and Barranca Parkway	224	1290	281	67	343	236	560	1023	143	204	646	220

4.3 EXISTING YEAR (2020) VEHICLE MILES TRAVELED (VMT)

Table 4-3 presents the VMT analysis results for the existing year (2020) scenario. VMT calculations are based on the scenario parameters and methodology as described in Sections 2.5 and 3.1, respectively.

Table 4-3 Existing Year (2020) VMT Summary

	I – I VMT	I – X VMT	X – I VMT	Total VMT	Service Population	VMT/SP
City	697,779	5,356,504	5,352,841	11,407,124	507,924	22.5
County	48,242,429	25,463,887	25,637,825	99,344,141	3,834,949	25.9

SP = Service Population = Total Employees + Total Population. Reduction factor applied to Total Employees as noted in Section 3.1 and shown in Appendix F. I-I = Internal-Internal; I-X = Internal-External; X-I = External-Internal.

4.4 EXISTING YEAR (2020) ROADWAY SEGMENT LEVEL OF SERVICE

Table 4-4 includes the 24-hour count locations, volumes, and corresponding roadway segment level of service. The following study roadway segments currently operate at a deficient LOS:

- Segment 4 – Harbor Boulevard from Westminster Avenue/17th Street to Hazard Avenue
- Segment 11 – Bristol Street from 17th Street to Santa Clara Avenue
- Segment 13 – Bristol Street from 17th Street to Washington Avenue
- Segment 14 – Fairview Street from Trask Avenue to 17th Street
- Segment 17 – Flower Street from 1st Street to Bishop Street
- Segment 23 – Main Street from 1st Street to Bishop Street
- Segment 25 – Grand Avenue from Santa Ana Boulevard to 4th Street
- Segment 39 – Bristol Street from Edinger Avenue to Warner Avenue
- Segment 44 – Edinger Avenue from Flower Street to Main Street
- Segment 45 – Main Street from McFadden Avenue to Edinger Avenue
- Segment 57 – Dyer Road from Grand Avenue to Pullman Street
- Segment 58 – McFadden Avenue from Bristol Street to Flower Street
- Segment 72 – McFadden Avenue from Main Street to Standard Avenue
- Segment 88 – Harbor Boulevard from Edinger Avenue to Warner Avenue

Table 4-4 Existing Year (2020) Roadway Segment LOS

ID	Street	Segment	Lanes	ADT	LOS
1	1st Street	Euclid Street to Ward Street	6D	25,233	A
2	Euclid Street	1st Street to McFadden Avenue	6D	40,731	C
3	Westminster Avenue	Harbor Boulevard to Fairview Street	6D	30,459	A
4	Harbor Boulevard	Westminster Avenue/17th Street to Hazard Avenue	6D	54,137	E
5	1st Street	Harbor Boulevard to Jackson	6D	32,736	A
6	Edinger Avenue	Harbor Boulevard to Fairview Street	4D	27,838	C
7	Warner Avenue	Harbor Boulevard to Fairview Street	6D	31,945	A
8	Harbor Boulevard	Segerstrom Avenue to MacArthur Boulevard	6D	15,622	A
9	Fairview Street	1st Street to Willits Street	6D	42,605	C
10	1st Street	Sullivan Street to Raitt Street	6D	36,377	B
11	Bristol Street	17th Street to Santa Clara Avenue	4D	45,676	F
12	17th Street	College Avenue to Bristol Street	6D	37,345	B
13	Bristol Street	17th Street to Washington Avenue	4D	42,005	F
14	Fairview Street	Trask Avenue to 17th Street	4D	40,432	F
15	Bristol Street	1st Street to Bishop Street	6D	42,663	C
16	Civic Center Drive	Bristol Street to Flower Street	4D	17,589	A
17	Flower Street	1st Street to Bishop Street	2U	15,622	F
18	Main Street	17th Street to 20th Street	4D	32,044	D
19	Main Street	Washington Street to Civic Center Drive	4D	33,489	D
20	Civic Center Drive	Flower Street to Ross Street	4D	17,427	A
21	Santa Ana Boulevard	Flower Street to Ross Street	6D	14,689	A
22	1st Street	Main Street to Standard Avenue	6D	42,699	C
23	Main Street	1st Street to Bishop Street	4U	30,125	F
24	Grand Avenue	Santa Clara Avenue to Fairhaven Street	4D	30,206	D
25	Grand Avenue	Santa Ana Boulevard to 4th Street	4D	36,678	E
26	Santa Clara Avenue	Grand Avenue to Tustin Avenue	2U	10,585	D
27	Tustin Avenue	Santa Clara Avenue to Fairhaven Street	6D	35,410	B
28	17th Street	Cabrillo Park Drive to Tustin Avenue	4D	32,080	D
29	Tustin Avenue	Fruit Street to 4th Street	6D	25,174	A
30	1st Street	Grand Avenue to Elk Lane	6D	28,638	A
31	1st Street	Cabrillo Park Drive to Tustin Avenue	6D	22,083	A
32	Fairview Street	Edinger Avenue to Harvard Street	6D	37,524	B
33	Fairview Street	Warner Avenue to Segerstrom Avenue	6D	39,878	C
34	MacArthur Boulevard	Harbor Boulevard to Fairview Street	6D	26,235	A
35	Edinger Avenue	Fairview Street to Greenville Street	4D	29,115	C
36	McFadden Avenue	Fairview Street to Raitt Street	4D	20,997	A
37	MacArthur Boulevard	Fairview Street to Raitt Street	6D	28,809	A
38	Segerstrom Avenue	Fairview Street to Raitt Street	4D	19,326	A
39	Bristol Street	Edinger Avenue to Warner Avenue	4D	37,238	E
40	Bristol Street	Warner Avenue to Segerstrom Avenue	6D	38,007	B

ID	Street	Segment	Lanes	ADT	LOS
41	Warner Avenue	Raitt Street to Bristol Street	5D	34,555	C
42	Bristol Street	MacArthur Boulevard to Sunflower Avenue	6D	34,731	B
43	Flower Street	Warner Avenue to Segerstrom Avenue	4D	15,378	A
44	Edinger Avenue	Flower Street to Main Street	4D	36,534	E
45	Main Street	McFadden Avenue to Edinger Avenue	4U	28,622	F
46	Main Street	Edinger Avenue to Warner Avenue	4D	27,972	C
47	Main Street	Warner Avenue to Dyer Road	5D	30,484	B
48	Segerstrom Avenue	Bristol Street to Flower Street	4D	22,959	B
49	MacArthur Boulevard	Flower Street to Main Street	6D	37,946	B
50	Main Street	MacArthur Boulevard to Sunflower Avenue	6D	23,692	A
51	Grand Avenue	Edinger Avenue to Warner Avenue	6D	17,735	A
52	Edinger Avenue	Richie Street to Newport Avenue	6D	40,435	C
53	Warner Avenue	Grand Avenue to Red Hill Avenue	6D	22,435	A
54	Warner Avenue	Main Street to Standard Avenue	6D	27,391	A
55	McFadden Avenue	Newhope Street to Harbor Boulevard	4D	18,495	A
56	McFadden Avenue	Standard Avenue to Grand Avenue	4D	20,188	A
57	Dyer Road	Grand Avenue to Pullman Street	6D	51,084	E
58	McFadden Avenue	Bristol Street to Flower Street	2U	14,951	F
59	Main Street	La Veta Avenue to Memory Lane	6D	31,004	A
60	1st Street	Bristol Street to Flower Street	6D	39,006	B
61	Fairhaven Avenue	Grand Avenue to Tustin Avenue	4D	10,218	A
62	4th Street	French Street to Standard Avenue	2D	14,855	C
63	Broadway	17th Street to Civic Center Drive	4D	20,630	A
64	Broadway	Civic Center Drive to 1st Street	4U	16,005	B
65	Cambridge Street	SR-22 to Fairhaven Avenue	2U	- *	-
66	Chestnut Avenue	Standard Avenue to Lyon Street	4U	2,587	A
67	Civic Center Drive	French Street to Santiago Street	2U	10,266	D
68	Civic Center Drive	Fairview Road to Bristol Street	4U	13,772	A
69	Flower Street	Edinger Avenue to Warner Avenue	2U	10,964	D
70	Halladay Avenue	Warner Avenue to Dyer Road	2D	- *	-
71	Hazard Avenue	Euclid Street to Harbor Boulevard	4U	9,546	A
72	McFadden Avenue	Main Street to Standard Avenue	2U	16,064	F
73	Penn Way/Santiago Street	I-5 SB Ramps to Santa Ana Boulevard	4U	- *	-
74	Raitt Street	Santa Ana Boulevard to 1st Street	2U	9,978	C
75	Raitt Street	Warner Avenue to Segerstrom Avenue	4D	14,746	A
76	Santa Ana Boulevard	French Street to Santiago Street	2D	6,616	A
77	Santa Ana Boulevard	Raitt Street to Bristol Street	4U	4,236	A
78	Standard Avenue	Chestnut Avenue to McFadden Avenue	4U	12,871	A
79	Standard Avenue	Edinger Avenue to Warner Avenue	4U	12,852	A
80	Greenville Street	Edinger Avenue to Warner Avenue	2U	7,090	A
81	Greenville Street	Warner Avenue to Segerstrom Avenue	4D	8,578	A
82	Flower Street	17th Street to Northern Terminus	2D	11,155	B

ID	Street	Segment	Lanes	ADT	LOS
83	Logan Street	Civic Center Drive to Santa Ana Boulevard	2U	- *	-
84	Dyer Road	Pullman Street to Red Hill Avenue	6D	31,248	A
85	Fairhaven Avenue	Tustin Street to Yorba Street	4U	16,381	B
86	Santa Clara Avenue	Tustin Street to Yorba Street	2U	8,568	B
87	Harbor Boulevard	McFadden Avenue to Edinger Avenue	6D	49,281	D
88	Harbor Boulevard	Edinger Avenue to Warner Avenue	6D	52,363	E

Notes:

* Not available.

(1) ADT – Average Daily Traffic Volumes

(2) LOS – Level of Service

(3) #D – total number of lanes in both directions divided by raised or striped median; #U – total number of undivided lanes in both directions

(4) Roadway capacities shown in Table 3-1.

(5) Yellow and red shading indicates an unacceptable level of service.

4.5 EXISTING YEAR (2020) INTERSECTION LEVEL OF SERVICE

A summary of the AM and PM peak hour level of service analysis results for the existing year (2020) existing condition are included in Table 4-5. Intersections are general considered unacceptable if the level of service (LOS) is “E” or “F”. It should be noted that Caltrans and CMP intersection have a minimum acceptable LOS of C and E, respectively. The following intersections are forecast to have unacceptable level of service in the existing year (2020) condition:

- INT 2 – Euclid street and McFadden Avenue (City of Santa Ana)
- INT 12 – Harbor Boulevard and Warner Avenue (City of Santa Ana – CMP)
- INT 13 – Harbor Boulevard and Segerstrom Avenue (City of Santa Ana)
- INT 14 – Hyland Avenue and MacArthur Boulevard (City of Costa Mesa / City of Santa Ana)
- INT 37 – Bristol Street and Segerstrom Avenue (City of Santa Ana)
- INT 45 – Flower Street and McFadden Avenue (City of Santa Ana)
- INT 47 – Flower Street and MacArthur Boulevard (City of Santa Ana)
- INT 82 – Grand Avenue and Edinger Avenue (City of Santa Ana)
- INT 91 – Tustin Street and Fairhaven Avenue (City of Orange)

Table 4-5: Existing Year (2020) LOS Summary

ID	INTERSECTION	AM		PM	
		V/C or Delay	LOS	V/C or Delay	LOS
1	Euclid Street and Bolsa Avenue	0.85	D	0.87	D
2	Euclid Street and McFadden Avenue	0.91	E	0.83	D
3	Euclid Street and Edinger Avenue	0.86	D	0.79	C
4	Newhope Street and Hazard Avenue	0.71	C	0.64	B
5	Newhope Street and McFadden Avenue	0.83	D	0.84	D
6	Harbor Boulevard and SR-22 WB Off-Ramp / Banner Drive	27.4	C	23.6	C
7	Trask Avenue and SR-22 EB On-Ramp	11.5	B	12.4	B
8	Harbor Boulevard and Westminster Avenue	0.82	D	0.79	C
9	Harbor Boulevard and 1st Street	0.81	D	0.83	D
10	Harbor Boulevard and McFadden Avenue	0.79	C	0.81	D
11	Harbor Boulevard and Edinger Avenue	0.77	C	0.70	B
12	Harbor Boulevard and Warner Avenue	0.81	D	1.58	F
13	Harbor Boulevard and Segerstrom Avenue	0.98	E	0.90	D
14	Hyland Avenue / OCTA Bus Base and MacArthur Boulevard	0.61	B	0.92	E
15	Harbor Boulevard and MacArthur Boulevard	0.75	C	0.82	D
16	Harbor Boulevard and Sunflower Avenue	0.70	B	0.78	C
17	Harbor Boulevard and I-405 NB Off-Ramp	19.7	B	23.7	C
18	Harbor Boulevard and I-405 SB Off-Ramp	13.2	B	19.4	B
19	Fairview Street and Civic Center Drive	0.67	B	0.66	B
20	Fairview Street and 1st Street	0.87	D	0.88	D
21	Fairview Street and McFadden Avenue	0.79	C	0.80	C
22	Fairview Street and Edinger Avenue	0.75	C	0.81	D
23	Fairview Street and Warner Avenue	0.85	D	0.85	D
24	Fairview Street and MacArthur Boulevard	0.70	B	0.83	D
25	Fairview Road and Sunflower Avenue	0.71	C	0.71	C
26	Greenville Street and Edinger Avenue	0.56	A	0.59	A
27	Greenville Street and Segerstrom Avenue	0.73	C	0.69	B
28	Raitt Street and McFadden Avenue	0.72	C	0.72	C
29	Raitt Street and Edinger Avenue	0.85	D	0.86	D
30	Bear Street and MacArthur Boulevard	0.74	C	0.87	D
31	Bristol Street and 17th Street	0.73	C	0.69	B
32	Bristol Street and Civic Center Drive	0.83	D	0.83	D
33	Bristol Street and Santa Ana Boulevard	0.67	B	0.66	B
34	Bristol Street and 1st Street	0.75	C	0.78	C
35	Bristol Street and McFadden Avenue	0.75	C	0.75	C
36	Bristol Street and Warner Avenue	0.77	C	0.79	C
37	Bristol Street and Segerstrom Avenue	0.79	C	0.91	E
38	Bristol Street and Alton Avenue	0.56	A	0.69	B
39	Bristol Street and MacArthur Boulevard	0.74	C	0.81	D

ID	INTERSECTION	AM		PM	
		V/C or Delay	LOS	V/C or Delay	LOS
40	Bristol Street and Sunflower Avenue	0.64	B	0.69	B
41	Bristol Street and I-405 NB Ramps	19.1	B	28.2	C
42	Bristol Street and I-405 SB Ramps	22.3	C	18.4	B
43	Flower Street and Santa Ana Boulevard	0.60	A	0.57	A
44	Flower Street and 1st Street	0.80	C	0.75	C
45	Flower Street and McFadden Avenue	0.82	D	0.92	E
46	Flower Street and Segerstrom Avenue	0.77	C	0.90	D
47	Flower Street and MacArthur Boulevard	0.70	B	0.91	E
48	Main Street and La Veta Avenue	0.57	A	0.63	B
49	Main Street and Mainplace Drive / Memory Lane	0.49	A	0.47	A
50	Main Street and 17th Street	0.82	D	0.73	C
51	Main Street and Civic Center Drive	0.76	C	0.80	C
52	Main Street and Santa Ana Boulevard	0.67	B	0.61	B
53	Main Street and 4th Street	0.49	A	0.54	A
54	Main Street and 1st Street	0.76	C	0.80	C
55	Main Street and McFadden Avenue	0.90	D	0.85	D
56	Main Street and Edinger Avenue	0.83	D	0.85	D
57	Main Street and MacArthur Boulevard	0.74	C	0.78	C
58	Penn Way and 17th Street	11.2	B	20.7	C
59	Santiago Street / I-5 NB Ramps and 17th Street	31.2	C	19.5	B
60	Penn Way and I-5 SB Ramps	19.0	B	22.0	C
61	Santiago Street and Civic Center Drive	16.9	C	17.1	C
62	Santiago Street and Santa Ana Boulevard	0.55	A	0.57	A
63*	Standard Avenue and 4th Street	-	-	-	-
64	Standard Avenue and 1st Street	0.80	C	0.84	D
65	Standard Avenue and McFadden Avenue	0.61	B	0.68	B
66	Halladay Street and Warner Avenue	0.66	B	0.68	B
67	Halladay Street and Dyer Road	0.57	A	0.78	C
68	SR-55 SB Ramps and MacArthur Boulevard	19.8	B	17.3	B
69	SR-55 NB Ramps and MacArthur Boulevard	19.2	B	14.8	B
70	SR-55 SB Ramps and Dyer Road	23.7	C	25.7	C
71	Glassell Street and La Veta Avenue	0.60	A	0.62	B
72	Glassell Street and SR-22 WB Ramps	28.5	C	24.8	C
73	Glassell Street / Grand Avenue and SR-22 EB Ramps	27.0	C	26.5	C
74	Grand Avenue and Fairhaven Avenue	0.68	B	0.68	B
75	Grand Avenue and Santa Clara Avenue	0.89	D	0.75	C
76	Grand Avenue and 17th Street	0.80	C	0.83	D
77	Grand Avenue and I-5 NB Ramps	12.9	B	10.0	A
78	Grand Avenue and Santa Ana Boulevard	23.8	C	21.1	C
79	Grand Avenue and 1st Street	0.80	C	0.79	C

ID	INTERSECTION	AM		PM	
		V/C or Delay	LOS	V/C or Delay	LOS
80	Grand Avenue and Chestnut Avenue	0.71	C	0.62	B
81	Grand Avenue and McFadden Avenue	0.83	D	0.76	C
82	Grand Avenue and Edinger Avenue	0.76	C	0.91	E
83	Grand Avenue and Warner Avenue	0.53	A	0.70	B
84	SR-55 NB Ramps and Dyer Road	16.3	B	5.7	A
85	Cambridge Street and La Veta Avenue	17.3	C	12.5	B
86	Cambridge Street and Fairhaven Avenue	0.56	A	0.58	A
87	Mabury Street and 1st Street	28.3	C	26.1	C
88	Tustin Street and La Veta Avenue	0.52	A	0.44	A
89	Tustin Street and SR-22 WB On-Ramp	12.9	B	12.1	B
90	Tustin Street and SR-22 EB Off-Ramp / Seba Avenue	24.2	C	23.7	C
91	Tustin Street and Fairhaven Avenue	0.98	E	0.61	B
92	Tustin Avenue and Santa Clara Avenue	0.87	D	0.65	B
93	Tustin Avenue and 17th Street	0.75	C	0.72	C
94	Tustin Avenue and 4th Street	0.70	B	0.69	B
95	SR-55 SB Ramps / Auto Mall Drive and Edinger Avenue	24.4	C	25.1	C
96	SR-55 NB Ramps / Del Amo Avenue and Newport Avenue	24.0	C	27.4	C
97	Red Hill Avenue and Edinger Avenue	0.57	A	0.67	B
98	Red Hill Avenue and Warner Avenue	0.49	A	0.59	A
99	Red Hill Avenue and Barranca Parkway	0.58	A	0.56	A
100	Red Hill Avenue and Alton Parkway	0.52	A	0.67	B
101	Red Hill Avenue and MacArthur Boulevard	0.66	B	0.66	B
102	Red Hill Avenue and Main Street	0.67	B	0.77	C
103	I-5 SB Ramps and Santa Ana Boulevard	17.4	B	18.9	B
104	Tustin Ranch Road and Warner Avenue	0.48	A	0.61	B
105	Von Karman Avenue and Barranca Parkway	0.76	C	0.87	D

Notes: (1) LOS – Level of Service; (2) V/C – Volume to Capacity

*Intersection does not currently exist; assessed in future scenarios only.

5.0 Future Year 2045 Forecast Modeling

5.1 ORANGE COUNTY TRANSPORTATION AUTHORITY MODEL (OCTAM)

The Orange County Transportation Authority (OCTA) is responsible for regional transportation planning in Orange County. OCTA's role as the regional planning agency is to plan for and evaluate multi-modal transportation alternatives to support regional planning activities. The Orange County Transportation Authority Model (OCTAM) is OCTA's regional model that is based on the traditional four-step sequential modeling methodology with "feedback loops" procedures to insure internal modeling consistency. The model incorporates multi-modal analytical capabilities to analyze the following modes of travel: local and express bus transit, urban rail, commuter rail, toll roads, carpools, truck traffic, as well as non-motorized transportation which includes pedestrian and bicycle trips. The model responds to changes in land use types, household characteristics, transportation infrastructure, and travel costs such as transit fares, parking costs, tolls, and auto operating costs.

5.2 PEAK HOUR FORECASTS

The future year 2040 volumes were derived based on existing peak hour count data and forecast link volumes obtained from the Orange County Transportation Analysis Model (OCTAM 5.0). OCTAM 5.0 (TransCad) is the accepted sub-regional model for forecasting travel demand for Orange County. Growth factors for each intersection approach and departure were interpolated from OCTAM 5.0 link plots for the baseline 2016 and 2045 scenarios. These growth factors were then applied to existing counts to forecast future turning movement volumes at each of the study intersections.

5.2.1 Turning Movement Development

It should be noted that Intersection #63 (Standard Avenue and 4th Street) does not currently exist, but is assumed to be constructed in the future year (2045) scenarios. Turning movement volumes for this intersection were developed through use of a post-processor. Because this intersection may affect local travel patterns, turning movement volumes for two adjacent intersections were also developed using this method. These intersections are #62 (Santiago Street and Santa Ana Boulevard) and #64 (Standard Avenue and 1st Street).

The process of converting link level traffic volumes to turning movement volumes is called "post processing." The fundamental theory behind the post-processor is the belief that with proper calibration, travel demand models provide good forecasts at the link level. Turning level forecasts are obtainable from the model, but the reliability of the forecast breaks down at this level of detail, and the abstraction of reality into numerical methods becomes apparent. The frictionless nature of left and right turns in the travel demand model allow them to occur as easily as through movements, which does not represent a realistic situation.

IBI Group has developed a spreadsheet-based postprocessor that uses existing turning movement volumes or split percentages along with forecast link-level data to determine future turn movement volumes at selected intersections. For intersections where existing data is not available (#63), assumed split percentages of 50% for the through movements, 25% for the right turn movements, and 25% for the left turn movements are used.

The postprocessor generates another solution to the possible combination of turning movements at a given intersection. There are numerous approaches to post processing. The IBI Group postprocessor utilizes a procedure documented in Chapter 8 of the National Cooperative Highway Research Program Report 255. It uses an iterative process to balance the intersection throughput volumes, which provides the best combination of reasonable turning movement volumes and traceability of results. Most importantly, the model link volumes (especially the approach intersection volumes) are maintained

when using this methodology. The "post processing" method can be summarized into the following steps:

1. If existing peak hour turning movement volumes are not available, calculate a base set of turning volumes from the known/assumed splits and the peak hour approach link volumes.
2. Calculate the inbound and outbound volumes for each leg of the intersection from the initial set of turning volumes.
3. Multiply the inbound volumes by the ratio of the forecast inbound volume to the calculated inbound volume for each leg. The calculated inbound volumes should now match the forecast inbound volumes.
4. Multiply the new volumes by the ratio of the forecast outbound volume to the calculated outbound volume for each leg. The calculated outbound volumes should now match the forecast outbound volumes for each leg, but the calculated inbound volumes may no longer be equal to the forecast inbound volumes.
5. Compare the calculated approach and departure volumes with the forecast approach and departure volumes.
6. If the deviation is within the tolerance level, the solution is obtained.
7. If the deviation is not within the tolerance level, repeat steps 3 and 4.
8. Repeat this process until the tolerance is met.

5.2.2 Roadway Segment Forecasts

Forecast roadway segment volumes were also derived based on existing average daily traffic (ADT) volumes and forecast ADT link volumes obtained from OCTAM 5.0. Growth factors for each study roadway segment were interpolated from OCTAM 5.0 link plots for the 2016 and 2045 baseline scenarios. The growth factors were then applied to existing ADT counts to forecast future roadway segment ADT.

5.2.3 Santa Ana Fixed Guideway (OC Streetcar)

As described in Section 2.0 of this report, the OC Streetcar is a proposed streetcar service that would travel primarily along Santa Ana Boulevard and the Pacific Electric Right-of-Way (PEROW) between the Santa Ana Regional Transportation Center (SARTC) and Garden Grove (4 miles long). The streetcar is proposed to travel along an exclusive guideway or path on rails that are embedded in the pavement. The streetcar would adhere to the same signal operations as on-street automobiles for most locations where Transit Signal Priority is not implemented. Santa Ana Boulevard is reclassified between Raitt Street and Shelton Street from a four lane undivided roadway to a two lane roadway (divided with a center left turn lane or raised median with left turn pockets. The project also proposes to reconfigure portions of Santa Ana Boulevard between Raitt Street and SARTC to accommodate a bike lane on the north side of the street throughout the alignment as well as 14-inch high platforms. The Fixed Guideway service is proposed to run every 10 to 15 minutes from approximately 6:00 AM to 11:00 PM. Within OCTAM, the Fixed Guideway is modeled as 'bus transit,' which would translate to six extra trips assigned during the peak hour in the direction of operations.

In 2016, the OCTA Board conditionally approved the following additional MPAH amendments:

- Fourth Street from French Street to Grand Avenue – Secondary to Divided Collector
- Santa Ana Boulevard from Flower Street to Ross – Major to Primary
- Santa Ana Boulevard from French Street to Santiago Street – Primary to Divided Collector
- Santa Ana Boulevard from Raitt Street to Flower Street – Major to Divided Collector

6.0 Future Year (2045) No Project

This scenario is used as the point of comparison for the network alternatives and consists of the key elements presented in Section 2.6.

This scenario will serve as a base for comparison and establish impacts of the proposed With Project network. The Future Year 2045 No Project intersection geometries are the same as existing. The future year 2045 No Project volumes for the AM peak hour are shown in Table 6-1 and the PM peak hour volumes are shown in Table 6-2.

Table 6-1 Future Year (2045) No Project Volumes – AM Peak Hour

ID	Intersection	Northbound			Southbound			Eastbound			Westbound		
		L	T	R	L	T	R	L	T	R	L	T	R
1	Euclid Street and Bolsa Avenue	103	870	149	200	1785	101	252	937	177	190	606	194
2	Euclid Street and McFadden Avenue	162	1227	146	148	2062	171	255	521	323	151	335	127
3	Euclid Street and Edinger Avenue	127	801	68	168	2442	224	160	700	428	125	761	139
4	Newhope Street and Hazard Avenue	78	590	84	88	1302	119	108	276	204	119	397	159
5	Newhope Street and McFadden Avenue	77	342	120	122	1213	113	135	492	160	190	484	108
6	Harbor Boulevard and SR-22 WB Off-Ramp / Banner Drive	84	1534	0	0	1465	19	81	0	133	836	44	117
7	Trask Avenue and SR-22 EB On-Ramp	0	0	0	0	0	0	713	893	0	0	852	159
8	Harbor Boulevard and Westminster Avenue	178	1173	251	258	2021	115	192	1010	36	415	1124	306
9	Harbor Boulevard and 1st Street	95	756	163	236	1989	129	138	919	178	196	497	116
10	Harbor Boulevard and McFadden Avenue	104	1059	101	190	2004	67	177	462	138	138	311	89
11	Harbor Boulevard and Edinger Avenue	103	772	146	204	2349	68	123	743	373	191	424	176
12	Harbor Boulevard and Warner Avenue	109	665	169	429	1933	116	101	1440	379	138	723	122
13	Harbor Boulevard and Segerstrom Avenue	107	759	48	169	2274	85	82	689	278	140	434	98
14	Hyland Avenue / OCTA Bus Base and MacArthur Boulevard	86	4	24	8	2	19	7	1934	767	68	517	21
15	Harbor Boulevard and MacArthur Boulevard	131	920	94	295	1701	118	131	1183	357	128	427	127
16	Harbor Boulevard and Sunflower Avenue	221	1128	209	233	2204	54	13	153	59	139	178	101
17	Harbor Boulevard and I-405 NB Off-Ramp	0	1915	0	0	1978	0	0	0	0	399	0	702
18	Harbor Boulevard and I-405 SB Off-Ramp	0	1963	0	0	1253	0	475	0	529	0	0	0
19	Fairview Street and Civic Center Drive	7	1569	508	332	1915	8	7	25	25	100	3	52
20	Fairview Street and 1st Street	200	1538	289	245	1426	164	200	1153	179	120	539	181

ID	Intersection	Northbound			Southbound			Eastbound			Westbound		
		L	T	R	L	T	R	L	T	R	L	T	R
21	Fairview Street and McFadden Avenue	141	1510	202	154	1878	136	221	522	120	147	380	30
22	Fairview Street and Edinger Avenue	200	883	123	223	1558	132	361	1002	268	421	553	110
23	Fairview Street and Warner Avenue	222	981	129	194	1543	113	68	991	295	267	807	261
24	Fairview Street and MacArthur Boulevard	261	811	94	290	1460	163	121	984	145	235	494	140
25	Fairview Road and Sunflower Avenue	185	1071	163	191	1627	104	49	322	65	357	299	154
26	Greenville Street and Edinger Avenue	186	0	251	0	0	0	0	1821	444	153	813	0
27	Greenville Street and Segerstrom Avenue	47	193	78	154	472	160	46	1035	165	190	768	88
28	Raitt Street and McFadden Avenue	67	618	98	123	938	128	122	743	95	146	461	82
29	Raitt Street and Edinger Avenue	197	524	189	163	770	91	324	1980	285	122	954	56
30	Bear Street and MacArthur Boulevard	71	245	104	199	756	300	92	1581	108	62	1041	88
31	Bristol Street and 17th Street	251	1292	218	487	2001	263	324	963	156	368	845	280
32	Bristol Street and Civic Center Drive	133	1178	104	403	1628	101	165	836	103	127	421	87
33	Bristol Street and Santa Ana Boulevard	69	1502	209	153	1684	46	171	831	72	185	462	79
34	Bristol Street and 1st Street	205	1430	181	315	1298	183	200	1231	124	90	678	99
35	Bristol Street and McFadden Avenue	125	1117	56	204	1986	205	309	531	261	262	729	84
36	Bristol Street and Warner Avenue	221	993	183	600	2033	230	165	919	229	231	1058	180
37	Bristol Street and Segerstrom Avenue	70	778	146	283	1011	119	280	1354	125	134	607	78
38	Bristol Street and Alton Avenue	11	739	55	230	1591	36	164	101	211	41	87	31
39	Bristol Street and MacArthur Boulevard	102	531	133	329	1434	150	166	1203	244	159	758	110
40	Bristol Street and Sunflower Avenue	111	546	161	242	1370	103	112	926	375	295	480	166
41	Bristol Street and I-405 NB Ramps	0	1638	210	0	1918	8	0	0	36	145	87	796
42	Bristol Street and I-405 SB Ramps	125	1225	0	0	1030	886	696	0	636	0	0	0
43	Flower Street and Santa Ana Boulevard	100	936	136	214	723	97	211	1315	150	143	458	191
44	Flower Street and 1st Street	139	602	159	334	1058	111	148	1355	54	209	861	123
45	Flower Street and McFadden Avenue	70	511	44	118	655	95	112	1278	97	113	764	103
46	Flower Street and Segerstrom Avenue	86	451	100	98	544	120	223	1531	427	104	764	84
47	Flower Street and MacArthur Boulevard	26	170	88	167	361	270	151	1716	73	62	1049	67
48	Main Street and	105	724	375	198	1034	173	361	510	222	316	276	230

Santa Ana General Plan Update Traffic Impact Study – Final Draft

ID	Intersection	Northbound			Southbound			Eastbound			Westbound		
		L	T	R	L	T	R	L	T	R	L	T	R
	La Veta Avenue												
49	Main Street and Mainplace Drive / Memory Lane	34	920	301	36	1386	290	185	291	20	132	151	10
50	Main Street and 17th Street	133	788	169	237	1322	85	127	1336	67	356	1425	21
51	Main Street and Civic Center Drive	142	925	81	55	970	148	120	727	132	43	566	34
52	Main Street and Santa Ana Boulevard	66	1050	0	0	1135	100	0	0	0	90	1250	96
53	Main Street and 4th Street	0	939	22	0	961	24	0	70	11	0	140	34
54	Main Street and 1st Street	103	532	54	77	772	57	106	1241	131	86	1072	60
55	Main Street and McFadden Avenue	93	874	44	162	1259	25	86	815	89	164	438	126
56	Main Street and Edinger Avenue	99	561	61	211	975	51	96	1248	168	108	630	77
57	Main Street and MacArthur Boulevard	51	295	250	539	709	160	230	1336	242	138	411	206
58	Penn Way and 17th Street	52	0	260	0	0	0	0	1341	684	214	1722	0
59	Santiago Street / I-5 NB Ramps and 17th Street	720	33	21	54	0	279	89	932	337	0	1245	20
60	Penn Way and I-5 SB Ramps	0	260	230	951	196	0	0	0	0	196	0	110
61	Santiago Street and Civic Center Drive	487	338	47	10	590	144	182	69	369	108	99	20
62	Santiago Street and Santa Ana Boulevard	188	611	303	409	972	253	118	732	99	297	699	258
63	Standard Avenue and 4th Street	191	473	248	431	604	332	298	624	219	250	550	340
64	Standard Avenue and 1st Street	45	631	312	123	901	41	161	1,959	121	194	1,282	120
65	Standard Avenue and McFadden Avenue	94	360	162	226	547	38	34	1178	142	150	397	89
66	Halladay Street and Warner Avenue	95	0	220	0	0	0	0	1833	207	260	986	0
67	Halladay Street and Dyer Road	15	24	65	450	91	96	46	1537	11	104	566	91
68	SR-55 SB Ramps and MacArthur Boulevard	0	0	0	998	0	903	0	1349	961	0	1187	135
69	SR-55 NB Ramps and MacArthur Boulevard	946	0	1017	0	0	0	0	1468	726	0	517	244
70	SR-55 SB Ramps and Dyer Road	286	34	654	50	242	60	37	1422	303	348	552	92
71	Glassell Street and La Veta Avenue	263	412	125	14	295	65	57	293	563	367	387	9
72	Glassell Street and SR-22 WB Ramps	511	574	0	0	1017	473	0	0	0	323	6	483
73	Glassell Street / Grand Avenue and SR-22 EB Ramps	0	918	245	373	977	0	270	0	1058	0	0	0
74	Grand Avenue and Fairhaven Avenue	21	840	121	207	1,718	38	99	60	59	213	24	192
75	Grand Avenue and Santa Clara Avenue	75	528	136	345	1,687	380	143	233	48	200	385	352
76	Grand Avenue and 17th Street	186	543	373	340	1,426	280	198	739	94	342	894	98

Santa Ana General Plan Update Traffic Impact Study – Final Draft

ID	Intersection	Northbound			Southbound			Eastbound			Westbound		
		L	T	R	L	T	R	L	T	R	L	T	R
77	Grand Avenue and I-5 NB Ramps	0	1056	610	90	2893	0	0	0	0	507	0	140
78	Grand Avenue and Santa Ana Boulevard	49	694	35	202	1670	1473	268	221	436	6	475	43
79	Grand Avenue and 1st Street	208	732	34	99	1432	174	436	1041	295	216	759	87
80	Grand Avenue and Chestnut Avenue	53	737	163	161	1937	53	34	239	63	130	384	239
81	Grand Avenue and McFadden Avenue	181	764	114	249	1672	163	205	663	201	123	440	111
82	Grand Avenue and Edinger Avenue	47	472	92	243	1244	243	347	1447	139	189	724	158
83	Grand Avenue and Warner Avenue	142	429	184	183	528	178	333	1188	467	92	406	137
84	SR-55 NB Ramps and Dyer Road	610	0	499	0	0	0	0	1618	647	0	599	361
85	Cambridge Street and La Veta Avenue	185	235	0	0	480	245	273	0	436	0	0	0
86	Cambridge Street and Fairhaven Avenue	0	0	0	567	0	183	80	216	0	0	195	152
87	Mabury Street and 1st Street	6	0	157	248	147	554	0	1230	13	38	579	0
88	Tustin Street and La Veta Avenue	7	301	87	67	1307	4	9	11	35	307	1	47
89	Tustin Street and SR-22 WB On-Ramp	614	571	0	0	1171	699	0	0	0	0	0	0
90	Tustin Street and SR-22 EB Off-Ramp / Seba Avenue	0	953	5	17	1049	0	275	27	1182	6	0	43
91	Tustin Street and Fairhaven Avenue	101	586	103	280	2,411	48	84	317	546	416	460	601
92	Tustin Avenue and Santa Clara Avenue	83	453	84	151	3,094	98	335	847	618	160	332	166
93	Tustin Avenue and 17th Street	127	226	269	716	2,067	23	621	2,450	418	664	1,047	256
94	Tustin Avenue and 4th Street	80	408	365	601	765	237	126	748	31	125	704	457
95	SR-55 SB Ramps / Auto Mall Drive and Edinger Avenue	456	68	540	50	30	8	36	1426	527	510	1202	157
96	SR-55 NB Ramps / Del Amo Avenue and Newport Avenue	392	104	66	21	512	750	269	163	155	8	223	4
97	Red Hill Avenue and Edinger Avenue	101	374	106	195	828	388	397	1276	271	255	1234	173
98	Red Hill Avenue and Warner Avenue	68	414	56	20	935	188	273	464	342	120	427	76
99	Red Hill Avenue and Barranca Parkway	152	379	125	163	719	94	124	748	296	511	571	111
100	Red Hill Avenue and Alton Parkway	225	663	415	212	962	154	158	490	490	342	290	163
101	Red Hill Avenue and MacArthur Boulevard	83	742	13	186	481	441	1153	596	98	32	308	789
102	Red Hill Avenue and Main Street	201	691	449	56	261	90	139	1309	254	154	309	73
103	I-5 SB Ramps and Santa Ana Boulevard	0	0	0	382	0	38	332	569	0	0	1267	370

ID	Intersection	Northbound			Southbound			Eastbound			Westbound		
		L	T	R	L	T	R	L	T	R	L	T	R
104	Tustin Ranch Road and Warner Avenue	0	0	0	141	0	18	27	357	0	0	2130	490
105	Von Karman Avenue and Barranca Parkway	401	533	319	104	1021	446	219	823	275	902	1482	46

Table 6-2 Future Year (2045) No Project Volumes – PM Peak Hour

ID	Intersection	Northbound			Southbound			Eastbound			Westbound		
		L	T	R	L	T	R	L	T	R	L	T	R
1	Euclid Street and Bolsa Avenue	169	1569	126	152	866	164	212	678	106	209	877	209
2	Euclid Street and McFadden Avenue	242	1973	127	96	1179	143	207	475	210	114	479	221
3	Euclid Street and Edinger Avenue	539	1610	115	136	897	228	141	544	163	128	1181	191
4	Newhope Street and Hazard Avenue	105	1159	45	46	982	117	75	148	91	88	556	160
5	Newhope Street and McFadden Avenue	188	1009	177	140	625	121	61	372	54	104	574	164
6	Harbor Boulevard and SR-22 WB Off-Ramp / Banner Drive	109	2457	0	0	1801	58	102	0	86	576	78	165
7	Trask Avenue and SR-22 EB On-Ramp	0	0	0	0	0	0	927	695	0	0	786	74
8	Harbor Boulevard and Westminster Avenue	237	1178	279	254	1752	202	215	768	37	357	1238	281
9	Harbor Boulevard and 1st Street	290	1497	166	245	1073	145	179	730	138	199	929	151
10	Harbor Boulevard and McFadden Avenue	169	1737	127	256	1094	99	241	585	73	198	474	137
11	Harbor Boulevard and Edinger Avenue	254	1597	193	290	843	77	109	460	81	196	1138	379
12	Harbor Boulevard and Warner Avenue	762	3656	275	262	1457	174	217	1539	352	249	2589	827
13	Harbor Boulevard and Segerstrom Avenue	273	1717	55	87	986	87	118	585	192	117	1269	461
14	Hyland Avenue / OCTA Bus Base and MacArthur Boulevard	1201	7	70	12	4	14	36	891	160	25	2350	12
15	Harbor Boulevard and MacArthur Boulevard	558	1441	83	204	1028	169	140	489	181	81	1373	258
16	Harbor Boulevard and Sunflower Avenue	154	1532	228	114	1417	43	81	220	229	301	632	236
17	Harbor Boulevard and I-405 NB Off-Ramp	0	1529	0	0	2570	0	0	0	0	496	0	801
18	Harbor Boulevard and I-405 SB Off-Ramp	0	1881	0	0	2281	0	177	0	815	0	0	0
19	Fairview Street and Civic Center Drive	6	1690	475	192	1784	0	2	6	4	424	0	157
20	Fairview Street and 1st Street	169	1241	112	236	1468	291	193	781	136	140	1060	164
21	Fairview Street and McFadden Avenue	164	1507	131	191	1553	242	158	427	106	158	545	134
22	Fairview Street and Edinger Avenue	184	1759	108	204	635	156	205	628	168	650	1375	302
23	Fairview Street and Warner Avenue	213	1695	158	182	921	93	168	815	126	168	989	214
24	Fairview Street and MacArthur Boulevard	225	1550	84	171	955	88	240	627	211	167	1272	223
25	Fairview Road and Sunflower Avenue	192	1725	375	140	1162	81	262	555	123	227	569	148

Santa Ana General Plan Update Traffic Impact Study – Final Draft

ID	Intersection	Northbound			Southbound			Eastbound			Westbound		
		L	T	R	L	T	R	L	T	R	L	T	R
26	Greenville Street and Edinger Avenue	293	0	195	0	0	0	0	1061	216	153	1811	0
27	Greenville Street and Segerstrom Avenue	50	414	31	52	171	52	127	967	55	37	1414	202
28	Raitt Street and McFadden Avenue	61	872	136	51	533	86	108	640	56	98	827	114
29	Raitt Street and Edinger Avenue	171	736	206	114	396	99	125	862	123	192	2171	194
30	Bear Street and MacArthur Boulevard	273	1314	343	115	278	84	80	753	78	67	1211	193
31	Bristol Street and 17th Street	375	1823	303	337	1794	305	238	530	96	311	1170	396
32	Bristol Street and Civic Center Drive	222	1550	81	159	1458	149	195	549	65	184	789	89
33	Bristol Street and Santa Ana Boulevard	84	1702	97	117	1558	59	155	428	100	392	624	168
34	Bristol Street and 1st Street	392	1693	250	223	1209	273	160	900	115	196	1204	114
35	Bristol Street and McFadden Avenue	224	1649	90	111	1554	358	245	478	95	209	1088	127
36	Bristol Street and Warner Avenue	316	1182	216	338	1128	219	176	791	140	251	1481	434
37	Bristol Street and Segerstrom Avenue	182	1347	237	101	927	194	224	803	64	145	1313	66
38	Bristol Street and Alton Avenue	43	1681	158	116	870	54	25	35	65	91	150	29
39	Bristol Street and MacArthur Boulevard	321	1369	249	233	858	135	335	746	158	236	1370	259
40	Bristol Street and Sunflower Avenue	651	1376	222	215	804	230	301	588	228	247	952	303
41	Bristol Street and I-405 NB Ramps	0	2094	183	0	2375	22	0	0	204	350	300	1162
42	Bristol Street and I-405 SB Ramps	128	1570	0	0	1611	942	740	0	331	0	0	0
43	Flower Street and Santa Ana Boulevard	198	1206	99	87	442	40	357	1029	168	186	649	192
44	Flower Street and 1st Street	224	1063	253	200	549	159	102	895	74	210	1415	147
45	Flower Street and McFadden Avenue	91	1234	76	46	352	57	124	928	37	93	1159	166
46	Flower Street and Segerstrom Avenue	122	859	82	84	469	135	203	1011	107	92	1545	99
47	Flower Street and MacArthur Boulevard	130	621	72	93	224	215	199	947	60	62	1989	177
48	Main Street and La Veta Avenue	347	1059	496	164	1031	266	327	466	209	282	563	226
49	Main Street and Mainplace Drive / Memory Lane	113	1186	225	52	1083	143	391	433	116	278	227	110
50	Main Street and 17th Street	197	1019	222	222	969	150	224	1256	74	199	1220	81
51	Main Street and Civic Center Drive	92	1169	98	52	853	54	239	1322	158	38	384	39
52	Main Street and Santa Ana Boulevard	51	1152	0	0	1083	53	0	0	0	92	924	120
53	Main Street and 4th Street	0	950	45	0	864	39	0	70	39	0	229	58

Santa Ana General Plan Update Traffic Impact Study – Final Draft

ID	Intersection	Northbound			Southbound			Eastbound			Westbound		
		L	T	R	L	T	R	L	T	R	L	T	R
54	Main Street and 1st Street	152	745	65	146	559	119	116	1172	87	111	1244	87
55	Main Street and McFadden Avenue	132	1037	64	123	834	61	182	805	98	133	752	338
56	Main Street and Edinger Avenue	101	1069	49	129	646	88	118	698	78	102	1364	141
57	Main Street and MacArthur Boulevard	446	1067	293	265	345	260	313	643	62	193	1529	444
58	Penn Way and 17th Street	1113	0	543	0	0	0	0	1672	539	123	1440	0
59	Santiago Street / I-5 NB Ramps and 17th Street	330	44	17	50	0	130	114	1047	688	0	1564	42
60	Penn Way and I-5 SB Ramps	0	631	414	592	137	0	0	0	0	214	0	183
61	Santiago Street and Civic Center Drive	194	598	60	32	456	117	266	76	269	14	19	18
62	Santiago Street and Santa Ana Boulevard	135	833	236	378	639	103	164	673	87	255	546	347
63	Standard Avenue and 4th Street	251	543	214	254	428	297	302	477	201	233	648	351
64	Standard Avenue and 1st Street	109	724	259	142	679	47	168	1,279	65	264	1,888	116
65	Standard Avenue and McFadden Avenue	194	765	94	237	520	90	95	632	108	123	749	217
66	Halladay Street and Warner Avenue	338	0	704	0	0	0	2	868	87	272	2159	0
67	Halladay Street and Dyer Road	61	266	307	296	39	83	147	1271	9	51	1655	132
68	SR-55 SB Ramps and MacArthur Boulevard	0	0	0	299	0	724	0	1187	1058	0	1474	579
69	SR-55 NB Ramps and MacArthur Boulevard	620	0	412	0	0	0	0	711	731	0	1467	1056
70	SR-55 SB Ramps and Dyer Road	386	12	291	103	226	110	59	1379	187	566	1008	65
71	Glassell Street and La Veta Avenue	573	595	194	14	471	35	106	346	594	211	382	15
72	Glassell Street and SR-22 WB Ramps	660	1079	0	0	1007	293	0	0	0	251	9	446
73	Glassell Street / Grand Avenue and SR-22 EB Ramps	0	1450	370	461	824	0	229	4	503	0	0	0
74	Grand Avenue and Fairhaven Avenue	54	1,420	284	242	974	89	79	45	33	221	42	157
75	Grand Avenue and Santa Clara Avenue	103	1,386	288	240	946	240	114	139	26	157	282	300
76	Grand Avenue and 17th Street	288	1,026	259	294	634	140	321	823	138	279	1,031	187
77	Grand Avenue and I-5 NB Ramps	0	1855	1432	62	1501	0	0	0	0	151	0	182
78	Grand Avenue and Santa Ana Boulevard	185	2091	34	38	839	595	377	230	363	34	228	165
79	Grand Avenue and 1st Street	188	1435	43	113	667	266	326	1080	107	154	958	176
80	Grand Avenue and Chestnut Avenue	152	1142	198	161	716	121	70	214	47	139	433	252
81	Grand Avenue and McFadden Avenue	222	1264	218	153	696	187	122	454	79	96	762	168

Santa Ana General Plan Update Traffic Impact Study – Final Draft

ID	Intersection	Northbound			Southbound			Eastbound			Westbound		
		L	T	R	L	T	R	L	T	R	L	T	R
82	Grand Avenue and Edinger Avenue	244	1411	122	203	501	281	182	787	63	93	1673	217
83	Grand Avenue and Warner Avenue	183	660	146	140	452	208	306	587	127	241	1539	504
84	SR-55 NB Ramps and Dyer Road	181	0	49	0	0	0	0	1183	602	0	1488	929
85	Cambridge Street and La Veta Avenue	235	327	0	0	206	191	375	0	247	0	0	0
86	Cambridge Street and Fairhaven Avenue	0	0	0	219	0	76	132	230	0	0	237	295
87	Mabury Street and 1st Street	23	0	233	195	83	367	0	1334	21	40	549	0
88	Tustin Street and La Veta Avenue	38	863	205	79	701	13	13	5	20	146	4	90
89	Tustin Street and SR-22 WB On-Ramp	466	1340	0	0	573	294	0	0	0	0	0	0
90	Tustin Street and SR-22 EB Off-Ramp / Seba Avenue	0	1416	4	40	550	0	440	39	558	28	0	67
91	Tustin Street and Fairhaven Avenue	280	1,492	132	356	940	108	89	200	163	100	220	208
92	Tustin Avenue and Santa Clara Avenue	191	923	142	199	1,574	109	72	227	133	133	166	157
93	Tustin Avenue and 17th Street	253	1,083	557	377	404	40	524	1,029	139	243	798	444
94	Tustin Avenue and 4th Street	28	299	97	459	339	124	208	743	38	118	798	491
95	SR-55 SB Ramps / Auto Mall Drive and Edinger Avenue	401	32	423	110	50	37	47	1677	472	468	1220	146
96	SR-55 NB Ramps / Del Amo Avenue and Newport Avenue	879	262	51	17	209	803	156	54	32	23	348	16
97	Red Hill Avenue and Edinger Avenue	204	1469	233	105	209	169	410	1051	128	90	1161	567
98	Red Hill Avenue and Warner Avenue	374	1281	147	79	304	385	246	668	104	76	1598	210
99	Red Hill Avenue and Barranca Parkway	338	1270	327	241	408	192	172	637	84	110	839	245
100	Red Hill Avenue and Alton Parkway	26	1458	211	122	519	4	434	1065	545	1299	222	801
101	Red Hill Avenue and MacArthur Boulevard	175	1133	14	315	654	1148	499	230	35	39	810	568
102	Red Hill Avenue and Main Street	436	941	254	88	640	348	200	714	193	277	1575	88
103	I-5 SB Ramps and Santa Ana Boulevard	0	0	0	304	0	67	765	865	0	0	621	170
104	Tustin Ranch Road and Warner Avenue	0	0	0	553	0	38	65	2154	0	0	856	369
105	Von Karman Avenue and Barranca Parkway	346	1992	434	80	407	280	765	1397	195	232	734	250

6.1 FUTURE YEAR (2045) NO PROJECT VEHICLE MILES TRAVELED (VMT)

Table 7-6 presents the VMT analysis results for the Future Year (2045) No Project scenario. VMT calculations are based on the scenario parameters and methodology as described in Sections 2.6 and 3.1, respectively.

Table 6-3 Future Year (2045) VMT Summary

	I – I VMT	I – X VMT	X – I VMT	Total VMT	Service Population	VMT/SP
City	692,704	5,737,798	5,733,292	12,163,794	534,238	22.8
County	52,994,916	29,554,879	29,660,308	112,210,103	4,221,830	26.6

SP = Service Population = Total Employees + Total Population. Reduction factor applied to Total Employees as noted in Section 3.1 and shown in Appendix F. I-I = Internal-Internal; I-X = Internal-External; X-I = External-Internal.

6.2 ROADWAY SEGMENT LEVEL OF SERVICE

A summary of the forecast roadway segment volumes and corresponding level of service results for the future year 2045 No Project condition is shown in Table 6-4. The following roadway segments are forecast to operate at a deficient LOS:

- Segment 8 – Harbor Boulevard from Segerstrom Avenue to MacArthur Boulevard
- Segment 23 – Main Street from 1st Street to Bishop Street
- Segment 39 – Bristol Street from Edinger Avenue to Warner Avenue
- Segment 43 – Flower Street from Warner Avenue to Segerstrom Avenue
- Segment 45 – Main Street from McFadden Avenue to Edinger Avenue
- Segment 52 – Edinger Avenue from Richie Street to Newport Avenue
- Segment 57 – Dyer Road from Grand Avenue to Pullman Street
- Segment 58 – McFadden Avenue from Bristol Street to Flower Street
- Segment 62 – Fourth Street from French Street to Standard Avenue
- Segment 63 – Broadway from 17th Street to Civic Center Drive
- Segment 72 – McFadden Avenue from Main Street to Standard Avenue
- Segment 73 – Penn Way/Santiago Street from I-5 SB Ramps to Santa Ana Boulevard
- Segment 74 – Raitt Street from Santa Ana Boulevard to 1st Street
- Segment 84 – Dyer Road from Pullman Street to Red Hill Avenue

Table 6-4 Future Year (2045) No Project Roadway Segment LOS

ID	Street	Segment	Lanes	ADT	LOS
1	1st Street	Euclid Street to Ward Street	6D	21,700	A
2	Euclid Street	1st Street to McFadden Avenue	6D	35,900	B
3	Westminster Avenue	Harbor Boulevard to Fairview Street	6D	25,400	A
4	Harbor Boulevard	Westminster Avenue/17th Street to Hazard Avenue	6D	41,100	C
5	1st Street	Harbor Boulevard to Jackson	6D	23,700	A
6	Edinger Avenue	Harbor Boulevard to Fairview Street	6D	23,300	A
7	Warner Avenue	Harbor Boulevard to Fairview Street	6D	28,500	A
8	Harbor Boulevard	Segerstrom Avenue to MacArthur Boulevard	6D	59,600	F
9	Fairview Street	1st Street to Willits Street	6D	38,800	B
10	1st Street	Sullivan Street to Raitt Street	6D	24,400	A
11	Bristol Street	17th Street to Santa Clara Avenue	6D	43,200	C
12	17th Street	College Avenue to Bristol Street	6D	30,800	A
13	Bristol Street	17th Street to Washington Avenue	6D	47,300	D
14	Fairview Street	Trask Avenue to 17th Street	6D	47,400	D
15	Bristol Street	1st Street to Bishop Street	6D	45,500	D
16	Civic Center Drive	Bristol Street to Flower Street	4U	18,400	C
17	Flower Street	1st Street to Bishop Street	4U	9,400	A
18	Main Street	17th Street to 20th Street	6D	40,800	C
19	Main Street	Washington Street to Civic Center Drive	4U	16,600	B
20	Civic Center Drive	Flower Street to Ross Street	4U	10,200	A
21	Santa Ana Boulevard	Flower Street to Ross Street	6D	22,200	A
22	1st Street	Main Street to Standard Avenue	6D	38,200	B
23	Main Street	1st Street to Bishop Street	4U	29,400	F
24	Grand Avenue	Santa Clara Avenue to Fairhaven Street	6D	31,200	A
25	Grand Avenue	Santa Ana Boulevard to 4th Street	6D	24,600	A
26	Santa Clara Avenue	Grand Avenue to Tustin Avenue	4U	10,800	A
27	Tustin Avenue	Santa Clara Avenue to Fairhaven Street	6D	23,400	A
28	17th Street	Cabrillo Park Drive to Tustin Avenue	6D	32,700	A
29	Tustin Avenue	Fruit Street to 4th Street	6D	22,100	A
30	1st Street	Grand Avenue to Elk Lane	6D	29,300	A
31	1st Street	Cabrillo Park Drive to Tustin Avenue	6D	15,600	A
32	Fairview Street	Edinger Avenue to Harvard Street	6D	46,200	D
33	Fairview Street	Warner Avenue to Segerstrom Avenue	6D	43,200	C
34	MacArthur Boulevard	Harbor Boulevard to Fairview Street	6D	33,500	A
35	Edinger Avenue	Fairview Street to Greenville Street	6D	20,400	A
36	McFadden Avenue	Fairview Street to Raitt Street	4U	20,000	D
37	MacArthur Boulevard	Fairview Street to Raitt Street	6D	29,700	A
38	Segerstrom Avenue	Fairview Street to Raitt Street	6D	26,300	A
39	Bristol Street	Edinger Avenue to Warner Avenue	6D	53,500	E
40	Bristol Street	Warner Avenue to Segerstrom Avenue	6D	45,100	D

ID	Street	Segment	Lanes	ADT	LOS
41	Warner Avenue	Raitt Street to Bristol Street	6D	22,600	A
42	Bristol Street	MacArthur Boulevard to Sunflower Avenue	6D	49,100	D
43	Flower Street	Warner Avenue to Segerstrom Avenue	4D	36,200	E
44	Edinger Avenue	Flower Street to Main Street	6D	23,200	A
45	Main Street	McFadden Avenue to Edinger Avenue	4U	25,100	F
46	Main Street	Edinger Avenue to Warner Avenue	5D	34,400	C
47	Main Street	Warner Avenue to Dyer Road	6D	36,700	B
48	Segerstrom Avenue	Bristol Street to Flower Street	6D	24,400	A
49	MacArthur Boulevard	Flower Street to Main Street	6D	35,400	B
50	Main Street	MacArthur Boulevard to Sunflower Avenue	6D	26,300	A
51	Grand Avenue	Edinger Avenue to Warner Avenue	6D	34,100	B
52	Edinger Avenue	Richie Street to Newport Avenue	6D	52,800	E
53	Warner Avenue	Grand Avenue to Red Hill Avenue	6D	31,800	A
54	Warner Avenue	Main Street to Standard Avenue	6D	22,700	A
55	McFadden Avenue	Newhope Street to Harbor Boulevard	4U	13,800	A
56	McFadden Avenue	Standard Avenue to Grand Avenue	4U	16,100	B
57	Dyer Road	Grand Avenue to Pullman Street	6D	73,900	F
58	McFadden Avenue	Bristol Street to Flower Street	4U	23,300	E
59	Main Street	La Veta Avenue to Memory Lane	8D	48,800	B
60	1st Street	Bristol Street to Flower Street	6D	26,600	A
61	Fairhaven Avenue	Grand Avenue to Tustin Avenue	4D	13,500	A
62	4th Street	French Street to Standard Avenue	4U	22,800	E
63	Broadway	17th Street to Civic Center Drive	4U	29,600	F
64	Broadway	Civic Center Drive to 1st Street	4U	12,200	A
65	Cambridge Street	SR-22 to Fairhaven Avenue	4U	9,200	A
66	Chestnut Avenue	Standard Avenue to Lyon Street	4U	11,900	A
67	Civic Center Drive	French Street to Santiago Street	4U	2,100	A
68	Civic Center Drive	Fairview Road to Bristol Street	4U	20,300	D
69	Flower Street	Edinger Avenue to Warner Avenue	4U	13,300	A
70	Halladay Avenue	Warner Avenue to Dyer Road	4U	22,100	D
71	Hazard Avenue	Euclid Street to Harbor Boulevard	4U	15,400	B
72	McFadden Avenue	Main Street to Standard Avenue	4U	24,700	E
73	Penn Way/Santiago Street	I-5 SB Ramps to Santa Ana Boulevard	4U	26,300	F
74	Raitt Street	Santa Ana Boulevard to 1st Street	4U	23,100	E
75	Raitt Street	Warner Avenue to Segerstrom Avenue	4U	20,000	D
76	Santa Ana Boulevard	French Street to Santiago Street	4D	16,500	A
77	Santa Ana Boulevard	Raitt Street to Bristol Street	6D	27,000	A
78	Standard Avenue	Chestnut Avenue to McFadden Avenue	4U	19,600	C
79	Standard Avenue	Edinger Avenue to Warner Avenue	4U	18,200	C
80	Greenville Street	Edinger Avenue to Warner Avenue	2U	6,600	A
81	Greenville Street	Warner Avenue to Segerstrom Avenue	4D	8,400	A
82	Flower Street	17th Street to Northern Terminus	2D	5,900	A

ID	Street	Segment	Lanes	ADT	LOS
83	Logan Street	Civic Center Drive to Santa Ana Boulevard	2U	- *	-
84	Dyer Road	Pullman Street to Red Hill Avenue	6D	58,000	F
85	Fairhaven Avenue	Tustin Street to Yorba Street	4U	17,214	B
86	Santa Clara Avenue	Tustin Street to Yorba Street	4U	9,004	A
87	Harbor Boulevard	McFadden Avenue to Edinger Avenue	6D	36,400	B
88	Harbor Boulevard	Edinger Avenue to Warner Avenue	6D	44,900	C

Notes:

* Not available.

(1) ADT – Average Daily Traffic Volumes

(2) LOS – Level of Service

(3) #D – total number of lanes in both directions divided by raised or striped median; #U – total number of undivided lanes in both directions.

(4) Roadway capacities shown in Table 3-1.

6.3 INTERSECTION LEVEL OF SERVICE

A summary of the AM and PM peak hour level of service analysis results for the Future Year (2045) No Project condition is provided in Table 6-5. Intersections are considered unacceptable if the level of service (LOS) is “E” or “F”. It should be noted that Caltrans and CMP intersection have a minimum LOS of C and E, respectively. The following intersections are forecast to have unacceptable level of service in the Future Year (2045) No Project condition:

- INT 2 – Euclid Street and McFadden Avenue (City of Santa Ana)
- INT 3 – Euclid Street and Edinger Avenue (City of Fountain Valley)
- INT 8 – Harbor Boulevard and Westminster Avenue (City of Garden Grove / City of Santa Ana)
- INT 12 – Harbor Boulevard and Warner Avenue (City of Santa Ana – CMP)
- INT 13 – Harbor Boulevard and Segerstrom Avenue (City of Santa Ana)
- INT 14 – Hyland Avenue and MacArthur Boulevard (City of Costa Mesa)
- INT 22 – Fairview Street and Edinger Avenue (City of Santa Ana)
- INT 29 – Raitt Street and Edinger Avenue (City of Santa Ana)
- INT 32 – Bristol Street and Civic Center Drive (City of Santa Ana)
- INT 35 – Bristol Street and McFadden Avenue (City of Santa Ana)
- INT 36 – Bristol Street and Warner Avenue (City of Santa Ana)
- INT 44 – Flower Street and 1st Street (City of Santa Ana)
- INT 45 – Flower Street and McFadden Avenue (City of Santa Ana)
- INT 51 – Main Street and Civic Center Drive (City of Santa Ana)
- INT 52 – Main Street and Santa Ana Boulevard (City of Santa Ana)
- INT 55 – Main Street and McFadden Avenue (City of Santa Ana)
- INT 61 – Santiago Street and Civic Center Drive (City of Santa Ana)
- INT 62 – Santiago Street and Santa Ana Boulevard (City of Santa Ana)

- INT 63 – Standard Avenue and 4th Street (City of Santa Ana)
- INT 64 – Standard Avenue and 1st Street (City of Santa Ana)
- INT 66 – Halladay Street and Warner Avenue (City of Santa Ana)
- INT 67 – Halladay Street and Dyer Road (City of Santa Ana)
- INT 82 – Grand Avenue and Edinger Avenue (City of Santa Ana)
- INT 91 – Tustin Street and Fairhaven Avenue (City of Orange)
- INT 92 – Tustin Avenue and Santa Clara Avenue (City of Santa Ana)
- INT 93 – Tustin Avenue and 17th Street (City of Santa Ana)
- INT 96 – SR-55 NB Ramps / Del Amo Avenue and Newport Avenue (Caltrans)
- INT 100 – Red Hill Avenue and Alton Parkway (City of Irvine)
- INT 105 – Von Karman Avenue and Barranca Parkway (City of Irvine)

Table 6-5: Future Year (2045) No Project Intersection LOS Summary

ID	INTERSECTION	AM		PM	
		V/C or Delay	LOS	V/C or Delay	LOS
1	Euclid Street and Bolsa Avenue	0.86	D	0.86	D
2	Euclid Street and McFadden Avenue	0.98	E	0.90	D
3	Euclid Street and Edinger Avenue	0.99	E	0.89	D
4	Newhope Street and Hazard Avenue	0.78	C	0.72	C
5	Newhope Street and McFadden Avenue	0.83	D	0.78	C
6	Harbor Boulevard and SR-22 WB Off-Ramp / Banner Drive	28.4	C	24.2	C
7	Trask Avenue and SR-22 EB On-Ramp	12.0	B	13.6	B
8	Harbor Boulevard and Westminster Avenue	0.99	E	0.88	D
9	Harbor Boulevard and 1st Street	0.79	C	0.78	C
10	Harbor Boulevard and McFadden Avenue	0.79	C	0.81	D
11	Harbor Boulevard and Edinger Avenue	0.84	D	0.73	C
12	Harbor Boulevard and Warner Avenue	0.79	C	1.54	F
13	Harbor Boulevard and Segerstrom Avenue	0.97	E	0.92	E
14	Hyland Avenue / OCTA Bus Base and MacArthur Boulevard	0.61	B	0.92	E
15	Harbor Boulevard and MacArthur Boulevard	0.74	C	0.78	C
16	Harbor Boulevard and Sunflower Avenue	0.70	B	0.72	C
17	Harbor Boulevard and I-405 NB Off-Ramp	18.0	B	18.3	B
18	Harbor Boulevard and I-405 SB Off-Ramp	15.0	B	17.9	B
19	Fairview Street and Civic Center Drive	0.74	C	0.76	C
20	Fairview Street and 1st Street	0.86	D	0.90	D
21	Fairview Street and McFadden Avenue	0.80	C	0.78	C
22	Fairview Street and Edinger Avenue	0.86	D	0.92	E
23	Fairview Street and Warner Avenue	0.82	D	0.80	C
24	Fairview Street and MacArthur Boulevard	0.68	B	0.77	C
25	Fairview Road and Sunflower Avenue	0.70	B	0.72	C
26	Greenville Street and Edinger Avenue	0.77	C	0.60	A
27	Greenville Street and Segerstrom Avenue	0.84	D	0.78	C
28	Raitt Street and McFadden Avenue	0.78	C	0.76	C
29	Raitt Street and Edinger Avenue	0.99	E	0.99	E
30	Bear Street and MacArthur Boulevard	0.71	C	0.85	D
31	Bristol Street and 17th Street	0.87	D	0.82	D
32	Bristol Street and Civic Center Drive	0.94	E	0.91	E
33	Bristol Street and Santa Ana Boulevard	0.81	D	0.85	D
34	Bristol Street and 1st Street	0.77	C	0.83	D
35	Bristol Street and McFadden Avenue	0.96	E	1.03	F
36	Bristol Street and Warner Avenue	0.92	E	0.85	D
37	Bristol Street and Segerstrom Avenue	0.81	D	0.87	D
38	Bristol Street and Alton Avenue	0.55	A	0.63	B
39	Bristol Street and MacArthur Boulevard	0.70	B	0.77	C

ID	INTERSECTION	AM		PM	
		V/C or Delay	LOS	V/C or Delay	LOS
40	Bristol Street and Sunflower Avenue	0.65	B	0.69	B
41	Bristol Street and I-405 NB Ramps	20.8	C	28.5	C
42	Bristol Street and I-405 SB Ramps	23.9	C	18.3	B
43	Flower Street and Santa Ana Boulevard	0.81	D	0.86	D
44	Flower Street and 1st Street	0.93	E	0.88	D
45	Flower Street and McFadden Avenue	0.90	D	1.04	F
46	Flower Street and Segerstrom Avenue	0.78	C	0.87	D
47	Flower Street and MacArthur Boulevard	0.68	B	0.90	D
48	Main Street and La Veta Avenue	0.59	A	0.70	B
49	Main Street and Mainplace Drive / Memory Lane	0.51	A	0.56	A
50	Main Street and 17th Street	0.88	D	0.76	C
51	Main Street and Civic Center Drive	0.78	C	0.97	E
52	Main Street and Santa Ana Boulevard	0.93	E	0.79	C
53	Main Street and 4th Street	0.41	A	0.45	A
54	Main Street and 1st Street	0.68	B	0.74	C
55	Main Street and McFadden Avenue	0.89	D	0.93	E
56	Main Street and Edinger Avenue	0.80	C	0.87	D
57	Main Street and MacArthur Boulevard	0.68	B	0.75	C
58	Penn Way and 17th Street	12.2	B	25.5	C
59	Santiago Street / I-5 NB Ramps and 17th Street	30.0	C	19.0	B
60	Penn Way and I-5 SB Ramps	21.2	C	23.0	C
61	Santiago Street and Civic Center Drive	159.2	F	110.0	F
62	Santiago Street and Santa Ana Boulevard	1.04	F	1.02	F
63*	Standard Avenue and 4th Street	0.94	E	0.89	D
64	Standard Avenue and 1st Street	0.98	E	0.97	E
65	Standard Avenue and McFadden Avenue	0.85	D	0.83	D
66	Halladay Street and Warner Avenue	0.78	C	0.97	E
67	Halladay Street and Dyer Road	0.77	C	1.06	F
68	SR-55 SB Ramps and MacArthur Boulevard	19.9	B	17.8	B
69	SR-55 NB Ramps and MacArthur Boulevard	19.3	B	14.6	B
70	SR-55 SB Ramps and Dyer Road	25.7	C	26.5	C
71	Glassell Street and La Veta Avenue	0.80	C	0.74	C
72	Glassell Street and SR-22 WB Ramps	32.6	C	30.5	C
73	Glassell Street / Grand Avenue and SR-22 EB Ramps	30.6	C	31.6	C
74	Grand Avenue and Fairhaven Avenue	0.61	B	0.72	C
75	Grand Avenue and Santa Clara Avenue	0.84	D	0.81	D
76	Grand Avenue and 17th Street	0.79	C	0.86	D
77	Grand Avenue and I-5 NB Ramps	13.2	B	10.1	B
78	Grand Avenue and Santa Ana Boulevard	26.0	C	25.3	C
79	Grand Avenue and 1st Street	0.74	C	0.73	C

ID	INTERSECTION	AM		PM	
		V/C or Delay	LOS	V/C or Delay	LOS
80	Grand Avenue and Chestnut Avenue	0.70	B	0.69	B
81	Grand Avenue and McFadden Avenue	0.89	D	0.82	D
82	Grand Avenue and Edinger Avenue	0.84	D	1.00	E
83	Grand Avenue and Warner Avenue	0.61	B	0.83	D
84	SR-55 NB Ramps and Dyer Road	17.1	B	5.7	A
85	Cambridge Street and La Veta Avenue	31.6	D	19.7	C
86	Cambridge Street and Fairhaven Avenue	0.56	A	0.45	A
87	Mabury Street and 1st Street	27.4	C	27.1	C
88	Tustin Street and La Veta Avenue	0.45	A	0.38	A
89	Tustin Street and SR-22 WB On-Ramp	12.2	B	11.1	B
90	Tustin Street and SR-22 EB Off-Ramp / Seba Avenue	25.0	C	23.1	C
91	Tustin Street and Fairhaven Avenue	1.20	F	0.69	B
92	Tustin Avenue and Santa Clara Avenue	1.04	F	0.71	C
93	Tustin Avenue and 17th Street	0.91	E	0.80	C
94	Tustin Avenue and 4th Street	0.83	D	0.71	C
95	SR-55 SB Ramps / Auto Mall Drive and Edinger Avenue	25.2	C	25.5	C
96	SR-55 NB Ramps / Del Amo Avenue and Newport Avenue	25.4	C	39.1	D
97	Red Hill Avenue and Edinger Avenue	0.61	B	0.85	D
98	Red Hill Avenue and Warner Avenue	0.56	A	0.88	D
99	Red Hill Avenue and Barranca Parkway	0.55	A	0.54	A
100	Red Hill Avenue and Alton Parkway	0.86	D	1.18	F
101	Red Hill Avenue and MacArthur Boulevard	0.69	B	0.70	B
102	Red Hill Avenue and Main Street	0.72	C	0.81	D
103	I-5 SB Ramps and Santa Ana Boulevard	17.4	B	18.4	B
104	Tustin Ranch Road and Warner Avenue	0.52	A	0.65	B
105	Von Karman Avenue and Barranca Parkway	0.93	E	1.23	F

Notes: (1) LOS – Level of Service; (2) V/C – Volume to Capacity

7.0 Future Year (2045) With Project

This network alternative includes all the improvements listed in the No Project alternative, in addition to the improvements presented in Section 2.7.

Separate OCTAM 5.0 forecasts were produced for the With Project condition in order to understand traffic changes resulting from the proposed roadway improvements listed above. The Future Year (2045) With Project – AM and PM peak hour intersection turning movement volumes are shown in Tables 7-1 and 7-2.

Table 7-1 Future Year (2045) With Project Volumes – AM Peak Hour

ID	Intersection	Northbound			Southbound			Eastbound			Westbound		
		L	T	R	L	T	R	L	T	R	L	T	R
1	Euclid Street and Bolsa Avenue	100	845	145	194	1725	97	194	721	136	190	606	194
2	Euclid Street and McFadden Avenue	156	1185	141	146	2031	168	227	463	287	106	234	89
3	Euclid Street and Edinger Avenue	127	801	68	180	2613	240	136	595	364	133	812	148
4	Newhope Street and Hazard Avenue	94	708	101	86	1262	116	17	44	33	17	57	23
5	Newhope Street and McFadden Avenue	77	342	120	116	1153	107	106	386	125	122	311	69
6	Harbor Boulevard and SR-22 WB Off-Ramp / Banner Drive	83	1508	0	0	1354	18	81	0	133	836	44	117
7	Trask Avenue and SR-22 EB On-Ramp	0	0	0	0	0	0	558	699	0	0	624	117
8	Harbor Boulevard and Westminster Avenue	159	1045	224	251	1970	113	173	910	32	406	1100	299
9	Harbor Boulevard and 1st Street	102	816	176	223	1876	122	118	788	153	229	580	135
10	Harbor Boulevard and McFadden Avenue	101	1026	98	179	1891	63	136	353	106	85	193	55
11	Harbor Boulevard and Edinger Avenue	95	713	135	212	2441	71	123	743	373	211	469	195
12	Harbor Boulevard and Warner Avenue	106	647	164	451	2034	122	100	1422	374	125	654	111
13	Harbor Boulevard and Segerstrom Avenue	107	759	48	173	2324	87	90	753	303	146	453	103
14	Hyland Avenue / OCTA Bus Base and MacArthur Boulevard	86	4	24	8	2	19	7	1915	760	82	626	26
15	Harbor Boulevard and MacArthur Boulevard	128	898	92	289	1662	115	133	1204	363	152	506	151
16	Harbor Boulevard and Sunflower Avenue	221	1128	209	242	2284	56	9	109	42	149	190	107
17	Harbor Boulevard and I-405 NB Off-Ramp	0	1915	0	0	2007	0	0	0	0	399	0	702
18	Harbor Boulevard and I-405 SB Off-Ramp	0	1993	0	0	1278	0	475	0	529	0	0	0
19	Fairview Street and Civic Center Drive	7	1435	465	314	1812	8	7	25	25	50	2	26
20	Fairview Street and 1st Street	196	1508	284	272	1579	181	170	977	151	180	809	271

Santa Ana General Plan Update Traffic Impact Study – Final Draft

ID	Intersection	Northbound			Southbound			Eastbound			Westbound		
		L	T	R	L	T	R	L	T	R	L	T	R
21	Fairview Street and McFadden Avenue	138	1479	198	184	2242	162	92	216	50	93	240	19
22	Fairview Street and Edinger Avenue	212	935	131	225	1576	133	361	1002	268	463	608	121
23	Fairview Street and Warner Avenue	235	1039	136	205	1628	119	69	1010	301	277	836	271
24	Fairview Street and MacArthur Boulevard	280	870	100	269	1357	152	121	984	145	298	627	178
25	Fairview Road and Sunflower Avenue	182	1051	160	191	1627	104	44	286	58	357	299	154
26	Greenville Street and Edinger Avenue	140	0	188	0	0	0	0	1788	436	178	949	0
27	Greenville Street and Segerstrom Avenue	47	193	78	154	472	160	50	1127	180	210	847	97
28	Raitt Street and McFadden Avenue	34	309	49	69	528	72	52	313	40	60	190	34
29	Raitt Street and Edinger Avenue	85	228	82	80	376	45	330	2016	290	127	992	59
30	Bear Street and MacArthur Boulevard	61	210	89	192	728	289	99	1690	116	103	1735	147
31	Bristol Street and 17th Street	241	1241	210	449	1845	243	341	1015	164	386	886	293
32	Bristol Street and Civic Center Drive	129	1141	101	396	1597	100	80	404	50	145	481	100
33	Bristol Street and Santa Ana Boulevard	68	1482	206	172	1891	51	54	264	23	52	129	22
34	Bristol Street and 1st Street	208	1451	184	315	1298	183	206	1268	128	126	949	139
35	Bristol Street and McFadden Avenue	130	1159	58	228	2223	229	155	266	131	145	405	47
36	Bristol Street and Warner Avenue	221	993	183	643	2178	247	172	958	238	231	1058	180
37	Bristol Street and Segerstrom Avenue	70	778	146	283	1011	119	306	1480	136	157	712	91
38	Bristol Street and Alton Avenue	10	702	53	224	1551	36	190	117	244	41	87	31
39	Bristol Street and MacArthur Boulevard	95	491	123	319	1389	145	211	1531	311	191	910	132
40	Bristol Street and Sunflower Avenue	119	583	172	232	1316	99	135	1115	451	295	480	166
41	Bristol Street and I-405 NB Ramps	0	1638	210	0	2088	8	0	0	36	147	89	807
42	Bristol Street and I-405 SB Ramps	122	1195	0	0	1097	943	675	0	618	0	0	0
43	Flower Street and Santa Ana Boulevard	64	593	86	275	929	124	63	394	45	118	377	158
44	Flower Street and 1st Street	89	387	102	366	1158	121	107	983	39	161	664	95
45	Flower Street and McFadden Avenue	30	219	19	66	367	53	58	658	50	54	366	49
46	Flower Street and Segerstrom Avenue	86	451	100	98	544	120	237	1631	455	115	846	93
47	Flower Street and MacArthur Boulevard	26	170	88	163	352	264	163	1852	79	79	1329	85
48	Main Street and	123	844	438	161	843	141	350	495	215	334	291	243

Santa Ana General Plan Update Traffic Impact Study – Final Draft

ID	Intersection	Northbound			Southbound			Eastbound			Westbound		
		L	T	R	L	T	R	L	T	R	L	T	R
	La Veta Avenue												
49	Main Street and Mainplace Drive / Memory Lane	35	955	313	27	1066	223	123	194	13	264	301	20
50	Main Street and 17th Street	156	929	199	225	1251	81	114	1203	60	369	1475	22
51	Main Street and Civic Center Drive	138	901	79	69	1222	186	75	454	83	52	679	41
52	Main Street and Santa Ana Boulevard	66	1050	0	0	1162	103	0	0	0	61	848	65
53	Main Street and 4th Street	0	1052	25	0	1098	27	0	93	14	0	105	26
54	Main Street and 1st Street	103	532	54	94	937	69	69	805	85	78	972	54
55	Main Street and McFadden Avenue	93	874	44	184	1434	28	44	419	46	97	259	74
56	Main Street and Edinger Avenue	104	589	64	239	1103	58	99	1288	174	149	867	106
57	Main Street and MacArthur Boulevard	60	344	292	539	709	160	230	1336	242	187	556	279
58	Penn Way and 17th Street	49	0	250	0	0	0	0	1279	652	236	1901	0
59	Santiago Street / I-5 NB Ramps and 17th Street	720	33	21	60	0	312	101	1062	384	0	1508	24
60	Penn Way and I-5 SB Ramps	0	192	170	837	173	0	0	0	0	170	0	95
61	Santiago Street and Civic Center Drive	318	221	31	6	335	82	212	81	431	126	116	23
62	Santiago Street and Santa Ana Boulevard	188	611	303	409	972	253	118	732	99	297	699	258
63	Standard Avenue and 4th Street	191	473	248	431	604	332	298	624	219	250	550	340
64	Standard Avenue and 1st Street	45	631	312	123	901	41	161	1959	121	194	1282	120
65	Standard Avenue and McFadden Avenue	44	170	77	123	297	21	21	736	89	81	214	48
66	Halladay Street and Warner Avenue	69	0	160	0	0	0	0	1772	200	210	797	0
67	Halladay Street and Dyer Road	16	26	71	155	31	33	54	1820	13	126	686	111
68	SR-55 SB Ramps and MacArthur Boulevard	0	0	0	998	0	903	0	1423	1014	0	1363	155
69	SR-55 NB Ramps and MacArthur Boulevard	965	0	1037	0	0	0	0	1503	744	0	591	279
70	SR-55 SB Ramps and Dyer Road	312	37	713	50	242	60	34	1282	273	418	663	111
71	Glassell Street and La Veta Avenue	292	458	139	13	274	60	57	293	563	380	401	10
72	Glassell Street and SR-22 WB Ramps	568	638	0	0	1017	473	0	0	0	247	4	369
73	Glassell Street / Grand Avenue and SR-22 EB Ramps	0	968	258	345	904	0	258	0	1012	0	0	0
74	Grand Avenue and Fairhaven Avenue	25	1,032	148	184	1,531	34	99	60	59	152	17	137
75	Grand Avenue and Santa Clara Avenue	92	648	167	307	1,503	338	179	291	60	140	270	246
76	Grand Avenue and 17th Street	228	666	458	303	1,270	249	246	915	116	401	1,047	114

Santa Ana General Plan Update Traffic Impact Study – Final Draft

ID	Intersection	Northbound			Southbound			Eastbound			Westbound		
		L	T	R	L	T	R	L	T	R	L	T	R
77	Grand Avenue and I-5 NB Ramps	0	1145	662	104	3338	0	0	0	0	557	0	154
78	Grand Avenue and Santa Ana Boulevard	79	1119	57	231	1908	1684	242	200	394	5	407	37
79	Grand Avenue and 1st Street	186	655	31	121	1753	213	318	760	216	268	939	107
80	Grand Avenue and Chestnut Avenue	53	737	163	174	2086	57	64	449	118	81	237	148
81	Grand Avenue and McFadden Avenue	262	1104	165	294	1974	192	109	352	107	95	340	86
82	Grand Avenue and Edinger Avenue	65	649	127	253	1293	253	396	1654	159	170	651	142
83	Grand Avenue and Warner Avenue	187	564	241	204	589	199	314	1120	440	140	617	208
84	SR-55 NB Ramps and Dyer Road	637	0	521	0	0	0	0	1550	620	0	859	517
85	Cambridge Street and La Veta Avenue	185	235	0	0	480	245	195	0	312	0	0	0
86	Cambridge Street and Fairhaven Avenue	0	0	0	618	0	199	69	185	0	0	130	101
87	Mabury Street and 1st Street	5	0	122	276	164	618	0	922	10	46	701	0
88	Tustin Street and La Veta Avenue	9	365	105	48	944	3	9	11	35	279	1	43
89	Tustin Street and SR-22 WB On-Ramp	762	708	0	0	897	536	0	0	0	0	0	0
90	Tustin Street and SR-22 EB Off-Ramp / Seba Avenue	0	1213	6	13	779	0	252	25	1084	6	0	43
91	Tustin Street and Fairhaven Avenue	125	720	126	249	2,148	42	78	297	511	306	338	442
92	Tustin Avenue and Santa Clara Avenue	102	556	104	135	2,756	87	267	673	491	118	244	122
93	Tustin Avenue and 17th Street	155	277	330	638	1,841	20	494	1,948	333	488	770	188
94	Tustin Avenue and 4th Street	40	204	183	743	946	293	159	942	39	129	727	472
95	SR-55 SB Ramps / Auto Mall Drive and Edinger Avenue	456	68	540	50	30	8	34	1334	493	510	1202	157
96	SR-55 NB Ramps / Del Amo Avenue and Newport Avenue	413	109	69	20	497	728	269	163	155	8	223	4
97	Red Hill Avenue and Edinger Avenue	122	449	128	203	861	403	397	1276	271	250	1213	170
98	Red Hill Avenue and Warner Avenue	118	716	97	20	949	191	239	407	300	152	543	96
99	Red Hill Avenue and Barranca Parkway	184	458	151	184	809	106	126	758	300	522	583	114
100	Red Hill Avenue and Alton Parkway	235	693	434	233	1059	170	185	574	574	335	284	159
101	Red Hill Avenue and MacArthur Boulevard	83	742	13	205	529	485	1194	617	101	34	329	843
102	Red Hill Avenue and Main Street	201	691	449	78	365	126	139	1309	254	167	335	79
103	I-5 SB Ramps and Santa Ana Boulevard	0	0	0	382	0	38	287	492	0	0	1027	300

Santa Ana General Plan Update Traffic Impact Study – Final Draft

ID	Intersection	Northbound			Southbound			Eastbound			Westbound		
		L	T	R	L	T	R	L	T	R	L	T	R
104	Tustin Ranch Road and Warner Avenue	0	0	0	174	0	22	27	357	0	0	2130	490
105	Von Karman Avenue and Barranca Parkway	375	497	298	98	960	420	247	928	310	917	1506	47

Table 7-2 Future Year (2045) With Project Volumes – PM Peak Hour

ID	Intersection	Northbound			Southbound			Eastbound			Westbound		
		L	T	R	L	T	R	L	T	R	L	T	R
1	Euclid Street and Bolsa Avenue	165	1532	123	137	781	148	201	641	100	168	702	168
2	Euclid Street and McFadden Avenue	248	2020	130	87	1070	130	134	307	136	86	359	166
3	Euclid Street and Edinger Avenue	551	1648	117	136	897	228	121	467	140	119	1103	179
4	Newhope Street and Hazard Avenue	102	1129	44	45	954	114	33	66	40	8	51	15
5	Newhope Street and McFadden Avenue	188	1009	177	121	539	104	45	273	40	72	398	113
6	Harbor Boulevard and SR-22 WB Off-Ramp / Banner Drive	103	2324	0	0	1823	59	102	0	86	558	75	160
7	Trask Avenue and SR-22 EB On-Ramp	0	0	0	0	0	0	785	588	0	0	449	42
8	Harbor Boulevard and Westminster Avenue	222	1106	262	254	1752	202	227	808	39	294	1018	231
9	Harbor Boulevard and 1st Street	280	1446	160	240	1053	142	192	784	148	185	865	141
10	Harbor Boulevard and McFadden Avenue	182	1866	136	261	1114	101	147	358	45	63	151	43
11	Harbor Boulevard and Edinger Avenue	262	1645	199	283	822	75	109	460	81	188	1089	363
12	Harbor Boulevard and Warner Avenue	768	3685	277	250	1389	166	198	1399	320	253	2626	838
13	Harbor Boulevard and Segerstrom Avenue	275	1732	55	86	973	86	118	585	192	121	1308	475
14	Hyland Avenue / OCTA Bus Base and MacArthur Boulevard	1139	7	66	12	4	14	35	869	156	25	2320	12
15	Harbor Boulevard and MacArthur Boulevard	527	1362	79	206	1039	170	143	501	185	85	1429	269
16	Harbor Boulevard and Sunflower Avenue	156	1552	230	118	1464	44	85	230	239	282	592	221
17	Harbor Boulevard and I-405 NB Off-Ramp	0	1488	0	0	2570	0	0	0	0	513	0	828
18	Harbor Boulevard and I-405 SB Off-Ramp	0	1881	0	0	2254	0	181	0	833	0	0	0
19	Fairview Street and Civic Center Drive	6	1777	499	205	1903	0	2	6	4	164	0	61
20	Fairview Street and 1st Street	182	1339	121	236	1468	291	215	870	151	126	952	147
21	Fairview Street and McFadden Avenue	174	1596	139	195	1577	246	79	214	53	51	177	43
22	Fairview Street and Edinger Avenue	190	1810	111	198	616	151	205	628	168	639	1353	297
23	Fairview Street and Warner Avenue	211	1679	156	179	906	92	163	792	123	178	1049	227
24	Fairview Street and MacArthur Boulevard	228	1568	85	162	902	83	253	661	223	159	1210	212
25	Fairview Road and Sunflower Avenue	190	1705	371	138	1145	79	245	520	115	208	522	136

Santa Ana General Plan Update Traffic Impact Study – Final Draft

ID	Intersection	Northbound			Southbound			Eastbound			Westbound		
		L	T	R	L	T	R	L	T	R	L	T	R
26	Greenville Street and Edinger Avenue	327	0	218	0	0	0	0	1178	240	155	1840	0
27	Greenville Street and Segerstrom Avenue	50	414	31	44	143	44	138	1049	60	39	1490	213
28	Raitt Street and McFadden Avenue	34	482	75	24	252	40	59	347	30	38	318	44
29	Raitt Street and Edinger Avenue	84	361	101	61	209	52	177	1226	175	195	2203	197
30	Bear Street and MacArthur Boulevard	262	1258	328	115	278	84	90	847	88	82	1475	235
31	Bristol Street and 17th Street	370	1801	300	347	1847	314	243	543	98	280	1055	357
32	Bristol Street and Civic Center Drive	214	1494	78	173	1589	163	130	366	43	149	635	72
33	Bristol Street and Santa Ana Boulevard	85	1722	98	120	1597	60	70	194	45	125	199	54
34	Bristol Street and 1st Street	434	1872	276	216	1169	264	259	1454	186	155	953	90
35	Bristol Street and McFadden Avenue	249	1833	99	116	1618	373	114	222	44	82	424	50
36	Bristol Street and Warner Avenue	312	1170	213	343	1144	223	159	715	126	282	1662	487
37	Bristol Street and Segerstrom Avenue	177	1309	231	98	894	187	279	998	79	156	1408	71
38	Bristol Street and Alton Avenue	43	1667	157	114	858	54	50	70	130	0	0	0
39	Bristol Street and MacArthur Boulevard	335	1428	260	237	871	137	357	796	169	247	1432	270
40	Bristol Street and Sunflower Avenue	687	1452	234	226	844	242	391	764	296	254	976	311
41	Bristol Street and I-405 NB Ramps	0	2235	195	0	2458	23	0	0	204	357	306	1184
42	Bristol Street and I-405 SB Ramps	135	1647	0	0	1657	968	740	0	331	0	0	0
43	Flower Street and Santa Ana Boulevard	215	1307	107	95	486	44	104	300	49	106	371	110
44	Flower Street and 1st Street	211	1000	238	140	383	111	135	1181	98	144	969	101
45	Flower Street and McFadden Avenue	54	734	45	26	201	33	56	422	17	43	532	76
46	Flower Street and Segerstrom Avenue	120	843	80	80	449	129	241	1198	126	101	1699	109
47	Flower Street and MacArthur Boulevard	116	553	65	97	233	224	264	1254	80	61	1967	175
48	Main Street and La Veta Avenue	310	948	444	191	1199	309	347	495	222	332	662	266
49	Main Street and Mainplace Drive / Memory Lane	102	1075	204	48	999	132	195	217	58	370	302	146
50	Main Street and 17th Street	239	1237	270	243	1062	164	174	975	58	187	1147	76
51	Main Street and Civic Center Drive	98	1234	103	63	1031	65	168	930	111	38	384	39
52	Main Street and Santa Ana Boulevard	56	1280	0	0	1108	54	0	0	0	65	656	85
53	Main Street and 4th Street	0	1108	53	0	951	43	0	112	63	0	157	40

Santa Ana General Plan Update Traffic Impact Study – Final Draft

ID	Intersection	Northbound			Southbound			Eastbound			Westbound		
		L	T	R	L	T	R	L	T	R	L	T	R
54	Main Street and 1st Street	179	875	76	160	615	131	91	921	68	75	834	58
55	Main Street and McFadden Avenue	149	1169	72	138	933	68	78	345	42	71	400	180
56	Main Street and Edinger Avenue	111	1181	54	129	646	88	159	940	105	117	1569	162
57	Main Street and MacArthur Boulevard	488	1169	321	271	352	266	385	792	76	188	1488	432
58	Penn Way and 17th Street	795	0	388	0	0	0	0	1712	552	126	1480	0
59	Santiago Street / I-5 NB Ramps and 17th Street	375	50	20	55	0	142	128	1168	767	0	1622	44
60	Penn Way and I-5 SB Ramps	0	363	238	508	117	0	0	0	0	214	0	183
61	Santiago Street and Civic Center Drive	133	411	41	20	281	72	266	76	269	14	19	18
62	Santiago Street and Santa Ana Boulevard	135	833	236	378	639	103	164	673	87	255	546	347
63	Standard Avenue and 4th Street	251	543	214	254	428	297	302	477	201	233	648	351
64	Standard Avenue and 1st Street	109	724	259	142	679	47	168	1279	65	264	1888	116
65	Standard Avenue and McFadden Avenue	103	407	50	110	240	42	53	351	60	68	412	119
66	Halladay Street and Warner Avenue	200	0	417	0	0	0	2	955	96	287	2284	0
67	Halladay Street and Dyer Road	57	249	287	125	17	35	166	1433	10	52	1680	134
68	SR-55 SB Ramps and MacArthur Boulevard	0	0	0	321	0	777	0	1305	1163	0	1547	608
69	SR-55 NB Ramps and MacArthur Boulevard	726	0	483	0	0	0	0	764	785	0	1444	1040
70	SR-55 SB Ramps and Dyer Road	386	12	291	103	226	110	66	1544	210	507	904	58
71	Glassell Street and La Veta Avenue	573	595	194	15	499	37	112	367	631	225	407	16
72	Glassell Street and SR-22 WB Ramps	640	1045	0	0	1110	323	0	0	0	268	9	476
73	Glassell Street / Grand Avenue and SR-22 EB Ramps	0	1316	336	505	903	0	238	4	522	0	0	0
74	Grand Avenue and Fairhaven Avenue	50	1,311	262	242	974	89	79	45	33	153	29	109
75	Grand Avenue and Santa Clara Avenue	95	1,280	266	240	946	240	114	139	26	115	206	220
76	Grand Avenue and 17th Street	266	947	239	294	634	140	371	949	160	284	1,046	190
77	Grand Avenue and I-5 NB Ramps	0	2036	1571	67	1623	0	0	0	0	168	0	202
78	Grand Avenue and Santa Ana Boulevard	213	2411	40	44	964	684	370	226	356	44	295	213
79	Grand Avenue and 1st Street	195	1493	45	133	784	313	272	900	89	121	753	138
80	Grand Avenue and Chestnut Avenue	180	1352	234	149	664	112	47	143	31	91	283	165
81	Grand Avenue and McFadden Avenue	232	1320	227	176	800	215	64	238	42	96	762	168

Santa Ana General Plan Update Traffic Impact Study – Final Draft

ID	Intersection	Northbound			Southbound			Eastbound			Westbound		
		L	T	R	L	T	R	L	T	R	L	T	R
82	Grand Avenue and Edinger Avenue	259	1494	129	236	583	327	207	895	72	98	1758	228
83	Grand Avenue and Warner Avenue	218	788	174	178	575	265	342	656	142	244	1556	510
84	SR-55 NB Ramps and Dyer Road	188	0	51	0	0	0	0	1355	689	0	1411	882
85	Cambridge Street and La Veta Avenue	176	246	0	0	206	191	469	0	309	0	0	0
86	Cambridge Street and Fairhaven Avenue	0	0	0	195	0	68	85	148	0	0	218	272
87	Mabury Street and 1st Street	25	0	256	164	70	310	0	1275	20	31	423	0
88	Tustin Street and La Veta Avenue	31	693	164	96	851	16	13	5	20	134	4	82
89	Tustin Street and SR-22 WB On-Ramp	383	1100	0	0	642	330	0	0	0	0	0	0
90	Tustin Street and SR-22 EB Off-Ramp / Seba Avenue	0	1155	3	43	589	0	440	39	558	28	0	67
91	Tustin Street and Fairhaven Avenue	258	1,377	122	356	940	108	82	185	151	86	191	180
92	Tustin Avenue and Santa Clara Avenue	176	852	131	199	1,574	109	48	150	88	115	144	136
93	Tustin Avenue and 17th Street	233	1,000	514	377	404	40	346	680	92	211	693	385
94	Tustin Avenue and 4th Street	35	381	123	536	396	145	226	806	41	123	833	513
95	SR-55 SB Ramps / Auto Mall Drive and Edinger Avenue	401	32	423	110	50	37	46	1649	464	437	1139	136
96	SR-55 NB Ramps / Del Amo Avenue and Newport Avenue	879	262	51	19	231	889	165	57	33	23	348	16
97	Red Hill Avenue and Edinger Avenue	208	1501	238	108	214	173	410	1051	128	91	1176	574
98	Red Hill Avenue and Warner Avenue	343	1175	135	89	341	432	324	880	137	78	1643	216
99	Red Hill Avenue and Barranca Parkway	344	1293	333	314	531	249	178	662	87	129	979	286
100	Red Hill Avenue and Alton Parkway	27	1513	219	148	628	5	453	1111	569	2003	342	1235
101	Red Hill Avenue and MacArthur Boulevard	179	1160	14	340	707	1240	515	237	36	39	818	574
102	Red Hill Avenue and Main Street	467	1006	272	88	640	348	212	757	205	284	1617	91
103	I-5 SB Ramps and Santa Ana Boulevard	0	0	0	357	0	78	595	672	0	0	590	162
104	Tustin Ranch Road and Warner Avenue	0	0	0	653	0	45	64	2124	0	0	925	398
105	Von Karman Avenue and Barranca Parkway	362	2082	454	80	407	280	785	1435	201	254	805	274

7.1 FUTURE YEAR (2045) WITH PROJECT VEHICLE MILES TRAVELED (VMT)

Table 7-3 presents the VMT analysis results for the Future Year (2045) With Project scenario. VMT calculations are based on the scenario parameters and methodology as described in Sections 2.7 and 3.1, respectively.

Table 7-3 Future Year (2045) VMT Summary

	I – I VMT	I – X VMT	X – I VMT	Total VMT	Service Population	VMT/SP
City	637,655	5,432,337	5,448,967	11,518,959	566,616	20.3
County	52,931,787	29,642,498	29,748,229	112,322,514	4,262,124	26.4

SP = Service Population = Total Employees + Total Population. Reduction factor applied to Total Employees as noted in Section 3.1 and shown in Appendix F. I-I = Internal-Internal; I-X = Internal-External; X-I = External-Internal.

7.2 ROADWAY SEGMENT LEVEL OF SERVICE

A summary of the forecast roadway segment volumes and corresponding level of service results for the Future Year (2045) With Project condition is shown in Table 7-4. The following roadway segments are forecast to operate at a deficient LOS:

- Segment 8 – Harbor Boulevard from Segerstrom Avenue to MacArthur Boulevard
- Segment 23 – Main Street from 1st Street to Bishop Street
- Segment 39 – Bristol Street from Edinger Avenue to Warner Avenue
- Segment 42 – Bristol Street from MacArthur Boulevard to Sunflower Avenue
- Segment 45 – Main Street from McFadden Avenue to Edinger Avenue
- Segment 46 – Main Street from Edinger Avenue to Warner Avenue
- Segment 57 – Dyer Road from Grand Avenue to Pullman Street
- Segment 63 – Broadway from 17th Street to Civic Center Drive
- Segment 84 – Dyer Road from Pullman Street to Red Hill Avenue

Table 7-4 Future Year (2045) With Project Roadway Segment LOS

ID	Street	Segment	Lanes	ADT	LOS
1	1st Street	Euclid Street to Ward Street	6D	18,700	A
2	Euclid Street	1st Street to McFadden Avenue	6D	34,000	B
3	Westminster Avenue	Harbor Boulevard to Fairview Street	6D	17,400	A
4	Harbor Boulevard	Westminster Avenue/17th Street to Hazard Avenue	6D	36,200	B
5	1st Street	Harbor Boulevard to Jackson	6D	23,100	A
6	Edinger Avenue	Harbor Boulevard to Fairview Street	6D	23,300	A
7	Warner Avenue	Harbor Boulevard to Fairview Street	6D	26,300	A
8	Harbor Boulevard	Segerstrom Avenue to MacArthur Boulevard	6D	56,900	F
9	Fairview Street	1st Street to Willits Street	6D	38,600	B
10	1st Street	Sullivan Street to Raitt Street	6D	26,600	A
11	Bristol Street	17th Street to Santa Clara Avenue	6D	41,500	C
12	17th Street	College Avenue to Bristol Street	6D	29,500	A
13	Bristol Street	17th Street to Washington Avenue	6D	45,100	D
14	Fairview Street	Trask Avenue to 17th Street	6D	48,100	D
15	Bristol Street	1st Street to Bishop Street	6D	49,000	D
16	Civic Center Drive	Bristol Street to Flower Street	4U	18,600	C
17	Flower Street	1st Street to Bishop Street	2D	6,900	A
18	Main Street	17th Street to 20th Street	6D	43,000	C
19	Main Street	Washington Street to Civic Center Drive	4U	19,000	C
20	Civic Center Drive	Flower Street to Ross Street	4U	10,200	A
21	Santa Ana Boulevard	Flower Street to Ross Street	4D	15,800	A
22	1st Street	Main Street to Standard Avenue	4D	32,900	D
23	Main Street	1st Street to Bishop Street	4U	30,500	F
24	Grand Avenue	Santa Clara Avenue to Fairhaven Street	6D	31,100	A
25	Grand Avenue	Santa Ana Boulevard to 4th Street	6D	35,000	B
26	Santa Clara Avenue	Grand Avenue to Tustin Avenue	2D	8,700	A
27	Tustin Avenue	Santa Clara Avenue to Fairhaven Street	6D	20,400	A
28	17th Street	Cabrillo Park Drive to Tustin Avenue	6D	34,600	B
29	Tustin Avenue	Fruit Street to 4th Street	6D	28,100	A
30	1st Street	Grand Avenue to Elk Lane	4D	30,800	D
31	1st Street	Cabrillo Park Drive to Tustin Avenue	4D	14,600	A
32	Fairview Street	Edinger Avenue to Harvard Street	6D	45,100	D
33	Fairview Street	Warner Avenue to Segerstrom Avenue	6D	41,800	C
34	MacArthur Boulevard	Harbor Boulevard to Fairview Street	6D	32,600	A
35	Edinger Avenue	Fairview Street to Greenville Street	6D	22,200	A
36	McFadden Avenue	Fairview Street to Raitt Street	2D	8,200	A
37	MacArthur Boulevard	Fairview Street to Raitt Street	6D	28,900	A
38	Segerstrom Avenue	Fairview Street to Raitt Street	6D	29,600	A
39	Bristol Street	Edinger Avenue to Warner Avenue	6D	54,500	E
40	Bristol Street	Warner Avenue to Segerstrom Avenue	6D	44,800	C

ID	Street	Segment	Lanes	ADT	LOS
41	Warner Avenue	Raitt Street to Bristol Street	6D	22,300	A
42	Bristol Street	MacArthur Boulevard to Sunflower Avenue	6D	50,800	E
43	Flower Street	Warner Avenue to Segerstrom Avenue	4D	33,300	D
44	Edinger Avenue	Flower Street to Main Street	6D	25,200	A
45	Main Street	McFadden Avenue to Edinger Avenue	4U	27,500	F
46	Main Street	Edinger Avenue to Warner Avenue	4D	38,200	F
47	Main Street	Warner Avenue to Dyer Road	6D	38,600	B
48	Segerstrom Avenue	Bristol Street to Flower Street	6D	25,900	A
49	MacArthur Boulevard	Flower Street to Main Street	6D	39,800	C
50	Main Street	MacArthur Boulevard to Sunflower Avenue	6D	29,000	A
51	Grand Avenue	Edinger Avenue to Warner Avenue	6D	37,300	B
52	Edinger Avenue	Richie Street to Newport Avenue	6D	49,700	D
53	Warner Avenue	Grand Avenue to Red Hill Avenue	6D	34,600	B
54	Warner Avenue	Main Street to Standard Avenue	6D	23,900	A
55	McFadden Avenue	Newhope Street to Harbor Boulevard	4U	8,700	A
56	McFadden Avenue	Standard Avenue to Grand Avenue	2D	8,600	A
57	Dyer Road	Grand Avenue to Pullman Street	6D	80,700	F
58	McFadden Avenue	Bristol Street to Flower Street	2D	11,800	B
59	Main Street	La Veta Avenue to Memory Lane	8D	50,200	B
60	1st Street	Bristol Street to Flower Street	4D	25,700	B
61	Fairhaven Avenue	Grand Avenue to Tustin Avenue	2D	11,100	B
62	4th Street	French Street to Standard Avenue	2D	16,500	D
63	Broadway	17th Street to Civic Center Drive	2D	22,700	F
64	Broadway	Civic Center Drive to 1st Street	2D	13,800	C
65	Cambridge Street	SR-22 to Fairhaven Avenue	2D	8,800	A
66	Chestnut Avenue	Standard Avenue to Lyon Street	2D	7,700	A
67	Civic Center Drive	French Street to Santiago Street	2U	1,900	A
68	Civic Center Drive	Fairview Road to Bristol Street	2D	12,200	C
69	Flower Street	Edinger Avenue to Warner Avenue	2D	6,300	A
70	Halladay Avenue	Warner Avenue to Dyer Road	2D	16,100	D
71	Hazard Avenue	Euclid Street to Harbor Boulevard	2D	7,900	A
72	McFadden Avenue	Main Street to Standard Avenue	2D	14,300	C
73	Penn Way/Santiago Street	I-5 SB Ramps to Santa Ana Boulevard	2D	19,400	D
74	Raitt Street	Santa Ana Boulevard to 1st Street	2D	15,500	D
75	Raitt Street	Warner Avenue to Segerstrom Avenue	2D	11,600	B
76	Santa Ana Boulevard	French Street to Santiago Street	2D	13,500	C
77	Santa Ana Boulevard	Raitt Street to Bristol Street	2D	13,000	C
78	Standard Avenue	Chestnut Avenue to McFadden Avenue	2D	11,000	B
79	Standard Avenue	Edinger Avenue to Warner Avenue	2D	10,000	B
80	Greenville Street	Edinger Avenue to Warner Avenue	2U	8,000	B
81	Greenville Street	Warner Avenue to Segerstrom Avenue	2D	8,000	A
82	Flower Street	17th Street to Northern Terminus	2D	4,700	A

ID	Street	Segment	Lanes	ADT	LOS
83	Logan Street	Civic Center Drive to Santa Ana Boulevard	2U	- *	-
84	Dyer Road	Pullman Street to Red Hill Avenue	6D	57,500	F
85	Fairhaven Avenue	Tustin Street to Yorba Street	4U	14,947	A
86	Santa Clara Avenue	Tustin Street to Yorba Street	4U	7,818	A
87	Harbor Boulevard	McFadden Avenue to Edinger Avenue	6D	35,100	B
88	Harbor Boulevard	Edinger Avenue to Warner Avenue	6D	43,100	C

Notes:

* Not available.

(1) ADT – Average Daily Traffic Volumes

(2) LOS – Level of Service

(3) #D – total number of lanes in both directions divided by raised or striped median; #U – total number of undivided lanes in both directions.

(4) Roadway capacities shown in Table 3-1.

(5) Yellow and red shading indicates an unacceptable level of service

7.3 INTERSECTION LEVEL OF SERVICE

A summary of the AM and PM peak hour intersection level of service analysis results for the Future Year (2045) With Project condition is included in Table 7-5. The following intersections are expected to operate at an unacceptable level of service:

- INT 2 – Euclid street and McFadden Avenue (City of Santa Ana)
- INT 3 – Euclid Street and Edinger Avenue (City of Fountain Valley)
- INT 8 – Harbor Boulevard and Westminster Avenue (City of Santa Ana)
- INT 12 – Harbor Boulevard and Warner Avenue (City of Santa Ana – CMP)
- INT 13 – Harbor Boulevard and Segerstrom Avenue (City of Santa Ana)
- INT 22 – Fairview Street and Edinger Avenue (City of Santa Ana)
- INT 29 – Raitt Street and Edinger Avenue (City of Santa Ana)
- INT 32 – Bristol Street and Civic Center Drive (City of Santa Ana)
- INT 34 – Bristol Street and 1st Street (City of Santa Ana)
- INT 35 – Bristol Street and McFadden Avenue (City of Santa Ana)
- INT 36 – Bristol Street and Warner Avenue (City of Santa Ana)
- INT 37 – Bristol Street and Segerstrom Avenue (City of Santa Ana)
- INT 44 – Flower Street and 1st Street (City of Santa Ana)
- INT 45 – Flower Street and McFadden Avenue (City of Santa Ana)
- INT 46 – Flower Street and Segerstrom Avenue (City of Santa Ana)
- INT 47 – Flower Street and MacArthur Boulevard (City of Santa Ana)
- INT 55 – Main Street and McFadden Avenue (City of Santa Ana)
- INT 56 – Main Street and Edinger Avenue (City of Santa Ana)
- INT 61 – Santiago Street and Civic Center Drive (City of Santa Ana)

- INT 62 – Santiago Street and Santa Ana Boulevard (City of Santa Ana)
- INT 63 – Standard Avenue and 4th Street (City of Santa Ana)
- INT 64 – Standard Avenue and 1st Street (City of Santa Ana)
- INT 67 – Halladay Street and Dyer Road (City of Santa Ana)
- INT 80 – Grand Avenue and Chestnut Avenue (City of Santa Ana)
- INT 81 – Grand Avenue and McFadden Avenue (City of Santa Ana)
- INT 82 – Grand Avenue and Edinger Avenue (City of Santa Ana)
- INT 91 – Tustin Street and Fairhaven Avenue (City of Santa Ana)
- INT 92 – Tustin Avenue and Santa Clara Avenue (City of Santa Ana)
- INT 96 – SR-55 NB Ramps / Del Amo Avenue and Newport Avenue (Caltrans)
- INT 98 – Red Hill Avenue and Warner Avenue (City of Tustin)
- INT 100 – Red Hill Avenue and Alton Parkway (City of Irvine)
- INT 105 – Von Karman Avenue and Barranca Parkway (City of Irvine)

Table 7-5: Future Year (2045) With Project Intersection LOS Summary

ID	INTERSECTION	AM		PM	
		V/C or Delay	LOS	V/C or Delay	LOS
1	Euclid Street and Bolsa Avenue	0.79	C	0.79	C
2	Euclid Street and McFadden Avenue	0.91	E	0.79	C
3	Euclid Street and Edinger Avenue	1.01	F	0.86	D
4	Newhope Street and Hazard Avenue	0.60	A	0.52	A
5	Newhope Street and McFadden Avenue	0.73	C	0.68	B
6	Harbor Boulevard and SR-22 WB Off-Ramp / Banner Drive	28.5	C	23.8	C
7	Trask Avenue and SR-22 EB On-Ramp	11.0	B	11.0	B
8	Harbor Boulevard and Westminster Avenue	0.94	E	0.84	D
9	Harbor Boulevard and 1st Street	0.75	C	0.75	C
10	Harbor Boulevard and McFadden Avenue	0.73	C	0.71	C
11	Harbor Boulevard and Edinger Avenue	0.86	D	0.72	C
12	Harbor Boulevard and Warner Avenue	0.80	C	1.54	F
13	Harbor Boulevard and Segerstrom Avenue	1.01	F	0.93	E
14	Hyland Avenue / OCTA Bus Base and MacArthur Boulevard	0.62	B	0.89	D
15	Harbor Boulevard and MacArthur Boulevard	0.75	C	0.79	C
16	Harbor Boulevard and Sunflower Avenue	0.71	C	0.71	C
17	Harbor Boulevard and I-405 NB Off-Ramp	17.9	B	18.8	B
18	Harbor Boulevard and I-405 SB Off-Ramp	15.0	B	18.1	B
19	Fairview Street and Civic Center Drive	0.68	B	0.71	C
20	Fairview Street and 1st Street	0.89	D	0.89	D
21	Fairview Street and McFadden Avenue	0.80	C	0.68	B
22	Fairview Street and Edinger Avenue	0.88	D	0.92	E
23	Fairview Street and Warner Avenue	0.85	D	0.81	D
24	Fairview Street and MacArthur Boulevard	0.69	B	0.76	C
25	Fairview Road and Sunflower Avenue	0.69	B	0.69	B
26	Greenville Street and Edinger Avenue	0.74	C	0.65	B
27	Greenville Street and Segerstrom Avenue	0.88	D	0.80	C
28	Raitt Street and McFadden Avenue	0.70	B	0.68	B
29	Raitt Street and Edinger Avenue	0.93	E	0.99	E
30	Bear Street and MacArthur Boulevard	0.76	C	0.90	D
31	Bristol Street and 17th Street	0.85	D	0.81	D
32	Bristol Street and Civic Center Drive	0.93	E	0.90	D
33	Bristol Street and Santa Ana Boulevard	0.72	C	0.73	C
34	Bristol Street and 1st Street	0.90	D	0.97	E
35	Bristol Street and McFadden Avenue	0.95	E	0.89	D
36	Bristol Street and Warner Avenue	0.96	E	0.87	D
37	Bristol Street and Segerstrom Avenue	0.85	D	0.92	E
38	Bristol Street and Alton Avenue	0.55	A	0.58	A
39	Bristol Street and MacArthur Boulevard	0.76	C	0.80	C

ID	INTERSECTION	AM		PM	
		V/C or Delay	LOS	V/C or Delay	LOS
40	Bristol Street and Sunflower Avenue	0.68	B	0.74	C
41	Bristol Street and I-405 NB Ramps	20.9	C	29.0	C
42	Bristol Street and I-405 SB Ramps	23.6	C	18.2	B
43	Flower Street and Santa Ana Boulevard	0.59	A	0.67	B
44	Flower Street and 1st Street	0.93	E	1.22	F
45	Flower Street and McFadden Avenue	0.81	D	0.97	E
46	Flower Street and Segerstrom Avenue	0.82	D	0.92	E
47	Flower Street and MacArthur Boulevard	0.71	C	0.91	E
48	Main Street and La Veta Avenue	0.54	A	0.76	C
49	Main Street and Mainplace Drive / Memory Lane	0.46	A	0.50	A
50	Main Street and 17th Street	0.85	D	0.80	C
51	Main Street and Civic Center Drive	0.85	D	0.86	D
52	Main Street and Santa Ana Boulevard	0.79	C	0.70	B
53	Main Street and 4th Street	0.44	A	0.47	A
54	Main Street and 1st Street	0.75	C	0.80	C
55	Main Street and McFadden Avenue	0.92	E	0.94	E
56	Main Street and Edinger Avenue	0.88	D	0.98	E
57	Main Street and MacArthur Boulevard	0.72	C	0.78	C
58	Penn Way and 17th Street	12.1	B	20.3	C
59	Santiago Street / I-5 NB Ramps and 17th Street	31.4	C	20.3	C
60	Penn Way and I-5 SB Ramps	19.5	B	22.8	C
61	Santiago Street and Civic Center Drive	62.6	F	27.6	D
62	Santiago Street and Santa Ana Boulevard	1.44	F	1.41	F
63*	Standard Avenue and 4th Street	1.340	F	1.340	F
64	Standard Avenue and 1st Street	1.52	F	1.48	F
65	Standard Avenue and McFadden Avenue	0.84	D	0.77	C
66	Halladay Street and Warner Avenue	0.69	B	0.82	D
67	Halladay Street and Dyer Road	0.67	B	0.95	E
68	SR-55 SB Ramps and MacArthur Boulevard	20.2	C	18.4	B
69	SR-55 NB Ramps and MacArthur Boulevard	19.5	B	16.2	B
70	SR-55 SB Ramps and Dyer Road	25.9	C	26.5	C
71	Glassell Street and La Veta Avenue	0.83	D	0.77	C
72	Glassell Street and SR-22 WB Ramps	30.1	C	33.4	C
73	Glassell Street / Grand Avenue and SR-22 EB Ramps	29.6	C	31.8	C
74	Grand Avenue and Fairhaven Avenue	0.57	A	0.67	B
75	Grand Avenue and Santa Clara Avenue	0.80	C	0.73	C
76	Grand Avenue and 17th Street	0.86	D	0.85	D
77	Grand Avenue and I-5 NB Ramps	15.3	B	11.3	B
78	Grand Avenue and Santa Ana Boulevard	26.3	C	28.5	C
79	Grand Avenue and 1st Street	0.83	D	0.72	C

ID	INTERSECTION	AM		PM	
		V/C or Delay	LOS	V/C or Delay	LOS
80	Grand Avenue and Chestnut Avenue	0.94	E	0.78	C
81	Grand Avenue and McFadden Avenue	1.01	F	0.81	D
82	Grand Avenue and Edinger Avenue	0.90	D	1.08	F
83	Grand Avenue and Warner Avenue	0.66	B	0.90	D
84	SR-55 NB Ramps and Dyer Road	17.3	B	6.0	A
85	Cambridge Street and La Veta Avenue	23.4	C	26.1	D
86	Cambridge Street and Fairhaven Avenue	0.62	B	0.53	A
87	Mabury Street and 1st Street	27.4	C	27.2	C
88	Tustin Street and La Veta Avenue	0.36	A	0.34	A
89	Tustin Street and SR-22 WB On-Ramp	13.2	B	7.7	A
90	Tustin Street and SR-22 EB Off-Ramp / Seba Avenue	23.8	C	23.3	C
91	Tustin Street and Fairhaven Avenue	1.24	F	0.76	C
92	Tustin Avenue and Santa Clara Avenue	1.10	F	0.78	C
93	Tustin Avenue and 17th Street	0.81	D	0.74	C
94	Tustin Avenue and 4th Street	0.79	C	0.78	C
95	SR-55 SB Ramps / Auto Mall Drive and Edinger Avenue	25.1	C	25.4	C
96	SR-55 NB Ramps / Del Amo Avenue and Newport Avenue	25.6	C	46.2	D
97	Red Hill Avenue and Edinger Avenue	0.62	B	0.87	D
98	Red Hill Avenue and Warner Avenue	0.58	A	0.95	E
99	Red Hill Avenue and Barranca Parkway	0.58	A	0.59	A
100	Red Hill Avenue and Alton Parkway	0.93	E	1.49	F
101	Red Hill Avenue and MacArthur Boulevard	0.71	C	0.72	C
102	Red Hill Avenue and Main Street	0.73	C	0.84	D
103	I-5 SB Ramps and Santa Ana Boulevard	17.8	B	19.9	B
104	Tustin Ranch Road and Warner Avenue	0.53	A	0.67	B
105	Von Karman Avenue and Barranca Parkway	0.93	E	1.28	F

Notes: (1) LOS – Level of Service; (2) V/C – Volume to Capacity

8.0 VMT and LOS Analysis

This section presents the significant impact analysis for the Future Year (2045) With Project scenario. Significant impacts are identified based on the criteria established in Section 3.1.

8.1 VMT IMPACT ANALYSIS

Per the City’s VMT Guidelines, VMT impacts are to be identified for the Future Year (2045) With Project scenario. VMT impacts were assessed using the methodology described in Section 3.1. The following presents the screening and impact analysis process. First, the two general conditions are considered:

- **Does the project have the potential to reduce VMT/SP?**
 - It should be noted that the project consists of land use and the transportation network changes. Due to the scale of land use changes not all land uses are high-density and/or transit-oriented, thus the land use changes cannot be assumed to have the same VMT-reducing effect as, for example, a TOD Specific Plan. The proposed transportation network, however, has the potential to reduce VMT/SP since it proposes to reclassify streets in order to implement transit, Complete Streets, and active transportation improvements.
- **Is the project consistent with the Regional Transportation Plan (RTP) / Sustainable Communities Strategy’s (SCS)?**
 - While the proposed General Plan does forecast growth beyond the RTP/SCS, it is occurring in a manner consistent with the goals of the RTP/SCS in that growth occurs in high density in/near high-quality transit corridors (HQTC). Additionally, the proposed transportation network supports active transportation and the reduction of VMT.

Since it is not clear that the land use changes will reduce VMT/SP, the project is not eligible to be screened from a full VMT analysis. Project and cumulative impacts are assessed below.

Project Level Impact

A project is considered to have a significant impact if the project VMT/SP (for the land use plan) exceeds 15% below the existing total daily VMT/SP for the County. Table 8-1 provides a summary of the VMT impact analysis for project level impacts. A significant impact at the project level is not expected due to the implementation of the project.

Table 8-1: Future Year (2045) VMT Impact Analysis – Project Impact

Metric	2045 – With Project City VMT/SP	2020 – No Project County VMT/SP	VMT Threshold 15% below 2020 – No Project County VMT/SP	Impact?
VMT/SP	20.3	25.9	22.0	NO

Cumulative Impact

A project is considered to have a significant cumulative impact if the project results in a negative effect on VMT/SP at the citywide level (City VMT/SP is higher with the project than without it). Table 8-2 provides a summary of the VMT impact analysis for project level impacts. A significant cumulative impact is not expected due to the implementation of the project.

Table 8-2: Future Year (2045) VMT Impact Analysis – Cumulative Impact

Metric	2045 – No Project City VMT/SP	2045 – With Project City VMT/SP	Impact?
VMT/SP	22.8	20.3	NO

The VMT impact analysis results show that the project is not expected to cause a significant project level or cumulative impact.

8.2 LEVEL OF SERVICE ASSESSMENT

If an intersection is expected to be significantly impacted due to the implementation of the proposed project, mitigation measures are to be identified such that the project impact is mitigated. This is generally accomplished by returning the V/C or Delay to pre-project levels and/or the resulting LOS to an acceptable LOS. This analysis for intersection LOS is provided here only for analysis with regard to MPAH reclassifications and consistency with OCTA's MPAH guidelines. Intersection LOS analysis is no longer required under CEQA, and the deficient LOS values identified here are not considered to be significant environmental impacts.

The cities of Santa Ana, Costa Mesa, Irvine, Fountain Valley, Tustin, and Orange have established LOS D as their minimum acceptable LOS. Caltrans and the OC CMP established LOS C and E as their minimum acceptable LOS, respectively.

Strategies and improvements to provide acceptable intersection LOS are developed in a manner which first considers lower intensity modifications, such as striping modifications, before considering more complex modifications such as signal controls or physical improvements. All strategies and improvements are subject to the approval of the presiding public authority, including funding and implementation. The City of Santa Ana will pursue the development of a Transportation System Improvement Assessment (TSIA) in order to provide funding for the implementation of the full transportation network buildout, including the strategies and improvements identified in this report.

The Future Year (2045) significant impact summary is provided in Table 8-3. Improvements are identified in Table 8-4. Table 8-5 provides a summary of the intersection performance with the implementation of the mitigation measures.

Unacceptable LOS and traffic impacts are expected at the intersections listed below (peak hour / jurisdiction). The intersection impacts were investigated to determine a probable cause for the impact (land use, transportation network, or both). In order to do this, link volumes and intersection LOS were compared for two scenarios: 1) a year 2045 scenario which includes the proposed General Plan land use updates and utilizes the 2045 baseline (No Project) network described in Section 2.6; and 2) the 2045 With Project scenario which includes all proposed General Plan land use updates and transportation network modifications described in Section 2.7. OCTAM volume comparison plots and a LOS comparison table are provided in Appendix G.

- **INT 3 – Euclid Street and Edinger Avenue (AM peak hour / Fountain Valley)**
 - The impact at this intersection is expected to occur as a result of the proposed reclassifications. Specific improvements to this intersection to address this identified impact are presented in Table 8.4 later in this report. As this impact is in part caused by the proposed MPAH reclassifications, OCTA and the City of Santa Ana will enter into a memorandum of understanding (MOU) that describes the timing and triggers for implementation of the improvements identified in Table 8.4. Additionally, the City of Santa will contribute to improvements based on the calculated fair-share percentage presented in Table 8-4.

- **INT 13 – Harbor Boulevard and Segerstrom Avenue (AM peak hour / Santa Ana)**
 - The impact at this intersection is expected to occur as a result of the proposed land use changes. Specific improvements to this intersection to address this identified impact are presented in Table 8.4 later in this report.

- **INT 34 – Bristol Street and 1st Street (AM and PM peak hour / City of Santa Ana)**
 - The impact at this intersection is expected to occur as a result of the proposed reclassifications. Specific improvements to this intersection to address this identified impact are presented in Table 8.4 later in this report. As this impact is in part caused by the proposed MPAH reclassifications, OCTA and the City of Santa Ana will enter into a memorandum of understanding (MOU) that describes the timing and triggers for implementation of the improvements identified in Table 8.4.

- **INT 36 – Bristol Street and Warner Avenue (AM peak hour / City of Santa Ana)**
 - The impact at this intersection is expected to occur as a result of the proposed reclassifications. Specific improvements to this intersection to address this identified impact are presented in Table 8.4 later in this report. As this impact is in part caused by the proposed MPAH reclassifications, OCTA and the City of Santa Ana will enter into a memorandum of understanding (MOU) that describes the timing and triggers for implementation of the improvements identified in Table 8.4.

- **INT 37 – Bristol Street and Segerstrom Avenue (PM peak hour / City of Santa Ana)**
 - The impact at this intersection is expected to occur as a result of both the proposed land use changes and reclassifications. Specific improvements to this intersection to address this identified impact are presented in Table 8.4 later in this report. As this impact is in part caused by the proposed MPAH reclassifications, OCTA and the City

of Santa Ana will enter into a memorandum of understanding (MOU) that describes the timing and triggers for implementation of the improvements identified in Table 8.4.

- **INT 44 – Flower Street 1st Street (PM peak hour / City of Santa Ana)**
 - The impact at this intersection is expected to occur as a result of both the proposed land use changes and reclassifications. Specific improvements to this intersection to address this identified impact are presented in Table 8.4 later in this report. As this impact is in part caused by the proposed MPAH reclassifications, OCTA and the City of Santa Ana will enter into a memorandum of understanding (MOU) that describes the timing and triggers for implementation of the improvements identified in Table 8.4.
- **INT 46 – Flower Street and Segerstrom Avenue (PM peak hour / City of Santa Ana)**
 - The impact at this intersection is expected to occur as a result of both the proposed land use changes and reclassifications. Specific improvements to this intersection to address this identified impact are presented in Table 8.4 later in this report. As this impact is in part caused by the proposed MPAH reclassifications, OCTA and the City of Santa Ana will enter into a memorandum of understanding (MOU) that describes the timing and triggers for implementation of the improvements identified in Table 8.4.
- **INT 47 – Flower Street and MacArthur Boulevard (PM peak hour / City of Santa Ana)**
 - The impact at this intersection is expected to occur as a result of the proposed land use changes. Specific improvements to this intersection to address this identified impact are presented in Table 8.4 later in this report.
- **INT 55 – Main Street and McFadden Avenue (AM peak hour / City of Santa Ana)**
 - The impact at this intersection is expected to occur as a result of both the proposed land use changes and reclassifications. Specific improvements to this intersection to address this identified impact are presented in Table 8.4 later in this report. As this impact is in part caused by the proposed MPAH reclassifications, OCTA and the City of Santa Ana will enter into a memorandum of understanding (MOU) that describes the timing and triggers for implementation of the improvements identified in Table 8.4.
- **INT 56 – Main Street and Edinger Avenue (PM peak hour / City of Santa Ana)**
 - The impact at this intersection is expected to occur as a result of the proposed reclassifications. Specific improvements to this intersection to address this identified impact are presented in Table 8.4 later in this report. As this impact is in part caused by the proposed MPAH reclassifications, OCTA and the City of Santa Ana will enter into a memorandum of understanding (MOU) that describes the timing and triggers for implementation of the improvements identified in Table 8.4.

- **INT 62 – Santiago Street & Santa Ana Boulevard (AM & PM peak hour / City of Santa Ana)**
 - The impact at this intersection is expected to occur as a result of the proposed reclassifications. Specific improvements to this intersection to address this identified impact are presented in Table 8.4 later in this report. As this impact is in part caused by the proposed MPAH reclassifications, OCTA and the City of Santa Ana will enter into a memorandum of understanding (MOU) that describes the timing and triggers for implementation of the improvements identified in Table 8.4.
- **INT 63 – Standard Avenue and 4th Street (AM and PM peak hour / City of Santa Ana)**
 - The impact at this intersection is expected to occur as a result of the proposed reclassifications. Specific improvements to this intersection to address this identified impact are presented in Table 8.4 later in this report. As this impact is in part caused by the proposed MPAH reclassifications, OCTA and the City of Santa Ana will enter into a memorandum of understanding (MOU) that describes the timing and triggers for implementation of the improvements identified in Table 8.4.
- **INT 64 – Standard Avenue and 1st Street (AM and PM peak hour / City of Santa Ana)**
 - The impact at this intersection is expected to occur as a result of the proposed reclassifications. Specific improvements to this intersection to address this identified impact are presented in Table 8.4 later in this report. As this impact is in part caused by the proposed MPAH reclassifications, OCTA and the City of Santa Ana will enter into a memorandum of understanding (MOU) that describes the timing and triggers for implementation of the improvements identified in Table 8.4.
- **INT 80 – Grand Avenue and Chestnut Avenue (AM peak hour / City of Santa Ana)**
 - The impact at this intersection is expected to occur as a result of the proposed reclassifications. Specific improvements to this intersection to address this identified impact are presented in Table 8.4 later in this report. As this impact is in part caused by the proposed MPAH reclassifications, OCTA and the City of Santa Ana will enter into a memorandum of understanding (MOU) that describes the timing and triggers for implementation of the improvements identified in Table 8.4.
- **INT 81 – Grand Avenue and McFadden Avenue (AM peak hour / City of Santa Ana)**
 - The impact at this intersection is expected to occur as a result of the proposed reclassifications. Specific improvements to this intersection to address this identified impact are presented in Table 8.4 later in this report. As this impact is in part caused by the proposed MPAH reclassifications, OCTA and the City of Santa Ana will enter

into a memorandum of understanding (MOU) that describes the timing and triggers for implementation of the improvements identified in Table 8.4.

- **INT 82 – Grand Avenue and Edinger Avenue (PM peak hour / City of Santa Ana)**
 - The impact at this intersection is expected to occur as a result of the proposed reclassifications. Specific improvements to this intersection to address this identified impact are presented in Table 8.4 later in this report. As this impact is in part caused by the proposed MPAH reclassifications, OCTA and the City of Santa Ana will enter into a memorandum of understanding (MOU) that describes the timing and triggers for implementation of the improvements identified in Table 8.4.
- **INT 91 – Tustin Street and Fairhaven Avenue (AM peak hour / City of Santa Ana)**
 - The impact at this intersection is expected to occur as a result of the proposed reclassifications. Specific improvements to this intersection to address this identified impact are presented in Table 8.4 later in this report. As this impact is in part caused by the proposed MPAH reclassifications, OCTA and the City of Santa Ana will enter into a memorandum of understanding (MOU) that describes the timing and triggers for implementation of the improvements identified in Table 8.4.
- **INT 92 – Tustin Avenue and Santa Clara Avenue (AM peak hour / City of Santa Ana)**
 - The impact at this intersection is expected to occur as a result of the proposed reclassifications. Specific improvements to this intersection to address this identified impact are presented in Table 8.4 later in this report. As this impact is in part caused by the proposed MPAH reclassifications, OCTA and the City of Santa Ana will enter into a memorandum of understanding (MOU) that describes the timing and triggers for implementation of the improvements identified in Table 8.4.
- **INT 96 – SR-55 NB Ramps/Del Amo Avenue & Newport Avenue (PM peak hour / Caltrans)**
 - The impact at this intersection is expected to occur as a result of the proposed land use changes. Specific improvements to this intersection to address this identified impact are presented in Table 8.4 later in this report. Additionally, the City of Santa will contribute to improvements based on the calculated fair-share percentage presented in Table 8-4. Additionally, the City of Santa will contribute to improvements based on the calculated fair-share percentage presented in Table 8-4.
- **INT 98 – Red Hill Avenue and Warner Avenue (PM peak hour / City of Tustin)**
 - The impact at this intersection is expected to occur as a result of the proposed land use changes. Specific improvements to this intersection to address this identified impact are presented in Table 8.4 later in this report. Additionally, the City of Santa will

contribute to improvements based on the calculated fair-share percentage presented in Table 8-4.

- **INT 100 – Red Hill Avenue and Alton Parkway (AM and PM peak hour / City of Irvine)**
 - The impact at this intersection is expected to occur as a result of the proposed land use changes. Specific improvements to this intersection to address this identified impact are presented in Table 8.4 later in this report. Additionally, the City of Santa will contribute to improvements based on the calculated fair-share percentage presented in Table 8-4.

- **INT 105 – Von Karman Avenue and Barranca Parkway (PM peak hour / City of Irvine)**
 - The impact at this intersection is expected to occur as a result of the proposed land use changes. Specific improvements to this intersection to address this identified impact are presented in Table 8.4 later in this report. Additionally, the City of Santa will contribute to improvements based on the calculated fair-share percentage presented in Table 8-4.

In addition to assessing intersection impacts, a performance assessment of study roadway segments was conducted in order to determine the potential adverse effects of the project. Although not considered an environmental impact, changes in roadway performance monitored for congestion management and fair-share contribution purposes. Highlighted below is a roadway segment expected to operate beyond capacity in the future 2045 scenarios; improvements are thus required to accommodate forecasted volumes.

- **Segment #84 – Dyer Road from Pullman Street to Red Hill Avenue (City of Santa Ana)**
 - This segment is expected to operate at LOS F in both the 2045 No Project and 2045 With Project scenarios. Planned improvements include a widening of this section of Dyer Road in order to accommodate forecasted traffic volumes. As of the time this report is written, the City of Irvine is expected to be fully responsible for the improvements. However, considering the project's contribution to traffic volumes the City of Santa Ana will provide a fair-share contribution of 23% for future improvements.

Fair-Share Calculation

As noted, the City of Santa Ana will contribute to intersection improvements based on the fair-share contribution to intersection volumes due to the proposed MPAH reclassifications. The fair-share for a given intersection is calculated using the formula shown below and is presented in Table 8-4 for each intersection which is not, or only partially, under the jurisdiction of the City of Santa Ana. Fair-share is the portion of new traffic generated by the project as a percentage of the total change in traffic from the existing year analysis.

$$\text{Fair – Share (\%)} = \left(\frac{\text{Future With Project Volume} - \text{Future No Project Volume}}{\text{Future With Project Volume} - \text{Existing No Project Volume}} \right) \times 100\%$$

Table 8-3: Future Year (2045) LOS Impact Summary

ID	INTERSECTION	PEAK HOUR	2045 No Project		2045 With Project		DELTA	LOS IMPACT?
			V/C or Delay	LOS	V/C or Delay	LOS		
1	Euclid Street and Bolsa Avenue	AM	0.86	D	0.79	C	-0.07	NO
		PM	0.86	D	0.79	C	-0.07	NO
2	Euclid Street and McFadden Avenue	AM	0.98	E	0.91	E	-0.07	NO
		PM	0.90	D	0.79	C	-0.11	NO
3	Euclid Street and Edinger Avenue	AM	0.99	E	1.01	F	0.02	YES
		PM	0.89	D	0.86	D	-0.03	NO
4	Newhope Street and Hazard Avenue	AM	0.78	C	0.60	A	-0.18	NO
		PM	0.72	C	0.52	A	-0.20	NO
5	Newhope Street and McFadden Avenue	AM	0.83	D	0.73	C	-0.10	NO
		PM	0.78	C	0.68	B	-0.10	NO
6	Harbor Boulevard and SR-22 WB Off-Ramp / Banner Drive	AM	28.4	C	28.5	C	0.1	NO / NO *
		PM	24.2	C	23.8	C	-0.4	NO / NO *
7	Trask Avenue and SR-22 EB On-Ramp	AM	12.0	B	11.0	B	-1.0	NO
		PM	13.6	B	11.0	B	-2.6	NO
8	Harbor Boulevard and Westminster Avenue	AM	0.99	E	0.94	E	-0.05	NO
		PM	0.88	D	0.84	D	-0.04	NO
9	Harbor Boulevard and 1st Street	AM	0.79	C	0.75	C	-0.04	NO
		PM	0.78	C	0.75	C	-0.03	NO
10	Harbor Boulevard and McFadden Avenue	AM	0.79	C	0.73	C	-0.06	NO
		PM	0.81	D	0.71	C	-0.10	NO
11	Harbor Boulevard and Edinger Avenue	AM	0.84	D	0.86	D	0.02	NO
		PM	0.73	C	0.72	C	-0.01	NO
12	Harbor Boulevard and Warner Avenue	AM	0.79	C	0.80	C	0.01	NO
		PM	1.54	F	1.54	F	0.00	NO
13	Harbor Boulevard and Segerstrom Avenue	AM	0.97	E	1.01	F	0.04	YES

ID	INTERSECTION	PEAK HOUR	2045 No Project		2045 With Project		DELTA	LOS IMPACT?
			V/C or Delay	LOS	V/C or Delay	LOS		
		PM	0.92	E	0.93	E	0.01	NO
14	Hyland Avenue / OCTA Bus Base and MacArthur Boulevard	AM	0.61	B	0.62	B	0.01	NO
		PM	0.92	E	0.89	D	-0.03	NO
15	Harbor Boulevard and MacArthur Boulevard	AM	0.74	C	0.75	C	0.01	NO
		PM	0.78	C	0.79	C	0.01	NO
16	Harbor Boulevard and Sunflower Avenue	AM	0.70	B	0.71	C	0.01	NO
		PM	0.72	C	0.71	C	-0.01	NO
17	Harbor Boulevard and I-405 NB Off-Ramp	AM	18.0	B	17.9	B	-0.1	NO / NO *
		PM	18.3	B	18.8	B	0.5	NO / NO *
18	Harbor Boulevard and I-405 SB Off-Ramp	AM	15.0	B	15.0	B	0.0	NO / NO *
		PM	17.9	B	18.1	B	0.2	NO / NO *
19	Fairview Street and Civic Center Drive	AM	0.74	C	0.68	B	-0.06	NO
		PM	0.76	C	0.71	C	-0.05	NO
20	Fairview Street and 1st Street	AM	0.86	D	0.89	D	0.03	NO
		PM	0.90	D	0.89	D	-0.01	NO
21	Fairview Street and McFadden Avenue	AM	0.80	C	0.80	C	0.00	NO
		PM	0.78	C	0.68	B	-0.10	NO
22	Fairview Street and Edinger Avenue	AM	0.86	D	0.88	D	0.02	NO
		PM	0.92	E	0.92	E	0.00	NO
23	Fairview Street and Warner Avenue	AM	0.82	D	0.85	D	0.03	NO
		PM	0.80	C	0.81	D	0.01	NO
24	Fairview Street and MacArthur Boulevard	AM	0.68	B	0.69	B	0.01	NO
		PM	0.77	C	0.76	C	-0.01	NO
25	Fairview Road and Sunflower Avenue	AM	0.70	B	0.69	B	-0.01	NO
		PM	0.72	C	0.69	B	-0.03	NO
26	Greenville Street and Edinger Avenue	AM	0.77	C	0.74	C	-0.03	NO
		PM	0.60	A	0.65	B	0.05	NO

ID	INTERSECTION	PEAK HOUR	2045 No Project		2045 With Project		DELTA	LOS IMPACT?
			V/C or Delay	LOS	V/C or Delay	LOS		
27	Greenville Street and Segerstrom Avenue	AM	0.84	D	0.88	D	0.04	NO
		PM	0.78	C	0.80	C	0.02	NO
28	Raitt Street and McFadden Avenue	AM	0.78	C	0.70	B	-0.08	NO
		PM	0.76	C	0.68	B	-0.08	NO
29	Raitt Street and Edinger Avenue	AM	0.99	E	0.93	E	-0.06	NO
		PM	0.99	E	0.99	E	0.00	NO
30	Bear Street and MacArthur Boulevard	AM	0.71	C	0.76	C	0.05	NO
		PM	0.85	D	0.90	D	0.05	NO
31	Bristol Street and 17th Street	AM	0.87	D	0.85	D	-0.02	NO
		PM	0.82	D	0.81	D	-0.01	NO
32	Bristol Street and Civic Center Drive	AM	0.94	E	0.93	E	-0.01	NO
		PM	0.91	E	0.90	D	-0.01	NO
33	Bristol Street and Santa Ana Boulevard	AM	0.81	D	0.72	C	-0.09	NO
		PM	0.85	D	0.73	C	-0.12	NO
34	Bristol Street and 1st Street	AM	0.77	C	0.90	D	0.13	NO
		PM	0.83	D	0.97	E	0.14	YES
35	Bristol Street and McFadden Avenue	AM	0.96	E	0.95	E	-0.01	NO
		PM	1.03	F	0.89	D	-0.14	NO
36	Bristol Street and Warner Avenue	AM	0.92	E	0.96	E	0.04	YES
		PM	0.85	D	0.87	D	0.02	NO
37	Bristol Street and Segerstrom Avenue	AM	0.81	D	0.85	D	0.04	NO
		PM	0.87	D	0.92	E	0.05	YES
38	Bristol Street and Alton Avenue	AM	0.55	A	0.55	A	0.00	NO
		PM	0.63	B	0.58	A	-0.05	NO
39	Bristol Street and MacArthur Boulevard	AM	0.70	B	0.76	C	0.06	NO
		PM	0.77	C	0.80	C	0.03	NO
40	Bristol Street and Sunflower Avenue	AM	0.65	B	0.68	B	0.03	NO

ID	INTERSECTION	PEAK HOUR	2045 No Project		2045 With Project		DELTA	LOS IMPACT?
			V/C or Delay	LOS	V/C or Delay	LOS		
		PM	0.69	B	0.74	C	0.05	NO
41	Bristol Street and I-405 NB Ramps	AM	20.8	C	20.9	C	0.1	NO
		PM	28.5	C	29.0	C	0.5	NO
42	Bristol Street and I-405 SB Ramps	AM	23.9	C	23.6	C	-0.3	NO
		PM	18.3	B	18.2	B	-0.1	NO
43	Flower Street and Santa Ana Boulevard	AM	0.81	D	0.59	A	-0.22	NO
		PM	0.86	D	0.67	B	-0.19	NO
44	Flower Street and 1st Street	AM	0.93	E	0.93	E	0.00	NO
		PM	0.88	D	1.22	F	0.34	YES
45	Flower Street and McFadden Avenue	AM	0.90	D	0.81	D	-0.09	NO
		PM	1.04	F	0.97	E	-0.07	NO
46	Flower Street and Segerstrom Avenue	AM	0.78	C	0.82	D	0.04	NO
		PM	0.87	D	0.92	E	0.05	YES
47	Flower Street and MacArthur Boulevard	AM	0.68	B	0.71	C	0.03	NO
		PM	0.90	D	0.91	E	0.01	YES
48	Main Street and La Veta Avenue	AM	0.59	A	0.54	A	-0.05	NO
		PM	0.70	B	0.76	C	0.06	NO
49	Main Street and Mainplace Drive / Memory Lane	AM	0.51	A	0.46	A	-0.05	NO
		PM	0.56	A	0.50	A	-0.06	NO
50	Main Street and 17th Street	AM	0.88	D	0.85	D	-0.03	NO
		PM	0.76	C	0.80	C	0.04	NO
51	Main Street and Civic Center Drive	AM	0.78	C	0.85	D	0.07	NO
		PM	0.97	E	0.86	D	-0.11	NO
52	Main Street and Santa Ana Boulevard	AM	0.93	E	0.79	C	-0.14	NO
		PM	0.79	C	0.70	B	-0.09	NO
53	Main Street and 4th Street	AM	0.41	A	0.44	A	0.03	NO
		PM	0.45	A	0.47	A	0.02	NO

ID	INTERSECTION	PEAK HOUR	2045 No Project		2045 With Project		DELTA	LOS IMPACT?
			V/C or Delay	LOS	V/C or Delay	LOS		
54	Main Street and 1st Street	AM	0.68	B	0.75	C	0.07	NO
		PM	0.74	C	0.80	C	0.06	NO
55	Main Street and McFadden Avenue	AM	0.89	D	0.92	E	0.03	YES
		PM	0.93	E	0.94	E	0.01	NO
56	Main Street and Edinger Avenue	AM	0.80	C	0.88	D	0.08	NO
		PM	0.87	D	0.98	E	0.11	YES
57	Main Street and MacArthur Boulevard	AM	0.68	B	0.72	C	0.04	NO
		PM	0.75	C	0.78	C	0.03	NO
58	Penn Way and 17th Street	AM	12.2	B	12.1	B	-0.1	NO
		PM	25.5	C	20.3	C	-5.2	NO
59	Santiago Street / I-5 NB Ramps and 17th Street	AM	30.0	C	31.4	C	1.4	NO
		PM	19.0	B	20.3	C	1.3	NO
60	Penn Way and I-5 SB Ramps	AM	21.2	C	19.5	B	-1.7	NO
		PM	23.0	C	22.8	C	-0.2	NO
61	Santiago Street and Civic Center Drive	AM	159.2	F	62.6	F	-96.6	NO
		PM	110.0	F	27.6	D	-82.4	NO
62	Santiago Street and Santa Ana Boulevard	AM	1.04	F	1.44	F	0.40	YES
		PM	1.02	F	1.41	F	0.39	YES
63	Standard Avenue and 4th Street	AM	0.94	E	1.34	F	0.40	YES
		PM	0.89	D	1.34	F	0.45	YES
64	Standard Avenue and 1st Street	AM	0.98	E	1.52	F	0.54	YES
		PM	0.97	E	1.48	F	0.51	YES
65	Standard Avenue and McFadden Avenue	AM	0.85	D	0.84	D	-0.01	NO
		PM	0.83	D	0.77	C	-0.06	NO
66	Halladay Street and Warner Avenue	AM	0.78	C	0.69	B	-0.09	NO
		PM	0.97	E	0.82	D	-0.16	NO
67	Halladay Street and Dyer Road	AM	0.77	C	0.67	B	-0.10	NO

ID	INTERSECTION	PEAK HOUR	2045 No Project		2045 With Project		DELTA	LOS IMPACT?
			V/C or Delay	LOS	V/C or Delay	LOS		
		PM	1.06	F	0.95	E	-0.11	NO
68	SR-55 SB Ramps and MacArthur Boulevard	AM	19.9	B	20.2	C	0.3	NO
		PM	17.8	B	18.4	B	0.6	NO
69	SR-55 NB Ramps and MacArthur Boulevard	AM	19.3	B	19.5	B	0.2	NO
		PM	14.6	B	16.2	B	1.6	NO
70	SR-55 SB Ramps and Dyer Road	AM	25.7	C	25.9	C	0.2	NO
		PM	26.5	C	26.5	C	0.0	NO
71	Glassell Street and La Veta Avenue	AM	0.80	C	0.83	D	0.03	NO
		PM	0.74	C	0.77	C	0.03	NO
72	Glassell Street and SR-22 WB Ramps	AM	32.6	C	30.1	C	-2.5	NO
		PM	30.5	C	33.4	C	2.9	NO
73	Glassell Street / Grand Avenue and SR-22 EB Ramps	AM	30.6	C	29.6	C	-1.0	NO
		PM	31.6	C	31.8	C	0.2	NO
74	Grand Avenue and Fairhaven Avenue	AM	0.61	B	0.57	A	-0.04	NO
		PM	0.72	C	0.67	B	-0.05	NO
75	Grand Avenue and Santa Clara Avenue	AM	0.84	D	0.80	C	-0.04	NO
		PM	0.81	D	0.73	C	-0.08	NO
76	Grand Avenue and 17th Street	AM	0.79	C	0.86	D	0.07	NO
		PM	0.86	D	0.85	D	-0.01	NO
77	Grand Avenue and I-5 NB Ramps	AM	13.2	B	15.3	B	2.1	NO
		PM	10.1	B	11.3	B	1.2	NO
78	Grand Avenue and Santa Ana Boulevard	AM	26.0	C	26.3	C	0.3	NO
		PM	25.3	C	28.5	C	3.2	NO
79	Grand Avenue and 1st Street	AM	0.74	C	0.83	D	0.09	NO
		PM	0.73	C	0.72	C	-0.01	NO
80	Grand Avenue and Chestnut Avenue	AM	0.70	B	0.94	E	0.24	YES
		PM	0.69	B	0.78	C	0.09	NO

ID	INTERSECTION	PEAK HOUR	2045 No Project		2045 With Project		DELTA	LOS IMPACT?
			V/C or Delay	LOS	V/C or Delay	LOS		
81	Grand Avenue and McFadden Avenue	AM	0.89	D	1.01	F	0.12	YES
		PM	0.82	D	0.81	D	-0.01	NO
82	Grand Avenue and Edinger Avenue	AM	0.84	D	0.90	D	0.06	NO
		PM	1.00	E	1.08	F	0.08	YES
83	Grand Avenue and Warner Avenue	AM	0.61	B	0.66	B	0.05	NO
		PM	0.83	D	0.90	D	0.07	NO
84	SR-55 NB Ramps and Dyer Road	AM	17.1	B	17.3	B	0.2	NO
		PM	5.7	A	6.0	A	0.3	NO
85	Cambridge Street and La Veta Avenue	AM	31.6	D	23.4	C	-8.2	NO
		PM	19.7	C	26.1	D	6.4	NO
86	Cambridge Street and Fairhaven Avenue	AM	0.56	A	0.62	B	0.06	NO
		PM	0.45	A	0.53	A	0.08	NO
87	Mabury Street and 1st Street	AM	27.4	C	27.4	C	0.0	NO / NO *
		PM	27.1	C	27.2	C	0.1	NO / NO *
88	Tustin Street and La Veta Avenue	AM	0.45	A	0.36	A	-0.09	NO
		PM	0.38	A	0.34	A	-0.04	NO
89	Tustin Street and SR-22 WB On-Ramp	AM	12.2	B	13.2	B	1.0	NO
		PM	11.1	B	7.7	A	-3.4	NO
90	Tustin Street and SR-22 EB Off-Ramp / Seba Avenue	AM	25.0	C	23.8	C	-1.2	NO
		PM	23.1	C	23.3	C	0.2	NO
91	Tustin Street and Fairhaven Avenue	AM	1.20	F	1.24	F	0.04	YES
		PM	0.69	B	0.76	C	0.07	NO
92	Tustin Avenue and Santa Clara Avenue	AM	1.04	F	1.10	F	0.06	YES
		PM	0.71	C	0.78	C	0.07	NO
93	Tustin Avenue and 17th Street	AM	0.91	E	0.81	D	-0.10	NO
		PM	0.80	C	0.74	C	-0.06	NO
94	Tustin Avenue and 4th Street	AM	0.83	D	0.79	C	-0.04	NO

ID	INTERSECTION	PEAK HOUR	2045 No Project		2045 With Project		DELTA	LOS IMPACT?
			V/C or Delay	LOS	V/C or Delay	LOS		
		PM	0.71	C	0.78	C	0.07	NO
95	SR-55 SB Ramps / Auto Mall Drive and Edinger Avenue	AM	25.2	C	25.1	C	-0.1	NO / NO *
		PM	25.5	C	25.4	C	-0.1	NO / NO *
96	SR-55 NB Ramps / Del Amo Avenue and Newport Avenue	AM	25.4	C	25.6	C	0.2	NO
		PM	39.1	D	46.2	D	7.1	YES
97	Red Hill Avenue and Edinger Avenue	AM	0.61	B	0.62	B	0.01	NO
		PM	0.85	D	0.87	D	0.02	NO
98	Red Hill Avenue and Warner Avenue	AM	0.56	A	0.58	A	0.02	NO
		PM	0.88	D	0.95	E	0.07	YES
99	Red Hill Avenue and Barranca Parkway	AM	0.55	A	0.58	A	0.03	NO
		PM	0.54	A	0.59	A	0.05	NO
100	Red Hill Avenue and Alton Parkway	AM	0.86	D	0.93	E	0.07	YES
		PM	1.18	F	1.49	F	0.31	YES
101	Red Hill Avenue and MacArthur Boulevard	AM	0.69	B	0.71	C	0.02	NO
		PM	0.70	B	0.72	C	0.02	NO
102	Red Hill Avenue and Main Street	AM	0.72	C	0.73	C	0.01	NO
		PM	0.81	D	0.84	D	0.03	NO
103	I-5 SB Ramps and Santa Ana Boulevard	AM	17.4	B	17.8	B	0.4	NO
		PM	18.4	B	19.9	B	1.5	NO
104	Tustin Ranch Road and Warner Avenue	AM	0.52	A	0.53	A	0.01	NO
		PM	0.65	B	0.67	B	0.02	NO
105	Von Karman Avenue and Barranca Parkway	AM	0.93	E	0.93	E	0.00	NO
		PM	1.23	F	1.28	F	0.05	YES

*Intersection is a Caltrans intersection and also part of OC CMP; XX/YY denotes LOS impacts per Caltrans/CMP impact criteria, respectively.

Table 8-4: LOS Improvement Measures

ID	INTERSECTION	IMPROVEMENT
3	Euclid Street and Edinger Avenue	<ul style="list-style-type: none"> • Alternative 1 <ul style="list-style-type: none"> ○ Convert the WB right-turn lane into a shared thru-right. • Alternative 2 <ul style="list-style-type: none"> ○ Add EB-LT lane. • Alternative 3 <ul style="list-style-type: none"> ○ Add LT lane for EB and WB directions. • Fair-Share: 9.0% (AM)
13	Harbor Boulevard and Segerstrom Avenue	<ul style="list-style-type: none"> • Add a second WB left-turn lane. • Change WB and EB left-turn control to protected.
34	Bristol Street and 1st Street	<ul style="list-style-type: none"> • Maintain 2045 NP configuration for WB approach. <ul style="list-style-type: none"> ○ WB approach to be: 1L, 2T, 1TR • Add EB right-turn pocket.
36	Bristol Street and Warner Avenue	<ul style="list-style-type: none"> • Feasible improvements could not be identified.
37	Bristol Street and Segerstrom Avenue	<ul style="list-style-type: none"> • Maintain 2045 NP configurations for EB/WB approaches. <ul style="list-style-type: none"> ○ EB/WB approaches to be: 1LT, 2T, 1TR • Add NB right-turn pocket.
44	Flower Street and 1st Street	<ul style="list-style-type: none"> • Maintain 2045 NP configurations for NB approach. <ul style="list-style-type: none"> ○ NB approach to be: 1L, 2T, 1R
46	Flower Street and Segerstrom Avenue	<ul style="list-style-type: none"> • Feasible improvements could not be identified.
47	Flower Street and MacArthur Boulevard	<ul style="list-style-type: none"> • Feasible improvements could not be identified.
55	Main Street and McFadden Avenue	<ul style="list-style-type: none"> • Feasible improvements could not be identified.
56	Main Street and Edinger Avenue	<ul style="list-style-type: none"> • Feasible improvements could not be identified.
62	Santiago Street and Santa Ana Boulevard	<ul style="list-style-type: none"> • Feasible improvements could not be identified.

ID	INTERSECTION	IMPROVEMENT
63	Standard Avenue and 4th Street	<ul style="list-style-type: none"> • Maintain 2045 NP conditions. <ul style="list-style-type: none"> ○ NB / SB to be: 1L, 1T, 1R ○ EB / WB to be: 1L, 1T, 1TR
64	Standard Avenue and 1st Street	<ul style="list-style-type: none"> • Feasible improvements could not be identified.
80	Grand Avenue and Chestnut Avenue	<ul style="list-style-type: none"> • Feasible improvements could not be identified.
81	Grand Avenue and McFadden Avenue	<ul style="list-style-type: none"> • Maintain 2045 NP configuration for EB approach <ul style="list-style-type: none"> ○ EB approach to be: 1L, 1T, 1TR
82	Grand Avenue and Edinger Avenue	<ul style="list-style-type: none"> • Feasible improvements could not be identified.
91	Tustin Street and Fairhaven Avenue	<ul style="list-style-type: none"> • Maintain 2045 NP lane configurations for EB and WB approaches <ul style="list-style-type: none"> ○ EB approach to be: 1L, 1T, 1TR ○ WB approach to be: 1L, 1T, 1R
92	Tustin Avenue and Santa Clara Avenue	<ul style="list-style-type: none"> • Maintain 2045 NP lane configurations for EB and WB approaches. <ul style="list-style-type: none"> ○ EB and WB approaches to be: 1L, 1T, 1TR
96	SR-55 NB Ramps / Del Amo Avenue and Newport Avenue	<ul style="list-style-type: none"> • Add a second SB right-turn lane. • Fair-Share: 10.6% (PM)
98	Red Hill Avenue and Warner Avenue	<ul style="list-style-type: none"> • Add a left-turn lane to the EB approach. • Fair-Share: 17.3% (PM)
100	Red Hill Avenue and Alton Parkway	<ul style="list-style-type: none"> • Add a NB thru lane. • Add a left-turn lane and a shared thru-right to the EB approach. • Convert the WB right-turn lane into a shared thru-right. • Fair-Share: 21.0% (AM) / 34.7% (PM)
105	Von Karman Avenue and Barranca Parkway	<ul style="list-style-type: none"> • Convert one (1) WB thru lane into a shared thru-right. • Fair-Share: 14.1% (PM)

Table 8-5: Future Year (2045) With Project – Mitigated Impact Summary

ID	INTERSECTION	PEAK HOUR	2045 No Project		2045 With Project		DELTA	IMPACT?	2045 With Project – Mit.		DELTA	IMPACT?
			V/C or Delay	LOS	V/C or Delay	LOS			V/C or Delay	LOS		
3	Euclid Street and Edinger Avenue (with Alternative 1 measure)	AM	0.99	E	1.01	F	0.02	YES	1.00	E	0.01	NO
		PM	0.89	D	0.86	D	-0.03	NO	0.80	D	-0.09	NO
3	Euclid Street and Edinger Avenue (with Alternative 2 measure)	AM	0.99	E	1.01	F	0.02	YES	1.00	E	0.01	NO
		PM	0.89	D	0.86	D	-0.03	NO	0.82	D	-0.07	NO
3	Euclid Street and Edinger Avenue (with Alternative 3 measure)	AM	0.99	E	1.01	F	0.02	YES	0.97	E	-0.02	NO
		PM	0.89	D	0.86	D	-0.03	NO	0.82	D	-0.07	NO
13	Harbor Boulevard and Segerstrom Avenue	AM	0.97	E	1.01	F	0.04	YES	0.96	E	-0.01	NO
		PM	0.92	E	0.93	E	0.01	NO	0.93	E	0.01	NO
34	Bristol Street and 1st Street	AM	0.77	C	0.90	D	0.13	NO	0.79	C	0.02	NO
		PM	0.83	D	0.97	E	0.14	YES	0.87	D	0.04	NO
36	Bristol Street and Warner Avenue	AM	0.92	E	0.96	E	0.04	YES	0.96	E	0.04	YES
		PM	0.85	D	0.87	D	0.02	NO	0.87	D	0.02	NO
37	Bristol Street and Segerstrom Avenue	AM	0.81	D	0.85	D	0.04	NO	0.81	D	0.00	NO
		PM	0.87	D	0.92	E	0.05	YES	0.87	D	0.00	NO
44	Flower Street and 1st Street	AM	0.93	E	0.93	E	0.00	NO	0.93	E	0.00	NO
		PM	0.88	D	1.22	F	0.34	YES	0.92	E	0.04	YES
46	Flower Street and Segerstrom Avenue	AM	0.78	C	0.82	D	0.04	NO	0.82	D	0.04	NO
		PM	0.87	D	0.92	E	0.05	YES	0.92	E	0.05	YES
47	Flower Street and Macarthur Boulevard	AM	0.68	B	0.71	C	0.03	NO	0.71	C	0.03	NO
		PM	0.90	D	0.91	E	0.01	YES	0.91	E	0.01	YES
55	Main Street and McFadden Avenue	AM	0.89	D	0.92	E	0.03	YES	0.92	E	0.03	YES
		PM	0.93	E	0.94	E	0.01	NO	0.94	E	0.01	NO
56	Main Street and Edinger Avenue	AM	0.80	C	0.88	D	0.08	NO	0.88	D	0.08	NO
		PM	0.87	D	0.98	E	0.11	YES	0.98	E	0.11	YES

ID	INTERSECTION	PEAK HOUR	2045 No Project		2045 With Project		DELTA	IMPACT?	2045 With Project – Mit.		DELTA	IMPACT?
			V/C or Delay	LOS	V/C or Delay	LOS			V/C or Delay	LOS		
62	Santiago Street and Santa Ana Boulevard	AM	1.04	F	1.44	F	0.40	YES	1.44	F	0.40	YES
		PM	1.02	F	1.41	F	0.39	YES	1.41	F	0.39	YES
63	Standard Avenue and 4th Street	AM	0.94	E	1.34	F	0.40	YES	1.06	F	0.12	YES
		PM	0.89	D	1.34	F	0.45	YES	1.03	F	0.14	YES
64	Standard Avenue and 1st Street	AM	0.98	E	1.52	F	0.54	YES	1.52	F	0.54	YES
		PM	0.97	E	1.48	F	0.51	YES	1.48	F	0.51	YES
80	Grand Avenue and Chestnut Avenue	AM	0.70	B	0.94	E	0.24	YES	0.94	E	0.24	YES
		PM	0.69	B	0.78	C	0.09	NO	0.78	C	0.09	NO
81	Grand Avenue and McFadden Avenue	AM	0.89	D	1.01	F	0.12	YES	0.86	D	-0.03	NO
		PM	0.82	D	0.81	D	-0.01	NO	0.81	D	-0.01	NO
82	Grand Avenue and Edinger Avenue	AM	0.84	D	0.90	D	0.06	NO	0.90	D	0.06	NO
		PM	1.00	E	1.08	F	0.08	YES	1.08	F	0.08	YES
91	Tustin Street and Fairhaven Avenue	AM	1.20	F	1.24	F	0.04	YES	1.06	F	-0.14	NO
		PM	0.69	B	0.76	C	0.07	NO	0.64	B	-0.05	NO
92	Tustin Avenue and Santa Clara Avenue	AM	1.04	F	1.10	F	0.06	YES	0.94	E	-0.10	NO
		PM	0.71	C	0.78	C	0.07	NO	0.68	B	-0.03	NO
96	SR-55 NB Ramps / Del Amo Avenue and Newport Avenue	AM	25.4	C	25.6	C	0.2	NO	24.4	C	-1.0	NO
		PM	39.1	D	46.2	D	7.1	YES	28.5	C	-10.6	NO
98	Red Hill Avenue and Warner Avenue	AM	0.56	A	0.58	A	0.02	NO	0.56	A	0.00	NO
		PM	0.88	D	0.95	E	0.07	YES	0.80	D	-0.08	NO
100	Red Hill Avenue and Alton Parkway	AM	0.86	D	0.93	E	0.07	YES	0.68	B	-0.18	NO
		PM	1.18	F	1.49	F	0.31	YES	1.28	F	0.10	YES
105	Von Karman Avenue and Barranca Parkway	AM	0.93	E	0.93	E	0.00	NO	0.93	E	0.00	NO
		PM	1.23	F	1.28	F	0.05	YES	1.24	F	0.01	NO

As shown in Table 8-5, impacts are expected to remain at the following intersections:

- **INT 36 – Bristol Street and Warner Avenue (City of Santa Ana)**
 - Due to limited right-of-way, feasible improvements could not be developed. The LOS cannot be returned to an acceptable LOS; the impact is to remain in the AM peak hour.
- **INT 44 – Flower Street and 1st Street (City of Santa Ana)**
 - A mitigation measure was developed but only resulted in partial mitigation of the impact. The LOS cannot be returned to an acceptable LOS; the impact is to remain in the PM peak hour.
- **INT 46 – Flower Street and Segerstrom Avenue (City of Santa Ana)**
 - Due to limited right-of-way, feasible improvements could not be developed. The LOS cannot be returned to an acceptable LOS; the impact is to remain in the PM peak hour.
- **INT 47 – Flower Street and Segerstrom Avenue (City of Santa Ana)**
 - Due to limited right-of-way, feasible improvements could not be developed. The LOS cannot be returned to an acceptable LOS; the impact is to remain in the PM peak hour.
- **INT 55 – Main Street and McFadden Avenue (City of Santa Ana)**
 - Due to limited right-of-way, feasible improvements could not be developed. The LOS cannot be returned to an acceptable LOS; the impact is to remain in the AM peak hour.
- **INT 56 – Main Street and Edinger Avenue (City of Santa Ana)**
 - Due to limited right-of-way, feasible improvements could not be developed. The LOS cannot be returned to an acceptable LOS; the impact is to remain in the PM peak hour.
- **INT 62 – Santiago Street and Santa Ana Boulevard (City of Santa Ana)**
 - Due to limited right-of-way and the implementation of the OC Streetcar, a mitigation measure was developed but only resulted in partial mitigation of the impact. The LOS cannot be returned to an acceptable LOS; the impact is to remain in the AM and PM peak hours.
- **INT 63 – Standard Avenue and 4th Street (City of Santa Ana)**
 - A mitigation measure was developed but only resulted in partial mitigation of the impact. The LOS cannot be returned to an acceptable LOS; the impact is to remain in the AM and PM peak hours.

- **INT 64 – Standard Avenue and 1st Street (City of Santa Ana)**
 - Due to limited right-of-way and the planned implementation of the bike lanes along both Standard Avenue and First Street, no feasible improvements were identified. The LOS cannot be returned to an acceptable LOS; the impact is to remain in the AM and PM peak hours.
- **INT 80 – Grand Avenue and Chestnut Avenue (City of Santa Ana)**
 - Due to limited right-of-way and the planned implementation of the bike lanes along Chestnut Avenue, no feasible improvements were identified. The LOS cannot be returned to an acceptable LOS; the impact is to remain in the AM peak hour.
- **INT 82 – Grand Avenue and Edinger Avenue (City of Santa Ana)**
 - Due to limited right-of-way, feasible improvements could not be developed. The LOS cannot be returned to an acceptable LOS; the impact is to remain in the PM peak hour.
- **INT 100 – Red Hill Avenue and Alton Parkway (City of Irvine)**
 - Due to limited right-of-way, a mitigation measure was developed and resulted in mitigating the impacts in the AM peak hour only. The LOS cannot be returned to an acceptable LOS in the PM peak hour; additionally, the impact is to remain in the PM peak hour.

9.0 Conclusions

This traffic analysis report has been prepared in support of the General Plan Update (GPU) Draft Program Environmental Impact Report (PEIR) for the City of Santa Ana and to assess requested changes to the Orange County Transportation Authority's (OCTA) Master Plan of Arterial Highways (MPAH) by the City of Santa Ana. The purpose of this study is to identify traffic impacts due to the implementation of the proposed project (General Plan update). This study was prepared in conformance with CEQA guidelines and in consultation with the OPR Technical Advisory as well as the traffic impact analysis guidelines for the City of Santa Ana and local jurisdictions. CEQA identifies VMT as the preferred metric for identifying environmental impacts. However, intersection impacts and roadway LOS are also evaluated in order to address local network performance. A summary of the analysis is provided below.

9.1 VMT IMPACT ANALYSIS

A VMT analysis was conducted to determine impacts due to the implementation of the project. The project was evaluated to determine the potential project level and cumulative impacts.

A project is considered to have a significant impact at the project level if the project VMT/SP (for the land use plan) exceeds 15% below the existing total daily VMT/SP for the County. The VMT impact threshold (15% below the 2020 – No Project County VMT/SP) is 22.0 VMT/SP. The project resulted in a 2045 – With Project City VMT/SP of 20.3 VMT/SP. Thus, the project does not result in a project level VMT impact.

A project is considered to have a significant cumulative impact if the project results in a negative effect on VMT/SP at the citywide level (City VMT/SP is higher with the project than without it). The VMT impact threshold (2045 – No Project City VMT/SP) is 22.8 VMT/SP. The project resulted in a 2045 – With Project City VMT/SP of 20.3 VMT/SP. The project does not result in a negative impact on citywide VMT, therefore does not result in a cumulative impact.

9.2 INTERSECTION LOS ANALYSIS

An intersection impact analysis was conducted in order to determine projects impacts related to the OCTA MPAH and City-level LOS guidelines at study intersections. It should be noted that intersection impacts may be identified but are not indicative of an environmental impact, per CEQA. Significant impacts are expected at twenty-four (24) study intersections for the Future year (2045) With Project scenario. Mitigation of the impacts is not required for CEQA conformance, but measures were developed to address local network performance. All mitigation measures are subject to the approval of the presiding public authority, including funding and implementation. The City of Santa Ana will update its Transportation System Improvement Assessment (TSIA) in order to provide funding for the implementation of the City of Santa Ana Circulation Element Transportation Network buildout. For mitigation measures in adjoining jurisdictions, the City of Santa Ana will contribute to the fairshare of the corresponding mitigation measures.

All identified impacts are expected to be mitigated with the exception of:

- INT 36 – Bristol Street and Warner Avenue (City of Santa Ana)
- INT 44 – Flower Street and 1st Street (City of Santa Ana)
- INT 46 – Flower Street and Segerstrom Avenue (City of Santa Ana)
- INT 47 – Flower Street and Segerstrom Avenue (City of Santa Ana)
- INT 55 – Main Street and McFadden Avenue (City of Santa Ana)

- INT 56 – Main Street and Edinger Avenued (City of Santa Ana)
- INT 62 – Santiago Street and Santa Ana Boulevard (City of Santa Ana)
- INT 63 – Standard Avenue and 4th Street (City of Santa Ana)
- INT 64 – Standard Avenue and 1st Street (City of Santa Ana)
- INT 80 – Grand Avenue and Chestnut Avenue (City of Santa Ana)
- INT 82 – Grand Avenued and Alton Parkway (City of Santa Ana)
- INT 100 – Red Hill Avenue and Alton Parkway (City of Irvine)

9.3 ROADWAY LOS

Roadway LOS was assessed to determine conformance with the City of Santa Ana MPSH minimum level of service requirements. Eleven study roadways currently operate at an unacceptable LOS. Thirteen study roadways are expected to operate at an unacceptable LOS in the Future Year (2045) No Project scenario. Eight roadways are expected to operate at an unacceptable LOS in the Future Year (2045) With Project scenario. Although the LOS exceeds the standard established in the Circulation Element, physical improvements are not feasible due to right-of-way constraints.

10.0 Appendices

- APPENDIX A – LANE GEOMETRIES
- APPENDIX B – INTERSECTION VOLUMES
- APPENDIX C – OCTAM VOLUME PLOTS
- APPENDIX D – ANALYSIS WORKSHEETS
- APPENDIX E – MITIGATION WORKSHEETS
- APPENDIX F – VMT CALCULATIONS
- APPENDIX G – OCTAM 2045 VOLUME COMPARISON PLOTS
- APPENDIX H - COUNTS

APPENDIX A

LANE GEOMETRIES

APPENDIX A.1

LANE GEOMETRIES – 2020 NP

Santa Ana Circulation Element

Scenario Report

Scenario: 2020 NP AM Peak Hour

Command: Default Command

Volume: 2020 NP AM

Geometry: NP

Impact Fee: Default Impact Fee

Trip Generation: Default Trip Generation

Trip Distribution: Default Trip Distribution

Paths: Default Path

Routes: Default Route

Configuration: Default Configuration

 Santa Ana Circulation Element

 Lane Geometry Report

Number of approach lanes: (L) (LT) (T) (RT) (R) (LTR)

Node Intersection	NB	SB	EB	WB
1 Euclid St and 1st St	102100	102100	102100	102100
2 Euclid St and McFadden Ave	102100	102100	101100	101100
3 Euclid St and Edinger Ave	202100	202100	102010	102010
4 Newhope St and Hazard Ave	101100	101100	101100	101100
5 Newhope St and McFadden Ave	101100	101100	101100	101100
6 Harbor Blvd and SR-22 WB Off-Ramp /	103000	002100	000001	110010
7 Trask Avenue and SR-22 EB On-Ramp	000000	000000	201000	001100
8 Harbor Blvd and Westminster Ave	103010	103010	102100	103010
9 Harbor Blvd and 1st St	103010	103010	202100	202100
10 Harbor Blvd and McFadden Ave	203010	202100	101100	101100
11 Harbor Blvd and Edinger Ave	203010	203010	202100	203010
12 Harbor Blvd and Warner Ave	202100	203010	203010	203010
13 Harbor Blvd and Segerstrom Ave	202100	102100	101100	102010
14 MacArthur Blvd and Hyland Ave	200100	101010	103010	103010
15 MacArthur Blvd and Harbor Blvd	203010	203010	103010	103010
16 Harbor Blvd and Sunflower Ave	203010	203010	101100	110100
17 Harbor Blvd and I-405 WB Off-Ramp	004000	004000	000000	100011
18 Harbor Blvd and I-405 EB Off-Ramp	003010	004000	100011	000000
19 Fairview St and Civic Center Dr	102100	102100	010100	110010
20 Fairview St and 1st St	103010	102100	102100	102100
21 Fairview St and McFadden Ave	103010	103010	101100	101100
22 Fairview St and Edinger Ave	202100	202100	202100	202100
23 Fairview St and Warner Ave	202100	202100	202100	202100
24 Fairview St and MacArthur Blvd	202100	203010	203010	203010
25 Fairview Rd and Sunflower Ave	203010	202100	201100	202010
26 Greenville St and Edinger Ave	100010	000000	002100	102000
27 Greenville St and Segerstrom Ave	101100	101010	101100	101100
28 Raitt St and McFadden Ave	101100	101100	101100	101100
29 Raitt St and Edinger Ave	101100	101100	101100	101100
30 Bear St and MacArthur Blvd	102010	102010	102100	102100
31 Bristol St and 17th St	203010	203010	202100	203010
32 Bristol St and Civic Center Dr	102100	102100	101100	101100
33 Bristol St and Santa Ana Blvd	102100	102100	101100	101100
34 Bristol St and 1st St	203010	203010	102100	102100
35 Bristol St and McFadden Ave	103010	103010	101100	101100
36 Bristol St and Warner Ave	202010	202100	103010	103010
37 Bristol St and Segerstrom Ave	102100	102100	101100	101100
38 Bristol St and Alton Ave	102100	103010	101100	100100
39 Bristol St and MacArthur Blvd	203010	202100	203010	203010
40 Bristol St and Sunflower Ave	202110	203010	202110	203010
41 Bristol St and I-405 WB Ramps	004010	004100	000020	111020
42 Bristol St and I-405 EB Ramps	104000	002110	300010	000000
43 Flower St and Santa Ana Blvd	102010	102010	103010	102010
44 Flower St and 1st St	102010	101100	102100	102100
45 Flower St and McFadden Ave	100100	100100	100100	100100
46 Flower St and Segerstrom Ave	101100	101100	101100	101100
47 Flower St and MacArthur Blvd	101100	101100	102100	102100

 Santa Ana Circulation Element

Number of approach lanes: (L) (LT) (T) (RT) (R) (LTR)

Node Intersection	NB	SB	EB	WB
48 Main St and La Veta Ave	203010	202100	202100	202010
49 Main St and Mainplace Dr / Memory L	202100	202100	202100	202010
50 Main St and 17th St	202010	201100	202100	202010
51 Main St and Civic Center Dr	101100	101100	101100	101100
52 Main St and Santa Ana Blvd	102000	001100	000000	011100
53 Main St and 4th St	001100	001100	000100	000100
54 Main St and 1st St	101100	102010	102100	102100
55 Main St and McFadden Ave	101100	101100	100100	101010
56 Main St and Edinger Ave	101100	101100	102010	102100
57 Main St and MacArthur Blvd	203010	203010	203010	203010
58 Penn Wy and 17th St	200020	000000	002100	103000
59 I-5 NB Off Ramps/17th Street	110010	100010	103010	002100
60 Penn Wy and I-5 SB Ramps	002010	202000	000000	100020
61 Santiago St and Civic Center Dr	100100	100100	010010	000001
62 Santiago St and Santa Ana Blvd	101010	101010	101100	102010
64 Standard Ave and 1st St	100100	000001	101100	101100
65 Standard Ave and Mcfadden Ave	101100	101100	101100	101100
66 Halladay St and Warner Ave	100010	000000	001100	011000
67 Halladay St and Dyer Rd	100100	100100	102100	102100
68 SR-55 SB Ramps and MacArthur Blvd	000000	200020	002110	003010
69 SR-55 NB Ramps and MacArthur Blvd	200010	000000	002020	003010
70 SR-55 SB Ramps and Dyer Rd	110020	011010	103010	203010
71 Glassell St and La Veta Ave	201010	101100	101010	101100
72 Glassell St and SR-22 WB Ramps	102000	002010	000000	100011
73 Grand Ave / Glassell St and SR-22 E	002010	102000	100011	000000
74 Grand Ave and Fairhaven Ave	102100	102010	101100	101010
75 Grand Ave and Santa Clara Ave	102100	101100	100100	101010
76 Grand Ave and 17th St	102100	102010	202100	202100
77 Grand Ave and I-5 NB Ramps	002010	103000	000000	200010
78 Grand Ave and Santa Ana Blvd	102100	102020	201020	010100
79 Grand Ave and 1st St	202100	203010	202100	201100
80 Grand Ave and Chestnut Ave	102100	102100	101100	101100
81 Grand Ave and McFadden Ave	102100	102100	101100	101100
82 Grand Ave and Edinger Ave	102100	102100	102100	102100
83 Grand Ave and Warner Ave	102100	102100	203010	202010
84 SR-55 NB Ramps and Dyer Rd	100011	000000	003010	002100
85 Cambridge St and La Veta Ave	101000	001010	100010	000000
86 Cambridge St and Fairhaven Ave	000000	100010	102000	001100
87 Mabury St and 1st Street	100010	100011	002100	102100
88 Tustin St and La Veta Ave	102100	102100	101100	110010
89 Tustin St and SR-22 WB On-Ramp	202000	002100	000000	000000
90 Tustin St and SR-22 EB Off-Ramp / S	002100	103000	100011	000001
91 Tustin Ave and Fairhaven Ave	202100	202100	101100	101010
92 Tustin Ave and Santa Clara Ave	102100	202100	101100	101100
93 Tustin Ave and 17th St	202010	202100	203010	203010
94 Tustin Ave and 4th St	102100	202010	102100	102100
95 SR-55 SB Ramps / Auto Mall Dr and E	110020	101010	103010	202100
96 SR-55 NB Ramps / Del Amo Ave and Ne	202100	103010	201100	101100
97 Red Hill Ave and Edinger Ave	203010	203010	203010	203010
98 Red Hill Ave and Warner Ave	203100	202100	102100	203010

Traffix 8.0.0715 (c) 2008 Dowling Assoc. Licensed to IBI GROUP, IRVINE, CA

 Santa Ana Circulation Element

Number of approach lanes: (L) (LT) (T) (RT) (R) (LTR)

Node Intersection	NB	SB	EB	WB
99 Red Hill Ave and Dyer Rd / barranca	204010	204010	203100	204010
100 Red Hill Ave and Alton Pkwy	103010	103010	102010	201010
101 Red Hill Ave and MacArthur Blvd	202100	203010	203010	103010
102 Red Hill Ave and Main St	202010	202010	202100	202100
103 I-5 SB Ramps and Santa Ana Blvd	000000	200010	203000	002100
104 Tustin Ranch Rd and Warner Ave	000000	200010	203000	003010
105 Von Karman Ave and Barranca Pkwy	201100	202020	203010	204010
106 Red Hill Avenue and El Camino Real	203010	102100	101010	100100
107 Red Hill Avenue and I-5 NB Ramps	103000	003010	000000	200010
108 Red Hill Avenue and I-5 SB Ramps	004010	103000	010010	000000
109 Red Hill Avenue and Nissan Road	103100	102100	100100	100100
110 Red Hill Avenue and Walnut Avenue	102100	102100	101100	201100
111 Red Hill Avenue and Valencia Avenue	103100	102100	101010	201010
112 Tustin Ranch Road and Warner Avenue	003010	203000	000000	300020
113 Tustin Ranch Road and Walnut Avenue	203010	203010	201100	202010
114 SR-55 SB Ramps and Irvine Boulevard	000000	100011	002100	103000
115 SR-55 NB Ramps and Irvine Boulevard	100011	000000	103000	002100

APPENDIX A.2

LANE GEOMETRIES – 2045 NP

Santa Ana Circulation Element

Scenario Report

Scenario: 2045 NP AM Peak Hour
Command: Default Command
Volume: 2045 NP AM
Geometry: MPAH
Impact Fee: Default Impact Fee
Trip Generation: Default Trip Generation
Trip Distribution: Default Trip Distribution
Paths: Default Path
Routes: Default Route
Configuration: Default Configuration

 Santa Ana Circulation Element

 Lane Geometry Report

Number of approach lanes: (L) (LT) (T) (RT) (R) (LTR)

Node Intersection	NB	SB	EB	WB
1 Euclid St and 1st St	102100	102100	102100	102100
2 Euclid St and McFadden Ave	102100	102100	101100	101100
3 Euclid St and Edinger Ave	202100	202100	102010	102010
4 Newhope St and Hazard Ave	101100	101100	101100	101100
5 Newhope St and McFadden Ave	101100	101100	101100	101100
6 Harbor Blvd and SR-22 WB Off-Ramp /	103000	002100	000001	110010
7 Trask Avenue and SR-22 EB On-Ramp	000000	000000	201000	001100
8 Harbor Blvd and Westminster Ave	103010	103010	102100	103010
9 Harbor Blvd and 1st St	103010	103010	202100	202100
10 Harbor Blvd and McFadden Ave	203010	202100	101100	101100
11 Harbor Blvd and Edinger Ave	203010	203010	202100	203010
12 Harbor Blvd and Warner Ave	202100	203010	203010	203010
13 Harbor Blvd and Segerstrom Ave	202100	102100	101100	102010
14 MacArthur Blvd and Hyland Ave	200100	101010	103010	103010
15 MacArthur Blvd and Harbor Blvd	203010	203010	103010	103010
16 Harbor Blvd and Sunflower Ave	203010	203010	101100	110100
17 Harbor Blvd and I-405 NB Off-Ramp	004000	004000	000000	100011
18 Harbor Blvd and I-405 SB Off-Ramp	003010	004000	100011	000000
19 Fairview St and Civic Center Dr	102100	102100	010100	110010
20 Fairview St and 1st St	103010	102100	102100	102100
21 Fairview St and McFadden Ave	103010	103010	101100	101100
22 Fairview St and Edinger Ave	202100	202100	202100	202100
23 Fairview St and Warner Ave	202100	202100	202100	202100
24 Fairview St and MacArthur Blvd	202100	203010	203010	203010
25 Fairview Rd and Sunflower Ave	203010	202100	201100	202010
26 Greenville St and Edinger Ave	100010	000000	002100	103000
27 Greenville St and Segerstrom Ave	100100	100100	102100	102100
28 Raitt St and McFadden Ave	101100	101100	101100	101100
29 Raitt St and Edinger Ave	101100	101100	102100	102100
30 Bear St and MacArthur Blvd	102010	102010	102100	102100
31 Bristol St and 17th St	203010	203010	202100	203010
32 Bristol St and Civic Center Dr	102100	102100	101100	101100
33 Bristol St and Santa Ana Blvd	102100	102100	102100	102100
34 Bristol St and 1st St	203010	203010	102100	102100
35 Bristol St and McFadden Ave	103010	103010	101100	101100
36 Bristol St and Warner Ave	202100	202100	103010	103010
37 Bristol St and Segerstrom Ave	102100	102100	102100	102100
38 Bristol St and Alton Ave	102100	103010	101100	100100
39 Bristol St and MacArthur Blvd	203010	202100	203010	203010
40 Bristol St and Sunflower Ave	202110	203010	202110	203010
41 Bristol St and I-405 NB Ramps	004010	004100	000020	111020
42 Bristol St and I-405 SB Ramps	104000	002110	300010	000000
43 Flower St and Santa Ana Blvd	102010	102010	103010	102100
44 Flower St and 1st St	102010	101100	102100	102100
45 Flower St and McFadden Ave	010100	010100	010100	010100
46 Flower St and Segerstrom Ave	101100	101100	102100	102100
47 Flower St and MacArthur Blvd	101100	101100	102100	102100

 Santa Ana Circulation Element

Number of approach lanes: (L) (LT) (T) (RT) (R) (LTR)

Node Intersection	NB	SB	EB	WB
48 Main St and La Veta Ave	203010	202100	202100	202010
49 Main St and Mainplace Dr / Memory L	202100	202100	202100	202010
50 Main St and 17th St	202010	202010	202100	202100
51 Main St and Civic Center Dr	101100	101100	101100	101100
52 Main St and Santa Ana Blvd	102000	001100	000000	010100
53 Main St and 4th St	001100	001100	001100	001100
54 Main St and 1st St	101100	102010	102100	102100
55 Main St and McFadden Ave	101100	101100	101100	101100
56 Main St and Edinger Ave	101100	101100	102100	102100
57 Main St and MacArthur Blvd	203010	203010	203010	203010
58 Penn Wy and 17th St	200020	000000	002100	103000
59 I-5 NB Off Ramps/17th Street	110010	100010	103010	002100
60 Penn Wy and I-5 SB Ramps	002010	202000	000000	100020
61 Santiago St and Civic Center Dr	100100	100100	010010	000001
62 Santiago St and Santa Ana Blvd	101100	101100	101100	102010
63 Standard Ave and 4th St	102010	102010	101100	101100
64 Standard Ave and 1st St	101100	101100	102100	102100
65 Standard Ave and Mcfadden Ave	101100	101100	101100	101100
66 Halladay St and Warner Ave	100010	000000	002100	012000
67 Halladay St and Dyer Rd	100100	100100	102100	102100
68 SR-55 SB Ramps and MacArthur Blvd	000000	200020	002110	003010
69 SR-55 NB Ramps and MacArthur Blvd	200010	000000	002020	003010
70 SR-55 SB Ramps and Dyer Rd	110020	011010	103010	203010
71 Glassell St and La Veta Ave	201010	101100	101010	101100
72 Glassell St and SR-22 WB Ramps	102000	002010	000000	100011
73 Grand Ave / Glassell St and SR-22 E	002010	102000	100011	000000
74 Grand Ave and Fairhaven Ave	102100	102100	101100	101010
75 Grand Ave and Santa Clara Ave	102100	102100	100100	101010
76 Grand Ave and 17th St	102100	102100	202100	202100
77 Grand Ave and I-5 NB Ramps	002010	103000	000000	200010
78 Grand Ave and Santa Ana Blvd	102100	102020	201020	010100
79 Grand Ave and 1st St	202100	203010	202100	202100
80 Grand Ave and Chestnut Ave	102100	102100	101100	101100
81 Grand Ave and McFadden Ave	102100	102100	101100	101100
82 Grand Ave and Edinger Ave	102100	102100	102100	102100
83 Grand Ave and Warner Ave	102100	102100	203010	202100
84 SR-55 NB Ramps and Dyer Rd	100011	000000	003010	002100
85 Cambridge St and La Veta Ave	101000	001010	100010	000000
86 Cambridge St and Fairhaven Ave	000000	100010	102000	001100
87 Mabury St and 1st Street	100010	100011	002100	102100
88 Tustin St and La Veta Ave	102100	102100	101100	110010
89 Tustin St and SR-22 WB On-Ramp	202000	002100	000000	000000
90 Tustin St and SR-22 EB Off-Ramp / S	002100	103000	100011	000001
91 Tustin Ave and Fairhaven Ave	202100	202100	101100	101010
92 Tustin Ave and Santa Clara Ave	102100	202100	101100	101100
93 Tustin Ave and 17th St	202010	202100	203010	203010
94 Tustin Ave and 4th St	102100	202010	102110	102100
95 SR-55 SB Ramps / Auto Mall Dr and E	110020	101010	103010	202100
96 SR-55 NB Ramps / Del Amo Ave and Ne	202100	103010	201100	101100
97 Red Hill Ave and Edinger Ave	203010	203010	203010	203010

 Santa Ana Circulation Element

Number of approach lanes: (L) (LT) (T) (RT) (R) (LTR)

Node Intersection	NB	SB	EB	WB
98 Red Hill Ave and Warner Ave	203100	202100	102100	203010
99 Red Hill Ave and Dyer Rd / barranca	204010	204010	203100	204010
100 Red Hill Ave and Alton Pkwy	103010	103010	102010	201010
101 Red Hill Ave and MacArthur Blvd	202100	203010	203010	103010
102 Red Hill Ave and Main St	202010	202010	202100	202100
103 I-5 SB Ramps and Santa Ana Blvd	000000	200010	203000	002100
104 Tustin Ranch Rd and Warner Ave	000000	200010	203000	003010
105 Von Karman Ave and Barranca Pkwy	201100	202020	203010	204010
106 Red Hill Avenue and El Camino Real	203010	102100	101010	100100
107 Red Hill Avenue and I-5 NB Ramps	103000	003010	000000	200010
108 Red Hill Avenue and I-5 SB Ramps	004010	103000	010010	000000
109 Red Hill Avenue and Nissan Road	103100	102100	100100	100100
110 Red Hill Avenue and Walnut Avenue	102100	102100	101100	201100
111 Red Hill Avenue and Valencia Avenue	103100	102100	101010	201010
112 Tustin Ranch Road and Warner Avenue	003010	203000	000000	300020
113 Tustin Ranch Road and Walnut Avenue	203010	203010	201100	202010
114 SR-55 SB Ramps and Irvine Boulevard	000000	100011	002100	103000
115 SR-55 NB Ramps and Irvine Boulevard	100011	000000	103000	002100

APPENDIX A.3

LANE GEOMETRIES – 2045 WP

Santa Ana Circulation Element

Scenario Report

Scenario: 2045 WP AM Peak Hour

Command: Default Command

Volume: 2045 AM

Geometry: SACE

Impact Fee: Default Impact Fee

Trip Generation: Default Trip Generation

Trip Distribution: Default Trip Distribution

Paths: Default Path

Routes: Default Route

Configuration: Default Configuration

 Santa Ana Circulation Element

 Lane Geometry Report

Number of approach lanes: (L) (LT) (T) (RT) (R) (LTR)

Node Intersection	NB	SB	EB	WB
1 Euclid St and 1st St	102100	102100	102100	102100
2 Euclid St and McFadden Ave	102100	102100	101100	101100
3 Euclid St and Edinger Ave	202100	202100	102010	102010
4 Newhope St and Hazard Ave	101100	101100	100100	100100
5 Newhope St and McFadden Ave	101100	101100	101100	101100
6 Harbor Blvd and SR-22 WB Off-Ramp /	103000	002100	000001	110010
7 Trask Avenue and SR-22 EB On-Ramp	000000	000000	201000	001100
8 Harbor Blvd and Westminster Ave	103010	103010	102100	103010
9 Harbor Blvd and 1st St	103010	103010	202100	202100
10 Harbor Blvd and McFadden Ave	203010	202100	101100	100100
11 Harbor Blvd and Edinger Ave	203010	203010	202100	203010
12 Harbor Blvd and Warner Ave	202100	203010	203010	203010
13 Harbor Blvd and Segerstrom Ave	202100	102100	101100	102010
14 MacArthur Blvd and Hyland Ave	200100	101010	103010	103010
15 MacArthur Blvd and Harbor Blvd	203010	203010	103010	103010
16 Harbor Blvd and Sunflower Ave	203010	203010	101100	110100
17 Harbor Blvd and I-405 NB Off-Ramp	004000	004000	000000	100011
18 Harbor Blvd and I-405 SB Off-Ramp	003010	004000	100011	000000
19 Fairview St and Civic Center Dr	102100	102100	010100	110010
20 Fairview St and 1st St	103010	102100	102100	102100
21 Fairview St and McFadden Ave	103010	103010	100100	100100
22 Fairview St and Edinger Ave	202100	202100	202100	202100
23 Fairview St and Warner Ave	202100	202100	202100	202100
24 Fairview St and MacArthur Blvd	202100	203010	203010	203010
25 Fairview Rd and Sunflower Ave	203010	202100	201100	202010
26 Greenville St and Edinger Ave	100010	000000	002100	103000
27 Greenville St and Segerstrom Ave	100100	100100	102100	102100
28 Raitt St and McFadden Ave	100100	100100	100100	100100
29 Raitt St and Edinger Ave	100100	100100	102100	102100
30 Bear St and MacArthur Blvd	102010	102010	102100	102100
31 Bristol St and 17th St	203010	203010	202100	203010
32 Bristol St and Civic Center Dr	102100	102100	100100	101100
33 Bristol St and Santa Ana Blvd	102100	102100	100100	100100
34 Bristol St and 1st St	203010	203010	102100	101100
35 Bristol St and McFadden Ave	103010	103010	100100	100100
36 Bristol St and Warner Ave	202100	202100	103010	103010
37 Bristol St and Segerstrom Ave	102100	102100	102100	102100
38 Bristol St and Alton Ave	102100	103010	101100	100100
39 Bristol St and MacArthur Blvd	203010	202100	203010	203010
40 Bristol St and Sunflower Ave	202110	203010	202110	203010
41 Bristol St and I-405 NB Ramps	004010	004100	000020	111020
42 Bristol St and I-405 SB Ramps	104000	002110	300010	000000
43 Flower St and Santa Ana Blvd	102010	102010	102010	102010
44 Flower St and 1st St	101010	101100	101100	101100
45 Flower St and McFadden Ave	100100	100100	100100	100100
46 Flower St and Segerstrom Ave	101100	101100	102100	102100
47 Flower St and MacArthur Blvd	101100	101100	102100	102100

 Santa Ana Circulation Element

Number of approach lanes: (L) (LT) (T) (RT) (R) (LTR)

Node Intersection	NB	SB	EB	WB
48 Main St and La Veta Ave	203010	202100	202100	202010
49 Main St and Mainplace Dr / Memory L	202100	202100	202100	202010
50 Main St and 17th St	202010	202010	202100	202100
51 Main St and Civic Center Dr	101100	101100	101100	101100
52 Main St and Santa Ana Blvd	102000	001100	000000	010100
53 Main St and 4th St	001100	001100	001100	001100
54 Main St and 1st St	101100	102010	101100	101100
55 Main St and McFadden Ave	101100	101100	100100	100100
56 Main St and Edinger Ave	101100	101100	102100	102100
57 Main St and MacArthur Blvd	203010	203010	203010	203010
58 Penn Wy and 17th St	200020	000000	002100	103000
59 I-5 NB Off Ramps/17th Street	110010	100010	103010	002100
60 Penn Wy and I-5 SB Ramps	002010	202000	000000	100020
61 Santiago St and Civic Center Dr	100100	100100	100100	000001
62 Santiago St and Santa Ana Blvd	101010	101010	100100	102010
63 Standard Ave and 4th St	101010	101010	100100	100100
64 Standard Ave and 1st St	100100	000001	101100	101100
65 Standard Ave and Mcfadden Ave	100100	100100	100100	100100
66 Halladay St and Warner Ave	100010	000000	002100	012000
67 Halladay St and Dyer Rd	100100	100100	102100	102100
68 SR-55 SB Ramps and MacArthur Blvd	000000	200020	002110	003010
69 SR-55 NB Ramps and MacArthur Blvd	200010	000000	002020	003010
70 SR-55 SB Ramps and Dyer Rd	110020	011010	103010	203010
71 Glassell St and La Veta Ave	201010	101100	101010	101100
72 Glassell St and SR-22 WB Ramps	102000	002010	000000	100011
73 Grand Ave / Glassell St and SR-22 E	002010	102000	100011	000000
74 Grand Ave and Fairhaven Ave	102100	102100	101100	100100
75 Grand Ave and Santa Clara Ave	102100	102100	100100	101010
76 Grand Ave and 17th St	102100	102100	202100	202100
77 Grand Ave and I-5 NB Ramps	002010	103000	000000	200010
78 Grand Ave and Santa Ana Blvd	102100	102020	201020	010100
79 Grand Ave and 1st St	202100	203010	202010	202010
80 Grand Ave and Chestnut Ave	102100	102100	100100	100100
81 Grand Ave and McFadden Ave	102100	102100	100100	101100
82 Grand Ave and Edinger Ave	102100	102100	102100	102100
83 Grand Ave and Warner Ave	102100	102100	203010	202100
84 SR-55 NB Ramps and Dyer Rd	100011	000000	003010	002100
85 Cambridge St and La Veta Ave	101000	001010	100010	000000
86 Cambridge St and Fairhaven Ave	000000	100010	101000	000100
87 Mabury St and 1st Street	100010	100011	001100	101100
88 Tustin St and La Veta Ave	102100	102100	101100	110010
89 Tustin St and SR-22 WB On-Ramp	202000	002100	000000	000000
90 Tustin St and SR-22 EB Off-Ramp / S	002100	103000	100011	000001
91 Tustin Ave and Fairhaven Ave	202100	202100	100100	100100
92 Tustin Ave and Santa Clara Ave	102100	202100	100100	100100
93 Tustin Ave and 17th St	202010	202100	203010	203010
94 Tustin Ave and 4th St	102100	202010	102110	102100
95 SR-55 SB Ramps / Auto Mall Dr and E	110020	101010	103010	202100
96 SR-55 NB Ramps / Del Amo Ave and Ne	202100	103010	201100	101100
97 Red Hill Ave and Edinger Ave	203010	203010	203010	203010

 Santa Ana Circulation Element

Number of approach lanes: (L) (LT) (T) (RT) (R) (LTR)

Node Intersection	NB	SB	EB	WB
98 Red Hill Ave and Warner Ave	203100	202100	102100	203010
99 Red Hill Ave and Dyer Rd / barranca	204010	204010	203100	204010
100 Red Hill Ave and Alton Pkwy	103010	103010	102010	201010
101 Red Hill Ave and MacArthur Blvd	202100	203010	203010	103010
102 Red Hill Ave and Main St	202010	202010	202100	202100
103 I-5 SB Ramps and Santa Ana Blvd	000000	200010	203000	002100
104 Tustin Ranch Rd and Warner Ave	000000	200010	203000	003010
105 Von Karman Ave and Barranca Pkwy	201100	202020	203010	204010
106 Red Hill Avenue and El Camino Real	203010	102100	101010	100100
107 Red Hill Avenue and I-5 NB Ramps	103000	003010	000000	200010
108 Red Hill Avenue and I-5 SB Ramps	004010	103000	010010	000000
109 Red Hill Avenue and Nissan Road	103100	102100	100100	100100
110 Red Hill Avenue and Walnut Avenue	102100	102100	101100	201100
111 Red Hill Avenue and Valencia Avenue	103100	102100	101010	201010
112 Tustin Ranch Road and Warner Avenue	003010	203000	000000	300020
113 Tustin Ranch Road and Walnut Avenue	203010	203010	201100	202010
114 SR-55 SB Ramps and Irvine Boulevard	000000	100011	002100	103000
115 SR-55 NB Ramps and Irvine Boulevard	100011	000000	103000	002100

APPENDIX B

INTERSECTION VOLUMES

APPENDIX B.1
INTERSECTION VOLUMES –
2020 NP (AM PEAK HOUR)

Santa Ana Circulation Element

Intersection Graphic Report
Entered Volume (Base Alternative)
2020 NP AM Peak Hour

Intersection #1: Euclid St and 1st St

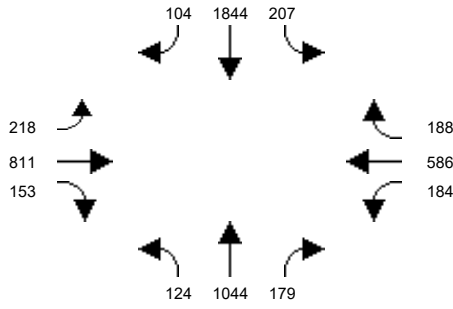

Intersection #2: Euclid St and McFadden Ave

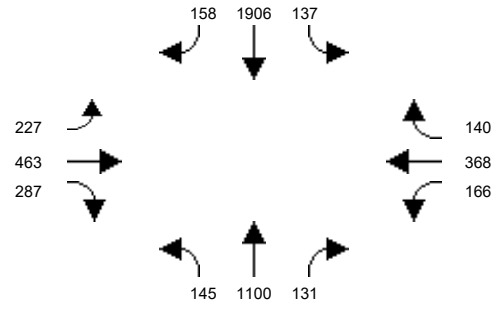

Intersection #3: Euclid St and Edinger Ave

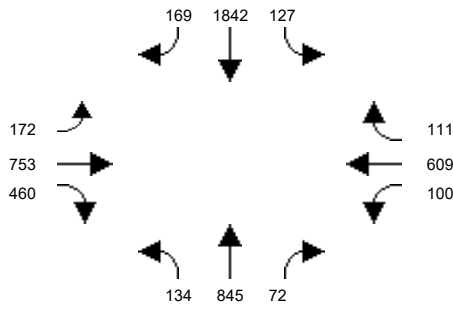

Intersection #4: Newhope St and Hazard Ave

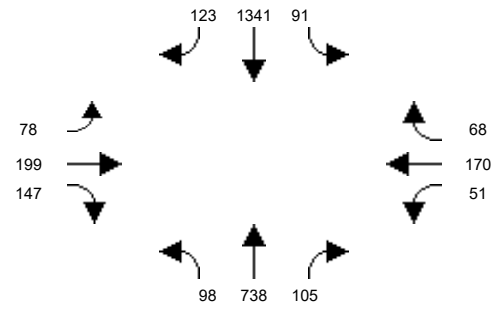

Intersection #5: Newhope St and McFadden Ave

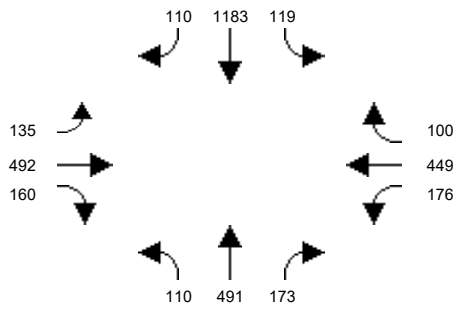

Intersection #6: Harbor Blvd and SR-22 WB Off-Ramp / Banner Dr

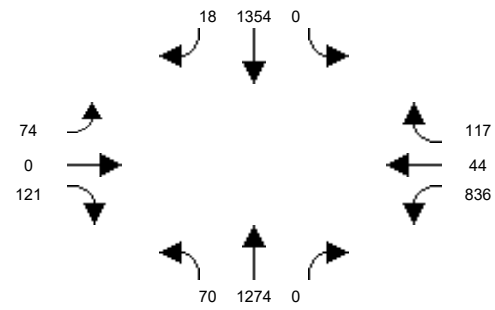

Intersection #7: Trask Avenue and SR-22 EB On-Ramp

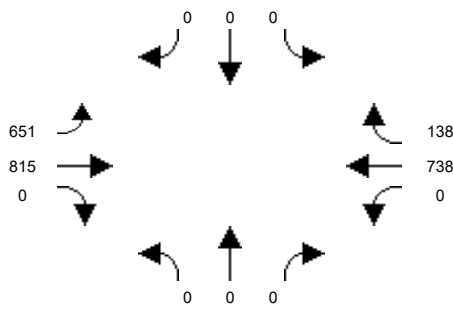

Intersection #8: Harbor Blvd and Westminster Ave

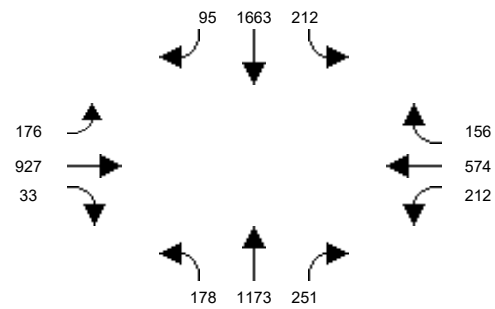

Intersection #9: Harbor Blvd and 1st St

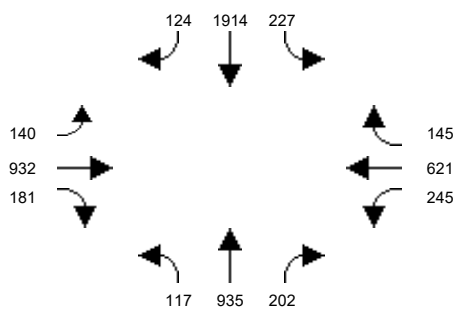

Intersection #10: Harbor Blvd and McFadden Ave

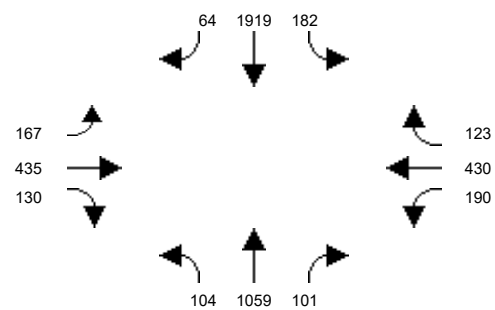

Santa Ana Circulation Element

Intersection Graphic Report
Entered Volume (Base Alternative)
2020 NP AM Peak Hour

Intersection #11: Harbor Blvd and Edinger Ave

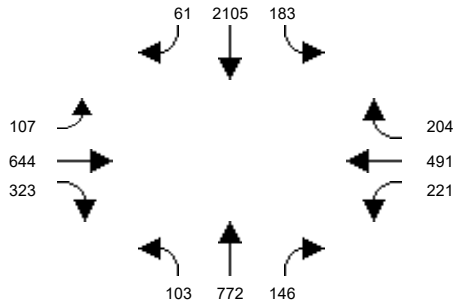

Intersection #12: Harbor Blvd and Warner Ave

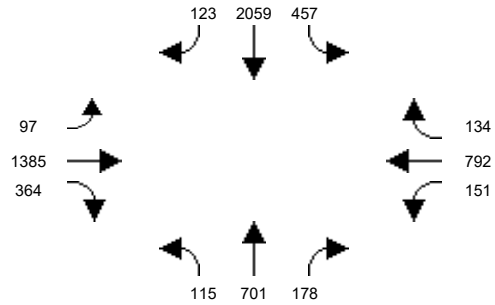

Intersection #13: Harbor Blvd and Segerstrom Ave

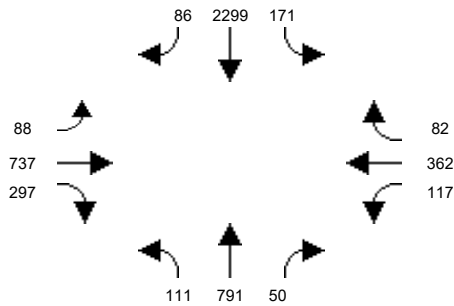

Intersection #14: MacArthur Blvd and Hyland Ave

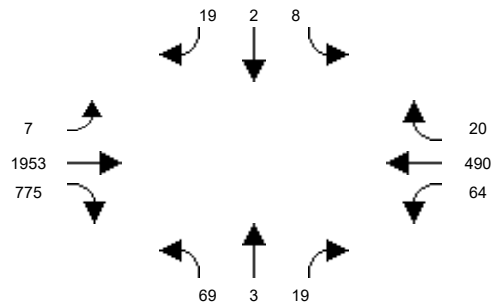

Intersection #15: MacArthur Blvd and Harbor Blvd

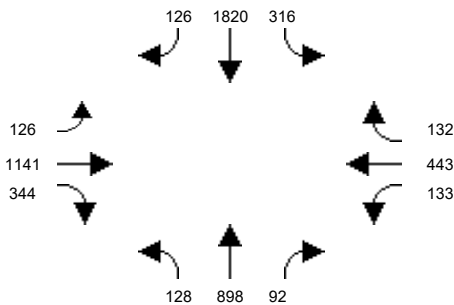

Intersection #16: Harbor Blvd and Sunflower Ave

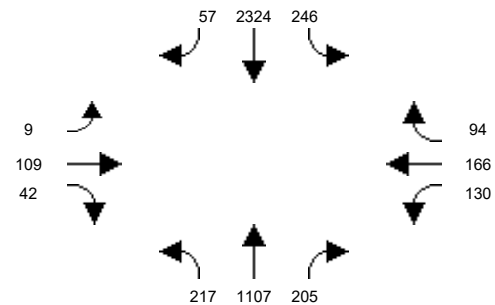

Intersection #17: Harbor Blvd and I-405 WB Off-Ramp

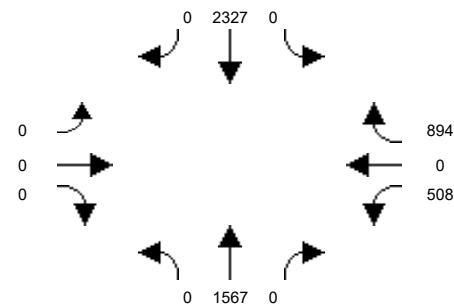

Intersection #18: Harbor Blvd and I-405 EB Off-Ramp

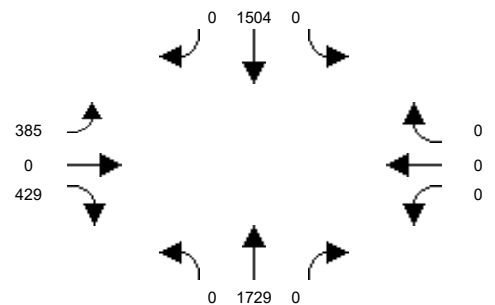

Intersection #19: Fairview St and Civic Center Dr

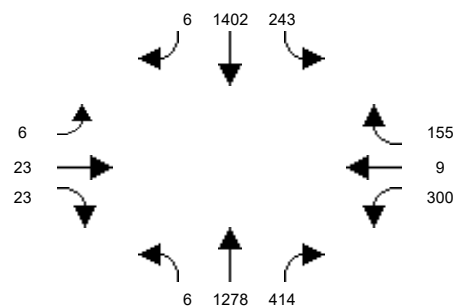

Intersection #20: Fairview St and 1st St

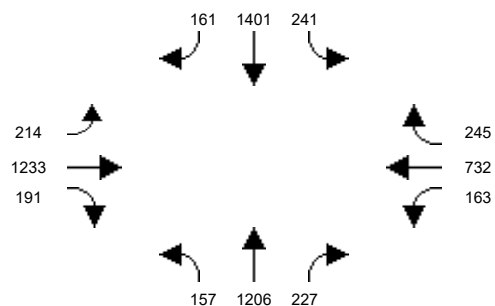

Santa Ana Circulation Element

Intersection Graphic Report
Entered Volume (Base Alternative)
2020 NP AM Peak Hour

Intersection #21: Fairview St and McFadden Ave

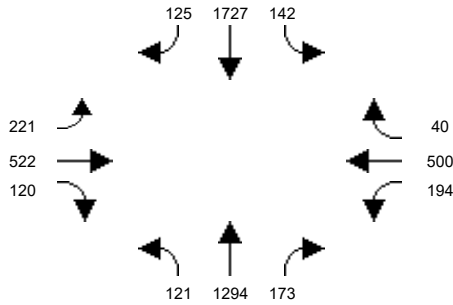

Intersection #22: Fairview St and Edinger Ave

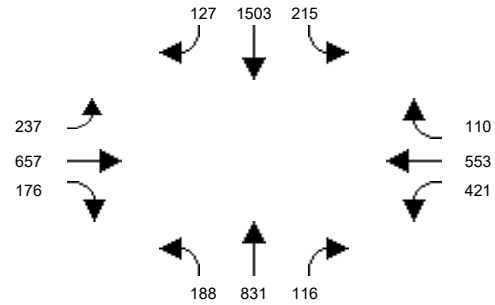

Intersection #23: Fairview St and Warner Ave

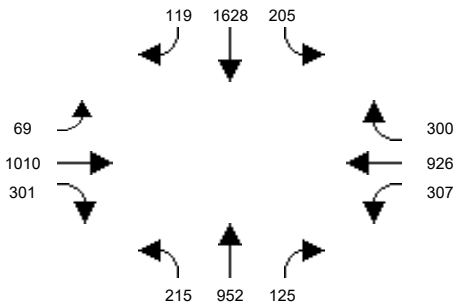

Intersection #24: Fairview St and MacArthur Blvd

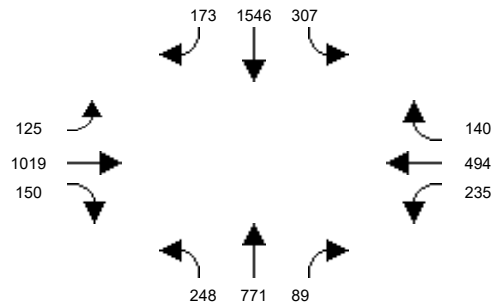

Intersection #25: Fairview Rd and Sunflower Ave

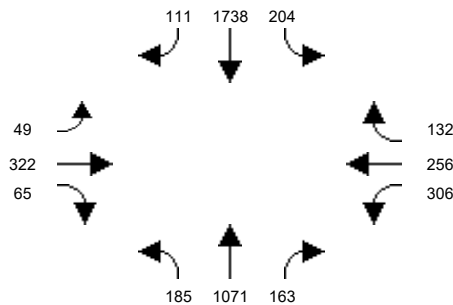

Intersection #26: Greenville St and Edinger Ave

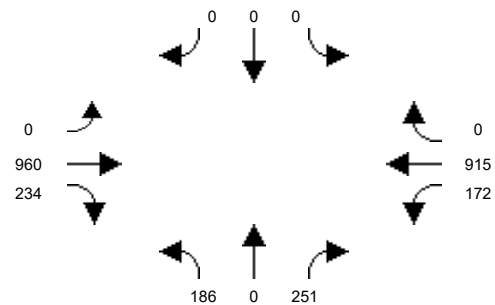

Intersection #27: Greenville St and Segerstrom Ave

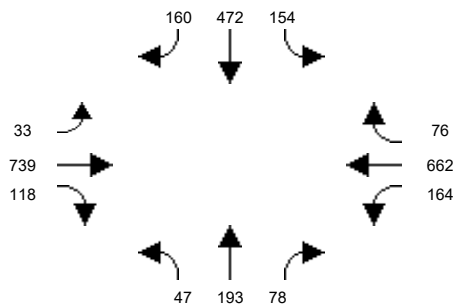

Intersection #28: Raitt St and McFadden Ave

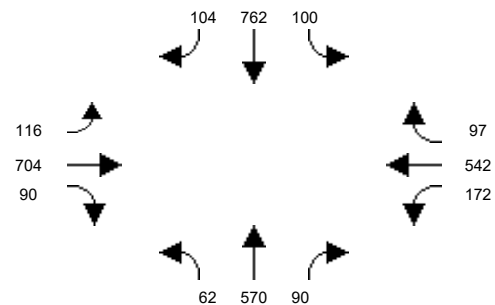

Intersection #29: Raitt St and Edinger Ave

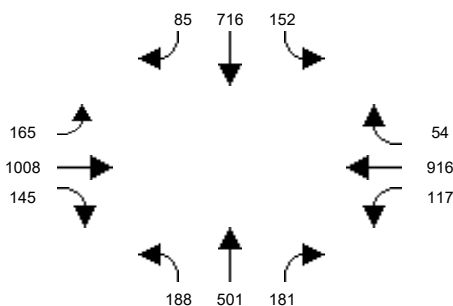

Intersection #30: Bear St and MacArthur Blvd

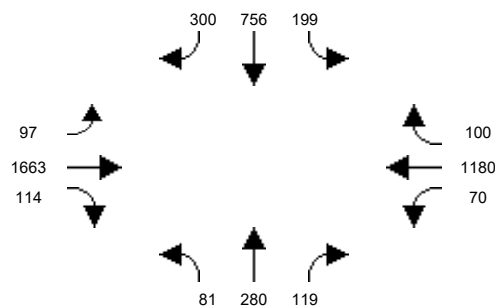

Santa Ana Circulation Element

Intersection Graphic Report
Entered Volume (Base Alternative)
2020 NP AM Peak Hour

Intersection #31: Bristol St and 17th St

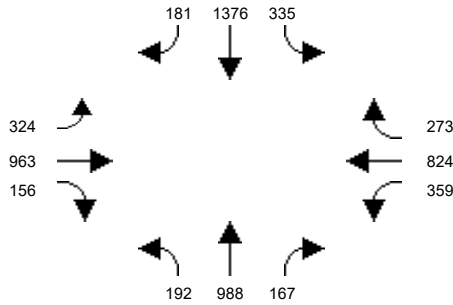

Intersection #32: Bristol St and Civic Center Dr

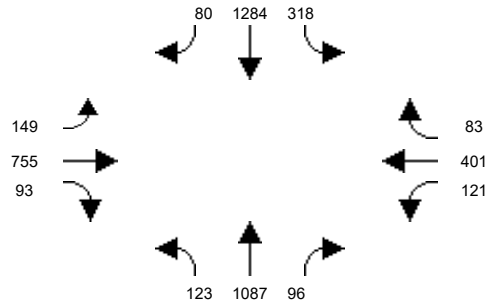

Intersection #33: Bristol St and Santa Ana Blvd

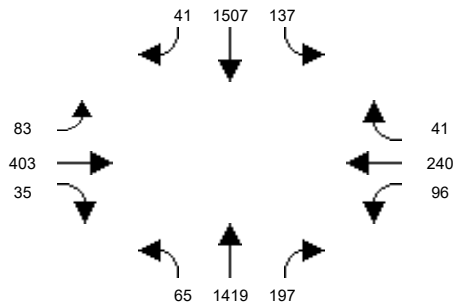

Intersection #34: Bristol St and 1st St

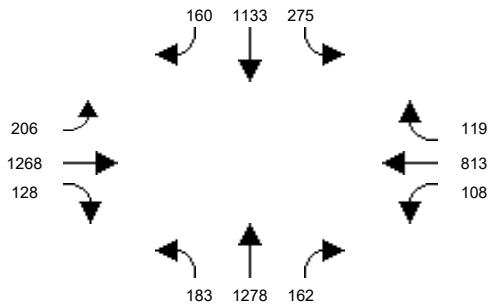

Intersection #35: Bristol St and McFadden Ave

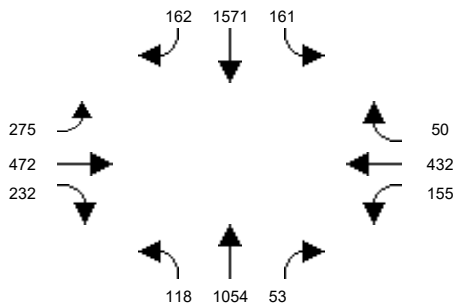

Intersection #36: Bristol St and Warner Ave

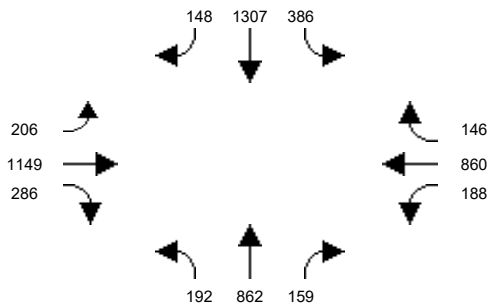

Intersection #37: Bristol St and Segerstrom Ave

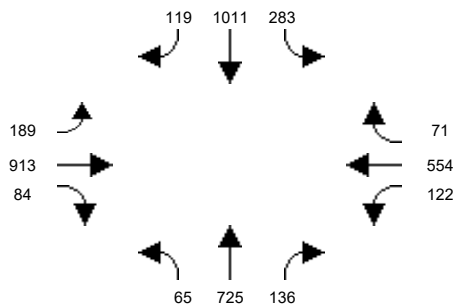

Intersection #38: Bristol St and Alton Ave

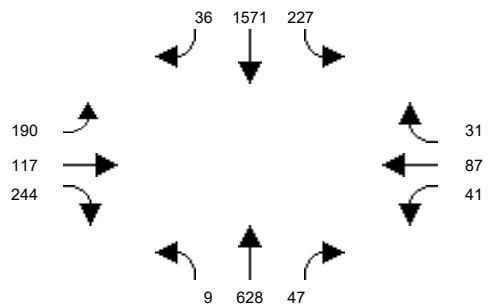

Intersection #39: Bristol St and MacArthur Blvd

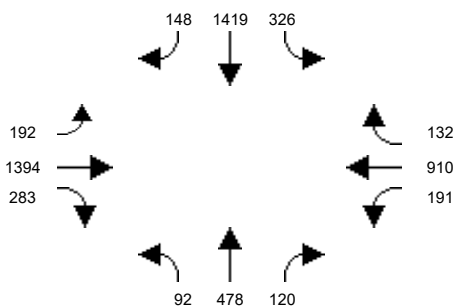

Intersection #40: Bristol St and Sunflower Ave

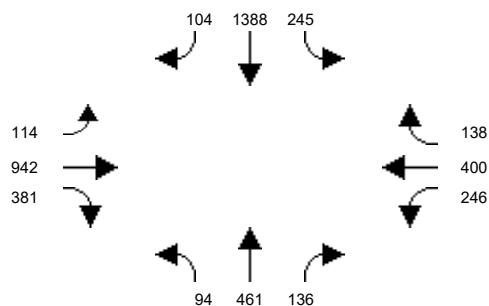

Santa Ana Circulation Element

Intersection Graphic Report
Entered Volume (Base Alternative)
2020 NP AM Peak Hour

Intersection #41: Bristol St and I-405 WB Ramps

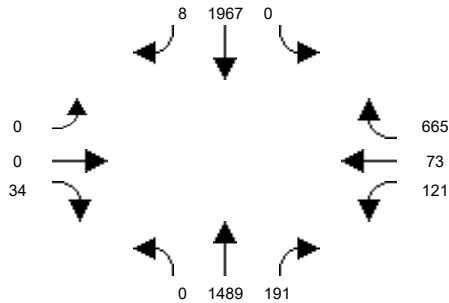

Intersection #42: Bristol St and I-405 EB Ramps

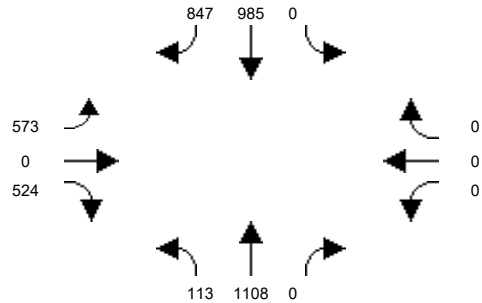

Intersection #43: Flower St and Santa Ana Blvd

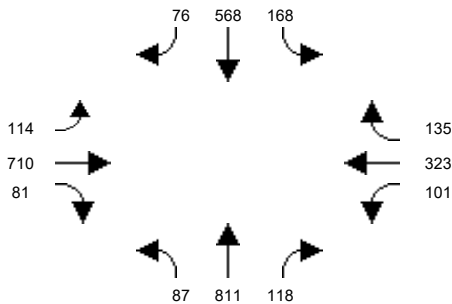

Intersection #44: Flower St and 1st St

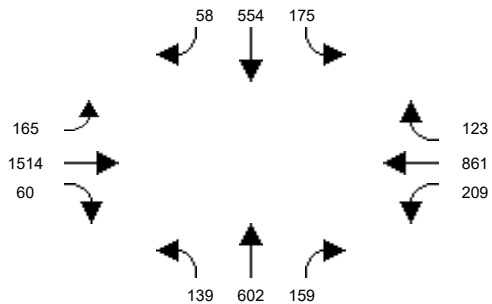

Intersection #45: Flower St and McFadden Ave

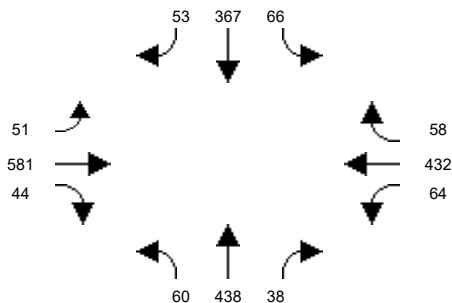

Intersection #46: Flower St and Segerstrom Ave

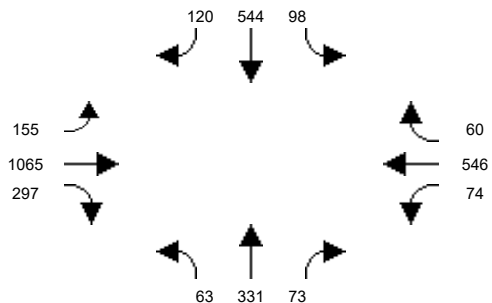

Intersection #47: Flower St and MacArthur Blvd

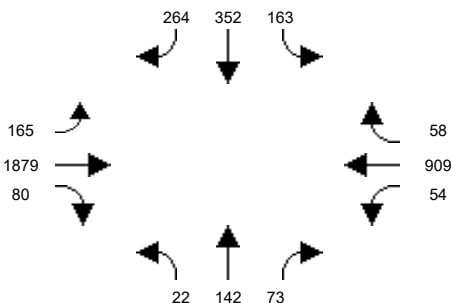

Intersection #48: Main St and La Veta Ave

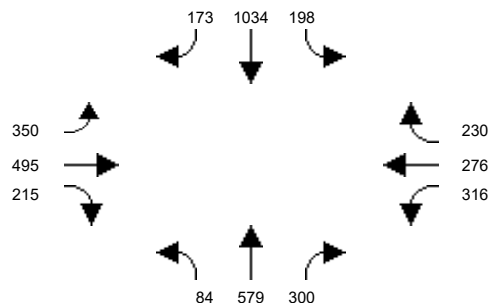

Intersection #49: Main St and Mainplace Dr / Memory Ln

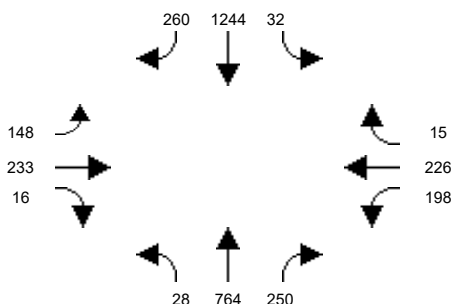

Intersection #50: Main St and 17th St

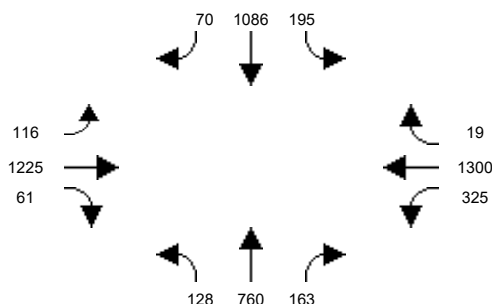

Santa Ana Circulation Element

Intersection Graphic Report
Entered Volume (Base Alternative)
2020 NP AM Peak Hour

Intersection #51: Main St and Civic Center Dr

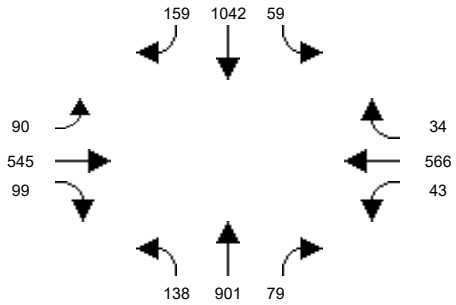

Intersection #52: Main St and Santa Ana Blvd

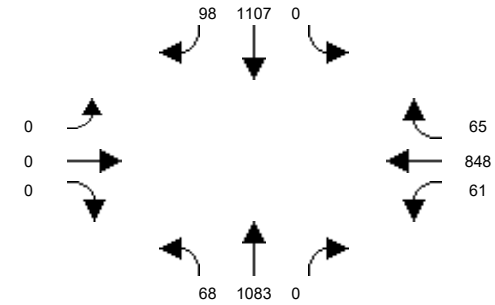

Intersection #53: Main St and 4th St

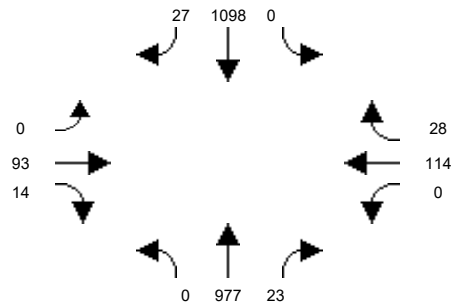

Intersection #54: Main St and 1st St

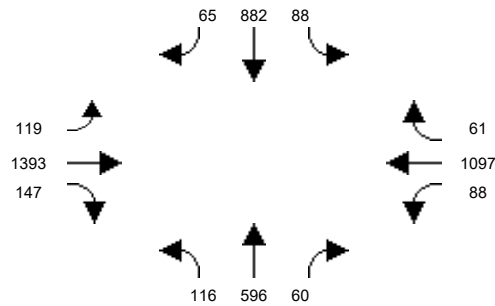

Intersection #55: Main St and McFadden Ave

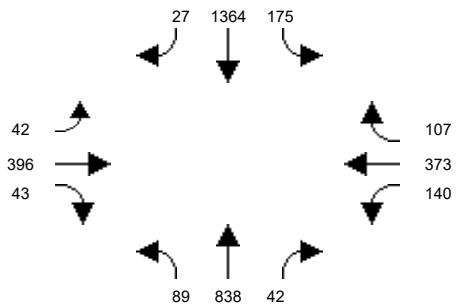

Intersection #56: Main St and Edinger Ave

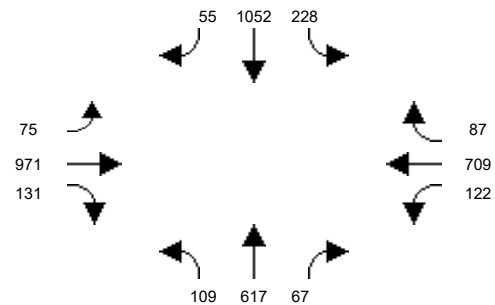

Intersection #57: Main St and MacArthur Blvd

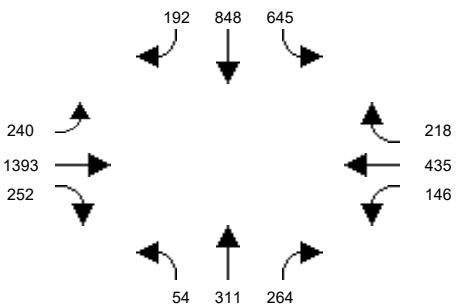

Intersection #58: Penn Wy and 17th St

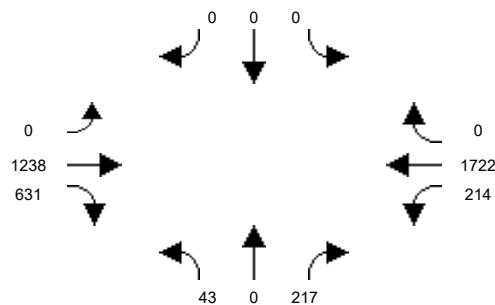

Intersection #59: I-5 NB Off Ramps/17th Street

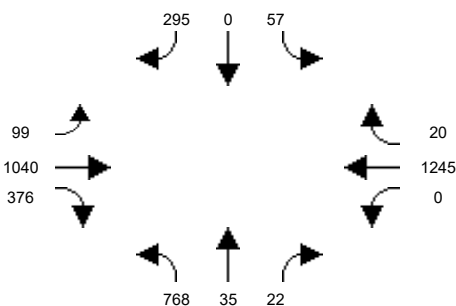

Intersection #60: Penn Wy and I-5 SB Ramps

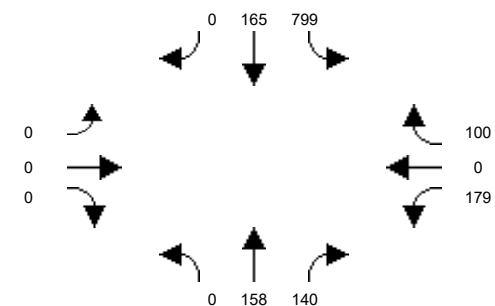

Santa Ana Circulation Element

Intersection Graphic Report
Entered Volume (Base Alternative)
2020 NP AM Peak Hour

Intersection #61: Santiago St and Civic Center Dr

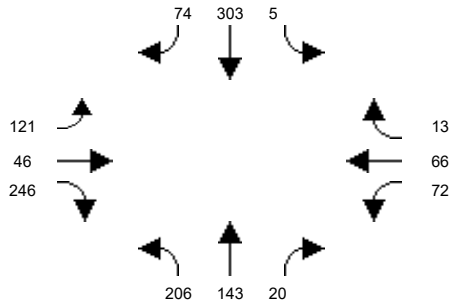

Intersection #62: Santiago St and Santa Ana Blvd

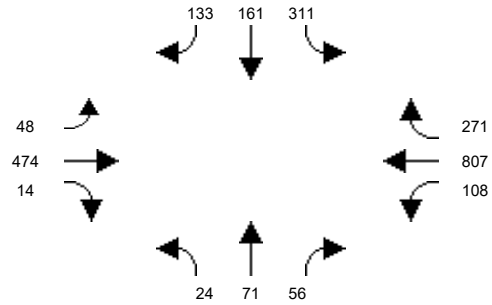

Intersection #64: Standard Ave and 1st St

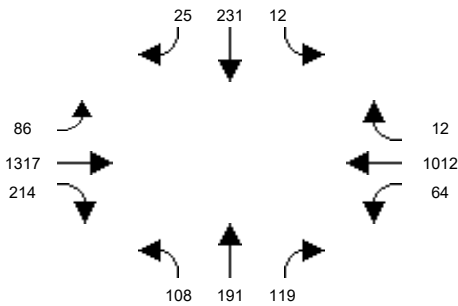

Intersection #65: Standard Ave and Mcfadden Ave

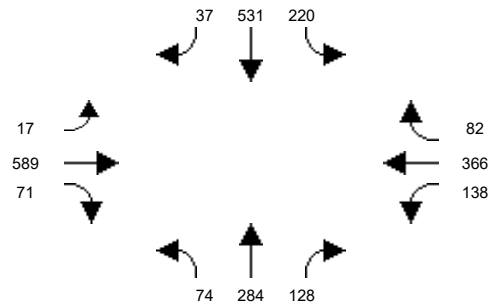

Intersection #66: Halladay St and Warner Ave

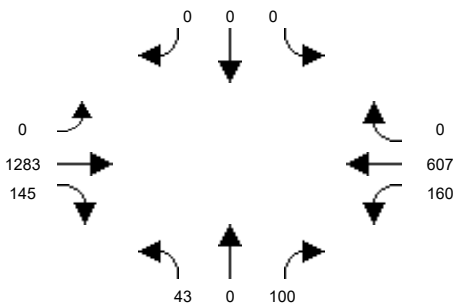

Intersection #67: Halladay St and Dyer Rd

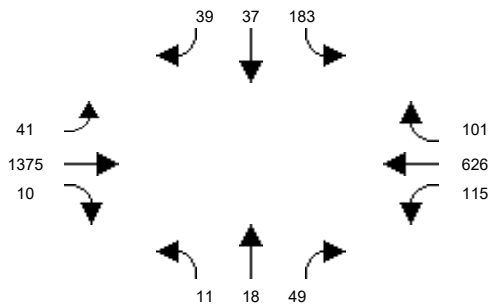

Intersection #68: SR-55 SB Ramps and MacArthur Blvd

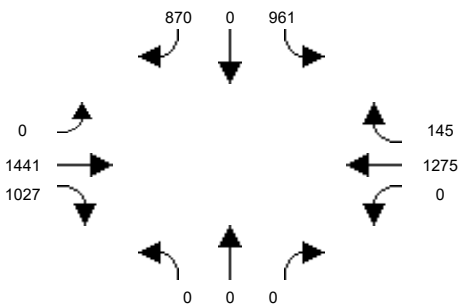

Intersection #69: SR-55 NB Ramps and MacArthur Blvd

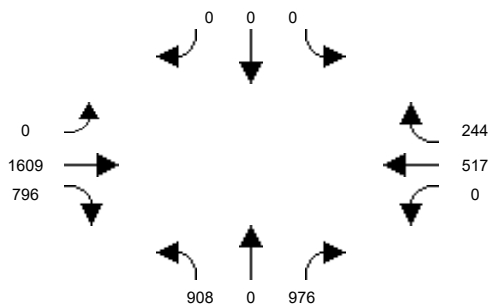

Intersection #70: SR-55 SB Ramps and Dyer Rd

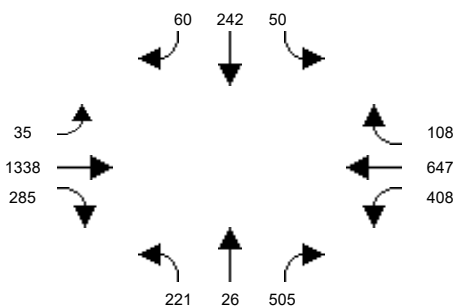

Intersection #71: Glassell St and La Veta Ave

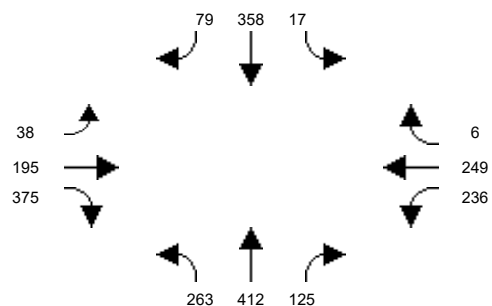

Santa Ana Circulation Element

Intersection Graphic Report
Entered Volume (Base Alternative)
2020 NP AM Peak Hour

Intersection #72: Glassell St and SR-22 WB Ramps

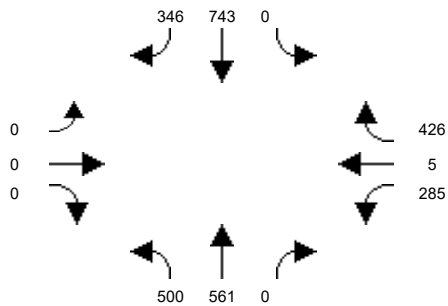

Intersection #73: Grand Ave / Glassell St and SR-22 EB Ramps

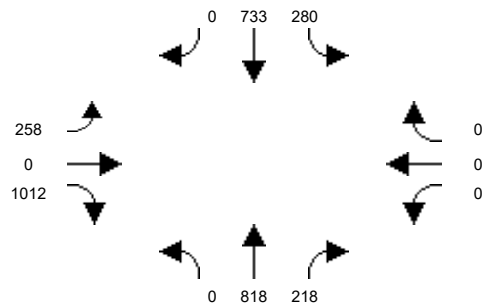

Intersection #74: Grand Ave and Fairhaven Ave

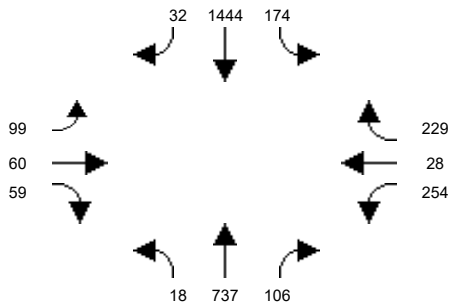

Intersection #75: Grand Ave and Santa Clara Ave

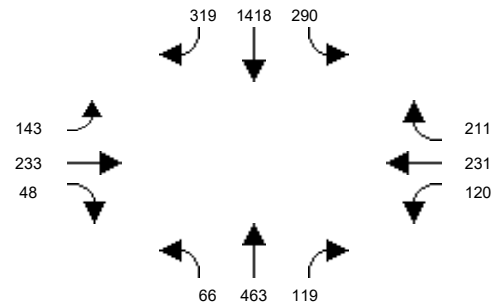

Intersection #76: Grand Ave and 17th St

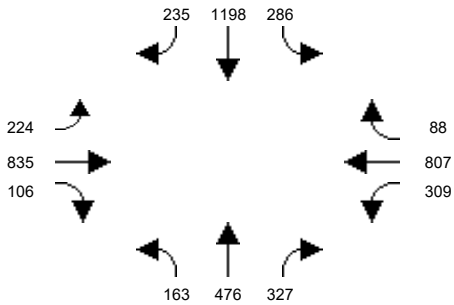

Intersection #77: Grand Ave and I-5 NB Ramps

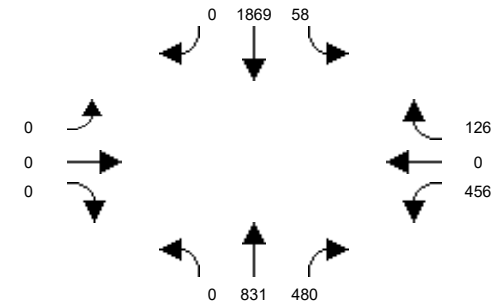

Intersection #78: Grand Ave and Santa Ana Blvd

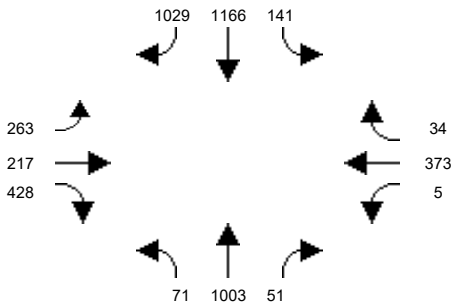

Intersection #79: Grand Ave and 1st St

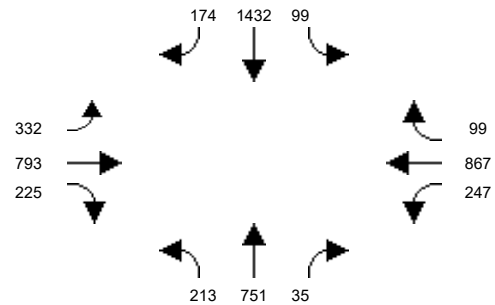

Intersection #80: Grand Ave and Chestnut Ave

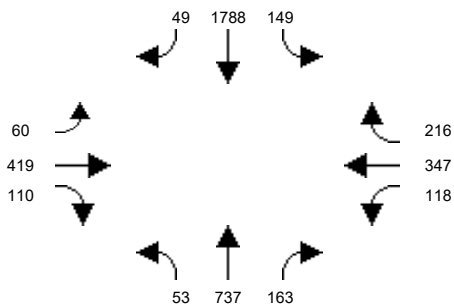

Intersection #81: Grand Ave and McFadden Ave

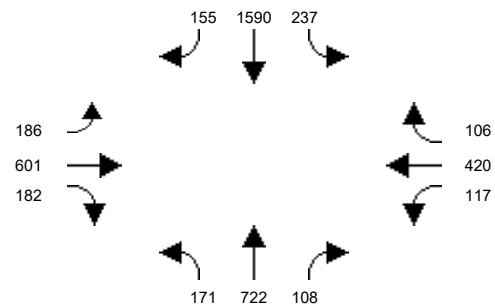

Santa Ana Circulation Element

Intersection Graphic Report
Entered Volume (Base Alternative)
2020 NP AM Peak Hour

Intersection #82: Grand Ave and Edinger Ave

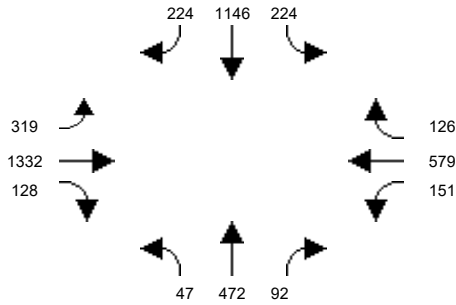

Intersection #83: Grand Ave and Warner Ave

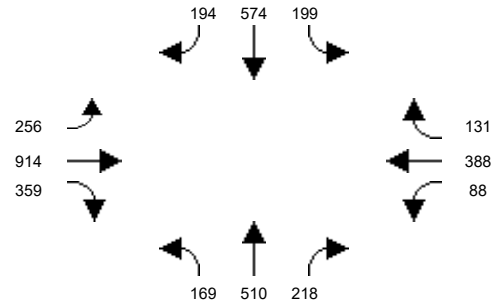

Intersection #84: SR-55 NB Ramps and Dyer Rd

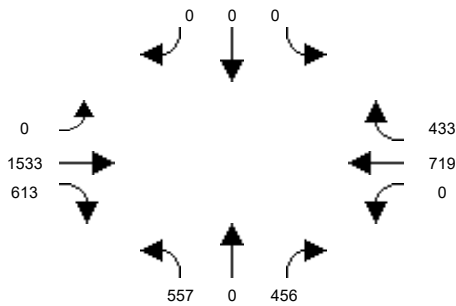

Intersection #85: Cambridge St and La Veta Ave

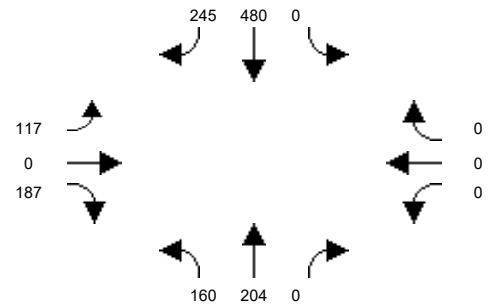

Intersection #86: Cambridge St and Fairhaven Ave

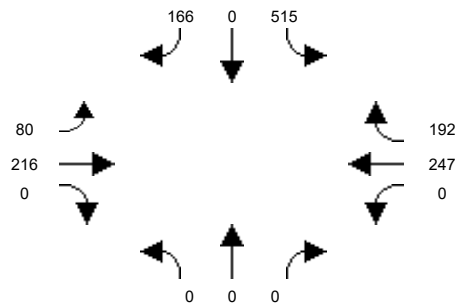

Intersection #87: Mabury St and 1st Street

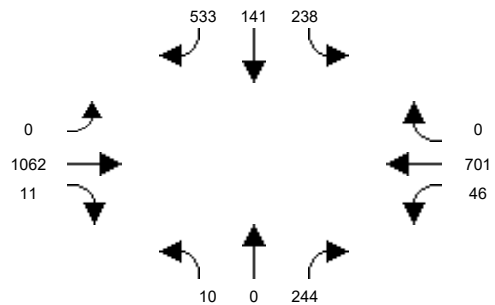

Intersection #88: Tustin St and La Veta Ave

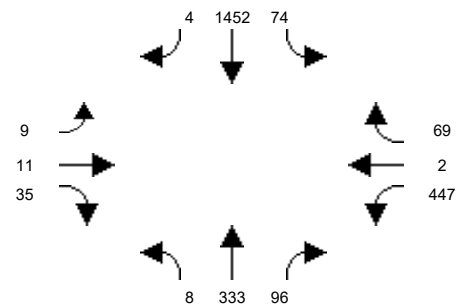

Intersection #89: Tustin St and SR-22 WB On-Ramp

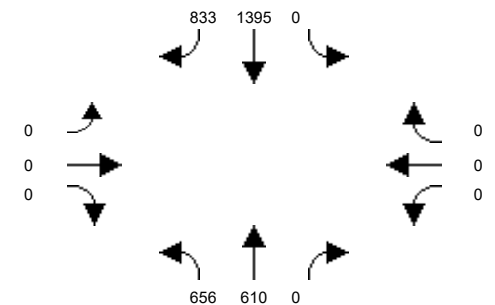

Intersection #90: Tustin St and SR-22 EB Off-Ramp / Seba Ave

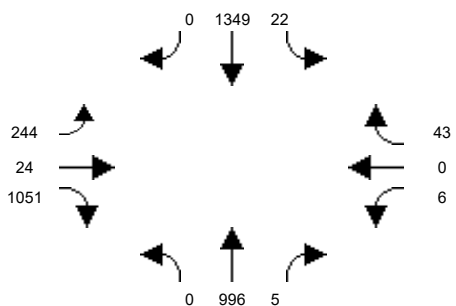

Intersection #91: Tustin Ave and Fairhaven Ave

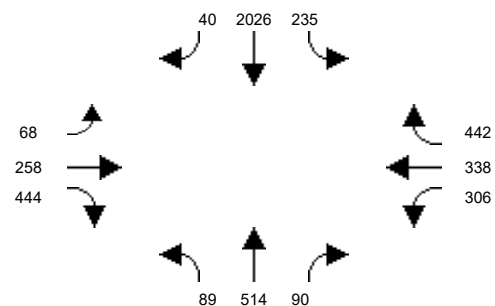

Santa Ana Circulation Element

Intersection Graphic Report
Entered Volume (Base Alternative)
2020 NP AM Peak Hour

Intersection #92: Tustin Ave and Santa Clara Ave

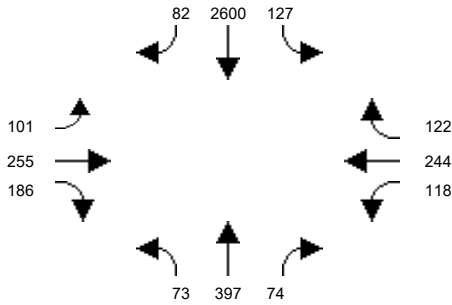

Intersection #93: Tustin Ave and 17th St

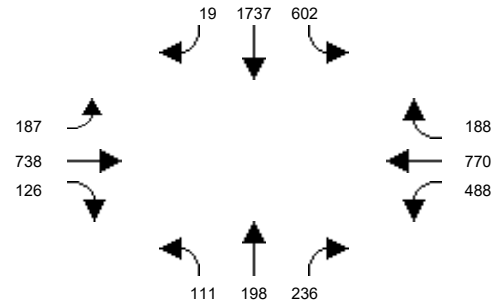

Intersection #94: Tustin Ave and 4th St

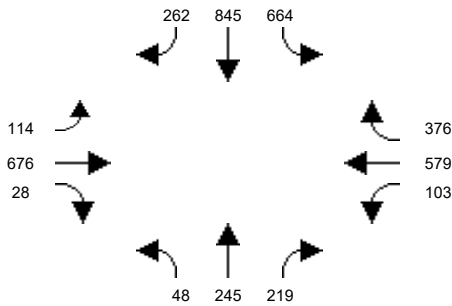

Intersection #95: SR-55 SB Ramps / Auto Mall Dr and Edinger Ave

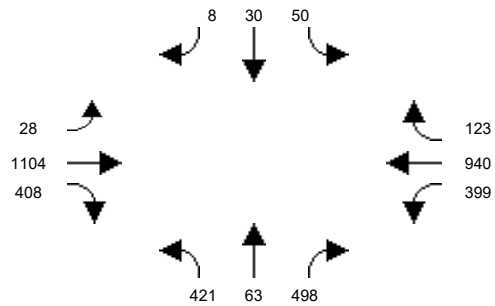

Intersection #96: SR-55 NB Ramps / Del Amo Ave and Newport

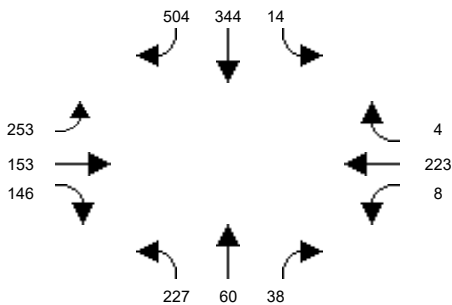

Intersection #97: Red Hill Ave and Edinger Ave

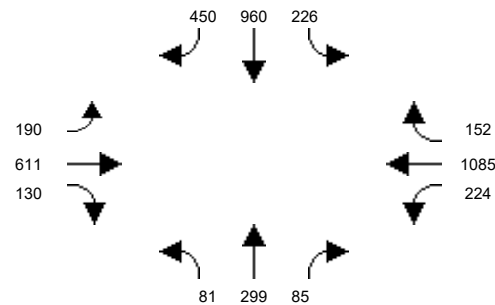

Intersection #98: Red Hill Ave and Warner Ave

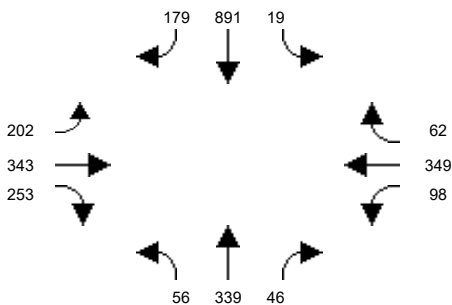

Intersection #99: Red Hill Ave and Dyer Rd / barranca Pkwy

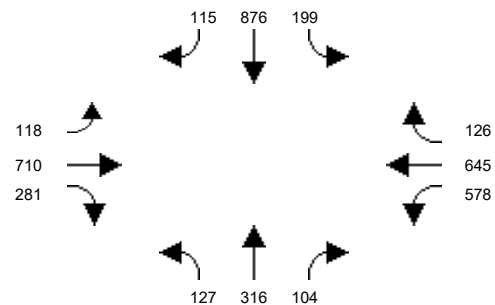

Intersection #100: Red Hill Ave and Alton Pkwy

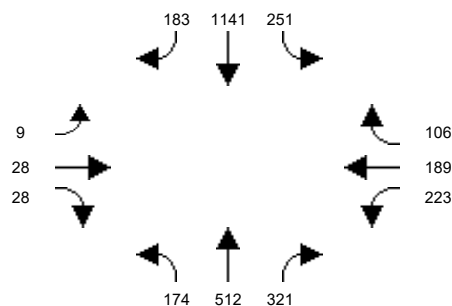

Intersection #101: Red Hill Ave and MacArthur Blvd

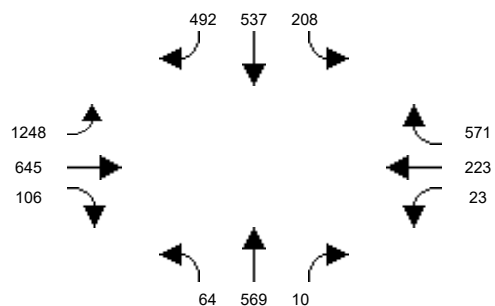

Santa Ana Circulation Element

Intersection Graphic Report
Entered Volume (Base Alternative)
2020 NP AM Peak Hour

Intersection #102: Red Hill Ave and Main St

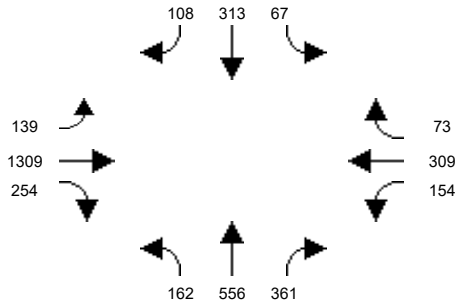

Intersection #103: I-5 SB Ramps and Santa Ana Blvd

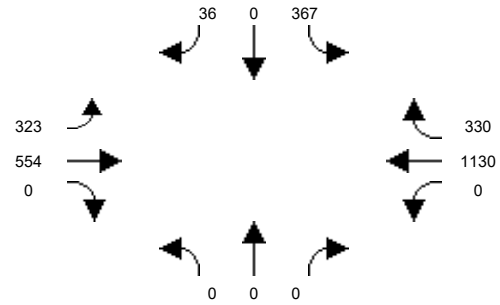

Intersection #104: Tustin Ranch Rd and Warner Ave

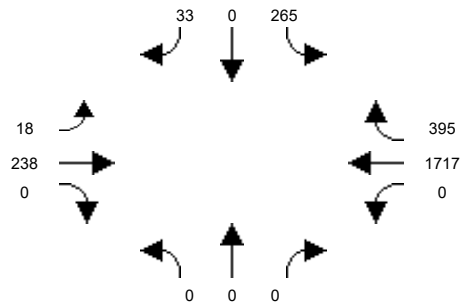

Intersection #105: Von Karman Ave and Barranca Pkwy

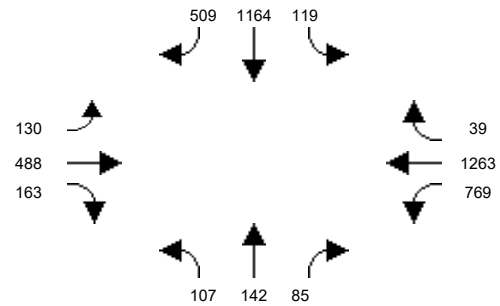

Intersection #106: Red Hill Avenue and El Camino Real

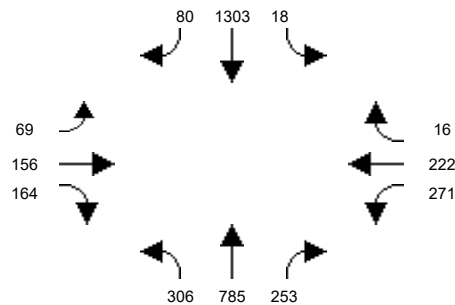

Intersection #107: Red Hill Avenue and I-5 NB Ramps

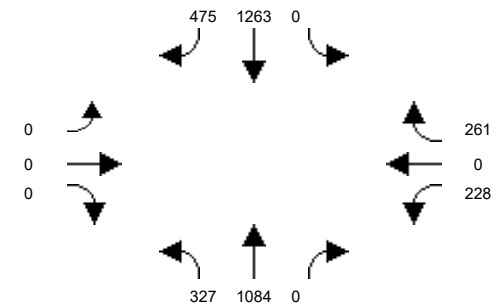

Intersection #108: Red Hill Avenue and I-5 SB Ramps

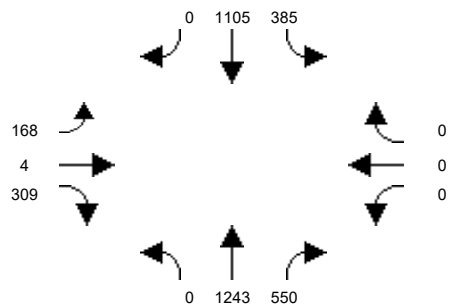

Intersection #109: Red Hill Avenue and Nisson Road

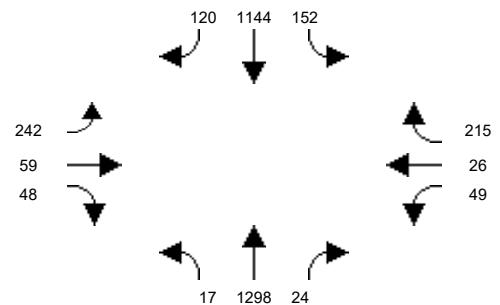

Intersection #110: Red Hill Avenue and Walnut Avenue

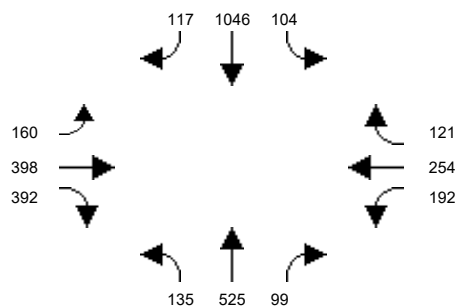

Intersection #111: Red Hill Avenue and Valencia Avenue

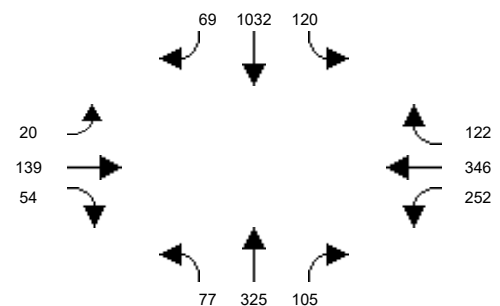

Santa Ana Circulation Element

Intersection Graphic Report
Entered Volume (Base Alternative)
2020 NP AM Peak Hour

Intersection #112: Tustin Ranch Road and Warner Avenue North

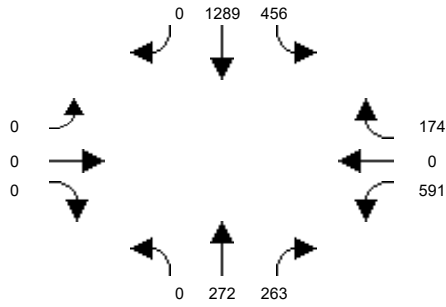

Intersection #113: Tustin Ranch Road and Walnut Avenue

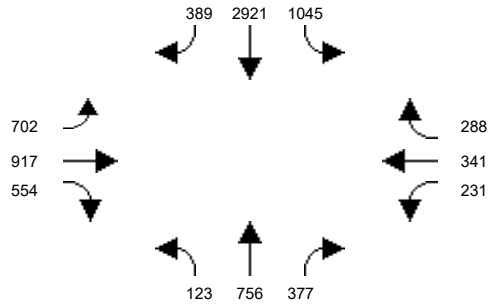

Intersection #114: SR-55 SB Ramps and Irvine Boulevard

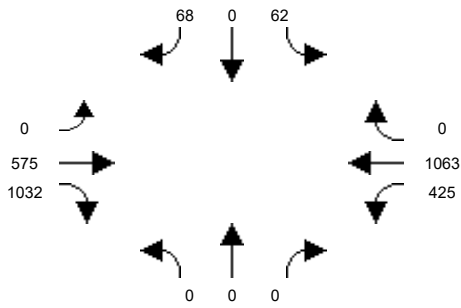

Intersection #115: SR-55 NB Ramps and Irvine Boulevard

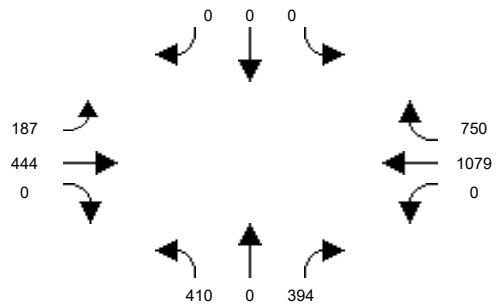

APPENDIX B.2
INTERSECTION VOLUMES –
2020 NP (PM PEAK HOUR)

Santa Ana Circulation Element

Intersection Graphic Report
Entered Volume (Base Alternative)
2020 NP PM Peak Hour

Intersection #1: Euclid St and 1st St

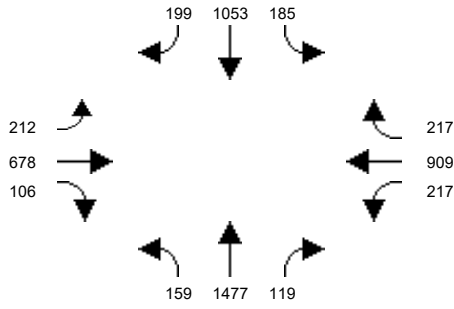

Intersection #2: Euclid St and McFadden Ave

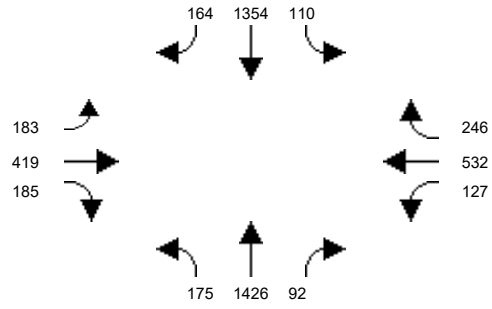

Intersection #3: Euclid St and Edinger Ave

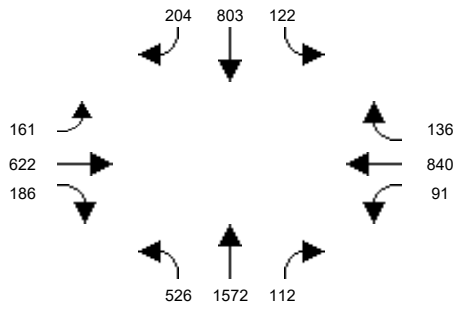

Intersection #4: Newhope St and Hazard Ave

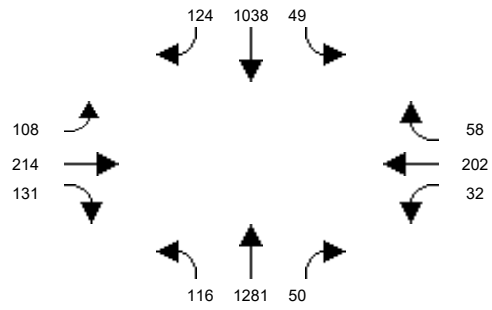

Intersection #5: Newhope St and McFadden Ave

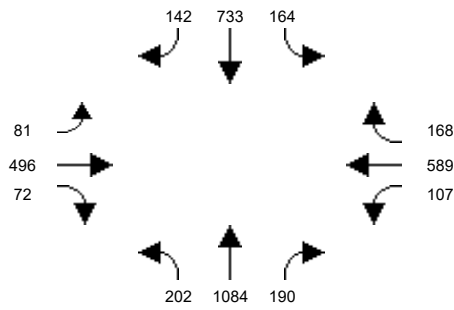

Intersection #6: Harbor Blvd and SR-22 WB Off-Ramp / Banner Dr

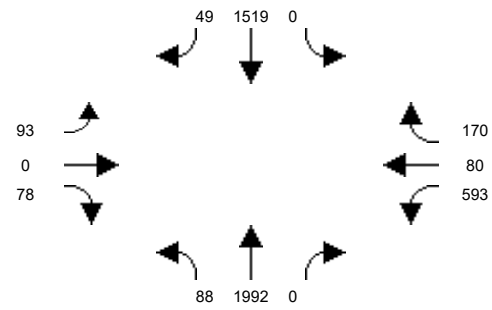

Intersection #7: Trask Avenue and SR-22 EB On-Ramp

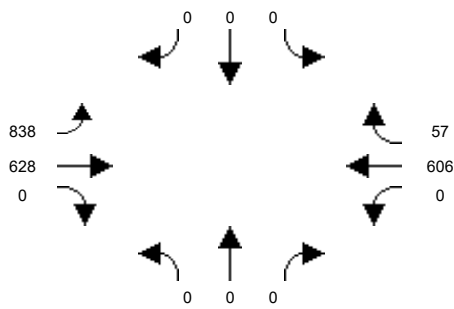

Intersection #8: Harbor Blvd and Westminster Ave

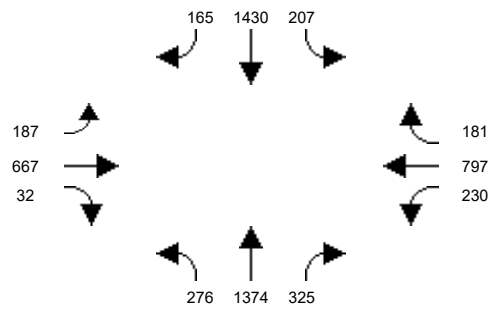

Intersection #9: Harbor Blvd and 1st St

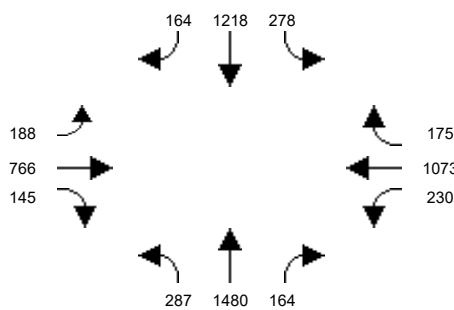

Intersection #10: Harbor Blvd and McFadden Ave

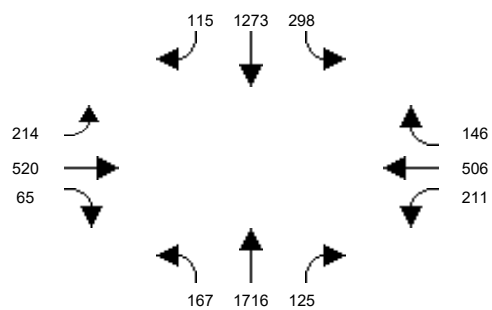

Santa Ana Circulation Element

Intersection Graphic Report
Entered Volume (Base Alternative)
2020 NP PM Peak Hour

Intersection #11: Harbor Blvd and Edinger Ave

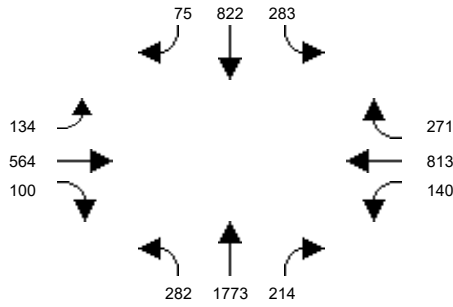

Intersection #12: Harbor Blvd and Warner Ave

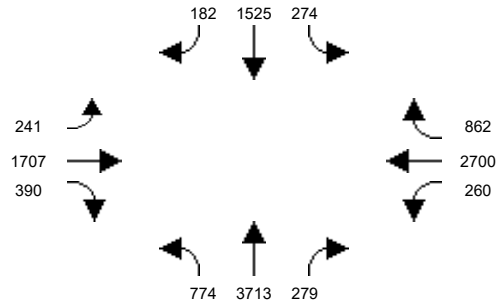

Intersection #13: Harbor Blvd and Segerstrom Ave

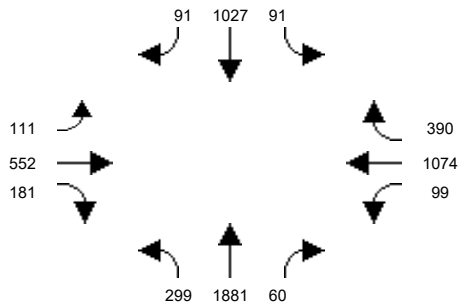

Intersection #14: MacArthur Blvd and Hyland Ave

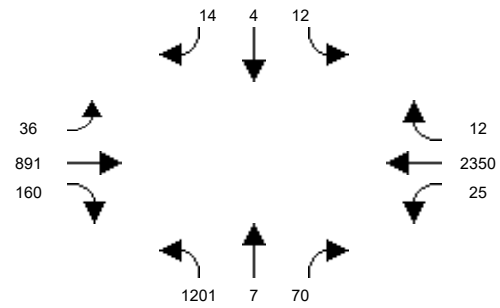

Intersection #15: MacArthur Blvd and Harbor Blvd

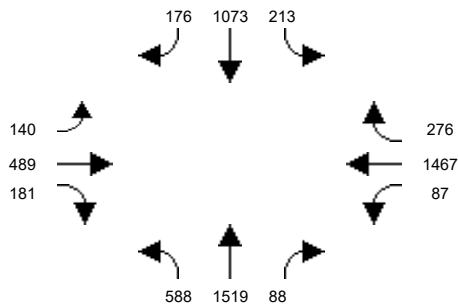

Intersection #16: Harbor Blvd and Sunflower Ave

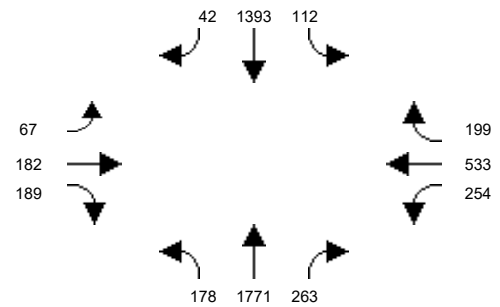

Intersection #17: Harbor Blvd and I-405 WB Off-Ramp

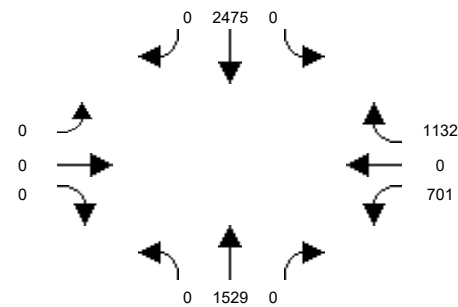

Intersection #18: Harbor Blvd and I-405 EB Off-Ramp

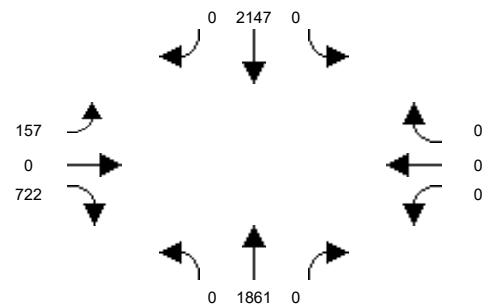

Intersection #19: Fairview St and Civic Center Dr

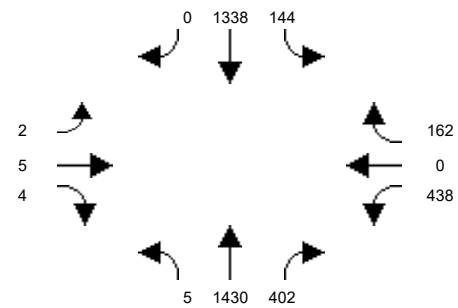

Intersection #20: Fairview St and 1st St

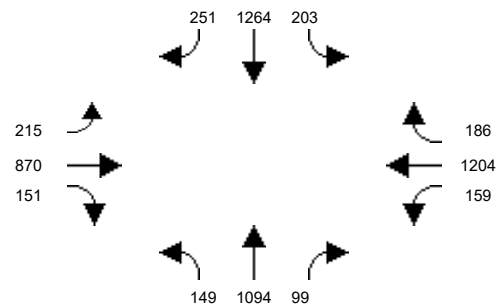

Santa Ana Circulation Element

Intersection Graphic Report
Entered Volume (Base Alternative)
2020 NP PM Peak Hour

Intersection #21: Fairview St and McFadden Ave

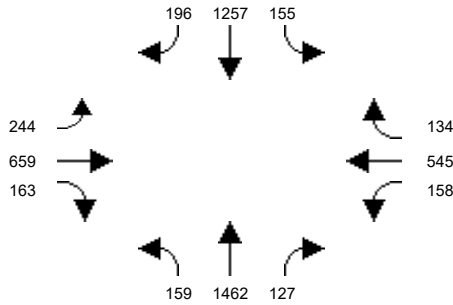

Intersection #22: Fairview St and Edinger Ave

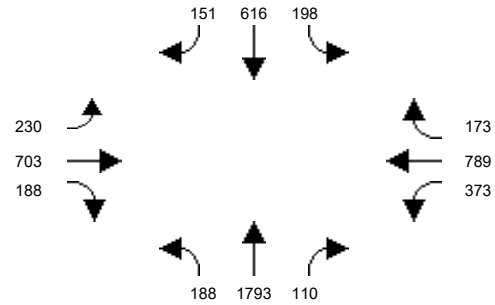

Intersection #23: Fairview St and Warner Ave

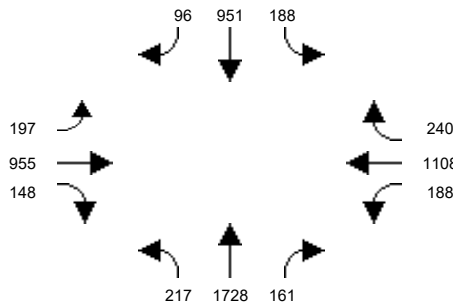

Intersection #24: Fairview St and MacArthur Blvd

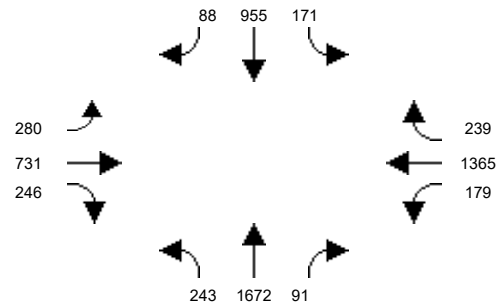

Intersection #25: Fairview Rd and Sunflower Ave

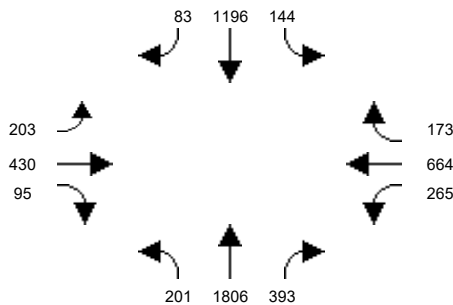

Intersection #26: Greenville St and Edinger Ave

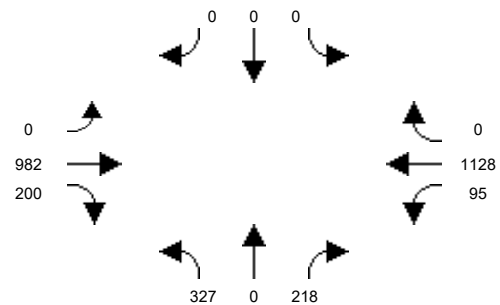

Intersection #27: Greenville St and Segerstrom Ave

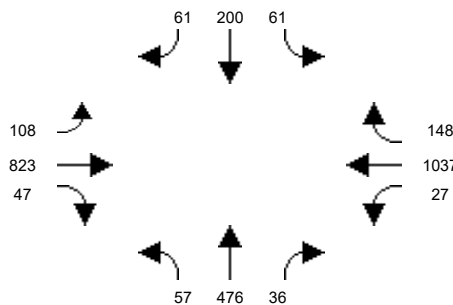

Intersection #28: Raitt St and McFadden Ave

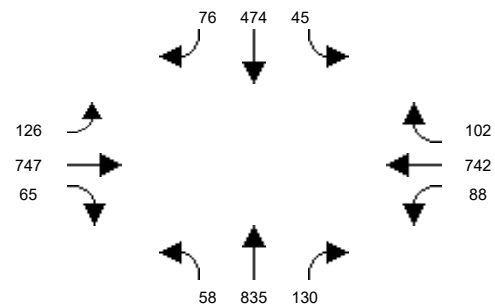

Intersection #29: Raitt St and Edinger Ave

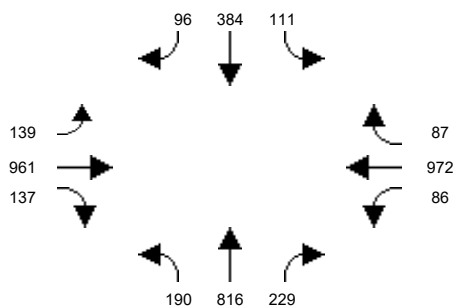

Intersection #30: Bear St and MacArthur Blvd

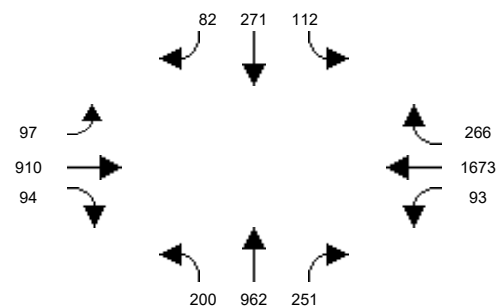

Santa Ana Circulation Element

Intersection Graphic Report
Entered Volume (Base Alternative)
2020 NP PM Peak Hour

Intersection #31: Bristol St and 17th St

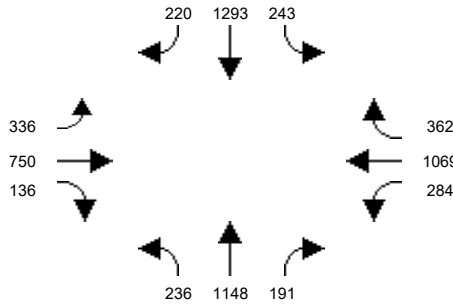

Intersection #32: Bristol St and Civic Center Dr

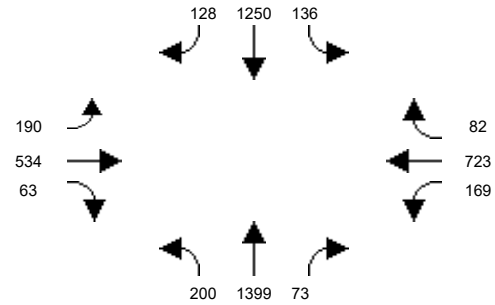

Intersection #33: Bristol St and Santa Ana Blvd

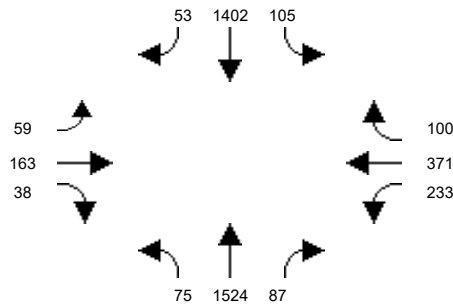

Intersection #34: Bristol St and 1st St

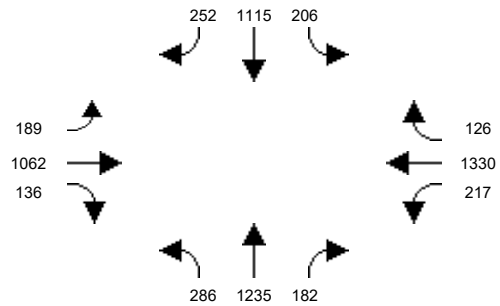

Intersection #35: Bristol St and McFadden Ave

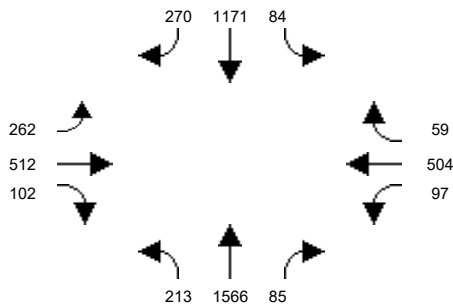

Intersection #36: Bristol St and Warner Ave

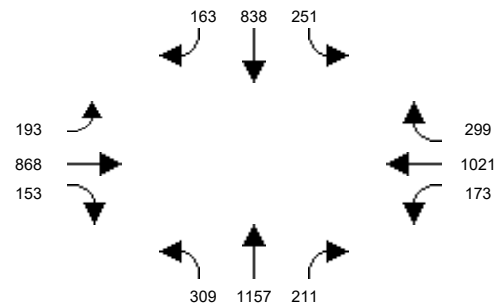

Intersection #37: Bristol St and Segerstrom Ave

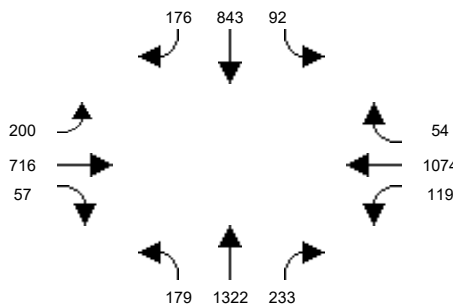

Intersection #38: Bristol St and Alton Ave

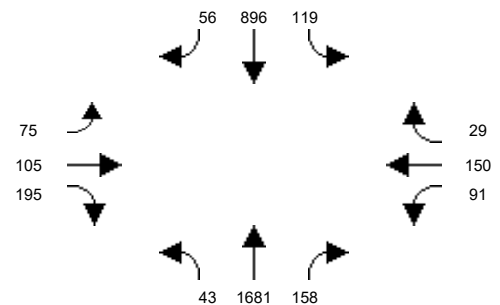

Intersection #39: Bristol St and MacArthur Blvd

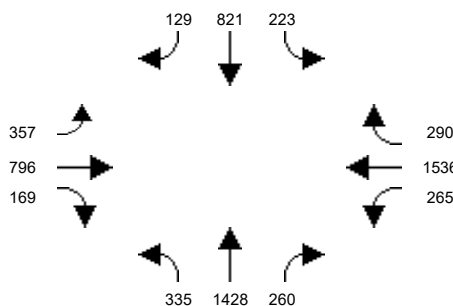

Intersection #40: Bristol St and Sunflower Ave

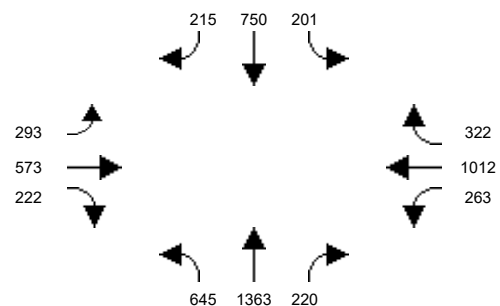

Santa Ana Circulation Element

Intersection Graphic Report
Entered Volume (Base Alternative)
2020 NP PM Peak Hour

Intersection #41: Bristol St and I-405 WB Ramps

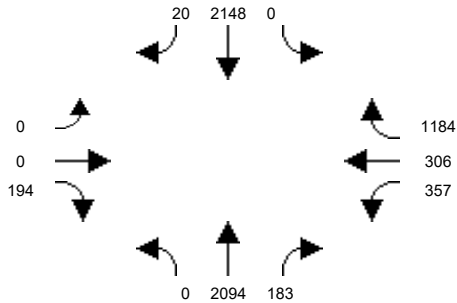

Intersection #42: Bristol St and I-405 EB Ramps

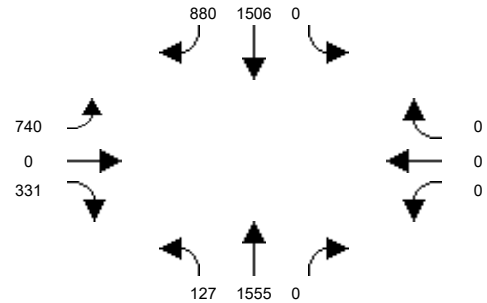

Intersection #43: Flower St and Santa Ana Blvd

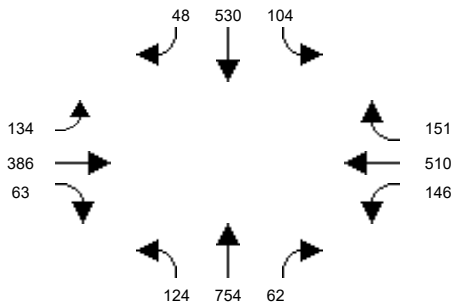

Intersection #44: Flower St and 1st St

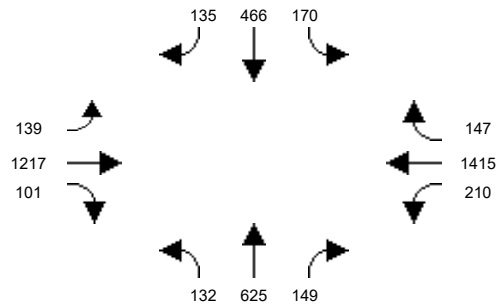

Intersection #45: Flower St and McFadden Ave

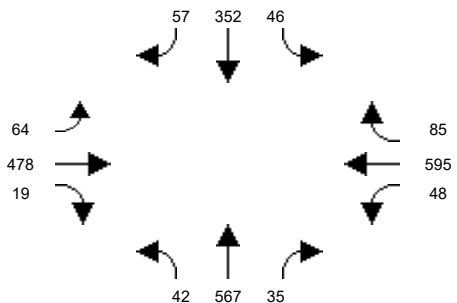

Intersection #46: Flower St and Segerstrom Ave

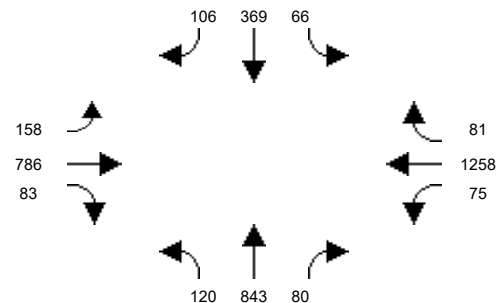

Intersection #47: Flower St and MacArthur Blvd

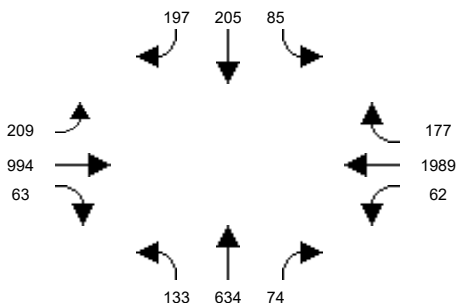

Intersection #48: Main St and La Veta Ave

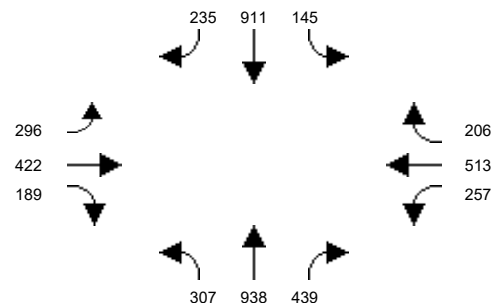

Intersection #49: Main St and Mainplace Dr / Memory Ln

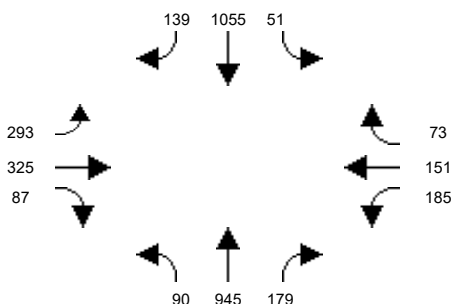

Intersection #50: Main St and 17th St

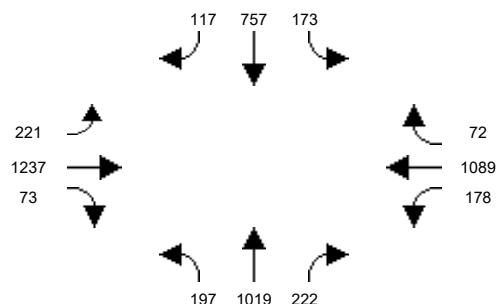

Santa Ana Circulation Element

Intersection Graphic Report
Entered Volume (Base Alternative)
2020 NP PM Peak Hour

Intersection #51: Main St and Civic Center Dr

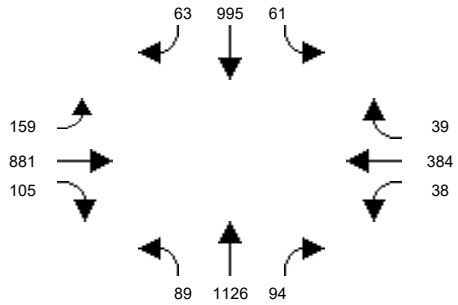

Intersection #52: Main St and Santa Ana Blvd

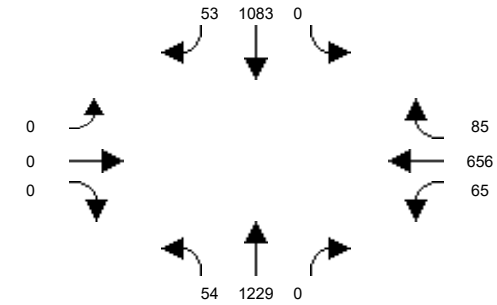

Intersection #53: Main St and 4th St

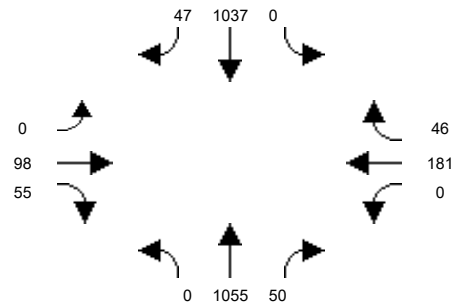

Intersection #54: Main St and 1st St

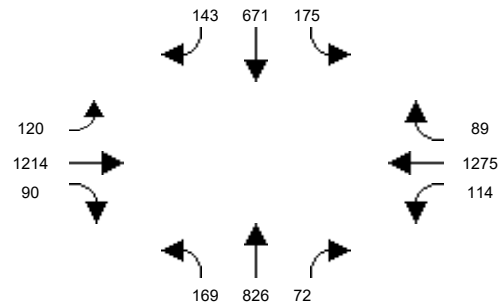

Intersection #55: Main St and McFadden Ave

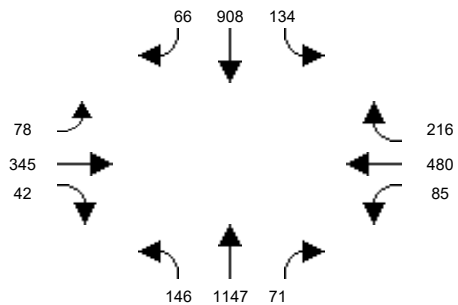

Intersection #56: Main St and Edinger Ave

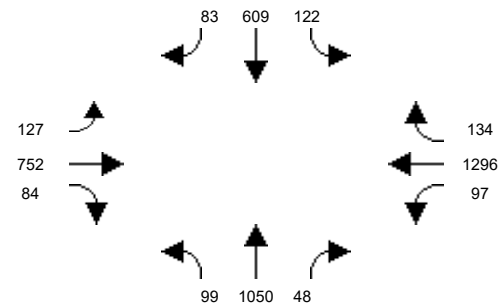

Intersection #57: Main St and MacArthur Blvd

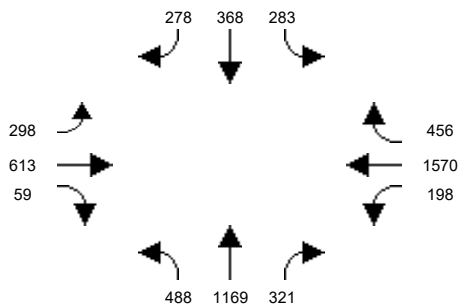

Intersection #58: Penn Wy and 17th St

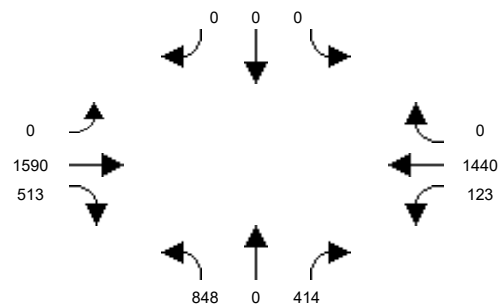

Intersection #59: I-5 NB Off Ramps/17th Street

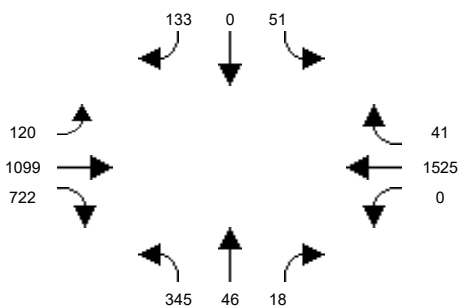

Intersection #60: Penn Wy and I-5 SB Ramps

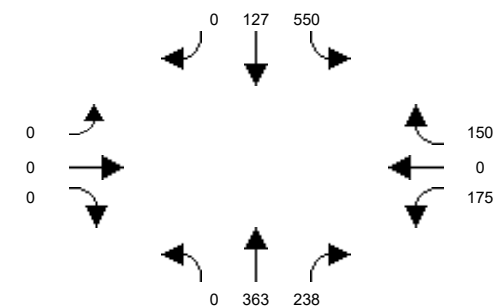

Santa Ana Circulation Element

Intersection Graphic Report
Entered Volume (Base Alternative)
2020 NP PM Peak Hour

Intersection #61: Santiago St and Civic Center Dr

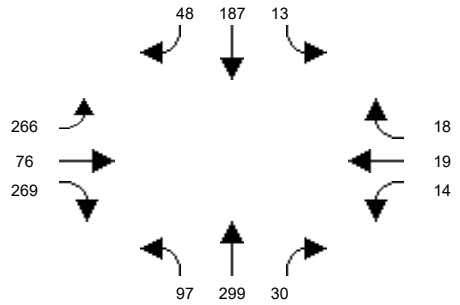

Intersection #62: Santiago St and Santa Ana Blvd

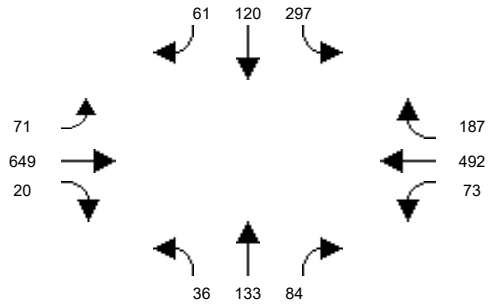

Intersection #64: Standard Ave and 1st St

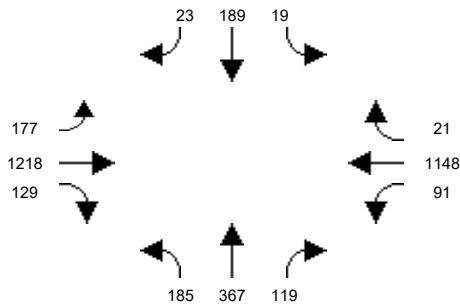

Intersection #65: Standard Ave and Mcfadden Ave

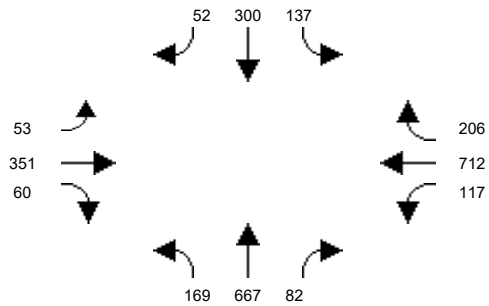

Intersection #66: Halladay St and Warner Ave

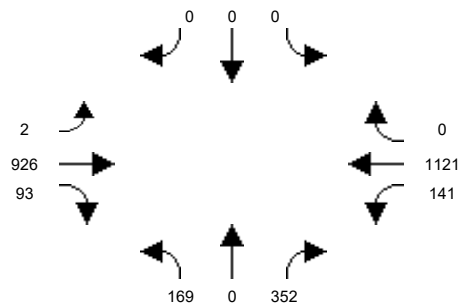

Intersection #67: Halladay St and Dyer Rd

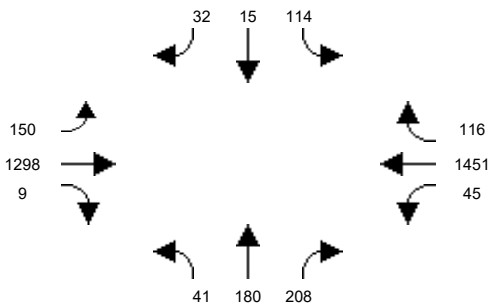

Intersection #68: SR-55 SB Ramps and MacArthur Blvd

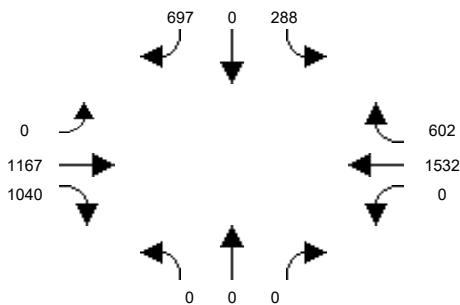

Intersection #69: SR-55 NB Ramps and MacArthur Blvd

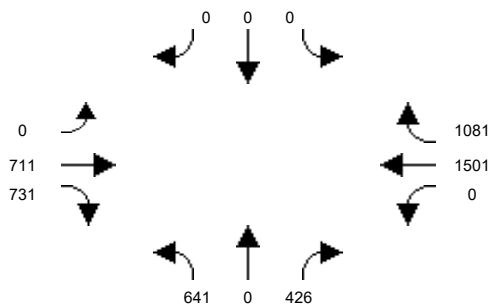

Intersection #70: SR-55 SB Ramps and Dyer Rd

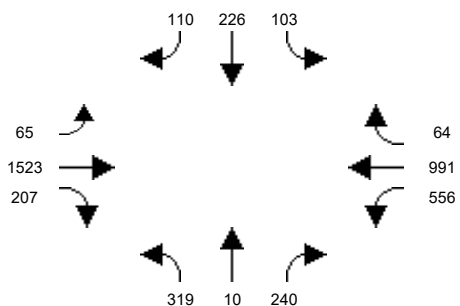

Intersection #71: Glassell St and La Veta Ave

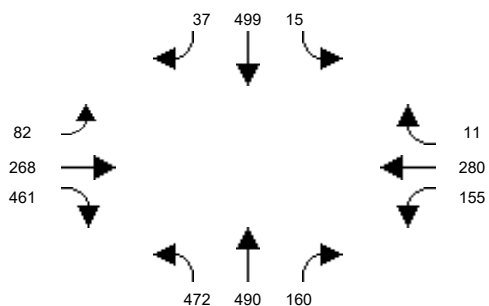

Santa Ana Circulation Element

Intersection Graphic Report
Entered Volume (Base Alternative)
2020 NP PM Peak Hour

Intersection #72: Glassell St and SR-22 WB Ramps

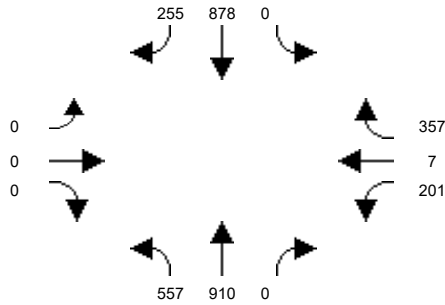

Intersection #73: Grand Ave / Glassell St and SR-22 EB Ramps

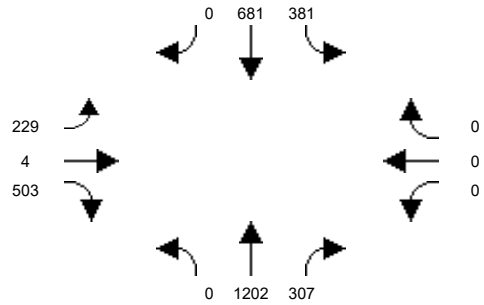

Intersection #74: Grand Ave and Fairhaven Ave

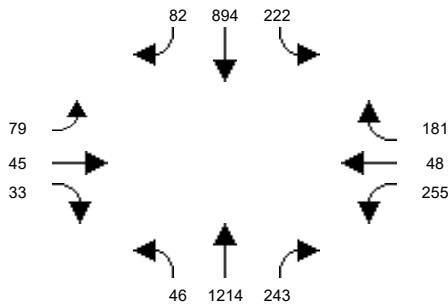

Intersection #75: Grand Ave and Santa Clara Ave

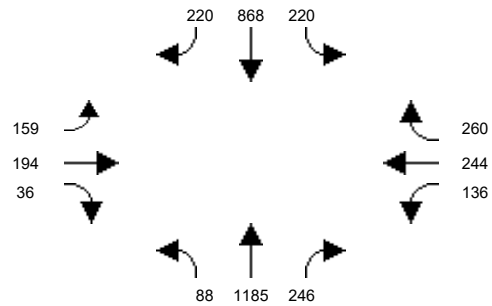

Intersection #76: Grand Ave and 17th St

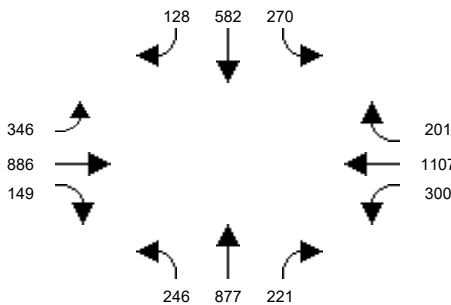

Intersection #77: Grand Ave and I-5 NB Ramps

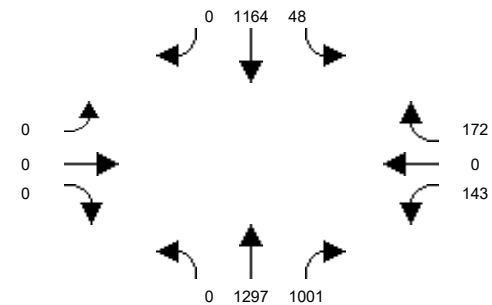

Intersection #78: Grand Ave and Santa Ana Blvd

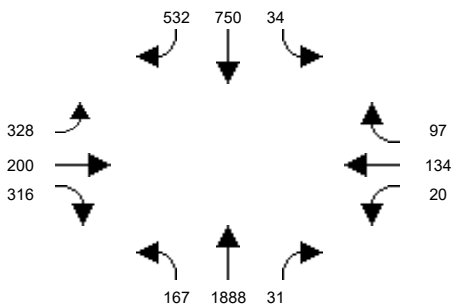

Intersection #79: Grand Ave and 1st St

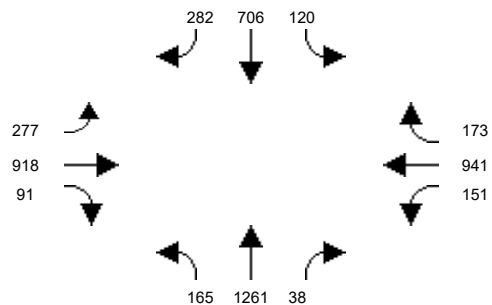

Intersection #80: Grand Ave and Chestnut Ave

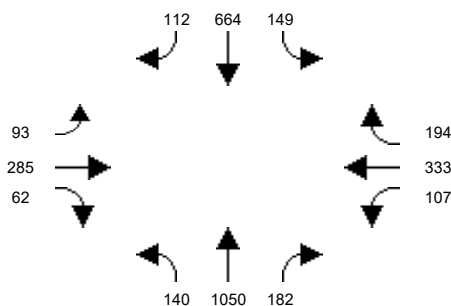

Intersection #81: Grand Ave and McFadden Ave

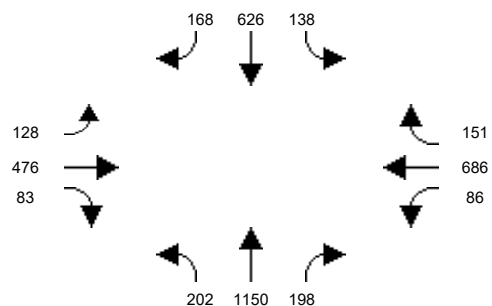

Santa Ana Circulation Element

Intersection Graphic Report
Entered Volume (Base Alternative)
2020 NP PM Peak Hour

Intersection #82: Grand Ave and Edinger Ave

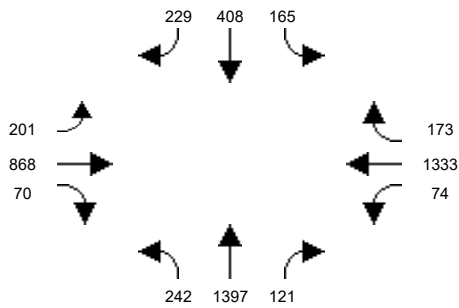

Intersection #83: Grand Ave and Warner Ave

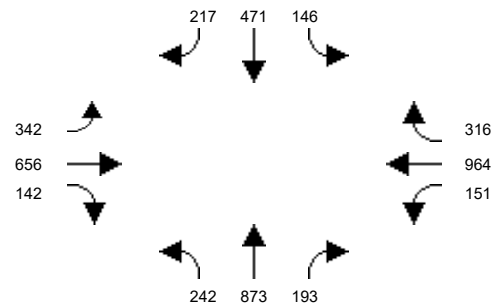

Intersection #84: SR-55 NB Ramps and Dyer Rd

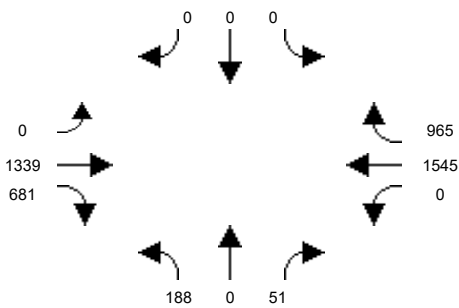

Intersection #85: Cambridge St and La Veta Ave

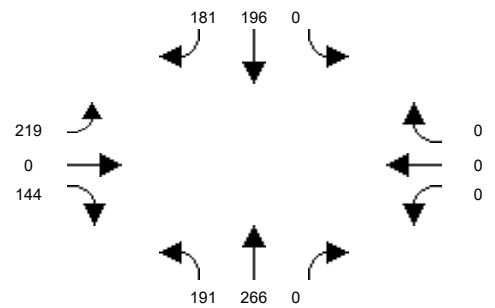

Intersection #86: Cambridge St and Fairhaven Ave

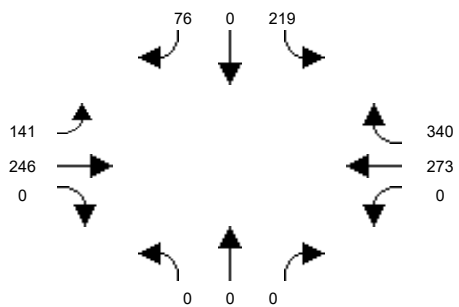

Intersection #87: Mabury St and 1st Street

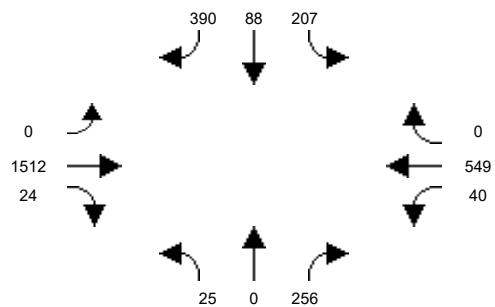

Intersection #88: Tustin St and La Veta Ave

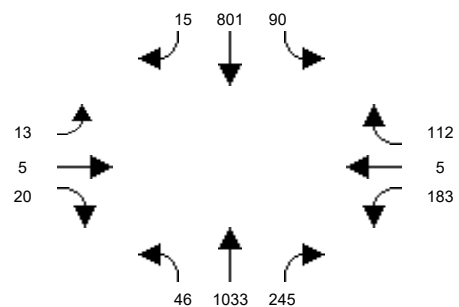

Intersection #89: Tustin St and SR-22 WB On-Ramp

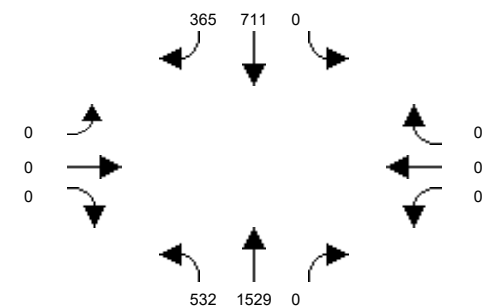

Intersection #90: Tustin St and SR-22 EB Off-Ramp / Seba Ave

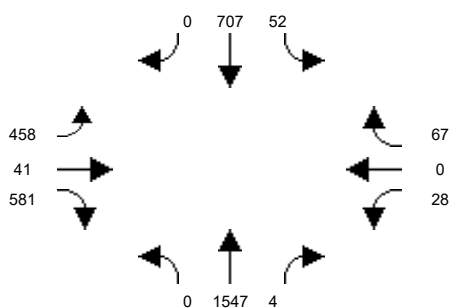

Intersection #91: Tustin Ave and Fairhaven Ave

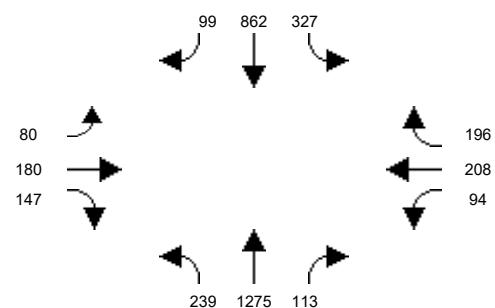

Santa Ana Circulation Element

Intersection Graphic Report
Entered Volume (Base Alternative)
2020 NP PM Peak Hour

Intersection #92: Tustin Ave and Santa Clara Ave

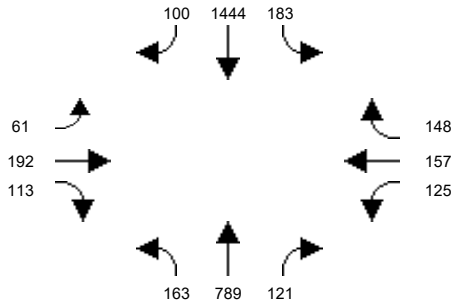

Intersection #93: Tustin Ave and 17th St

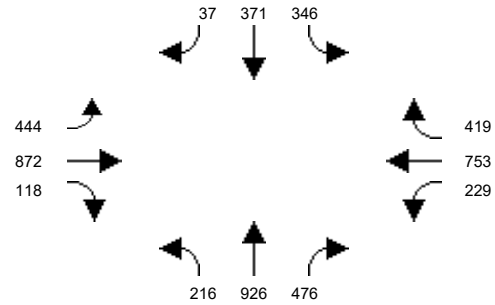

Intersection #94: Tustin Ave and 4th St

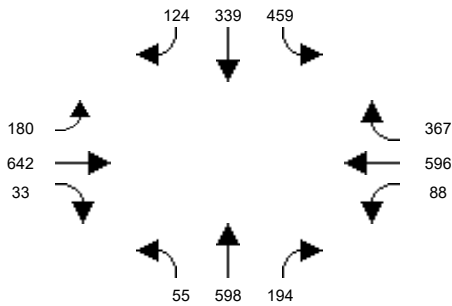

Intersection #95: SR-55 SB Ramps / Auto Mall Dr and Edinger Ave

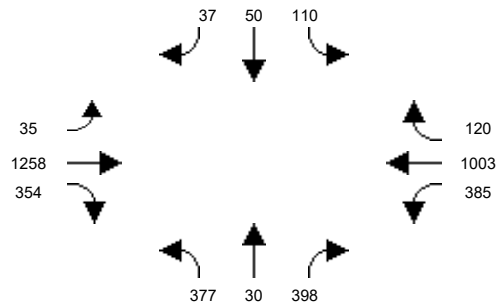

Intersection #96: SR-55 NB Ramps / Del Amo Ave and Newport

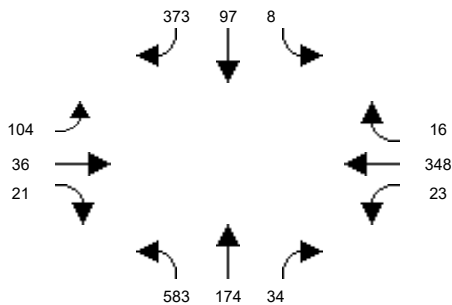

Intersection #97: Red Hill Ave and Edinger Ave

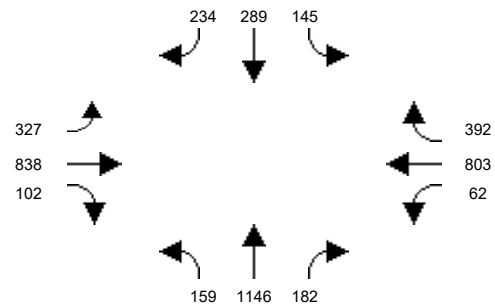

Intersection #98: Red Hill Ave and Warner Ave

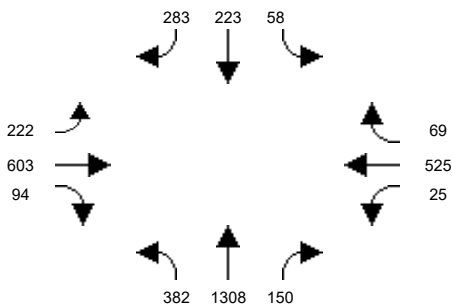

Intersection #99: Red Hill Ave and Dyer Rd / barranca Pkwy

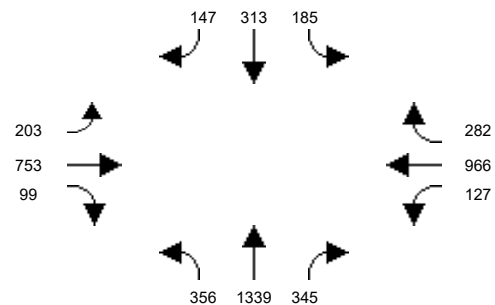

Intersection #100: Red Hill Ave and Alton Pkwy

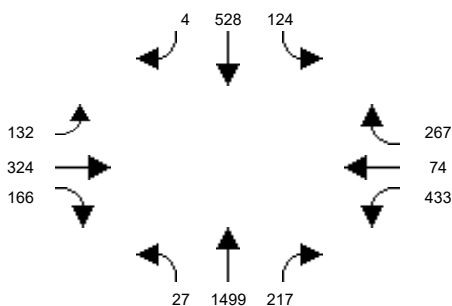

Intersection #101: Red Hill Ave and MacArthur Blvd

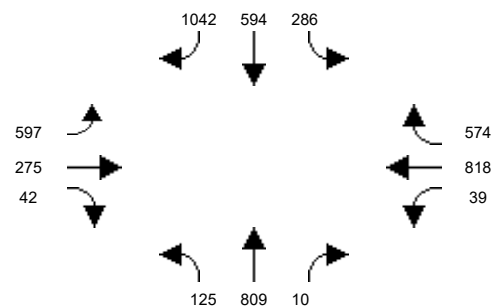

Santa Ana Circulation Element

Intersection Graphic Report
Entered Volume (Base Alternative)
2020 NP PM Peak Hour

Intersection #102: Red Hill Ave and Main St

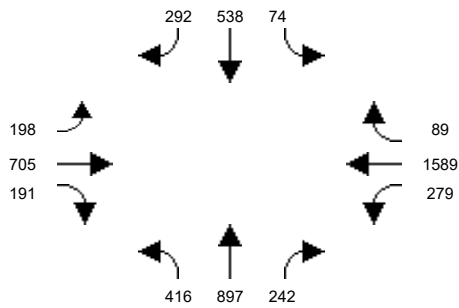

Intersection #103: I-5 SB Ramps and Santa Ana Blvd

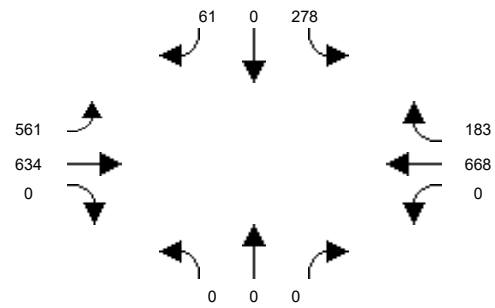

Intersection #104: Tustin Ranch Rd and Warner Ave

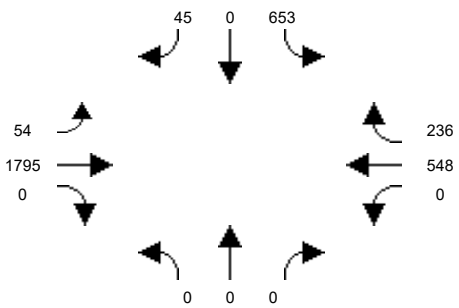

Intersection #105: Von Karman Ave and Barranca Pkwy

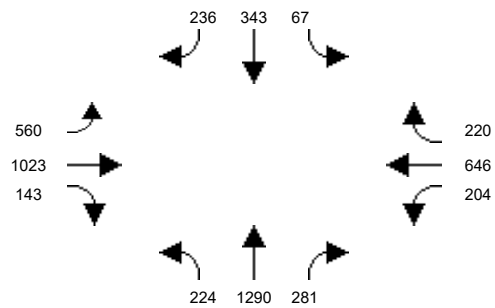

Intersection #106: Red Hill Avenue and El Camino Real

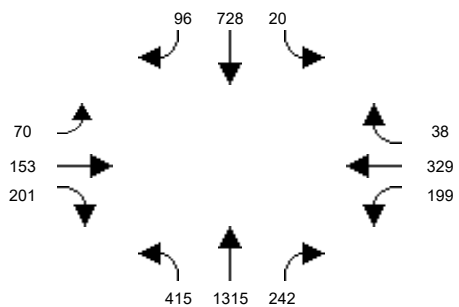

Intersection #107: Red Hill Avenue and I-5 NB Ramps

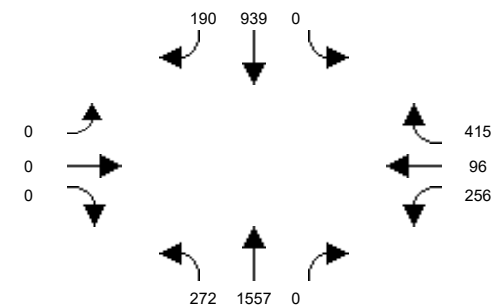

Intersection #108: Red Hill Avenue and I-5 SB Ramps

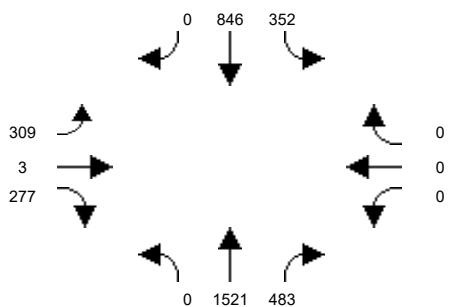

Intersection #109: Red Hill Avenue and Nisson Road

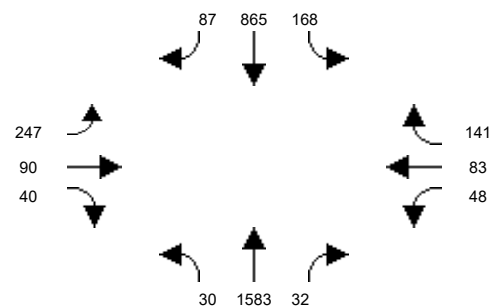

Intersection #110: Red Hill Avenue and Walnut Avenue

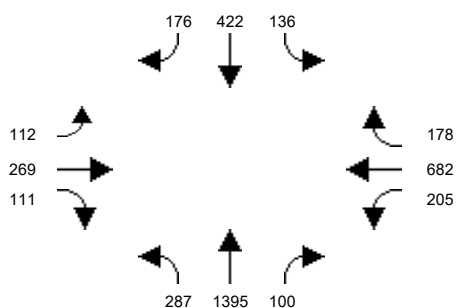

Intersection #111: Red Hill Avenue and Valencia Avenue

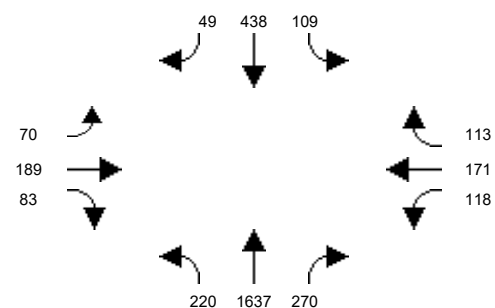

Santa Ana Circulation Element

Intersection Graphic Report
Entered Volume (Base Alternative)
2020 NP PM Peak Hour

Intersection #112: Tustin Ranch Road and Warner Avenue North

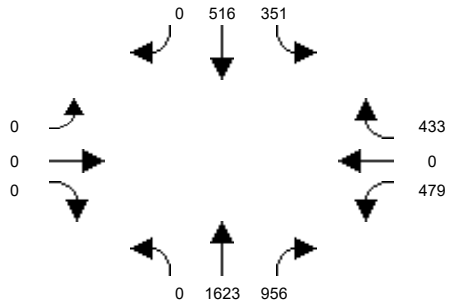

Intersection #113: Tustin Ranch Road and Walnut Avenue

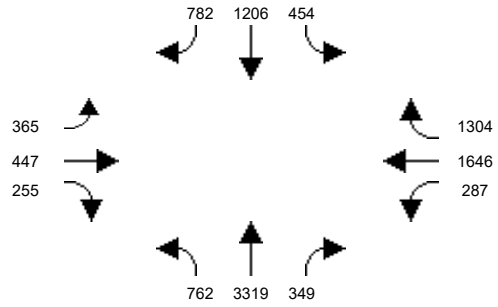

Intersection #114: SR-55 SB Ramps and Irvine Boulevard

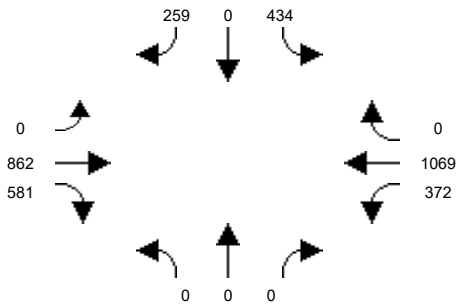

Intersection #115: SR-55 NB Ramps and Irvine Boulevard

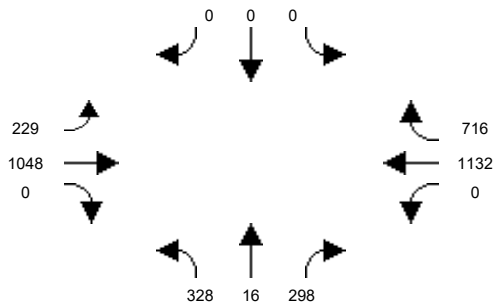

APPENDIX B.3
INTERSECTION VOLUMES –
2045 NP (AM PEAK HOUR)

Santa Ana Circulation Element

Intersection Graphic Report
Entered Volume (Base Alternative)
2045 NP AM Peak Hour

Intersection #1: Euclid St and 1st St

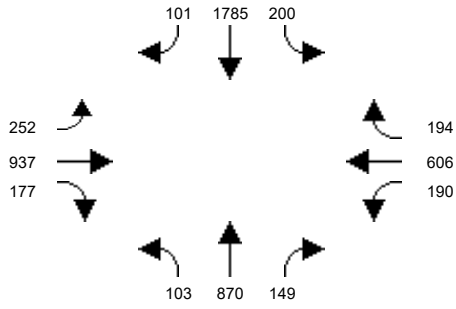

Intersection #2: Euclid St and McFadden Ave

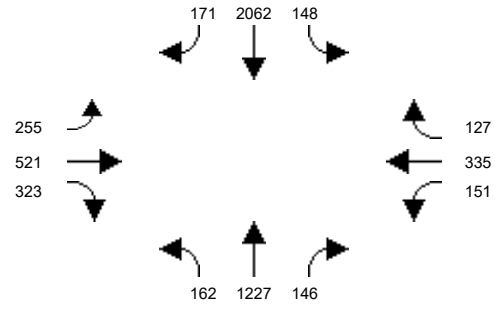

Intersection #3: Euclid St and Edinger Ave

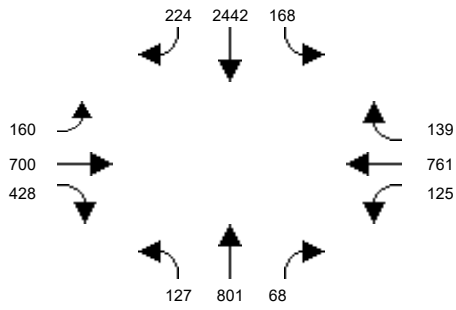

Intersection #4: Newhope St and Hazard Ave

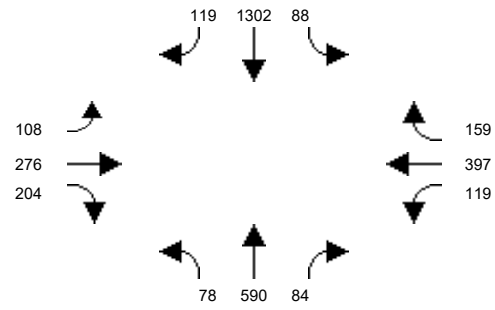

Intersection #5: Newhope St and McFadden Ave

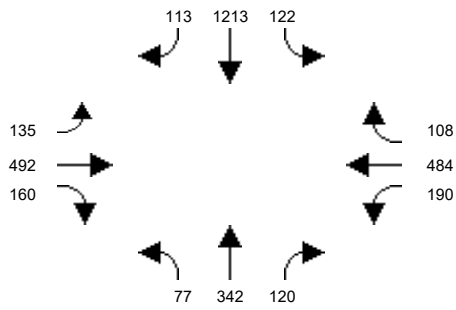

Intersection #6: Harbor Blvd and SR-22 WB Off-Ramp / Banner Dr

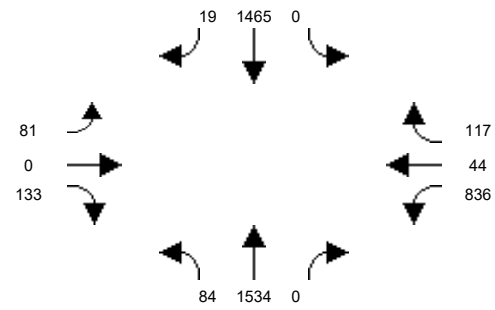

Intersection #7: Trask Avenue and SR-22 EB On-Ramp

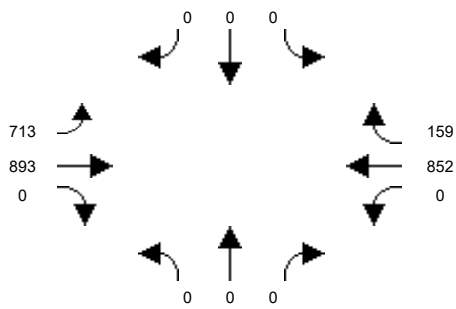

Intersection #8: Harbor Blvd and Westminster Ave

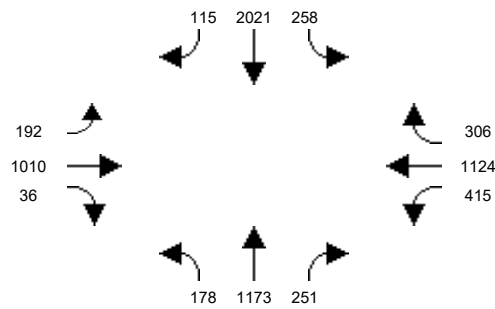

Intersection #9: Harbor Blvd and 1st St

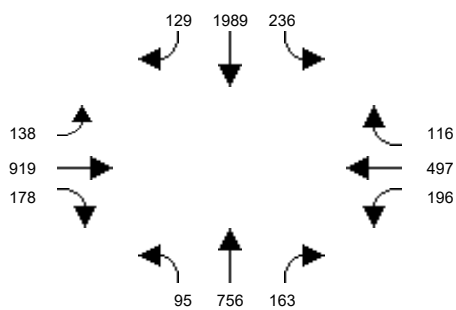

Intersection #10: Harbor Blvd and McFadden Ave

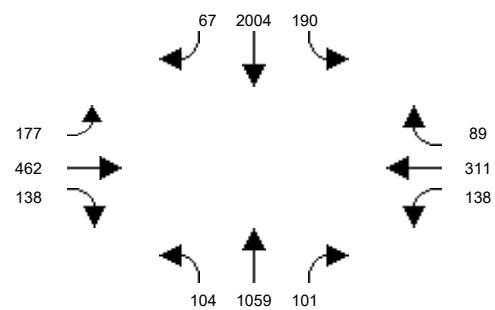

Santa Ana Circulation Element

Intersection Graphic Report
Entered Volume (Base Alternative)
2045 NP AM Peak Hour

Intersection #11: Harbor Blvd and Edinger Ave

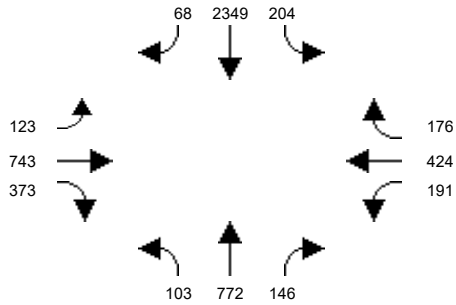

Intersection #12: Harbor Blvd and Warner Ave

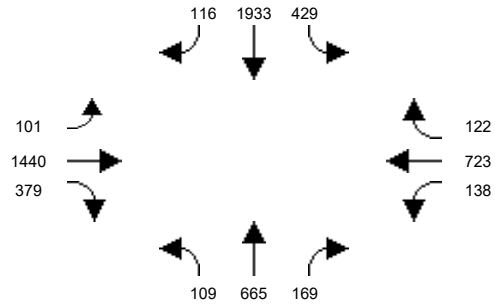

Intersection #13: Harbor Blvd and Segerstrom Ave

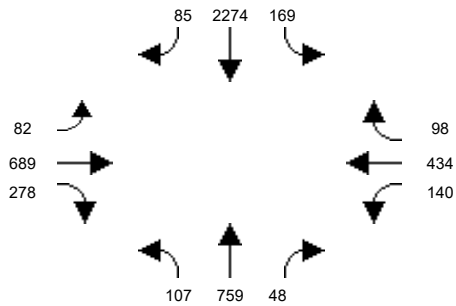

Intersection #14: MacArthur Blvd and Hyland Ave

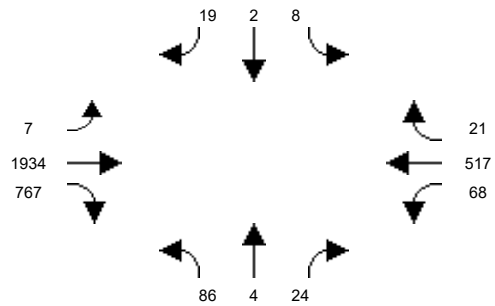

Intersection #15: MacArthur Blvd and Harbor Blvd

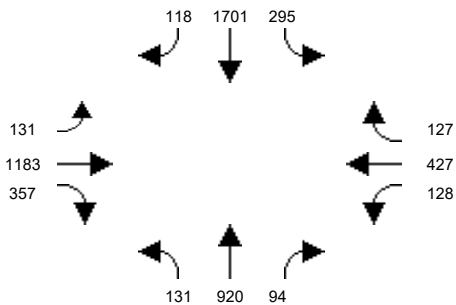

Intersection #16: Harbor Blvd and Sunflower Ave

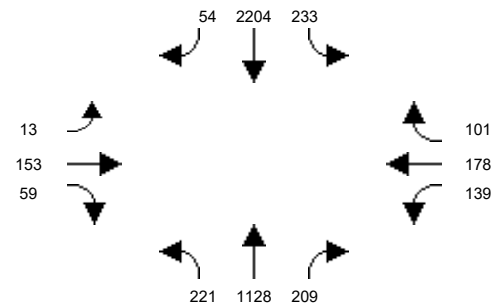

Intersection #17: Harbor Blvd and I-405 NB Off-Ramp

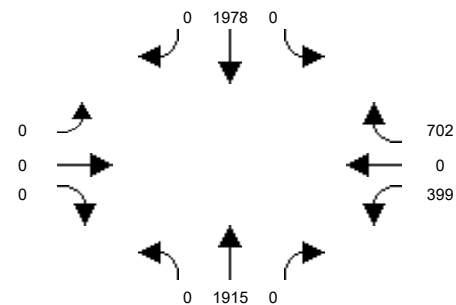

Intersection #18: Harbor Blvd and I-405 SB Off-Ramp

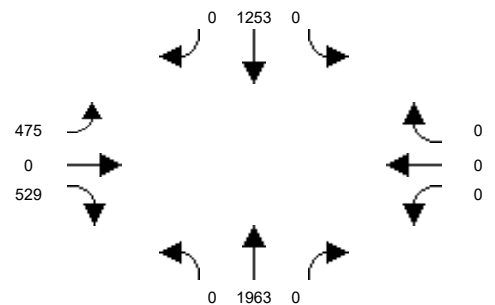

Intersection #19: Fairview St and Civic Center Dr

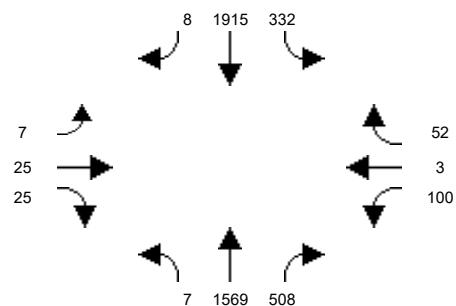

Intersection #20: Fairview St and 1st St

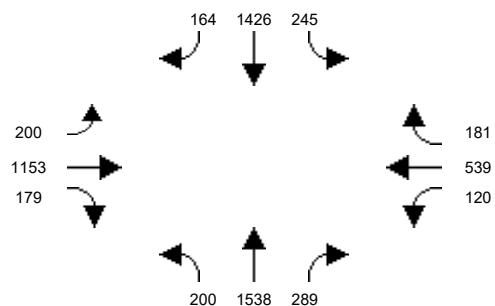

Santa Ana Circulation Element

Intersection Graphic Report
Entered Volume (Base Alternative)
2045 NP AM Peak Hour

Intersection #21: Fairview St and McFadden Ave

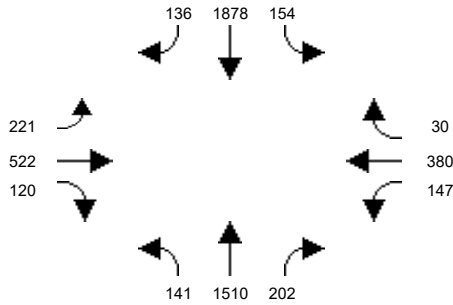

Intersection #22: Fairview St and Edinger Ave

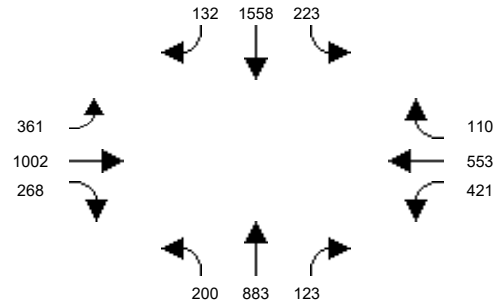

Intersection #23: Fairview St and Warner Ave

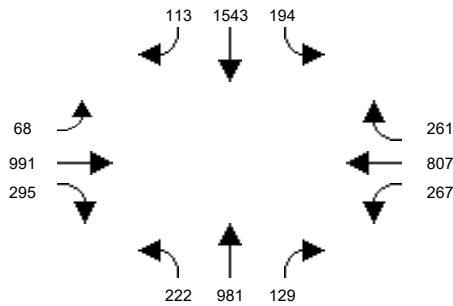

Intersection #24: Fairview St and MacArthur Blvd

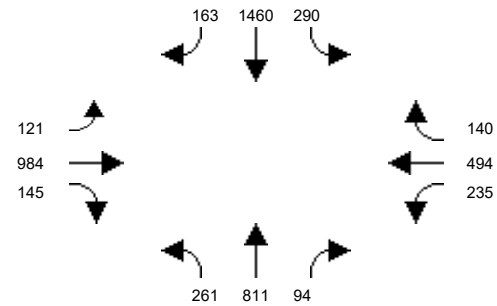

Intersection #25: Fairview Rd and Sunflower Ave

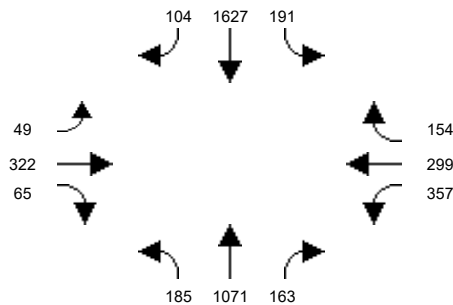

Intersection #26: Greenville St and Edinger Ave

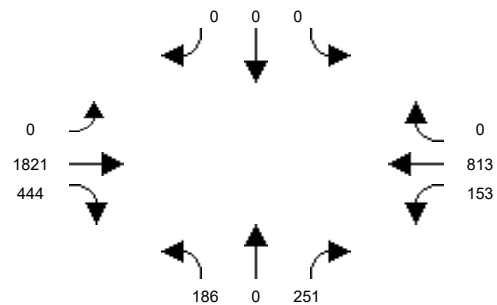

Intersection #27: Greenville St and Segerstrom Ave

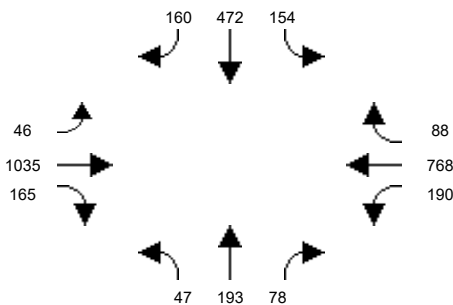

Intersection #28: Raitt St and McFadden Ave

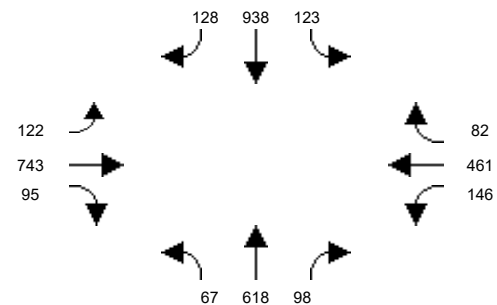

Intersection #29: Raitt St and Edinger Ave

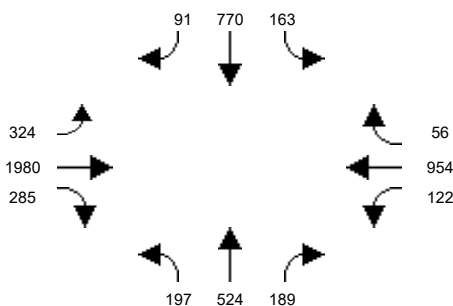

Intersection #30: Bear St and MacArthur Blvd

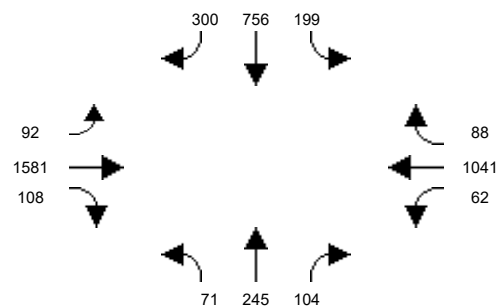

Santa Ana Circulation Element

Intersection Graphic Report
Entered Volume (Base Alternative)
2045 NP AM Peak Hour

Intersection #31: Bristol St and 17th St

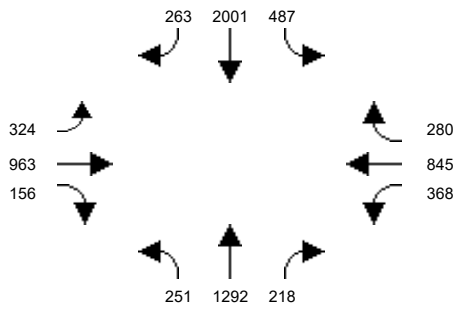

Intersection #32: Bristol St and Civic Center Dr

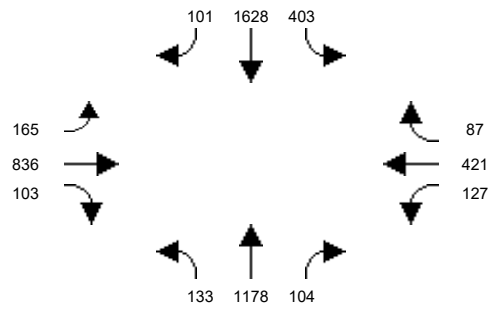

Intersection #33: Bristol St and Santa Ana Blvd

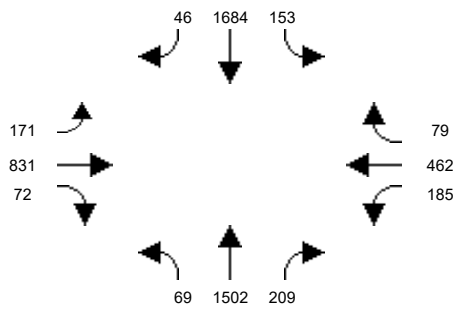

Intersection #34: Bristol St and 1st St

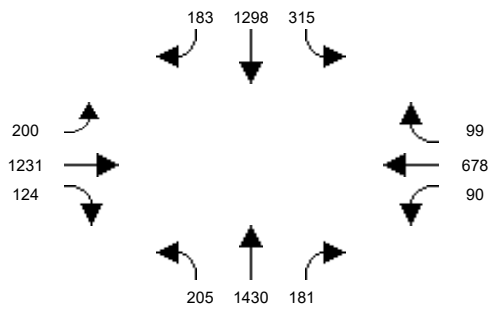

Intersection #35: Bristol St and McFadden Ave

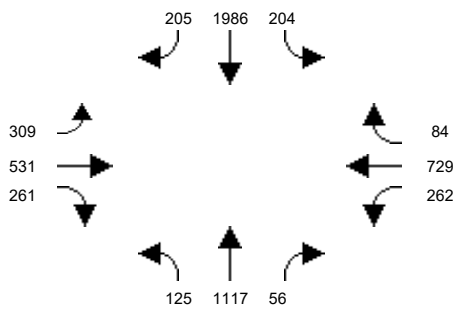

Intersection #36: Bristol St and Warner Ave

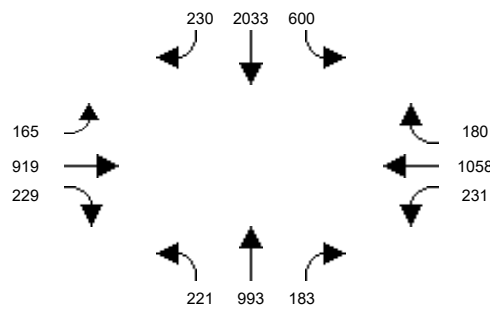

Intersection #37: Bristol St and Segerstrom Ave

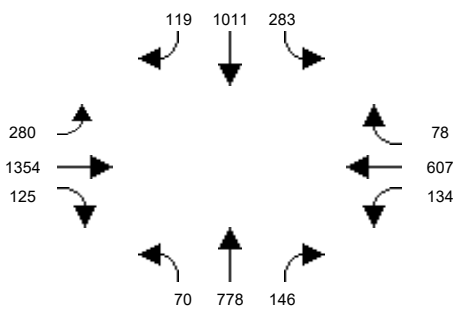

Intersection #38: Bristol St and Alton Ave

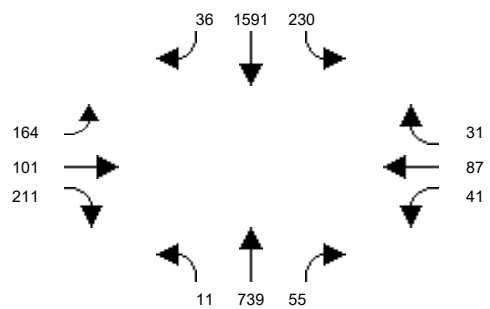

Intersection #39: Bristol St and MacArthur Blvd

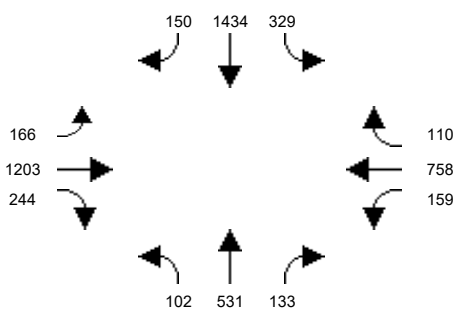

Intersection #40: Bristol St and Sunflower Ave

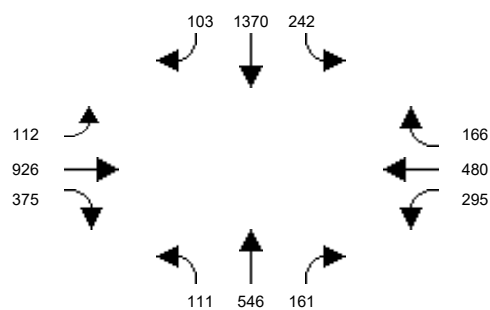

Santa Ana Circulation Element

Intersection Graphic Report
Entered Volume (Base Alternative)
2045 NP AM Peak Hour

Intersection #41: Bristol St and I-405 NB Ramps

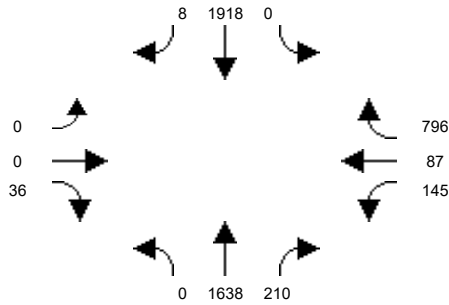

Intersection #42: Bristol St and I-405 SB Ramps

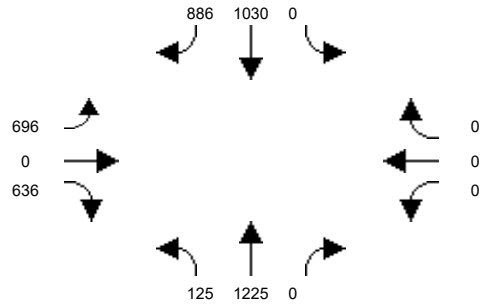

Intersection #43: Flower St and Santa Ana Blvd

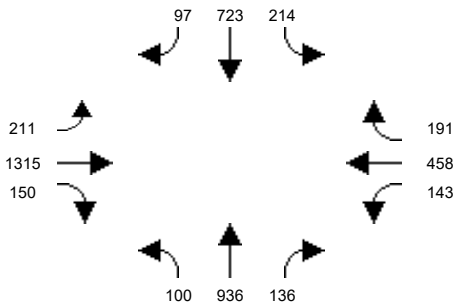

Intersection #44: Flower St and 1st St

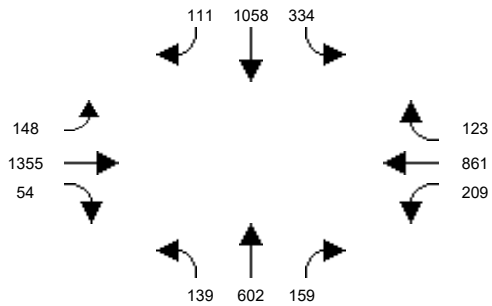

Intersection #45: Flower St and McFadden Ave

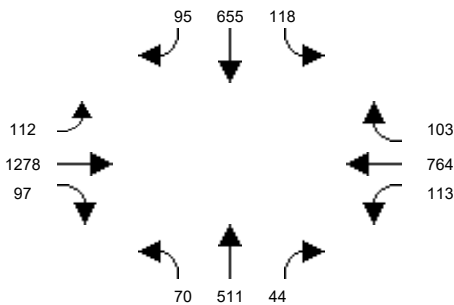

Intersection #46: Flower St and Segerstrom Ave

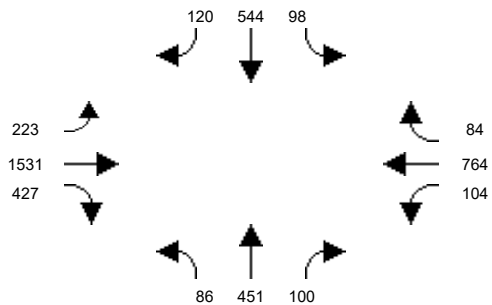

Intersection #47: Flower St and MacArthur Blvd

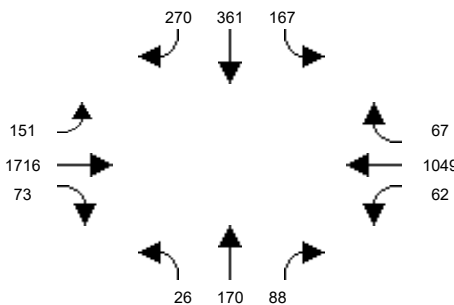

Intersection #48: Main St and La Veta Ave

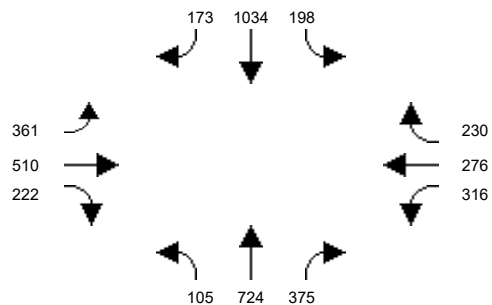

Intersection #49: Main St and Mainplace Dr / Memory Ln

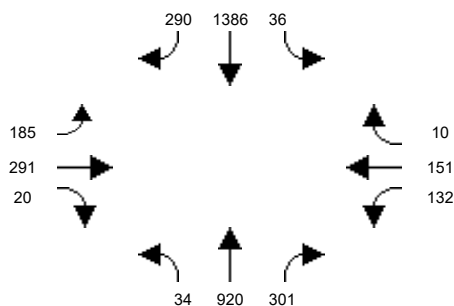

Intersection #50: Main St and 17th St

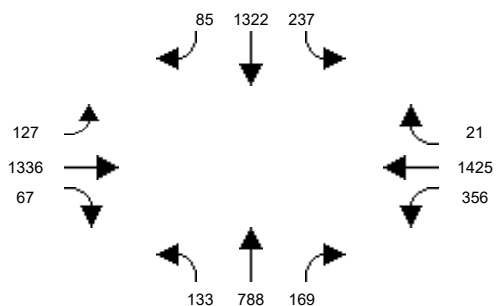

Santa Ana Circulation Element

Intersection Graphic Report
Entered Volume (Base Alternative)
2045 NP AM Peak Hour

Intersection #51: Main St and Civic Center Dr

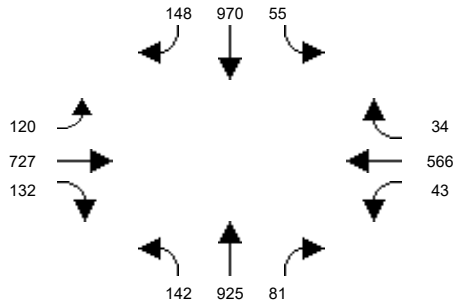

Intersection #52: Main St and Santa Ana Blvd

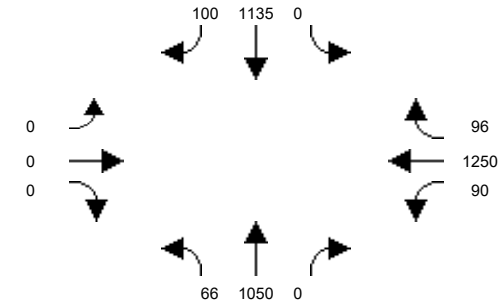

Intersection #53: Main St and 4th St

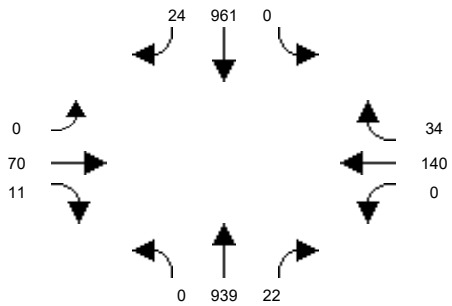

Intersection #54: Main St and 1st St

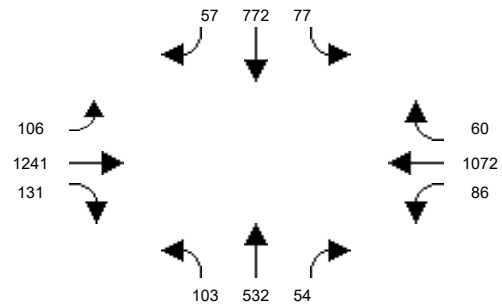

Intersection #55: Main St and McFadden Ave

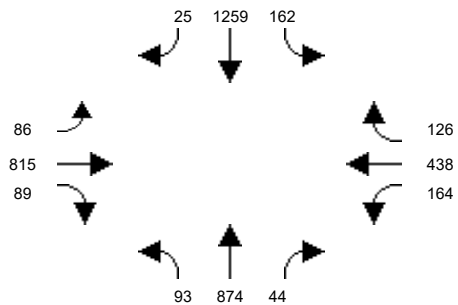

Intersection #56: Main St and Edinger Ave

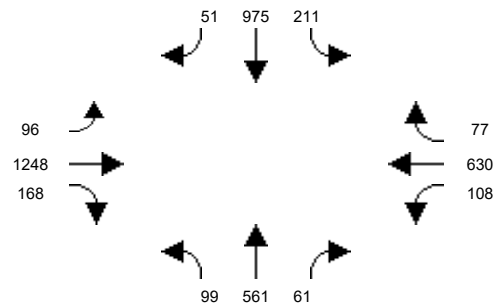

Intersection #57: Main St and MacArthur Blvd

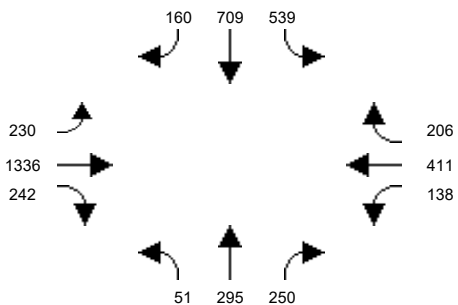

Intersection #58: Penn Wy and 17th St

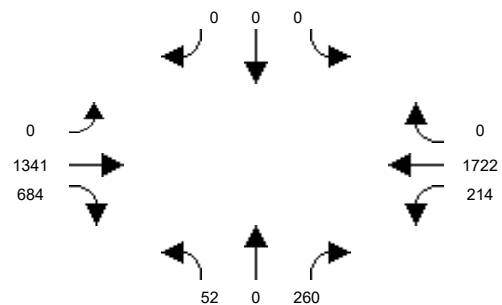

Intersection #59: I-5 NB Off Ramps/17th Street

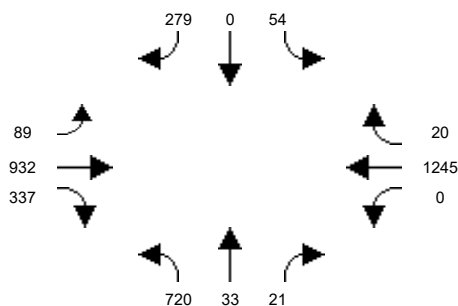

Intersection #60: Penn Wy and I-5 SB Ramps

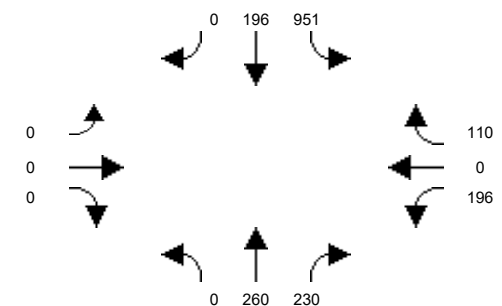

Santa Ana Circulation Element

Intersection Graphic Report
Entered Volume (Base Alternative)
2045 NP AM Peak Hour

Intersection #61: Santiago St and Civic Center Dr

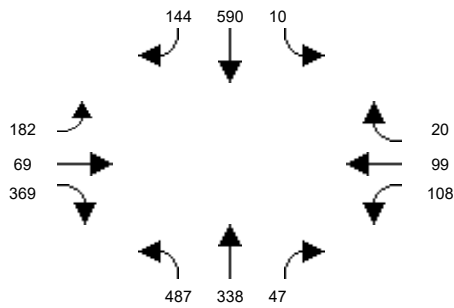

Intersection #62: Santiago St and Santa Ana Blvd

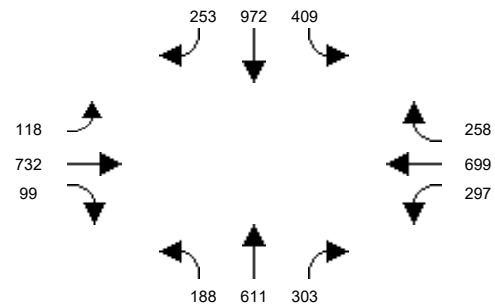

Intersection #63: Standard Ave and 4th St

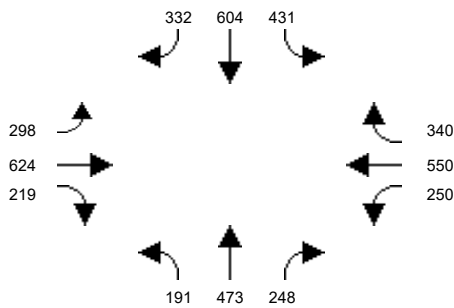

Intersection #64: Standard Ave and 1st St

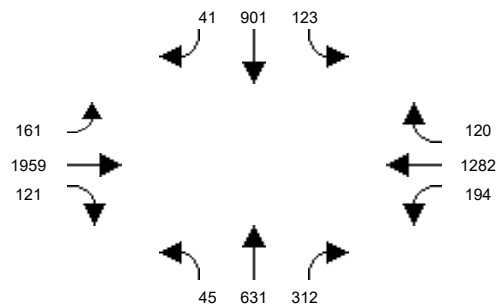

Intersection #65: Standard Ave and Mcfadden Ave

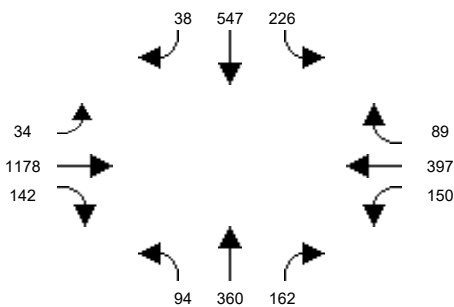

Intersection #66: Halladay St and Warner Ave

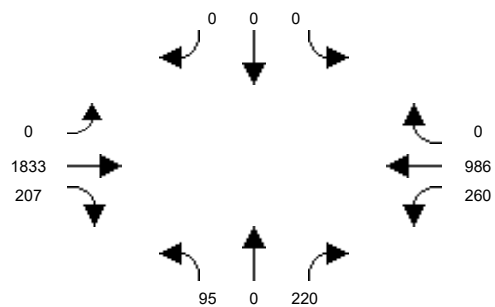

Intersection #67: Halladay St and Dyer Rd

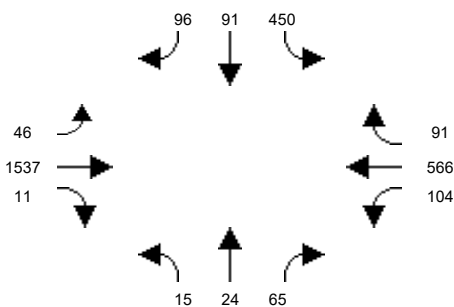

Intersection #68: SR-55 SB Ramps and MacArthur Blvd

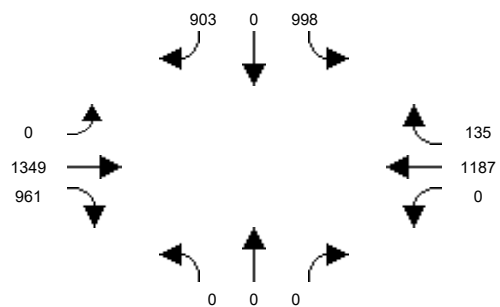

Intersection #69: SR-55 NB Ramps and MacArthur Blvd

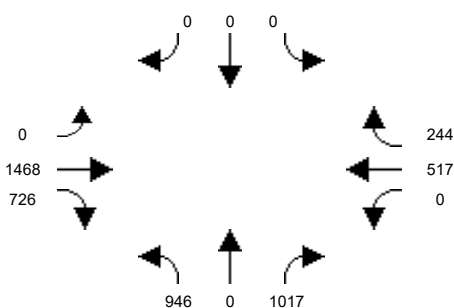

Intersection #70: SR-55 SB Ramps and Dyer Rd

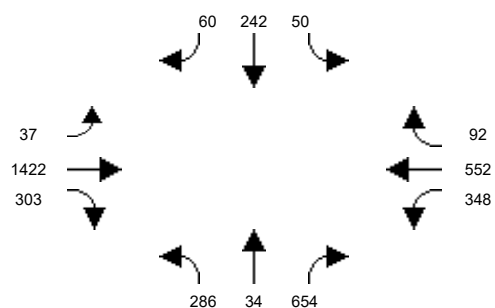

Santa Ana Circulation Element

Intersection Graphic Report
Entered Volume (Base Alternative)
2045 NP AM Peak Hour

Intersection #71: Glassell St and La Veta Ave

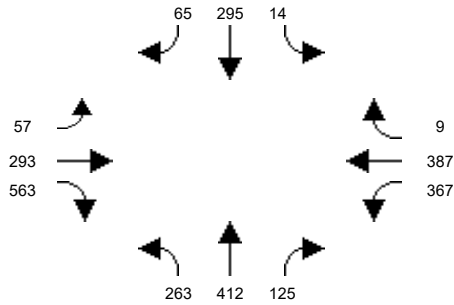

Intersection #72: Glassell St and SR-22 WB Ramps

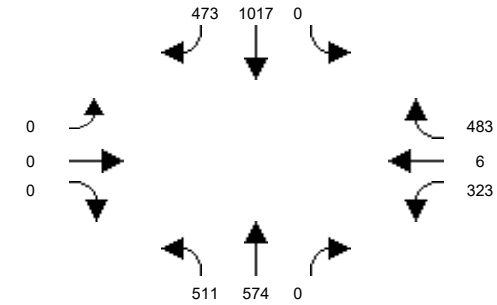

Intersection #73: Grand Ave / Glassell St and SR-22 EB Ramps

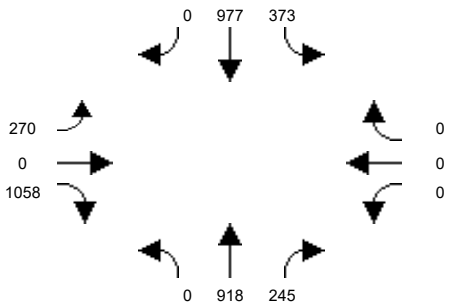

Intersection #74: Grand Ave and Fairhaven Ave

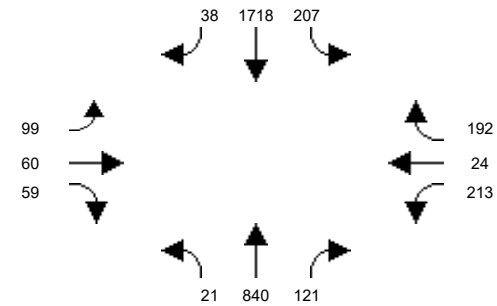

Intersection #75: Grand Ave and Santa Clara Ave

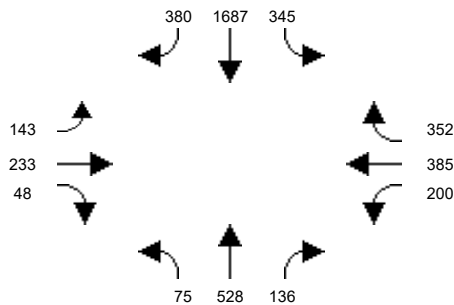

Intersection #76: Grand Ave and 17th St

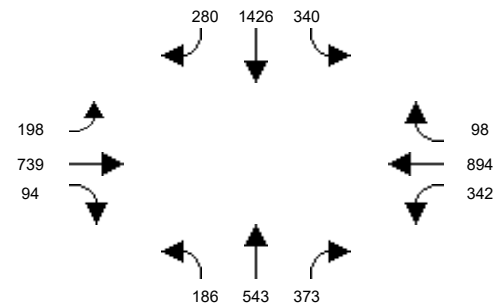

Intersection #77: Grand Ave and I-5 NB Ramps

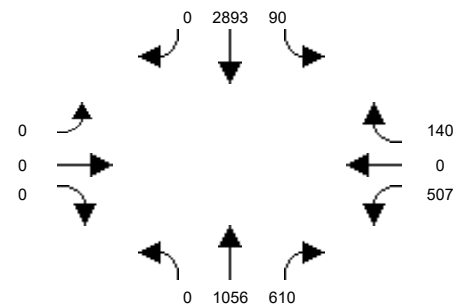

Intersection #78: Grand Ave and Santa Ana Blvd

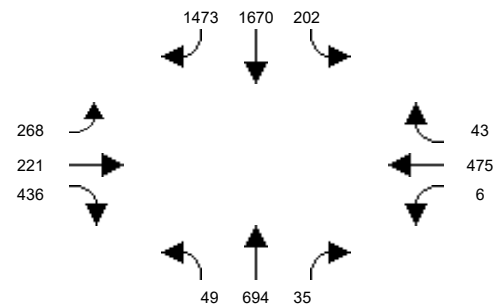

Intersection #79: Grand Ave and 1st St

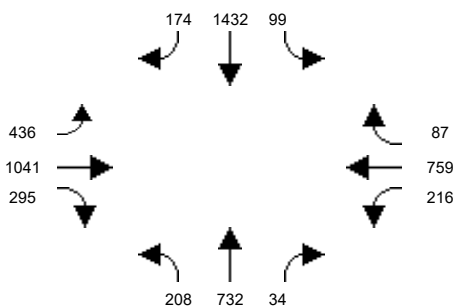

Intersection #80: Grand Ave and Chestnut Ave

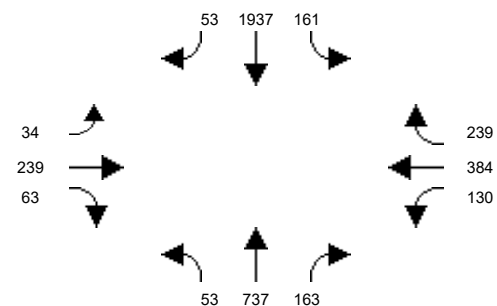

Santa Ana Circulation Element

Intersection Graphic Report
Entered Volume (Base Alternative)
2045 NP AM Peak Hour

Intersection #81: Grand Ave and McFadden Ave

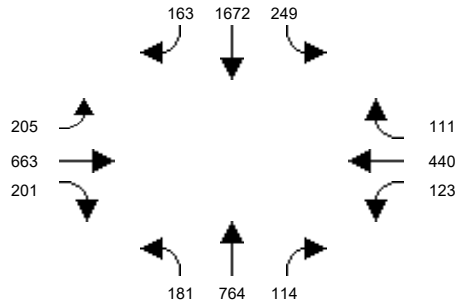

Intersection #82: Grand Ave and Edinger Ave

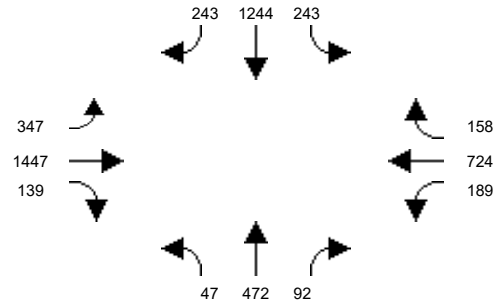

Intersection #83: Grand Ave and Warner Ave

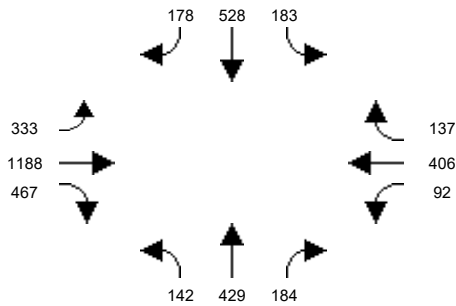

Intersection #84: SR-55 NB Ramps and Dyer Rd

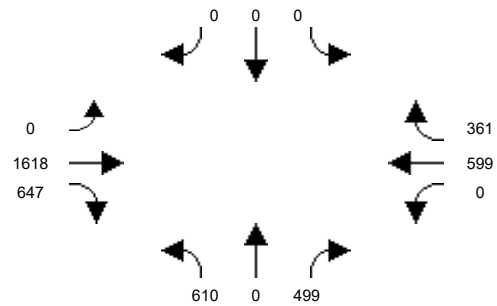

Intersection #85: Cambridge St and La Veta Ave

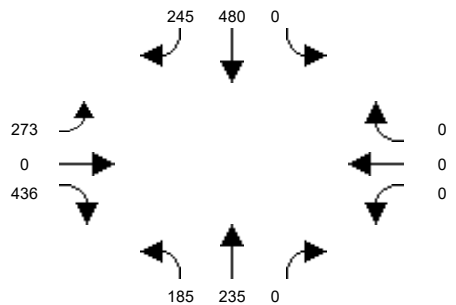

Intersection #86: Cambridge St and Fairhaven Ave

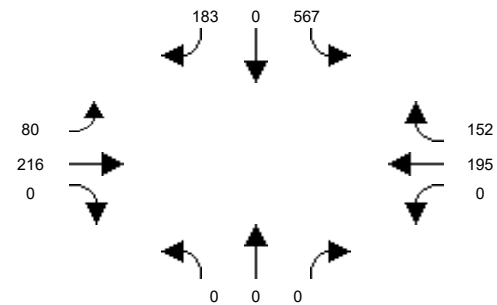

Intersection #87: Mabury St and 1st Street

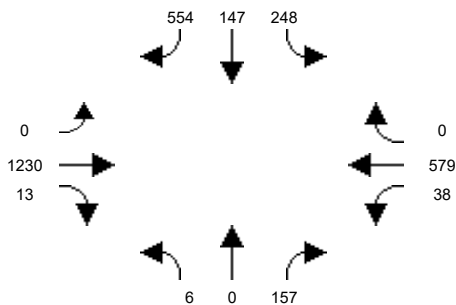

Intersection #88: Tustin St and La Veta Ave

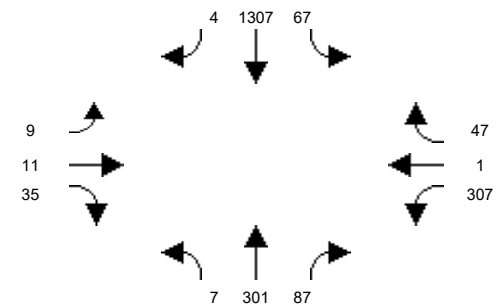

Intersection #89: Tustin St and SR-22 WB On-Ramp

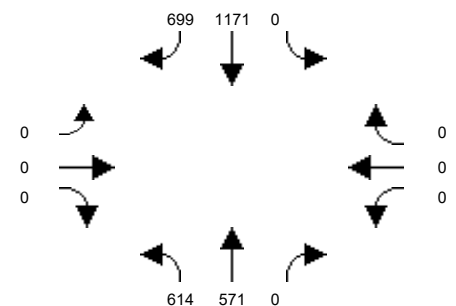

Intersection #90: Tustin St and SR-22 EB Off-Ramp / Seba Ave

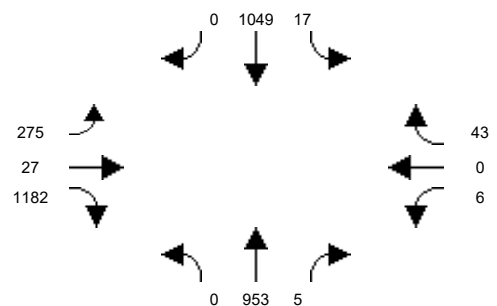

Santa Ana Circulation Element

Intersection Graphic Report
Entered Volume (Base Alternative)
2045 NP AM Peak Hour

Intersection #91: Tustin Ave and Fairhaven Ave

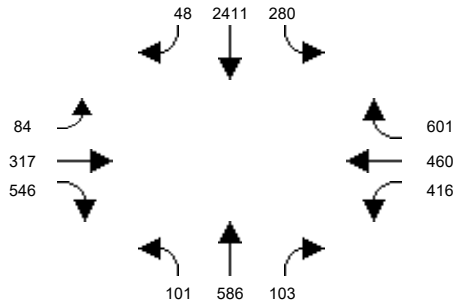

Intersection #92: Tustin Ave and Santa Clara Ave

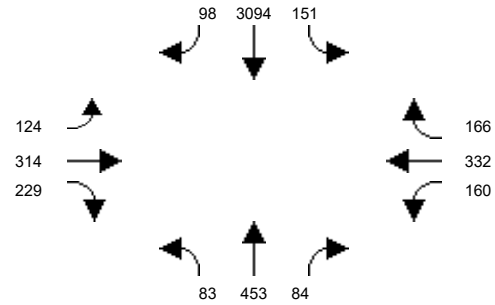

Intersection #93: Tustin Ave and 17th St

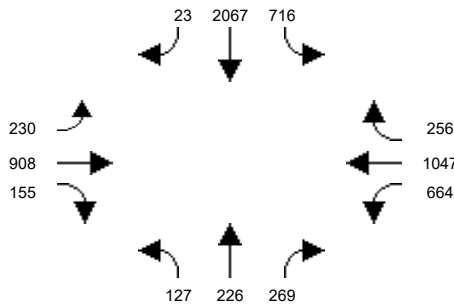

Intersection #94: Tustin Ave and 4th St

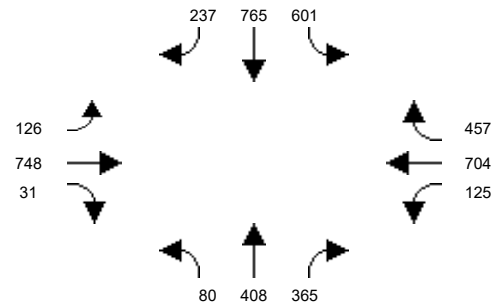

Intersection #95: SR-55 SB Ramps / Auto Mall Dr and Edinger Ave

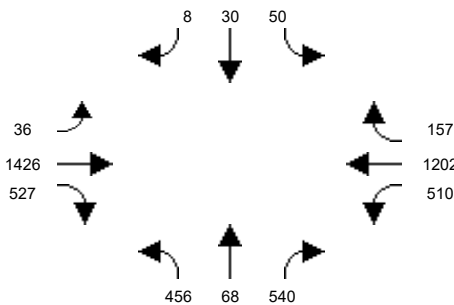

Intersection #96: SR-55 NB Ramps / Del Amo Ave and Newport Avenue

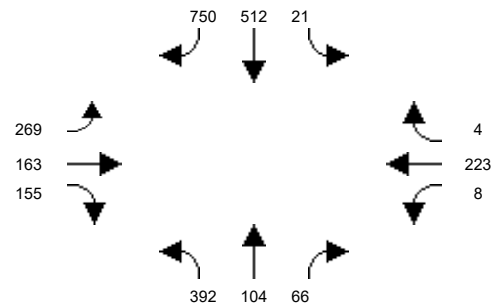

Intersection #97: Red Hill Ave and Edinger Ave

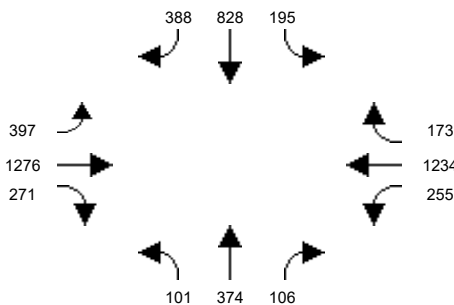

Intersection #98: Red Hill Ave and Warner Ave

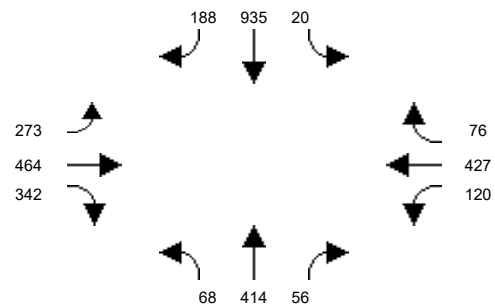

Intersection #99: Red Hill Ave and Dyer Rd / barranca Pkwy

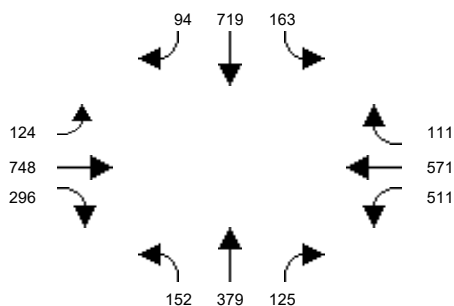

Intersection #100: Red Hill Ave and Alton Pkwy

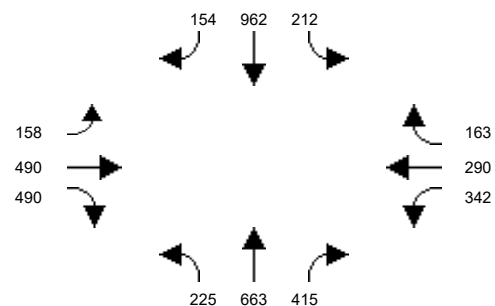

Santa Ana Circulation Element

Intersection Graphic Report
Entered Volume (Base Alternative)
2045 NP AM Peak Hour

Intersection #101: Red Hill Ave and MacArthur Blvd

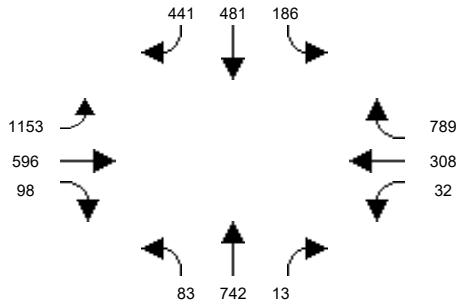

Intersection #102: Red Hill Ave and Main St

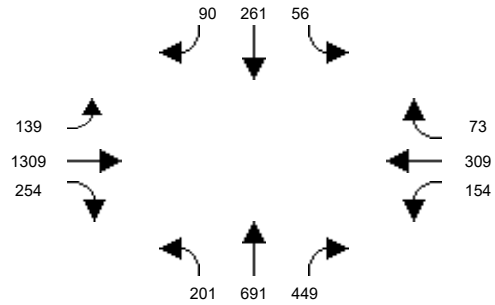

Intersection #103: I-5 SB Ramps and Santa Ana Blvd

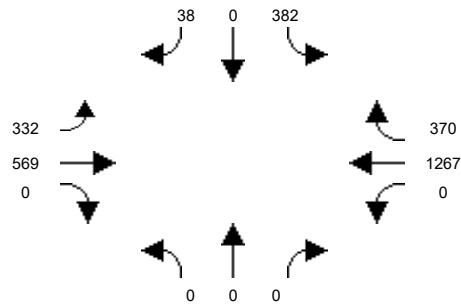

Intersection #104: Tustin Ranch Rd and Warner Ave

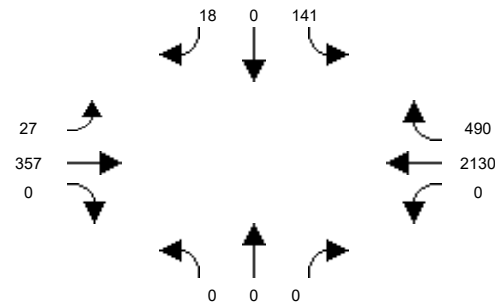

Intersection #105: Von Karman Ave and Barranca Pkwy

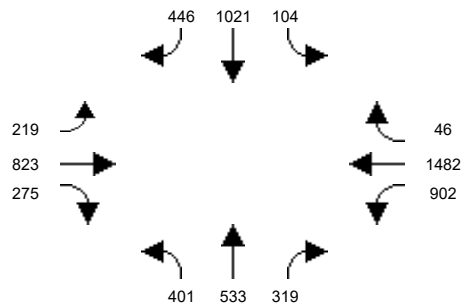

Intersection #106: Red Hill Avenue and El Camino Real

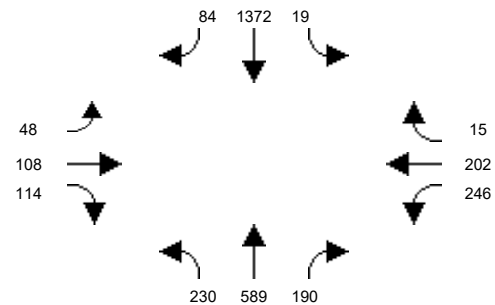

Intersection #107: Red Hill Avenue and I-5 NB Ramps

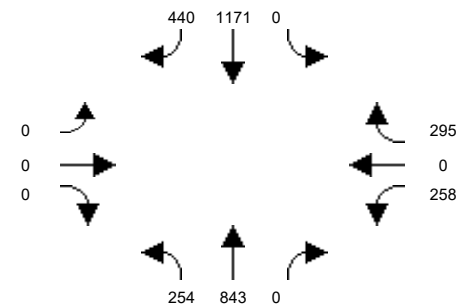

Intersection #108: Red Hill Avenue and I-5 SB Ramps

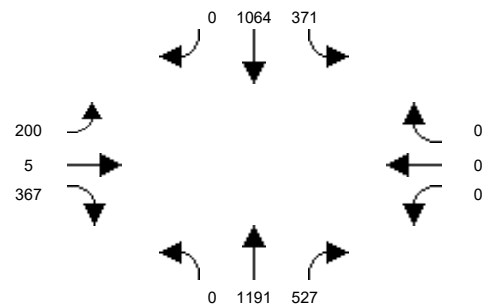

Intersection #109: Red Hill Avenue and Nissan Road

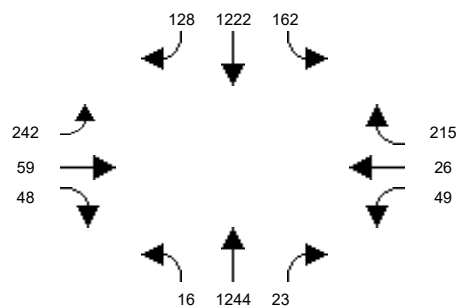

Intersection #110: Red Hill Avenue and Walnut Avenue

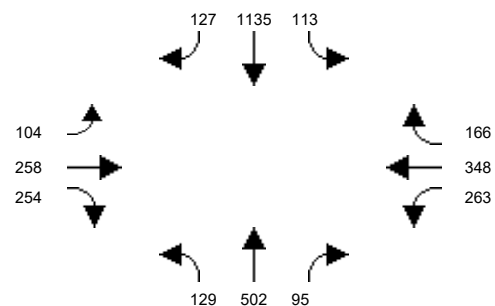

Santa Ana Circulation Element

Intersection Graphic Report
Entered Volume (Base Alternative)
2045 NP AM Peak Hour

Intersection #111: Red Hill Avenue and Valencia Avenue

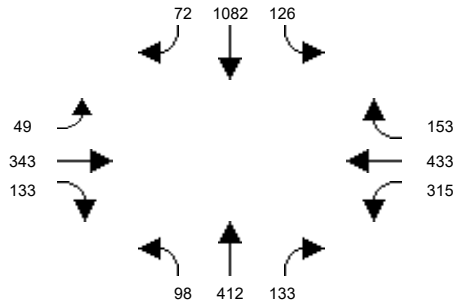

Intersection #112: Tustin Ranch Road and Warner Avenue North

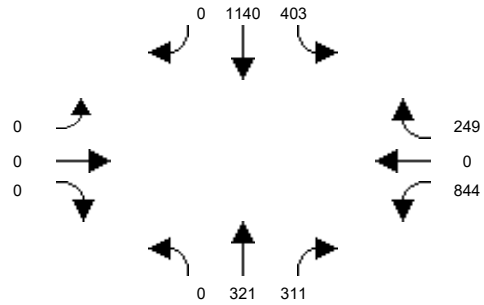

Intersection #113: Tustin Ranch Road and Walnut Avenue

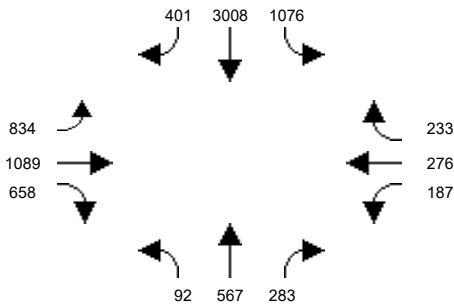

Intersection #114: SR-55 SB Ramps and Irvine Boulevard

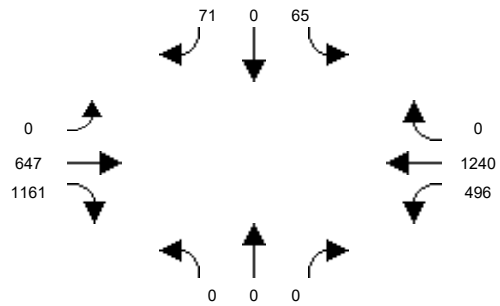

Intersection #115: SR-55 NB Ramps and Irvine Boulevard

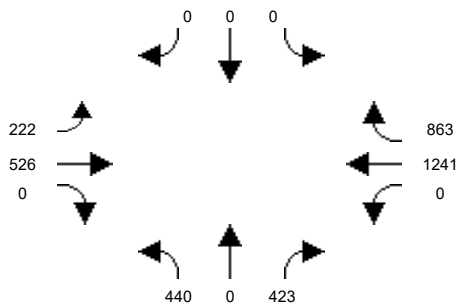

APPENDIX B.4
INTERSECTION VOLUMES –
2045 NP (PM PEAK HOUR)

Santa Ana Circulation Element

Intersection Graphic Report
Entered Volume (Base Alternative)
2045 NP PM Peak Hour

Intersection #1: Euclid St and 1st St

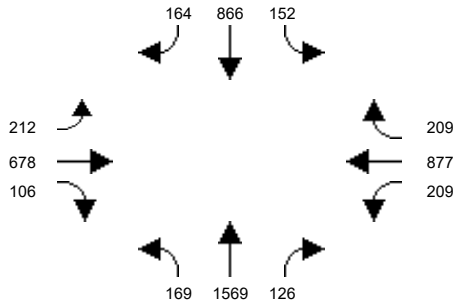

Intersection #2: Euclid St and McFadden Ave

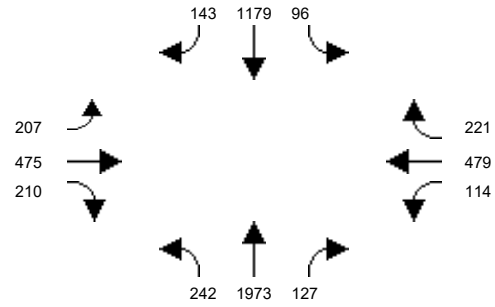

Intersection #3: Euclid St and Edinger Ave

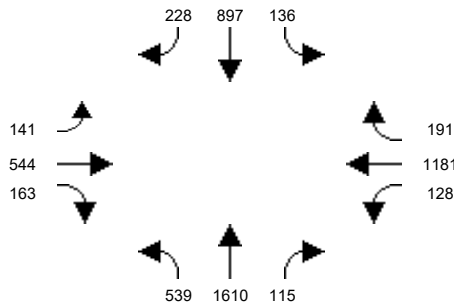

Intersection #4: Newhope St and Hazard Ave

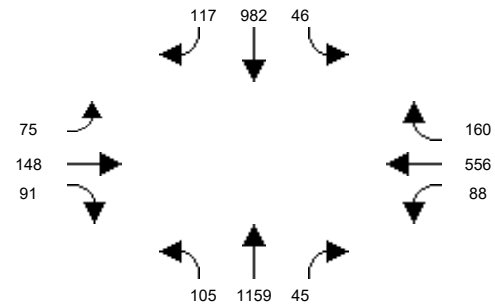

Intersection #5: Newhope St and McFadden Ave

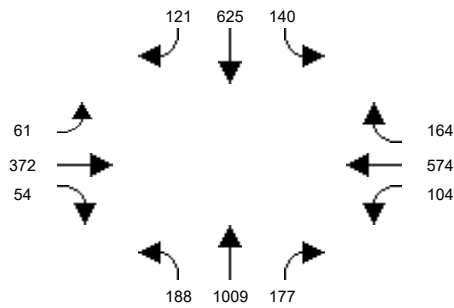

Intersection #6: Harbor Blvd and SR-22 WB Off-Ramp / Banner Dr

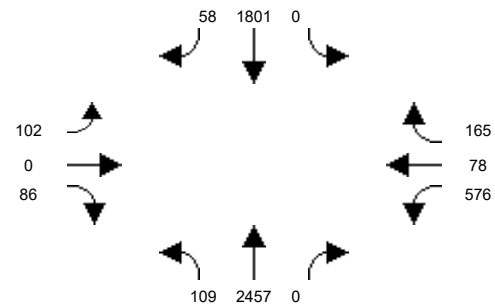

Intersection #7: Trask Avenue and SR-22 EB On-Ramp

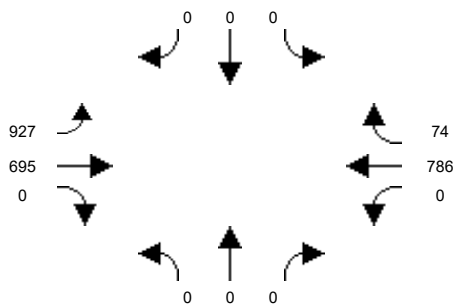

Intersection #8: Harbor Blvd and Westminster Ave

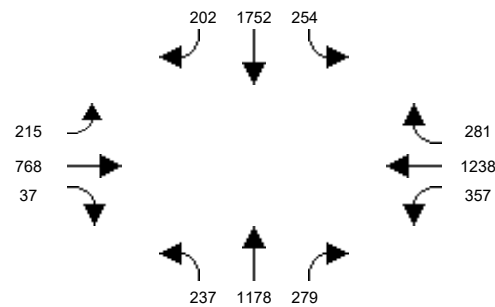

Intersection #9: Harbor Blvd and 1st St

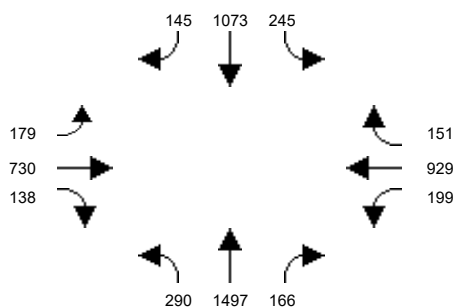

Intersection #10: Harbor Blvd and McFadden Ave

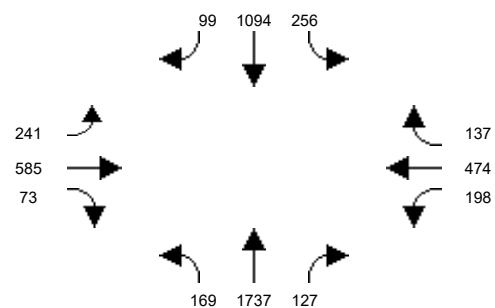

Santa Ana Circulation Element

Intersection Graphic Report
Entered Volume (Base Alternative)
2045 NP PM Peak Hour

Intersection #11: Harbor Blvd and Edinger Ave

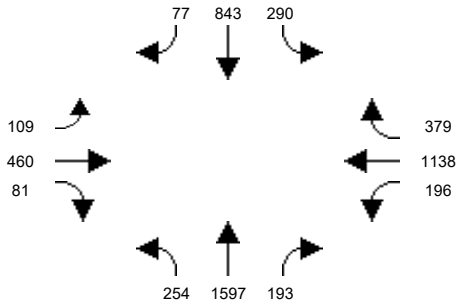

Intersection #12: Harbor Blvd and Warner Ave

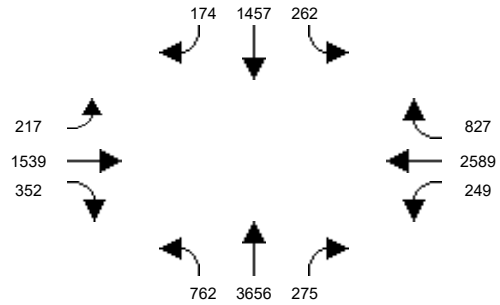

Intersection #13: Harbor Blvd and Segerstrom Ave

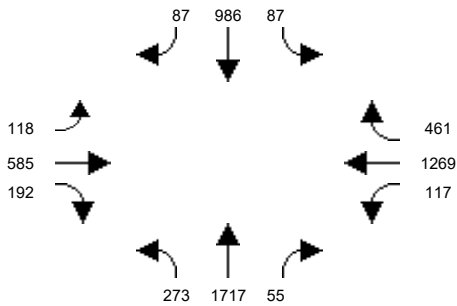

Intersection #14: MacArthur Blvd and Hyland Ave

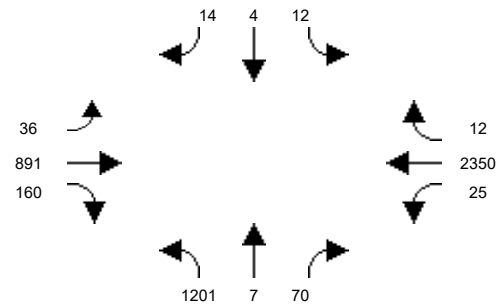

Intersection #15: MacArthur Blvd and Harbor Blvd

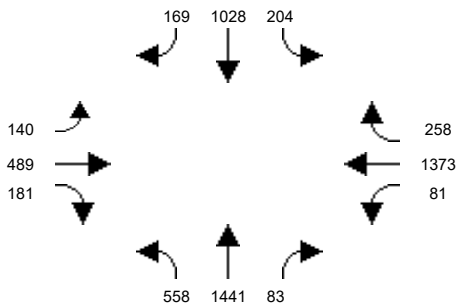

Intersection #16: Harbor Blvd and Sunflower Ave

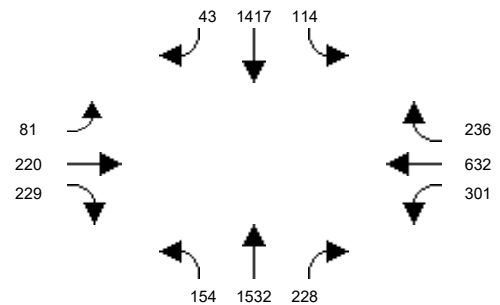

Intersection #17: Harbor Blvd and I-405 NB Off-Ramp

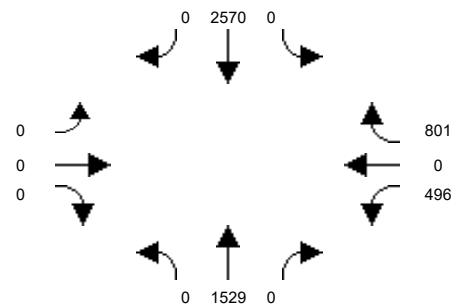

Intersection #18: Harbor Blvd and I-405 SB Off-Ramp

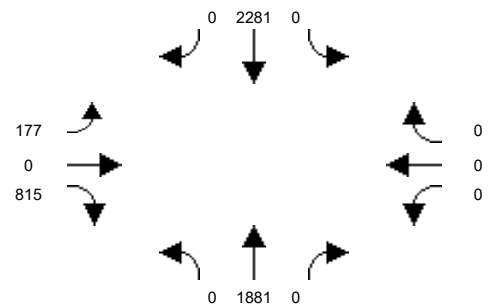

Intersection #19: Fairview St and Civic Center Dr

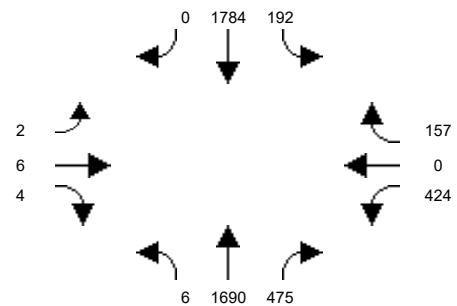

Intersection #20: Fairview St and 1st St

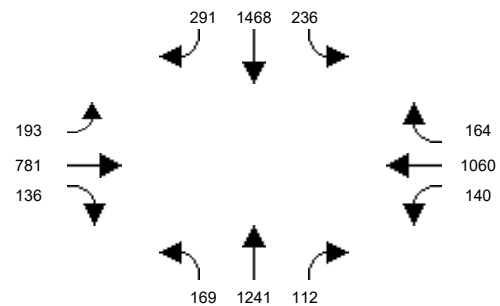

Santa Ana Circulation Element

Intersection Graphic Report
Entered Volume (Base Alternative)
2045 NP PM Peak Hour

Intersection #21: Fairview St and McFadden Ave

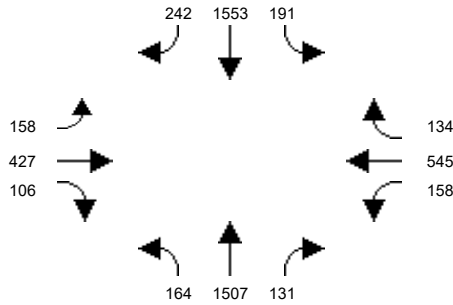

Intersection #22: Fairview St and Edinger Ave

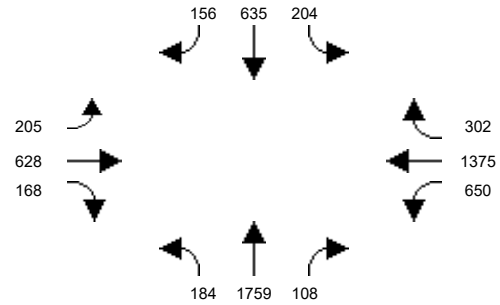

Intersection #23: Fairview St and Warner Ave

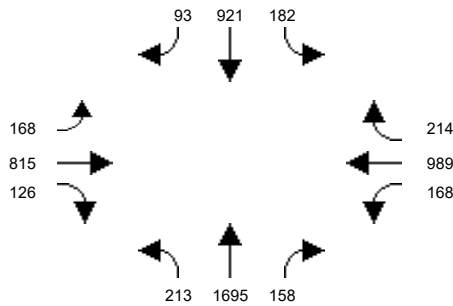

Intersection #24: Fairview St and MacArthur Blvd

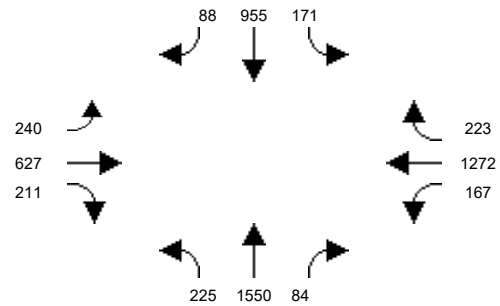

Intersection #25: Fairview Rd and Sunflower Ave

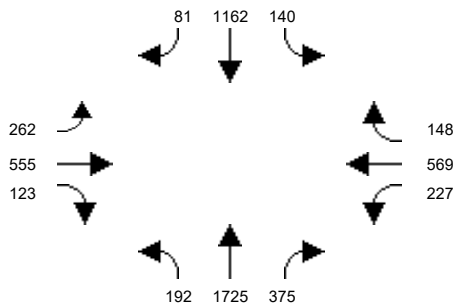

Intersection #26: Greenville St and Edinger Ave

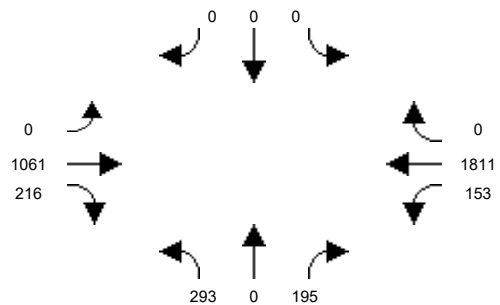

Intersection #27: Greenville St and Segerstrom Ave

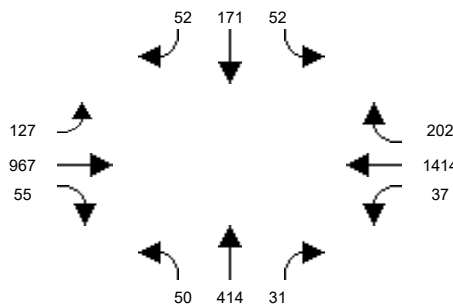

Intersection #28: Raitt St and McFadden Ave

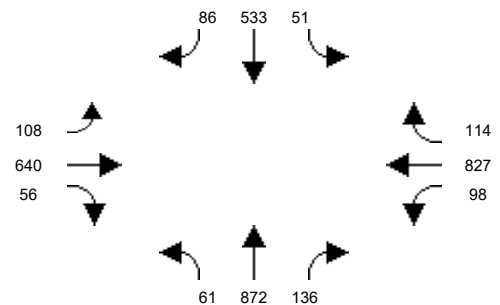

Intersection #29: Raitt St and Edinger Ave

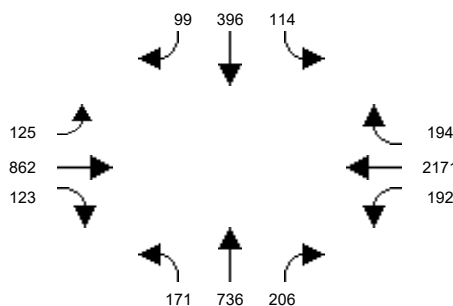

Intersection #30: Bear St and MacArthur Blvd

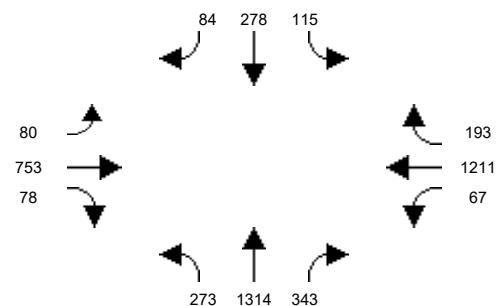

Santa Ana Circulation Element

Intersection Graphic Report
Entered Volume (Base Alternative)
2045 NP PM Peak Hour

Intersection #31: Bristol St and 17th St

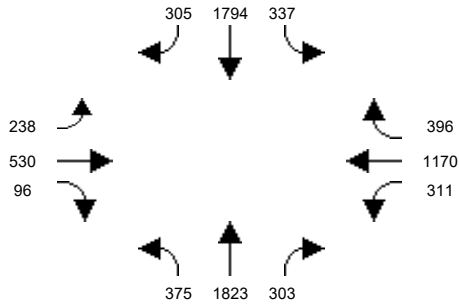

Intersection #32: Bristol St and Civic Center Dr

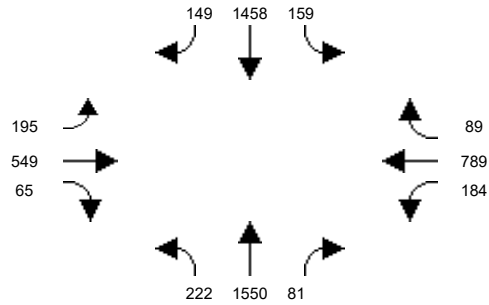

Intersection #33: Bristol St and Santa Ana Blvd

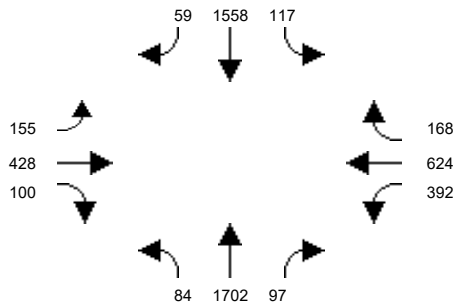

Intersection #34: Bristol St and 1st St

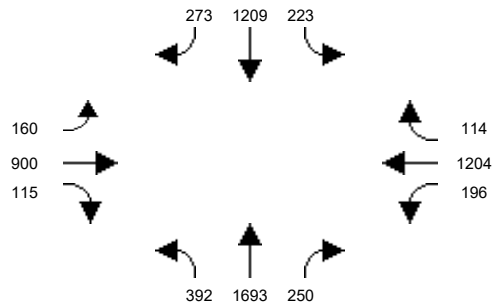

Intersection #35: Bristol St and McFadden Ave

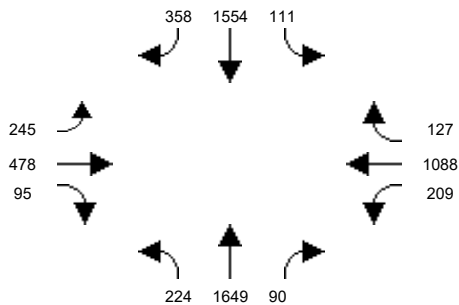

Intersection #36: Bristol St and Warner Ave

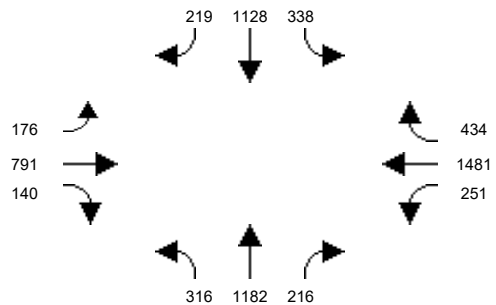

Intersection #37: Bristol St and Segerstrom Ave

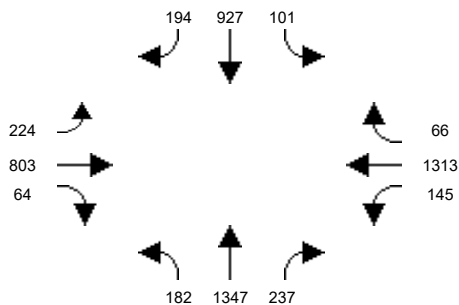

Intersection #38: Bristol St and Alton Ave

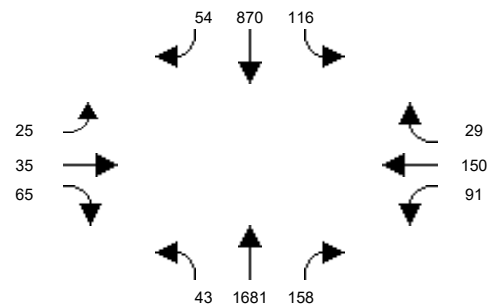

Intersection #39: Bristol St and MacArthur Blvd

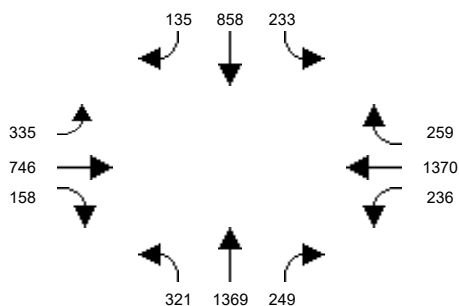

Intersection #40: Bristol St and Sunflower Ave

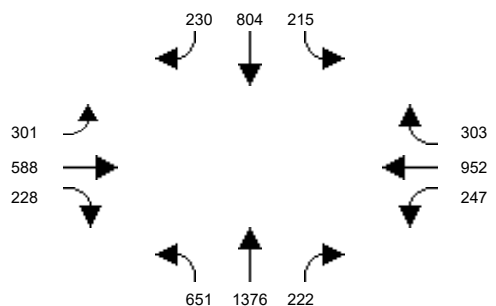

Santa Ana Circulation Element

Intersection Graphic Report
Entered Volume (Base Alternative)
2045 NP PM Peak Hour

Intersection #41: Bristol St and I-405 NB Ramps

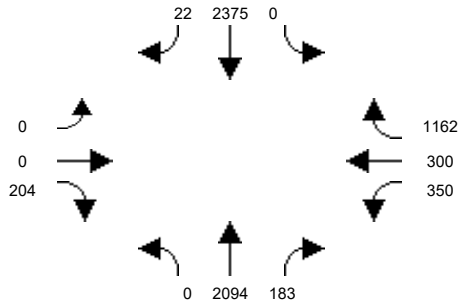

Intersection #42: Bristol St and I-405 SB Ramps

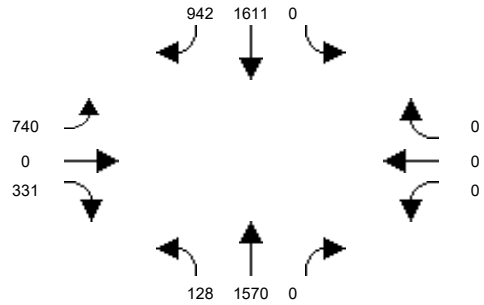

Intersection #43: Flower St and Santa Ana Blvd

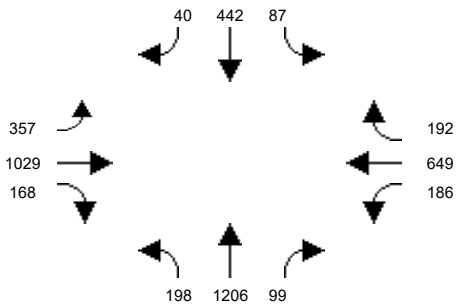

Intersection #44: Flower St and 1st St

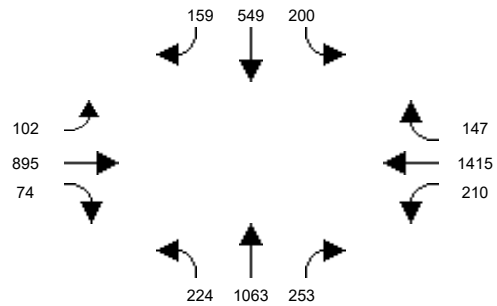

Intersection #45: Flower St and McFadden Ave

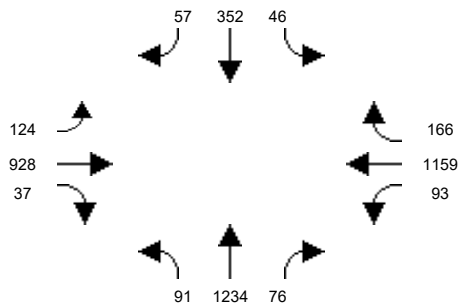

Intersection #46: Flower St and Segerstrom Ave

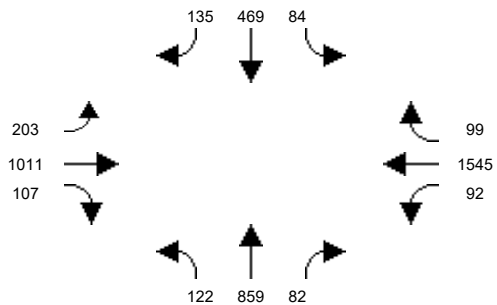

Intersection #47: Flower St and MacArthur Blvd

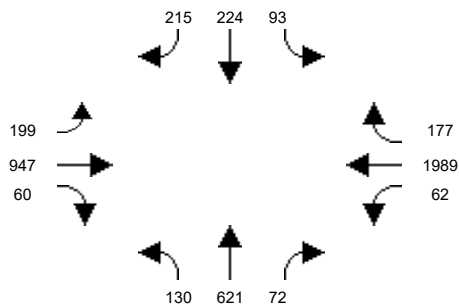

Intersection #48: Main St and La Veta Ave

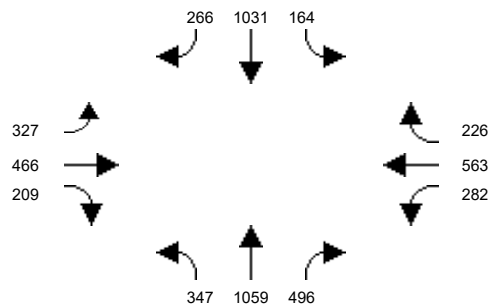

Intersection #49: Main St and Mainplace Dr / Memory Ln

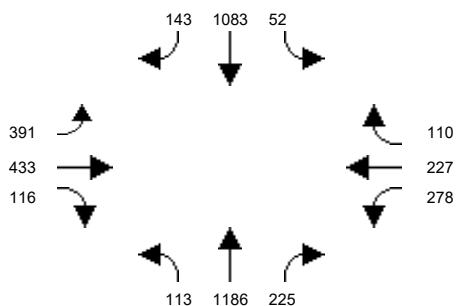

Intersection #50: Main St and 17th St

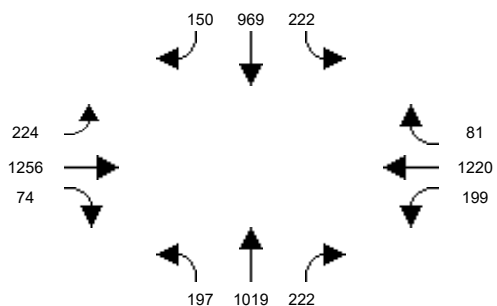

Santa Ana Circulation Element

Intersection Graphic Report
Entered Volume (Base Alternative)
2045 NP PM Peak Hour

Intersection #51: Main St and Civic Center Dr

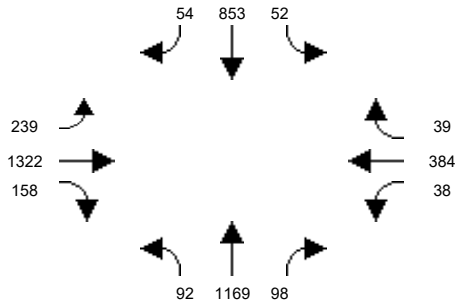

Intersection #52: Main St and Santa Ana Blvd

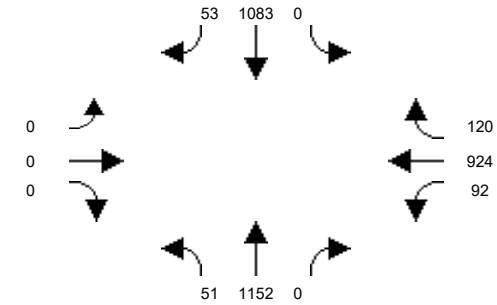

Intersection #53: Main St and 4th St

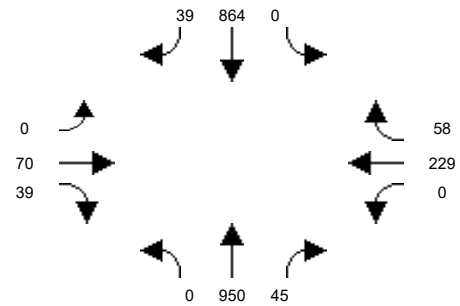

Intersection #54: Main St and 1st St

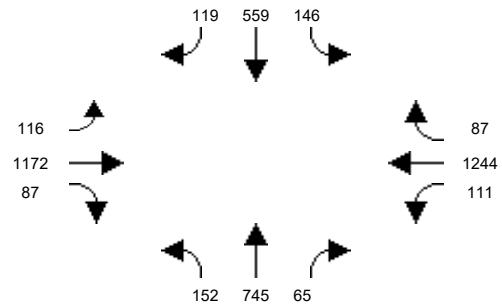

Intersection #55: Main St and McFadden Ave

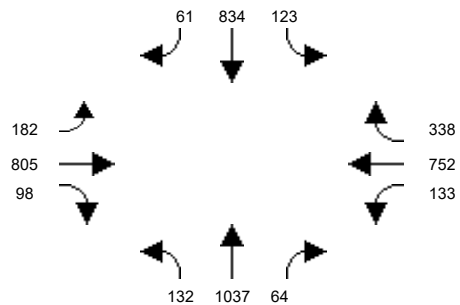

Intersection #56: Main St and Edinger Ave

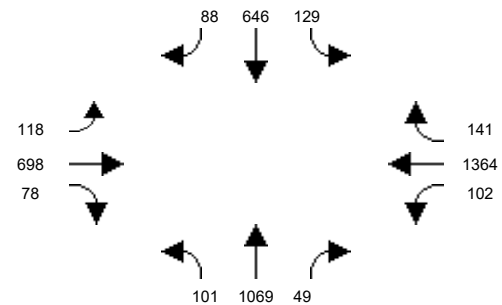

Intersection #57: Main St and MacArthur Blvd

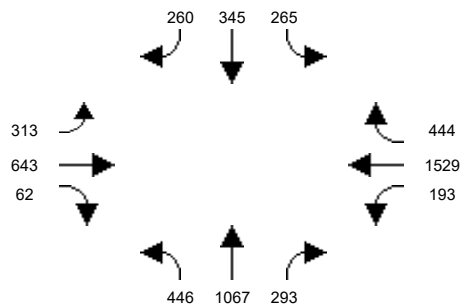

Intersection #58: Penn Wy and 17th St

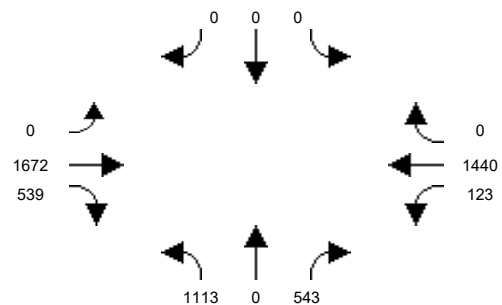

Intersection #59: I-5 NB Off Ramps/17th Street

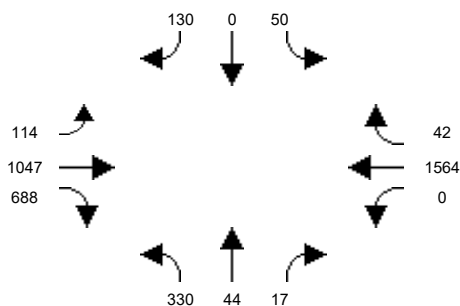

Intersection #60: Penn Wy and I-5 SB Ramps

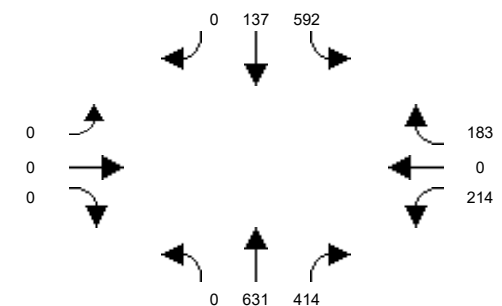

Santa Ana Circulation Element

Intersection Graphic Report
Entered Volume (Base Alternative)
2045 NP PM Peak Hour

Intersection #61: Santiago St and Civic Center Dr

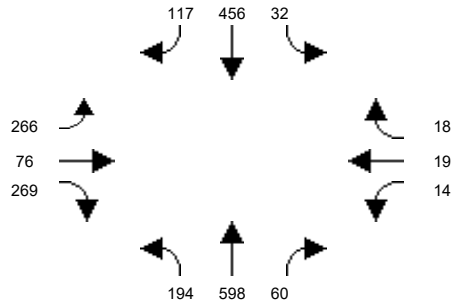

Intersection #62: Santiago St and Santa Ana Blvd

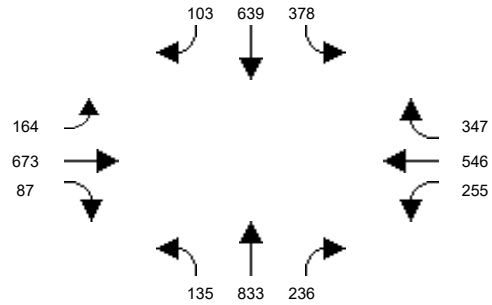

Intersection #63: Standard Ave and 4th St

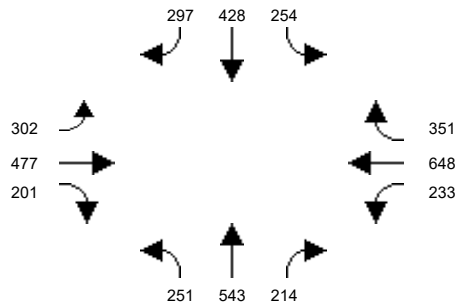

Intersection #64: Standard Ave and 1st St

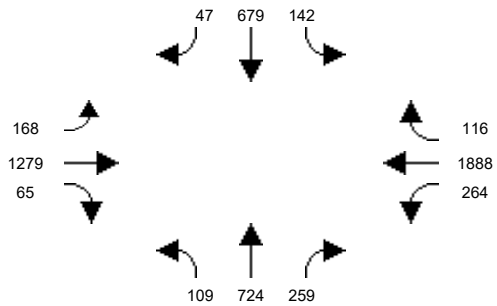

Intersection #65: Standard Ave and Mcfadden Ave

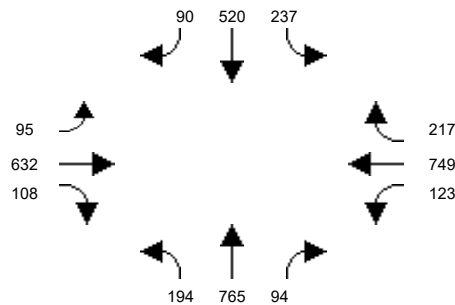

Intersection #66: Halladay St and Warner Ave

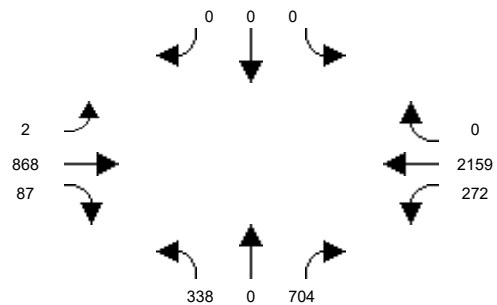

Intersection #67: Halladay St and Dyer Rd

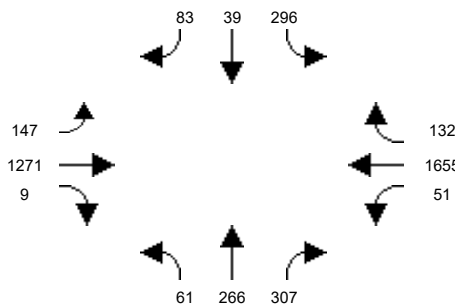

Intersection #68: SR-55 SB Ramps and MacArthur Blvd

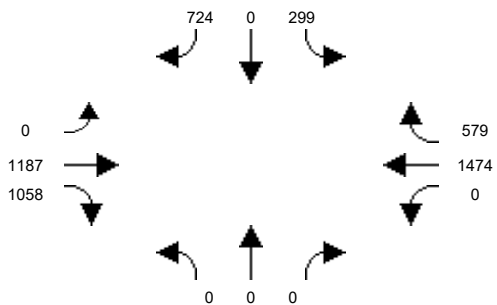

Intersection #69: SR-55 NB Ramps and MacArthur Blvd

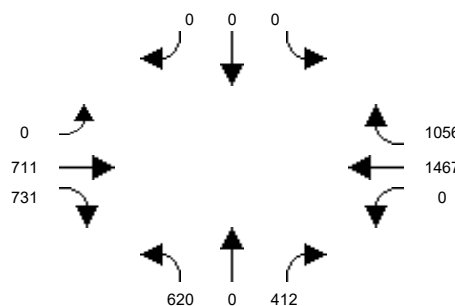

Intersection #70: SR-55 SB Ramps and Dyer Rd

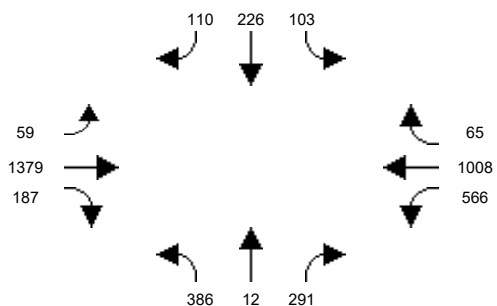

Santa Ana Circulation Element

Intersection Graphic Report
Entered Volume (Base Alternative)
2045 NP PM Peak Hour

Intersection #71: Glassell St and La Veta Ave

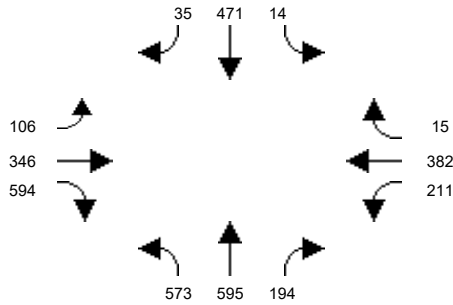

Intersection #72: Glassell St and SR-22 WB Ramps

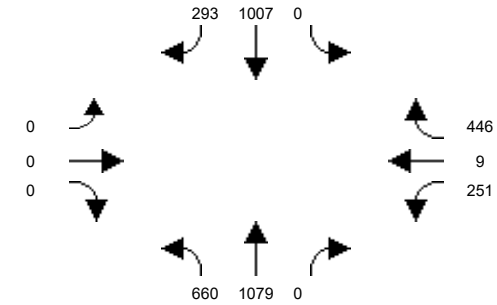

Intersection #73: Grand Ave / Glassell St and SR-22 EB Ramps

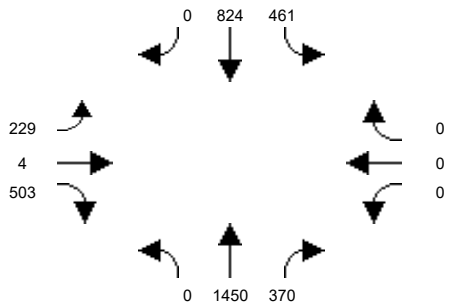

Intersection #74: Grand Ave and Fairhaven Ave

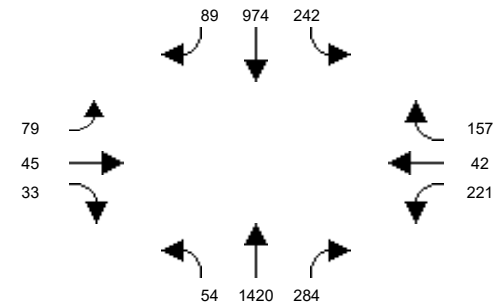

Intersection #75: Grand Ave and Santa Clara Ave

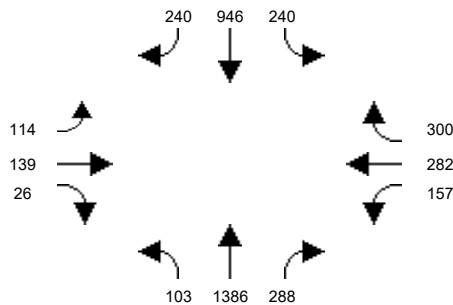

Intersection #76: Grand Ave and 17th St

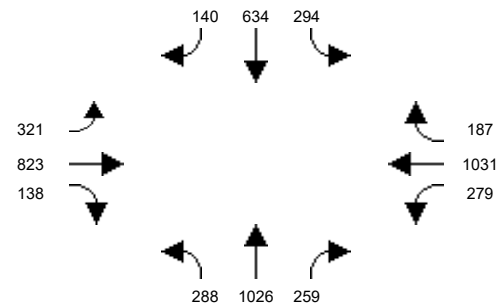

Intersection #77: Grand Ave and I-5 NB Ramps

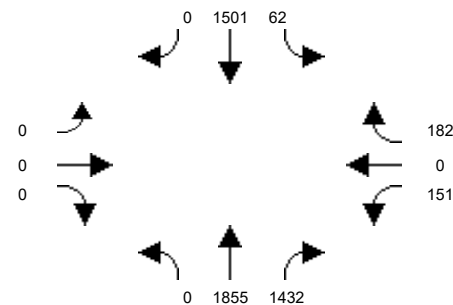

Intersection #78: Grand Ave and Santa Ana Blvd

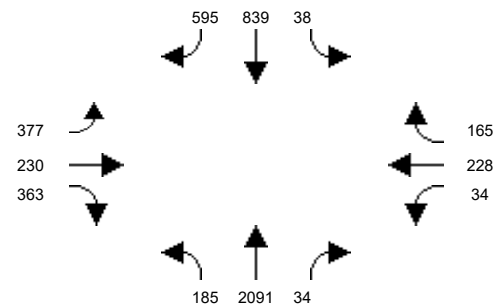

Intersection #79: Grand Ave and 1st St

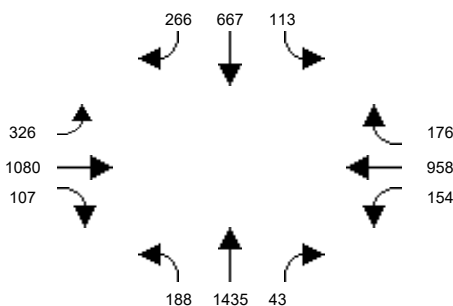

Intersection #80: Grand Ave and Chestnut Ave

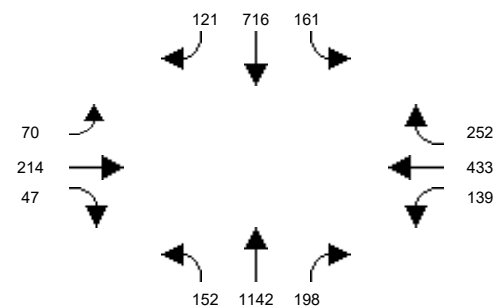

Santa Ana Circulation Element

Intersection Graphic Report
Entered Volume (Base Alternative)
2045 NP PM Peak Hour

Intersection #81: Grand Ave and McFadden Ave

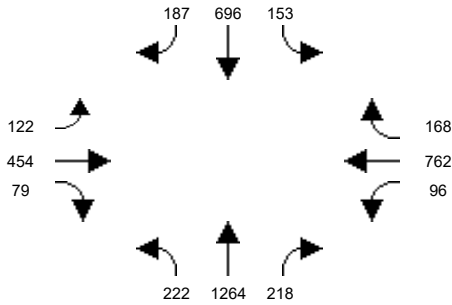

Intersection #82: Grand Ave and Edinger Ave

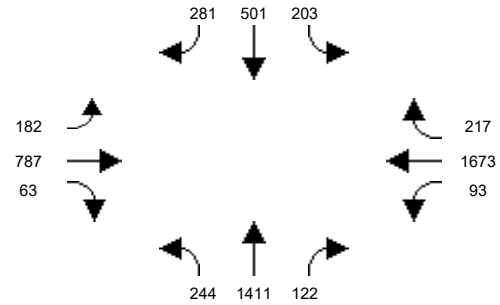

Intersection #83: Grand Ave and Warner Ave

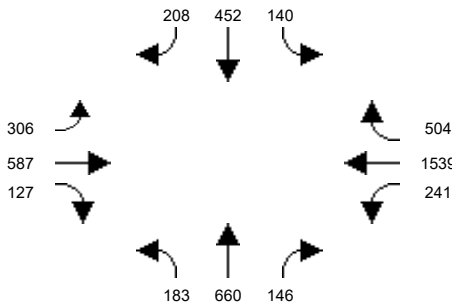

Intersection #84: SR-55 NB Ramps and Dyer Rd

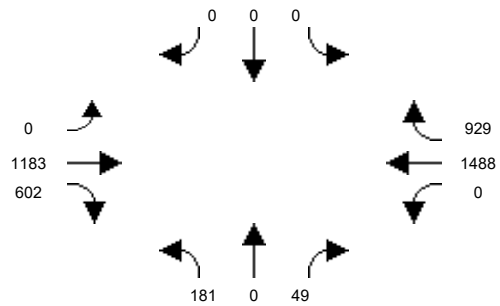

Intersection #85: Cambridge St and La Veta Ave

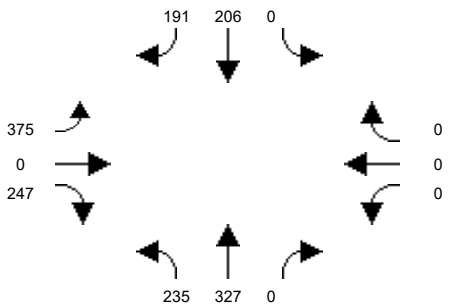

Intersection #86: Cambridge St and Fairhaven Ave

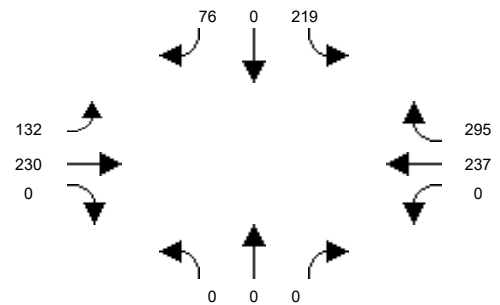

Intersection #87: Mabury St and 1st Street

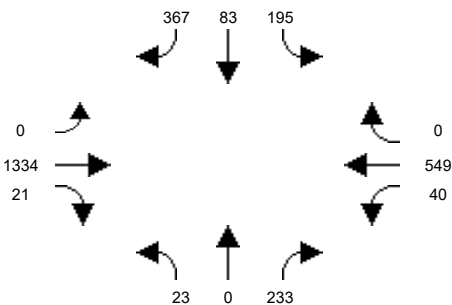

Intersection #88: Tustin St and La Veta Ave

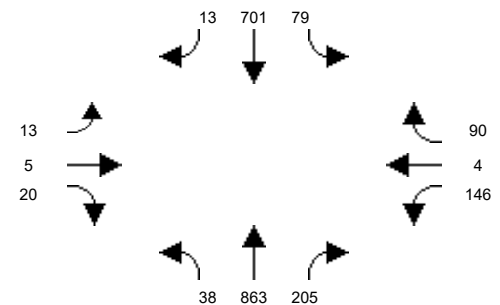

Intersection #89: Tustin St and SR-22 WB On-Ramp

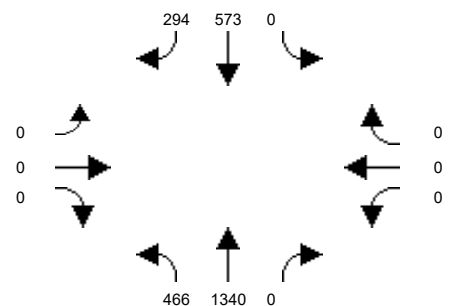

Intersection #90: Tustin St and SR-22 EB Off-Ramp / Seba Ave

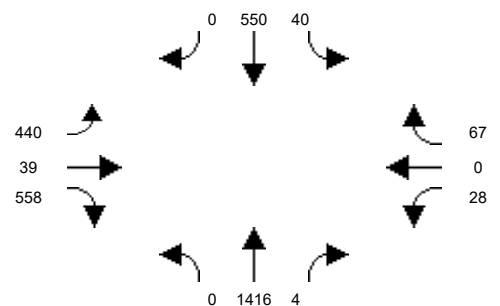

Santa Ana Circulation Element

Intersection Graphic Report
Entered Volume (Base Alternative)
2045 NP PM Peak Hour

Intersection #91: Tustin Ave and Fairhaven Ave

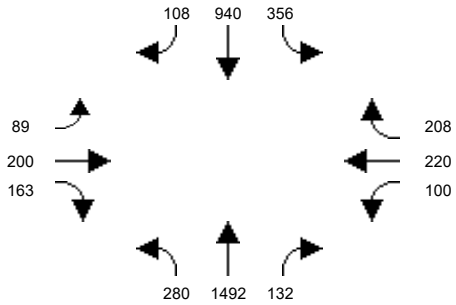

Intersection #92: Tustin Ave and Santa Clara Ave

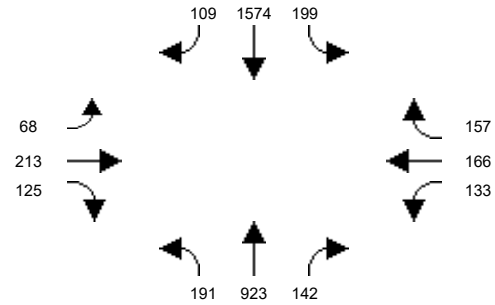

Intersection #93: Tustin Ave and 17th St

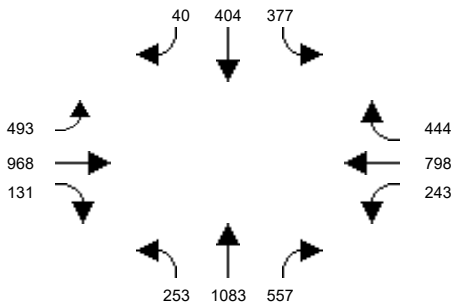

Intersection #94: Tustin Ave and 4th St

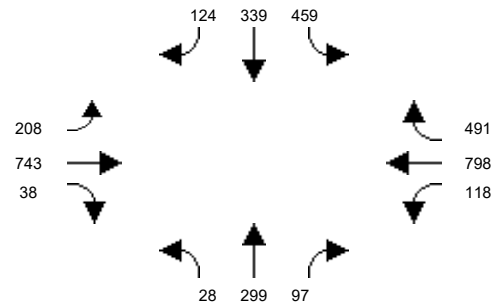

Intersection #95: SR-55 SB Ramps / Auto Mall Dr and Edinger Ave

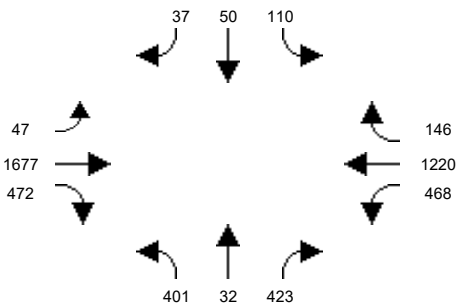

Intersection #96: SR-55 NB Ramps / Del Amo Ave and Newport Avenue

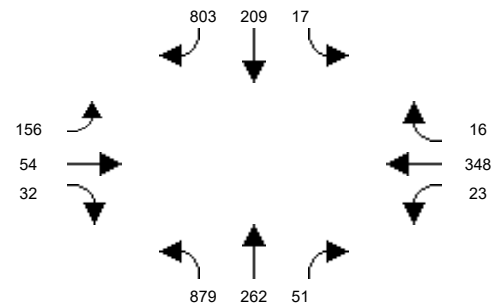

Intersection #97: Red Hill Ave and Edinger Ave

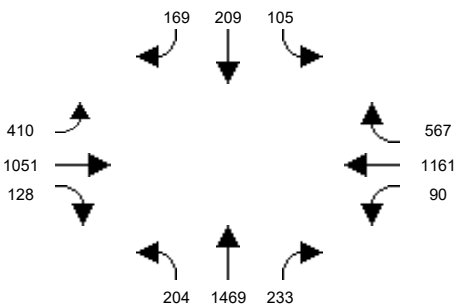

Intersection #98: Red Hill Ave and Warner Ave

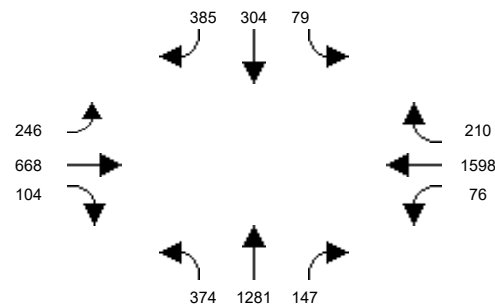

Intersection #99: Red Hill Ave and Dyer Rd / barranca Pkwy

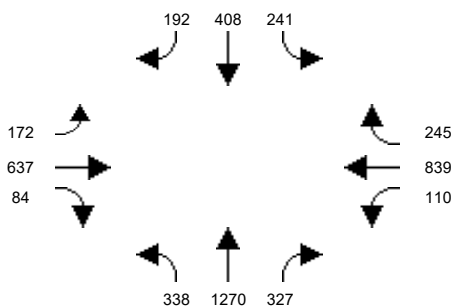

Intersection #100: Red Hill Ave and Alton Pkwy

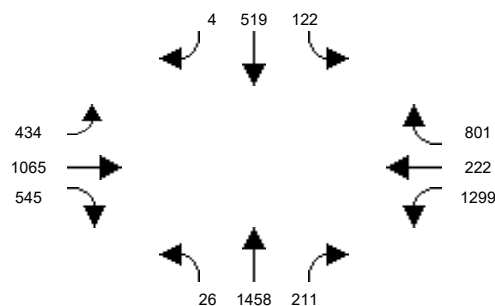

Santa Ana Circulation Element

Intersection Graphic Report
Entered Volume (Base Alternative)
2045 NP PM Peak Hour

Intersection #101: Red Hill Ave and MacArthur Blvd

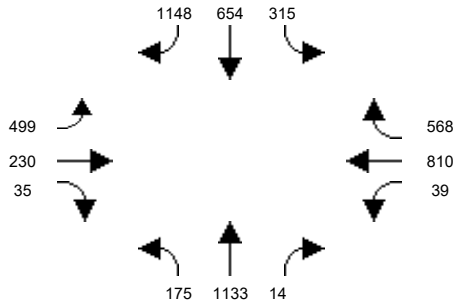

Intersection #102: Red Hill Ave and Main St

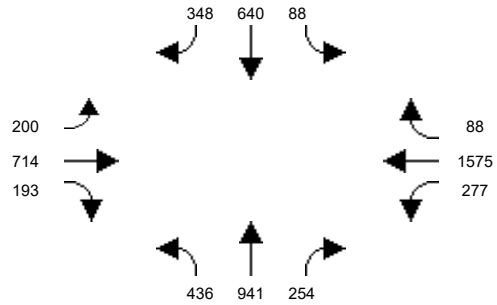

Intersection #103: I-5 SB Ramps and Santa Ana Blvd

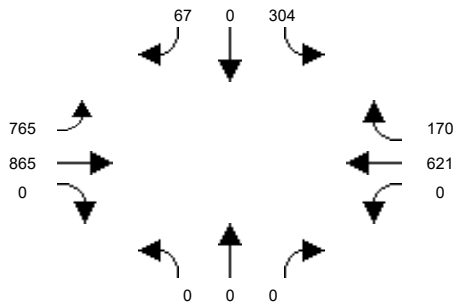

Intersection #104: Tustin Ranch Rd and Warner Ave

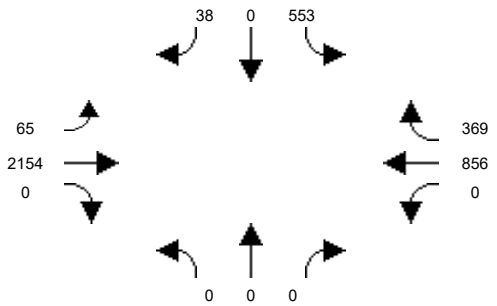

Intersection #105: Von Karman Ave and Barranca Pkwy

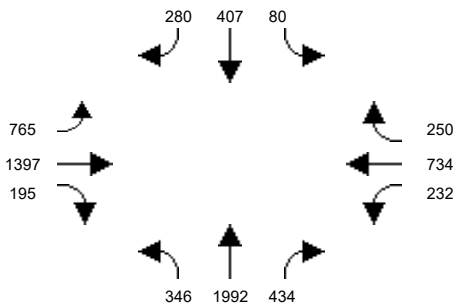

Intersection #106: Red Hill Avenue and El Camino Real

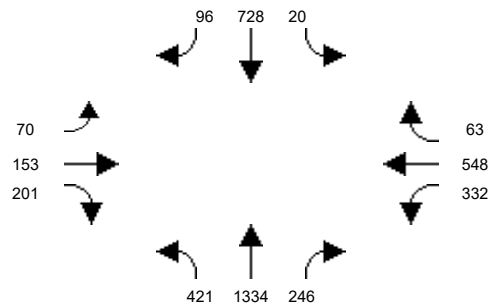

Intersection #107: Red Hill Avenue and I-5 NB Ramps

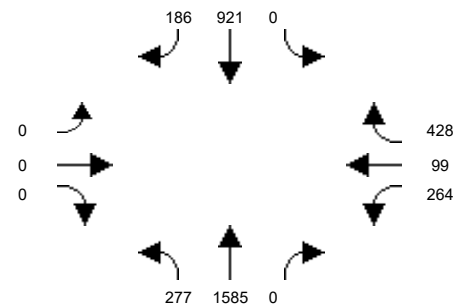

Intersection #108: Red Hill Avenue and I-5 SB Ramps

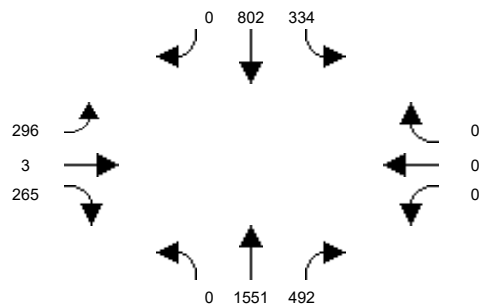

Intersection #109: Red Hill Avenue and Nissan Road

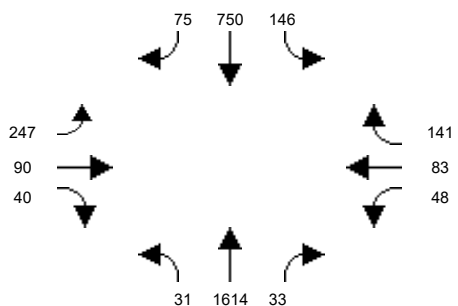

Intersection #110: Red Hill Avenue and Walnut Avenue

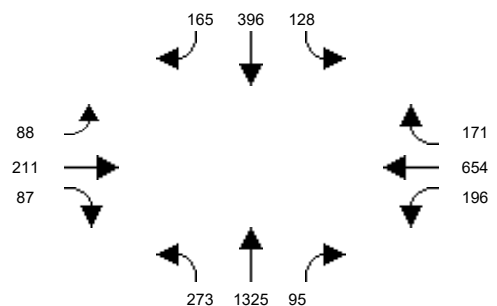

Santa Ana Circulation Element

Intersection Graphic Report
Entered Volume (Base Alternative)
2045 NP PM Peak Hour

Intersection #111: Red Hill Avenue and Valencia Avenue

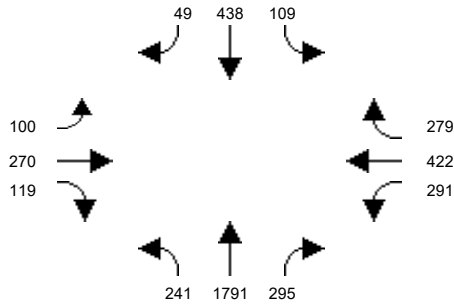

Intersection #112: Tustin Ranch Road and Warner Avenue North

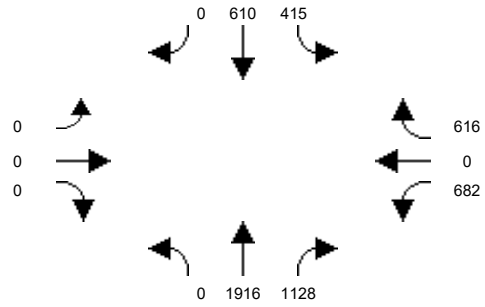

Intersection #113: Tustin Ranch Road and Walnut Avenue

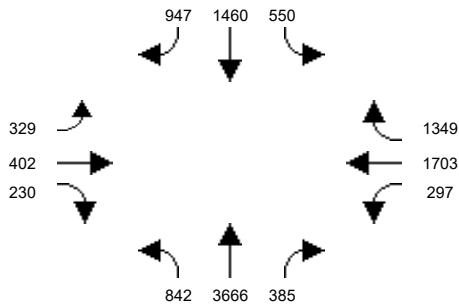

Intersection #114: SR-55 SB Ramps and Irvine Boulevard

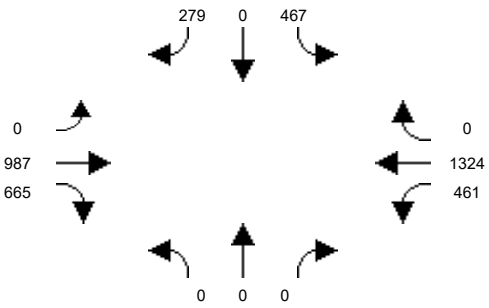

Intersection #115: SR-55 NB Ramps and Irvine Boulevard

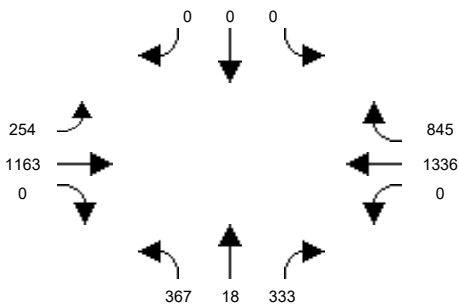

APPENDIX B.5
INTERSECTION VOLUMES –
2045 WP (AM PEAK HOUR)

Santa Ana Circulation Element

Intersection Graphic Report
Entered Volume (Base Alternative)
2045 WP AM Peak Hour

Intersection #1: Euclid St and 1st St

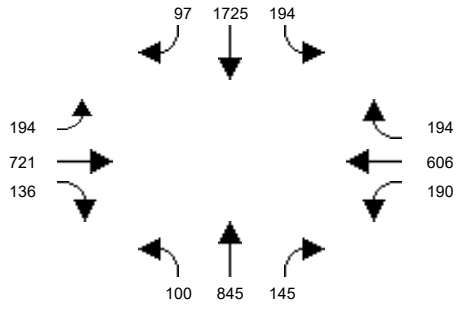

Intersection #2: Euclid St and McFadden Ave

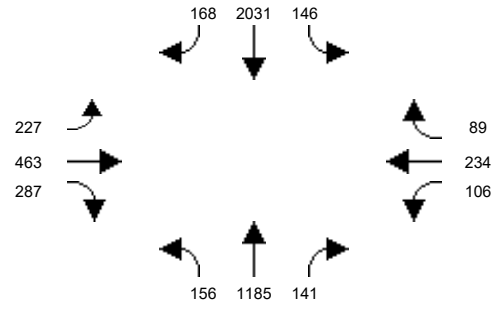

Intersection #3: Euclid St and Edinger Ave

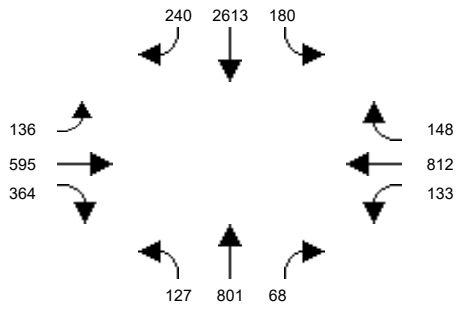

Intersection #4: Newhope St and Hazard Ave

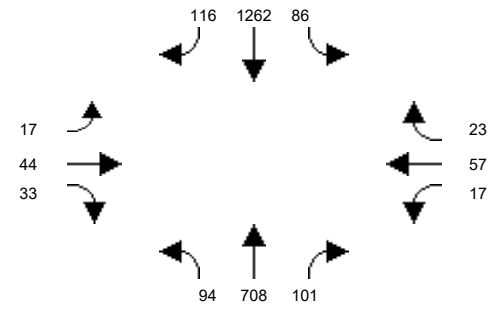

Intersection #5: Newhope St and McFadden Ave

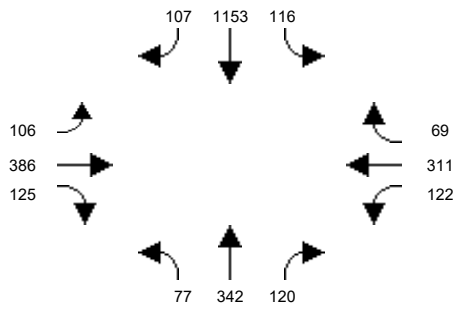

Intersection #6: Harbor Blvd and SR-22 WB Off-Ramp / Banner Dr

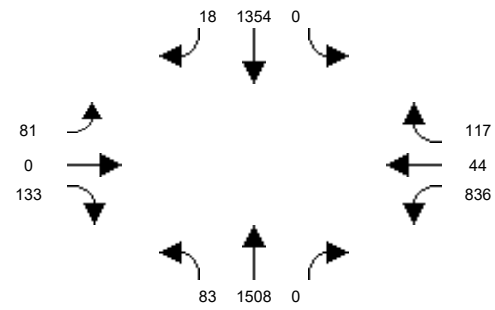

Intersection #7: Trask Avenue and SR-22 EB On-Ramp

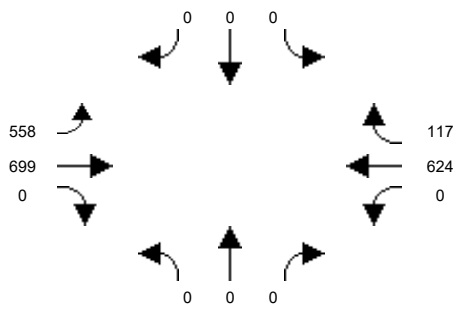

Intersection #8: Harbor Blvd and Westminster Ave

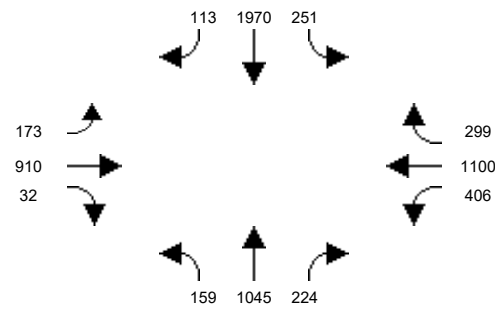

Intersection #9: Harbor Blvd and 1st St

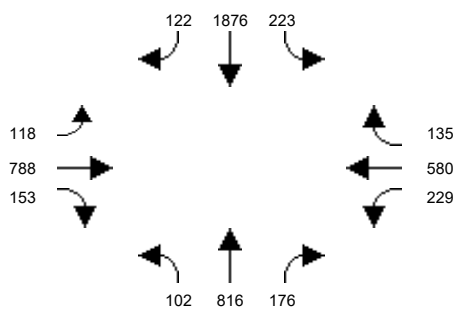

Intersection #10: Harbor Blvd and McFadden Ave

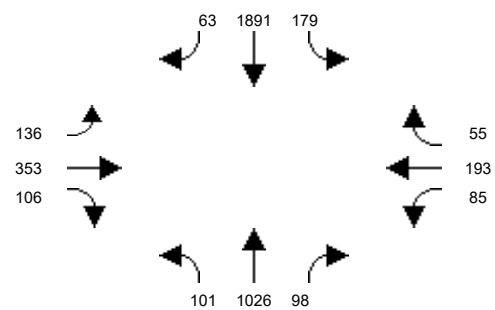

Santa Ana Circulation Element

Intersection Graphic Report
Entered Volume (Base Alternative)
2045 WP AM Peak Hour

Intersection #11: Harbor Blvd and Edinger Ave

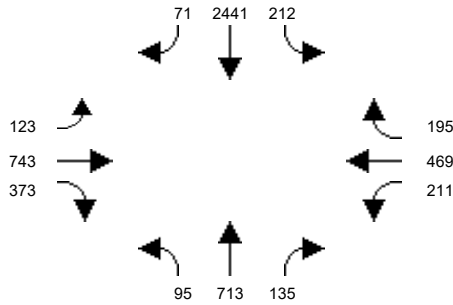

Intersection #12: Harbor Blvd and Warner Ave

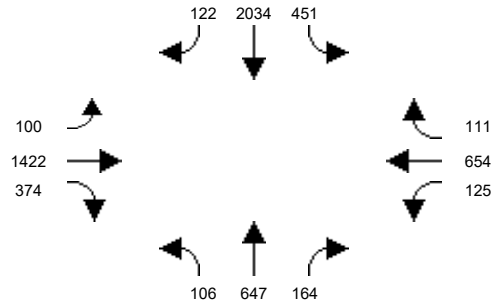

Intersection #13: Harbor Blvd and Segerstrom Ave

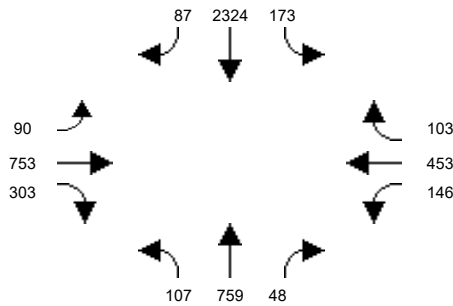

Intersection #14: MacArthur Blvd and Hyland Ave

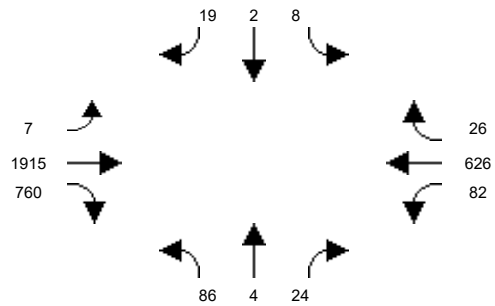

Intersection #15: MacArthur Blvd and Harbor Blvd

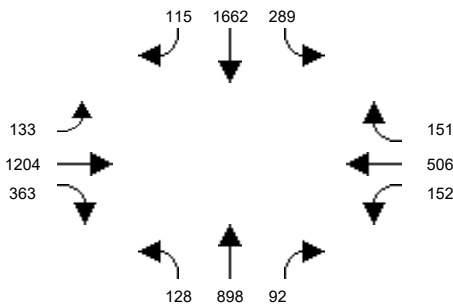

Intersection #16: Harbor Blvd and Sunflower Ave

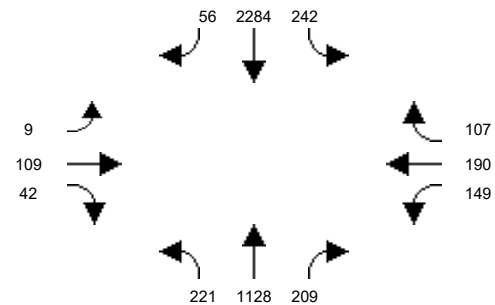

Intersection #17: Harbor Blvd and I-405 NB Off-Ramp

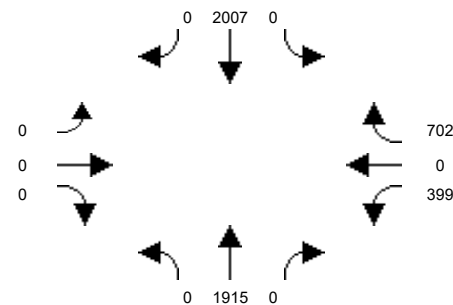

Intersection #18: Harbor Blvd and I-405 SB Off-Ramp

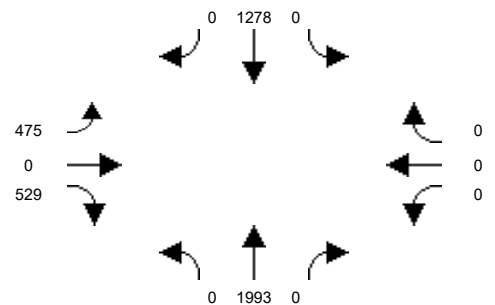

Intersection #19: Fairview St and Civic Center Dr

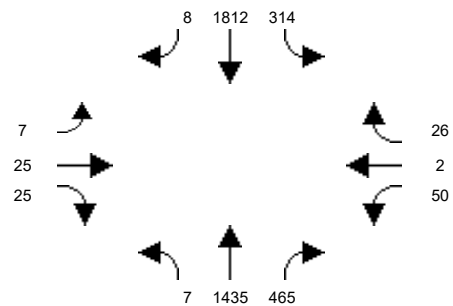

Intersection #20: Fairview St and 1st St

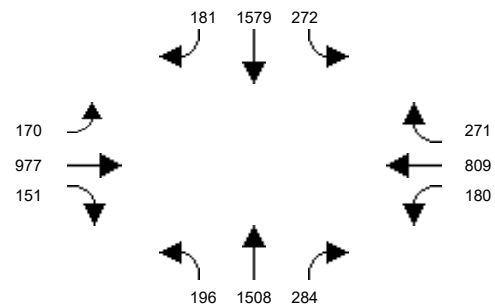

Santa Ana Circulation Element

Intersection Graphic Report
Entered Volume (Base Alternative)
2045 WP AM Peak Hour

Intersection #21: Fairview St and McFadden Ave

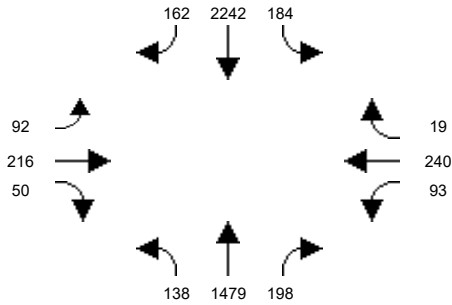

Intersection #22: Fairview St and Edinger Ave

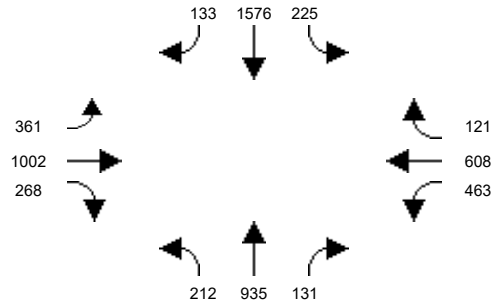

Intersection #23: Fairview St and Warner Ave

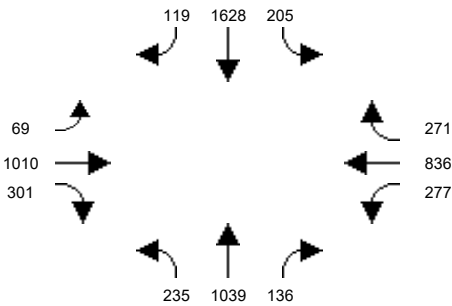

Intersection #24: Fairview St and MacArthur Blvd

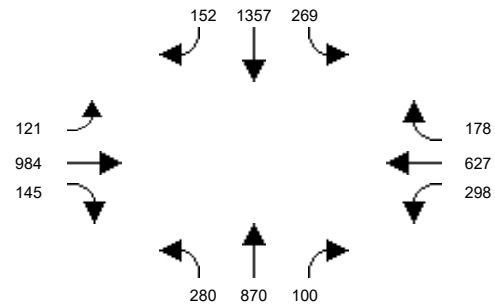

Intersection #25: Fairview Rd and Sunflower Ave

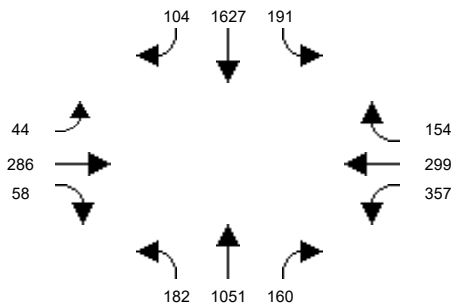

Intersection #26: Greenville St and Edinger Ave

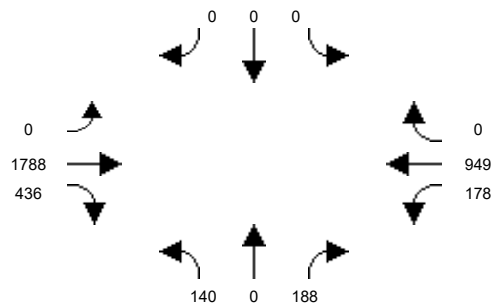

Intersection #27: Greenville St and Segerstrom Ave

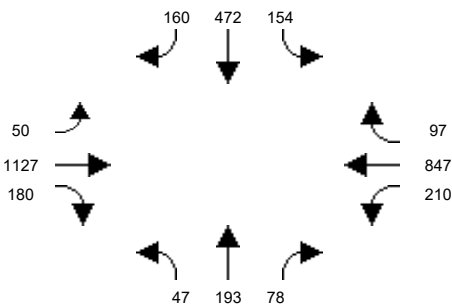

Intersection #28: Raitt St and McFadden Ave

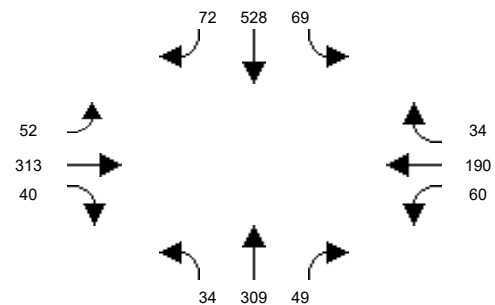

Intersection #29: Raitt St and Edinger Ave

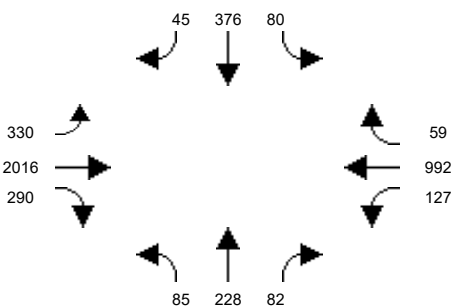

Intersection #30: Bear St and MacArthur Blvd

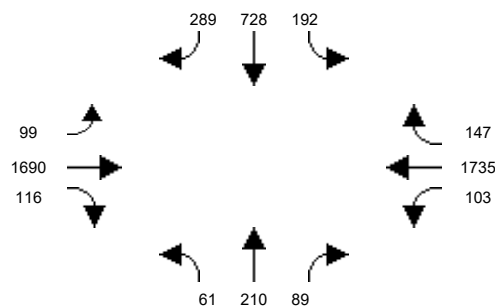

Santa Ana Circulation Element

Intersection Graphic Report
Entered Volume (Base Alternative)
2045 WP AM Peak Hour

Intersection #31: Bristol St and 17th St

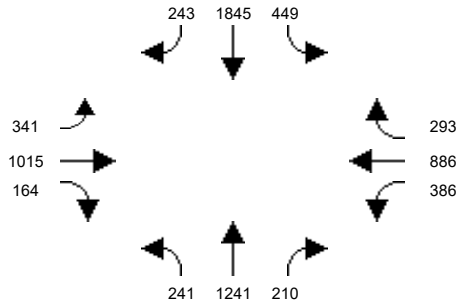

Intersection #32: Bristol St and Civic Center Dr

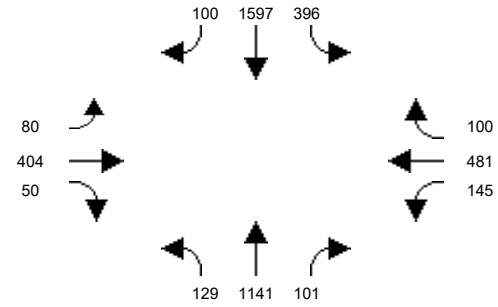

Intersection #33: Bristol St and Santa Ana Blvd

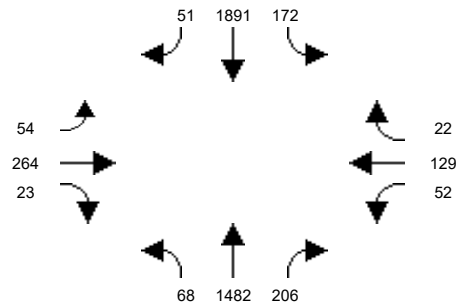

Intersection #34: Bristol St and 1st St

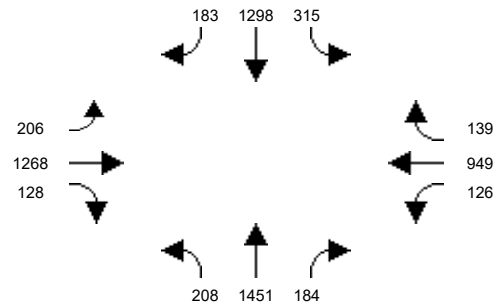

Intersection #35: Bristol St and McFadden Ave

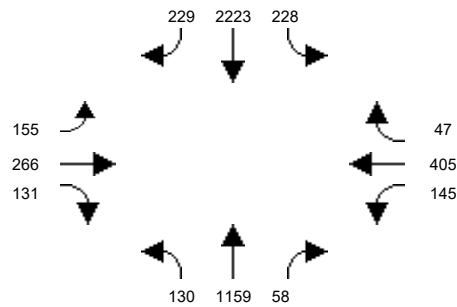

Intersection #36: Bristol St and Warner Ave

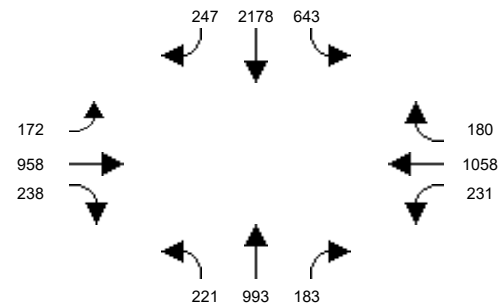

Intersection #37: Bristol St and Segerstrom Ave

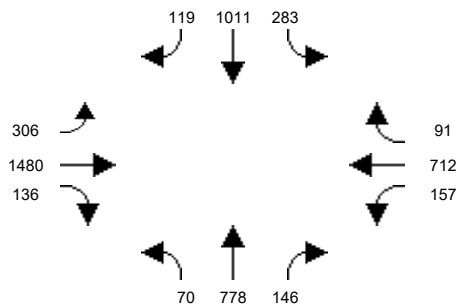

Intersection #38: Bristol St and Alton Ave

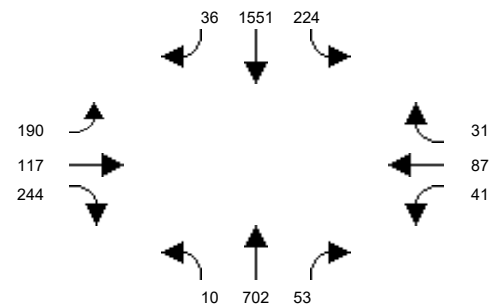

Intersection #39: Bristol St and MacArthur Blvd

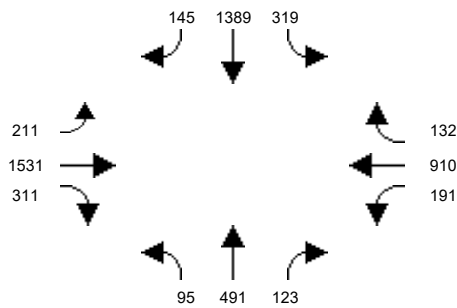

Intersection #40: Bristol St and Sunflower Ave

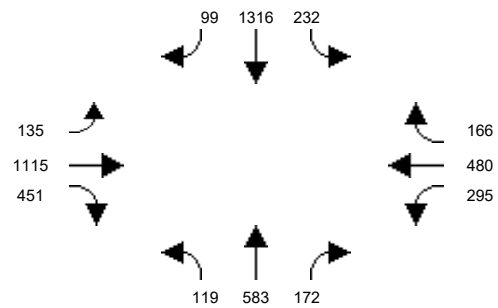

Santa Ana Circulation Element

Intersection Graphic Report
Entered Volume (Base Alternative)
2045 WP AM Peak Hour

Intersection #41: Bristol St and I-405 NB Ramps

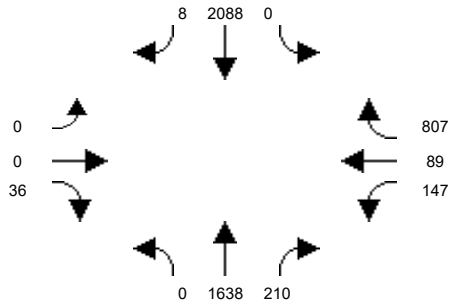

Intersection #42: Bristol St and I-405 SB Ramps

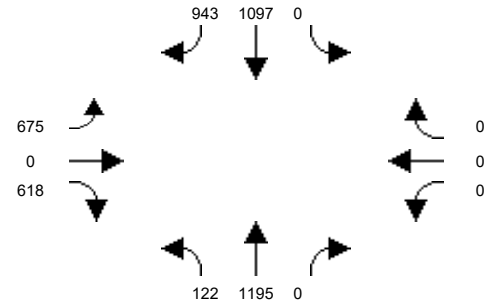

Intersection #43: Flower St and Santa Ana Blvd

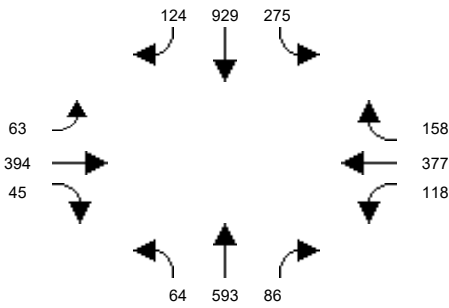

Intersection #44: Flower St and 1st St

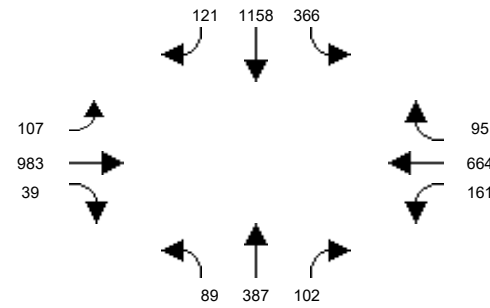

Intersection #45: Flower St and McFadden Ave

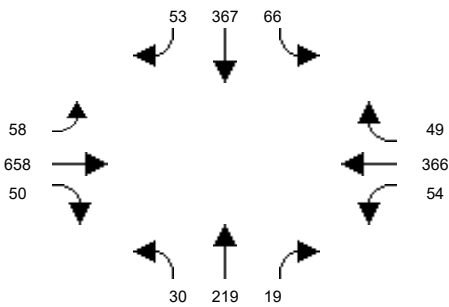

Intersection #46: Flower St and Segerstrom Ave

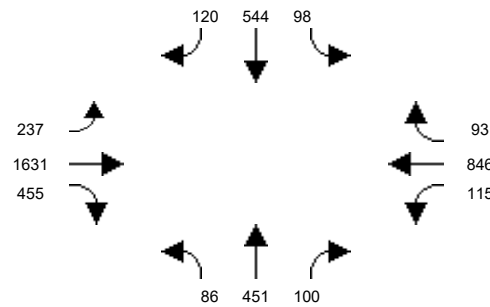

Intersection #47: Flower St and MacArthur Blvd

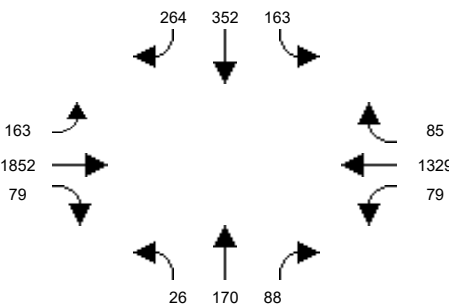

Intersection #48: Main St and La Veta Ave

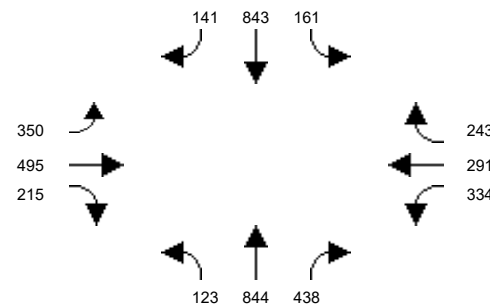

Intersection #49: Main St and Mainplace Dr / Memory Ln

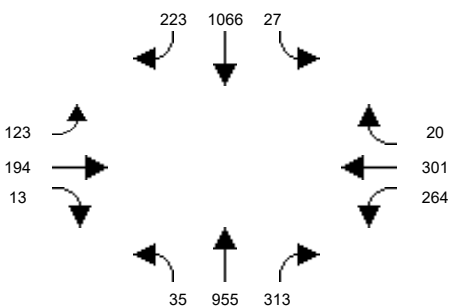

Intersection #50: Main St and 17th St

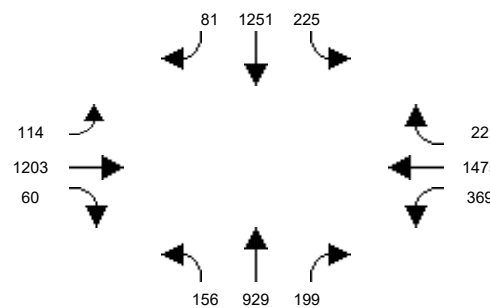

Santa Ana Circulation Element

Intersection Graphic Report
Entered Volume (Base Alternative)
2045 WP AM Peak Hour

Intersection #51: Main St and Civic Center Dr

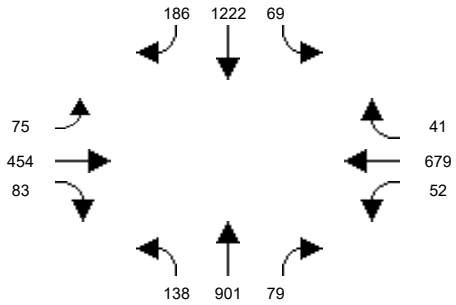

Intersection #52: Main St and Santa Ana Blvd

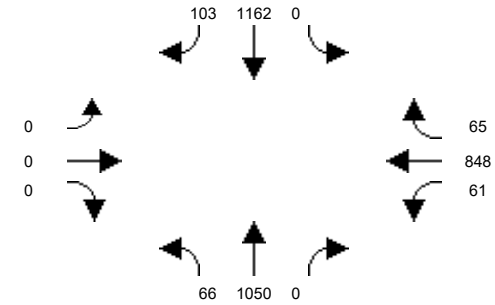

Intersection #53: Main St and 4th St

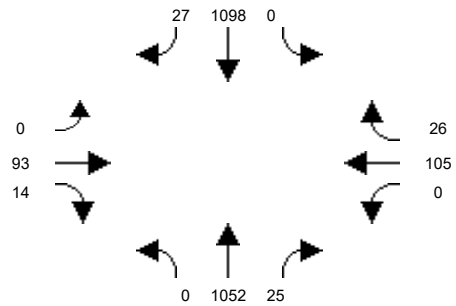

Intersection #54: Main St and 1st St

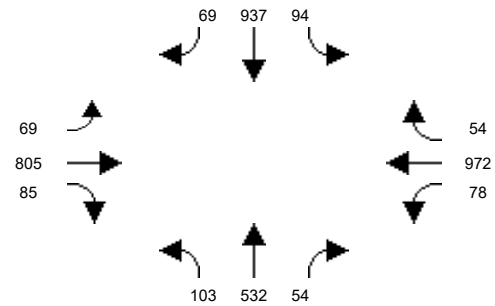

Intersection #55: Main St and McFadden Ave

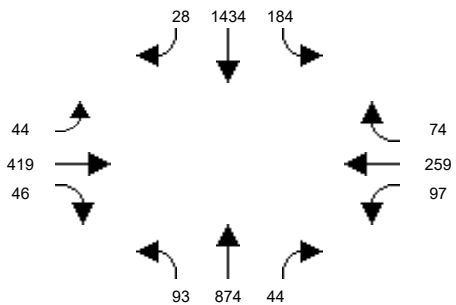

Intersection #56: Main St and Edinger Ave

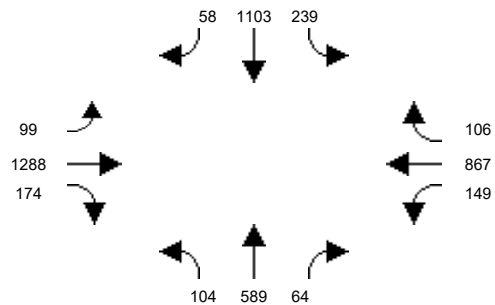

Intersection #57: Main St and MacArthur Blvd

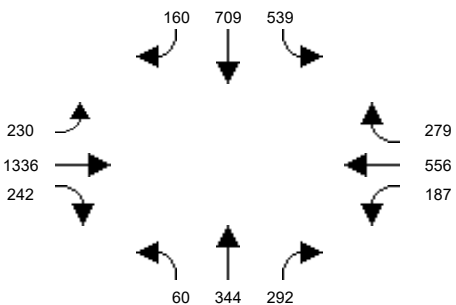

Intersection #58: Penn Wy and 17th St

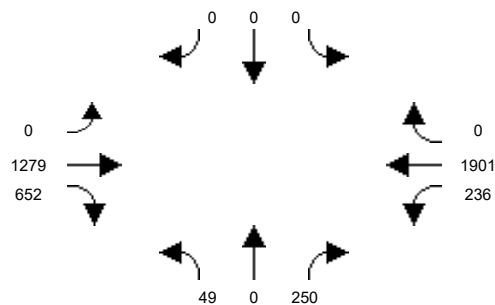

Intersection #59: I-5 NB Off Ramps/17th Street

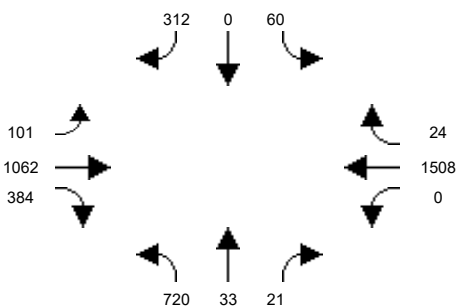

Intersection #60: Penn Wy and I-5 SB Ramps

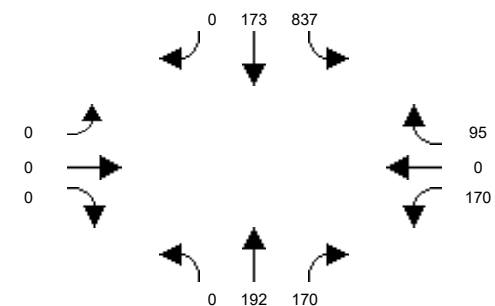

Santa Ana Circulation Element

Intersection Graphic Report
Entered Volume (Base Alternative)
2045 WP AM Peak Hour

Intersection #61: Santiago St and Civic Center Dr

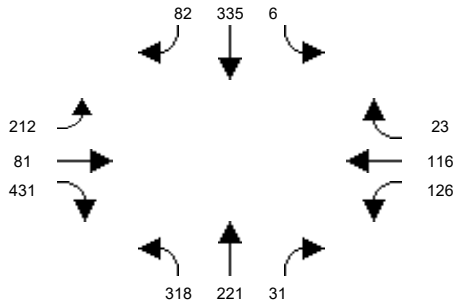

Intersection #62: Santiago St and Santa Ana Blvd

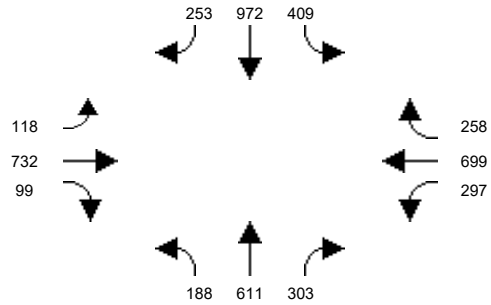

Intersection #63: Standard Ave and 4th St

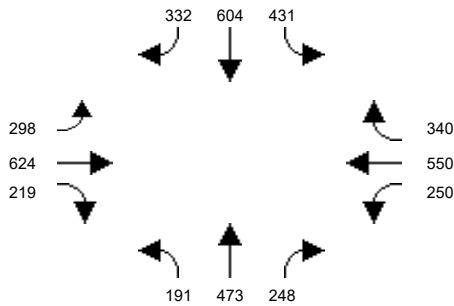

Intersection #64: Standard Ave and 1st St

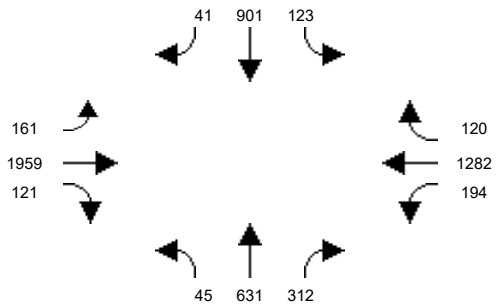

Intersection #65: Standard Ave and Mcfadden Ave

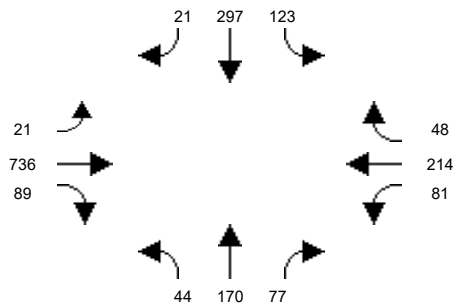

Intersection #66: Halladay St and Warner Ave

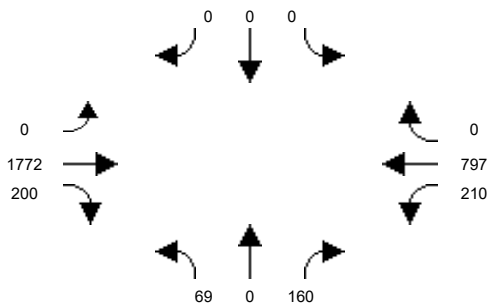

Intersection #67: Halladay St and Dyer Rd

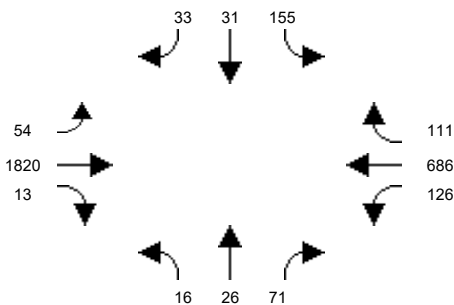

Intersection #68: SR-55 SB Ramps and MacArthur Blvd

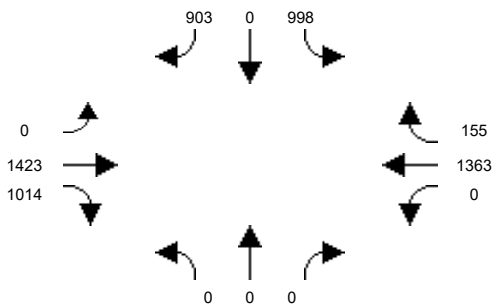

Intersection #69: SR-55 NB Ramps and MacArthur Blvd

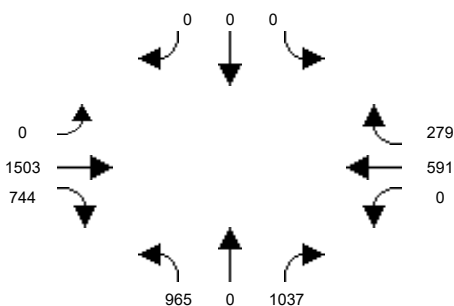

Intersection #70: SR-55 SB Ramps and Dyer Rd

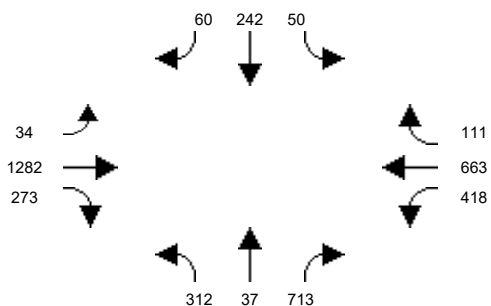

Santa Ana Circulation Element

Intersection Graphic Report
Entered Volume (Base Alternative)
2045 WP AM Peak Hour

Intersection #71: Glassell St and La Veta Ave

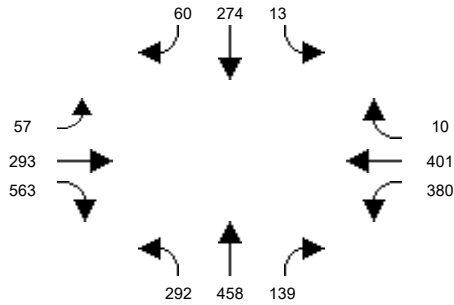

Intersection #72: Glassell St and SR-22 WB Ramps

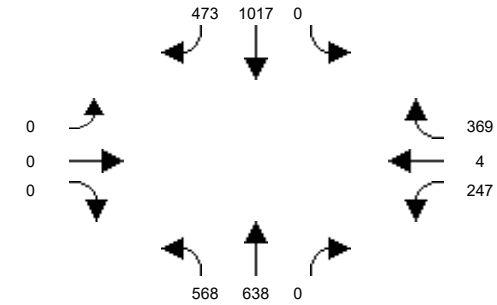

Intersection #73: Grand Ave / Glassell St and SR-22 EB Ramps

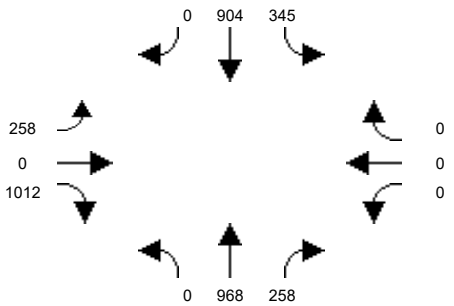

Intersection #74: Grand Ave and Fairhaven Ave

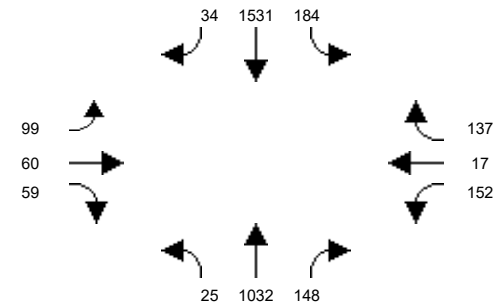

Intersection #75: Grand Ave and Santa Clara Ave

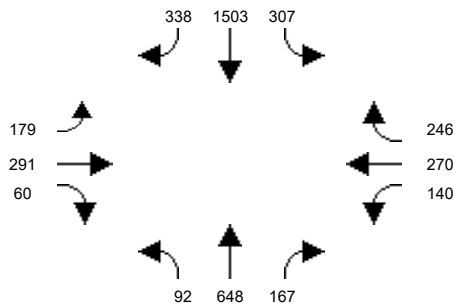

Intersection #76: Grand Ave and 17th St

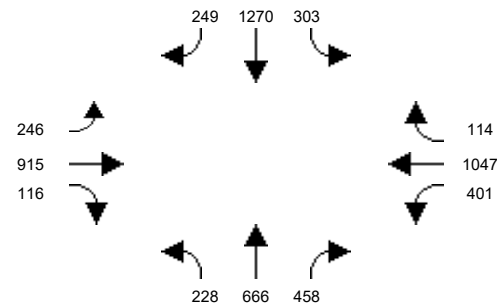

Intersection #77: Grand Ave and I-5 NB Ramps

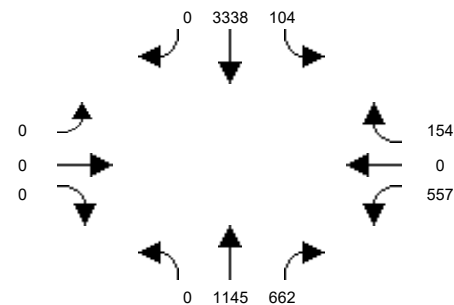

Intersection #78: Grand Ave and Santa Ana Blvd

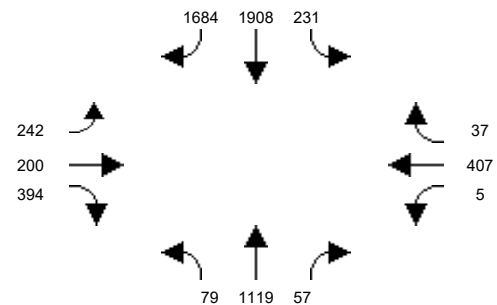

Intersection #79: Grand Ave and 1st St

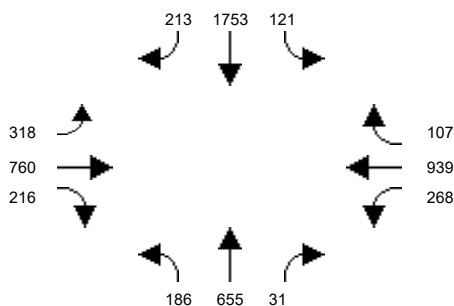

Intersection #80: Grand Ave and Chestnut Ave

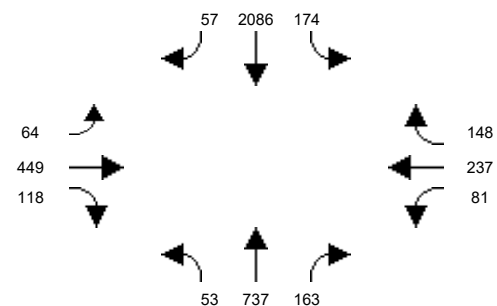

Santa Ana Circulation Element

Intersection Graphic Report
Entered Volume (Base Alternative)
2045 WP AM Peak Hour

Intersection #81: Grand Ave and McFadden Ave

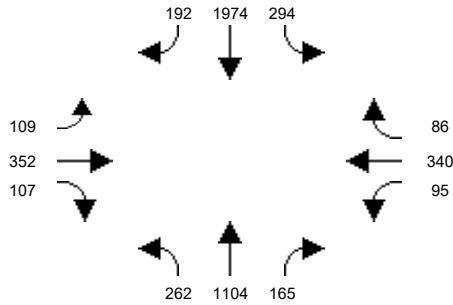

Intersection #82: Grand Ave and Edinger Ave

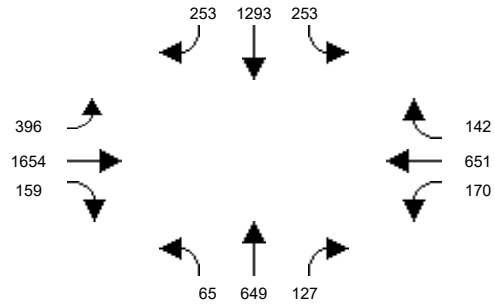

Intersection #83: Grand Ave and Warner Ave

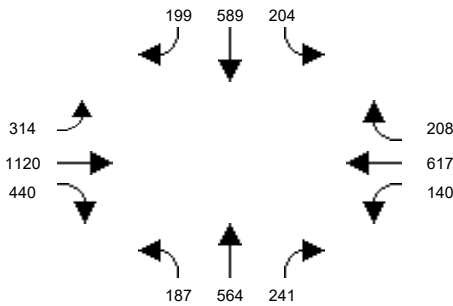

Intersection #84: SR-55 NB Ramps and Dyer Rd

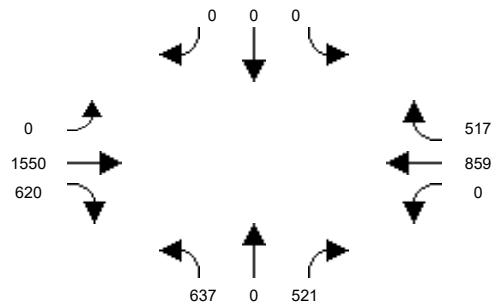

Intersection #85: Cambridge St and La Veta Ave

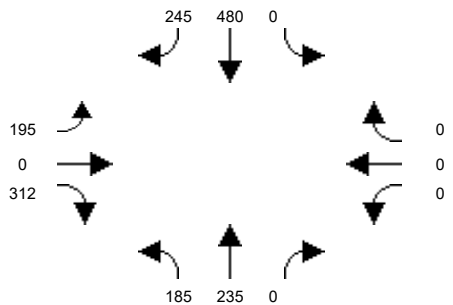

Intersection #86: Cambridge St and Fairhaven Ave

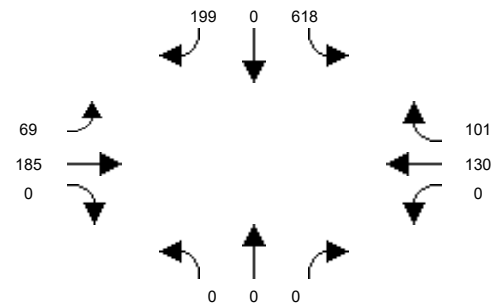

Intersection #87: Mabury St and 1st Street

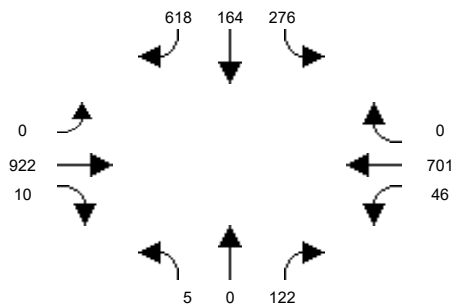

Intersection #88: Tustin St and La Veta Ave

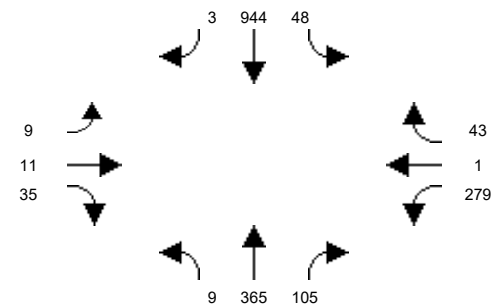

Intersection #89: Tustin St and SR-22 WB On-Ramp

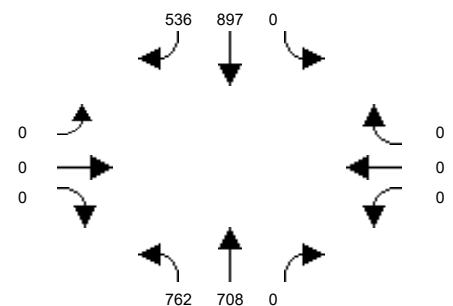

Intersection #90: Tustin St and SR-22 EB Off-Ramp / Seba Ave

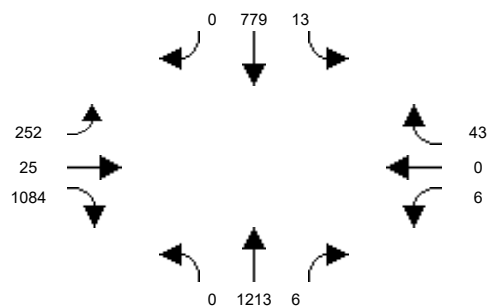

Santa Ana Circulation Element

Intersection Graphic Report
Entered Volume (Base Alternative)
2045 WP AM Peak Hour

Intersection #91: Tustin Ave and Fairhaven Ave

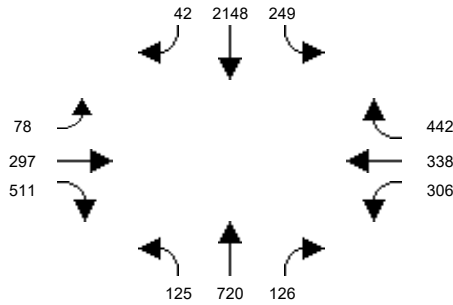

Intersection #92: Tustin Ave and Santa Clara Ave

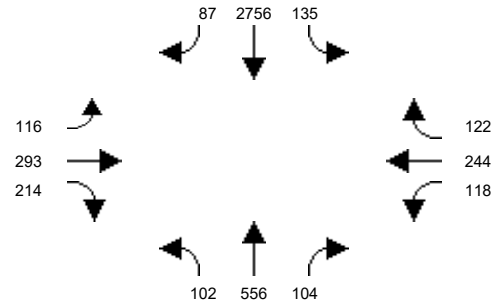

Intersection #93: Tustin Ave and 17th St

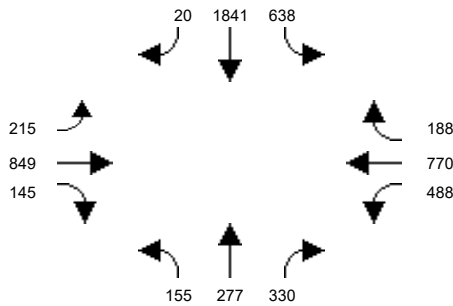

Intersection #94: Tustin Ave and 4th St

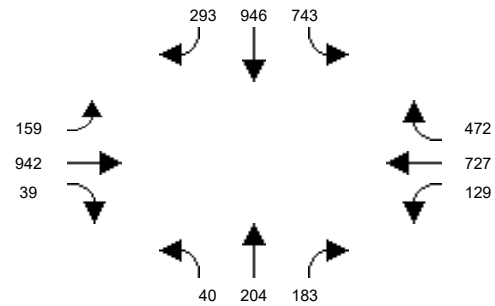

Intersection #95: SR-55 SB Ramps / Auto Mall Dr and Edinger Ave

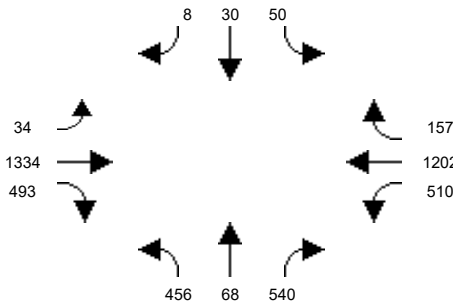

Intersection #96: SR-55 NB Ramps / Del Amo Ave and Newport Avenue

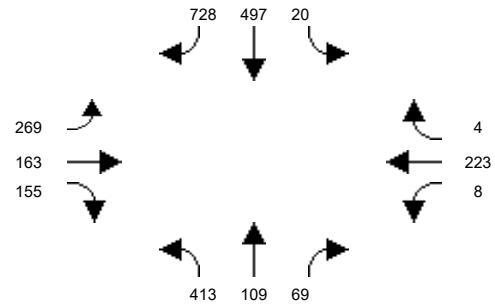

Intersection #97: Red Hill Ave and Edinger Ave

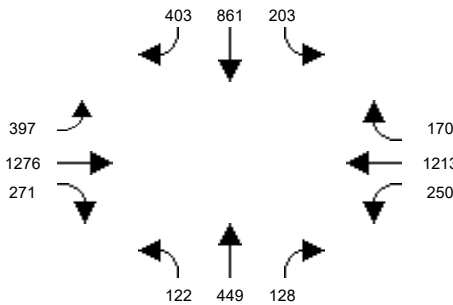

Intersection #98: Red Hill Ave and Warner Ave

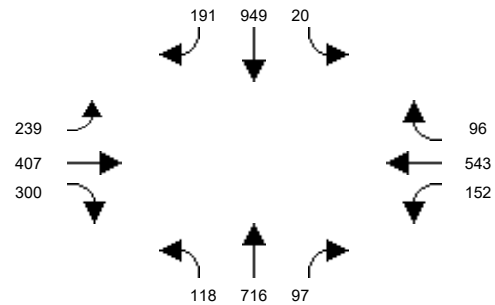

Intersection #99: Red Hill Ave and Dyer Rd / barranca Pkwy

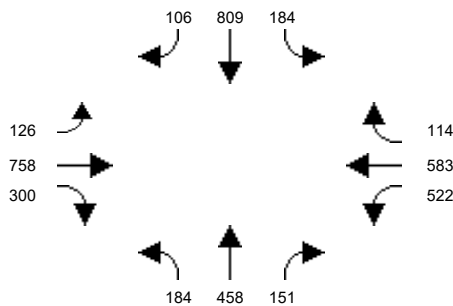

Intersection #100: Red Hill Ave and Alton Pkwy

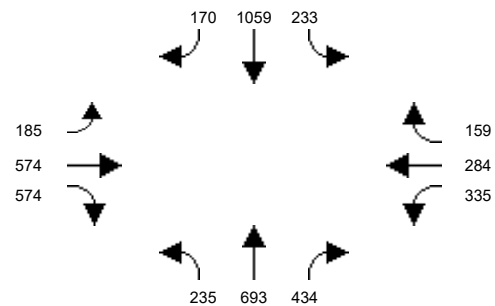

Santa Ana Circulation Element

Intersection Graphic Report
Entered Volume (Base Alternative)
2045 WP AM Peak Hour

Intersection #101: Red Hill Ave and MacArthur Blvd

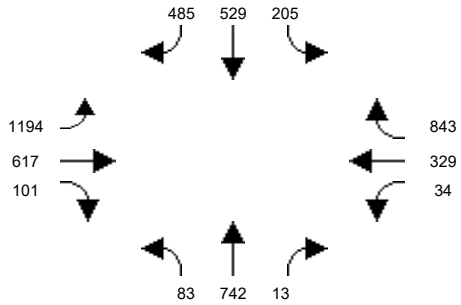

Intersection #102: Red Hill Ave and Main St

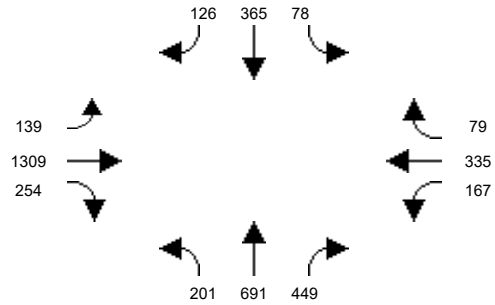

Intersection #103: I-5 SB Ramps and Santa Ana Blvd

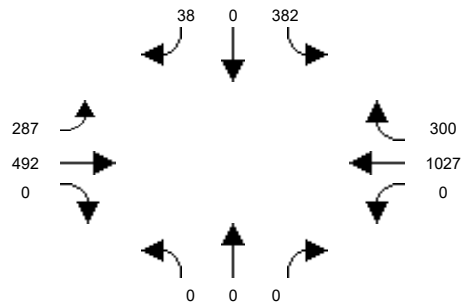

Intersection #104: Tustin Ranch Rd and Warner Ave

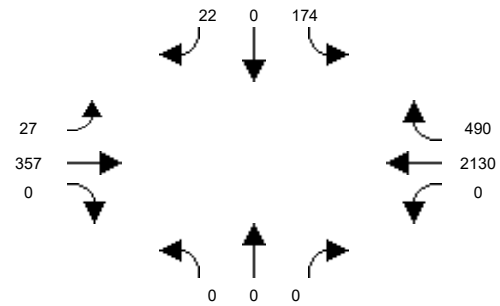

Intersection #105: Von Karman Ave and Barranca Pkwy

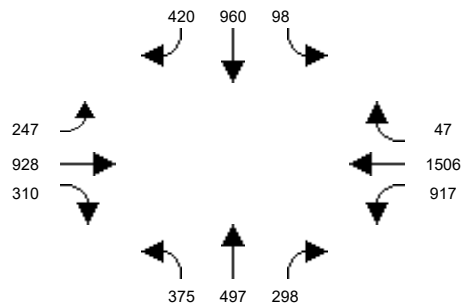

Intersection #106: Red Hill Avenue and El Camino Real

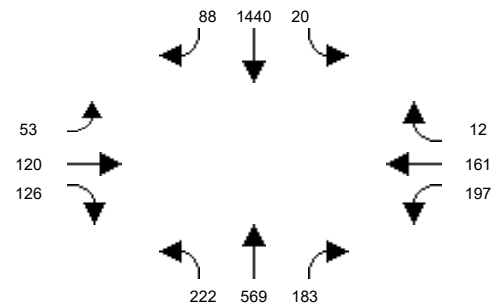

Intersection #107: Red Hill Avenue and I-5 NB Ramps

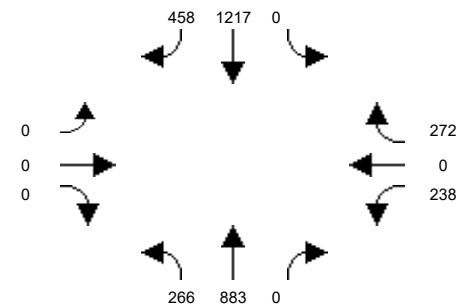

Intersection #108: Red Hill Avenue and I-5 SB Ramps

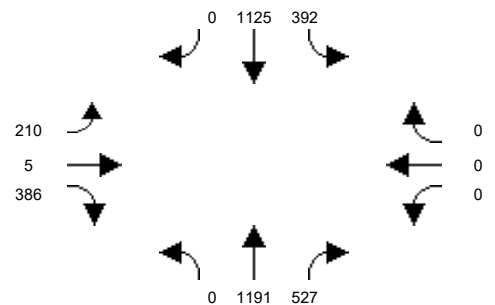

Intersection #109: Red Hill Avenue and Nissan Road

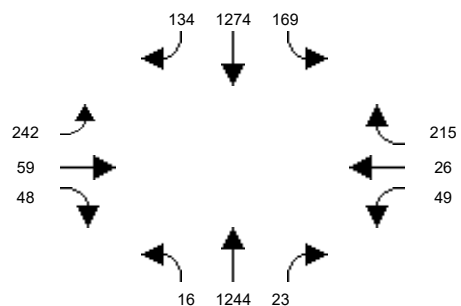

Intersection #110: Red Hill Avenue and Walnut Avenue

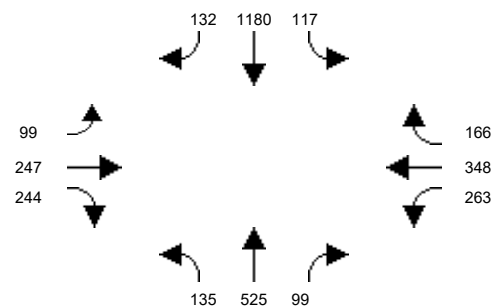

Santa Ana Circulation Element

Intersection Graphic Report
Entered Volume (Base Alternative)
2045 WP AM Peak Hour

Intersection #111: Red Hill Avenue and Valencia Avenue

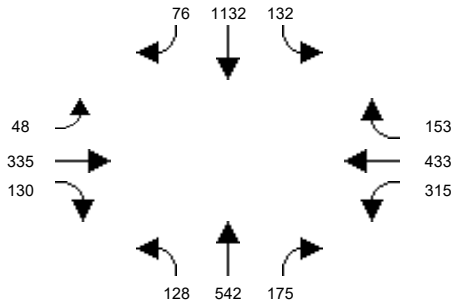

Intersection #112: Tustin Ranch Road and Warner Avenue North

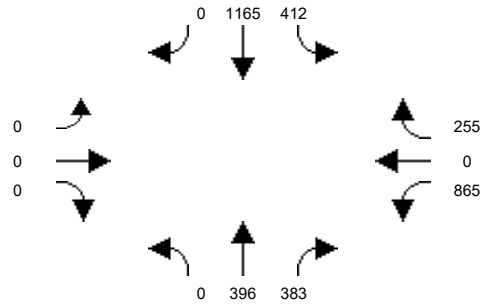

Intersection #113: Tustin Ranch Road and Walnut Avenue

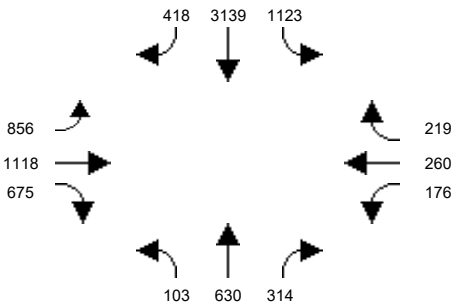

Intersection #114: SR-55 SB Ramps and Irvine Boulevard

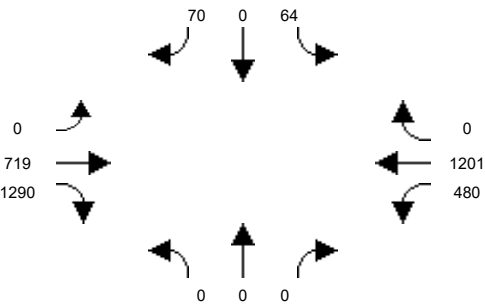

Intersection #115: SR-55 NB Ramps and Irvine Boulevard

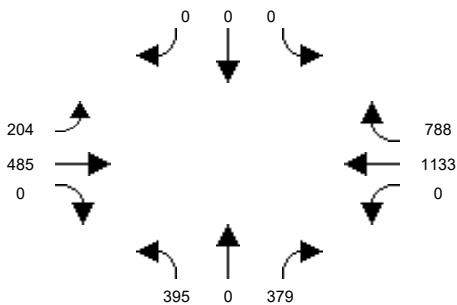

APPENDIX B.6
INTERSECTION VOLUMES –
2045 WP (PM PEAK HOUR)

Santa Ana Circulation Element

Intersection Graphic Report
Entered Volume (Base Alternative)
2045 WP PM Peak Hour

Intersection #1: Euclid St and 1st St

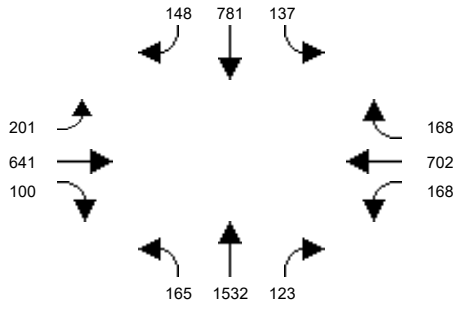

Intersection #2: Euclid St and McFadden Ave

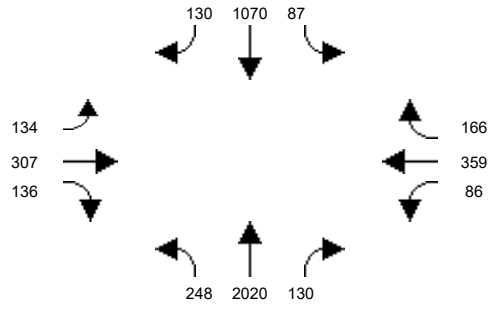

Intersection #3: Euclid St and Edinger Ave

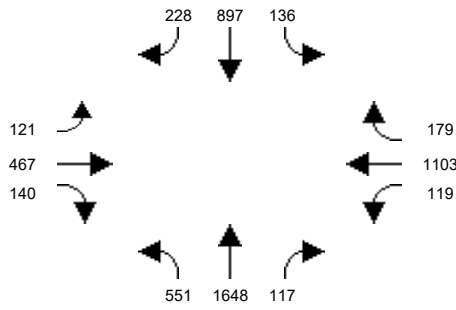

Intersection #4: Newhope St and Hazard Ave

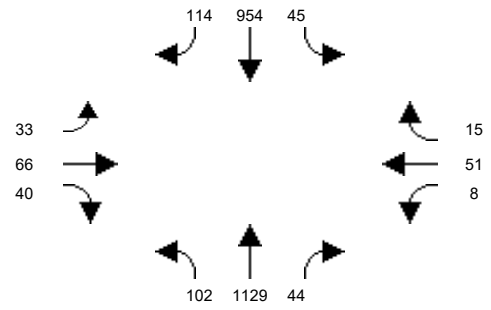

Intersection #5: Newhope St and McFadden Ave

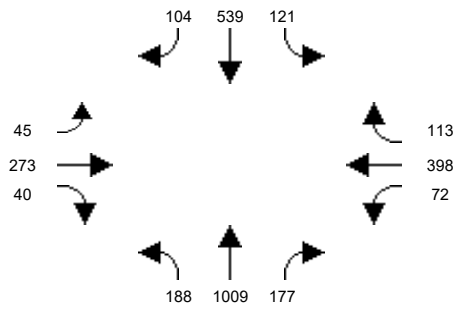

Intersection #6: Harbor Blvd and SR-22 WB Off-Ramp / Banner Dr

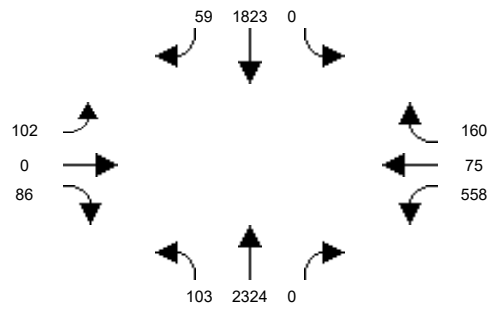

Intersection #7: Trask Avenue and SR-22 EB On-Ramp

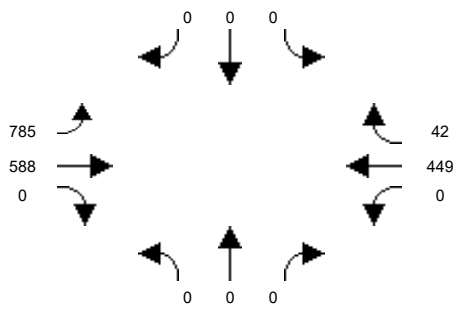

Intersection #8: Harbor Blvd and Westminster Ave

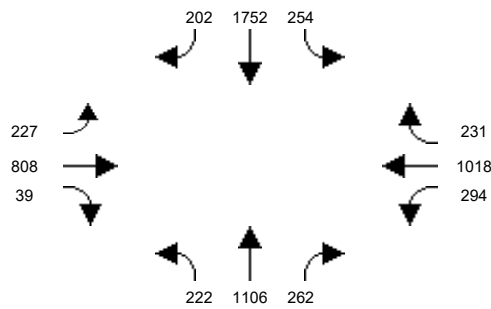

Intersection #9: Harbor Blvd and 1st St

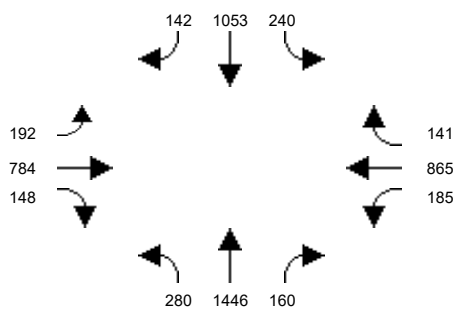

Intersection #10: Harbor Blvd and McFadden Ave

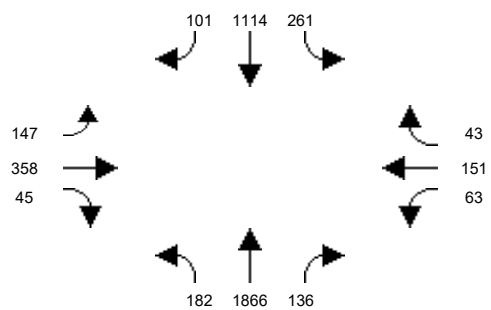

Santa Ana Circulation Element

Intersection Graphic Report
Entered Volume (Base Alternative)
2045 WP PM Peak Hour

Intersection #11: Harbor Blvd and Edinger Ave

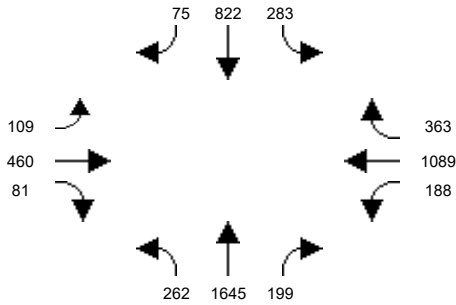

Intersection #12: Harbor Blvd and Warner Ave

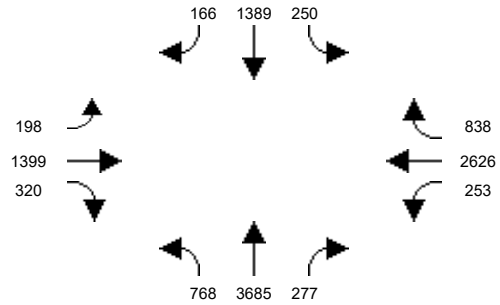

Intersection #13: Harbor Blvd and Segerstrom Ave

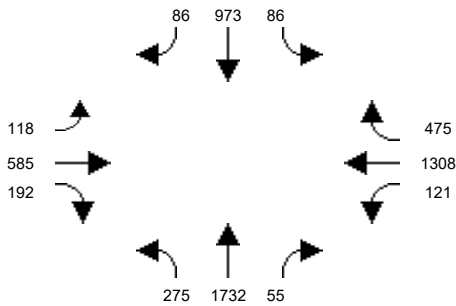

Intersection #14: MacArthur Blvd and Hyland Ave

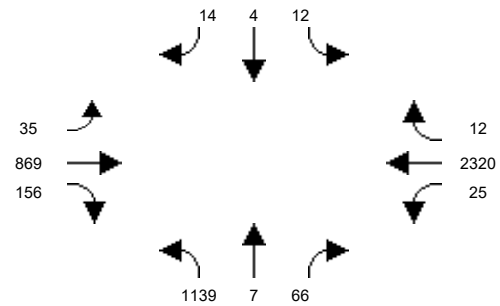

Intersection #15: MacArthur Blvd and Harbor Blvd

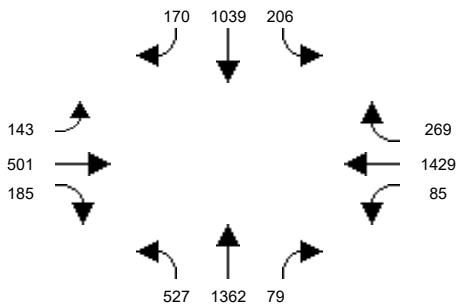

Intersection #16: Harbor Blvd and Sunflower Ave

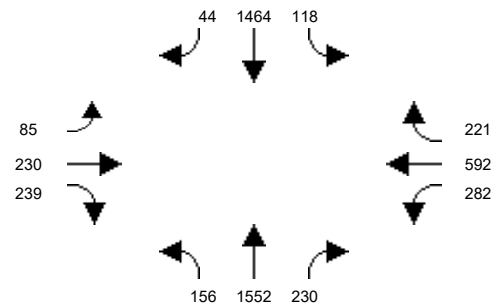

Intersection #17: Harbor Blvd and I-405 NB Off-Ramp

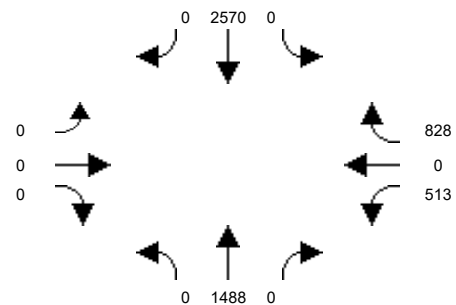

Intersection #18: Harbor Blvd and I-405 SB Off-Ramp

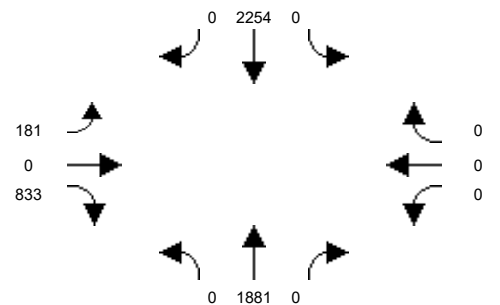

Intersection #19: Fairview St and Civic Center Dr

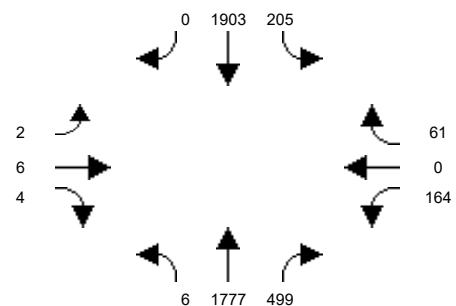

Intersection #20: Fairview St and 1st St

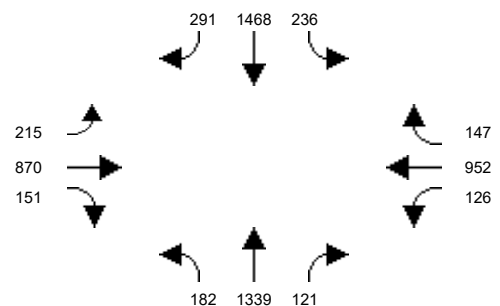

Santa Ana Circulation Element

Intersection Graphic Report
Entered Volume (Base Alternative)
2045 WP PM Peak Hour

Intersection #21: Fairview St and McFadden Ave

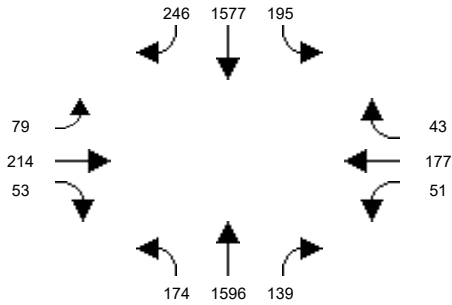

Intersection #22: Fairview St and Edinger Ave

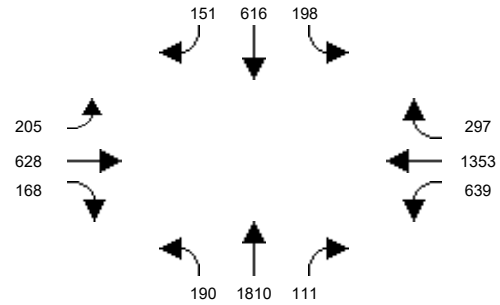

Intersection #23: Fairview St and Warner Ave

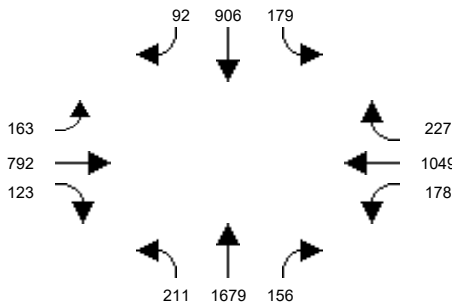

Intersection #24: Fairview St and MacArthur Blvd

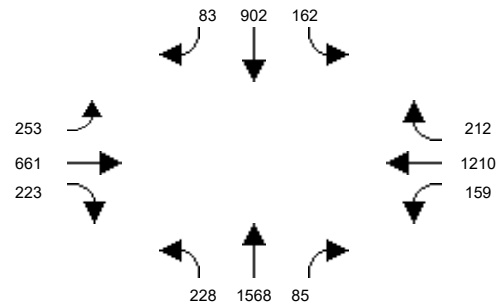

Intersection #25: Fairview Rd and Sunflower Ave

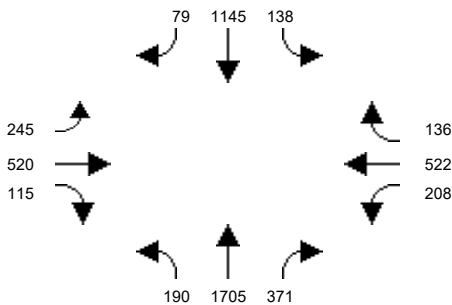

Intersection #26: Greenville St and Edinger Ave

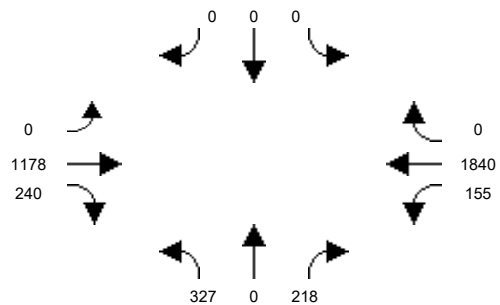

Intersection #27: Greenville St and Segerstrom Ave

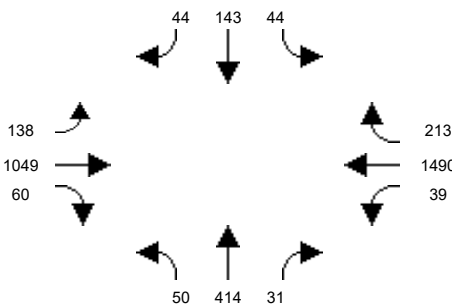

Intersection #28: Raitt St and McFadden Ave

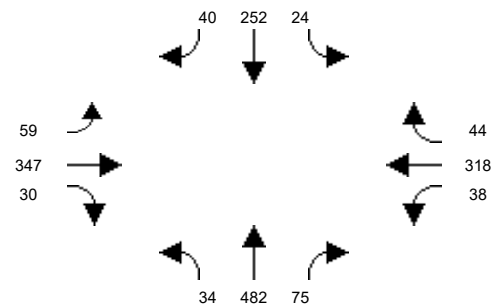

Intersection #29: Raitt St and Edinger Ave

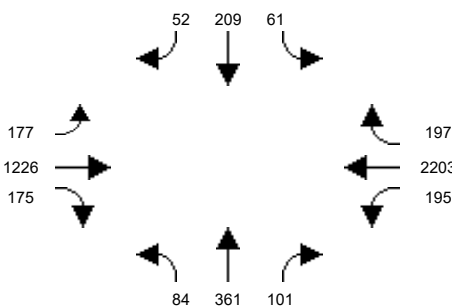

Intersection #30: Bear St and MacArthur Blvd

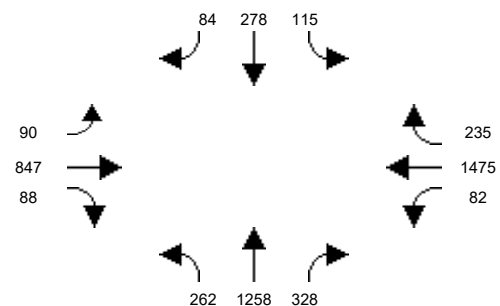

Santa Ana Circulation Element

Intersection Graphic Report
Entered Volume (Base Alternative)
2045 WP PM Peak Hour

Intersection #31: Bristol St and 17th St

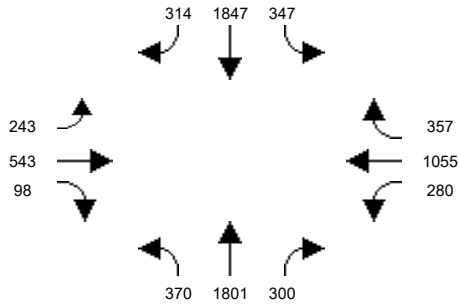

Intersection #32: Bristol St and Civic Center Dr

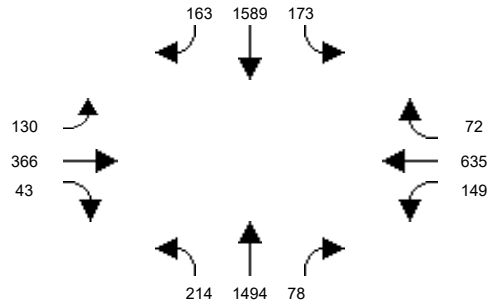

Intersection #33: Bristol St and Santa Ana Blvd

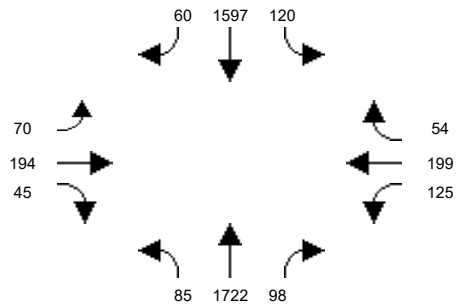

Intersection #34: Bristol St and 1st St

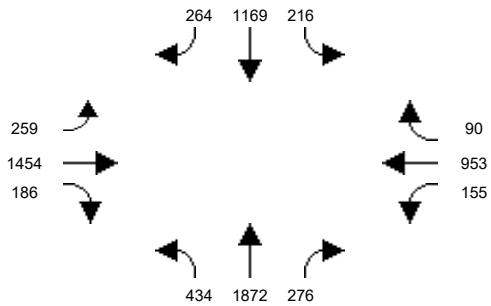

Intersection #35: Bristol St and McFadden Ave

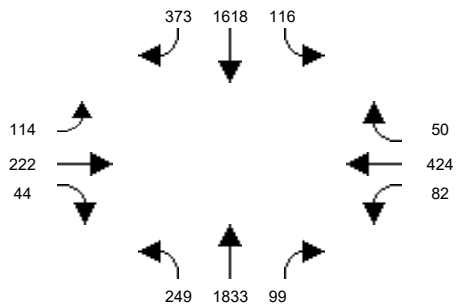

Intersection #36: Bristol St and Warner Ave

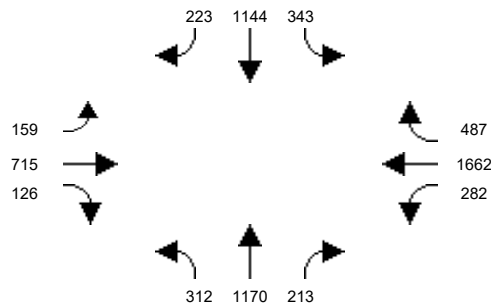

Intersection #37: Bristol St and Segerstrom Ave

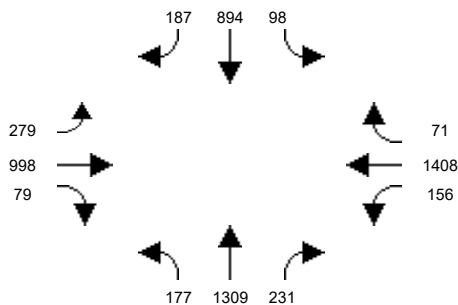

Intersection #38: Bristol St and Alton Ave

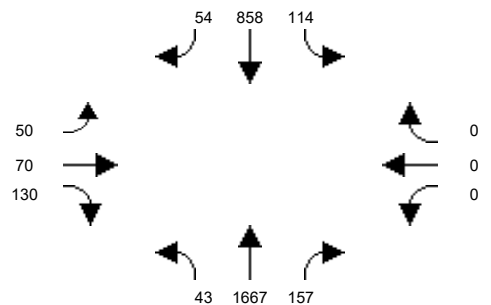

Intersection #39: Bristol St and MacArthur Blvd

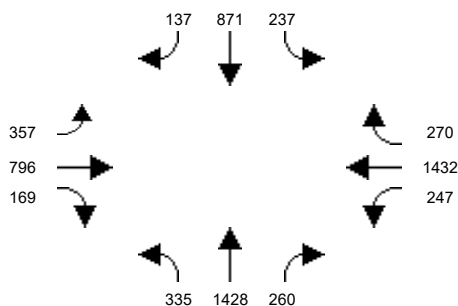

Intersection #40: Bristol St and Sunflower Ave

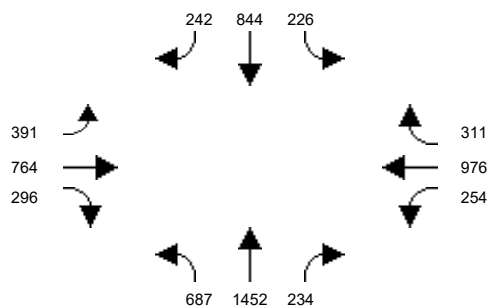

Santa Ana Circulation Element

Intersection Graphic Report
Entered Volume (Base Alternative)
2045 WP PM Peak Hour

Intersection #41: Bristol St and I-405 NB Ramps

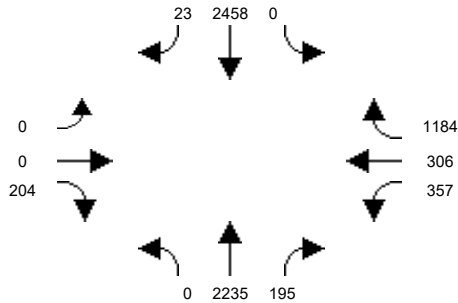

Intersection #42: Bristol St and I-405 SB Ramps

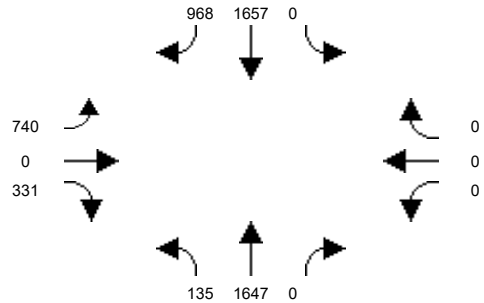

Intersection #43: Flower St and Santa Ana Blvd

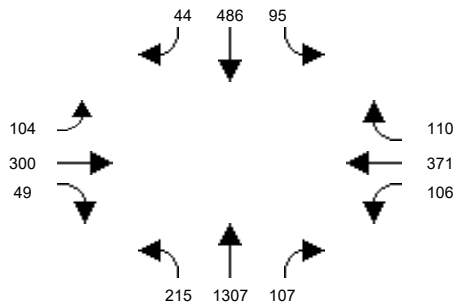

Intersection #44: Flower St and 1st St

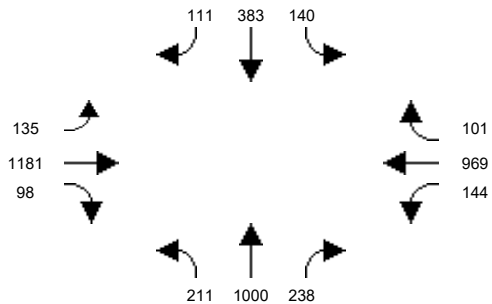

Intersection #45: Flower St and McFadden Ave

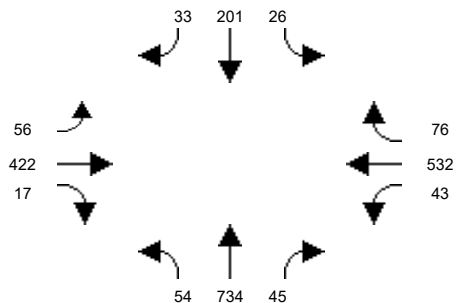

Intersection #46: Flower St and Segerstrom Ave

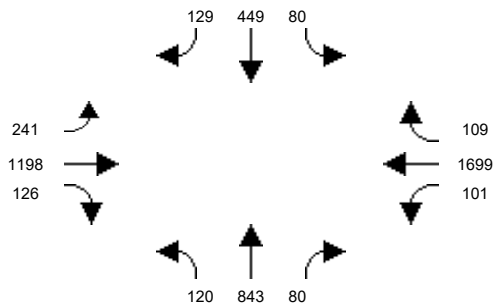

Intersection #47: Flower St and MacArthur Blvd

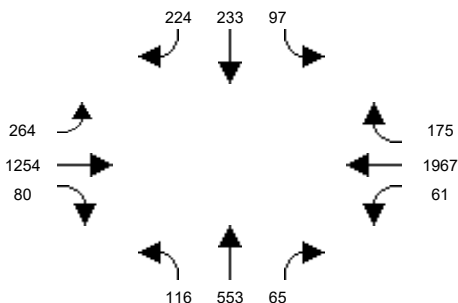

Intersection #48: Main St and La Veta Ave

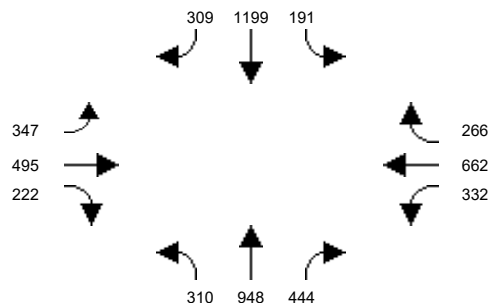

Intersection #49: Main St and Mainplace Dr / Memory Ln

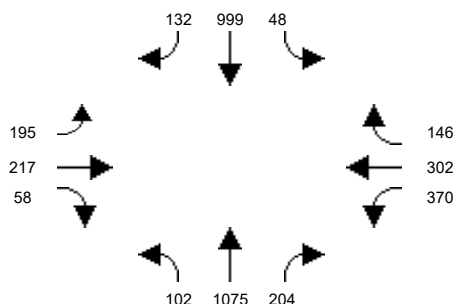

Intersection #50: Main St and 17th St

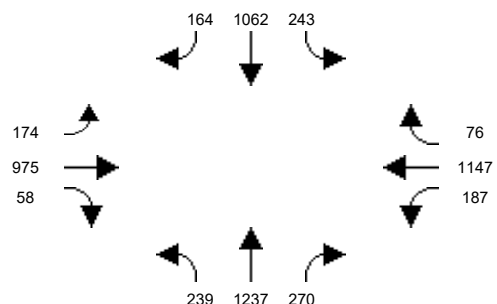

Santa Ana Circulation Element

Intersection Graphic Report
Entered Volume (Base Alternative)
2045 WP PM Peak Hour

Intersection #51: Main St and Civic Center Dr

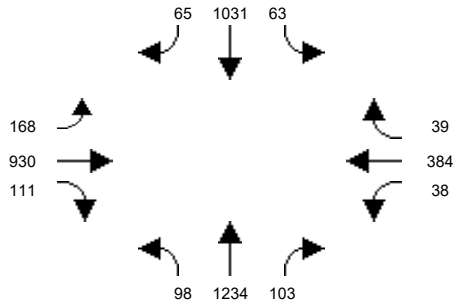

Intersection #52: Main St and Santa Ana Blvd

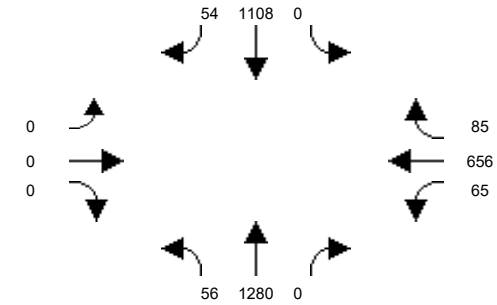

Intersection #53: Main St and 4th St

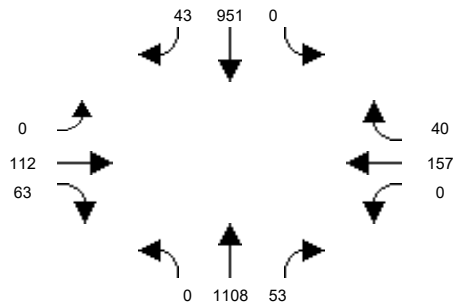

Intersection #54: Main St and 1st St

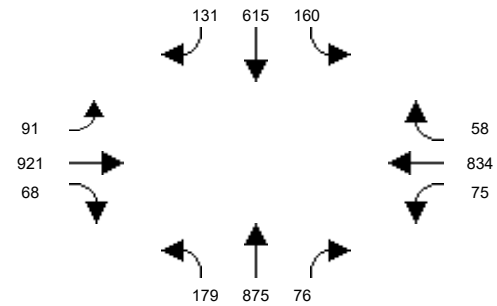

Intersection #55: Main St and McFadden Ave

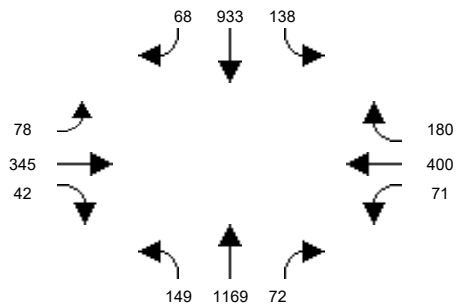

Intersection #56: Main St and Edinger Ave

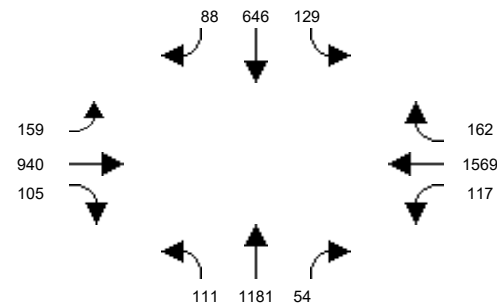

Intersection #57: Main St and MacArthur Blvd

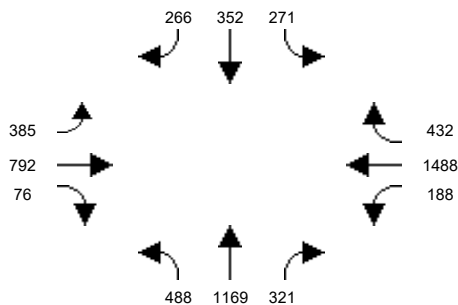

Intersection #58: Penn Wy and 17th St

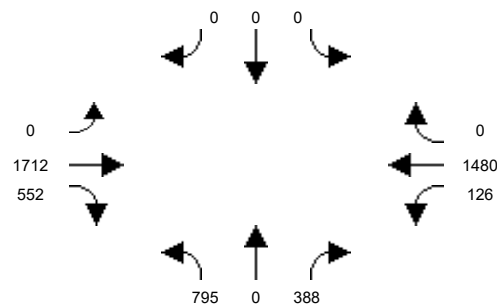

Intersection #59: I-5 NB Off Ramps/17th Street

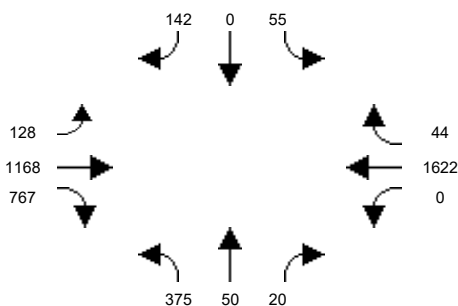

Intersection #60: Penn Wy and I-5 SB Ramps

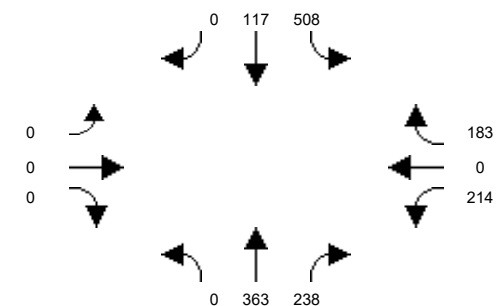

Santa Ana Circulation Element

Intersection Graphic Report
Entered Volume (Base Alternative)
2045 WP PM Peak Hour

Intersection #61: Santiago St and Civic Center Dr

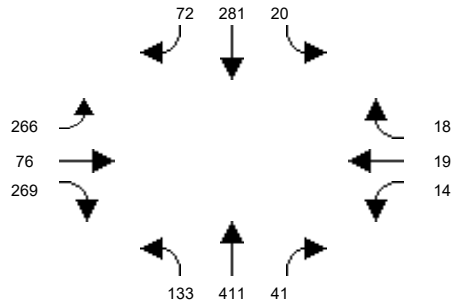

Intersection #62: Santiago St and Santa Ana Blvd

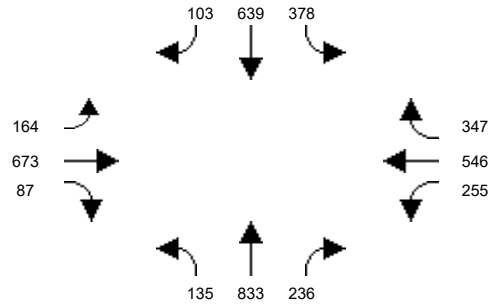

Intersection #63: Standard Ave and 4th St

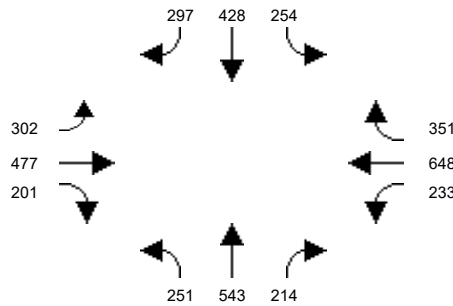

Intersection #64: Standard Ave and 1st St

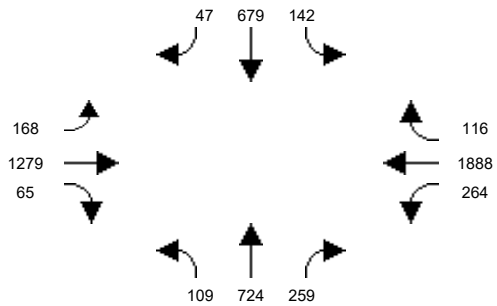

Intersection #65: Standard Ave and Mcfadden Ave

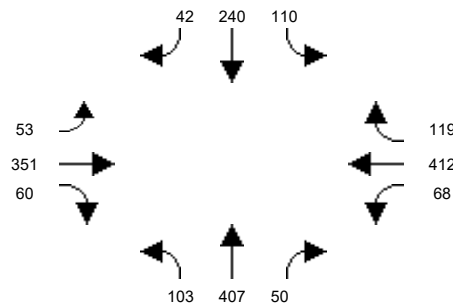

Intersection #66: Halladay St and Warner Ave

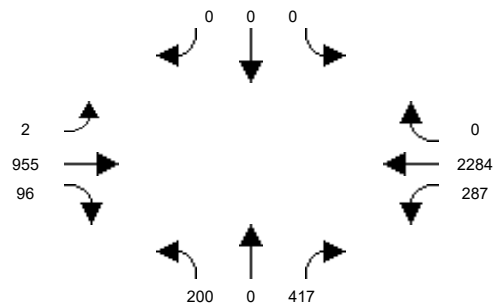

Intersection #67: Halladay St and Dyer Rd

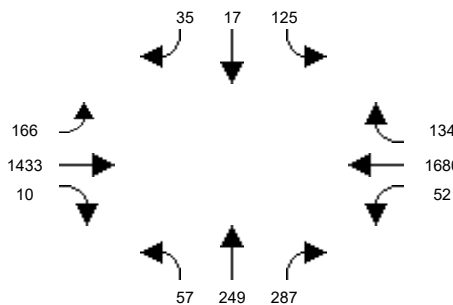

Intersection #68: SR-55 SB Ramps and MacArthur Blvd

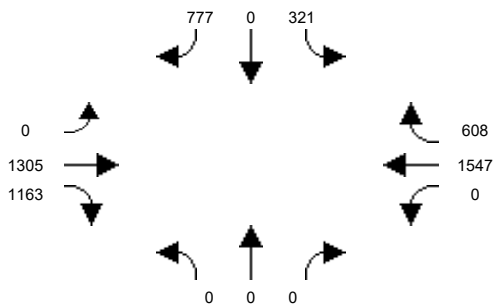

Intersection #69: SR-55 NB Ramps and MacArthur Blvd

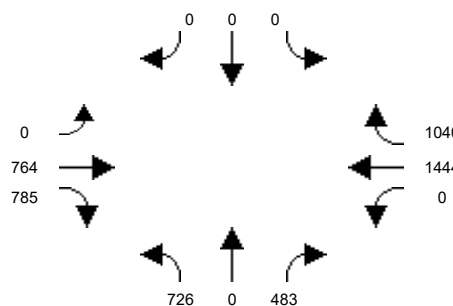

Intersection #70: SR-55 SB Ramps and Dyer Rd

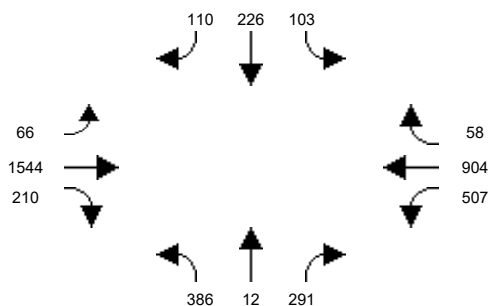

Santa Ana Circulation Element

Intersection Graphic Report
Entered Volume (Base Alternative)
2045 WP PM Peak Hour

Intersection #71: Glassell St and La Veta Ave

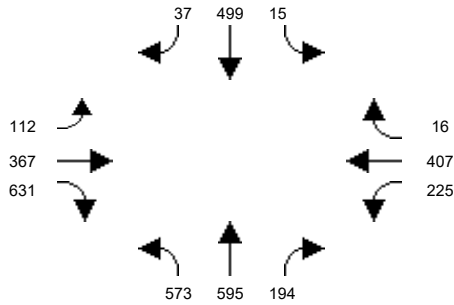

Intersection #72: Glassell St and SR-22 WB Ramps

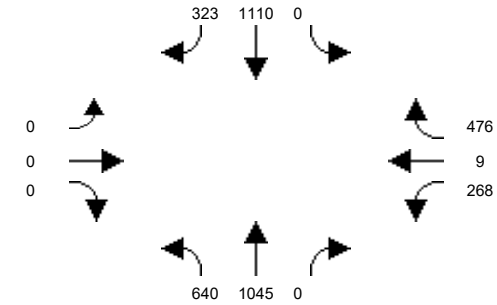

Intersection #73: Grand Ave / Glassell St and SR-22 EB Ramps

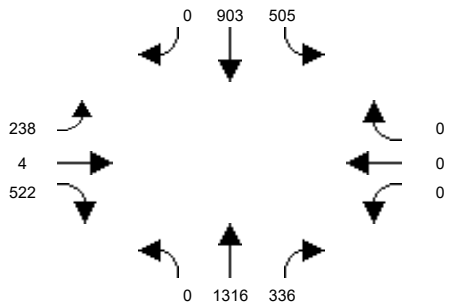

Intersection #74: Grand Ave and Fairhaven Ave

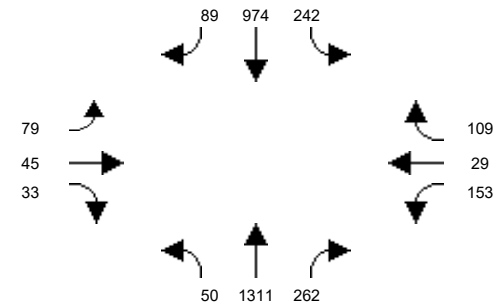

Intersection #75: Grand Ave and Santa Clara Ave

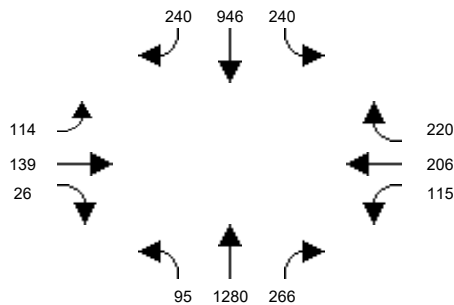

Intersection #76: Grand Ave and 17th St

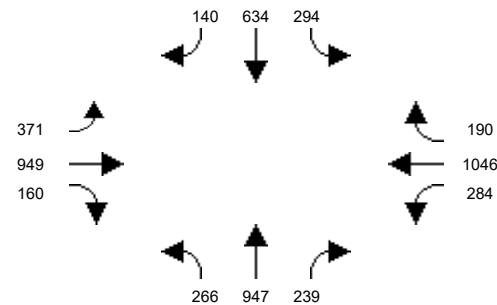

Intersection #77: Grand Ave and I-5 NB Ramps

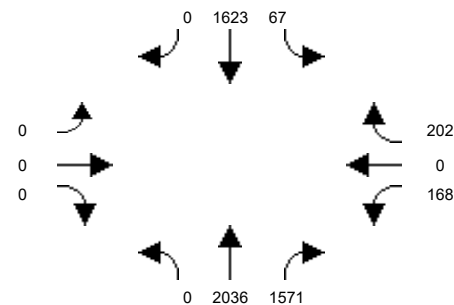

Intersection #78: Grand Ave and Santa Ana Blvd

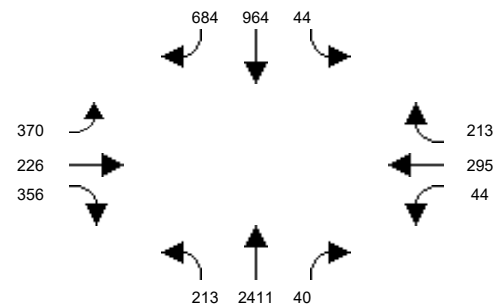

Intersection #79: Grand Ave and 1st St

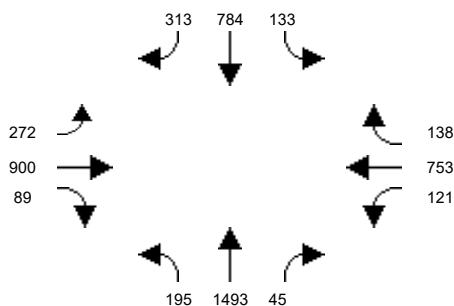

Intersection #80: Grand Ave and Chestnut Ave

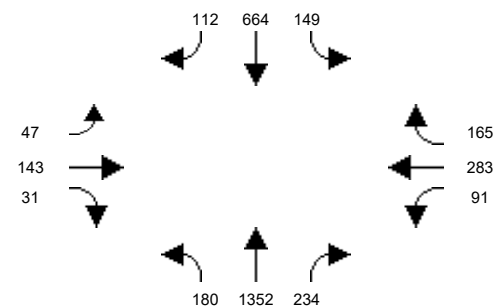

Santa Ana Circulation Element

Intersection Graphic Report
Entered Volume (Base Alternative)
2045 WP PM Peak Hour

Intersection #81: Grand Ave and McFadden Ave

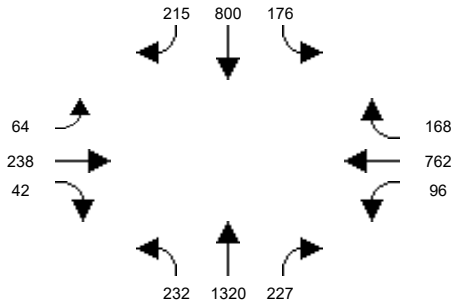

Intersection #82: Grand Ave and Edinger Ave

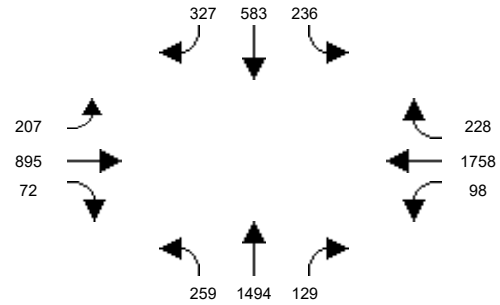

Intersection #83: Grand Ave and Warner Ave

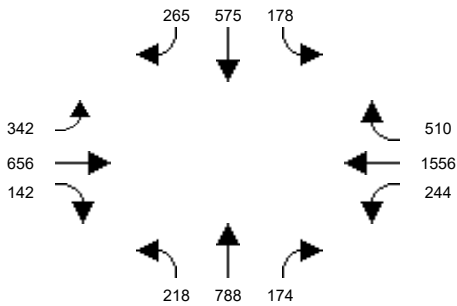

Intersection #84: SR-55 NB Ramps and Dyer Rd

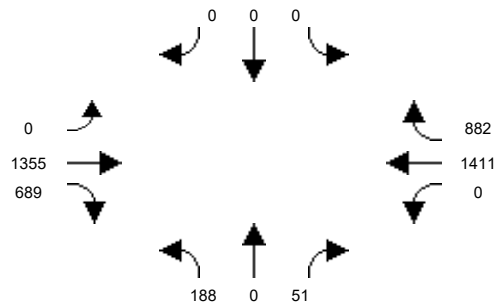

Intersection #85: Cambridge St and La Veta Ave

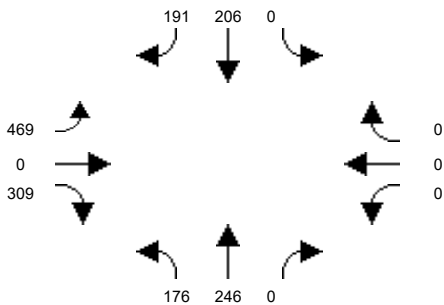

Intersection #86: Cambridge St and Fairhaven Ave

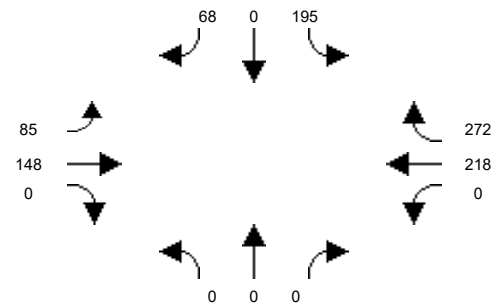

Intersection #87: Mabury St and 1st Street

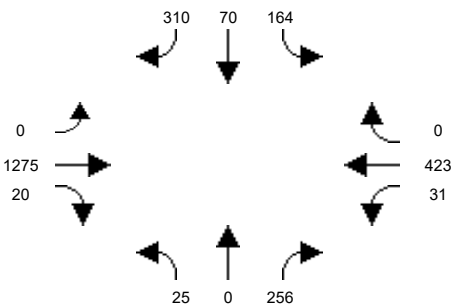

Intersection #88: Tustin St and La Veta Ave

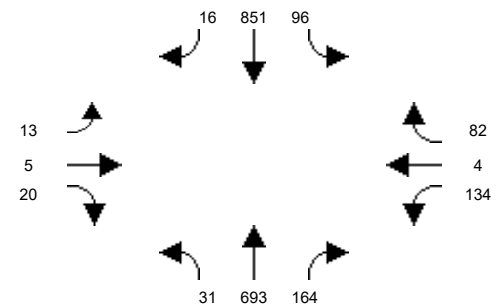

Intersection #89: Tustin St and SR-22 WB On-Ramp

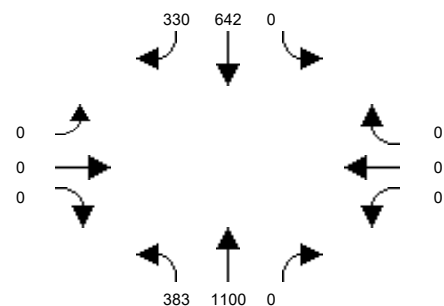

Intersection #90: Tustin St and SR-22 EB Off-Ramp / Seba Ave

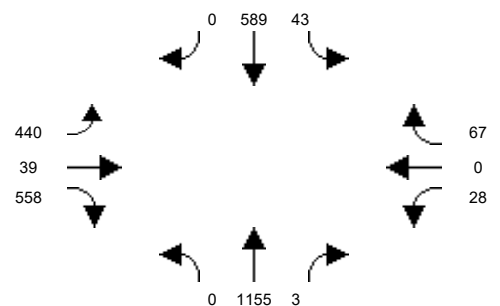

Santa Ana Circulation Element

Intersection Graphic Report
Entered Volume (Base Alternative)
2045 WP PM Peak Hour

Intersection #91: Tustin Ave and Fairhaven Ave

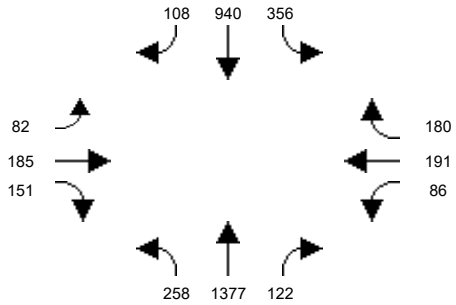

Intersection #92: Tustin Ave and Santa Clara Ave

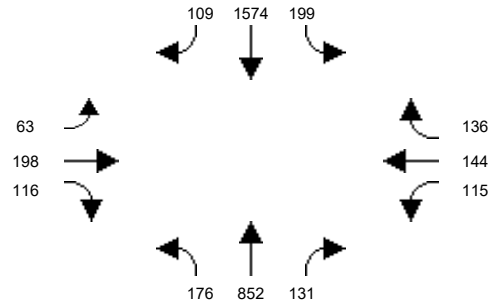

Intersection #93: Tustin Ave and 17th St

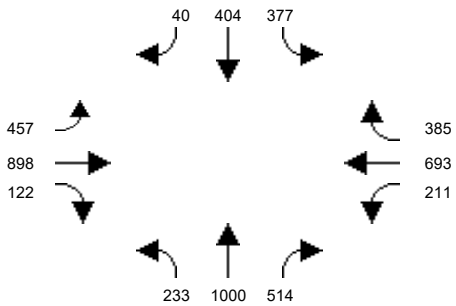

Intersection #94: Tustin Ave and 4th St

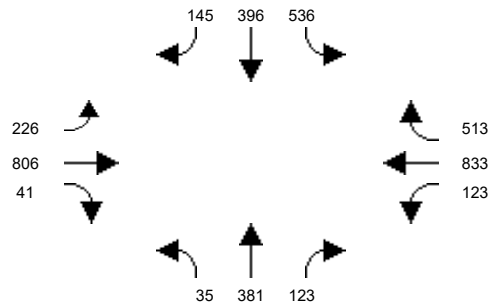

Intersection #95: SR-55 SB Ramps / Auto Mall Dr and Edinger Ave

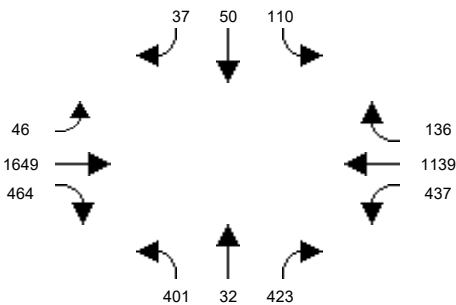

Intersection #96: SR-55 NB Ramps / Del Amo Ave and Newport Avenue

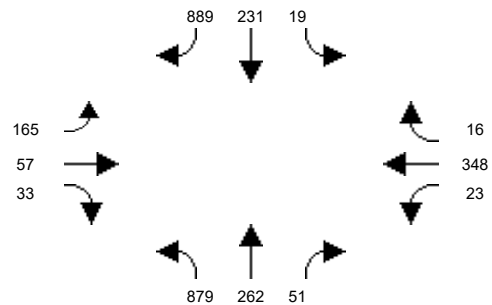

Intersection #97: Red Hill Ave and Edinger Ave

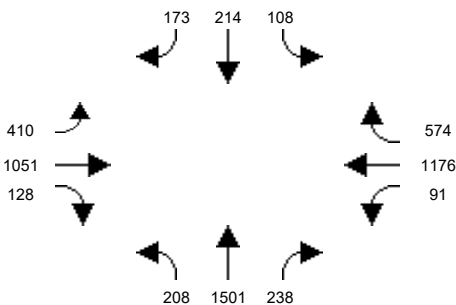

Intersection #98: Red Hill Ave and Warner Ave

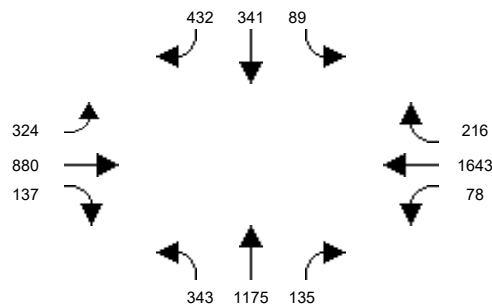

Intersection #99: Red Hill Ave and Dyer Rd / barranca Pkwy

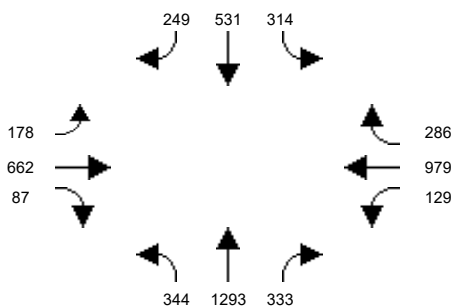

Intersection #100: Red Hill Ave and Alton Pkwy

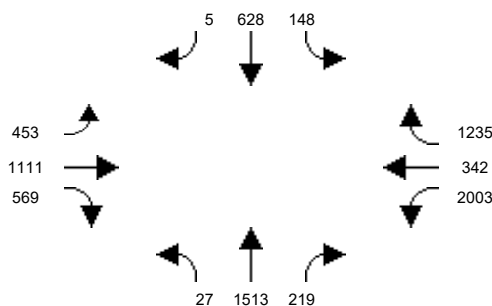

Santa Ana Circulation Element

Intersection Graphic Report
Entered Volume (Base Alternative)
2045 WP PM Peak Hour

Intersection #101: Red Hill Ave and MacArthur Blvd

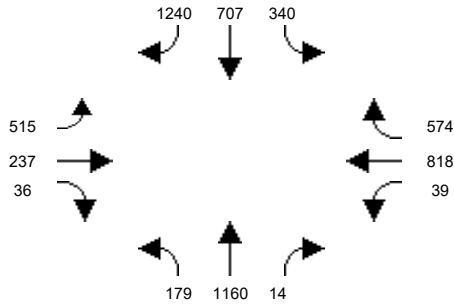

Intersection #102: Red Hill Ave and Main St

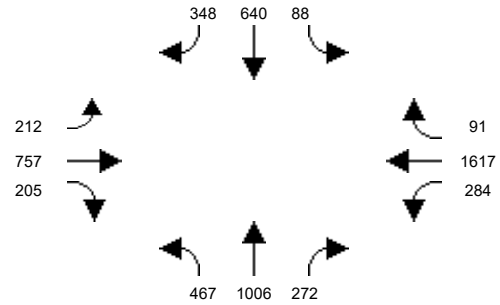

Intersection #103: I-5 SB Ramps and Santa Ana Blvd

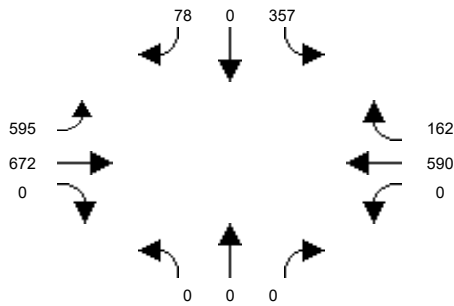

Intersection #104: Tustin Ranch Rd and Warner Ave

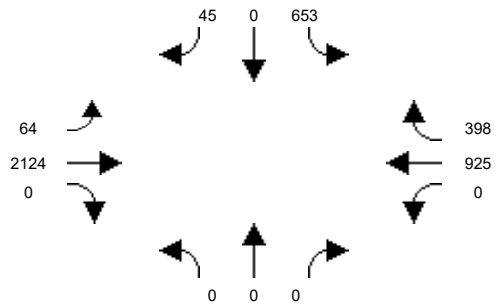

Intersection #105: Von Karman Ave and Barranca Pkwy

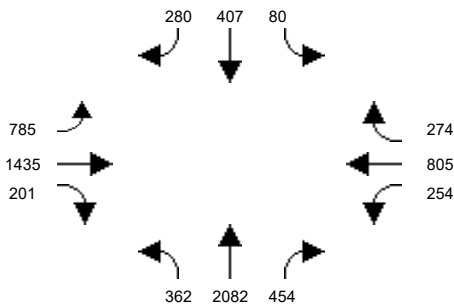

Intersection #106: Red Hill Avenue and El Camino Real

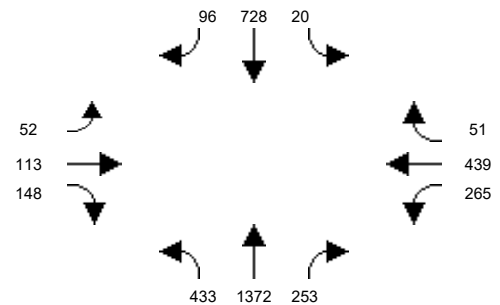

Intersection #107: Red Hill Avenue and I-5 NB Ramps

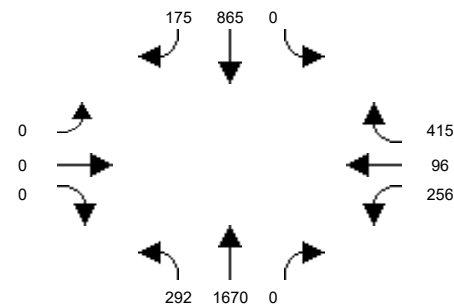

Intersection #108: Red Hill Avenue and I-5 SB Ramps

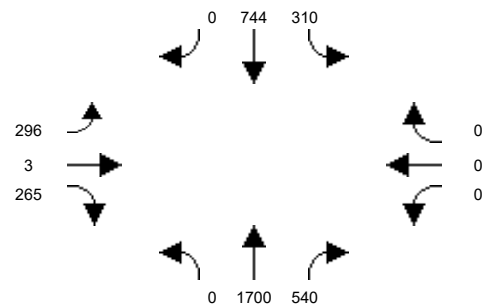

Intersection #109: Red Hill Avenue and Nisson Road

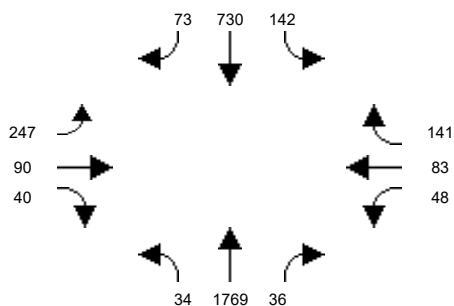

Intersection #110: Red Hill Avenue and Walnut Avenue

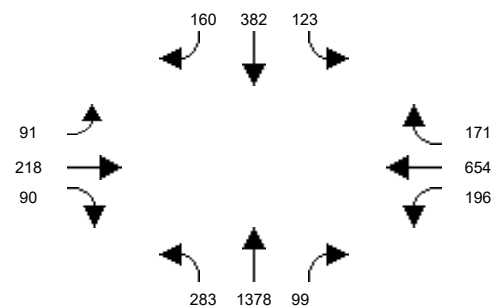

Santa Ana Circulation Element

Intersection Graphic Report
Entered Volume (Base Alternative)
2045 WP PM Peak Hour

Intersection #111: Red Hill Avenue and Valencia Avenue

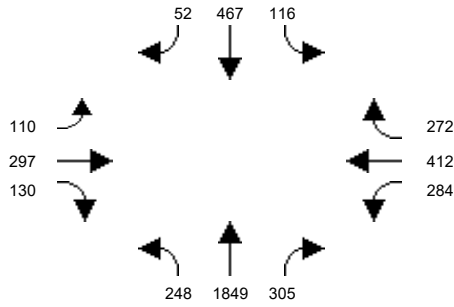

Intersection #112: Tustin Ranch Road and Warner Avenue North

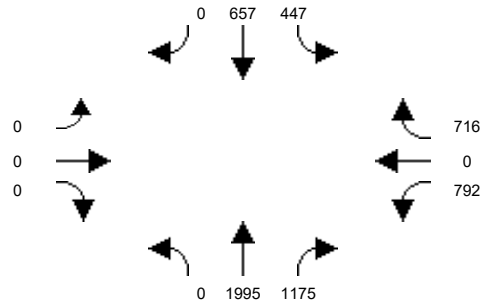

Intersection #113: Tustin Ranch Road and Walnut Avenue

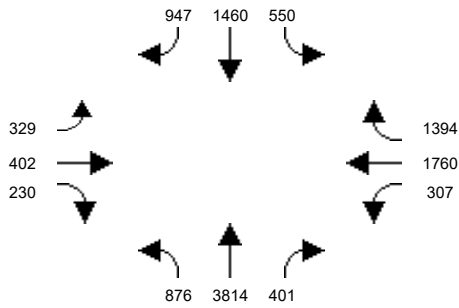

Intersection #114: SR-55 SB Ramps and Irvine Boulevard

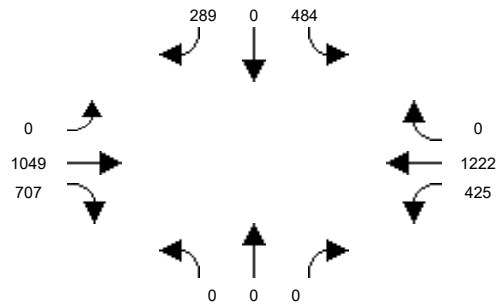

Intersection #115: SR-55 NB Ramps and Irvine Boulevard

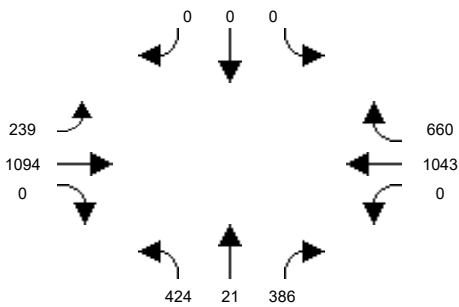

APPENDIX C

OCTAM VOLUME PLOTS

OCTAM 5.0 - Year 2016 Daily Forecasts
Volumes in Thousands
Raw Volumes - Not For Distribution

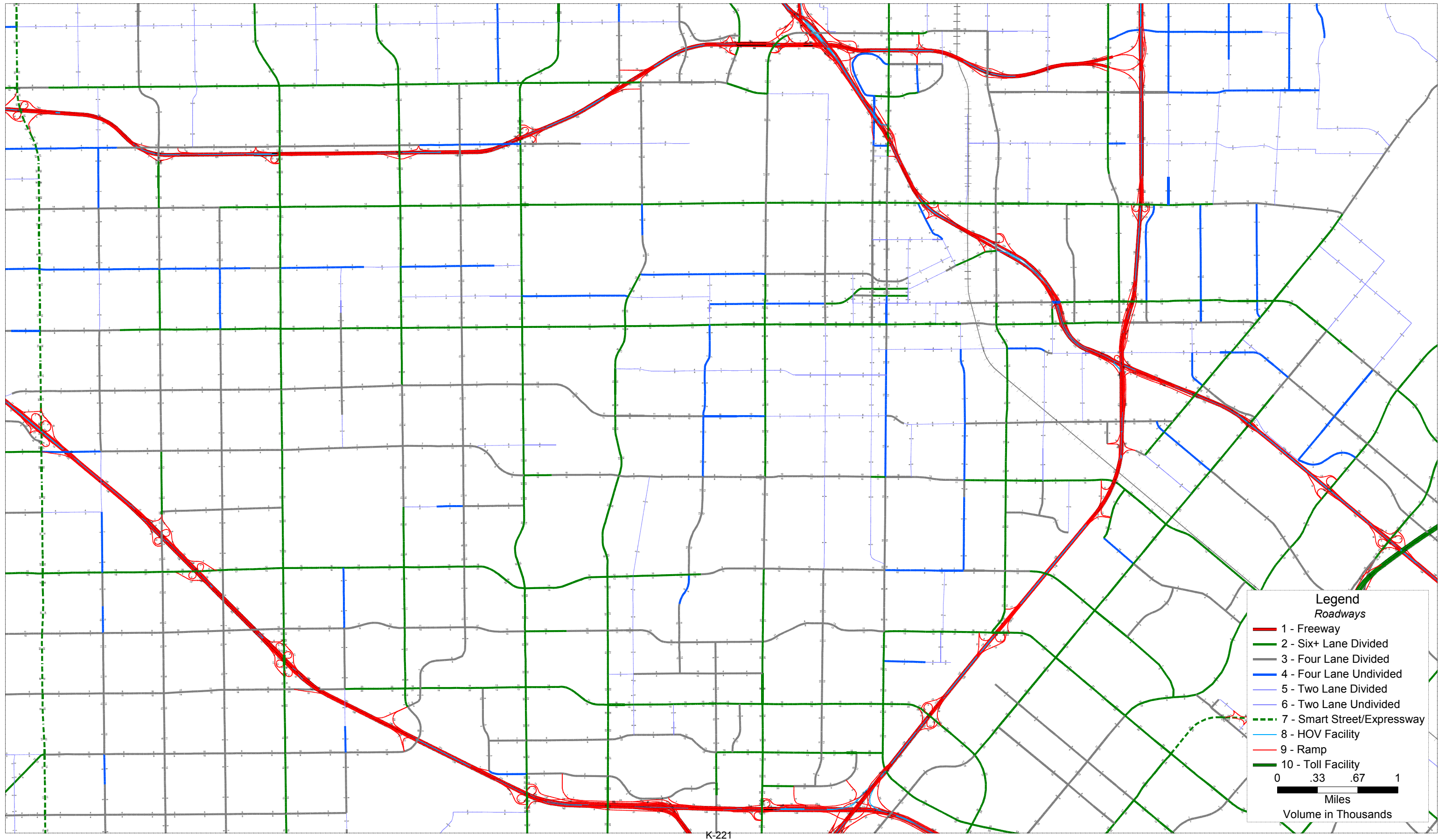

OCTAM 5.0 - Year 2016 AM Peak Period Forecasts
Volumes in Thousands
Raw Volumes - Not For Distribution

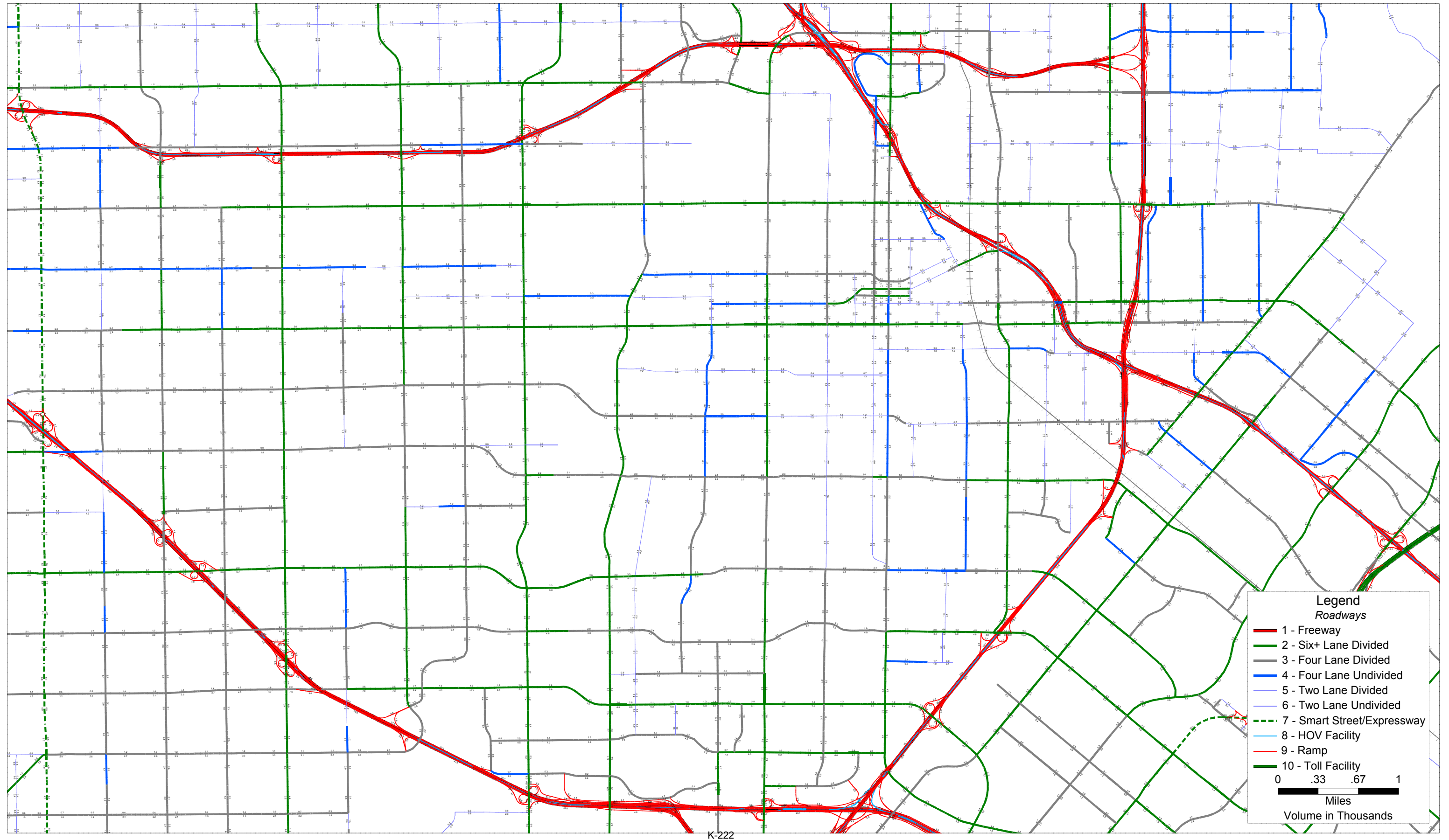

K-222

OCTAM 5.0 - Year 2016 PM Peak Period Forecasts
Volumes in Thousands
Raw Volumes - Not For Distribution

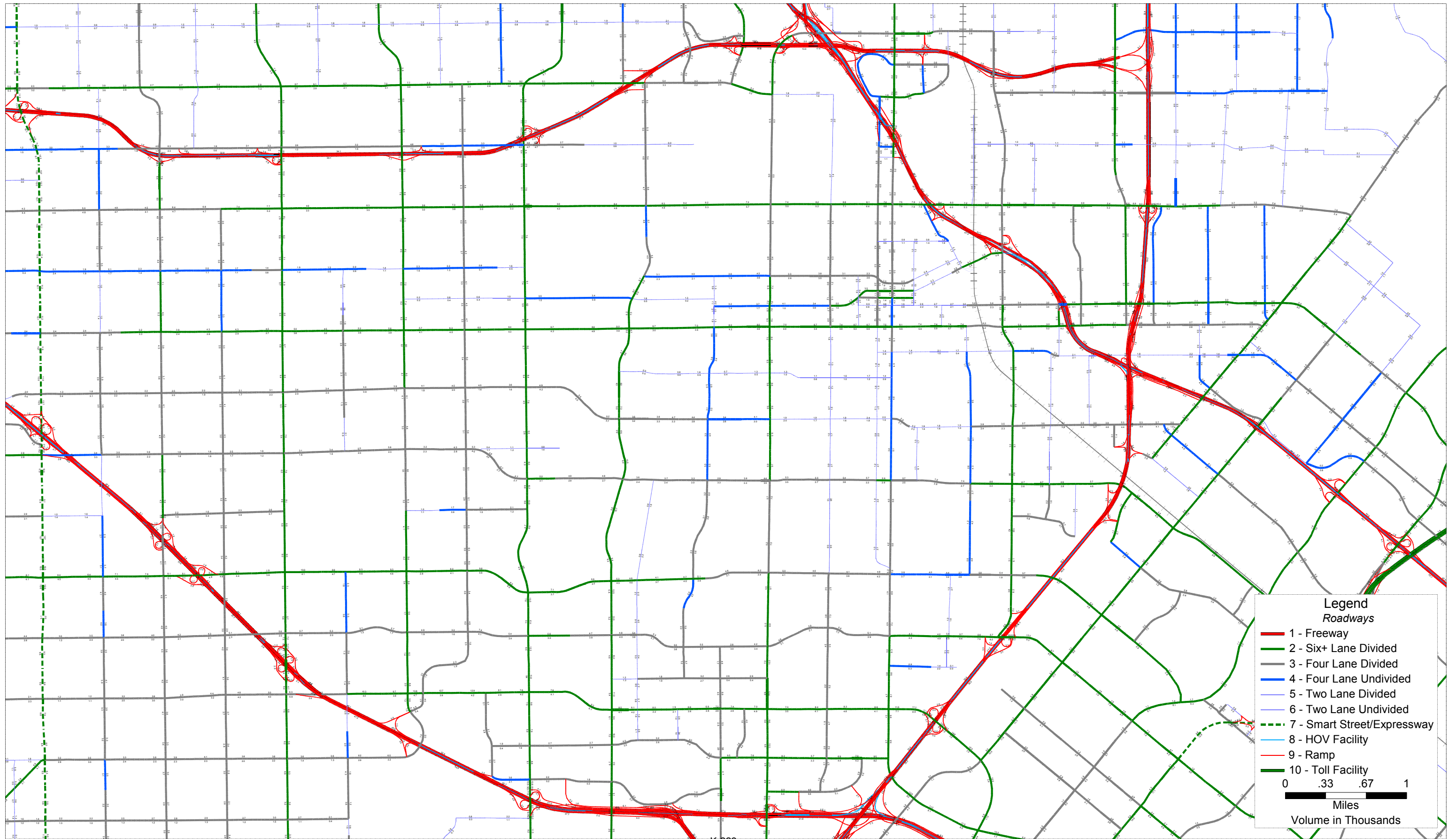

OCTAM 5.0 - Year 2045 SACE Baseline Daily Forecasts
Volumes in Thousands
Raw Volumes - Not For Distribution

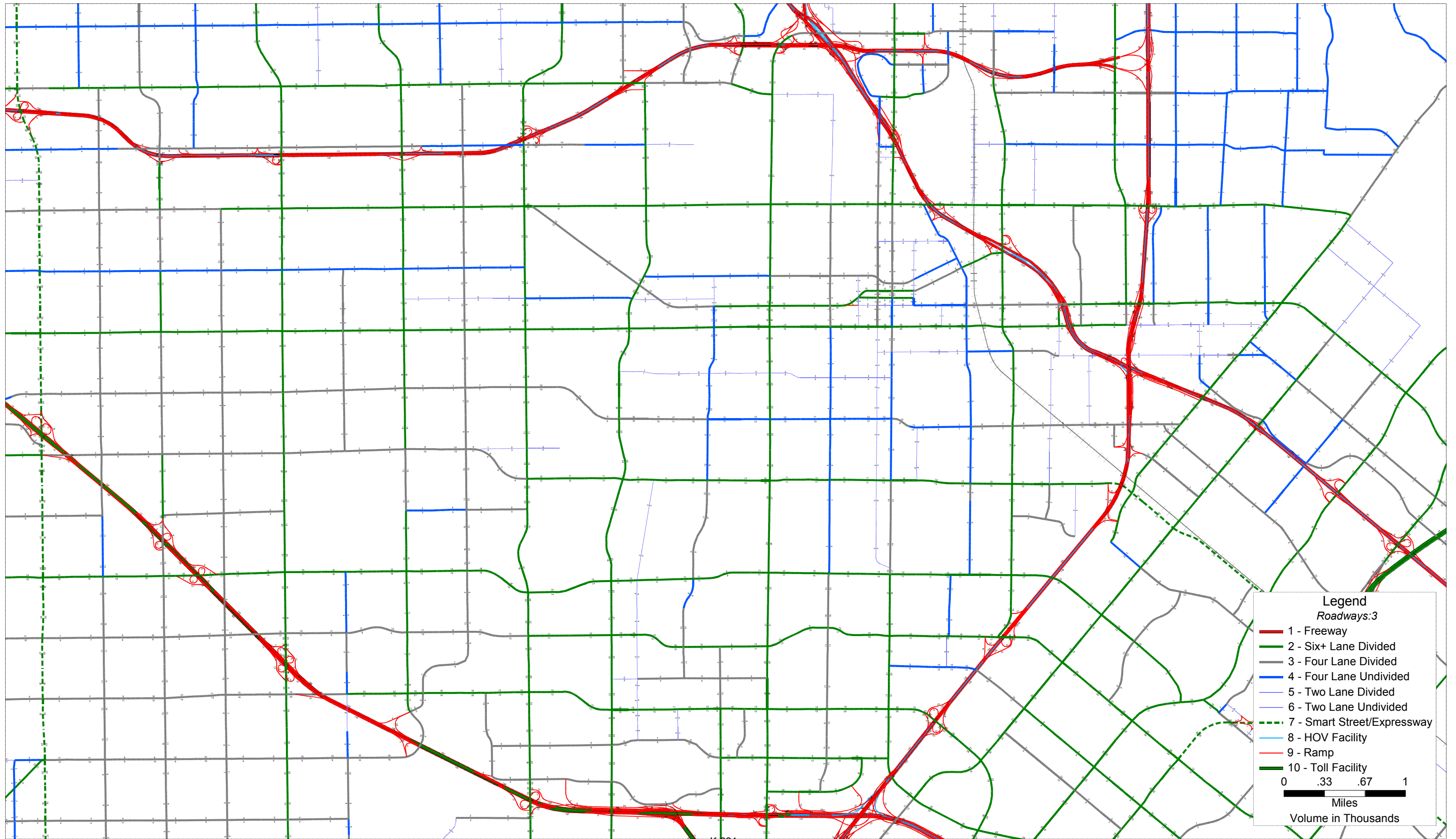

Legend
Roadways:3

- 1 - Freeway
- 2 - Six+ Lane Divided
- 3 - Four Lane Divided
- 4 - Four Lane Undivided
- 5 - Two Lane Divided
- 6 - Two Lane Undivided
- 7 - Smart Street/Expressway
- 8 - HOV Facility
- 9 - Ramp
- 10 - Toll Facility

0 .33 .67 1
Miles
Volume in Thousands

OCTAM 5.0 - Year 2045 SACE Baseline AM Peak Period Forecasts

Volumes in Thousands

Raw Volumes - Not For Distribution

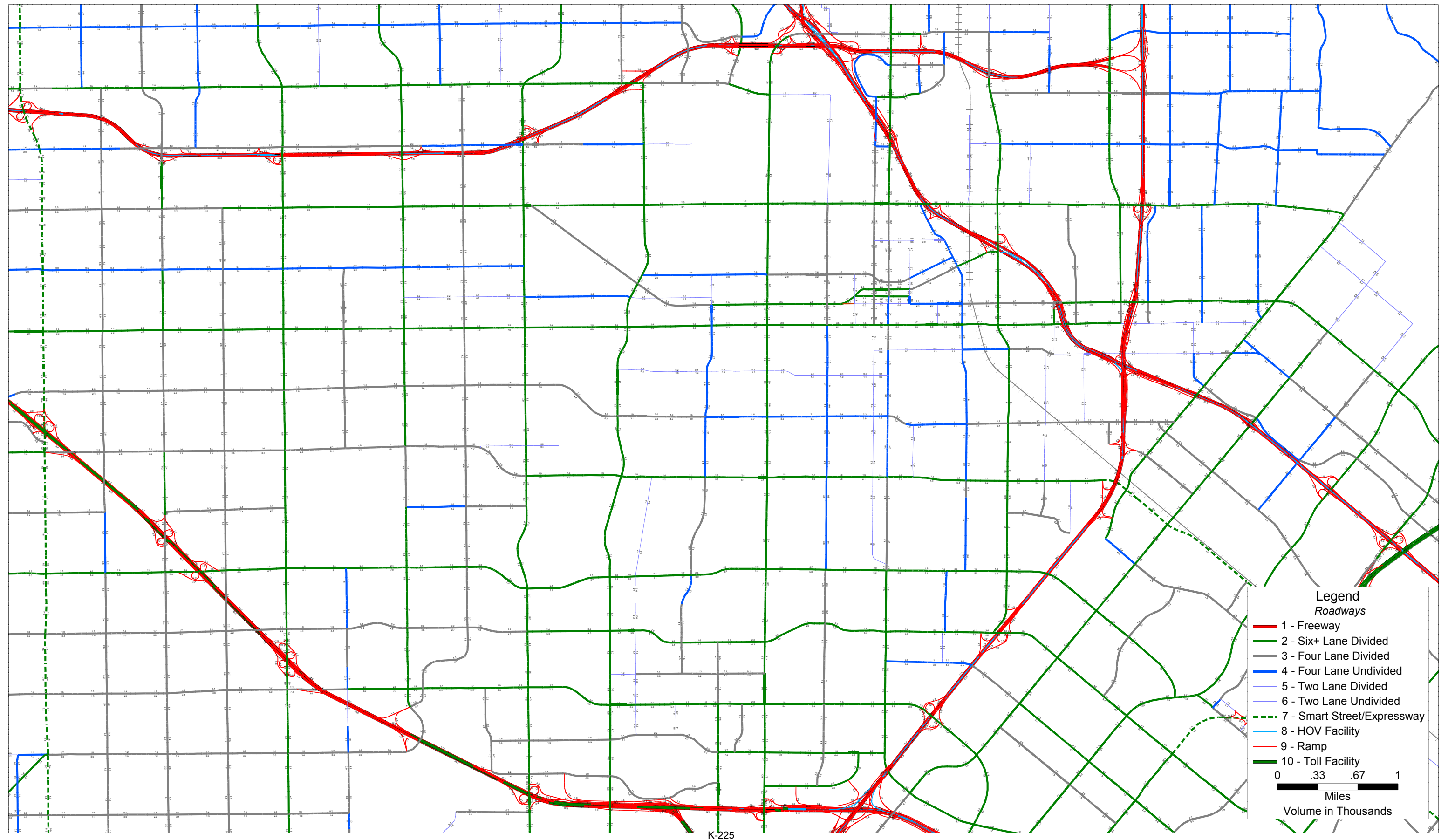

K-225

OCTAM 5.0 - Year 2045 SACE Baseline PM Peak Period Forecasts

Volumes in Thousands

Raw Volumes - Not For Distribution

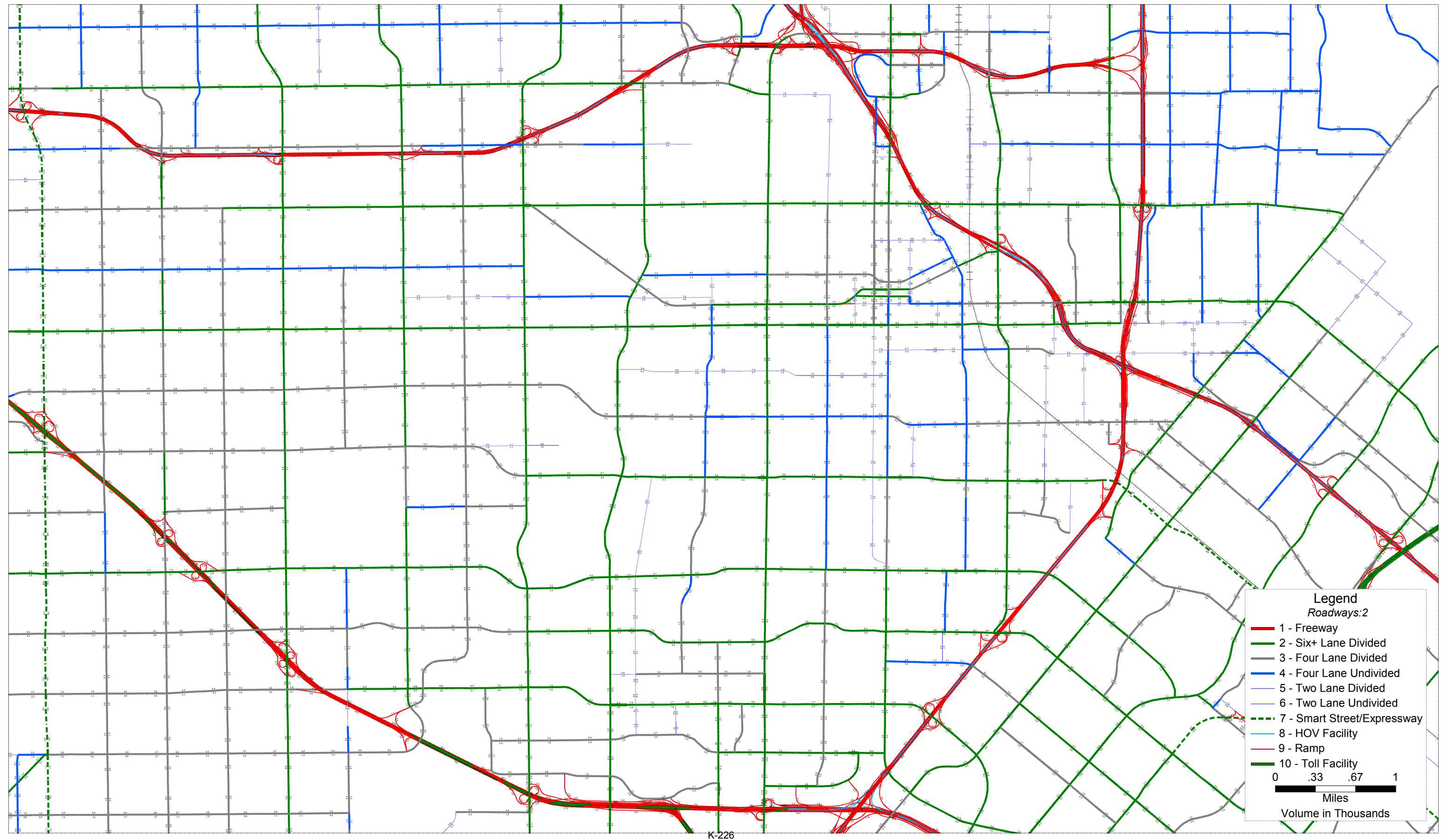

APPENDIX D

ANALYSIS WORKSHEETS

APPENDIX D.1
ANALYSIS WORKSHEETS –
2020 NP (AM Peak Hour)

Santa Ana Circulation Element

Scenario Report

Scenario: 2020 NP AM Peak Hour

Command: Default Command

Volume: 2020 NP AM

Geometry: NP

Impact Fee: Default Impact Fee

Trip Generation: Default Trip Generation

Trip Distribution: Default Trip Distribution

Paths: Default Path

Routes: Default Route

Configuration: Default Configuration

 Santa Ana Circulation Element

 Impact Analysis Report
 Level Of Service

Intersection	Base		Future		Change in
	Del/	V/	Del/	V/	
	LOS	Veh C	LOS	Veh C	
# 1 Euclid St and 1st St	D	xxxxxx 0.849	D	xxxxxx 0.849	+ 0.000 V/C
# 2 Euclid St and McFadden Ave	E	xxxxxx 0.909	E	xxxxxx 0.909	+ 0.000 V/C
# 3 Euclid St and Edinger Ave	D	xxxxxx 0.861	D	xxxxxx 0.861	+ 0.000 V/C
# 4 Newhope St and Hazard Ave	C	xxxxxx 0.709	C	xxxxxx 0.709	+ 0.000 V/C
# 5 Newhope St and McFadden Ave	D	xxxxxx 0.828	D	xxxxxx 0.828	+ 0.000 V/C
# 6 Harbor Blvd and SR-22 WB Off-R	C	27.4 0.695	C	27.4 0.695	+ 0.000 D/V
# 7 Trask Avenue and SR-22 EB On-R	B	11.5 0.457	B	11.5 0.457	+ 0.000 D/V
# 8 Harbor Blvd and Westminster Av	D	xxxxxx 0.820	D	xxxxxx 0.820	+ 0.000 V/C
# 9 Harbor Blvd and 1st St	D	xxxxxx 0.807	D	xxxxxx 0.807	+ 0.000 V/C
# 10 Harbor Blvd and McFadden Ave	C	xxxxxx 0.791	C	xxxxxx 0.791	+ 0.000 V/C
# 11 Harbor Blvd and Edinger Ave	C	xxxxxx 0.766	C	xxxxxx 0.766	+ 0.000 V/C
# 12 Harbor Blvd and Warner Ave	D	xxxxxx 0.808	D	xxxxxx 0.808	+ 0.000 V/C
# 13 Harbor Blvd and Segerstrom Ave	E	xxxxxx 0.978	E	xxxxxx 0.978	+ 0.000 V/C
# 14 MacArthur Blvd and Hyland Ave	B	xxxxxx 0.608	B	xxxxxx 0.608	+ 0.000 V/C
# 15 MacArthur Blvd and Harbor Blvd	C	xxxxxx 0.754	C	xxxxxx 0.754	+ 0.000 V/C
# 16 Harbor Blvd and Sunflower Ave	C	xxxxxx 0.702	C	xxxxxx 0.702	+ 0.000 V/C
# 17 Harbor Blvd and I-405 WB Off-R	B	19.7 0.695	B	19.7 0.695	+ 0.000 D/V
# 18 Harbor Blvd and I-405 EB Off-R	B	13.2 0.524	B	13.2 0.524	+ 0.000 D/V
# 19 Fairview St and Civic Center D	B	xxxxxx 0.667	B	xxxxxx 0.667	+ 0.000 V/C
# 20 Fairview St and 1st St	D	xxxxxx 0.872	D	xxxxxx 0.872	+ 0.000 V/C
# 21 Fairview St and McFadden Ave	C	xxxxxx 0.786	C	xxxxxx 0.786	+ 0.000 V/C
# 22 Fairview St and Edinger Ave	C	xxxxxx 0.753	C	xxxxxx 0.753	+ 0.000 V/C
# 23 Fairview St and Warner Ave	D	xxxxxx 0.850	D	xxxxxx 0.850	+ 0.000 V/C
# 24 Fairview St and MacArthur Blvd	C	xxxxxx 0.704	C	xxxxxx 0.704	+ 0.000 V/C

 Santa Ana Circulation Element

Intersection	Base		Future		Change in
	Del/ LOS	V/ Veh C	Del/ LOS	V/ Veh C	
# 25 Fairview Rd and Sunflower Ave	C	xxxxxx 0.705	C	xxxxxx 0.705	+ 0.000 V/C
# 26 Greenville St and Edinger Ave	A	xxxxxx 0.563	A	xxxxxx 0.563	+ 0.000 V/C
# 27 Greenville St and Segerstrom A	C	xxxxxx 0.727	C	xxxxxx 0.727	+ 0.000 V/C
# 28 Raitt St and McFadden Ave	C	xxxxxx 0.715	C	xxxxxx 0.715	+ 0.000 V/C
# 29 Raitt St and Edinger Ave	D	xxxxxx 0.851	D	xxxxxx 0.851	+ 0.000 V/C
# 30 Bear St and MacArthur Blvd	C	xxxxxx 0.737	C	xxxxxx 0.737	+ 0.000 V/C
# 31 Bristol St and 17th St	C	xxxxxx 0.725	C	xxxxxx 0.725	+ 0.000 V/C
# 32 Bristol St and Civic Center Dr	D	xxxxxx 0.827	D	xxxxxx 0.827	+ 0.000 V/C
# 33 Bristol St and Santa Ana Blvd	B	xxxxxx 0.669	B	xxxxxx 0.669	+ 0.000 V/C
# 34 Bristol St and 1st St	C	xxxxxx 0.745	C	xxxxxx 0.745	+ 0.000 V/C
# 35 Bristol St and McFadden Ave	C	xxxxxx 0.749	C	xxxxxx 0.749	+ 0.000 V/C
# 36 Bristol St and Warner Ave	C	xxxxxx 0.767	C	xxxxxx 0.767	+ 0.000 V/C
# 37 Bristol St and Segerstrom Ave	C	xxxxxx 0.794	C	xxxxxx 0.794	+ 0.000 V/C
# 38 Bristol St and Alton Ave	A	xxxxxx 0.556	A	xxxxxx 0.556	+ 0.000 V/C
# 39 Bristol St and MacArthur Blvd	C	xxxxxx 0.738	C	xxxxxx 0.738	+ 0.000 V/C
# 40 Bristol St and Sunflower Ave	B	xxxxxx 0.635	B	xxxxxx 0.635	+ 0.000 V/C
# 41 Bristol St and I-405 WB Ramps	B	19.1 0.500	B	19.1 0.500	+ 0.000 D/V
# 42 Bristol St and I-405 EB Ramps	C	22.3 0.607	C	22.3 0.607	+ 0.000 D/V
# 43 Flower St and Santa Ana Blvd	A	xxxxxx 0.596	A	xxxxxx 0.596	+ 0.000 V/C
# 44 Flower St and 1st St	C	xxxxxx 0.795	C	xxxxxx 0.795	+ 0.000 V/C
# 45 Flower St and McFadden Ave	D	xxxxxx 0.819	D	xxxxxx 0.819	+ 0.000 V/C
# 46 Flower St and Segerstrom Ave	C	xxxxxx 0.769	C	xxxxxx 0.769	+ 0.000 V/C
# 47 Flower St and MacArthur Blvd	B	xxxxxx 0.698	B	xxxxxx 0.698	+ 0.000 V/C
# 48 Main St and La Veta Ave	A	xxxxxx 0.574	A	xxxxxx 0.574	+ 0.000 V/C
# 49 Main St and Mainplace Dr / Mem	A	xxxxxx 0.485	A	xxxxxx 0.485	+ 0.000 V/C
# 50 Main St and 17th St	D	xxxxxx 0.821	D	xxxxxx 0.821	+ 0.000 V/C

Traffix 8.0.0715 (c) 2008 Dowling Assoc. Licensed to IBI GROUP, IRVINE, CA

 Santa Ana Circulation Element

Intersection	Base		Future		Change in	
	Del/ LOS	V/ Veh C	Del/ LOS	V/ Veh C		
# 51 Main St and Civic Center Dr	C	xxxxxx 0.755	C	xxxxxx 0.755	+ 0.000	V/C
# 52 Main St and Santa Ana Blvd	B	xxxxxx 0.667	B	xxxxxx 0.667	+ 0.000	V/C
# 53 Main St and 4th St	A	xxxxxx 0.490	A	xxxxxx 0.490	+ 0.000	V/C
# 54 Main St and 1st St	C	xxxxxx 0.758	C	xxxxxx 0.758	+ 0.000	V/C
# 55 Main St and McFadden Ave	E	xxxxxx 0.902	E	xxxxxx 0.902	+ 0.000	V/C
# 56 Main St and Edinger Ave	D	xxxxxx 0.826	D	xxxxxx 0.826	+ 0.000	V/C
# 57 Main St and MacArthur Blvd	C	xxxxxx 0.735	C	xxxxxx 0.735	+ 0.000	V/C
# 58 Penn Wy and 17th St	B	11.2 0.602	B	11.2 0.602	+ 0.000	D/V
# 59 I-5 NB Off Ramps/17th Street	C	31.2 0.740	C	31.2 0.740	+ 0.000	D/V
# 60 Penn Wy and I-5 SB Ramps	B	19.0 0.436	B	19.0 0.436	+ 0.000	D/V
# 61 Santiago St and Civic Center D	C	16.9 0.723	C	16.9 0.723	+ 0.000	V/C
# 62 Santiago St and Santa Ana Blvd	A	xxxxxx 0.553	A	xxxxxx 0.553	+ 0.000	V/C
# 64 Standard Ave and 1st St	D	xxxxxx 0.803	D	xxxxxx 0.803	+ 0.000	V/C
# 65 Standard Ave and Mcfadden Ave	B	xxxxxx 0.609	B	xxxxxx 0.609	+ 0.000	V/C
# 66 Halladay St and Warner Ave	B	xxxxxx 0.659	B	xxxxxx 0.659	+ 0.000	V/C
# 67 Halladay St and Dyer Rd	A	xxxxxx 0.567	A	xxxxxx 0.567	+ 0.000	V/C
# 68 SR-55 SB Ramps and MacArthur B	B	19.8 0.615	B	19.8 0.615	+ 0.000	D/V
# 69 SR-55 NB Ramps and MacArthur B	B	19.2 0.742	B	19.2 0.742	+ 0.000	D/V
# 70 SR-55 SB Ramps and Dyer Rd	C	23.7 0.552	C	23.7 0.552	+ 0.000	D/V
# 71 Glassell St and La Veta Ave	B	xxxxxx 0.603	B	xxxxxx 0.603	+ 0.000	V/C
# 72 Glassell St and SR-22 WB Ramps	C	28.5 0.741	C	28.5 0.741	+ 0.000	D/V
# 73 Grand Ave / Glassell St and SR	C	27.0 0.760	C	27.0 0.760	+ 0.000	D/V
# 74 Grand Ave and Fairhaven Ave	B	xxxxxx 0.680	B	xxxxxx 0.680	+ 0.000	V/C
# 75 Grand Ave and Santa Clara Ave	D	xxxxxx 0.885	D	xxxxxx 0.885	+ 0.000	V/C
# 76 Grand Ave and 17th St	C	xxxxxx 0.797	C	xxxxxx 0.797	+ 0.000	V/C

 Santa Ana Circulation Element

Intersection	Base			Future			Change in
	Del/ LOS	V/ Veh	C	Del/ LOS	V/ Veh	C	
# 77 Grand Ave and I-5 NB Ramps	B	12.9	0.516	B	12.9	0.516	+ 0.000 D/V
# 78 Grand Ave and Santa Ana Blvd	C	23.8	0.662	C	23.8	0.662	+ 0.000 D/V
# 79 Grand Ave and 1st St	D	xxxxx	0.803	D	xxxxx	0.803	+ 0.000 V/C
# 80 Grand Ave and Chestnut Ave	C	xxxxx	0.705	C	xxxxx	0.705	+ 0.000 V/C
# 81 Grand Ave and McFadden Ave	D	xxxxx	0.829	D	xxxxx	0.829	+ 0.000 V/C
# 82 Grand Ave and Edinger Ave	C	xxxxx	0.763	C	xxxxx	0.763	+ 0.000 V/C
# 83 Grand Ave and Warner Ave	A	xxxxx	0.528	A	xxxxx	0.528	+ 0.000 V/C
# 84 SR-55 NB Ramps and Dyer Rd	B	16.3	0.530	B	16.3	0.530	+ 0.000 D/V
# 85 Cambridge St and La Veta Ave	C	17.3	0.799	C	17.3	0.799	+ 0.000 V/C
# 86 Cambridge St and Fairhaven Ave	A	xxxxx	0.559	A	xxxxx	0.559	+ 0.000 V/C
# 87 Mabury St and 1st Street	C	28.3	0.691	C	28.3	0.691	+ 0.000 D/V
# 88 Tustin St and La Veta Ave	A	xxxxx	0.521	A	xxxxx	0.521	+ 0.000 V/C
# 89 Tustin St and SR-22 WB On-Ramp	B	12.9	0.734	B	12.9	0.734	+ 0.000 D/V
# 90 Tustin St and SR-22 EB Off-Ram	C	24.2	0.731	C	24.2	0.731	+ 0.000 D/V
# 91 Tustin Ave and Fairhaven Ave	E	xxxxx	0.977	E	xxxxx	0.977	+ 0.000 V/C
# 92 Tustin Ave and Santa Clara Ave	D	xxxxx	0.866	D	xxxxx	0.866	+ 0.000 V/C
# 93 Tustin Ave and 17th St	C	xxxxx	0.748	C	xxxxx	0.748	+ 0.000 V/C
# 94 Tustin Ave and 4th St	C	xxxxx	0.701	C	xxxxx	0.701	+ 0.000 V/C
# 95 SR-55 SB Ramps / Auto Mall Dr	C	24.4	0.558	C	24.4	0.558	+ 0.000 D/V
# 96 SR-55 NB Ramps / Del Amo Ave a	C	24.0	0.463	C	24.0	0.463	+ 0.000 D/V
# 97 Red Hill Ave and Edinger Ave	A	xxxxx	0.569	A	xxxxx	0.569	+ 0.000 V/C
# 98 Red Hill Ave and Warner Ave	A	xxxxx	0.485	A	xxxxx	0.485	+ 0.000 V/C
# 99 Red Hill Ave and Dyer Rd / bar	A	xxxxx	0.575	A	xxxxx	0.575	+ 0.000 V/C
#100 Red Hill Ave and Alton Pkwy	A	xxxxx	0.524	A	xxxxx	0.524	+ 0.000 V/C
#101 Red Hill Ave and MacArthur Blv	B	xxxxx	0.664	B	xxxxx	0.664	+ 0.000 V/C
#102 Red Hill Ave and Main St	B	xxxxx	0.670	B	xxxxx	0.670	+ 0.000 V/C

Traffix 8.0.0715 (c) 2008 Dowling Assoc. Licensed to IBI GROUP, IRVINE, CA

 Santa Ana Circulation Element

Intersection		Base		Future		Change in	
		Del/ LOS	V/ Veh	Del/ LOS	V/ Veh		
#103 I-5 SB Ramps and Santa Ana Blv	B	17.4	0.514	B 17.4	0.514	+ 0.000	D/V
#104 Tustin Ranch Rd and Warner Ave	A	xxxxx	0.475	A xxxxx	0.475	+ 0.000	V/C
#105 Von Karman Ave and Barranca Pk	C	xxxxx	0.762	C xxxxx	0.762	+ 0.000	V/C
#106 Red Hill Avenue and El Camino	C	xxxxx	0.706	C xxxxx	0.706	+ 0.000	V/C
#107 Red Hill Avenue and I-5 NB Ram	C	20.3	0.670	C 20.3	0.670	+ 0.000	D/V
#108 Red Hill Avenue and I-5 SB Ram	C	22.0	0.784	C 22.0	0.784	+ 0.000	D/V
#109 Red Hill Avenue and Nisson Roa	B	xxxxx	0.653	B xxxxx	0.653	+ 0.000	V/C
#110 Red Hill Avenue and Walnut Ave	B	xxxxx	0.684	B xxxxx	0.684	+ 0.000	V/C
#111 Red Hill Avenue and Valencia A	A	xxxxx	0.544	A xxxxx	0.544	+ 0.000	V/C
#112 Tustin Ranch Road and Warner A	A	xxxxx	0.426	A xxxxx	0.426	+ 0.000	V/C
#113 Tustin Ranch Road and Walnut A	F	xxxxx	1.193	F xxxxx	1.193	+ 0.000	V/C
#114 SR-55 SB Ramps and Irvine Boul	C	23.2	0.970	C 23.2	0.970	+ 0.000	D/V
#115 SR-55 NB Ramps and Irvine Boul	B	19.8	0.797	B 19.8	0.797	+ 0.000	D/V

Santa Ana Circulation Element

Level Of Service Computation Report

ICU 1(Loss as Cycle Length %) Method (Base Volume Alternative)

Intersection #1 Euclid St and 1st St

Cycle (sec): 100 Critical Vol./Cap.(X): 0.849
Loss Time (sec): 5 Average Delay (sec/veh): xxxxxx
Optimal Cycle: 65 Level Of Service: D

Table with 4 columns: North Bound, South Bound, East Bound, West Bound. Rows include Movement (L-T-R), Control, Rights, Min. Green, Y+R, and Lanes.

Volume Module table with 12 columns representing different volume categories and 12 rows of adjustment factors.

Saturation Flow Module table with 12 columns and 4 rows of saturation flow data.

Capacity Analysis Module table with 12 columns and 2 rows of capacity analysis data.

Santa Ana Circulation Element

Level Of Service Computation Report

ICU 1(Loss as Cycle Length %) Method (Base Volume Alternative)

Intersection #2 Euclid St and McFadden Ave

Cycle (sec): 100 Critical Vol./Cap.(X): 0.909
 Loss Time (sec): 5 Average Delay (sec/veh): xxxxxx
 Optimal Cycle: 92 Level Of Service: E

Approach:	North Bound			South Bound			East Bound			West Bound		
Movement:	L	T	R	L	T	R	L	T	R	L	T	R
Control:	Protected			Protected			Prot+Permit			Prot+Permit		
Rights:	WideBypass			Include			Include			Include		
Min. Green:	0	0	0	0	0	0	0	0	0	0	0	0
Y+R:	4.0	4.0	4.0	4.0	4.0	4.0	4.0	4.0	4.0	4.0	4.0	4.0
Lanes:	1	0	2	1	0	2	1	0	1	1	0	1

Volume Module:

Base Vol:	145	1100	131	137	1906	158	227	463	287	166	368	140
Growth Adj:	1.00	1.00	1.00	1.00	1.00	1.00	1.00	1.00	1.00	1.00	1.00	1.00
Initial Bse:	145	1100	131	137	1906	158	227	463	287	166	368	140
User Adj:	1.00	1.00	1.00	1.00	1.00	1.00	1.00	1.00	1.00	1.00	1.00	1.00
PHF Adj:	1.00	1.00	1.00	1.00	1.00	1.00	1.00	1.00	1.00	1.00	1.00	1.00
PHF Volume:	145	1100	131	137	1906	158	227	463	287	166	368	140
Reduct Vol:	0	0	0	0	0	0	0	0	0	0	0	0
Reduced Vol:	145	1100	131	137	1906	158	227	463	287	166	368	140
PCE Adj:	1.00	1.00	1.00	1.00	1.00	1.00	1.00	1.00	1.00	1.00	1.00	1.00
MLF Adj:	1.00	1.00	1.00	1.00	1.00	1.00	1.00	1.00	1.00	1.00	1.00	1.00
FinalVolume:	145	1100	131	137	1906	158	227	463	287	166	368	140

Saturation Flow Module:

Sat/Lane:	1600	1600	1600	1600	1600	1600	1600	1600	1600	1600	1600	1600
Adjustment:	1.00	1.05	1.00	1.00	1.05	1.00	1.00	1.05	1.00	1.00	1.04	1.00
Lanes:	1.00	2.68	0.32	1.00	2.77	0.23	1.00	1.23	0.77	1.00	1.45	0.55
Final Sat.:	1600	4489	511	1600	4633	367	1600	2075	1225	1600	2418	882

Capacity Analysis Module:

Vol/Sat:	0.09	0.25	0.26	0.09	0.41	0.43	0.14	0.22	0.23	0.10	0.15	0.16
Crit Moves:	****					****			****	****		

Santa Ana Circulation Element

Level Of Service Computation Report

ICU 1(Loss as Cycle Length %) Method (Base Volume Alternative)

Intersection #3 Euclid St and Edinger Ave

Cycle (sec): 100 Critical Vol./Cap.(X): 0.861
Loss Time (sec): 5 Average Delay (sec/veh): xxxxxx
Optimal Cycle: 69 Level Of Service: D

Table with 4 columns: North Bound, South Bound, East Bound, West Bound. Rows include Movement (L-T-R), Control, Rights, Min. Green, Y+R, and Lanes.

Volume Module table with 12 columns representing different traffic flows and 10 rows of adjustment factors like Growth Adj, PHF Adj, etc.

Saturation Flow Module table with 12 columns and 4 rows showing Sat/Lane, Adjustment, Lanes, and Final Sat.

Capacity Analysis Module table with 12 columns and 2 rows showing Vol/Sat and Crit Moves.

Santa Ana Circulation Element

Level Of Service Computation Report

ICU 1(Loss as Cycle Length %) Method (Base Volume Alternative)

Intersection #4 Newhope St and Hazard Ave

Cycle (sec): 100 Critical Vol./Cap.(X): 0.709
Loss Time (sec): 5 Average Delay (sec/veh): xxxxxx
Optimal Cycle: 38 Level Of Service: C

Table with 4 columns: North Bound, South Bound, East Bound, West Bound. Rows include Movement, Control, Rights, Min. Green, Y+R, and Lanes.

Volume Module: Table with 12 columns representing different traffic movements and 10 rows of adjustment factors like Growth Adj, User Adj, PHF Adj, etc.

Saturation Flow Module: Table with 12 columns and 4 rows showing saturation flow rates and adjustment factors.

Capacity Analysis Module: Table with 12 columns and 2 rows showing Vol/Sat and Crit Moves.

Santa Ana Circulation Element

Level Of Service Computation Report

ICU 1(Loss as Cycle Length %) Method (Base Volume Alternative)

Intersection #5 Newhope St and McFadden Ave

Cycle (sec): 100 Critical Vol./Cap.(X): 0.828
 Loss Time (sec): 5 Average Delay (sec/veh): xxxxxx
 Optimal Cycle: 59 Level Of Service: D

Approach:	North Bound			South Bound			East Bound			West Bound		
Movement:	L	T	R	L	T	R	L	T	R	L	T	R
Control:	Protected			Protected			Prot+Permit			Prot+Permit		
Rights:	Include			Include			Include			Include		
Min. Green:	0	0	0	0	0	0	0	0	0	0	0	0
Y+R:	4.0	4.0	4.0	4.0	4.0	4.0	4.0	4.0	4.0	4.0	4.0	4.0
Lanes:	1	0	1	1	0	1	1	0	1	1	0	1

Volume Module:

Base Vol:	110	491	173	119	1183	110	135	492	160	176	449	100
Growth Adj:	1.00	1.00	1.00	1.00	1.00	1.00	1.00	1.00	1.00	1.00	1.00	1.00
Initial Bse:	110	491	173	119	1183	110	135	492	160	176	449	100
User Adj:	1.00	1.00	1.00	1.00	1.00	1.00	1.00	1.00	1.00	1.00	1.00	1.00
PHF Adj:	1.00	1.00	1.00	1.00	1.00	1.00	1.00	1.00	1.00	1.00	1.00	1.00
PHF Volume:	110	491	173	119	1183	110	135	492	160	176	449	100
Reduct Vol:	0	0	0	0	0	0	0	0	0	0	0	0
Reduced Vol:	110	491	173	119	1183	110	135	492	160	176	449	100
PCE Adj:	1.00	1.00	1.00	1.00	1.00	1.00	1.00	1.00	1.00	1.00	1.00	1.00
MLF Adj:	1.00	1.00	1.00	1.00	1.00	1.00	1.00	1.00	1.00	1.00	1.00	1.00
FinalVolume:	110	491	173	119	1183	110	135	492	160	176	449	100

Saturation Flow Module:

Sat/Lane:	1600	1600	1600	1600	1600	1600	1600	1600	1600	1600	1600	1600
Adjustment:	1.00	1.04	1.00	1.00	1.03	1.00	1.00	1.04	1.00	1.00	1.04	1.00
Lanes:	1.00	1.48	0.52	1.00	1.83	0.17	1.00	1.51	0.49	1.00	1.64	0.36
Final Sat.:	1600	2466	834	1600	3028	272	1600	2515	785	1600	2717	583

Capacity Analysis Module:

Vol/Sat:	0.07	0.20	0.21	0.07	0.39	0.40	0.08	0.20	0.20	0.11	0.17	0.17
Crit Moves:	****					****	****			****		

Santa Ana Circulation Element

Level Of Service Computation Report

2000 HCM Operations Method (Base Volume Alternative)

Intersection #6 Harbor Blvd and SR-22 WB Off-Ramp / Banner Dr

Cycle (sec): 100 Critical Vol./Cap.(X): 0.695
 Loss Time (sec): 5 Average Delay (sec/veh): 27.4
 Optimal Cycle: 38 Level Of Service: C

Approach:	North Bound			South Bound			East Bound			West Bound		
Movement:	L	T	R	L	T	R	L	T	R	L	T	R
Control:	Protected			Protected			Split Phase			Split Phase		
Rights:	Include			Include			Include			Include		
Min. Green:	0	0	0	0	0	0	0	0	0	0	0	0
Y+R:	4.0	4.0	4.0	4.0	4.0	4.0	4.0	4.0	4.0	4.0	4.0	4.0
Lanes:	1	0	3	0	0	2	1	0	0	1	1	0

Volume Module:

Base Vol:	70	1274	0	0	1354	18	74	0	121	836	44	117
Growth Adj:	1.00	1.00	1.00	1.00	1.00	1.00	1.00	1.00	1.00	1.00	1.00	1.00
Initial Bse:	70	1274	0	0	1354	18	74	0	121	836	44	117
User Adj:	1.00	1.00	1.00	1.00	1.00	1.00	1.00	1.00	1.00	1.00	1.00	1.00
PHF Adj:	1.00	1.00	1.00	1.00	1.00	1.00	1.00	1.00	1.00	1.00	1.00	1.00
PHF Volume:	70	1274	0	0	1354	18	74	0	121	836	44	117
Reduct Vol:	0	0	0	0	0	0	0	0	0	0	0	0
Reduced Vol:	70	1274	0	0	1354	18	74	0	121	836	44	117
PCE Adj:	1.00	1.00	1.00	1.00	1.00	1.00	1.00	1.00	1.00	1.00	1.00	1.00
MLF Adj:	1.00	1.00	1.00	1.00	1.00	1.00	1.00	1.00	1.00	1.00	1.00	1.00
FinalVolume:	70	1274	0	0	1354	18	74	0	121	836	44	117

Saturation Flow Module:

Sat/Lane:	1900	1900	1900	1900	1900	1900	1900	1900	1900	1900	1900	1900
Adjustment:	0.95	0.91	1.00	1.00	0.91	0.91	0.90	1.00	0.90	0.96	0.96	0.85
Lanes:	1.00	3.00	0.00	0.00	2.96	0.04	0.38	0.00	0.62	1.90	0.10	1.00
Final Sat.:	1805	5187	0	0	5109	68	648	0	1059	3448	181	1615

Capacity Analysis Module:

Vol/Sat:	0.04	0.25	0.00	0.00	0.27	0.27	0.11	0.00	0.11	0.24	0.24	0.07
Crit Moves:	****			****			****		****	****		
Green/Cycle:	0.06	0.44	0.00	0.00	0.38	0.38	0.16	0.00	0.16	0.35	0.35	0.35
Volume/Cap:	0.70	0.56	0.00	0.00	0.70	0.70	0.70	0.00	0.70	0.70	0.70	0.21
Delay/Veh:	65.4	21.3	0.0	0.0	27.2	27.2	46.8	0.0	46.8	29.7	29.7	23.0
User DelAdj:	1.00	1.00	1.00	1.00	1.00	1.00	1.00	1.00	1.00	1.00	1.00	1.00
AdjDel/Veh:	65.4	21.3	0.0	0.0	27.2	27.2	46.8	0.0	46.8	29.7	29.7	23.0
LOS by Move:	E	C	A	A	C	C	D	A	D	C	C	C
HCM2k85thQ:	6	16	0	0	21	21	11	0	11	19	19	4

 Note: Queue reported is the number of cars per lane.

Santa Ana Circulation Element

Level Of Service Computation Report
 2000 HCM Operations Method (Base Volume Alternative)

 Intersection #7 Trask Avenue and SR-22 EB On-Ramp

Cycle (sec): 100 Critical Vol./Cap.(X): 0.457
 Loss Time (sec): 5 Average Delay (sec/veh): 11.5
 Optimal Cycle: 23 Level Of Service: B

Approach:	North Bound			South Bound			East Bound			West Bound		
Movement:	L	T	R	L	T	R	L	T	R	L	T	R
Control:	Protected			Protected			Protected			Protected		
Rights:	Include			Include			Include			Include		
Min. Green:	0	0	0	0	0	0	0	0	0	0	0	0
Y+R:	4.0	4.0	4.0	4.0	4.0	4.0	4.0	4.0	4.0	4.0	4.0	4.0
Lanes:	0	0	0	0	0	0	2	0	1	0	0	1

Volume Module:	North Bound			South Bound			East Bound			West Bound		
Base Vol:	0	0	0	0	0	0	651	815	0	0	738	138
Growth Adj:	1.00	1.00	1.00	1.00	1.00	1.00	1.00	1.00	1.00	1.00	1.00	1.00
Initial Bse:	0	0	0	0	0	0	651	815	0	0	738	138
User Adj:	1.00	1.00	1.00	1.00	1.00	1.00	1.00	1.00	1.00	1.00	1.00	1.00
PHF Adj:	1.00	1.00	1.00	1.00	1.00	1.00	1.00	1.00	1.00	1.00	1.00	1.00
PHF Volume:	0	0	0	0	0	0	651	815	0	0	738	138
Reduct Vol:	0	0	0	0	0	0	0	0	0	0	0	0
Reduced Vol:	0	0	0	0	0	0	651	815	0	0	738	138
PCE Adj:	1.00	1.00	1.00	1.00	1.00	1.00	1.00	1.00	1.00	1.00	1.00	1.00
MLF Adj:	1.00	1.00	1.00	1.00	1.00	1.00	1.00	1.00	1.00	1.00	1.00	1.00
FinalVolume:	0	0	0	0	0	0	651	815	0	0	738	138

Saturation Flow Module:	North Bound			South Bound			East Bound			West Bound		
Sat/Lane:	1900	1900	1900	1900	1900	1900	1900	1900	1900	1900	1900	1900
Adjustment:	1.00	1.00	1.00	1.00	1.00	1.00	0.92	1.00	1.00	1.00	0.93	0.93
Lanes:	0.00	0.00	0.00	0.00	0.00	0.00	2.00	1.00	0.00	0.00	1.68	0.32
Final Sat.:	0	0	0	0	0	0	3502	1900	0	0	2968	555

Capacity Analysis Module:	North Bound			South Bound			East Bound			West Bound		
Vol/Sat:	0.00	0.00	0.00	0.00	0.00	0.00	0.19	0.43	0.00	0.00	0.25	0.25
Crit Moves:							****				****	
Green/Cycle:	0.00	0.00	0.00	0.00	0.00	0.00	0.41	0.95	0.00	0.00	0.54	0.54
Volume/Cap:	0.00	0.00	0.00	0.00	0.00	0.00	0.46	0.45	0.00	0.00	0.46	0.46
Delay/Veh:	0.0	0.0	0.0	0.0	0.0	0.0	21.9	0.4	0.0	0.0	14.0	14.0
User DelAdj:	1.00	1.00	1.00	1.00	1.00	1.00	1.00	1.00	1.00	1.00	1.00	1.00
AdjDel/Veh:	0.0	0.0	0.0	0.0	0.0	0.0	21.9	0.4	0.0	0.0	14.0	14.0
LOS by Move:	A	A	A	A	A	A	C	A	A	A	B	B
HCM2k85thQ:	0	0	0	0	0	0	12	4	0	0	13	13

 Note: Queue reported is the number of cars per lane.

Santa Ana Circulation Element

Level Of Service Computation Report

ICU 1(Loss as Cycle Length %) Method (Base Volume Alternative)

Intersection #8 Harbor Blvd and Westminster Ave

Cycle (sec): 100 Critical Vol./Cap.(X): 0.820
Loss Time (sec): 5 Average Delay (sec/veh): xxxxxx
Optimal Cycle: 56 Level Of Service: D

Table with 4 columns: North Bound, South Bound, East Bound, West Bound. Rows include Movement, Control, Rights, Min. Green, Y+R, and Lanes.

Volume Module: Table with 12 columns representing different volume categories and their values.

Saturation Flow Module: Table with 12 columns representing saturation flow values for various lanes.

Capacity Analysis Module: Table with 12 columns representing capacity analysis metrics.

Santa Ana Circulation Element

Level Of Service Computation Report

ICU 1(Loss as Cycle Length %) Method (Base Volume Alternative)

Intersection #9 Harbor Blvd and 1st St

Cycle (sec): 100 Critical Vol./Cap.(X): 0.807
 Loss Time (sec): 5 Average Delay (sec/veh): xxxxxx
 Optimal Cycle: 53 Level Of Service: D

Approach:	North Bound			South Bound			East Bound			West Bound														
Movement:	L	T	R	L	T	R	L	T	R	L	T	R												
Control:	Protected			Protected			Protected			Protected														
Rights:	Include			Include			Include			Include														
Min. Green:	0	0	0	0	0	0	0	0	0	0	0	0												
Y+R:	4.0	4.0	4.0	4.0	4.0	4.0	4.0	4.0	4.0	4.0	4.0	4.0												
Lanes:	1	0	3	0	1		1	0	3	0	1		2	0	2	1	0		2	0	2	1	0	

Volume Module:

Base Vol:	117	935	202	227	1914	124	140	932	181	245	621	145
Growth Adj:	1.00	1.00	1.00	1.00	1.00	1.00	1.00	1.00	1.00	1.00	1.00	1.00
Initial Bse:	117	935	202	227	1914	124	140	932	181	245	621	145
User Adj:	1.00	1.00	1.00	1.00	1.00	1.00	1.00	1.00	1.00	1.00	1.00	1.00
PHF Adj:	1.00	1.00	1.00	1.00	1.00	1.00	1.00	1.00	1.00	1.00	1.00	1.00
PHF Volume:	117	935	202	227	1914	124	140	932	181	245	621	145
Reduct Vol:	0	0	0	0	0	0	0	0	0	0	0	0
Reduced Vol:	117	935	202	227	1914	124	140	932	181	245	621	145
PCE Adj:	1.00	1.00	1.00	1.00	1.00	1.00	1.00	1.00	1.00	1.00	1.00	1.00
MLF Adj:	1.00	1.00	1.00	1.00	1.00	1.00	1.00	1.00	1.00	1.00	1.00	1.00
FinalVolume:	117	935	202	227	1914	124	140	932	181	245	621	145

Saturation Flow Module:

Sat/Lane:	1600	1600	1600	1600	1600	1600	1600	1600	1600	1600	1600	1600
Adjustment:	1.00	1.06	1.00	1.00	1.06	1.00	1.00	1.05	1.00	1.00	1.05	1.00
Lanes:	1.00	3.00	1.00	1.00	3.00	1.00	2.00	2.51	0.49	2.00	2.43	0.57
Final Sat.:	1600	5100	1600	1600	5100	1600	3200	4219	781	3200	4091	909

Capacity Analysis Module:

Vol/Sat:	0.07	0.18	0.13	0.14	0.38	0.08	0.04	0.22	0.23	0.08	0.15	0.16
Crit Moves:	****			****					****	****		

Santa Ana Circulation Element

Level Of Service Computation Report

ICU 1(Loss as Cycle Length %) Method (Base Volume Alternative)

Intersection #10 Harbor Blvd and McFadden Ave

Cycle (sec): 100 Critical Vol./Cap.(X): 0.791
 Loss Time (sec): 5 Average Delay (sec/veh): xxxxxx
 Optimal Cycle: 50 Level Of Service: C

Approach:	North Bound			South Bound			East Bound			West Bound		
Movement:	L	T	R	L	T	R	L	T	R	L	T	R
Control:	Protected			Protected			Protected			Protected		
Rights:	Include			Include			Include			Include		
Min. Green:	0	0	0	0	0	0	0	0	0	0	0	0
Y+R:	4.0	4.0	4.0	4.0	4.0	4.0	4.0	4.0	4.0	4.0	4.0	4.0
Lanes:	2	0	3	0	1	0	2	0	2	1	0	1

Volume Module:

Base Vol:	104	1059	101	182	1919	64	167	435	130	190	430	123
Growth Adj:	1.00	1.00	1.00	1.00	1.00	1.00	1.00	1.00	1.00	1.00	1.00	1.00
Initial Bse:	104	1059	101	182	1919	64	167	435	130	190	430	123
User Adj:	1.00	1.00	1.00	1.00	1.00	1.00	1.00	1.00	1.00	1.00	1.00	1.00
PHF Adj:	1.00	1.00	1.00	1.00	1.00	1.00	1.00	1.00	1.00	1.00	1.00	1.00
PHF Volume:	104	1059	101	182	1919	64	167	435	130	190	430	123
Reduct Vol:	0	0	0	0	0	0	0	0	0	0	0	0
Reduced Vol:	104	1059	101	182	1919	64	167	435	130	190	430	123
PCE Adj:	1.00	1.00	1.00	1.00	1.00	1.00	1.00	1.00	1.00	1.00	1.00	1.00
MLF Adj:	1.00	1.00	1.00	1.00	1.00	1.00	1.00	1.00	1.00	1.00	1.00	1.00
FinalVolume:	104	1059	101	182	1919	64	167	435	130	190	430	123

Saturation Flow Module:

Sat/Lane:	1600	1600	1600	1600	1600	1600	1600	1600	1600	1600	1600	1600
Adjustment:	1.00	1.06	1.00	1.00	1.04	1.00	1.00	1.04	1.00	1.00	1.04	1.00
Lanes:	2.00	3.00	1.00	2.00	2.90	0.10	1.00	1.54	0.46	1.00	1.56	0.44
Final Sat.:	3200	5100	1600	3200	4845	155	1600	2564	736	1600	2588	712

Capacity Analysis Module:

Vol/Sat:	0.03	0.21	0.06	0.06	0.40	0.41	0.10	0.17	0.18	0.12	0.17	0.17
Crit Moves:	****					****			****	****		

Santa Ana Circulation Element

Level Of Service Computation Report

ICU 1(Loss as Cycle Length %) Method (Base Volume Alternative)

Intersection #11 Harbor Blvd and Edinger Ave

Cycle (sec): 100 Critical Vol./Cap.(X): 0.766
Loss Time (sec): 5 Average Delay (sec/veh): xxxxxx
Optimal Cycle: 46 Level Of Service: C

Table with 4 columns: North Bound, South Bound, East Bound, West Bound. Rows include Movement (L-T-R), Control (Protected), Rights (Include), Min. Green, Y+R, and Lanes.

Volume Module: Table with 12 columns representing different traffic volumes and adjustment factors like Growth Adj, User Adj, PHF Adj, etc.

Saturation Flow Module: Table with 12 columns showing saturation flow values and adjustment factors for different lane configurations.

Capacity Analysis Module: Table with 12 columns showing capacity analysis metrics like Vol/Sat and Crit Moves.

Santa Ana Circulation Element

Level Of Service Computation Report

ICU 1(Loss as Cycle Length %) Method (Base Volume Alternative)

Intersection #12 Harbor Blvd and Warner Ave

Cycle (sec): 100 Critical Vol./Cap.(X): 0.808
Loss Time (sec): 5 Average Delay (sec/veh): xxxxxx
Optimal Cycle: 54 Level Of Service: D

Table with 4 columns: North Bound, South Bound, East Bound, West Bound. Rows include Movement (L-T-R), Control (Protected), Rights (Include), Min. Green, Y+R, and Lanes.

Volume Module: Table with 12 columns representing different volume categories and their values across the four directions.

Saturation Flow Module: Table with 12 columns representing saturation flow values for various adjustment factors.

Capacity Analysis Module: Table with 12 columns representing capacity analysis values such as Vol/Sat and Crit Moves.

Santa Ana Circulation Element

Level Of Service Computation Report

ICU 1(Loss as Cycle Length %) Method (Base Volume Alternative)

Intersection #13 Harbor Blvd and Segerstrom Ave

Cycle (sec): 100 Critical Vol./Cap.(X): 0.978
 Loss Time (sec): 5 Average Delay (sec/veh): xxxxxx
 Optimal Cycle: 180 Level Of Service: E

Approach:	North Bound			South Bound			East Bound			West Bound		
Movement:	L	T	R	L	T	R	L	T	R	L	T	R
Control:	Protected			Protected			Prot+Permit			Prot+Permit		
Rights:	Include			Include			Include			Include		
Min. Green:	0	0	0	0	0	0	0	0	0	0	0	0
Y+R:	4.0	4.0	4.0	4.0	4.0	4.0	4.0	4.0	4.0	4.0	4.0	4.0
Lanes:	2	0	2	1	0	2	1	0	1	1	0	2

Volume Module:

Base Vol:	111	791	50	171	2299	86	88	737	297	117	362	82
Growth Adj:	1.00	1.00	1.00	1.00	1.00	1.00	1.00	1.00	1.00	1.00	1.00	1.00
Initial Bse:	111	791	50	171	2299	86	88	737	297	117	362	82
User Adj:	1.00	1.00	1.00	1.00	1.00	1.00	1.00	1.00	1.00	1.00	1.00	1.00
PHF Adj:	1.00	1.00	1.00	1.00	1.00	1.00	1.00	1.00	1.00	1.00	1.00	1.00
PHF Volume:	111	791	50	171	2299	86	88	737	297	117	362	82
Reduct Vol:	0	0	0	0	0	0	0	0	0	0	0	0
Reduced Vol:	111	791	50	171	2299	86	88	737	297	117	362	82
PCE Adj:	1.00	1.00	1.00	1.00	1.00	1.00	1.00	1.00	1.00	1.00	1.00	1.00
MLF Adj:	1.00	1.00	1.00	1.00	1.00	1.00	1.00	1.00	1.00	1.00	1.00	1.00
FinalVolume:	111	791	50	171	2299	86	88	737	297	117	362	82

Saturation Flow Module:

Sat/Lane:	1600	1600	1600	1600	1600	1600	1600	1600	1600	1600	1600	1600
Adjustment:	1.00	1.04	1.00	1.00	1.04	1.00	1.00	1.04	1.00	1.00	1.06	1.00
Lanes:	2.00	2.82	0.18	1.00	2.89	0.11	1.00	1.43	0.57	1.00	2.00	1.00
Final Sat.:	3200	4715	285	1600	4827	173	1600	2381	919	1600	3400	1600

Capacity Analysis Module:

Vol/Sat:	0.03	0.17	0.18	0.11	0.48	0.50	0.06	0.31	0.32	0.07	0.11	0.05
Crit Moves:	****					****			****	****		

Santa Ana Circulation Element

Level Of Service Computation Report

ICU 1(Loss as Cycle Length %) Method (Base Volume Alternative)

Intersection #14 MacArthur Blvd and Hyland Ave

Cycle (sec): 100 Critical Vol./Cap.(X): 0.608
 Loss Time (sec): 5 Average Delay (sec/veh): xxxxxx
 Optimal Cycle: 29 Level Of Service: B

Approach:	North Bound			South Bound			East Bound			West Bound		
Movement:	L	T	R	L	T	R	L	T	R	L	T	R
Control:	Protected			Protected			Prot+Permit			Prot+Permit		
Rights:	Include			Include			Include			Include		
Min. Green:	0	0	0	0	0	0	0	0	0	0	0	0
Y+R:	4.0	4.0	4.0	4.0	4.0	4.0	4.0	4.0	4.0	4.0	4.0	4.0
Lanes:	2	0	0	1	0	1	3	0	1	1	0	3

Volume Module:

Base Vol:	69	3	19	8	2	19	7	1953	775	64	490	20
Growth Adj:	1.00	1.00	1.00	1.00	1.00	1.00	1.00	1.00	1.00	1.00	1.00	1.00
Initial Bse:	69	3	19	8	2	19	7	1953	775	64	490	20
User Adj:	1.00	1.00	1.00	1.00	1.00	1.00	1.00	1.00	1.00	1.00	1.00	1.00
PHF Adj:	1.00	1.00	1.00	1.00	1.00	1.00	1.00	1.00	1.00	1.00	1.00	1.00
PHF Volume:	69	3	19	8	2	19	7	1953	775	64	490	20
Reduct Vol:	0	0	0	0	0	0	0	0	0	0	0	0
Reduced Vol:	69	3	19	8	2	19	7	1953	775	64	490	20
PCE Adj:	1.00	1.00	1.00	1.00	1.00	1.00	1.00	1.00	1.00	1.00	1.00	1.00
MLF Adj:	1.00	1.00	1.00	1.00	1.00	1.00	1.00	1.00	1.00	1.00	1.00	1.00
FinalVolume:	69	3	19	8	2	19	7	1953	775	64	490	20

Saturation Flow Module:

Sat/Lane:	1600	1600	1600	1600	1600	1600	1600	1600	1600	1600	1600	1600
Adjustment:	1.00	1.00	1.00	1.00	1.06	1.00	1.00	1.06	1.00	1.00	1.06	1.00
Lanes:	2.00	0.14	0.86	1.00	1.00	1.00	1.00	3.00	1.00	1.00	3.00	1.00
Final Sat.:	3200	218	1382	1600	1700	1600	1600	5100	1600	1600	5100	1600

Capacity Analysis Module:

Vol/Sat:	0.02	0.01	0.01	0.01	0.00	0.01	0.00	0.38	0.48	0.04	0.10	0.01
Crit Moves:	****					****			****	****		

Santa Ana Circulation Element

Level Of Service Computation Report

ICU 1(Loss as Cycle Length %) Method (Base Volume Alternative)

Intersection #15 MacArthur Blvd and Harbor Blvd

Cycle (sec): 100 Critical Vol./Cap.(X): 0.754
 Loss Time (sec): 5 Average Delay (sec/veh): xxxxxx
 Optimal Cycle: 44 Level Of Service: C

Approach:	North Bound			South Bound			East Bound			West Bound		
Movement:	L	T	R	L	T	R	L	T	R	L	T	R
Control:	Protected			Protected			Protected			Protected		
Rights:	Include			Include			Include			Include		
Min. Green:	0	0	0	0	0	0	0	0	0	0	0	0
Y+R:	4.0	4.0	4.0	4.0	4.0	4.0	4.0	4.0	4.0	4.0	4.0	4.0
Lanes:	2	0	3	0	1		2	0	3	0	1	

Volume Module:

Base Vol:	128	898	92	316	1820	126	126	1141	344	133	443	132
Growth Adj:	1.00	1.00	1.00	1.00	1.00	1.00	1.00	1.00	1.00	1.00	1.00	1.00
Initial Bse:	128	898	92	316	1820	126	126	1141	344	133	443	132
User Adj:	1.00	1.00	1.00	1.00	1.00	1.00	1.00	1.00	1.00	1.00	1.00	1.00
PHF Adj:	1.00	1.00	1.00	1.00	1.00	1.00	1.00	1.00	1.00	1.00	1.00	1.00
PHF Volume:	128	898	92	316	1820	126	126	1141	344	133	443	132
Reduct Vol:	0	0	0	0	0	0	0	0	0	0	0	0
Reduced Vol:	128	898	92	316	1820	126	126	1141	344	133	443	132
PCE Adj:	1.00	1.00	1.00	1.00	1.00	1.00	1.00	1.00	1.00	1.00	1.00	1.00
MLF Adj:	1.00	1.00	1.00	1.00	1.00	1.00	1.00	1.00	1.00	1.00	1.00	1.00
Final Volume:	128	898	92	316	1820	126	126	1141	344	133	443	132

Saturation Flow Module:

Sat/Lane:	1600	1600	1600	1600	1600	1600	1600	1600	1600	1600	1600	1600
Adjustment:	1.00	1.06	1.00	1.00	1.06	1.00	1.00	1.06	1.00	1.00	1.06	1.00
Lanes:	2.00	3.00	1.00	2.00	3.00	1.00	1.00	3.00	1.00	1.00	3.00	1.00
Final Sat.:	3200	5100	1600	3200	5100	1600	1600	5100	1600	1600	5100	1600

Capacity Analysis Module:

Vol/Sat:	0.04	0.18	0.06	0.10	0.36	0.08	0.08	0.22	0.22	0.08	0.09	0.08
Crit Moves:	****			****			****			****		

Santa Ana Circulation Element

Level Of Service Computation Report

ICU 1(Loss as Cycle Length %) Method (Base Volume Alternative)

Intersection #16 Harbor Blvd and Sunflower Ave

Cycle (sec): 100 Critical Vol./Cap.(X): 0.702
Loss Time (sec): 5 Average Delay (sec/veh): xxxxxx
Optimal Cycle: 37 Level Of Service: C

Table with 4 columns: North Bound, South Bound, East Bound, West Bound. Rows include Movement (L-T-R), Control, Rights, Min. Green, Y+R, and Lanes.

Volume Module: Table with 12 columns representing different traffic flows. Rows include Base Vol, Growth Adj, Initial Bse, User Adj, PHF Adj, PHF Volume, Reduct Vol, Reduced Vol, PCE Adj, MLF Adj, and Final Volume.

Saturation Flow Module: Table with 12 columns. Rows include Sat/Lane, Adjustment, Lanes, and Final Sat.

Capacity Analysis Module: Table with 12 columns. Rows include Vol/Sat and Crit Moves.

Santa Ana Circulation Element

Level Of Service Computation Report
 2000 HCM Operations Method (Base Volume Alternative)

 Intersection #17 Harbor Blvd and I-405 WB Off-Ramp

Cycle (sec): 100 Critical Vol./Cap.(X): 0.695
 Loss Time (sec): 5 Average Delay (sec/veh): 19.7
 Optimal Cycle: 38 Level Of Service: B

Approach:	North Bound			South Bound			East Bound			West Bound		
Movement:	L	T	R	L	T	R	L	T	R	L	T	R
Control:	Protected			Protected			Split Phase			Split Phase		
Rights:	Include			Include			Include			Include		
Min. Green:	0	0	0	0	0	0	0	0	0	0	0	0
Y+R:	4.0	4.0	4.0	4.0	4.0	4.0	4.0	4.0	4.0	4.0	4.0	4.0
Lanes:	0	0	4	0	0	4	0	0	0	1	0	1

Volume Module:

Base Vol:	0	1567	0	0	2327	0	0	0	0	508	0	894
Growth Adj:	1.00	1.00	1.00	1.00	1.00	1.00	1.00	1.00	1.00	1.00	1.00	1.00
Initial Bse:	0	1567	0	0	2327	0	0	0	0	508	0	894
User Adj:	1.00	1.00	1.00	1.00	1.00	1.00	1.00	1.00	1.00	1.00	1.00	1.00
PHF Adj:	1.00	1.00	1.00	1.00	1.00	1.00	1.00	1.00	1.00	1.00	1.00	1.00
PHF Volume:	0	1567	0	0	2327	0	0	0	0	508	0	894
Reduct Vol:	0	0	0	0	0	0	0	0	0	0	0	0
Reduced Vol:	0	1567	0	0	2327	0	0	0	0	508	0	894
PCE Adj:	1.00	1.00	1.00	1.00	1.00	1.00	1.00	1.00	1.00	1.00	1.00	1.00
MLF Adj:	1.00	1.00	1.00	1.00	1.00	1.00	1.00	1.00	1.00	1.00	1.00	1.00
FinalVolume:	0	1567	0	0	2327	0	0	0	0	508	0	894

Saturation Flow Module:

Sat/Lane:	1900	1900	1900	1900	1900	1900	1900	1900	1900	1900	1900	1900
Adjustment:	1.00	0.91	1.00	1.00	0.91	1.00	1.00	1.00	1.00	0.89	1.00	0.89
Lanes:	0.00	4.00	0.00	0.00	4.00	0.00	0.00	0.00	0.00	1.36	0.00	1.64
Final Sat.:	0	6916	0	0	6916	0	0	0	0	2298	0	2762

Capacity Analysis Module:

Vol/Sat:	0.00	0.23	0.00	0.00	0.34	0.00	0.00	0.00	0.00	0.22	0.00	0.32
Crit Moves:	****			****						****		
Green/Cycle:	0.00	0.48	0.00	0.00	0.48	0.00	0.00	0.00	0.00	0.47	0.00	0.47
Volume/Cap:	0.00	0.47	0.00	0.00	0.69	0.00	0.00	0.00	0.00	0.47	0.00	0.69
Delay/Veh:	0.0	17.3	0.0	0.0	20.7	0.0	0.0	0.0	0.0	18.4	0.0	22.2
User DelAdj:	1.00	1.00	1.00	1.00	1.00	1.00	1.00	1.00	1.00	1.00	1.00	1.00
AdjDel/Veh:	0.0	17.3	0.0	0.0	20.7	0.0	0.0	0.0	0.0	18.4	0.0	22.2
LOS by Move:	A	B	A	A	C	A	A	A	A	B	A	C
HCM2k85thQ:	0	13	0	0	24	0	0	0	0	12	0	21

 Note: Queue reported is the number of cars per lane.

Santa Ana Circulation Element

Level Of Service Computation Report
 2000 HCM Operations Method (Base Volume Alternative)

 Intersection #18 Harbor Blvd and I-405 EB Off-Ramp

Cycle (sec): 100 Critical Vol./Cap.(X): 0.524
 Loss Time (sec): 5 Average Delay (sec/veh): 13.2
 Optimal Cycle: 26 Level Of Service: B

Approach:	North Bound			South Bound			East Bound			West Bound		
Movement:	L	T	R	L	T	R	L	T	R	L	T	R
Control:	Protected			Protected			Split Phase			Split Phase		
Rights:	Ignore			Include			Include			Include		
Min. Green:	0	0	0	0	0	0	0	0	0	0	0	0
Y+R:	4.0	4.0	4.0	4.0	4.0	4.0	4.0	4.0	4.0	4.0	4.0	4.0
Lanes:	0	0	3	0	0	4	1	0	1	0	0	0

Volume Module:

Base Vol:	0	1729	0	0	1504	0	385	0	429	0	0	0
Growth Adj:	1.00	1.00	1.00	1.00	1.00	1.00	1.00	1.00	1.00	1.00	1.00	1.00
Initial Bse:	0	1729	0	0	1504	0	385	0	429	0	0	0
User Adj:	1.00	1.00	0.00	1.00	1.00	1.00	1.00	1.00	1.00	1.00	1.00	1.00
PHF Adj:	1.00	1.00	0.00	1.00	1.00	1.00	1.00	1.00	1.00	1.00	1.00	1.00
PHF Volume:	0	1729	0	0	1504	0	385	0	429	0	0	0
Reduct Vol:	0	0	0	0	0	0	0	0	0	0	0	0
Reduced Vol:	0	1729	0	0	1504	0	385	0	429	0	0	0
PCE Adj:	1.00	1.00	0.00	1.00	1.00	1.00	1.00	1.00	1.00	1.00	1.00	1.00
MLF Adj:	1.00	1.00	0.00	1.00	1.00	1.00	1.00	1.00	1.00	1.00	1.00	1.00
FinalVolume:	0	1729	0	0	1504	0	385	0	429	0	0	0

Saturation Flow Module:

Sat/Lane:	1900	1900	1900	1900	1900	1900	1900	1900	1900	1900	1900	1900
Adjustment:	1.00	0.91	1.00	1.00	0.91	1.00	0.90	1.00	0.90	1.00	1.00	1.00
Lanes:	0.00	3.00	1.00	0.00	4.00	0.00	1.47	0.00	1.53	0.00	0.00	0.00
Final Sat.:	0	5187	1900	0	6916	0	2518	0	2611	0	0	0

Capacity Analysis Module:

Vol/Sat:	0.00	0.33	0.00	0.00	0.22	0.00	0.15	0.00	0.16	0.00	0.00	0.00
Crit Moves:	****			****			****			****		
Green/Cycle:	0.00	0.64	0.00	0.00	0.64	0.00	0.31	0.00	0.31	0.00	0.00	0.00
Volume/Cap:	0.00	0.52	0.00	0.00	0.34	0.00	0.49	0.00	0.52	0.00	0.00	0.00
Delay/Veh:	0.0	10.1	0.0	0.0	8.5	0.0	28.0	0.0	28.5	0.0	0.0	0.0
User DelAdj:	1.00	1.00	1.00	1.00	1.00	1.00	1.00	1.00	1.00	1.00	1.00	1.00
AdjDel/Veh:	0.0	10.1	0.0	0.0	8.5	0.0	28.0	0.0	28.5	0.0	0.0	0.0
LOS by Move:	A	B	A	A	A	A	C	A	C	A	A	A
HCM2k85thQ:	0	16	0	0	9	0	10	0	11	0	0	0

 Note: Queue reported is the number of cars per lane.

Santa Ana Circulation Element

Level Of Service Computation Report

ICU 1(Loss as Cycle Length %) Method (Base Volume Alternative)

Intersection #19 Fairview St and Civic Center Dr

Cycle (sec): 100 Critical Vol./Cap.(X): 0.667
Loss Time (sec): 5 Average Delay (sec/veh): xxxxxx
Optimal Cycle: 34 Level Of Service: B

Table with 4 columns: North Bound, South Bound, East Bound, West Bound. Rows include Movement, Control, Rights, Min. Green, Y+R, and Lanes.

Volume Module: Table with 12 columns representing different traffic volumes and adjustment factors.

Saturation Flow Module: Table with 12 columns representing saturation flow rates and adjustment factors.

Capacity Analysis Module: Table with 12 columns representing capacity analysis metrics.

Santa Ana Circulation Element

Level Of Service Computation Report

ICU 1(Loss as Cycle Length %) Method (Base Volume Alternative)

Intersection #20 Fairview St and 1st St

Cycle (sec): 100 Critical Vol./Cap.(X): 0.872
Loss Time (sec): 5 Average Delay (sec/veh): xxxxxx
Optimal Cycle: 73 Level Of Service: D

Table with 4 columns: North Bound, South Bound, East Bound, West Bound. Rows include Movement (L-T-R), Control, Rights, Min. Green, Y+R, and Lanes.

Volume Module: Table with 12 columns representing different volume categories and their values.

Saturation Flow Module: Table with 12 columns representing saturation flow values for various lanes.

Capacity Analysis Module: Table with 12 columns representing capacity analysis values.

Santa Ana Circulation Element

Level Of Service Computation Report

ICU 1(Loss as Cycle Length %) Method (Base Volume Alternative)

Intersection #21 Fairview St and McFadden Ave

Cycle (sec): 100 Critical Vol./Cap.(X): 0.786
 Loss Time (sec): 5 Average Delay (sec/veh): xxxxxx
 Optimal Cycle: 49 Level Of Service: C

Approach:	North Bound			South Bound			East Bound			West Bound		
Movement:	L	T	R	L	T	R	L	T	R	L	T	R
Control:	Protected			Protected			Protected			Protected		
Rights:	Include			Include			Include			Include		
Min. Green:	0	0	0	0	0	0	0	0	0	0	0	0
Y+R:	4.0	4.0	4.0	4.0	4.0	4.0	4.0	4.0	4.0	4.0	4.0	4.0
Lanes:	1	0	3	0	1	1	1	0	1	1	1	0

Volume Module:

Base Vol:	121	1294	173	142	1727	125	221	522	120	194	500	40
Growth Adj:	1.00	1.00	1.00	1.00	1.00	1.00	1.00	1.00	1.00	1.00	1.00	1.00
Initial Bse:	121	1294	173	142	1727	125	221	522	120	194	500	40
User Adj:	1.00	1.00	1.00	1.00	1.00	1.00	1.00	1.00	1.00	1.00	1.00	1.00
PHF Adj:	1.00	1.00	1.00	1.00	1.00	1.00	1.00	1.00	1.00	1.00	1.00	1.00
PHF Volume:	121	1294	173	142	1727	125	221	522	120	194	500	40
Reduct Vol:	0	0	0	0	0	0	0	0	0	0	0	0
Reduced Vol:	121	1294	173	142	1727	125	221	522	120	194	500	40
PCE Adj:	1.00	1.00	1.00	1.00	1.00	1.00	1.00	1.00	1.00	1.00	1.00	1.00
MLF Adj:	1.00	1.00	1.00	1.00	1.00	1.00	1.00	1.00	1.00	1.00	1.00	1.00
FinalVolume:	121	1294	173	142	1727	125	221	522	120	194	500	40

Saturation Flow Module:

Sat/Lane:	1600	1600	1600	1600	1600	1600	1600	1600	1600	1600	1600	1600
Adjustment:	1.00	1.06	1.00	1.00	1.06	1.00	1.00	1.04	1.00	1.00	1.03	1.00
Lanes:	1.00	3.00	1.00	1.00	3.00	1.00	1.00	1.63	0.37	1.00	1.85	0.15
Final Sat.:	1600	5100	1600	1600	5100	1600	1600	2702	598	1600	3063	237

Capacity Analysis Module:

Vol/Sat:	0.08	0.25	0.11	0.09	0.34	0.08	0.14	0.19	0.20	0.12	0.16	0.17
Crit Moves:	****				****				****	****		

Santa Ana Circulation Element

Level Of Service Computation Report

ICU 1(Loss as Cycle Length %) Method (Base Volume Alternative)

Intersection #22 Fairview St and Edinger Ave

Cycle (sec): 100 Critical Vol./Cap.(X): 0.753
 Loss Time (sec): 5 Average Delay (sec/veh): xxxxxx
 Optimal Cycle: 44 Level Of Service: C

Approach:	North Bound			South Bound			East Bound			West Bound		
Movement:	L	T	R	L	T	R	L	T	R	L	T	R
Control:	Protected			Protected			Protected			Protected		
Rights:	Include			Include			Include			Include		
Min. Green:	0	0	0	0	0	0	0	0	0	0	0	0
Y+R:	4.0	4.0	4.0	4.0	4.0	4.0	4.0	4.0	4.0	4.0	4.0	4.0
Lanes:	2	0	2	1	0	0	2	0	2	1	0	0

Volume Module:

Base Vol:	188	831	116	215	1503	127	237	657	176	421	553	110
Growth Adj:	1.00	1.00	1.00	1.00	1.00	1.00	1.00	1.00	1.00	1.00	1.00	1.00
Initial Bse:	188	831	116	215	1503	127	237	657	176	421	553	110
User Adj:	1.00	1.00	1.00	1.00	1.00	1.00	1.00	1.00	1.00	1.00	1.00	1.00
PHF Adj:	1.00	1.00	1.00	1.00	1.00	1.00	1.00	1.00	1.00	1.00	1.00	1.00
PHF Volume:	188	831	116	215	1503	127	237	657	176	421	553	110
Reduct Vol:	0	0	0	0	0	0	0	0	0	0	0	0
Reduced Vol:	188	831	116	215	1503	127	237	657	176	421	553	110
PCE Adj:	1.00	1.00	1.00	1.00	1.00	1.00	1.00	1.00	1.00	1.00	1.00	1.00
MLF Adj:	1.00	1.00	1.00	1.00	1.00	1.00	1.00	1.00	1.00	1.00	1.00	1.00
FinalVolume:	188	831	116	215	1503	127	237	657	176	421	553	110

Saturation Flow Module:

Sat/Lane:	1600	1600	1600	1600	1600	1600	1600	1600	1600	1600	1600	1600
Adjustment:	1.00	1.05	1.00	1.00	1.05	1.00	1.00	1.05	1.00	1.00	1.05	1.00
Lanes:	2.00	2.63	0.37	2.00	2.77	0.23	2.00	2.37	0.63	2.00	2.50	0.50
Final Sat.:	3200	4412	588	3200	4626	374	3200	3986	1014	3200	4204	796

Capacity Analysis Module:

Vol/Sat:	0.06	0.19	0.20	0.07	0.32	0.34	0.07	0.16	0.17	0.13	0.13	0.14
Crit Moves:	****					****			****	****		

Santa Ana Circulation Element

Level Of Service Computation Report

ICU 1(Loss as Cycle Length %) Method (Base Volume Alternative)

Intersection #23 Fairview St and Warner Ave

Cycle (sec): 100 Critical Vol./Cap.(X): 0.850
 Loss Time (sec): 5 Average Delay (sec/veh): xxxxxx
 Optimal Cycle: 65 Level Of Service: D

Approach:	North Bound			South Bound			East Bound			West Bound		
Movement:	L	T	R	L	T	R	L	T	R	L	T	R
Control:	Protected			Protected			Protected			Protected		
Rights:	Include			Include			Include			Include		
Min. Green:	0	0	0	0	0	0	0	0	0	0	0	0
Y+R:	4.0	4.0	4.0	4.0	4.0	4.0	4.0	4.0	4.0	4.0	4.0	4.0
Lanes:	2	0	2	1	0	0	2	0	2	1	0	0

Volume Module:

Base Vol:	215	952	125	205	1628	119	69	1010	301	307	926	300
Growth Adj:	1.00	1.00	1.00	1.00	1.00	1.00	1.00	1.00	1.00	1.00	1.00	1.00
Initial Bse:	215	952	125	205	1628	119	69	1010	301	307	926	300
User Adj:	1.00	1.00	1.00	1.00	1.00	1.00	1.00	1.00	1.00	1.00	1.00	1.00
PHF Adj:	1.00	1.00	1.00	1.00	1.00	1.00	1.00	1.00	1.00	1.00	1.00	1.00
PHF Volume:	215	952	125	205	1628	119	69	1010	301	307	926	300
Reduct Vol:	0	0	0	0	0	0	0	0	0	0	0	0
Reduced Vol:	215	952	125	205	1628	119	69	1010	301	307	926	300
PCE Adj:	1.00	1.00	1.00	1.00	1.00	1.00	1.00	1.00	1.00	1.00	1.00	1.00
MLF Adj:	1.00	1.00	1.00	1.00	1.00	1.00	1.00	1.00	1.00	1.00	1.00	1.00
FinalVolume:	215	952	125	205	1628	119	69	1010	301	307	926	300

Saturation Flow Module:

Sat/Lane:	1600	1600	1600	1600	1600	1600	1600	1600	1600	1600	1600	1600
Adjustment:	1.00	1.05	1.00	1.00	1.04	1.00	1.00	1.05	1.00	1.00	1.06	1.00
Lanes:	2.00	2.65	0.35	2.00	2.80	0.20	2.00	2.31	0.69	2.00	2.27	0.73
Final Sat.:	3200	4443	557	3200	4673	327	3200	3898	1102	3200	3825	1175

Capacity Analysis Module:

Vol/Sat:	0.07	0.21	0.22	0.06	0.35	0.36	0.02	0.26	0.27	0.10	0.24	0.26
Crit Moves:	****					****			****	****		

Santa Ana Circulation Element

Level Of Service Computation Report

ICU 1(Loss as Cycle Length %) Method (Base Volume Alternative)

Intersection #24 Fairview St and MacArthur Blvd

Cycle (sec): 100 Critical Vol./Cap.(X): 0.704
 Loss Time (sec): 5 Average Delay (sec/veh): xxxxxx
 Optimal Cycle: 38 Level Of Service: C

Approach:	North Bound			South Bound			East Bound			West Bound		
Movement:	L	T	R	L	T	R	L	T	R	L	T	R
Control:	Protected			Protected			Protected			Protected		
Rights:	Include			Include			Include			Include		
Min. Green:	0	0	0	0	0	0	0	0	0	0	0	0
Y+R:	4.0	4.0	4.0	4.0	4.0	4.0	4.0	4.0	4.0	4.0	4.0	4.0
Lanes:	2	0	2	1	0	0	2	0	3	0	1	0

Volume Module:

Base Vol:	248	771	89	307	1546	173	125	1019	150	235	494	140
Growth Adj:	1.00	1.00	1.00	1.00	1.00	1.00	1.00	1.00	1.00	1.00	1.00	1.00
Initial Bse:	248	771	89	307	1546	173	125	1019	150	235	494	140
User Adj:	1.00	1.00	1.00	1.00	1.00	1.00	1.00	1.00	1.00	1.00	1.00	1.00
PHF Adj:	1.00	1.00	1.00	1.00	1.00	1.00	1.00	1.00	1.00	1.00	1.00	1.00
PHF Volume:	248	771	89	307	1546	173	125	1019	150	235	494	140
Reduct Vol:	0	0	0	0	0	0	0	0	0	0	0	0
Reduced Vol:	248	771	89	307	1546	173	125	1019	150	235	494	140
PCE Adj:	1.00	1.00	1.00	1.00	1.00	1.00	1.00	1.00	1.00	1.00	1.00	1.00
MLF Adj:	1.00	1.00	1.00	1.00	1.00	1.00	1.00	1.00	1.00	1.00	1.00	1.00
Final Volume:	248	771	89	307	1546	173	125	1019	150	235	494	140

Saturation Flow Module:

Sat/Lane:	1600	1600	1600	1600	1600	1600	1600	1600	1600	1600	1600	1600
Adjustment:	1.00	1.05	1.00	1.00	1.06	1.00	1.00	1.06	1.00	1.00	1.06	1.00
Lanes:	2.00	2.69	0.31	2.00	3.00	1.00	2.00	3.00	1.00	2.00	3.00	1.00
Final Sat.:	3200	4503	497	3200	5100	1600	3200	5100	1600	3200	5100	1600

Capacity Analysis Module:

Vol/Sat:	0.08	0.17	0.18	0.10	0.30	0.11	0.04	0.20	0.09	0.07	0.10	0.09
Crit Moves:	****			****			****			****		

Santa Ana Circulation Element

Level Of Service Computation Report

ICU 1(Loss as Cycle Length %) Method (Base Volume Alternative)

Intersection #25 Fairview Rd and Sunflower Ave

Cycle (sec): 100 Critical Vol./Cap.(X): 0.705
 Loss Time (sec): 5 Average Delay (sec/veh): xxxxxx
 Optimal Cycle: 38 Level Of Service: C

Approach:	North Bound			South Bound			East Bound			West Bound		
Movement:	L	T	R	L	T	R	L	T	R	L	T	R
Control:	Protected			Protected			Protected			Protected		
Rights:	Include			Include			Include			Include		
Min. Green:	0	0	0	0	0	0	0	0	0	0	0	0
Y+R:	4.0	4.0	4.0	4.0	4.0	4.0	4.0	4.0	4.0	4.0	4.0	4.0
Lanes:	2	0	3	0	1		2	0	2	1	0	

Volume Module:

Base Vol:	185	1071	163	204	1738	111	49	322	65	306	256	132
Growth Adj:	1.00	1.00	1.00	1.00	1.00	1.00	1.00	1.00	1.00	1.00	1.00	1.00
Initial Bse:	185	1071	163	204	1738	111	49	322	65	306	256	132
User Adj:	1.00	1.00	1.00	1.00	1.00	1.00	1.00	1.00	1.00	1.00	1.00	1.00
PHF Adj:	1.00	1.00	1.00	1.00	1.00	1.00	1.00	1.00	1.00	1.00	1.00	1.00
PHF Volume:	185	1071	163	204	1738	111	49	322	65	306	256	132
Reduct Vol:	0	0	0	0	0	0	0	0	0	0	0	0
Reduced Vol:	185	1071	163	204	1738	111	49	322	65	306	256	132
PCE Adj:	1.00	1.00	1.00	1.00	1.00	1.00	1.00	1.00	1.00	1.00	1.00	1.00
MLF Adj:	1.00	1.00	1.00	1.00	1.00	1.00	1.00	1.00	1.00	1.00	1.00	1.00
FinalVolume:	185	1071	163	204	1738	111	49	322	65	306	256	132

Saturation Flow Module:

Sat/Lane:	1600	1600	1600	1600	1600	1600	1600	1600	1600	1600	1600	1600
Adjustment:	1.00	1.06	1.00	1.00	1.04	1.00	1.00	1.04	1.00	1.00	1.06	1.00
Lanes:	2.00	3.00	1.00	2.00	2.82	0.18	2.00	1.66	0.34	2.00	2.00	1.00
Final Sat.:	3200	5100	1600	3200	4712	288	3200	2763	537	3200	3400	1600

Capacity Analysis Module:

Vol/Sat:	0.06	0.21	0.10	0.06	0.37	0.39	0.02	0.12	0.12	0.10	0.08	0.08
Crit Moves:	****					****		****		****		

Santa Ana Circulation Element

Level Of Service Computation Report

ICU 1(Loss as Cycle Length %) Method (Base Volume Alternative)

Intersection #26 Greenville St and Edinger Ave

Cycle (sec): 100 Critical Vol./Cap.(X): 0.563
Loss Time (sec): 5 Average Delay (sec/veh): xxxxxx
Optimal Cycle: 27 Level Of Service: A

Table with 4 columns: North Bound, South Bound, East Bound, West Bound. Rows include Movement (L-T-R), Control (Split Phase, Protected), Rights (Include), Min. Green, Y+R, and Lanes.

Volume Module table with 12 columns representing different traffic flows and 10 rows of adjustment factors like Base Vol, Growth Adj, PHF Adj, etc.

Saturation Flow Module table with 12 columns and 4 rows showing Sat/Lane, Adjustment, Lanes, and Final Sat.

Capacity Analysis Module table with 12 columns and 3 rows showing Vol/Sat, Crit Moves, and other capacity metrics.

Santa Ana Circulation Element

Level Of Service Computation Report

ICU 1(Loss as Cycle Length %) Method (Base Volume Alternative)

Intersection #27 Greenville St and Segerstrom Ave

Cycle (sec): 100 Critical Vol./Cap.(X): 0.727
 Loss Time (sec): 5 Average Delay (sec/veh): xxxxxx
 Optimal Cycle: 40 Level Of Service: C

Approach:	North Bound			South Bound			East Bound			West Bound		
Movement:	L	T	R	L	T	R	L	T	R	L	T	R
Control:	Permitted			Permitted			Permitted			Permitted		
Rights:	Include			Include			WideBypass			WideBypass		
Min. Green:	0	0	0	0	0	0	0	0	0	0	0	0
Y+R:	4.0	4.0	4.0	4.0	4.0	4.0	4.0	4.0	4.0	4.0	4.0	4.0
Lanes:	1	0	1	1	0	1	1	0	1	1	0	1

Volume Module:

Base Vol:	47	193	78	154	472	160	33	739	118	164	662	76
Growth Adj:	1.00	1.00	1.00	1.00	1.00	1.00	1.00	1.00	1.00	1.00	1.00	1.00
Initial Bse:	47	193	78	154	472	160	33	739	118	164	662	76
User Adj:	1.00	1.00	1.00	1.00	1.00	1.00	1.00	1.00	1.00	1.00	1.00	1.00
PHF Adj:	1.00	1.00	1.00	1.00	1.00	1.00	1.00	1.00	1.00	1.00	1.00	1.00
PHF Volume:	47	193	78	154	472	160	33	739	118	164	662	76
Reduct Vol:	0	0	0	0	0	0	0	0	0	0	0	0
Reduced Vol:	47	193	78	154	472	160	33	739	118	164	662	76
PCE Adj:	1.00	1.00	1.00	1.00	1.00	1.00	1.00	1.00	1.00	1.00	1.00	1.00
MLF Adj:	1.00	1.00	1.00	1.00	1.00	1.00	1.00	1.00	1.00	1.00	1.00	1.00
FinalVolume:	47	193	78	154	472	160	33	739	118	164	662	76

Saturation Flow Module:

Sat/Lane:	1600	1600	1600	1600	1600	1600	1600	1600	1600	1600	1600	1600
Adjustment:	1.00	1.04	1.00	1.00	1.06	1.00	1.00	1.04	1.00	1.00	1.03	1.00
Lanes:	1.00	1.42	0.58	1.00	1.00	1.00	1.00	1.72	0.28	1.00	1.79	0.21
Final Sat.:	1600	2379	921	1600	1700	1600	1600	2859	441	1600	2970	330

Capacity Analysis Module:

Vol/Sat:	0.03	0.08	0.08	0.10	0.28	0.10	0.02	0.26	0.27	0.10	0.22	0.23
Crit Moves:	****			****			****		****	****		

Santa Ana Circulation Element

Level Of Service Computation Report

ICU 1(Loss as Cycle Length %) Method (Base Volume Alternative)

Intersection #28 Raitt St and McFadden Ave

Cycle (sec): 100 Critical Vol./Cap.(X): 0.715
Loss Time (sec): 5 Average Delay (sec/veh): xxxxxx
Optimal Cycle: 39 Level Of Service: C

Table with 4 columns: North Bound, South Bound, East Bound, West Bound. Rows include Movement, Control, Rights, Min. Green, Y+R, and Lanes.

Volume Module: Table with 12 columns representing different traffic volumes and adjustment factors.

Saturation Flow Module: Table with 12 columns representing saturation flow rates and adjustment factors.

Capacity Analysis Module: Table with 12 columns representing capacity analysis metrics.

Santa Ana Circulation Element

Level Of Service Computation Report

ICU 1(Loss as Cycle Length %) Method (Base Volume Alternative)

Intersection #29 Raitt St and Edinger Ave

Cycle (sec): 100 Critical Vol./Cap.(X): 0.851
Loss Time (sec): 5 Average Delay (sec/veh): xxxxxx
Optimal Cycle: 65 Level Of Service: D

Table with 4 columns: North Bound, South Bound, East Bound, West Bound. Rows include Movement (L-T-R), Control, Rights, Min. Green, Y+R, and Lanes.

Volume Module table with 12 columns representing different traffic flows and 10 rows of adjustment factors like Growth Adj, PHF Adj, etc.

Saturation Flow Module table with 12 columns and 4 rows showing Sat/Lane, Adjustment, Lanes, and Final Sat.

Capacity Analysis Module table with 12 columns and 2 rows showing Vol/Sat and Crit Moves.

Santa Ana Circulation Element

Level Of Service Computation Report

ICU 1(Loss as Cycle Length %) Method (Base Volume Alternative)

Intersection #30 Bear St and MacArthur Blvd

Cycle (sec): 100 Critical Vol./Cap.(X): 0.737
 Loss Time (sec): 5 Average Delay (sec/veh): xxxxxx
 Optimal Cycle: 42 Level Of Service: C

Approach:	North Bound			South Bound			East Bound			West Bound		
Movement:	L	T	R	L	T	R	L	T	R	L	T	R
Control:	Protected			Protected			Protected			Protected		
Rights:	Include			Include			Include			Include		
Min. Green:	0	0	0	0	0	0	0	0	0	0	0	0
Y+R:	4.0	4.0	4.0	4.0	4.0	4.0	4.0	4.0	4.0	4.0	4.0	4.0
Lanes:	1	0	2	0	1	0	1	0	2	1	0	2

Volume Module:

Base Vol:	81	280	119	199	756	300	97	1663	114	70	1180	100
Growth Adj:	1.00	1.00	1.00	1.00	1.00	1.00	1.00	1.00	1.00	1.00	1.00	1.00
Initial Bse:	81	280	119	199	756	300	97	1663	114	70	1180	100
User Adj:	1.00	1.00	1.00	1.00	1.00	1.00	1.00	1.00	1.00	1.00	1.00	1.00
PHF Adj:	1.00	1.00	1.00	1.00	1.00	1.00	1.00	1.00	1.00	1.00	1.00	1.00
PHF Volume:	81	280	119	199	756	300	97	1663	114	70	1180	100
Reduct Vol:	0	0	0	0	0	0	0	0	0	0	0	0
Reduced Vol:	81	280	119	199	756	300	97	1663	114	70	1180	100
PCE Adj:	1.00	1.00	1.00	1.00	1.00	1.00	1.00	1.00	1.00	1.00	1.00	1.00
MLF Adj:	1.00	1.00	1.00	1.00	1.00	1.00	1.00	1.00	1.00	1.00	1.00	1.00
FinalVolume:	81	280	119	199	756	300	97	1663	114	70	1180	100

Saturation Flow Module:

Sat/Lane:	1600	1600	1600	1600	1600	1600	1600	1600	1600	1600	1600	1600
Adjustment:	1.00	1.06	1.00	1.00	1.06	1.00	1.00	1.04	1.00	1.00	1.05	1.00
Lanes:	1.00	2.00	1.00	1.00	2.00	1.00	1.00	2.81	0.19	1.00	2.77	0.23
Final Sat.:	1600	3400	1600	1600	3400	1600	1600	4692	308	1600	4625	375

Capacity Analysis Module:

Vol/Sat:	0.05	0.08	0.07	0.12	0.22	0.19	0.06	0.35	0.37	0.04	0.26	0.27
Crit Moves:	****			****			****		****	****		

Santa Ana Circulation Element

Level Of Service Computation Report

ICU 1(Loss as Cycle Length %) Method (Base Volume Alternative)

Intersection #31 Bristol St and 17th St

Cycle (sec): 100 Critical Vol./Cap.(X): 0.725
 Loss Time (sec): 5 Average Delay (sec/veh): xxxxxx
 Optimal Cycle: 40 Level Of Service: C

Approach:	North Bound			South Bound			East Bound			West Bound		
Movement:	L	T	R	L	T	R	L	T	R	L	T	R
Control:	Protected			Protected			Protected			Protected		
Rights:	Include			Include			Include			Ovl		
Min. Green:	0	0	0	0	0	0	0	0	0	0	0	0
Y+R:	4.0	4.0	4.0	4.0	4.0	4.0	4.0	4.0	4.0	4.0	4.0	4.0
Lanes:	2	0	3	0	1		2	0	3	0	1	

Volume Module:

Base Vol:	192	988	167	335	1376	181	324	963	156	359	824	273
Growth Adj:	1.00	1.00	1.00	1.00	1.00	1.00	1.00	1.00	1.00	1.00	1.00	1.00
Initial Bse:	192	988	167	335	1376	181	324	963	156	359	824	273
User Adj:	1.00	1.00	1.00	1.00	1.00	1.00	1.00	1.00	1.00	1.00	1.00	1.00
PHF Adj:	1.00	1.00	1.00	1.00	1.00	1.00	1.00	1.00	1.00	1.00	1.00	1.00
PHF Volume:	192	988	167	335	1376	181	324	963	156	359	824	273
Reduct Vol:	0	0	0	0	0	0	0	0	0	0	0	0
Reduced Vol:	192	988	167	335	1376	181	324	963	156	359	824	273
PCE Adj:	1.00	1.00	1.00	1.00	1.00	1.00	1.00	1.00	1.00	1.00	1.00	1.00
MLF Adj:	1.00	1.00	1.00	1.00	1.00	1.00	1.00	1.00	1.00	1.00	1.00	1.00
FinalVolume:	192	988	167	335	1376	181	324	963	156	359	824	273
OvlAdjVol:												106

Saturation Flow Module:

Sat/Lane:	1600	1600	1600	1600	1600	1600	1600	1600	1600	1600	1600	1600
Adjustment:	1.00	1.06	1.00	1.00	1.06	1.00	1.00	1.05	1.00	1.00	1.06	1.00
Lanes:	2.00	3.00	1.00	2.00	3.00	1.00	2.00	2.58	0.42	2.00	3.00	1.00
Final Sat.:	3200	5100	1600	3200	5100	1600	3200	4331	669	3200	5100	1600

Capacity Analysis Module:

Vol/Sat:	0.06	0.19	0.10	0.10	0.27	0.11	0.10	0.22	0.23	0.11	0.16	0.17
OvlAdjV/S:												0.07
Crit Moves:	****			****			****			****		

Santa Ana Circulation Element

Level Of Service Computation Report

ICU 1(Loss as Cycle Length %) Method (Base Volume Alternative)

Intersection #32 Bristol St and Civic Center Dr

Cycle (sec): 100 Critical Vol./Cap.(X): 0.827
Loss Time (sec): 5 Average Delay (sec/veh): xxxxxx
Optimal Cycle: 58 Level Of Service: D

Table with 4 columns: North Bound, South Bound, East Bound, West Bound. Rows include Movement (L-T-R), Control, Rights, Min. Green, Y+R, and Lanes.

Volume Module: Table with 12 columns representing traffic volumes and adjustment factors for Base Vol, Growth Adj, Initial Bse, User Adj, PHF Adj, PHF Volume, Reduct Vol, Reduced Vol, PCE Adj, MLF Adj, and Final Volume.

Saturation Flow Module: Table with 12 columns representing saturation flow rates and adjustment factors for Sat/Lane, Adjustment, Lanes, and Final Sat.

Capacity Analysis Module: Table with 12 columns representing capacity analysis metrics like Vol/Sat and Crit Moves.

Santa Ana Circulation Element

Level Of Service Computation Report

ICU 1(Loss as Cycle Length %) Method (Base Volume Alternative)

Intersection #33 Bristol St and Santa Ana Blvd

Cycle (sec): 100 Critical Vol./Cap.(X): 0.669
 Loss Time (sec): 5 Average Delay (sec/veh): xxxxxx
 Optimal Cycle: 34 Level Of Service: B

Approach:	North Bound			South Bound			East Bound			West Bound		
Movement:	L	T	R	L	T	R	L	T	R	L	T	R
Control:	Protected			Protected			Prot+Permit			Prot+Permit		
Rights:	Include			Include			Include			Include		
Min. Green:	0	0	0	0	0	0	0	0	0	0	0	0
Y+R:	4.0	4.0	4.0	4.0	4.0	4.0	4.0	4.0	4.0	4.0	4.0	4.0
Lanes:	1	0	2	1	0	2	1	0	1	1	0	1

Volume Module:

Base Vol:	65	1419	197	137	1507	41	83	403	35	96	240	41
Growth Adj:	1.00	1.00	1.00	1.00	1.00	1.00	1.00	1.00	1.00	1.00	1.00	1.00
Initial Bse:	65	1419	197	137	1507	41	83	403	35	96	240	41
User Adj:	1.00	1.00	1.00	1.00	1.00	1.00	1.00	1.00	1.00	1.00	1.00	1.00
PHF Adj:	1.00	1.00	1.00	1.00	1.00	1.00	1.00	1.00	1.00	1.00	1.00	1.00
PHF Volume:	65	1419	197	137	1507	41	83	403	35	96	240	41
Reduct Vol:	0	0	0	0	0	0	0	0	0	0	0	0
Reduced Vol:	65	1419	197	137	1507	41	83	403	35	96	240	41
PCE Adj:	1.00	1.00	1.00	1.00	1.00	1.00	1.00	1.00	1.00	1.00	1.00	1.00
MLF Adj:	1.00	1.00	1.00	1.00	1.00	1.00	1.00	1.00	1.00	1.00	1.00	1.00
FinalVolume:	65	1419	197	137	1507	41	83	403	35	96	240	41

Saturation Flow Module:

Sat/Lane:	1600	1600	1600	1600	1600	1600	1600	1600	1600	1600	1600	1600
Adjustment:	1.00	1.05	1.00	1.00	1.04	1.00	1.00	1.03	1.00	1.00	1.04	1.00
Lanes:	1.00	2.63	0.37	1.00	2.92	0.08	1.00	1.84	0.16	1.00	1.71	0.29
Final Sat.:	1600	4415	585	1600	4873	127	1600	3044	256	1600	2833	467

Capacity Analysis Module:

Vol/Sat:	0.04	0.32	0.34	0.09	0.31	0.32	0.05	0.13	0.14	0.06	0.08	0.09
Crit Moves:			****	****					****	****		

Santa Ana Circulation Element

Level Of Service Computation Report

ICU 1(Loss as Cycle Length %) Method (Base Volume Alternative)

Intersection #34 Bristol St and 1st St

Cycle (sec): 100 Critical Vol./Cap.(X): 0.745
Loss Time (sec): 5 Average Delay (sec/veh): xxxxxx
Optimal Cycle: 43 Level Of Service: C

Table with 4 columns: North Bound, South Bound, East Bound, West Bound. Rows include Movement (L-T-R), Control (Protected), Rights (Include), Min. Green, Y+R, and Lanes.

Volume Module: Table with 12 columns for volume and adjustment factors. Rows include Base Vol, Growth Adj, Initial Bse, User Adj, PHF Adj, PHF Volume, Reduct Vol, Reduced Vol, PCE Adj, MLF Adj, and Final Volume.

Saturation Flow Module: Table with 12 columns for saturation flow. Rows include Sat/Lane, Adjustment, Lanes, and Final Sat.

Capacity Analysis Module: Table with 12 columns for capacity analysis. Rows include Vol/Sat and Crit Moves.

Santa Ana Circulation Element

Level Of Service Computation Report

ICU 1(Loss as Cycle Length %) Method (Base Volume Alternative)

Intersection #35 Bristol St and McFadden Ave

Cycle (sec): 100 Critical Vol./Cap.(X): 0.749
Loss Time (sec): 5 Average Delay (sec/veh): xxxxxx
Optimal Cycle: 43 Level Of Service: C

Table with 4 columns: North Bound, South Bound, East Bound, West Bound. Rows include Movement, Control, Rights, Min. Green, Y+R, and Lanes.

Volume Module table with 12 columns representing different traffic flows and 10 rows of adjustment factors like Growth Adj, PHF Adj, etc.

Saturation Flow Module table with 12 columns and 4 rows showing Sat/Lane, Adjustment, Lanes, and Final Sat.

Capacity Analysis Module table with 12 columns and 3 rows showing Vol/Sat, Crit Moves, and other capacity metrics.

Santa Ana Circulation Element

Level Of Service Computation Report

ICU 1(Loss as Cycle Length %) Method (Base Volume Alternative)

Intersection #36 Bristol St and Warner Ave

Cycle (sec): 100 Critical Vol./Cap.(X): 0.767
 Loss Time (sec): 5 Average Delay (sec/veh): xxxxxx
 Optimal Cycle: 46 Level Of Service: C

Approach:	North Bound			South Bound			East Bound			West Bound		
Movement:	L	T	R	L	T	R	L	T	R	L	T	R
Control:	Protected			Protected			Protected			Protected		
Rights:	Include			Include			Include			Include		
Min. Green:	0	0	0	0	0	0	0	0	0	0	0	0
Y+R:	4.0	4.0	4.0	4.0	4.0	4.0	4.0	4.0	4.0	4.0	4.0	4.0
Lanes:	2	0	2	0	2	1	0	1	0	3	0	1

Volume Module:

Base Vol:	192	862	159	386	1307	148	206	1149	286	188	860	146
Growth Adj:	1.00	1.00	1.00	1.00	1.00	1.00	1.00	1.00	1.00	1.00	1.00	1.00
Initial Bse:	192	862	159	386	1307	148	206	1149	286	188	860	146
User Adj:	1.00	1.00	1.00	1.00	1.00	1.00	1.00	1.00	1.00	1.00	1.00	1.00
PHF Adj:	1.00	1.00	1.00	1.00	1.00	1.00	1.00	1.00	1.00	1.00	1.00	1.00
PHF Volume:	192	862	159	386	1307	148	206	1149	286	188	860	146
Reduct Vol:	0	0	0	0	0	0	0	0	0	0	0	0
Reduced Vol:	192	862	159	386	1307	148	206	1149	286	188	860	146
PCE Adj:	1.00	1.00	1.00	1.00	1.00	1.00	1.00	1.00	1.00	1.00	1.00	1.00
MLF Adj:	1.00	1.00	1.00	1.00	1.00	1.00	1.00	1.00	1.00	1.00	1.00	1.00
FinalVolume:	192	862	159	386	1307	148	206	1149	286	188	860	146

Saturation Flow Module:

Sat/Lane:	1600	1600	1600	1600	1600	1600	1600	1600	1600	1600	1600	1600
Adjustment:	1.00	1.06	1.00	1.00	1.05	1.00	1.00	1.06	1.00	1.00	1.06	1.00
Lanes:	2.00	2.00	1.00	2.00	2.69	0.31	1.00	3.00	1.00	1.00	3.00	1.00
Final Sat.:	3200	3400	1600	3200	4512	488	1600	5100	1600	1600	5100	1600

Capacity Analysis Module:

Vol/Sat:	0.06	0.25	0.10	0.12	0.29	0.30	0.13	0.23	0.18	0.12	0.17	0.09
Crit Moves:	****			****			****			****		

Santa Ana Circulation Element

Level Of Service Computation Report

ICU 1(Loss as Cycle Length %) Method (Base Volume Alternative)

Intersection #37 Bristol St and Segerstrom Ave

Cycle (sec): 100 Critical Vol./Cap.(X): 0.794
Loss Time (sec): 5 Average Delay (sec/veh): xxxxxx
Optimal Cycle: 51 Level Of Service: C

Table with 4 columns: North Bound, South Bound, East Bound, West Bound. Rows include Movement (L-T-R), Control, Rights, Min. Green, Y+R, and Lanes.

Volume Module: Table with 12 columns representing different volume categories and 12 rows of adjustment factors like Growth Adj, PHF Adj, etc.

Saturation Flow Module: Table with 12 columns and 4 rows showing Sat/Lane, Adjustment, Lanes, and Final Sat.

Capacity Analysis Module: Table with 12 columns and 3 rows showing Vol/Sat and Crit Moves.

Santa Ana Circulation Element

Level Of Service Computation Report

ICU 1(Loss as Cycle Length %) Method (Base Volume Alternative)

Intersection #38 Bristol St and Alton Ave

Cycle (sec): 100 Critical Vol./Cap.(X): 0.556
Loss Time (sec): 5 Average Delay (sec/veh): xxxxxx
Optimal Cycle: 26 Level Of Service: A

Table with 4 columns: North Bound, South Bound, East Bound, West Bound. Rows include Movement (L-T-R), Control, Rights, Min. Green, Y+R, and Lanes.

Volume Module: Table with 12 columns representing different traffic volumes and adjustment factors like Growth Adj, Initial Bse, User Adj, etc.

Saturation Flow Module: Table with 12 columns showing saturation flow rates and adjustment factors for each lane.

Capacity Analysis Module: Table with 12 columns showing volume-to-saturation ratios and critical moves.

Santa Ana Circulation Element

Level Of Service Computation Report

ICU 1(Loss as Cycle Length %) Method (Base Volume Alternative)

Intersection #39 Bristol St and MacArthur Blvd

Cycle (sec): 100 Critical Vol./Cap.(X): 0.738
 Loss Time (sec): 5 Average Delay (sec/veh): xxxxxx
 Optimal Cycle: 42 Level Of Service: C

Approach:	North Bound			South Bound			East Bound			West Bound		
Movement:	L	T	R	L	T	R	L	T	R	L	T	R
Control:	Protected			Protected			Protected			Protected		
Rights:	Include			Include			Include			Include		
Min. Green:	0	0	0	0	0	0	0	0	0	0	0	0
Y+R:	4.0	4.0	4.0	4.0	4.0	4.0	4.0	4.0	4.0	4.0	4.0	4.0
Lanes:	2	0	3	0	1		2	0	2	1	0	

Volume Module:

Base Vol:	92	478	120	326	1419	148	192	1394	283	191	910	132
Growth Adj:	1.00	1.00	1.00	1.00	1.00	1.00	1.00	1.00	1.00	1.00	1.00	1.00
Initial Bse:	92	478	120	326	1419	148	192	1394	283	191	910	132
User Adj:	1.00	1.00	1.00	1.00	1.00	1.00	1.00	1.00	1.00	1.00	1.00	1.00
PHF Adj:	1.00	1.00	1.00	1.00	1.00	1.00	1.00	1.00	1.00	1.00	1.00	1.00
PHF Volume:	92	478	120	326	1419	148	192	1394	283	191	910	132
Reduct Vol:	0	0	0	0	0	0	0	0	0	0	0	0
Reduced Vol:	92	478	120	326	1419	148	192	1394	283	191	910	132
PCE Adj:	1.00	1.00	1.00	1.00	1.00	1.00	1.00	1.00	1.00	1.00	1.00	1.00
MLF Adj:	1.00	1.00	1.00	1.00	1.00	1.00	1.00	1.00	1.00	1.00	1.00	1.00
FinalVolume:	92	478	120	326	1419	148	192	1394	283	191	910	132

Saturation Flow Module:

Sat/Lane:	1600	1600	1600	1600	1600	1600	1600	1600	1600	1600	1600	1600
Adjustment:	1.00	1.06	1.00	1.00	1.05	1.00	1.00	1.06	1.00	1.00	1.06	1.00
Lanes:	2.00	3.00	1.00	2.00	2.72	0.28	2.00	3.00	1.00	2.00	3.00	1.00
Final Sat.:	3200	5100	1600	3200	4547	453	3200	5100	1600	3200	5100	1600

Capacity Analysis Module:

Vol/Sat:	0.03	0.09	0.08	0.10	0.31	0.33	0.06	0.27	0.18	0.06	0.18	0.08
Crit Moves:	****					****	****			****		

Santa Ana Circulation Element

Level Of Service Computation Report

ICU 1(Loss as Cycle Length %) Method (Base Volume Alternative)

Intersection #40 Bristol St and Sunflower Ave

Cycle (sec): 100 Critical Vol./Cap.(X): 0.635
Loss Time (sec): 5 Average Delay (sec/veh): xxxxxx
Optimal Cycle: 31 Level Of Service: B

Table with 4 columns: North Bound, South Bound, East Bound, West Bound. Rows include Movement (L-T-R), Control (Protected), Rights (Include), Min. Green, Y+R, and Lanes.

Volume Module table with 12 columns and 12 rows including Base Vol, Growth Adj, Initial Bse, User Adj, PHF Adj, PHF Volume, Reduct Vol, Reduced Vol, PCE Adj, MLF Adj, and Final Volume.

Saturation Flow Module table with 12 columns and 4 rows including Sat/Lane, Adjustment, Lanes, and Final Sat.

Capacity Analysis Module table with 12 columns and 2 rows including Vol/Sat and Crit Moves.

Santa Ana Circulation Element

Level Of Service Computation Report
 2000 HCM Operations Method (Base Volume Alternative)

 Intersection #41 Bristol St and I-405 WB Ramps

Cycle (sec): 100 Critical Vol./Cap.(X): 0.500
 Loss Time (sec): 5 Average Delay (sec/veh): 19.1
 Optimal Cycle: 25 Level Of Service: B

Approach:	North Bound			South Bound			East Bound			West Bound		
Movement:	L	T	R	L	T	R	L	T	R	L	T	R
Control:	Protected			Protected			Split Phase			Split Phase		
Rights:	Ignore			Include			Include			Ovl		
Min. Green:	0	0	0	0	0	0	0	0	0	0	0	0
Y+R:	4.0	4.0	4.0	4.0	4.0	4.0	4.0	4.0	4.0	4.0	4.0	4.0
Lanes:	0	0	4	0	0	4	0	0	0	1	1	0

Volume Module:	North Bound			South Bound			East Bound			West Bound		
Base Vol:	0	1489	191	0	1967	8	0	0	34	121	73	665
Growth Adj:	1.00	1.00	1.00	1.00	1.00	1.00	1.00	1.00	1.00	1.00	1.00	1.00
Initial Bse:	0	1489	191	0	1967	8	0	0	34	121	73	665
User Adj:	1.00	1.00	0.00	1.00	1.00	1.00	1.00	1.00	1.00	1.00	1.00	1.00
PHF Adj:	1.00	1.00	0.00	1.00	1.00	1.00	1.00	1.00	1.00	1.00	1.00	1.00
PHF Volume:	0	1489	0	0	1967	8	0	0	34	121	73	665
Reduct Vol:	0	0	0	0	0	0	0	0	0	0	0	0
Reduced Vol:	0	1489	0	0	1967	8	0	0	34	121	73	665
PCE Adj:	1.00	1.00	0.00	1.00	1.00	1.00	1.00	1.00	1.00	1.00	1.00	1.00
MLF Adj:	1.00	1.00	0.00	1.00	1.00	1.00	1.00	1.00	1.00	1.00	1.00	1.00
FinalVolume:	0	1489	0	0	1967	8	0	0	34	121	73	665

Saturation Flow Module:	North Bound			South Bound			East Bound			West Bound		
Sat/Lane:	1900	1900	1900	1900	1900	1900	1900	1900	1900	1900	1900	1900
Adjustment:	1.00	0.91	1.00	1.00	0.91	0.91	1.00	1.00	0.75	0.92	0.92	0.75
Lanes:	0.00	4.00	1.00	0.00	4.98	0.02	0.00	0.00	2.00	1.87	1.13	2.00
Final Sat.:	0	6916	1900	0	8601	35	0	0	2842	3276	1976	2842

Capacity Analysis Module:	North Bound			South Bound			East Bound			West Bound		
Vol/Sat:	0.00	0.22	0.00	0.00	0.23	0.23	0.00	0.00	0.01	0.04	0.04	0.23
Crit Moves:	****			****					****			****
Green/Cycle:	0.00	0.46	0.00	0.00	0.46	0.46	0.00	0.00	0.02	0.47	0.47	0.47
Volume/Cap:	0.00	0.47	0.00	0.00	0.50	0.50	0.00	0.00	0.50	0.08	0.08	0.50
Delay/Veh:	0.0	18.8	0.0	0.0	19.2	19.2	0.0	0.0	53.9	14.7	14.7	18.7
User DelAdj:	1.00	1.00	1.00	1.00	1.00	1.00	1.00	1.00	1.00	1.00	1.00	1.00
AdjDel/Veh:	0.0	18.8	0.0	0.0	19.2	19.2	0.0	0.0	53.9	14.7	14.7	18.7
LOS by Move:	A	B	A	A	B	B	A	A	D	B	B	B
HCM2k85thQ:	0	13	0	0	14	14	0	0	2	2	2	13

 Note: Queue reported is the number of cars per lane.

Santa Ana Circulation Element

Level Of Service Computation Report
 2000 HCM Operations Method (Base Volume Alternative)

 Intersection #42 Bristol St and I-405 EB Ramps

Cycle (sec): 100 Critical Vol./Cap.(X): 0.607
 Loss Time (sec): 5 Average Delay (sec/veh): 22.3
 Optimal Cycle: 31 Level Of Service: C

Approach:	North Bound			South Bound			East Bound			West Bound		
Movement:	L	T	R	L	T	R	L	T	R	L	T	R
Control:	Protected			Protected			Split Phase			Split Phase		
Rights:	Include			Ignore			Include			Include		
Min. Green:	0	0	0	0	0	0	0	0	0	0	0	0
Y+R:	4.0	4.0	4.0	4.0	4.0	4.0	4.0	4.0	4.0	4.0	4.0	4.0
Lanes:	1	0	4	0	0	2	1	1	3	0	0	0

Volume Module:	North Bound			South Bound			East Bound			West Bound		
Base Vol:	113	1108	0	0	985	847	573	0	524	0	0	0
Growth Adj:	1.00	1.00	1.00	1.00	1.00	1.00	1.00	1.00	1.00	1.00	1.00	1.00
Initial Bse:	113	1108	0	0	985	847	573	0	524	0	0	0
User Adj:	1.00	1.00	1.00	1.00	1.00	0.00	1.00	1.00	1.00	1.00	1.00	1.00
PHF Adj:	1.00	1.00	1.00	1.00	1.00	0.00	1.00	1.00	1.00	1.00	1.00	1.00
PHF Volume:	113	1108	0	0	985	0	573	0	524	0	0	0
Reduct Vol:	0	0	0	0	0	0	0	0	0	0	0	0
Reduced Vol:	113	1108	0	0	985	0	573	0	524	0	0	0
PCE Adj:	1.00	1.00	1.00	1.00	1.00	0.00	1.00	1.00	1.00	1.00	1.00	1.00
MLF Adj:	1.00	1.00	1.00	1.00	1.00	0.00	1.00	1.00	1.00	1.00	1.00	1.00
FinalVolume:	113	1108	0	0	985	0	573	0	524	0	0	0

Saturation Flow Module:	North Bound			South Bound			East Bound			West Bound		
Sat/Lane:	1900	1900	1900	1900	1900	1900	1900	1900	1900	1900	1900	1900
Adjustment:	0.95	0.91	1.00	1.00	0.91	0.91	0.92	1.00	0.85	1.00	1.00	1.00
Lanes:	1.00	4.00	0.00	0.00	3.00	1.00	3.00	0.00	1.00	0.00	0.00	0.00
Final Sat.:	1805	6916	0	0	5187	1729	5253	0	1615	0	0	0

Capacity Analysis Module:	North Bound			South Bound			East Bound			West Bound		
Vol/Sat:	0.06	0.16	0.00	0.00	0.19	0.00	0.11	0.00	0.32	0.00	0.00	0.00
Crit Moves:	****			****					****			
Green/Cycle:	0.10	0.42	0.00	0.00	0.31	0.00	0.53	0.00	0.53	0.00	0.00	0.00
Volume/Cap:	0.61	0.39	0.00	0.00	0.61	0.00	0.20	0.00	0.61	0.00	0.00	0.00
Delay/Veh:	48.6	20.4	0.0	0.0	29.8	0.0	12.2	0.0	17.3	0.0	0.0	0.0
User DelAdj:	1.00	1.00	1.00	1.00	1.00	1.00	1.00	1.00	1.00	1.00	1.00	1.00
AdjDel/Veh:	48.6	20.4	0.0	0.0	29.8	0.0	12.2	0.0	17.3	0.0	0.0	0.0
LOS by Move:	D	C	A	A	C	A	B	A	B	A	A	A
HCM2k85thQ:	7	10	0	0	15	0	5	0	17	0	0	0

 Note: Queue reported is the number of cars per lane.

Santa Ana Circulation Element

Level Of Service Computation Report

ICU 1(Loss as Cycle Length %) Method (Base Volume Alternative)

Intersection #43 Flower St and Santa Ana Blvd

Cycle (sec): 100 Critical Vol./Cap.(X): 0.596
 Loss Time (sec): 5 Average Delay (sec/veh): xxxxxx
 Optimal Cycle: 29 Level Of Service: A

Approach:	North Bound			South Bound			East Bound			West Bound		
Movement:	L	T	R	L	T	R	L	T	R	L	T	R
Control:	Prot+Permit			Prot+Permit			Prot+Permit			Prot+Permit		
Rights:	Include			Include			Include			Include		
Min. Green:	0	0	0	0	0	0	0	0	0	0	0	0
Y+R:	4.0	4.0	4.0	4.0	4.0	4.0	4.0	4.0	4.0	4.0	4.0	4.0
Lanes:	1	0	2	0	1	1	1	0	3	0	1	1

Volume Module:

Base Vol:	87	811	118	168	568	76	114	710	81	101	323	135
Growth Adj:	1.00	1.00	1.00	1.00	1.00	1.00	1.00	1.00	1.00	1.00	1.00	1.00
Initial Bse:	87	811	118	168	568	76	114	710	81	101	323	135
User Adj:	1.00	1.00	1.00	1.00	1.00	1.00	1.00	1.00	1.00	1.00	1.00	1.00
PHF Adj:	1.00	1.00	1.00	1.00	1.00	1.00	1.00	1.00	1.00	1.00	1.00	1.00
PHF Volume:	87	811	118	168	568	76	114	710	81	101	323	135
Reduct Vol:	0	0	0	0	0	0	0	0	0	0	0	0
Reduced Vol:	87	811	118	168	568	76	114	710	81	101	323	135
PCE Adj:	1.00	1.00	1.00	1.00	1.00	1.00	1.00	1.00	1.00	1.00	1.00	1.00
MLF Adj:	1.00	1.00	1.00	1.00	1.00	1.00	1.00	1.00	1.00	1.00	1.00	1.00
FinalVolume:	87	811	118	168	568	76	114	710	81	101	323	135

Saturation Flow Module:

Sat/Lane:	1600	1600	1600	1600	1600	1600	1600	1600	1600	1600	1600	1600
Adjustment:	1.00	1.06	1.00	1.00	1.06	1.00	1.00	1.06	1.00	1.00	1.06	1.00
Lanes:	1.00	2.00	1.00	1.00	2.00	1.00	1.00	3.00	1.00	1.00	2.00	1.00
Final Sat.:	1600	3400	1600	1600	3400	1600	1600	5100	1600	1600	3400	1600

Capacity Analysis Module:

Vol/Sat:	0.05	0.24	0.07	0.11	0.17	0.05	0.07	0.14	0.05	0.06	0.10	0.08
Crit Moves:	****			****			****			****		

Santa Ana Circulation Element

Level Of Service Computation Report

ICU 1(Loss as Cycle Length %) Method (Base Volume Alternative)

Intersection #44 Flower St and 1st St

Cycle (sec): 100 Critical Vol./Cap.(X): 0.795
 Loss Time (sec): 5 Average Delay (sec/veh): xxxxxx
 Optimal Cycle: 51 Level Of Service: C

Approach:	North Bound			South Bound			East Bound			West Bound		
Movement:	L	T	R	L	T	R	L	T	R	L	T	R
Control:	Protected			Protected			Protected			Protected		
Rights:	Include			Include			Include			Include		
Min. Green:	0	0	0	0	0	0	0	0	0	0	0	0
Y+R:	4.0	4.0	4.0	4.0	4.0	4.0	4.0	4.0	4.0	4.0	4.0	4.0
Lanes:	1	0	2	0	1	1	0	1	0	1	0	2

Volume Module:

Base Vol:	139	602	159	175	554	58	165	1514	60	209	861	123
Growth Adj:	1.00	1.00	1.00	1.00	1.00	1.00	1.00	1.00	1.00	1.00	1.00	1.00
Initial Bse:	139	602	159	175	554	58	165	1514	60	209	861	123
User Adj:	1.00	1.00	1.00	1.00	1.00	1.00	1.00	1.00	1.00	1.00	1.00	1.00
PHF Adj:	1.00	1.00	1.00	1.00	1.00	1.00	1.00	1.00	1.00	1.00	1.00	1.00
PHF Volume:	139	602	159	175	554	58	165	1514	60	209	861	123
Reduct Vol:	0	0	0	0	0	0	0	0	0	0	0	0
Reduced Vol:	139	602	159	175	554	58	165	1514	60	209	861	123
PCE Adj:	1.00	1.00	1.00	1.00	1.00	1.00	1.00	1.00	1.00	1.00	1.00	1.00
MLF Adj:	1.00	1.00	1.00	1.00	1.00	1.00	1.00	1.00	1.00	1.00	1.00	1.00
FinalVolume:	139	602	159	175	554	58	165	1514	60	209	861	123

Saturation Flow Module:

Sat/Lane:	1600	1600	1600	1600	1600	1600	1600	1600	1600	1600	1600	1600
Adjustment:	1.00	1.06	1.00	1.00	1.03	1.00	1.00	1.04	1.00	1.00	1.05	1.00
Lanes:	1.00	2.00	1.00	1.00	1.81	0.19	1.00	2.89	0.11	1.00	2.62	0.38
Final Sat.:	1600	3400	1600	1600	2997	303	1600	4817	183	1600	4400	600

Capacity Analysis Module:

Vol/Sat:	0.09	0.18	0.10	0.11	0.18	0.19	0.10	0.31	0.33	0.13	0.20	0.21
Crit Moves:	****			****			****			****		

Santa Ana Circulation Element

Level Of Service Computation Report

ICU 1(Loss as Cycle Length %) Method (Base Volume Alternative)

Intersection #45 Flower St and McFadden Ave

Cycle (sec): 100 Critical Vol./Cap.(X): 0.819
 Loss Time (sec): 5 Average Delay (sec/veh): xxxxxx
 Optimal Cycle: 56 Level Of Service: D

Approach:	North Bound			South Bound			East Bound			West Bound		
Movement:	L	T	R	L	T	R	L	T	R	L	T	R
Control:	Permitted			Permitted			Permitted			Permitted		
Rights:	Include			Include			Include			Include		
Min. Green:	0	0	0	0	0	0	0	0	0	0	0	0
Y+R:	4.0	4.0	4.0	4.0	4.0	4.0	4.0	4.0	4.0	4.0	4.0	4.0
Lanes:	1	0	0	1	0	0	1	0	0	1	0	0

Volume Module:

Base Vol:	60	438	38	66	367	53	51	581	44	64	432	58
Growth Adj:	1.00	1.00	1.00	1.00	1.00	1.00	1.00	1.00	1.00	1.00	1.00	1.00
Initial Bse:	60	438	38	66	367	53	51	581	44	64	432	58
User Adj:	1.00	1.00	1.00	1.00	1.00	1.00	1.00	1.00	1.00	1.00	1.00	1.00
PHF Adj:	1.00	1.00	1.00	1.00	1.00	1.00	1.00	1.00	1.00	1.00	1.00	1.00
PHF Volume:	60	438	38	66	367	53	51	581	44	64	432	58
Reduct Vol:	0	0	0	0	0	0	0	0	0	0	0	0
Reduced Vol:	60	438	38	66	367	53	51	581	44	64	432	58
PCE Adj:	1.00	1.00	1.00	1.00	1.00	1.00	1.00	1.00	1.00	1.00	1.00	1.00
MLF Adj:	1.00	1.00	1.00	1.00	1.00	1.00	1.00	1.00	1.00	1.00	1.00	1.00
FinalVolume:	60	438	38	66	367	53	51	581	44	64	432	58

Saturation Flow Module:

Sat/Lane:	1600	1600	1600	1600	1600	1600	1600	1600	1600	1600	1600	1600
Adjustment:	1.00	1.00	1.00	1.00	1.00	1.00	1.00	1.00	1.00	1.00	1.00	1.00
Lanes:	1.00	0.92	0.08	1.00	0.87	0.13	1.00	0.93	0.07	1.00	0.88	0.12
Final Sat.:	1600	1472	128	1600	1398	202	1600	1487	113	1600	1411	189

Capacity Analysis Module:

Vol/Sat:	0.04	0.30	0.30	0.04	0.26	0.26	0.03	0.39	0.39	0.04	0.31	0.31
Crit Moves:	****			****			****			****		

Santa Ana Circulation Element

Level Of Service Computation Report

ICU 1(Loss as Cycle Length %) Method (Base Volume Alternative)

Intersection #46 Flower St and Segerstrom Ave

Cycle (sec): 100 Critical Vol./Cap.(X): 0.769
 Loss Time (sec): 5 Average Delay (sec/veh): xxxxxx
 Optimal Cycle: 46 Level Of Service: C

Approach:	North Bound			South Bound			East Bound			West Bound		
Movement:	L	T	R	L	T	R	L	T	R	L	T	R
Control:	Permitted			Permitted			Protected			Protected		
Rights:	Include			Include			Include			Include		
Min. Green:	0	0	0	0	0	0	0	0	0	0	0	0
Y+R:	4.0	4.0	4.0	4.0	4.0	4.0	4.0	4.0	4.0	4.0	4.0	4.0
Lanes:	1	0	1	1	0	1	1	0	1	1	0	1

Volume Module:

Base Vol:	63	331	73	98	544	120	155	1065	297	74	546	60
Growth Adj:	1.00	1.00	1.00	1.00	1.00	1.00	1.00	1.00	1.00	1.00	1.00	1.00
Initial Bse:	63	331	73	98	544	120	155	1065	297	74	546	60
User Adj:	1.00	1.00	1.00	1.00	1.00	1.00	1.00	1.00	1.00	1.00	1.00	1.00
PHF Adj:	1.00	1.00	1.00	1.00	1.00	1.00	1.00	1.00	1.00	1.00	1.00	1.00
PHF Volume:	63	331	73	98	544	120	155	1065	297	74	546	60
Reduct Vol:	0	0	0	0	0	0	0	0	0	0	0	0
Reduced Vol:	63	331	73	98	544	120	155	1065	297	74	546	60
PCE Adj:	1.00	1.00	1.00	1.00	1.00	1.00	1.00	1.00	1.00	1.00	1.00	1.00
MLF Adj:	1.00	1.00	1.00	1.00	1.00	1.00	1.00	1.00	1.00	1.00	1.00	1.00
FinalVolume:	63	331	73	98	544	120	155	1065	297	74	546	60

Saturation Flow Module:

Sat/Lane:	1600	1600	1600	1600	1600	1600	1600	1600	1600	1600	1600	1600
Adjustment:	1.00	1.04	1.00	1.00	1.04	1.00	1.00	1.04	1.00	1.00	1.03	1.00
Lanes:	1.00	1.64	0.36	1.00	1.64	0.36	1.00	1.56	0.44	1.00	1.80	0.20
Final Sat.:	1600	2722	578	1600	2722	578	1600	2602	698	1600	2983	317

Capacity Analysis Module:

Vol/Sat:	0.04	0.12	0.13	0.06	0.20	0.21	0.10	0.41	0.43	0.05	0.18	0.19
Crit Moves:	****					****			****	****		

Santa Ana Circulation Element

Level Of Service Computation Report

ICU 1(Loss as Cycle Length %) Method (Base Volume Alternative)

Intersection #47 Flower St and MacArthur Blvd

Cycle (sec): 100 Critical Vol./Cap.(X): 0.698
 Loss Time (sec): 5 Average Delay (sec/veh): xxxxxx
 Optimal Cycle: 37 Level Of Service: B

Approach:	North Bound			South Bound			East Bound			West Bound		
Movement:	L	T	R	L	T	R	L	T	R	L	T	R
Control:	Permitted			Permitted			Protected			Protected		
Rights:	Include			Include			Include			Include		
Min. Green:	0	0	0	0	0	0	0	0	0	0	0	0
Y+R:	4.0	4.0	4.0	4.0	4.0	4.0	4.0	4.0	4.0	4.0	4.0	4.0
Lanes:	1	0	1	1	0	1	1	0	2	1	0	2

Volume Module:

Base Vol:	22	142	73	163	352	264	165	1879	80	54	909	58
Growth Adj:	1.00	1.00	1.00	1.00	1.00	1.00	1.00	1.00	1.00	1.00	1.00	1.00
Initial Bse:	22	142	73	163	352	264	165	1879	80	54	909	58
User Adj:	1.00	1.00	1.00	1.00	1.00	1.00	1.00	1.00	1.00	1.00	1.00	1.00
PHF Adj:	1.00	1.00	1.00	1.00	1.00	1.00	1.00	1.00	1.00	1.00	1.00	1.00
PHF Volume:	22	142	73	163	352	264	165	1879	80	54	909	58
Reduct Vol:	0	0	0	0	0	0	0	0	0	0	0	0
Reduced Vol:	22	142	73	163	352	264	165	1879	80	54	909	58
PCE Adj:	1.00	1.00	1.00	1.00	1.00	1.00	1.00	1.00	1.00	1.00	1.00	1.00
MLF Adj:	1.00	1.00	1.00	1.00	1.00	1.00	1.00	1.00	1.00	1.00	1.00	1.00
Final Volume:	22	142	73	163	352	264	165	1879	80	54	909	58

Saturation Flow Module:

Sat/Lane:	1600	1600	1600	1600	1600	1600	1600	1600	1600	1600	1600	1600
Adjustment:	1.00	1.05	1.00	1.00	1.05	1.00	1.00	1.04	1.00	1.00	1.04	1.00
Lanes:	1.00	1.32	0.68	1.00	1.14	0.86	1.00	2.88	0.12	1.00	2.82	0.18
Final Sat.:	1600	2213	1087	1600	1929	1371	1600	4804	196	1600	4712	288

Capacity Analysis Module:

Vol/Sat:	0.01	0.06	0.07	0.10	0.18	0.19	0.10	0.39	0.41	0.03	0.19	0.20
Crit Moves:	****					****			****	****		

Santa Ana Circulation Element

Level Of Service Computation Report

ICU 1(Loss as Cycle Length %) Method (Base Volume Alternative)

Intersection #48 Main St and La Veta Ave

Cycle (sec): 100 Critical Vol./Cap.(X): 0.574
 Loss Time (sec): 5 Average Delay (sec/veh): xxxxxx
 Optimal Cycle: 27 Level Of Service: A

Approach:	North Bound			South Bound			East Bound			West Bound								
Movement:	L	T	R	L	T	R	L	T	R	L	T	R						
Control:	Protected			Protected			Protected			Protected								
Rights:	Ovl			Include			Include			Ovl								
Min. Green:	0	0	0	0	0	0	0	0	0	0	0	0						
Y+R:	4.0	4.0	4.0	4.0	4.0	4.0	4.0	4.0	4.0	4.0	4.0	4.0						
Lanes:	2	0	3	0	1		2	0	2	1	0		2	0	2	0	1	

Volume Module:

Base Vol:	84	579	300	198	1034	173	350	495	215	316	276	230
Growth Adj:	1.00	1.00	1.00	1.00	1.00	1.00	1.00	1.00	1.00	1.00	1.00	1.00
Initial Bse:	84	579	300	198	1034	173	350	495	215	316	276	230
User Adj:	1.00	1.00	1.00	1.00	1.00	1.00	1.00	1.00	1.00	1.00	1.00	1.00
PHF Adj:	1.00	1.00	1.00	1.00	1.00	1.00	1.00	1.00	1.00	1.00	1.00	1.00
PHF Volume:	84	579	300	198	1034	173	350	495	215	316	276	230
Reduct Vol:	0	0	0	0	0	0	0	0	0	0	0	0
Reduced Vol:	84	579	300	198	1034	173	350	495	215	316	276	230
PCE Adj:	1.00	1.00	1.00	1.00	1.00	1.00	1.00	1.00	1.00	1.00	1.00	1.00
MLF Adj:	1.00	1.00	1.00	1.00	1.00	1.00	1.00	1.00	1.00	1.00	1.00	1.00
FinalVolume:	84	579	300	198	1034	173	350	495	215	316	276	230
OvlAdjVol:	142									131		

Saturation Flow Module:

Sat/Lane:	1600	1600	1600	1600	1600	1600	1600	1600	1600	1600	1600	1600
Adjustment:	1.00	1.06	1.00	1.00	1.05	1.00	1.00	1.06	1.00	1.00	1.06	1.00
Lanes:	2.00	3.00	1.00	2.00	2.57	0.43	2.00	2.09	0.91	2.00	2.00	1.00
Final Sat.:	3200	5100	1600	3200	4312	688	3200	3546	1454	3200	3400	1600

Capacity Analysis Module:

Vol/Sat:	0.03	0.11	0.19	0.06	0.24	0.25	0.11	0.14	0.15	0.10	0.08	0.14
OvlAdjV/S:	0.09									0.08		
Crit Moves:	****			****			****			****		

Santa Ana Circulation Element

Level Of Service Computation Report

ICU 1(Loss as Cycle Length %) Method (Base Volume Alternative)

Intersection #49 Main St and Mainplace Dr / Memory Ln

Cycle (sec): 100 Critical Vol./Cap.(X): 0.485
 Loss Time (sec): 5 Average Delay (sec/veh): xxxxxx
 Optimal Cycle: 23 Level Of Service: A

Approach:	North Bound			South Bound			East Bound			West Bound		
Movement:	L	T	R	L	T	R	L	T	R	L	T	R
Control:	Protected			Protected			Protected			Protected		
Rights:	Include			Include			Include			Include		
Min. Green:	0	0	0	0	0	0	0	0	0	0	0	0
Y+R:	4.0	4.0	4.0	4.0	4.0	4.0	4.0	4.0	4.0	4.0	4.0	4.0
Lanes:	2	0	2	1	0	0	2	0	2	1	0	1

Volume Module:

Base Vol:	28	764	250	32	1244	260	148	233	16	198	226	15
Growth Adj:	1.00	1.00	1.00	1.00	1.00	1.00	1.00	1.00	1.00	1.00	1.00	1.00
Initial Bse:	28	764	250	32	1244	260	148	233	16	198	226	15
User Adj:	1.00	1.00	1.00	1.00	1.00	1.00	1.00	1.00	1.00	1.00	1.00	1.00
PHF Adj:	1.00	1.00	1.00	1.00	1.00	1.00	1.00	1.00	1.00	1.00	1.00	1.00
PHF Volume:	28	764	250	32	1244	260	148	233	16	198	226	15
Reduct Vol:	0	0	0	0	0	0	0	0	0	0	0	0
Reduced Vol:	28	764	250	32	1244	260	148	233	16	198	226	15
PCE Adj:	1.00	1.00	1.00	1.00	1.00	1.00	1.00	1.00	1.00	1.00	1.00	1.00
MLF Adj:	1.00	1.00	1.00	1.00	1.00	1.00	1.00	1.00	1.00	1.00	1.00	1.00
FinalVolume:	28	764	250	32	1244	260	148	233	16	198	226	15

Saturation Flow Module:

Sat/Lane:	1600	1600	1600	1600	1600	1600	1600	1600	1600	1600	1600	1600
Adjustment:	1.00	1.06	1.00	1.00	1.05	1.00	1.00	1.04	1.00	1.00	1.06	1.00
Lanes:	2.00	2.26	0.74	2.00	2.48	0.52	2.00	2.81	0.19	2.00	2.00	1.00
Final Sat.:	3200	3817	1183	3200	4170	830	3200	4692	308	3200	3400	1600

Capacity Analysis Module:

Vol/Sat:	0.01	0.20	0.21	0.01	0.30	0.31	0.05	0.05	0.05	0.06	0.07	0.01
Crit Moves:	****					****	****				****	

Santa Ana Circulation Element

Level Of Service Computation Report

ICU 1(Loss as Cycle Length %) Method (Base Volume Alternative)

Intersection #50 Main St and 17th St

Cycle (sec): 100 Critical Vol./Cap.(X): 0.821
Loss Time (sec): 5 Average Delay (sec/veh): xxxxxx
Optimal Cycle: 57 Level Of Service: D

Table with 4 columns: North Bound, South Bound, East Bound, West Bound. Rows include Movement, Control, Rights, Min. Green, Y+R, and Lanes.

Volume Module: Table with 12 columns representing traffic volumes and adjustment factors for various conditions like Base Vol, Growth Adj, etc.

Saturation Flow Module: Table with 12 columns representing saturation flow rates and adjustment factors for different lane configurations.

Capacity Analysis Module: Table with 12 columns representing capacity analysis metrics like Vol/Sat and Crit Moves.

Santa Ana Circulation Element

Level Of Service Computation Report

ICU 1(Loss as Cycle Length %) Method (Base Volume Alternative)

Intersection #51 Main St and Civic Center Dr

Cycle (sec): 100 Critical Vol./Cap.(X): 0.755
 Loss Time (sec): 5 Average Delay (sec/veh): xxxxxx
 Optimal Cycle: 44 Level Of Service: C

Approach:	North Bound			South Bound			East Bound			West Bound		
Movement:	L	T	R	L	T	R	L	T	R	L	T	R
Control:	Permitted			Permitted			Permitted			Permitted		
Rights:	Include			Include			Include			Include		
Min. Green:	0	0	0	0	0	0	0	0	0	0	0	0
Y+R:	4.0	4.0	4.0	4.0	4.0	4.0	4.0	4.0	4.0	4.0	4.0	4.0
Lanes:	1	0	1	1	0	1	1	0	1	1	0	1

Volume Module:

Base Vol:	138	901	79	59	1042	159	90	545	99	43	566	34
Growth Adj:	1.00	1.00	1.00	1.00	1.00	1.00	1.00	1.00	1.00	1.00	1.00	1.00
Initial Bse:	138	901	79	59	1042	159	90	545	99	43	566	34
User Adj:	1.00	1.00	1.00	1.00	1.00	1.00	1.00	1.00	1.00	1.00	1.00	1.00
PHF Adj:	1.00	1.00	1.00	1.00	1.00	1.00	1.00	1.00	1.00	1.00	1.00	1.00
PHF Volume:	138	901	79	59	1042	159	90	545	99	43	566	34
Reduct Vol:	0	0	0	0	0	0	0	0	0	0	0	0
Reduced Vol:	138	901	79	59	1042	159	90	545	99	43	566	34
PCE Adj:	1.00	1.00	1.00	1.00	1.00	1.00	1.00	1.00	1.00	1.00	1.00	1.00
MLF Adj:	1.00	1.00	1.00	1.00	1.00	1.00	1.00	1.00	1.00	1.00	1.00	1.00
FinalVolume:	138	901	79	59	1042	159	90	545	99	43	566	34

Saturation Flow Module:

Sat/Lane:	1600	1600	1600	1600	1600	1600	1600	1600	1600	1600	1600	1600
Adjustment:	1.00	1.03	1.00	1.00	1.04	1.00	1.00	1.04	1.00	1.00	1.03	1.00
Lanes:	1.00	1.84	0.16	1.00	1.74	0.26	1.00	1.69	0.31	1.00	1.89	0.11
Final Sat.:	1600	3042	258	1600	2876	424	1600	2808	492	1600	3119	181

Capacity Analysis Module:

Vol/Sat:	0.09	0.30	0.31	0.04	0.36	0.38	0.06	0.19	0.20	0.03	0.18	0.19
Crit Moves:	****					****	****					****

Santa Ana Circulation Element

Level Of Service Computation Report

ICU 1(Loss as Cycle Length %) Method (Base Volume Alternative)

Intersection #52 Main St and Santa Ana Blvd

Cycle (sec): 100 Critical Vol./Cap.(X): 0.667
 Loss Time (sec): 5 Average Delay (sec/veh): xxxxxx
 Optimal Cycle: 34 Level Of Service: B

Approach:	North Bound			South Bound			East Bound			West Bound		
Movement:	L	T	R	L	T	R	L	T	R	L	T	R
Control:	Permitted			Permitted			Permitted			Permitted		
Rights:	Include			Include			Include			Include		
Min. Green:	0	0	0	0	0	0	0	0	0	0	0	0
Y+R:	4.0	4.0	4.0	4.0	4.0	4.0	4.0	4.0	4.0	4.0	4.0	4.0
Lanes:	1	0	2	0	0	1	0	0	0	0	1	1

Volume Module:

Base Vol:	68	1083	0	0	1107	98	0	0	0	61	848	65
Growth Adj:	1.00	1.00	1.00	1.00	1.00	1.00	1.00	1.00	1.00	1.00	1.00	1.00
Initial Bse:	68	1083	0	0	1107	98	0	0	0	61	848	65
User Adj:	1.00	1.00	1.00	1.00	1.00	1.00	1.00	1.00	1.00	1.00	1.00	1.00
PHF Adj:	1.00	1.00	1.00	1.00	1.00	1.00	1.00	1.00	1.00	1.00	1.00	1.00
PHF Volume:	68	1083	0	0	1107	98	0	0	0	61	848	65
Reduct Vol:	0	0	0	0	0	0	0	0	0	0	0	0
Reduced Vol:	68	1083	0	0	1107	98	0	0	0	61	848	65
PCE Adj:	1.00	1.00	1.00	1.00	1.00	1.00	1.00	1.00	1.00	1.00	1.00	1.00
MLF Adj:	1.00	1.00	1.00	1.00	1.00	1.00	1.00	1.00	1.00	1.00	1.00	1.00
FinalVolume:	68	1083	0	0	1107	98	0	0	0	61	848	65

Saturation Flow Module:

Sat/Lane:	1600	1600	1600	1600	1600	1600	1600	1600	1600	1600	1600	1600
Adjustment:	1.00	1.06	1.00	1.00	1.03	1.00	1.00	1.06	1.00	1.00	1.02	1.00
Lanes:	1.00	2.00	0.00	0.00	1.84	0.16	0.00	0.00	0.00	0.19	2.61	0.20
Final Sat.:	1600	3400	0	0	3040	260	0	0	0	301	4279	320

Capacity Analysis Module:

Vol/Sat:	0.04	0.32	0.00	0.00	0.36	0.38	0.00	0.00	0.00	0.04	0.20	0.20
Crit Moves:	****					****					****	

Santa Ana Circulation Element

Level Of Service Computation Report

ICU 1(Loss as Cycle Length %) Method (Base Volume Alternative)

Intersection #53 Main St and 4th St

Cycle (sec): 100 Critical Vol./Cap.(X): 0.490
 Loss Time (sec): 5 Average Delay (sec/veh): xxxxxx
 Optimal Cycle: 23 Level Of Service: A

Approach:	North Bound			South Bound			East Bound			West Bound		
Movement:	L	T	R	L	T	R	L	T	R	L	T	R
Control:	Permitted			Permitted			Permitted			Permitted		
Rights:	Include			Include			Include			Include		
Min. Green:	0	0	0	0	0	0	0	0	0	0	0	0
Y+R:	4.0	4.0	4.0	4.0	4.0	4.0	4.0	4.0	4.0	4.0	4.0	4.0
Lanes:	0	0	1	1	0	0	0	0	1	0	0	1

Volume Module:

Base Vol:	0	977	23	0	1098	27	0	93	14	0	114	28
Growth Adj:	1.00	1.00	1.00	1.00	1.00	1.00	1.00	1.00	1.00	1.00	1.00	1.00
Initial Bse:	0	977	23	0	1098	27	0	93	14	0	114	28
User Adj:	1.00	1.00	1.00	1.00	1.00	1.00	1.00	1.00	1.00	1.00	1.00	1.00
PHF Adj:	1.00	1.00	1.00	1.00	1.00	1.00	1.00	1.00	1.00	1.00	1.00	1.00
PHF Volume:	0	977	23	0	1098	27	0	93	14	0	114	28
Reduct Vol:	0	0	0	0	0	0	0	0	0	0	0	0
Reduced Vol:	0	977	23	0	1098	27	0	93	14	0	114	28
PCE Adj:	1.00	1.00	1.00	1.00	1.00	1.00	1.00	1.00	1.00	1.00	1.00	1.00
MLF Adj:	1.00	1.00	1.00	1.00	1.00	1.00	1.00	1.00	1.00	1.00	1.00	1.00
FinalVolume:	0	977	23	0	1098	27	0	93	14	0	114	28

Saturation Flow Module:

Sat/Lane:	1600	1600	1600	1600	1600	1600	1600	1600	1600	1600	1600	1600
Adjustment:	1.00	1.03	1.00	1.00	1.03	1.00	1.00	1.00	1.00	1.00	1.00	1.00
Lanes:	0.00	1.95	0.05	0.00	1.95	0.05	0.00	0.87	0.13	0.00	0.80	0.20
Final Sat.:	0	3226	74	0	3223	77	0	1391	209	0	1285	315

Capacity Analysis Module:

Vol/Sat:	0.00	0.30	0.31	0.00	0.34	0.35	0.00	0.07	0.07	0.00	0.09	0.09
Crit Moves:	****				****	****	****				****	

Santa Ana Circulation Element

Level Of Service Computation Report

ICU 1(Loss as Cycle Length %) Method (Base Volume Alternative)

Intersection #54 Main St and 1st St

Cycle (sec): 100 Critical Vol./Cap.(X): 0.758
 Loss Time (sec): 5 Average Delay (sec/veh): xxxxxx
 Optimal Cycle: 44 Level Of Service: C

Approach:	North Bound			South Bound			East Bound			West Bound		
Movement:	L	T	R	L	T	R	L	T	R	L	T	R
Control:	Protected			Protected			Protected			Protected		
Rights:	Include			Include			Include			Include		
Min. Green:	0	0	0	0	0	0	0	0	0	0	0	0
Y+R:	4.0	4.0	4.0	4.0	4.0	4.0	4.0	4.0	4.0	4.0	4.0	4.0
Lanes:	1	0	1	1	0	2	1	0	2	1	0	2

Volume Module:

Base Vol:	116	596	60	88	882	65	119	1393	147	88	1097	61
Growth Adj:	1.00	1.00	1.00	1.00	1.00	1.00	1.00	1.00	1.00	1.00	1.00	1.00
Initial Bse:	116	596	60	88	882	65	119	1393	147	88	1097	61
User Adj:	1.00	1.00	1.00	1.00	1.00	1.00	1.00	1.00	1.00	1.00	1.00	1.00
PHF Adj:	1.00	1.00	1.00	1.00	1.00	1.00	1.00	1.00	1.00	1.00	1.00	1.00
PHF Volume:	116	596	60	88	882	65	119	1393	147	88	1097	61
Reduct Vol:	0	0	0	0	0	0	0	0	0	0	0	0
Reduced Vol:	116	596	60	88	882	65	119	1393	147	88	1097	61
PCE Adj:	1.00	1.00	1.00	1.00	1.00	1.00	1.00	1.00	1.00	1.00	1.00	1.00
MLF Adj:	1.00	1.00	1.00	1.00	1.00	1.00	1.00	1.00	1.00	1.00	1.00	1.00
FinalVolume:	116	596	60	88	882	65	119	1393	147	88	1097	61

Saturation Flow Module:

Sat/Lane:	1600	1600	1600	1600	1600	1600	1600	1600	1600	1600	1600	1600
Adjustment:	1.00	1.03	1.00	1.00	1.06	1.00	1.00	1.05	1.00	1.00	1.04	1.00
Lanes:	1.00	1.82	0.18	1.00	2.00	1.00	1.00	2.71	0.29	1.00	2.84	0.16
Final Sat.:	1600	3007	293	1600	3400	1600	1600	4542	458	1600	4747	253

Capacity Analysis Module:

Vol/Sat:	0.07	0.20	0.20	0.06	0.26	0.04	0.07	0.31	0.32	0.06	0.23	0.24
Crit Moves:	****			****			****		****	****		

Santa Ana Circulation Element

Level Of Service Computation Report

ICU 1(Loss as Cycle Length %) Method (Base Volume Alternative)

Intersection #55 Main St and McFadden Ave

Cycle (sec): 100 Critical Vol./Cap.(X): 0.902
 Loss Time (sec): 5 Average Delay (sec/veh): xxxxxx
 Optimal Cycle: 88 Level Of Service: E

Approach:	North Bound			South Bound			East Bound			West Bound		
Movement:	L	T	R	L	T	R	L	T	R	L	T	R
Control:	Prot+Permit			Prot+Permit			Protected			Protected		
Rights:	Include			Include			Include			Include		
Min. Green:	0	0	0	0	0	0	0	0	0	0	0	0
Y+R:	4.0	4.0	4.0	4.0	4.0	4.0	4.0	4.0	4.0	4.0	4.0	4.0
Lanes:	1	0	1	1	0	1	0	0	1	1	0	1

Volume Module:

Base Vol:	89	838	42	175	1364	27	42	396	43	140	373	107
Growth Adj:	1.00	1.00	1.00	1.00	1.00	1.00	1.00	1.00	1.00	1.00	1.00	1.00
Initial Bse:	89	838	42	175	1364	27	42	396	43	140	373	107
User Adj:	1.00	1.00	1.00	1.00	1.00	1.00	1.00	1.00	1.00	1.00	1.00	1.00
PHF Adj:	1.00	1.00	1.00	1.00	1.00	1.00	1.00	1.00	1.00	1.00	1.00	1.00
PHF Volume:	89	838	42	175	1364	27	42	396	43	140	373	107
Reduct Vol:	0	0	0	0	0	0	0	0	0	0	0	0
Reduced Vol:	89	838	42	175	1364	27	42	396	43	140	373	107
PCE Adj:	1.00	1.00	1.00	1.00	1.00	1.00	1.00	1.00	1.00	1.00	1.00	1.00
MLF Adj:	1.00	1.00	1.00	1.00	1.00	1.00	1.00	1.00	1.00	1.00	1.00	1.00
FinalVolume:	89	838	42	175	1364	27	42	396	43	140	373	107

Saturation Flow Module:

Sat/Lane:	1600	1600	1600	1600	1600	1600	1600	1600	1600	1600	1600	1600
Adjustment:	1.00	1.03	1.00	1.00	1.03	1.00	1.00	1.00	1.00	1.00	1.06	1.00
Lanes:	1.00	1.90	0.10	1.00	1.96	0.04	1.00	0.90	0.10	1.00	1.00	1.00
Final Sat.:	1600	3147	153	1600	3238	62	1600	1443	157	1600	1700	1600

Capacity Analysis Module:

Vol/Sat:	0.06	0.27	0.28	0.11	0.42	0.43	0.03	0.27	0.27	0.09	0.22	0.07
Crit Moves:	****					****		****		****		

Santa Ana Circulation Element

Level Of Service Computation Report

ICU 1(Loss as Cycle Length %) Method (Base Volume Alternative)

Intersection #56 Main St and Edinger Ave

Cycle (sec): 100 Critical Vol./Cap.(X): 0.826
 Loss Time (sec): 5 Average Delay (sec/veh): xxxxxx
 Optimal Cycle: 58 Level Of Service: D

Approach:	North Bound			South Bound			East Bound			West Bound		
Movement:	L	T	R	L	T	R	L	T	R	L	T	R
Control:	Protected			Protected			Protected			Protected		
Rights:	Include			Include			Include			Include		
Min. Green:	0	0	0	0	0	0	0	0	0	0	0	0
Y+R:	4.0	4.0	4.0	4.0	4.0	4.0	4.0	4.0	4.0	4.0	4.0	4.0
Lanes:	1	0	1	1	0	1	1	0	2	1	0	2

Volume Module:

Base Vol:	109	617	67	228	1052	55	75	971	131	122	709	87
Growth Adj:	1.00	1.00	1.00	1.00	1.00	1.00	1.00	1.00	1.00	1.00	1.00	1.00
Initial Bse:	109	617	67	228	1052	55	75	971	131	122	709	87
User Adj:	1.00	1.00	1.00	1.00	1.00	1.00	1.00	1.00	1.00	1.00	1.00	1.00
PHF Adj:	1.00	1.00	1.00	1.00	1.00	1.00	1.00	1.00	1.00	1.00	1.00	1.00
PHF Volume:	109	617	67	228	1052	55	75	971	131	122	709	87
Reduct Vol:	0	0	0	0	0	0	0	0	0	0	0	0
Reduced Vol:	109	617	67	228	1052	55	75	971	131	122	709	87
PCE Adj:	1.00	1.00	1.00	1.00	1.00	1.00	1.00	1.00	1.00	1.00	1.00	1.00
MLF Adj:	1.00	1.00	1.00	1.00	1.00	1.00	1.00	1.00	1.00	1.00	1.00	1.00
FinalVolume:	109	617	67	228	1052	55	75	971	131	122	709	87

Saturation Flow Module:

Sat/Lane:	1600	1600	1600	1600	1600	1600	1600	1600	1600	1600	1600	1600
Adjustment:	1.00	1.03	1.00	1.00	1.03	1.00	1.00	1.06	1.00	1.00	1.05	1.00
Lanes:	1.00	1.80	0.20	1.00	1.90	0.10	1.00	2.00	1.00	1.00	2.67	0.33
Final Sat.:	1600	2987	313	1600	3141	159	1600	3400	1600	1600	4475	525

Capacity Analysis Module:

Vol/Sat:	0.07	0.21	0.21	0.14	0.33	0.35	0.05	0.29	0.08	0.08	0.16	0.17
Crit Moves:	****					****		****		****		

Santa Ana Circulation Element

Level Of Service Computation Report

ICU 1(Loss as Cycle Length %) Method (Base Volume Alternative)

Intersection #57 Main St and MacArthur Blvd

Cycle (sec): 100 Critical Vol./Cap.(X): 0.735
Loss Time (sec): 5 Average Delay (sec/veh): xxxxxx
Optimal Cycle: 41 Level Of Service: C

Table with 4 columns: North Bound, South Bound, East Bound, West Bound. Rows include Movement (L-T-R), Control (Protected), Rights (Include), Min. Green, Y+R, and Lanes.

Volume Module: Table with 12 columns for volume and adjustment factors. Rows include Base Vol, Growth Adj, Initial Bse, User Adj, PHF Adj, PHF Volume, Reduct Vol, Reduced Vol, PCE Adj, MLF Adj, and Final Volume.

Saturation Flow Module: Table with 12 columns for saturation flow. Rows include Sat/Lane, Adjustment, Lanes, and Final Sat.

Capacity Analysis Module: Table with 12 columns for capacity analysis. Rows include Vol/Sat and Crit Moves.

Santa Ana Circulation Element

Level Of Service Computation Report
 2000 HCM Operations Method (Base Volume Alternative)

 Intersection #58 Penn Wy and 17th St

Cycle (sec): 100 Critical Vol./Cap.(X): 0.602
 Loss Time (sec): 5 Average Delay (sec/veh): 11.2
 Optimal Cycle: 30 Level Of Service: B

Approach:	North Bound			South Bound			East Bound			West Bound		
Movement:	L	T	R	L	T	R	L	T	R	L	T	R
Control:	Split Phase			Split Phase			Protected			Protected		
Rights:	Include			Include			Include			Include		
Min. Green:	0	0	0	0	0	0	0	0	0	0	0	0
Y+R:	4.0	4.0	4.0	4.0	4.0	4.0	4.0	4.0	4.0	4.0	4.0	4.0
Lanes:	2	0	0	0	0	0	0	0	2	1	0	0

Volume Module:

Base Vol:	43	0	217	0	0	0	0	1238	631	214	1722	0
Growth Adj:	1.00	1.00	1.00	1.00	1.00	1.00	1.00	1.00	1.00	1.00	1.00	1.00
Initial Bse:	43	0	217	0	0	0	0	1238	631	214	1722	0
User Adj:	1.00	1.00	1.00	1.00	1.00	1.00	1.00	1.00	1.00	1.00	1.00	1.00
PHF Adj:	1.00	1.00	1.00	1.00	1.00	1.00	1.00	1.00	1.00	1.00	1.00	1.00
PHF Volume:	43	0	217	0	0	0	0	1238	631	214	1722	0
Reduct Vol:	0	0	0	0	0	0	0	0	0	0	0	0
Reduced Vol:	43	0	217	0	0	0	0	1238	631	214	1722	0
PCE Adj:	1.00	1.00	1.00	1.00	1.00	1.00	1.00	1.00	1.00	1.00	1.00	1.00
MLF Adj:	1.00	1.00	1.00	1.00	1.00	1.00	1.00	1.00	1.00	1.00	1.00	1.00
FinalVolume:	43	0	217	0	0	0	0	1238	631	214	1722	0

Saturation Flow Module:

Sat/Lane:	1900	1900	1900	1900	1900	1900	1900	1900	1900	1900	1900	1900
Adjustment:	0.92	1.00	0.75	1.00	1.00	1.00	1.00	0.86	0.86	0.95	0.91	1.00
Lanes:	2.00	0.00	2.00	0.00	0.00	0.00	0.00	2.00	1.00	1.00	3.00	0.00
Final Sat.:	3502	0	2842	0	0	0	0	3282	1641	1805	5187	0

Capacity Analysis Module:

Vol/Sat:	0.01	0.00	0.08	0.00	0.00	0.00	0.00	0.38	0.38	0.12	0.33	0.00
Crit Moves:	****						****			****		
Green/Cycle:	0.13	0.00	0.13	0.00	0.00	0.00	0.00	0.63	0.63	0.20	0.82	0.00
Volume/Cap:	0.10	0.00	0.60	0.00	0.00	0.00	0.00	0.60	0.61	0.60	0.40	0.00
Delay/Veh:	38.7	0.0	44.1	0.0	0.0	0.0	0.0	11.5	11.7	39.5	2.4	0.0
User DelAdj:	1.00	1.00	1.00	1.00	1.00	1.00	1.00	1.00	1.00	1.00	1.00	1.00
AdjDel/Veh:	38.7	0.0	44.1	0.0	0.0	0.0	0.0	11.5	11.7	39.5	2.4	0.0
LOS by Move:	D	A	D	A	A	A	A	B	B	D	A	A
HCM2k85thQ:	1	0	7	0	0	0	0	19	20	10	8	0

 Note: Queue reported is the number of cars per lane.

Santa Ana Circulation Element

Level Of Service Computation Report

2000 HCM Operations Method (Base Volume Alternative)

Intersection #59 I-5 NB Off Ramps/17th Street

Cycle (sec): 100 Critical Vol./Cap.(X): 0.740
 Loss Time (sec): 5 Average Delay (sec/veh): 31.2
 Optimal Cycle: 44 Level Of Service: C

Street Name:	I-5 NB Off Ramps						17th Street													
Approach:	North Bound			South Bound			East Bound			West Bound										
Movement:	L	T	R	L	T	R	L	T	R	L	T	R								
Control:	Split Phase			Split Phase			Protected			Permitted										
Rights:	Include			Include			Ignore			Include										
Min. Green:	0	0	0	0	0	0	0	0	0	0	0	0								
Y+R:	4.0	4.0	4.0	4.0	4.0	4.0	4.0	4.0	4.0	4.0	4.0	4.0								
Lanes:	1	1	0	0	1	1	0	0	0	1	1	0	3	0	1	0	0	2	1	0

Volume Module:

Base Vol:	768	35	22	57	0	295	99	1040	376	0	1245	20
Growth Adj:	1.00	1.00	1.00	1.00	1.00	1.00	1.00	1.00	1.00	1.00	1.00	1.00
Initial Bse:	768	35	22	57	0	295	99	1040	376	0	1245	20
User Adj:	1.00	1.00	1.00	1.00	1.00	1.00	1.00	1.00	0.00	1.00	1.00	1.00
PHF Adj:	1.00	1.00	1.00	1.00	1.00	1.00	1.00	1.00	0.00	1.00	1.00	1.00
PHF Volume:	768	35	22	57	0	295	99	1040	0	0	1245	20
Reduct Vol:	0	0	0	0	0	0	0	0	0	0	0	0
Reduced Vol:	768	35	22	57	0	295	99	1040	0	0	1245	20
PCE Adj:	1.00	1.00	1.00	1.00	1.00	1.00	1.00	1.00	0.00	1.00	1.00	1.00
MLF Adj:	1.00	1.00	1.00	1.00	1.00	1.00	1.00	1.00	0.00	1.00	1.00	1.00
Final Volume:	768	35	22	57	0	295	99	1040	0	0	1245	20

Saturation Flow Module:

Sat/Lane:	1900	1900	1900	1900	1900	1900	1900	1900	1900	1900	1900	1900
Adjustment:	0.95	0.95	0.85	0.95	1.00	0.85	0.95	0.91	1.00	1.00	0.91	0.91
Lanes:	1.91	0.09	1.00	1.00	0.00	1.00	1.00	3.00	1.00	0.00	2.95	0.05
Final Sat.:	3467	158	1615	1805	0	1615	1805	5187	1900	0	5095	82

Capacity Analysis Module:

Vol/Sat:	0.22	0.22	0.01	0.03	0.00	0.18	0.05	0.20	0.00	0.00	0.24	0.24
Crit Moves:	****			****			****			****		
Green/Cycle:	0.30	0.30	0.30	0.25	0.00	0.25	0.07	0.40	0.00	0.00	0.33	0.33
Volume/Cap:	0.74	0.74	0.05	0.13	0.00	0.74	0.74	0.50	0.00	0.00	0.74	0.74
Delay/Veh:	34.3	34.3	24.9	29.4	0.0	42.0	64.9	22.4	0.0	0.0	31.5	31.5
User DelAdj:	1.00	1.00	1.00	1.00	1.00	1.00	1.00	1.00	1.00	1.00	1.00	1.00
AdjDel/Veh:	34.3	34.3	24.9	29.4	0.0	42.0	64.9	22.4	0.0	0.0	31.5	31.5
LOS by Move:	C	C	C	C	A	D	E	C	A	A	C	C
HCM2k85thQ:	19	19	1	2	0	15	7	13	0	0	21	21

Note: Queue reported is the number of cars per lane.

Santa Ana Circulation Element

Level Of Service Computation Report
 2000 HCM Operations Method (Base Volume Alternative)

 Intersection #60 Penn Wy and I-5 SB Ramps

Cycle (sec): 100 Critical Vol./Cap.(X): 0.436
 Loss Time (sec): 5 Average Delay (sec/veh): 19.0
 Optimal Cycle: 22 Level Of Service: B

Approach:	North Bound			South Bound			East Bound			West Bound		
Movement:	L	T	R	L	T	R	L	T	R	L	T	R
Control:	Protected			Protected			Split Phase			Split Phase		
Rights:	Include			Include			Include			Ovl		
Min. Green:	0	0	0	0	0	0	0	0	0	0	0	0
Y+R:	4.0	4.0	4.0	4.0	4.0	4.0	4.0	4.0	4.0	4.0	4.0	4.0
Lanes:	0	0	2	0	1		2	0	2	0	0	

Volume Module:

Base Vol:	0	158	140	799	165	0	0	0	0	179	0	100
Growth Adj:	1.00	1.00	1.00	1.00	1.00	1.00	1.00	1.00	1.00	1.00	1.00	1.00
Initial Bse:	0	158	140	799	165	0	0	0	0	179	0	100
User Adj:	1.00	1.00	1.00	1.00	1.00	1.00	1.00	1.00	1.00	1.00	1.00	1.00
PHF Adj:	1.00	1.00	1.00	1.00	1.00	1.00	1.00	1.00	1.00	1.00	1.00	1.00
PHF Volume:	0	158	140	799	165	0	0	0	0	179	0	100
Reduct Vol:	0	0	0	0	0	0	0	0	0	0	0	0
Reduced Vol:	0	158	140	799	165	0	0	0	0	179	0	100
PCE Adj:	1.00	1.00	1.00	1.00	1.00	1.00	1.00	1.00	1.00	1.00	1.00	1.00
MLF Adj:	1.00	1.00	1.00	1.00	1.00	1.00	1.00	1.00	1.00	1.00	1.00	1.00
FinalVolume:	0	158	140	799	165	0	0	0	0	179	0	100

Saturation Flow Module:

Sat/Lane:	1900	1900	1900	1900	1900	1900	1900	1900	1900	1900	1900	1900
Adjustment:	1.00	0.95	0.85	0.92	0.95	1.00	1.00	1.00	1.00	0.95	1.00	0.75
Lanes:	0.00	2.00	1.00	2.00	2.00	0.00	0.00	0.00	0.00	1.00	0.00	2.00
Final Sat.:	0	3610	1615	3502	3610	0	0	0	0	1805	0	2842

Capacity Analysis Module:

Vol/Sat:	0.00	0.04	0.09	0.23	0.05	0.00	0.00	0.00	0.00	0.10	0.00	0.04
Crit Moves:	****			****						****		
Green/Cycle:	0.00	0.20	0.20	0.52	0.72	0.00	0.00	0.00	0.00	0.23	0.00	0.75
Volume/Cap:	0.00	0.22	0.44	0.44	0.06	0.00	0.00	0.00	0.00	0.44	0.00	0.05
Delay/Veh:	0.0	33.7	36.1	14.9	4.0	0.0	0.0	0.0	0.0	33.9	0.0	3.2
User DelAdj:	1.00	1.00	1.00	1.00	1.00	1.00	1.00	1.00	1.00	1.00	1.00	1.00
AdjDel/Veh:	0.0	33.7	36.1	14.9	4.0	0.0	0.0	0.0	0.0	33.9	0.0	3.2
LOS by Move:	A	C	D	B	A	A	A	A	A	C	A	A
HCM2k85thQ:	0	3	6	12	1	0	0	0	0	8	0	1

 Note: Queue reported is the number of cars per lane.

Santa Ana Circulation Element

Level Of Service Computation Report

2000 HCM 4-Way Stop Method (Base Volume Alternative)

 Intersection #61 Santiago St and Civic Center Dr

Cycle (sec): 100 Critical Vol./Cap.(X): 0.723
 Loss Time (sec): 5 Average Delay (sec/veh): 16.9
 Optimal Cycle: 0 Level Of Service: C

Approach:	North Bound			South Bound			East Bound			West Bound		
Movement:	L	T	R	L	T	R	L	T	R	L	T	R
Control:	Stop Sign			Stop Sign			Stop Sign			Stop Sign		
Rights:	Include			Include			Include			Include		
Min. Green:	0	0	0	0	0	0	0	0	0	0	0	0
Lanes:	1	0	0	1	0	0	0	1	0	0	0	1

Volume Module:	North Bound			South Bound			East Bound			West Bound		
Base Vol:	206	143	20	5	303	74	121	46	246	72	66	13
Growth Adj:	1.00	1.00	1.00	1.00	1.00	1.00	1.00	1.00	1.00	1.00	1.00	1.00
Initial Bse:	206	143	20	5	303	74	121	46	246	72	66	13
User Adj:	1.00	1.00	1.00	1.00	1.00	1.00	1.00	1.00	1.00	1.00	1.00	1.00
PHF Adj:	1.00	1.00	1.00	1.00	1.00	1.00	1.00	1.00	1.00	1.00	1.00	1.00
PHF Volume:	206	143	20	5	303	74	121	46	246	72	66	13
Reduct Vol:	0	0	0	0	0	0	0	0	0	0	0	0
Reduced Vol:	206	143	20	5	303	74	121	46	246	72	66	13
PCE Adj:	1.00	1.00	1.00	1.00	1.00	1.00	1.00	1.00	1.00	1.00	1.00	1.00
MLF Adj:	1.00	1.00	1.00	1.00	1.00	1.00	1.00	1.00	1.00	1.00	1.00	1.00
FinalVolume:	206	143	20	5	303	74	121	46	246	72	66	13

Saturation Flow Module:	North Bound			South Bound			East Bound			West Bound		
Adjustment:	1.00	1.00	1.00	1.00	1.00	1.00	1.00	1.00	1.00	1.00	1.00	1.00
Lanes:	1.00	0.88	0.12	1.00	0.80	0.20	0.72	0.28	1.00	0.48	0.44	0.08
Final Sat.:	468	443	62	471	419	102	337	128	540	208	190	37

Capacity Analysis Module:	North Bound			South Bound			East Bound			West Bound		
Vol/Sat:	0.44	0.32	0.32	0.01	0.72	0.72	0.36	0.36	0.46	0.35	0.35	0.35
Crit Moves:	****			****			****			****		
Delay/Veh:	15.5	12.6	12.6	10.2	24.0	24.0	14.0	14.0	13.9	14.2	14.2	14.2
Delay Adj:	1.00	1.00	1.00	1.00	1.00	1.00	1.00	1.00	1.00	1.00	1.00	1.00
AdjDel/Veh:	15.5	12.6	12.6	10.2	24.0	24.0	14.0	14.0	13.9	14.2	14.2	14.2
LOS by Move:	C	B	B	B	C	C	B	B	B	B	B	B
ApproachDel:	14.2			23.8			13.9			14.2		
Delay Adj:	1.00			1.00			1.00			1.00		
ApprAdjDel:	14.2			23.8			13.9			14.2		
LOS by Appr:	B			C			B			B		
AllWayAvgQ:	0.7	0.4	0.4	0.0	2.1	2.1	0.5	0.5	0.7	0.4	0.4	0.4

 Note: Queue reported is the number of cars per lane.

Santa Ana Circulation Element

Level Of Service Computation Report

ICU 1(Loss as Cycle Length %) Method (Base Volume Alternative)

Intersection #62 Santiago St and Santa Ana Blvd

Cycle (sec): 100 Critical Vol./Cap.(X): 0.553
 Loss Time (sec): 5 Average Delay (sec/veh): xxxxxx
 Optimal Cycle: 26 Level Of Service: A

Approach:	North Bound			South Bound			East Bound			West Bound		
Movement:	L	T	R	L	T	R	L	T	R	L	T	R
Control:	Permitted			Permitted			Protected			Protected		
Rights:	Include			Include			Include			Include		
Min. Green:	0	0	0	0	0	0	0	0	0	0	0	0
Y+R:	4.0	4.0	4.0	4.0	4.0	4.0	4.0	4.0	4.0	4.0	4.0	4.0
Lanes:	1	0	1	0	1	0	1	1	0	1	0	1

Volume Module:

Base Vol:	24	71	56	311	161	133	48	474	14	108	807	271
Growth Adj:	1.00	1.00	1.00	1.00	1.00	1.00	1.00	1.00	1.00	1.00	1.00	1.00
Initial Bse:	24	71	56	311	161	133	48	474	14	108	807	271
User Adj:	1.00	1.00	1.00	1.00	1.00	1.00	1.00	1.00	1.00	1.00	1.00	1.00
PHF Adj:	1.00	1.00	1.00	1.00	1.00	1.00	1.00	1.00	1.00	1.00	1.00	1.00
PHF Volume:	24	71	56	311	161	133	48	474	14	108	807	271
Reduct Vol:	0	0	0	0	0	0	0	0	0	0	0	0
Reduced Vol:	24	71	56	311	161	133	48	474	14	108	807	271
PCE Adj:	1.00	1.00	1.00	1.00	1.00	1.00	1.00	1.00	1.00	1.00	1.00	1.00
MLF Adj:	1.00	1.00	1.00	1.00	1.00	1.00	1.00	1.00	1.00	1.00	1.00	1.00
FinalVolume:	24	71	56	311	161	133	48	474	14	108	807	271

Saturation Flow Module:

Sat/Lane:	1600	1600	1600	1600	1600	1600	1600	1600	1600	1600	1600	1600
Adjustment:	1.00	1.06	1.00	1.00	1.06	1.00	1.00	1.03	1.00	1.00	1.06	1.00
Lanes:	1.00	1.00	1.00	1.00	1.00	1.00	1.00	1.94	0.06	1.00	2.00	1.00
Final Sat.:	1600	1700	1600	1600	1700	1600	1600	3208	92	1600	3400	1600

Capacity Analysis Module:

Vol/Sat:	0.02	0.04	0.04	0.19	0.09	0.08	0.03	0.15	0.15	0.07	0.24	0.17
Crit Moves:	****			****			****			****		

Santa Ana Circulation Element

Level Of Service Computation Report

ICU 1(Loss as Cycle Length %) Method (Base Volume Alternative)

Intersection #64 Standard Ave and 1st St

Cycle (sec): 100 Critical Vol./Cap.(X): 0.803
Loss Time (sec): 5 Average Delay (sec/veh): xxxxxx
Optimal Cycle: 53 Level Of Service: D

Table with 4 columns: North Bound, South Bound, East Bound, West Bound. Rows include Movement (L-T-R), Control, Rights, Min. Green, Y+R, and Lanes.

Volume Module: Table with 12 columns representing different volume categories and 10 rows of adjustment factors like Growth Adj, PHF Adj, etc.

Saturation Flow Module: Table with 12 columns and 4 rows showing saturation flow values and adjustment factors.

Capacity Analysis Module: Table with 12 columns and 3 rows showing capacity analysis metrics like Vol/Sat and Crit Moves.

Santa Ana Circulation Element

Level Of Service Computation Report

ICU 1(Loss as Cycle Length %) Method (Base Volume Alternative)

Intersection #65 Standard Ave and Mcfadden Ave

Cycle (sec): 100 Critical Vol./Cap.(X): 0.609
Loss Time (sec): 5 Average Delay (sec/veh): xxxxxx
Optimal Cycle: 29 Level Of Service: B

Table with 4 columns: North Bound, South Bound, East Bound, West Bound. Rows include Movement (L-T-R), Control, Rights, Min. Green, Y+R, and Lanes.

Volume Module: Table with 12 columns representing different traffic volumes and adjustment factors like Growth Adj, Initial Bse, User Adj, PHF Adj, PHF Volume, Reduct Vol, Reduced Vol, PCE Adj, MLF Adj, and Final Volume.

Saturation Flow Module: Table with 12 columns showing saturation flow rates and adjustment factors for each lane.

Capacity Analysis Module: Table with 12 columns showing Vol/Sat ratios and Critical Moves.

Santa Ana Circulation Element

Level Of Service Computation Report

ICU 1(Loss as Cycle Length %) Method (Base Volume Alternative)

Intersection #66 Halladay St and Warner Ave

Cycle (sec): 100 Critical Vol./Cap.(X): 0.659
 Loss Time (sec): 5 Average Delay (sec/veh): xxxxxx
 Optimal Cycle: 33 Level Of Service: B

Approach:	North Bound			South Bound			East Bound			West Bound		
Movement:	L	T	R	L	T	R	L	T	R	L	T	R
Control:	Permitted			Permitted			Permitted			Permitted		
Rights:	Include			Include			Include			Include		
Min. Green:	0	0	0	0	0	0	0	0	0	0	0	0
Y+R:	4.0	4.0	4.0	4.0	4.0	4.0	4.0	4.0	4.0	4.0	4.0	4.0
Lanes:	1	0	0	0	0	0	0	0	1	0	1	0

Volume Module:

Base Vol:	43	0	100	0	0	0	0	1283	145	160	607	0
Growth Adj:	1.00	1.00	1.00	1.00	1.00	1.00	1.00	1.00	1.00	1.00	1.00	1.00
Initial Bse:	43	0	100	0	0	0	0	1283	145	160	607	0
User Adj:	1.00	1.00	1.00	1.00	1.00	1.00	1.00	1.00	1.00	1.00	1.00	1.00
PHF Adj:	1.00	1.00	1.00	1.00	1.00	1.00	1.00	1.00	1.00	1.00	1.00	1.00
PHF Volume:	43	0	100	0	0	0	0	1283	145	160	607	0
Reduct Vol:	0	0	0	0	0	0	0	0	0	0	0	0
Reduced Vol:	43	0	100	0	0	0	0	1283	145	160	607	0
PCE Adj:	1.00	1.00	1.00	1.00	1.00	1.00	1.00	1.00	1.00	1.00	1.00	1.00
MLF Adj:	1.00	1.00	1.00	1.00	1.00	1.00	1.00	1.00	1.00	1.00	1.00	1.00
FinalVolume:	43	0	100	0	0	0	0	1283	145	160	607	0

Saturation Flow Module:

Sat/Lane:	1600	1600	1600	1600	1600	1600	1600	1600	1600	1600	1600	1600
Adjustment:	1.00	1.06	1.00	1.00	1.06	1.00	1.00	1.03	1.00	1.00	1.04	1.00
Lanes:	1.00	0.00	1.00	0.00	0.00	0.00	0.00	1.80	0.20	0.42	1.58	0.00
Final Sat.:	1600	0	1600	0	0	0	0	2975	325	668	2632	0

Capacity Analysis Module:

Vol/Sat:	0.03	0.00	0.06	0.00	0.00	0.00	0.00	0.43	0.45	0.10	0.23	0.00
Crit Moves:	****			****			****			****		

Santa Ana Circulation Element

Level Of Service Computation Report

ICU 1(Loss as Cycle Length %) Method (Base Volume Alternative)

Intersection #67 Halladay St and Dyer Rd

Cycle (sec): 100 Critical Vol./Cap.(X): 0.567
Loss Time (sec): 5 Average Delay (sec/veh): xxxxxx
Optimal Cycle: 27 Level Of Service: A

Table with 4 columns: North Bound, South Bound, East Bound, West Bound. Rows include Movement (L-T-R), Control (Split Phase, Protected), Rights (Include), Min. Green, Y+R, and Lanes.

Volume Module: Table with 12 columns representing different volume categories and 12 rows for various adjustment factors like Base Vol, Growth Adj, PHF Adj, etc.

Saturation Flow Module: Table with 12 columns for saturation flow values and 4 rows for Sat/Lane, Adjustment, Lanes, and Final Sat.

Capacity Analysis Module: Table with 12 columns for capacity analysis values and 3 rows for Vol/Sat, Crit Moves, and asterisks.

Santa Ana Circulation Element

Level Of Service Computation Report
 2000 HCM Operations Method (Base Volume Alternative)

 Intersection #68 SR-55 SB Ramps and MacArthur Blvd

Cycle (sec): 100 Critical Vol./Cap.(X): 0.615
 Loss Time (sec): 5 Average Delay (sec/veh): 19.8
 Optimal Cycle: 31 Level Of Service: B

Approach:	North Bound			South Bound			East Bound			West Bound		
Movement:	L	T	R	L	T	R	L	T	R	L	T	R
Control:	Split Phase			Split Phase			Protected			Protected		
Rights:	Include			Include			Ignore			Ignore		
Min. Green:	0	0	0	0	0	0	0	0	0	0	0	0
Y+R:	4.0	4.0	4.0	4.0	4.0	4.0	4.0	4.0	4.0	4.0	4.0	4.0
Lanes:	0	0	0	2	0	0	0	0	2	1	1	0

Volume Module:

Base Vol:	0	0	0	961	0	870	0	1441	1027	0	1275	145
Growth Adj:	1.00	1.00	1.00	1.00	1.00	1.00	1.00	1.00	1.00	1.00	1.00	1.00
Initial Bse:	0	0	0	961	0	870	0	1441	1027	0	1275	145
User Adj:	1.00	1.00	1.00	1.00	1.00	1.00	1.00	1.00	0.00	1.00	1.00	0.00
PHF Adj:	1.00	1.00	1.00	1.00	1.00	1.00	1.00	1.00	0.00	1.00	1.00	0.00
PHF Volume:	0	0	0	961	0	870	0	1441	0	0	1275	0
Reduct Vol:	0	0	0	0	0	0	0	0	0	0	0	0
Reduced Vol:	0	0	0	961	0	870	0	1441	0	0	1275	0
PCE Adj:	1.00	1.00	1.00	1.00	1.00	1.00	1.00	1.00	0.00	1.00	1.00	0.00
MLF Adj:	1.00	1.00	1.00	1.00	1.00	1.00	1.00	1.00	0.00	1.00	1.00	0.00
FinalVolume:	0	0	0	961	0	870	0	1441	0	0	1275	0

Saturation Flow Module:

Sat/Lane:	1900	1900	1900	1900	1900	1900	1900	1900	1900	1900	1900	1900
Adjustment:	1.00	1.00	1.00	0.92	1.00	0.75	1.00	0.91	0.91	1.00	0.91	1.00
Lanes:	0.00	0.00	0.00	2.00	0.00	2.00	0.00	3.00	1.00	0.00	3.00	1.00
Final Sat.:	0	0	0	3502	0	2842	0	5187	1729	0	5187	1900

Capacity Analysis Module:

Vol/Sat:	0.00	0.00	0.00	0.27	0.00	0.31	0.00	0.28	0.00	0.00	0.25	0.00
Crit Moves:						****		****		****		
Green/Cycle:	0.00	0.00	0.00	0.50	0.00	0.50	0.00	0.45	0.00	0.00	0.45	0.00
Volume/Cap:	0.00	0.00	0.00	0.55	0.00	0.61	0.00	0.61	0.00	0.00	0.54	0.00
Delay/Veh:	0.0	0.0	0.0	17.7	0.0	19.0	0.0	21.3	0.0	0.0	20.2	0.0
User DelAdj:	1.00	1.00	1.00	1.00	1.00	1.00	1.00	1.00	1.00	1.00	1.00	1.00
AdjDel/Veh:	0.0	0.0	0.0	17.7	0.0	19.0	0.0	21.3	0.0	0.0	20.2	0.0
LOS by Move:	A	A	A	B	A	B	A	C	A	A	C	A
HCM2k85thQ:	0	0	0	16	0	17	0	19	0	0	16	0

 Note: Queue reported is the number of cars per lane.

Santa Ana Circulation Element

Level Of Service Computation Report
 2000 HCM Operations Method (Base Volume Alternative)

 Intersection #69 SR-55 NB Ramps and MacArthur Blvd

Cycle (sec): 100 Critical Vol./Cap.(X): 0.742
 Loss Time (sec): 5 Average Delay (sec/veh): 19.2
 Optimal Cycle: 44 Level Of Service: B

Approach:	North Bound			South Bound			East Bound			West Bound		
Movement:	L	T	R	L	T	R	L	T	R	L	T	R
Control:	Split Phase			Split Phase			Protected			Protected		
Rights:	Ignore			Include			Ignore			Ignore		
Min. Green:	0	0	0	0	0	0	0	0	0	0	0	0
Y+R:	4.0	4.0	4.0	4.0	4.0	4.0	4.0	4.0	4.0	4.0	4.0	4.0
Lanes:	2	0	0	0	0	0	0	0	2	0	0	3

Volume Module:

Base Vol:	908	0	976	0	0	0	0	1609	796	0	517	244
Growth Adj:	1.00	1.00	1.00	1.00	1.00	1.00	1.00	1.00	1.00	1.00	1.00	1.00
Initial Bse:	908	0	976	0	0	0	0	1609	796	0	517	244
User Adj:	1.00	1.00	0.00	1.00	1.00	1.00	1.00	1.00	0.00	1.00	1.00	0.00
PHF Adj:	1.00	1.00	0.00	1.00	1.00	1.00	1.00	1.00	0.00	1.00	1.00	0.00
PHF Volume:	908	0	0	0	0	0	0	1609	0	0	517	0
Reduct Vol:	0	0	0	0	0	0	0	0	0	0	0	0
Reduced Vol:	908	0	0	0	0	0	0	1609	0	0	517	0
PCE Adj:	1.00	1.00	0.00	1.00	1.00	1.00	1.00	1.00	0.00	1.00	1.00	0.00
MLF Adj:	1.00	1.00	0.00	1.00	1.00	1.00	1.00	1.00	0.00	1.00	1.00	0.00
FinalVolume:	908	0	0	0	0	0	0	1609	0	0	517	0

Saturation Flow Module:

Sat/Lane:	1900	1900	1900	1900	1900	1900	1900	1900	1900	1900	1900	1900
Adjustment:	0.92	1.00	1.00	1.00	1.00	1.00	1.00	0.95	0.88	1.00	0.91	1.00
Lanes:	2.00	0.00	1.00	0.00	0.00	0.00	0.00	2.00	2.00	0.00	3.00	1.00
Final Sat.:	3502	0	1900	0	0	0	0	3610	3344	0	5187	1900

Capacity Analysis Module:

Vol/Sat:	0.26	0.00	0.00	0.00	0.00	0.00	0.00	0.45	0.00	0.00	0.10	0.00
Crit Moves:	****							****		****		
Green/Cycle:	0.35	0.00	0.00	0.00	0.00	0.00	0.00	0.60	0.00	0.00	0.60	0.00
Volume/Cap:	0.74	0.00	0.00	0.00	0.00	0.00	0.00	0.74	0.00	0.00	0.17	0.00
Delay/Veh:	31.1	0.0	0.0	0.0	0.0	0.0	0.0	15.8	0.0	0.0	8.9	0.0
User DelAdj:	1.00	1.00	1.00	1.00	1.00	1.00	1.00	1.00	1.00	1.00	1.00	1.00
AdjDel/Veh:	31.1	0.0	0.0	0.0	0.0	0.0	0.0	15.8	0.0	0.0	8.9	0.0
LOS by Move:	C	A	A	A	A	A	A	B	A	A	A	A
HCM2k85thQ:	21	0	0	0	0	0	0	29	0	0	4	0

 Note: Queue reported is the number of cars per lane.

Santa Ana Circulation Element

Level Of Service Computation Report
 2000 HCM Operations Method (Base Volume Alternative)

 Intersection #70 SR-55 SB Ramps and Dyer Rd

Cycle (sec): 100 Critical Vol./Cap.(X): 0.552
 Loss Time (sec): 5 Average Delay (sec/veh): 23.7
 Optimal Cycle: 27 Level Of Service: C

Approach:	North Bound			South Bound			East Bound			West Bound		
Movement:	L	T	R	L	T	R	L	T	R	L	T	R
Control:	Split Phase			Split Phase			Protected			Protected		
Rights:	Ovl			Include			Include			Include		
Min. Green:	0	0	0	0	0	0	0	0	0	0	0	0
Y+R:	4.0	4.0	4.0	4.0	4.0	4.0	4.0	4.0	4.0	4.0	4.0	4.0
Lanes:	1	1	0	0	1	1	0	3	0	2	0	3

Volume Module:

Base Vol:	221	26	505	50	242	60	35	1338	285	408	647	108
Growth Adj:	1.00	1.00	1.00	1.00	1.00	1.00	1.00	1.00	1.00	1.00	1.00	1.00
Initial Bse:	221	26	505	50	242	60	35	1338	285	408	647	108
User Adj:	1.00	1.00	1.00	1.00	1.00	1.00	1.00	1.00	1.00	1.00	1.00	1.00
PHF Adj:	1.00	1.00	1.00	1.00	1.00	1.00	1.00	1.00	1.00	1.00	1.00	1.00
PHF Volume:	221	26	505	50	242	60	35	1338	285	408	647	108
Reduct Vol:	0	0	0	0	0	0	0	0	0	0	0	0
Reduced Vol:	221	26	505	50	242	60	35	1338	285	408	647	108
PCE Adj:	1.00	1.00	1.00	1.00	1.00	1.00	1.00	1.00	1.00	1.00	1.00	1.00
MLF Adj:	1.00	1.00	1.00	1.00	1.00	1.00	1.00	1.00	1.00	1.00	1.00	1.00
FinalVolume:	221	26	505	50	242	60	35	1338	285	408	647	108

Saturation Flow Module:

Sat/Lane:	1900	1900	1900	1900	1900	1900	1900	1900	1900	1900	1900	1900
Adjustment:	0.96	0.96	0.75	0.94	0.94	0.85	0.95	0.91	0.85	0.92	0.91	0.85
Lanes:	1.79	0.21	2.00	0.34	1.66	1.00	1.00	3.00	1.00	2.00	3.00	1.00
Final Sat.:	3254	383	2842	613	2968	1615	1805	5187	1615	3502	5187	1615

Capacity Analysis Module:

Vol/Sat:	0.07	0.07	0.18	0.08	0.08	0.04	0.02	0.26	0.18	0.12	0.12	0.07
Crit Moves:	****			****			****			****		
Green/Cycle:	0.12	0.12	0.33	0.15	0.15	0.15	0.09	0.47	0.47	0.21	0.59	0.59
Volume/Cap:	0.55	0.55	0.53	0.55	0.55	0.25	0.21	0.55	0.38	0.55	0.21	0.11
Delay/Veh:	42.7	42.7	27.5	40.8	40.8	38.3	42.7	19.4	17.5	36.1	9.7	9.2
User DelAdj:	1.00	1.00	1.00	1.00	1.00	1.00	1.00	1.00	1.00	1.00	1.00	1.00
AdjDel/Veh:	42.7	42.7	27.5	40.8	40.8	38.3	42.7	19.4	17.5	36.1	9.7	9.2
LOS by Move:	D	D	C	D	D	D	D	B	B	D	A	A
HCM2k85thQ:	7	7	12	8	8	3	2	17	9	10	5	2

 Note: Queue reported is the number of cars per lane.

Santa Ana Circulation Element

Level Of Service Computation Report

ICU 1(Loss as Cycle Length %) Method (Base Volume Alternative)

Intersection #71 Glassell St and La Veta Ave

Cycle (sec): 100 Critical Vol./Cap.(X): 0.603
 Loss Time (sec): 5 Average Delay (sec/veh): xxxxxx
 Optimal Cycle: 29 Level Of Service: B

Approach:	North Bound			South Bound			East Bound			West Bound		
Movement:	L	T	R	L	T	R	L	T	R	L	T	R
Control:	Protected			Protected			Protected			Protected		
Rights:	Ovl			Include			Ovl			Include		
Min. Green:	0	0	0	0	0	0	0	0	0	0	0	0
Y+R:	4.0	4.0	4.0	4.0	4.0	4.0	4.0	4.0	4.0	4.0	4.0	4.0
Lanes:	2	0	1	0	1	0	1	0	1	0	1	0

Volume Module:

Base Vol:	263	412	125	17	358	79	38	195	375	236	249	6
Growth Adj:	1.00	1.00	1.00	1.00	1.00	1.00	1.00	1.00	1.00	1.00	1.00	1.00
Initial Bse:	263	412	125	17	358	79	38	195	375	236	249	6
User Adj:	1.00	1.00	1.00	1.00	1.00	1.00	1.00	1.00	1.00	1.00	1.00	1.00
PHF Adj:	1.00	1.00	1.00	1.00	1.00	1.00	1.00	1.00	1.00	1.00	1.00	1.00
PHF Volume:	263	412	125	17	358	79	38	195	375	236	249	6
Reduct Vol:	0	0	0	0	0	0	0	0	0	0	0	0
Reduced Vol:	263	412	125	17	358	79	38	195	375	236	249	6
PCE Adj:	1.00	1.00	1.00	1.00	1.00	1.00	1.00	1.00	1.00	1.00	1.00	1.00
MLF Adj:	1.00	1.00	1.00	1.00	1.00	1.00	1.00	1.00	1.00	1.00	1.00	1.00
FinalVolume:	263	412	125	17	358	79	38	195	375	236	249	6
OvlAdjVol:	0						244					

Saturation Flow Module:

Sat/Lane:	1600	1600	1600	1600	1600	1600	1600	1600	1600	1600	1600	1600
Adjustment:	1.00	1.06	1.00	1.00	1.04	1.00	1.00	1.06	1.00	1.00	1.03	1.00
Lanes:	2.00	1.00	1.00	1.00	1.64	0.36	1.00	1.00	1.00	1.00	1.95	0.05
Final Sat.:	3200	1700	1600	1600	2722	578	1600	1700	1600	1600	3225	75

Capacity Analysis Module:

Vol/Sat:	0.08	0.24	0.08	0.01	0.13	0.14	0.02	0.11	0.23	0.15	0.08	0.08
OvlAdjV/S:	0.00						0.15					
Crit Moves:	****			****			****			****		

Santa Ana Circulation Element

Level Of Service Computation Report
 2000 HCM Operations Method (Base Volume Alternative)

 Intersection #72 Glassell St and SR-22 WB Ramps

Cycle (sec): 100 Critical Vol./Cap.(X): 0.741
 Loss Time (sec): 5 Average Delay (sec/veh): 28.5
 Optimal Cycle: 44 Level Of Service: C

Approach:	North Bound			South Bound			East Bound			West Bound		
Movement:	L	T	R	L	T	R	L	T	R	L	T	R
Control:	Protected			Permitted			Split Phase			Split Phase		
Rights:	Include			Include			Include			Include		
Min. Green:	0	0	0	0	0	0	0	0	0	0	0	0
Y+R:	4.0	4.0	4.0	4.0	4.0	4.0	4.0	4.0	4.0	4.0	4.0	4.0
Lanes:	1	0	2	0	0	2	0	0	0	1	0	1

Volume Module:

Base Vol:	500	561	0	0	743	346	0	0	0	285	5	426
Growth Adj:	1.00	1.00	1.00	1.00	1.00	1.00	1.00	1.00	1.00	1.00	1.00	1.00
Initial Bse:	500	561	0	0	743	346	0	0	0	285	5	426
User Adj:	1.00	1.00	1.00	1.00	1.00	1.00	1.00	1.00	1.00	1.00	1.00	1.00
PHF Adj:	1.00	1.00	1.00	1.00	1.00	1.00	1.00	1.00	1.00	1.00	1.00	1.00
PHF Volume:	500	561	0	0	743	346	0	0	0	285	5	426
Reduct Vol:	0	0	0	0	0	0	0	0	0	0	0	0
Reduced Vol:	500	561	0	0	743	346	0	0	0	285	5	426
PCE Adj:	1.00	1.00	1.00	1.00	1.00	1.00	1.00	1.00	1.00	1.00	1.00	1.00
MLF Adj:	1.00	1.00	1.00	1.00	1.00	1.00	1.00	1.00	1.00	1.00	1.00	1.00
Final Volume:	500	561	0	0	743	346	0	0	0	285	5	426

Saturation Flow Module:

Sat/Lane:	1900	1900	1900	1900	1900	1900	1900	1900	1900	1900	1900	1900
Adjustment:	0.95	0.95	1.00	1.00	0.95	0.85	1.00	1.00	1.00	0.86	0.86	0.86
Lanes:	1.00	2.00	0.00	0.00	2.00	1.00	0.00	0.00	0.00	1.40	0.01	1.59
Final Sat.:	1805	3610	0	0	3610	1615	0	0	0	2270	23	2588

Capacity Analysis Module:

Vol/Sat:	0.28	0.16	0.00	0.00	0.21	0.21	0.00	0.00	0.00	0.13	0.22	0.16
Crit Moves:	****				****					****		
Green/Cycle:	0.37	0.65	0.00	0.00	0.28	0.28	0.00	0.00	0.00	0.30	0.30	0.30
Volume/Cap:	0.74	0.24	0.00	0.00	0.74	0.77	0.00	0.00	0.00	0.42	0.74	0.55
Delay/Veh:	31.5	7.3	0.0	0.0	35.9	41.3	0.0	0.0	0.0	28.3	34.7	29.9
User DelAdj:	1.00	1.00	1.00	1.00	1.00	1.00	1.00	1.00	1.00	1.00	1.00	1.00
AdjDel/Veh:	31.5	7.3	0.0	0.0	35.9	41.3	0.0	0.0	0.0	28.3	34.7	29.9
LOS by Move:	C	A	A	A	D	D	A	A	A	C	C	C
HCM2k85thQ:	22	6	0	0	19	17	0	0	0	8	17	11

 Note: Queue reported is the number of cars per lane.

Santa Ana Circulation Element

Level Of Service Computation Report
 2000 HCM Operations Method (Base Volume Alternative)

 Intersection #73 Grand Ave / Glassell St and SR-22 EB Ramps

Cycle (sec): 100 Critical Vol./Cap.(X): 0.760
 Loss Time (sec): 5 Average Delay (sec/veh): 27.0
 Optimal Cycle: 47 Level Of Service: C

Approach:	North Bound			South Bound			East Bound			West Bound		
Movement:	L	T	R	L	T	R	L	T	R	L	T	R
Control:	Permitted			Protected			Split Phase			Split Phase		
Rights:	Include			Include			Include			Include		
Min. Green:	0	0	0	0	0	0	0	0	0	0	0	0
Y+R:	4.0	4.0	4.0	4.0	4.0	4.0	4.0	4.0	4.0	4.0	4.0	4.0
Lanes:	0	0	2	0	1	0	1	0	1	0	0	0

Volume Module:

Base Vol:	0	818	218	280	733	0	258	0	1012	0	0	0
Growth Adj:	1.00	1.00	1.00	1.00	1.00	1.00	1.00	1.00	1.00	1.00	1.00	1.00
Initial Bse:	0	818	218	280	733	0	258	0	1012	0	0	0
User Adj:	1.00	1.00	1.00	1.00	1.00	1.00	1.00	1.00	1.00	1.00	1.00	1.00
PHF Adj:	1.00	1.00	1.00	1.00	1.00	1.00	1.00	1.00	1.00	1.00	1.00	1.00
PHF Volume:	0	818	218	280	733	0	258	0	1012	0	0	0
Reduct Vol:	0	0	0	0	0	0	0	0	0	0	0	0
Reduced Vol:	0	818	218	280	733	0	258	0	1012	0	0	0
PCE Adj:	1.00	1.00	1.00	1.00	1.00	1.00	1.00	1.00	1.00	1.00	1.00	1.00
MLF Adj:	1.00	1.00	1.00	1.00	1.00	1.00	1.00	1.00	1.00	1.00	1.00	1.00
Final Volume:	0	818	218	280	733	0	258	0	1012	0	0	0

Saturation Flow Module:

Sat/Lane:	1900	1900	1900	1900	1900	1900	1900	1900	1900	1900	1900	1900
Adjustment:	1.00	0.95	0.85	0.95	0.95	1.00	0.87	1.00	0.87	1.00	1.00	1.00
Lanes:	0.00	2.00	1.00	1.00	2.00	0.00	1.20	0.00	1.80	0.00	0.00	0.00
Final Sat.:	0	3610	1615	1805	3610	0	1992	0	2974	0	0	0

Capacity Analysis Module:

Vol/Sat:	0.00	0.23	0.13	0.16	0.20	0.00	0.13	0.00	0.34	0.00	0.00	0.00
Crit Moves:	****			****			****			****		
Green/Cycle:	0.00	0.30	0.30	0.20	0.50	0.00	0.45	0.00	0.45	0.00	0.00	0.00
Volume/Cap:	0.00	0.76	0.45	0.76	0.40	0.00	0.29	0.00	0.76	0.00	0.00	0.00
Delay/Veh:	0.0	35.0	29.1	46.4	15.7	0.0	17.6	0.0	25.2	0.0	0.0	0.0
User DelAdj:	1.00	1.00	1.00	1.00	1.00	1.00	1.00	1.00	1.00	1.00	1.00	1.00
AdjDel/Veh:	0.0	35.0	29.1	46.4	15.7	0.0	17.6	0.0	25.2	0.0	0.0	0.0
LOS by Move:	A	D	C	D	B	A	B	A	C	A	A	A
HCM2k85thQ:	0	20	9	15	11	0	7	0	23	0	0	0

 Note: Queue reported is the number of cars per lane.

Santa Ana Circulation Element

Level of Service Computation Report

ICU 1(Loss as Cycle Length %) Method (Base Volume Alternative)

Intersection #74 Grand Ave and Fairhaven Ave

Cycle (sec): 100 Critical Vol./Cap.(X): 0.680
 Loss Time (sec): 5 Average Delay (sec/veh): xxxxxx
 Optimal Cycle: 35 Level of Service: B

Approach:	North Bound			South Bound			East Bound			West Bound		
Movement:	L	T	R	L	T	R	L	T	R	L	T	R
Control:	Protected			Protected			Permitted			Permitted		
Rights:	Include			Include			Include			Include		
Min. Green:	0	0	0	0	0	0	0	0	0	0	0	0
Y+R:	4.0	4.0	4.0	4.0	4.0	4.0	4.0	4.0	4.0	4.0	4.0	4.0
Lanes:	1	0	2	1	0	2	1	0	1	1	0	1

Volume Module:

Base Vol:	18	737	106	174	1444	32	99	60	59	254	28	229
Growth Adj:	1.00	1.00	1.00	1.00	1.00	1.00	1.00	1.00	1.00	1.00	1.00	1.00
Initial Bse:	18	737	106	174	1444	32	99	60	59	254	28	229
User Adj:	1.00	1.00	1.00	1.00	1.00	1.00	1.00	1.00	1.00	1.00	1.00	1.00
PHF Adj:	1.00	1.00	1.00	1.00	1.00	1.00	1.00	1.00	1.00	1.00	1.00	1.00
PHF Volume:	18	737	106	174	1444	32	99	60	59	254	28	229
Reduct Vol:	0	0	0	0	0	0	0	0	0	0	0	0
Reduced Vol:	18	737	106	174	1444	32	99	60	59	254	28	229
PCE Adj:	1.00	1.00	1.00	1.00	1.00	1.00	1.00	1.00	1.00	1.00	1.00	1.00
MLF Adj:	1.00	1.00	1.00	1.00	1.00	1.00	1.00	1.00	1.00	1.00	1.00	1.00
Final Volume:	18	737	106	174	1444	32	99	60	59	254	28	229

Saturation Flow Module:

Sat/Lane:	1600	1600	1600	1600	1600	1600	1600	1600	1600	1600	1600	1600
Adjustment:	1.00	1.05	1.00	1.00	1.06	1.00	1.00	1.06	1.00	1.00	1.06	1.00
Lanes:	1.00	2.62	0.38	1.00	2.00	1.00	1.00	1.01	0.99	1.00	1.00	1.00
Final Sat.:	1600	4396	604	1600	3400	1600	1600	1713	1587	1600	1700	1600

Capacity Analysis Module:

Vol/Sat:	0.01	0.17	0.18	0.11	0.42	0.02	0.06	0.04	0.04	0.16	0.02	0.14
Crit Moves:	****			****			****			****		

Santa Ana Circulation Element

Level Of Service Computation Report

ICU 1(Loss as Cycle Length %) Method (Base Volume Alternative)

Intersection #75 Grand Ave and Santa Clara Ave

Cycle (sec): 100 Critical Vol./Cap.(X): 0.885
 Loss Time (sec): 5 Average Delay (sec/veh): xxxxxx
 Optimal Cycle: 79 Level Of Service: D

Approach:	North Bound			South Bound			East Bound			West Bound		
Movement:	L	T	R	L	T	R	L	T	R	L	T	R
Control:	Protected			Protected			Permitted			Permitted		
Rights:	Include			WideBypass			Include			Include		
Min. Green:	0	0	0	0	0	0	0	0	0	0	0	0
Y+R:	4.0	4.0	4.0	4.0	4.0	4.0	4.0	4.0	4.0	4.0	4.0	4.0
Lanes:	1	0	2	1	0	1	1	0	0	1	0	1

Volume Module:

Base Vol:	66	463	119	290	1418	319	143	233	48	120	231	211
Growth Adj:	1.00	1.00	1.00	1.00	1.00	1.00	1.00	1.00	1.00	1.00	1.00	1.00
Initial Bse:	66	463	119	290	1418	319	143	233	48	120	231	211
User Adj:	1.00	1.00	1.00	1.00	1.00	1.00	1.00	1.00	1.00	1.00	1.00	1.00
PHF Adj:	1.00	1.00	1.00	1.00	1.00	1.00	1.00	1.00	1.00	1.00	1.00	1.00
PHF Volume:	66	463	119	290	1418	319	143	233	48	120	231	211
Reduct Vol:	0	0	0	0	0	0	0	0	0	0	0	0
Reduced Vol:	66	463	119	290	1418	319	143	233	48	120	231	211
PCE Adj:	1.00	1.00	1.00	1.00	1.00	1.00	1.00	1.00	1.00	1.00	1.00	1.00
MLF Adj:	1.00	1.00	1.00	1.00	1.00	1.00	1.00	1.00	1.00	1.00	1.00	1.00
Final Volume:	66	463	119	290	1418	319	143	233	48	120	231	211

Saturation Flow Module:

Sat/Lane:	1600	1600	1600	1600	1600	1600	1600	1600	1600	1600	1600	1600
Adjustment:	1.00	1.05	1.00	1.00	1.04	1.00	1.00	1.00	1.00	1.00	1.06	1.00
Lanes:	1.00	2.39	0.61	1.00	1.63	0.37	1.00	0.83	0.17	1.00	1.00	1.00
Final Sat.:	1600	4019	981	1600	2712	588	1600	1327	273	1600	1700	1600

Capacity Analysis Module:

Vol/Sat:	0.04	0.12	0.12	0.18	0.52	0.54	0.09	0.18	0.18	0.08	0.14	0.13
Crit Moves:	****					****	****			****		

Santa Ana Circulation Element

Level Of Service Computation Report

ICU 1(Loss as Cycle Length %) Method (Base Volume Alternative)

Intersection #76 Grand Ave and 17th St

Cycle (sec): 100 Critical Vol./Cap.(X): 0.797
 Loss Time (sec): 5 Average Delay (sec/veh): xxxxxxx
 Optimal Cycle: 51 Level Of Service: C

Approach:	North Bound			South Bound			East Bound			West Bound		
Movement:	L	T	R	L	T	R	L	T	R	L	T	R
Control:	Protected			Protected			Protected			Protected		
Rights:	Include			Include			Include			Include		
Min. Green:	0	0	0	0	0	0	0	0	0	0	0	0
Y+R:	4.0	4.0	4.0	4.0	4.0	4.0	4.0	4.0	4.0	4.0	4.0	4.0
Lanes:	1	0	2	1	0	2	0	1	0	2	0	2

Volume Module:

Base Vol:	163	476	327	286	1198	235	224	835	106	309	807	88
Growth Adj:	1.00	1.00	1.00	1.00	1.00	1.00	1.00	1.00	1.00	1.00	1.00	1.00
Initial Bse:	163	476	327	286	1198	235	224	835	106	309	807	88
User Adj:	1.00	1.00	1.00	1.00	1.00	1.00	1.00	1.00	1.00	1.00	1.00	1.00
PHF Adj:	1.00	1.00	1.00	1.00	1.00	1.00	1.00	1.00	1.00	1.00	1.00	1.00
PHF Volume:	163	476	327	286	1198	235	224	835	106	309	807	88
Reduct Vol:	0	0	0	0	0	0	0	0	0	0	0	0
Reduced Vol:	163	476	327	286	1198	235	224	835	106	309	807	88
PCE Adj:	1.00	1.00	1.00	1.00	1.00	1.00	1.00	1.00	1.00	1.00	1.00	1.00
MLF Adj:	1.00	1.00	1.00	1.00	1.00	1.00	1.00	1.00	1.00	1.00	1.00	1.00
FinalVolume:	163	476	327	286	1198	235	224	835	106	309	807	88

Saturation Flow Module:

Sat/Lane:	1600	1600	1600	1600	1600	1600	1600	1600	1600	1600	1600	1600
Adjustment:	1.00	1.06	1.00	1.00	1.06	1.00	1.00	1.05	1.00	1.00	1.05	1.00
Lanes:	1.00	2.00	1.00	1.00	2.00	1.00	2.00	2.66	0.34	2.00	2.71	0.29
Final Sat.:	1600	3400	1600	1600	3400	1600	3200	4459	541	3200	4528	472

Capacity Analysis Module:

Vol/Sat:	0.10	0.14	0.20	0.18	0.35	0.15	0.07	0.19	0.20	0.10	0.18	0.19
Crit Moves:	****			****			****	****				

Santa Ana Circulation Element

Level Of Service Computation Report

2000 HCM Operations Method (Base Volume Alternative)

Intersection #77 Grand Ave and I-5 NB Ramps

Cycle (sec): 100 Critical Vol./Cap.(X): 0.516
 Loss Time (sec): 5 Average Delay (sec/veh): 12.9
 Optimal Cycle: 26 Level Of Service: B

Approach:	North Bound			South Bound			East Bound			West Bound		
Movement:	L	T	R	L	T	R	L	T	R	L	T	R
Control:	Protected			Protected			Split Phase			Split Phase		
Rights:	Ignore			Include			Include			Include		
Min. Green:	0	0	0	0	0	0	0	0	0	0	0	0
Y+R:	4.0	4.0	4.0	4.0	4.0	4.0	4.0	4.0	4.0	4.0	4.0	4.0
Lanes:	0	0	2	0	1	1	0	0	3	0	0	0

-----|-----|-----|-----|

Volume Module:

Base Vol:	0	831	480	58	1869	0	0	0	0	456	0	126
Growth Adj:	1.00	1.00	1.00	1.00	1.00	1.00	1.00	1.00	1.00	1.00	1.00	1.00
Initial Bse:	0	831	480	58	1869	0	0	0	0	456	0	126
User Adj:	1.00	1.00	0.00	1.00	1.00	1.00	1.00	1.00	1.00	1.00	1.00	1.00
PHF Adj:	1.00	1.00	0.00	1.00	1.00	1.00	1.00	1.00	1.00	1.00	1.00	1.00
PHF Volume:	0	831	0	58	1869	0	0	0	0	456	0	126
Reduct Vol:	0	0	0	0	0	0	0	0	0	0	0	0
Reduced Vol:	0	831	0	58	1869	0	0	0	0	456	0	126
PCE Adj:	1.00	1.00	0.00	1.00	1.00	1.00	1.00	1.00	1.00	1.00	1.00	1.00
MLF Adj:	1.00	1.00	0.00	1.00	1.00	1.00	1.00	1.00	1.00	1.00	1.00	1.00
FinalVolume:	0	831	0	58	1869	0	0	0	0	456	0	126

-----|-----|-----|-----|

Saturation Flow Module:

Sat/Lane:	1900	1900	1900	1900	1900	1900	1900	1900	1900	1900	1900	1900
Adjustment:	1.00	0.95	1.00	0.95	0.91	1.00	1.00	1.00	1.00	0.92	1.00	0.85
Lanes:	0.00	2.00	1.00	1.00	3.00	0.00	0.00	0.00	0.00	2.00	0.00	1.00
Final Sat.:	0	3610	1900	1805	5187	0	0	0	0	3502	0	1615

-----|-----|-----|-----|

Capacity Analysis Module:

Vol/Sat:	0.00	0.23	0.00	0.03	0.36	0.00	0.00	0.00	0.00	0.13	0.00	0.08
Crit Moves:	****			****						****		
Green/Cycle:	0.00	0.61	0.00	0.09	0.70	0.00	0.00	0.00	0.00	0.25	0.00	0.25
Volume/Cap:	0.00	0.38	0.00	0.38	0.52	0.00	0.00	0.00	0.00	0.52	0.00	0.31
Delay/Veh:	0.0	9.9	0.0	44.7	7.3	0.0	0.0	0.0	0.0	32.7	0.0	30.8
User DelAdj:	1.00	1.00	1.00	1.00	1.00	1.00	1.00	1.00	1.00	1.00	1.00	1.00
AdjDel/Veh:	0.0	9.9	0.0	44.7	7.3	0.0	0.0	0.0	0.0	32.7	0.0	30.8
LOS by Move:	A	A	A	D	A	A	A	A	A	C	A	C
HCM2k85thQ:	0	10	0	3	15	0	0	0	0	10	0	5

Note: Queue reported is the number of cars per lane.

Santa Ana Circulation Element

Level Of Service Computation Report
 2000 HCM Operations Method (Base Volume Alternative)

 Intersection #78 Grand Ave and Santa Ana Blvd

Cycle (sec): 100 Critical Vol./Cap.(X): 0.662
 Loss Time (sec): 5 Average Delay (sec/veh): 23.8
 Optimal Cycle: 35 Level Of Service: C

Approach:	North Bound			South Bound			East Bound			West Bound		
Movement:	L	T	R	L	T	R	L	T	R	L	T	R
Control:	Protected			Protected			Split Phase			Split Phase		
Rights:	Include			Ovl			Include			Include		
Min. Green:	0	0	0	0	0	0	0	0	0	0	0	0
Y+R:	4.0	4.0	4.0	4.0	4.0	4.0	4.0	4.0	4.0	4.0	4.0	4.0
Lanes:	1	0	2	1	0	2	2	0	1	0	1	0

Volume Module:

Base Vol:	71	1003	51	141	1166	1029	263	217	428	5	373	34
Growth Adj:	1.00	1.00	1.00	1.00	1.00	1.00	1.00	1.00	1.00	1.00	1.00	1.00
Initial Bse:	71	1003	51	141	1166	1029	263	217	428	5	373	34
User Adj:	1.00	1.00	1.00	1.00	1.00	1.00	1.00	1.00	1.00	1.00	1.00	1.00
PHF Adj:	1.00	1.00	1.00	1.00	1.00	1.00	1.00	1.00	1.00	1.00	1.00	1.00
PHF Volume:	71	1003	51	141	1166	1029	263	217	428	5	373	34
Reduct Vol:	0	0	0	0	0	0	0	0	0	0	0	0
Reduced Vol:	71	1003	51	141	1166	1029	263	217	428	5	373	34
PCE Adj:	1.00	1.00	1.00	1.00	1.00	1.00	1.00	1.00	1.00	1.00	1.00	1.00
MLF Adj:	1.00	1.00	1.00	1.00	1.00	1.00	1.00	1.00	1.00	1.00	1.00	1.00
Final Volume:	71	1003	51	141	1166	1029	263	217	428	5	373	34

Saturation Flow Module:

Sat/Lane:	1900	1900	1900	1900	1900	1900	1900	1900	1900	1900	1900	1900
Adjustment:	0.95	0.90	0.90	0.95	0.95	0.75	0.92	1.00	0.75	0.94	0.94	0.94
Lanes:	1.00	2.85	0.15	1.00	2.00	2.00	2.00	1.00	2.00	0.02	1.81	0.17
Final Sat.:	1805	4901	249	1805	3610	2842	3502	1900	2842	43	3226	294

Capacity Analysis Module:

Vol/Sat:	0.04	0.20	0.20	0.08	0.32	0.36	0.08	0.11	0.15	0.12	0.12	0.12
Crit Moves:	****			****					****			****
Green/Cycle:	0.06	0.40	0.40	0.15	0.49	0.72	0.23	0.23	0.23	0.17	0.17	0.17
Volume/Cap:	0.66	0.52	0.52	0.52	0.66	0.51	0.33	0.50	0.66	0.66	0.66	0.66
Delay/Veh:	60.4	23.1	23.1	40.8	20.3	6.5	32.5	34.6	37.7	41.2	41.2	41.2
User DelAdj:	1.00	1.00	1.00	1.00	1.00	1.00	1.00	1.00	1.00	1.00	1.00	1.00
AdjDel/Veh:	60.4	23.1	23.1	40.8	20.3	6.5	32.5	34.6	37.7	41.2	41.2	41.2
LOS by Move:	E	C	C	D	C	A	C	C	D	D	D	D
HCM2k85thQ:	5	14	14	7	22	13	6	10	12	11	11	11

Note: Queue reported is the number of cars per lane.

Santa Ana Circulation Element

Level Of Service Computation Report

ICU 1(Loss as Cycle Length %) Method (Base Volume Alternative)

Intersection #79 Grand Ave and 1st St

Cycle (sec): 100 Critical Vol./Cap.(X): 0.803
 Loss Time (sec): 5 Average Delay (sec/veh): xxxxxx
 Optimal Cycle: 53 Level Of Service: D

Approach:	North Bound			South Bound			East Bound			West Bound		
Movement:	L	T	R	L	T	R	L	T	R	L	T	R
Control:	Protected			Protected			Protected			Protected		
Rights:	Include			Include			Include			Include		
Min. Green:	0	0	0	0	0	0	0	0	0	0	0	0
Y+R:	4.0	4.0	4.0	4.0	4.0	4.0	4.0	4.0	4.0	4.0	4.0	4.0
Lanes:	2	0	2	1	0	0	2	0	3	0	1	0

Volume Module:

Base Vol:	213	751	35	99	1432	174	332	793	225	247	867	99
Growth Adj:	1.00	1.00	1.00	1.00	1.00	1.00	1.00	1.00	1.00	1.00	1.00	1.00
Initial Bse:	213	751	35	99	1432	174	332	793	225	247	867	99
User Adj:	1.00	1.00	1.00	1.00	1.00	1.00	1.00	1.00	1.00	1.00	1.00	1.00
PHF Adj:	1.00	1.00	1.00	1.00	1.00	1.00	1.00	1.00	1.00	1.00	1.00	1.00
PHF Volume:	213	751	35	99	1432	174	332	793	225	247	867	99
Reduct Vol:	0	0	0	0	0	0	0	0	0	0	0	0
Reduced Vol:	213	751	35	99	1432	174	332	793	225	247	867	99
PCE Adj:	1.00	1.00	1.00	1.00	1.00	1.00	1.00	1.00	1.00	1.00	1.00	1.00
MLF Adj:	1.00	1.00	1.00	1.00	1.00	1.00	1.00	1.00	1.00	1.00	1.00	1.00
FinalVolume:	213	751	35	99	1432	174	332	793	225	247	867	99

Saturation Flow Module:

Sat/Lane:	1600	1600	1600	1600	1600	1600	1600	1600	1600	1600	1600	1600
Adjustment:	1.00	1.04	1.00	1.00	1.06	1.00	1.00	1.05	1.00	1.00	1.03	1.00
Lanes:	2.00	2.87	0.13	2.00	3.00	1.00	2.00	2.34	0.66	2.00	1.80	0.20
Final Sat.:	3200	4786	214	3200	5100	1600	3200	3939	1061	3200	2972	328

Capacity Analysis Module:

Vol/Sat:	0.07	0.16	0.16	0.03	0.28	0.11	0.10	0.20	0.21	0.08	0.29	0.30
Crit Moves:	****			****			****			****		

Santa Ana Circulation Element

Level Of Service Computation Report

ICU 1(Loss as Cycle Length %) Method (Base Volume Alternative)

Intersection #80 Grand Ave and Chestnut Ave

Cycle (sec): 100 Critical Vol./Cap.(X): 0.705
 Loss Time (sec): 5 Average Delay (sec/veh): xxxxxx
 Optimal Cycle: 38 Level Of Service: C

Approach:	North Bound			South Bound			East Bound			West Bound		
Movement:	L	T	R	L	T	R	L	T	R	L	T	R
Control:	Protected			Protected			Permitted			Permitted		
Rights:	Include			Include			Include			Include		
Min. Green:	0	0	0	0	0	0	0	0	0	0	0	0
Y+R:	4.0	4.0	4.0	4.0	4.0	4.0	4.0	4.0	4.0	4.0	4.0	4.0
Lanes:	1	0	2	1	0	2	1	0	1	1	0	1

Volume Module:

Base Vol:	53	737	163	149	1788	49	60	419	110	118	347	216
Growth Adj:	1.00	1.00	1.00	1.00	1.00	1.00	1.00	1.00	1.00	1.00	1.00	1.00
Initial Bse:	53	737	163	149	1788	49	60	419	110	118	347	216
User Adj:	1.00	1.00	1.00	1.00	1.00	1.00	1.00	1.00	1.00	1.00	1.00	1.00
PHF Adj:	1.00	1.00	1.00	1.00	1.00	1.00	1.00	1.00	1.00	1.00	1.00	1.00
PHF Volume:	53	737	163	149	1788	49	60	419	110	118	347	216
Reduct Vol:	0	0	0	0	0	0	0	0	0	0	0	0
Reduced Vol:	53	737	163	149	1788	49	60	419	110	118	347	216
PCE Adj:	1.00	1.00	1.00	1.00	1.00	1.00	1.00	1.00	1.00	1.00	1.00	1.00
MLF Adj:	1.00	1.00	1.00	1.00	1.00	1.00	1.00	1.00	1.00	1.00	1.00	1.00
FinalVolume:	53	737	163	149	1788	49	60	419	110	118	347	216

Saturation Flow Module:

Sat/Lane:	1600	1600	1600	1600	1600	1600	1600	1600	1600	1600	1600	1600
Adjustment:	1.00	1.05	1.00	1.00	1.04	1.00	1.00	1.04	1.00	1.00	1.05	1.00
Lanes:	1.00	2.46	0.54	1.00	2.92	0.08	1.00	1.58	0.42	1.00	1.23	0.77
Final Sat.:	1600	4131	869	1600	4872	128	1600	2635	665	1600	2072	1228

Capacity Analysis Module:

Vol/Sat:	0.03	0.18	0.19	0.09	0.37	0.38	0.04	0.16	0.17	0.07	0.17	0.18
Crit Moves:	****					****			****	****		

Santa Ana Circulation Element

Level Of Service Computation Report

ICU 1(Loss as Cycle Length %) Method (Base Volume Alternative)

Intersection #81 Grand Ave and McFadden Ave

Cycle (sec): 100 Critical Vol./Cap.(X): 0.829
 Loss Time (sec): 5 Average Delay (sec/veh): xxxxxx
 Optimal Cycle: 59 Level Of Service: D

Approach:	North Bound			South Bound			East Bound			West Bound		
Movement:	L	T	R	L	T	R	L	T	R	L	T	R
Control:	Protected			Protected			Protected			Protected		
Rights:	Include			Include			Include			Include		
Min. Green:	0	0	0	0	0	0	0	0	0	0	0	0
Y+R:	4.0	4.0	4.0	4.0	4.0	4.0	4.0	4.0	4.0	4.0	4.0	4.0
Lanes:	1	0	2	1	0	2	1	0	1	1	0	1

Volume Module:

Base Vol:	171	722	108	237	1590	155	186	601	182	117	420	106
Growth Adj:	1.00	1.00	1.00	1.00	1.00	1.00	1.00	1.00	1.00	1.00	1.00	1.00
Initial Bse:	171	722	108	237	1590	155	186	601	182	117	420	106
User Adj:	1.00	1.00	1.00	1.00	1.00	1.00	1.00	1.00	1.00	1.00	1.00	1.00
PHF Adj:	1.00	1.00	1.00	1.00	1.00	1.00	1.00	1.00	1.00	1.00	1.00	1.00
PHF Volume:	171	722	108	237	1590	155	186	601	182	117	420	106
Reduct Vol:	0	0	0	0	0	0	0	0	0	0	0	0
Reduced Vol:	171	722	108	237	1590	155	186	601	182	117	420	106
PCE Adj:	1.00	1.00	1.00	1.00	1.00	1.00	1.00	1.00	1.00	1.00	1.00	1.00
MLF Adj:	1.00	1.00	1.00	1.00	1.00	1.00	1.00	1.00	1.00	1.00	1.00	1.00
FinalVolume:	171	722	108	237	1590	155	186	601	182	117	420	106

Saturation Flow Module:

Sat/Lane:	1600	1600	1600	1600	1600	1600	1600	1600	1600	1600	1600	1600
Adjustment:	1.00	1.05	1.00	1.00	1.05	1.00	1.00	1.04	1.00	1.00	1.04	1.00
Lanes:	1.00	2.61	0.39	1.00	2.73	0.27	1.00	1.54	0.46	1.00	1.60	0.40
Final Sat.:	1600	4375	625	1600	4574	426	1600	2556	744	1600	2655	645

Capacity Analysis Module:

Vol/Sat:	0.11	0.17	0.17	0.15	0.35	0.36	0.12	0.24	0.24	0.07	0.16	0.16
Crit Moves:	****			****			****			****		

Santa Ana Circulation Element

Level Of Service Computation Report

ICU 1(Loss as Cycle Length %) Method (Base Volume Alternative)

Intersection #82 Grand Ave and Edinger Ave

Cycle (sec): 100 Critical Vol./Cap.(X): 0.763
 Loss Time (sec): 5 Average Delay (sec/veh): xxxxxx
 Optimal Cycle: 45 Level Of Service: C

Approach:	North Bound			South Bound			East Bound			West Bound		
Movement:	L	T	R	L	T	R	L	T	R	L	T	R
Control:	Protected			Protected			Protected			Protected		
Rights:	Include			Include			Include			Include		
Min. Green:	0	0	0	0	0	0	0	0	0	0	0	0
Y+R:	4.0	4.0	4.0	4.0	4.0	4.0	4.0	4.0	4.0	4.0	4.0	4.0
Lanes:	1	0	2	1	0	2	1	0	2	1	0	2

Volume Module:

Base Vol:	47	472	92	224	1146	224	319	1332	128	151	579	126
Growth Adj:	1.00	1.00	1.00	1.00	1.00	1.00	1.00	1.00	1.00	1.00	1.00	1.00
Initial Bse:	47	472	92	224	1146	224	319	1332	128	151	579	126
User Adj:	1.00	1.00	1.00	1.00	1.00	1.00	1.00	1.00	1.00	1.00	1.00	1.00
PHF Adj:	1.00	1.00	1.00	1.00	1.00	1.00	1.00	1.00	1.00	1.00	1.00	1.00
PHF Volume:	47	472	92	224	1146	224	319	1332	128	151	579	126
Reduct Vol:	0	0	0	0	0	0	0	0	0	0	0	0
Reduced Vol:	47	472	92	224	1146	224	319	1332	128	151	579	126
PCE Adj:	1.00	1.00	1.00	1.00	1.00	1.00	1.00	1.00	1.00	1.00	1.00	1.00
MLF Adj:	1.00	1.00	1.00	1.00	1.00	1.00	1.00	1.00	1.00	1.00	1.00	1.00
FinalVolume:	47	472	92	224	1146	224	319	1332	128	151	579	126

Saturation Flow Module:

Sat/Lane:	1600	1600	1600	1600	1600	1600	1600	1600	1600	1600	1600	1600
Adjustment:	1.00	1.05	1.00	1.00	1.05	1.00	1.00	1.05	1.00	1.00	1.05	1.00
Lanes:	1.00	2.51	0.49	1.00	2.51	0.49	1.00	2.74	0.26	1.00	2.46	0.54
Final Sat.:	1600	4217	783	1600	4215	785	1600	4579	421	1600	4142	858

Capacity Analysis Module:

Vol/Sat:	0.03	0.11	0.12	0.14	0.27	0.29	0.20	0.29	0.30	0.09	0.14	0.15
Crit Moves:	****				****			****		****		

Santa Ana Circulation Element

Level of Service Computation Report

ICU 1(Loss as Cycle Length %) Method (Base Volume Alternative)

Intersection #83 Grand Ave and Warner Ave

Cycle (sec): 100 Critical Vol./Cap.(X): 0.528
 Loss Time (sec): 0 Average Delay (sec/veh): xxxxxx
 Optimal Cycle: 48 Level Of Service: A

Approach:	North Bound			South Bound			East Bound			West Bound		
Movement:	L	T	R	L	T	R	L	T	R	L	T	R
Control:	Protected			Protected			Protected			Protected		
Rights:	Include			Include			Include			Include		
Min. Green:	0	0	0	0	0	0	0	0	0	0	0	0
Y+R:	4.0	4.0	4.0	4.0	4.0	4.0	4.0	4.0	4.0	4.0	4.0	4.0
Lanes:	1	0	2	1	0	2	2	0	3	2	0	2

Volume Module:

Base Vol:	169	510	218	199	574	194	256	914	359	88	388	131
Growth Adj:	1.00	1.00	1.00	1.00	1.00	1.00	1.00	1.00	1.00	1.00	1.00	1.00
Initial Bse:	169	510	218	199	574	194	256	914	359	88	388	131
User Adj:	1.00	1.00	1.00	1.00	1.00	1.00	1.00	1.00	1.00	1.00	1.00	1.00
PHF Adj:	1.00	1.00	1.00	1.00	1.00	1.00	1.00	1.00	1.00	1.00	1.00	1.00
PHF Volume:	169	510	218	199	574	194	256	914	359	88	388	131
Reduct Vol:	0	0	0	0	0	0	0	0	0	0	0	0
Reduced Vol:	169	510	218	199	574	194	256	914	359	88	388	131
PCE Adj:	1.00	1.00	1.00	1.00	1.00	1.00	1.00	1.00	1.00	1.00	1.00	1.00
MLF Adj:	1.00	1.00	1.00	1.00	1.00	1.00	1.00	1.00	1.00	1.00	1.00	1.00
FinalVolume:	169	510	218	199	574	194	256	914	359	88	388	131

Saturation Flow Module:

Sat/Lane:	1600	1600	1600	1600	1600	1600	1600	1600	1600	1600	1600	1600
Adjustment:	1.00	1.06	1.00	1.00	1.06	1.00	1.00	1.06	1.00	1.00	1.06	1.00
Lanes:	1.00	2.10	0.90	1.00	2.24	0.76	2.00	3.00	1.00	2.00	2.00	1.00
Final Sat.:	1600	3563	1437	1600	3788	1213	3200	5100	1600	3200	3400	1600

Capacity Analysis Module:

Vol/Sat:	0.11	0.14	0.15	0.12	0.15	0.16	0.08	0.18	0.22	0.03	0.11	0.08
Crit Moves:			****	****					****	****		

Santa Ana Circulation Element

Level Of Service Computation Report
 2000 HCM Operations Method (Base Volume Alternative)

 Intersection #84 SR-55 NB Ramps and Dyer Rd

Cycle (sec): 100 Critical Vol./Cap.(X): 0.530
 Loss Time (sec): 5 Average Delay (sec/veh): 16.3
 Optimal Cycle: 26 Level Of Service: B

Approach:	North Bound			South Bound			East Bound			West Bound		
Movement:	L	T	R	L	T	R	L	T	R	L	T	R
Control:	Split Phase			Split Phase			Protected			Protected		
Rights:	Include			Include			Ignore			Ignore		
Min. Green:	0	0	0	0	0	0	0	0	0	0	0	0
Y+R:	4.0	4.0	4.0	4.0	4.0	4.0	4.0	4.0	4.0	4.0	4.0	4.0
Lanes:	1	0	1	0	0	0	0	0	3	0	1	0

Volume Module:	North Bound			South Bound			East Bound			West Bound		
Base Vol:	557	0	456	0	0	0	0	1533	613	0	719	433
Growth Adj:	1.00	1.00	1.00	1.00	1.00	1.00	1.00	1.00	1.00	1.00	1.00	1.00
Initial Bse:	557	0	456	0	0	0	0	1533	613	0	719	433
User Adj:	1.00	1.00	1.00	1.00	1.00	1.00	1.00	1.00	0.00	1.00	1.00	0.00
PHF Adj:	1.00	1.00	1.00	1.00	1.00	1.00	1.00	1.00	0.00	1.00	1.00	0.00
PHF Volume:	557	0	456	0	0	0	0	1533	0	0	719	0
Reduct Vol:	0	0	0	0	0	0	0	0	0	0	0	0
Reduced Vol:	557	0	456	0	0	0	0	1533	0	0	719	0
PCE Adj:	1.00	1.00	1.00	1.00	1.00	1.00	1.00	1.00	0.00	1.00	1.00	0.00
MLF Adj:	1.00	1.00	1.00	1.00	1.00	1.00	1.00	1.00	0.00	1.00	1.00	0.00
Final Volume:	557	0	456	0	0	0	0	1533	0	0	719	0

Saturation Flow Module:	North Bound			South Bound			East Bound			West Bound		
Sat/Lane:	1900	1900	1900	1900	1900	1900	1900	1900	1900	1900	1900	1900
Adjustment:	0.91	1.00	0.91	1.00	1.00	1.00	1.00	0.91	1.00	1.00	0.91	0.91
Lanes:	1.55	0.00	1.45	0.00	0.00	0.00	0.00	3.00	1.00	0.00	3.00	0.00
Final Sat.:	2673	0	2501	0	0	0	0	5187	1900	0	5187	0

Capacity Analysis Module:	North Bound			South Bound			East Bound			West Bound		
Vol/Sat:	0.21	0.00	0.18	0.00	0.00	0.00	0.00	0.30	0.00	0.00	0.14	0.00
Crit Moves:	****			****			****			****		
Green/Cycle:	0.39	0.00	0.39	0.00	0.00	0.00	0.00	0.56	0.00	0.00	0.56	0.00
Volume/Cap:	0.53	0.00	0.46	0.00	0.00	0.00	0.00	0.53	0.00	0.00	0.25	0.00
Delay/Veh:	23.6	0.0	22.7	0.0	0.0	0.0	0.0	14.1	0.0	0.0	11.4	0.0
User DelAdj:	1.00	1.00	1.00	1.00	1.00	1.00	1.00	1.00	1.00	1.00	1.00	1.00
AdjDel/Veh:	23.6	0.0	22.7	0.0	0.0	0.0	0.0	14.1	0.0	0.0	11.4	0.0
LOS by Move:	C	A	C	A	A	A	A	B	A	A	B	A
HCM2k85thQ:	13	0	11	0	0	0	0	16	0	0	6	0

 Note: Queue reported is the number of cars per lane.

Santa Ana Circulation Element

Level Of Service Computation Report

2000 HCM 4-Way Stop Method (Base Volume Alternative)

 Intersection #85 Cambridge St and La Veta Ave

Cycle (sec): 100 Critical Vol./Cap.(X): 0.799
 Loss Time (sec): 5 Average Delay (sec/veh): 17.3
 Optimal Cycle: 0 Level Of Service: C

Approach:	North Bound			South Bound			East Bound			West Bound		
Movement:	L	T	R	L	T	R	L	T	R	L	T	R
Control:	Stop Sign			Stop Sign			Stop Sign			Stop Sign		
Rights:	Include			Include			Include			Include		
Min. Green:	0	0	0	0	0	0	0	0	0	0	0	0
Lanes:	1	0	1	0	0	1	1	0	0	0	0	0

Volume Module:

Base Vol:	160	204	0	0	480	245	117	0	187	0	0	0
Growth Adj:	1.00	1.00	1.00	1.00	1.00	1.00	1.00	1.00	1.00	1.00	1.00	1.00
Initial Bse:	160	204	0	0	480	245	117	0	187	0	0	0
User Adj:	1.00	1.00	1.00	1.00	1.00	1.00	1.00	1.00	1.00	1.00	1.00	1.00
PHF Adj:	1.00	1.00	1.00	1.00	1.00	1.00	1.00	1.00	1.00	1.00	1.00	1.00
PHF Volume:	160	204	0	0	480	245	117	0	187	0	0	0
Reduct Vol:	0	0	0	0	0	0	0	0	0	0	0	0
Reduced Vol:	160	204	0	0	480	245	117	0	187	0	0	0
PCE Adj:	1.00	1.00	1.00	1.00	1.00	1.00	1.00	1.00	1.00	1.00	1.00	1.00
MLF Adj:	1.00	1.00	1.00	1.00	1.00	1.00	1.00	1.00	1.00	1.00	1.00	1.00
FinalVolume:	160	204	0	0	480	245	117	0	187	0	0	0

Saturation Flow Module:

Adjustment:	1.00	1.00	1.00	1.00	1.00	1.00	1.00	1.00	1.00	1.00	1.00	1.00
Lanes:	1.00	1.00	0.00	0.00	1.00	1.00	1.00	0.00	1.00	0.00	0.00	0.00
Final Sat.:	514	554	0	0	601	671	467	0	553	0	0	0

Capacity Analysis Module:

Vol/Sat:	0.31	0.37	xxxx	xxxx	0.80	0.37	0.25	xxxx	0.34	xxxx	xxxx	xxxx
Crit Moves:	****			****			****			****		
Delay/Veh:	12.5	12.5	0.0	0.0	27.6	10.8	12.4	0.0	11.8	0.0	0.0	0.0
Delay Adj:	1.00	1.00	1.00	1.00	1.00	1.00	1.00	1.00	1.00	1.00	1.00	1.00
AdjDel/Veh:	12.5	12.5	0.0	0.0	27.6	10.8	12.4	0.0	11.8	0.0	0.0	0.0
LOS by Move:	B	B	*	*	D	B	B	*	B	*	*	*
ApproachDel:	12.5			21.9			12.0			xxxxxxx		
Delay Adj:	1.00			1.00			1.00			xxxxxxx		
ApprAdjDel:	12.5			21.9			12.0			xxxxxxx		
LOS by Appr:	B			C			B			*		
AllWayAvgQ:	0.4	0.5	0.0	0.0	3.2	0.5	0.3	0.0	0.4	0.0	0.0	0.0

 Note: Queue reported is the number of cars per lane.

Santa Ana Circulation Element

Level Of Service Computation Report

ICU 1(Loss as Cycle Length %) Method (Base Volume Alternative)

Intersection #86 Cambridge St and Fairhaven Ave

Cycle (sec): 100 Critical Vol./Cap.(X): 0.559

Loss Time (sec): 5 Average Delay (sec/veh): xxxxxx

Optimal Cycle: 26 Level Of Service: A

Approach:	North Bound			South Bound			East Bound			West Bound		
Movement:	L	T	R	L	T	R	L	T	R	L	T	R
Control:	Permitted			Permitted			Permitted			Permitted		
Rights:	Include			Include			Include			Include		
Min. Green:	0	0	0	0	0	0	0	0	0	0	0	0
Y+R:	4.0	4.0	4.0	4.0	4.0	4.0	4.0	4.0	4.0	4.0	4.0	4.0
Lanes:	0	0	0	1	0	0	1	0	2	0	0	1

Volume Module:	North Bound			South Bound			East Bound			West Bound		
Base Vol:	0	0	0	515	0	166	80	216	0	0	247	192
Growth Adj:	1.00	1.00	1.00	1.00	1.00	1.00	1.00	1.00	1.00	1.00	1.00	1.00
Initial Bse:	0	0	0	515	0	166	80	216	0	0	247	192
User Adj:	1.00	1.00	1.00	1.00	1.00	1.00	1.00	1.00	1.00	1.00	1.00	1.00
PHF Adj:	1.00	1.00	1.00	1.00	1.00	1.00	1.00	1.00	1.00	1.00	1.00	1.00
PHF Volume:	0	0	0	515	0	166	80	216	0	0	247	192
Reduct Vol:	0	0	0	0	0	0	0	0	0	0	0	0
Reduced Vol:	0	0	0	515	0	166	80	216	0	0	247	192
PCE Adj:	1.00	1.00	1.00	1.00	1.00	1.00	1.00	1.00	1.00	1.00	1.00	1.00
MLF Adj:	1.00	1.00	1.00	1.00	1.00	1.00	1.00	1.00	1.00	1.00	1.00	1.00
FinalVolume:	0	0	0	515	0	166	80	216	0	0	247	192

Saturation Flow Module:	North Bound			South Bound			East Bound			West Bound		
Sat/Lane:	1600	1600	1600	1600	1600	1600	1600	1600	1600	1600	1600	1600
Adjustment:	1.00	1.06	1.00	1.00	1.06	1.00	1.00	1.06	1.00	1.00	1.06	1.00
Lanes:	0.00	0.00	0.00	1.00	0.00	1.00	1.00	2.00	0.00	0.00	1.13	0.87
Final Sat.:	0	0	0	1600	0	1600	1600	3400	0	0	1900	1400

Capacity Analysis Module:	North Bound			South Bound			East Bound			West Bound		
Vol/Sat:	0.00	0.00	0.00	0.32	0.00	0.10	0.05	0.06	0.00	0.00	0.13	0.14
Crit Moves:				***			***					***

Santa Ana Circulation Element

Level Of Service Computation Report
 2000 HCM Operations Method (Base Volume Alternative)

 Intersection #87 Mabury St and 1st Street

Cycle (sec): 100 Critical Vol./Cap.(X): 0.691
 Loss Time (sec): 0 Average Delay (sec/veh): 28.3
 Optimal Cycle: 74 Level Of Service: C

Street Name:	Mabury						1st Street					
Approach:	North Bound			South Bound			East Bound			West Bound		
Movement:	L	T	R	L	T	R	L	T	R	L	T	R
Control:	Split Phase			Split Phase			Protected			Protected		
Rights:	Include			Include			Include			Include		
Min. Green:	0	0	0	0	0	0	0	0	0	0	0	0
Y+R:	4.0	4.0	4.0	4.0	4.0	4.0	4.0	4.0	4.0	4.0	4.0	4.0
Lanes:	1	0	0	0	1	0	0	0	2	1	0	2

Volume Module:

Base Vol:	10	0	244	238	141	533	0	1062	11	46	701	0
Growth Adj:	1.00	1.00	1.00	1.00	1.00	1.00	1.00	1.00	1.00	1.00	1.00	1.00
Initial Bse:	10	0	244	238	141	533	0	1062	11	46	701	0
User Adj:	1.00	1.00	1.00	1.00	1.00	1.00	1.00	1.00	1.00	1.00	1.00	1.00
PHF Adj:	1.00	1.00	1.00	1.00	1.00	1.00	1.00	1.00	1.00	1.00	1.00	1.00
PHF Volume:	10	0	244	238	141	533	0	1062	11	46	701	0
Reduct Vol:	0	0	0	0	0	0	0	0	0	0	0	0
Reduced Vol:	10	0	244	238	141	533	0	1062	11	46	701	0
PCE Adj:	1.00	1.00	1.00	1.00	1.00	1.00	1.00	1.00	1.00	1.00	1.00	1.00
MLF Adj:	1.00	1.00	1.00	1.00	1.00	1.00	1.00	1.00	1.00	1.00	1.00	1.00
Final Volume:	10	0	244	238	141	533	0	1062	11	46	701	0

Saturation Flow Module:

Sat/Lane:	1900	1900	1900	1900	1900	1900	1900	1900	1900	1900	1900	1900
Adjustment:	0.95	1.00	0.85	0.90	0.90	0.90	1.00	0.91	0.91	0.95	0.91	0.91
Lanes:	1.00	0.00	1.00	1.22	0.27	1.51	0.00	2.97	0.03	1.00	3.00	0.00
Final Sat.:	1805	0	1615	2097	458	2576	0	5129	53	1805	5187	0

Capacity Analysis Module:

Vol/Sat:	0.01	0.00	0.15	0.11	0.31	0.21	0.00	0.21	0.21	0.03	0.14	0.00
Crit Moves:			****		****			****		****		
Green/Cycle:	0.22	0.00	0.22	0.45	0.45	0.45	0.00	0.30	0.30	0.04	0.34	0.00
Volume/Cap:	0.03	0.00	0.69	0.25	0.69	0.46	0.00	0.69	0.69	0.69	0.40	0.00
Delay/Veh:	30.7	0.0	41.8	17.4	23.8	19.6	0.0	32.3	32.3	74.4	25.6	0.0
User DelAdj:	1.00	1.00	1.00	1.00	1.00	1.00	1.00	1.00	1.00	1.00	1.00	1.00
AdjDel/Veh:	30.7	0.0	41.8	17.4	23.8	19.6	0.0	32.3	32.3	74.4	25.6	0.0
LOS by Move:	C	A	D	B	C	B	A	C	C	E	C	A
HCM2k85thQ:	0	0	13	6	21	12	0	18	18	4	9	0

Note: Queue reported is the number of cars per lane.

Santa Ana Circulation Element

Level of Service Computation Report

ICU 1(Loss as Cycle Length %) Method (Base Volume Alternative)

Intersection #88 Tustin St and La Veta Ave

Cycle (sec): 100 Critical Vol./Cap.(X): 0.521
 Loss Time (sec): 5 Average Delay (sec/veh): xxxxxx
 Optimal Cycle: 25 Level Of Service: A

Approach:	North Bound			South Bound			East Bound			West Bound		
Movement:	L	T	R	L	T	R	L	T	R	L	T	R
Control:	Protected			Protected			Split Phase			Split Phase		
Rights:	Include			Include			Include			Ovl		
Min. Green:	0	0	0	0	0	0	0	0	0	0	0	0
Y+R:	4.0	4.0	4.0	4.0	4.0	4.0	4.0	4.0	4.0	4.0	4.0	4.0
Lanes:	1	0	2	1	0	2	1	0	1	1	0	0

Volume Module:

Base Vol:	8	333	96	74	1452	4	9	11	35	447	2	69
Growth Adj:	1.00	1.00	1.00	1.00	1.00	1.00	1.00	1.00	1.00	1.00	1.00	1.00
Initial Bse:	8	333	96	74	1452	4	9	11	35	447	2	69
User Adj:	1.00	1.00	1.00	1.00	1.00	1.00	1.00	1.00	1.00	1.00	1.00	1.00
PHF Adj:	1.00	1.00	1.00	1.00	1.00	1.00	1.00	1.00	1.00	1.00	1.00	1.00
PHF Volume:	8	333	96	74	1452	4	9	11	35	447	2	69
Reduct Vol:	0	0	0	0	0	0	0	0	0	0	0	0
Reduced Vol:	8	333	96	74	1452	4	9	11	35	447	2	69
PCE Adj:	1.00	1.00	1.00	1.00	1.00	1.00	1.00	1.00	1.00	1.00	1.00	1.00
MLF Adj:	1.00	1.00	1.00	1.00	1.00	1.00	1.00	1.00	1.00	1.00	1.00	1.00
FinalVolume:	8	333	96	74	1452	4	9	11	35	447	2	69
OvlAdjVol:												0

Saturation Flow Module:

Sat/Lane:	1600	1600	1600	1600	1600	1600	1600	1600	1600	1600	1600	1600
Adjustment:	1.00	1.05	1.00	1.00	1.04	1.00	1.00	1.06	1.00	1.00	1.00	1.00
Lanes:	1.00	2.33	0.67	1.00	2.99	0.01	1.00	1.00	1.00	1.99	0.01	1.00
Final Sat.:	1600	3926	1074	1600	4987	13	1600	1700	1600	3186	14	1600

Capacity Analysis Module:

Vol/Sat:	0.01	0.08	0.09	0.05	0.29	0.30	0.01	0.01	0.02	0.14	0.14	0.04
OvlAdjV/S:												0.00
Crit Moves:	****				****			****	****			

Santa Ana Circulation Element

Level of Service Computation Report
 2000 HCM Operations Method (Base Volume Alternative)

 Intersection #89 Tustin St and SR-22 WB On-Ramp

Cycle (sec): 100 Critical Vol./Cap.(X): 0.734
 Loss Time (sec): 5 Average Delay (sec/veh): 12.9
 Optimal Cycle: 43 Level of Service: B

Approach:	North Bound			South Bound			East Bound			West Bound		
Movement:	L	T	R	L	T	R	L	T	R	L	T	R
Control:	Protected			Permitted			Protected			Protected		
Rights:	Include			Include			Include			Include		
Min. Green:	0	0	0	0	0	0	0	0	0	0	0	0
Y+R:	4.0	4.0	4.0	4.0	4.0	4.0	4.0	4.0	4.0	4.0	4.0	4.0
Lanes:	2	0	2	0	0	2	1	0	0	0	0	0

Volume Module:

Base Vol:	656	610	0	0	1395	833	0	0	0	0	0	0
Growth Adj:	1.00	1.00	1.00	1.00	1.00	1.00	1.00	1.00	1.00	1.00	1.00	1.00
Initial Bse:	656	610	0	0	1395	833	0	0	0	0	0	0
User Adj:	1.00	1.00	1.00	1.00	1.00	1.00	1.00	1.00	1.00	1.00	1.00	1.00
PHF Adj:	1.00	1.00	1.00	1.00	1.00	1.00	1.00	1.00	1.00	1.00	1.00	1.00
PHF Volume:	656	610	0	0	1395	833	0	0	0	0	0	0
Reduct Vol:	0	0	0	0	0	0	0	0	0	0	0	0
Reduced Vol:	656	610	0	0	1395	833	0	0	0	0	0	0
PCE Adj:	1.00	1.00	1.00	1.00	1.00	1.00	1.00	1.00	1.00	1.00	1.00	1.00
MLF Adj:	1.00	1.00	1.00	1.00	1.00	1.00	1.00	1.00	1.00	1.00	1.00	1.00
Final Volume:	656	610	0	0	1395	833	0	0	0	0	0	0

Saturation Flow Module:

Sat/Lane:	1900	1900	1900	1900	1900	1900	1900	1900	1900	1900	1900	1900
Adjustment:	0.92	0.95	1.00	1.00	0.86	0.86	1.00	1.00	1.00	1.00	1.00	1.00
Lanes:	2.00	2.00	0.00	0.00	2.00	1.00	0.00	0.00	0.00	0.00	0.00	0.00
Final Sat.:	3502	3610	0	0	3264	1632	0	0	0	0	0	0

Capacity Analysis Module:

Vol/Sat:	0.19	0.17	0.00	0.00	0.43	0.51	0.00	0.00	0.00	0.00	0.00	0.00
Crit Moves:	****			****								
Green/Cycle:	0.26	0.95	0.00	0.00	0.69	0.69	0.00	0.00	0.00	0.00	0.00	0.00
Volume/Cap:	0.73	0.18	0.00	0.00	0.61	0.73	0.00	0.00	0.00	0.00	0.00	0.00
Delay/Veh:	37.3	0.2	0.0	0.0	8.4	10.5	0.0	0.0	0.0	0.0	0.0	0.0
User DelAdj:	1.00	1.00	1.00	1.00	1.00	1.00	1.00	1.00	1.00	1.00	1.00	1.00
AdjDel/Veh:	37.3	0.2	0.0	0.0	8.4	10.5	0.0	0.0	0.0	0.0	0.0	0.0
LOS by Move:	D	A	A	A	A	B	A	A	A	A	A	A
HCM2k85thQ:	17	1	0	0	19	27	0	0	0	0	0	0

Note: Queue reported is the number of cars per lane.

Santa Ana Circulation Element

Level Of Service Computation Report

2000 HCM Operations Method (Base Volume Alternative)

 Intersection #90 Tustin St and SR-22 EB Off-Ramp / Seba Ave

Cycle (sec): 100 Critical Vol./Cap.(X): 0.731
 Loss Time (sec): 5 Average Delay (sec/veh): 24.2
 Optimal Cycle: 43 Level Of Service: C

Approach:	North Bound			South Bound			East Bound			West Bound		
Movement:	L	T	R	L	T	R	L	T	R	L	T	R
Control:	Permitted			Permitted			Split Phase			Split Phase		
Rights:	Include			Include			Include			Include		
Min. Green:	0	0	0	0	0	0	0	0	0	0	0	0
Y+R:	4.0	4.0	4.0	4.0	4.0	4.0	4.0	4.0	4.0	4.0	4.0	4.0
Lanes:	0	0	2	1	0	3	0	1	0	1	0	0

Volume Module:	North Bound			South Bound			East Bound			West Bound		
Base Vol:	0	996	5	22	1349	0	244	24	1051	6	0	43
Growth Adj:	1.00	1.00	1.00	1.00	1.00	1.00	1.00	1.00	1.00	1.00	1.00	1.00
Initial Bse:	0	996	5	22	1349	0	244	24	1051	6	0	43
User Adj:	1.00	1.00	1.00	1.00	1.00	1.00	1.00	1.00	1.00	1.00	1.00	1.00
PHF Adj:	1.00	1.00	1.00	1.00	1.00	1.00	1.00	1.00	1.00	1.00	1.00	1.00
PHF Volume:	0	996	5	22	1349	0	244	24	1051	6	0	43
Reduct Vol:	0	0	0	0	0	0	0	0	0	0	0	0
Reduced Vol:	0	996	5	22	1349	0	244	24	1051	6	0	43
PCE Adj:	1.00	1.00	1.00	1.00	1.00	1.00	1.00	1.00	1.00	1.00	1.00	1.00
MLF Adj:	1.00	1.00	1.00	1.00	1.00	1.00	1.00	1.00	1.00	1.00	1.00	1.00
FinalVolume:	0	996	5	22	1349	0	244	24	1051	6	0	43

Saturation Flow Module:	North Bound			South Bound			East Bound			West Bound		
Sat/Lane:	1900	1900	1900	1900	1900	1900	1900	1900	1900	1900	1900	1900
Adjustment:	1.00	0.91	0.91	0.16	0.91	1.00	0.87	0.87	0.87	0.88	1.00	0.88
Lanes:	0.00	2.99	0.01	1.00	3.00	0.00	1.18	0.04	1.78	0.12	0.00	0.88
Final Sat.:	0	5156	26	304	5187	0	1958	59	2954	204	0	1460

Capacity Analysis Module:	North Bound			South Bound			East Bound			West Bound		
Vol/Sat:	0.00	0.19	0.19	0.07	0.26	0.00	0.12	0.41	0.36	0.03	0.00	0.03
Crit Moves:				****			****			****		
Green/Cycle:	0.00	0.36	0.36	0.36	0.36	0.00	0.55	0.55	0.55	0.04	0.00	0.04
Volume/Cap:	0.00	0.54	0.54	0.20	0.73	0.00	0.22	0.73	0.64	0.73	0.00	0.73
Delay/Veh:	0.0	26.1	26.1	23.3	29.6	0.0	11.4	18.3	16.1	80.9	0.0	80.9
User DelAdj:	1.00	1.00	1.00	1.00	1.00	1.00	1.00	1.00	1.00	1.00	1.00	1.00
AdjDel/Veh:	0.0	26.1	26.1	23.3	29.6	0.0	11.4	18.3	16.1	80.9	0.0	80.9
LOS by Move:	A	C	C	C	C	A	B	B	B	F	A	F
HCM2k85thQ:	0	14	14	1	21	0	5	24	20	5	0	5

Note: Queue reported is the number of cars per lane.

Santa Ana Circulation Element

Level Of Service Computation Report

ICU 1(Loss as Cycle Length %) Method (Base Volume Alternative)

 Intersection #91 Tustin Ave and Fairhaven Ave

Cycle (sec): 100 Critical Vol./Cap.(X): 0.977
 Loss Time (sec): 5 Average Delay (sec/veh): xxxxxx
 Optimal Cycle: 178 Level Of Service: E

Approach:	North Bound			South Bound			East Bound			West Bound		
Movement:	L	T	R	L	T	R	L	T	R	L	T	R
Control:	Protected			Protected			Protected			Protected		
Rights:	Include			Include			Include			Ovl		
Min. Green:	0	0	0	0	0	0	0	0	0	0	0	0
Y+R:	4.0	4.0	4.0	4.0	4.0	4.0	4.0	4.0	4.0	4.0	4.0	4.0
Lanes:	2	0	2	1	0	0	2	0	2	1	0	1

Volume Module:

Base Vol:	89	514	90	235	2026	40	68	258	444	306	338	442
Growth Adj:	1.00	1.00	1.00	1.00	1.00	1.00	1.00	1.00	1.00	1.00	1.00	1.00
Initial Bse:	89	514	90	235	2026	40	68	258	444	306	338	442
User Adj:	1.00	1.00	1.00	1.00	1.00	1.00	1.00	1.00	1.00	1.00	1.00	1.00
PHF Adj:	1.00	1.00	1.00	1.00	1.00	1.00	1.00	1.00	1.00	1.00	1.00	1.00
PHF Volume:	89	514	90	235	2026	40	68	258	444	306	338	442
Reduct Vol:	0	0	0	0	0	0	0	0	0	0	0	0
Reduced Vol:	89	514	90	235	2026	40	68	258	444	306	338	442
PCE Adj:	1.00	1.00	1.00	1.00	1.00	1.00	1.00	1.00	1.00	1.00	1.00	1.00
MLF Adj:	1.00	1.00	1.00	1.00	1.00	1.00	1.00	1.00	1.00	1.00	1.00	1.00
FinalVolume:	89	514	90	235	2026	40	68	258	444	306	338	442
OvlAdjVol:	325											

Saturation Flow Module:

Sat/Lane:	1600	1600	1600	1600	1600	1600	1600	1600	1600	1600	1600	1600
Adjustment:	1.00	1.05	1.00	1.00	1.04	1.00	1.00	1.06	1.00	1.00	1.06	1.00
Lanes:	2.00	2.55	0.45	2.00	2.94	0.06	1.00	1.00	1.00	1.00	1.00	1.00
Final Sat.:	3200	4285	715	3200	4907	93	1600	1700	1600	1600	1700	1600

Capacity Analysis Module:

Vol/Sat:	0.03	0.12	0.13	0.07	0.41	0.43	0.04	0.15	0.28	0.19	0.20	0.28
OvlAdjV/S:	0.20											
Crit Moves:	****			****			****			****		

Santa Ana Circulation Element

Level Of Service Computation Report

ICU 1(Loss as Cycle Length %) Method (Base Volume Alternative)

Intersection #92 Tustin Ave and Santa Clara Ave

Cycle (sec): 100 Critical Vol./Cap.(X): 0.866
 Loss Time (sec): 5 Average Delay (sec/veh): xxxxxx
 Optimal Cycle: 71 Level Of Service: D

Approach:	North Bound			South Bound			East Bound			West Bound		
Movement:	L	T	R	L	T	R	L	T	R	L	T	R
Control:	Protected			Protected			Permitted			Permitted		
Rights:	Include			Include			Include			Include		
Min. Green:	0	0	0	0	0	0	0	0	0	0	0	0
Y+R:	4.0	4.0	4.0	4.0	4.0	4.0	4.0	4.0	4.0	4.0	4.0	4.0
Lanes:	1	0	2	1	0	2	1	0	1	1	0	1

Volume Module:

Base Vol:	73	397	74	127	2600	82	101	255	186	118	244	122
Growth Adj:	1.00	1.00	1.00	1.00	1.00	1.00	1.00	1.00	1.00	1.00	1.00	1.00
Initial Bse:	73	397	74	127	2600	82	101	255	186	118	244	122
User Adj:	1.00	1.00	1.00	1.00	1.00	1.00	1.00	1.00	1.00	1.00	1.00	1.00
PHF Adj:	1.00	1.00	1.00	1.00	1.00	1.00	1.00	1.00	1.00	1.00	1.00	1.00
PHF Volume:	73	397	74	127	2600	82	101	255	186	118	244	122
Reduct Vol:	0	0	0	0	0	0	0	0	0	0	0	0
Reduced Vol:	73	397	74	127	2600	82	101	255	186	118	244	122
PCE Adj:	1.00	1.00	1.00	1.00	1.00	1.00	1.00	1.00	1.00	1.00	1.00	1.00
MLF Adj:	1.00	1.00	1.00	1.00	1.00	1.00	1.00	1.00	1.00	1.00	1.00	1.00
FinalVolume:	73	397	74	127	2600	82	101	255	186	118	244	122

Saturation Flow Module:

Sat/Lane:	1600	1600	1600	1600	1600	1600	1600	1600	1600	1600	1600	1600
Adjustment:	1.00	1.05	1.00	1.00	1.04	1.00	1.00	1.05	1.00	1.00	1.05	1.00
Lanes:	1.00	2.53	0.47	2.00	2.91	0.09	1.00	1.16	0.84	1.00	1.33	0.67
Final Sat.:	1600	4246	754	3200	4853	147	1600	1950	1350	1600	2233	1067

Capacity Analysis Module:

Vol/Sat:	0.05	0.09	0.10	0.04	0.54	0.56	0.06	0.13	0.14	0.07	0.11	0.11
Crit Moves:	****					****			****	****		

Santa Ana Circulation Element

Level Of Service Computation Report

ICU 1(Loss as Cycle Length %) Method (Base Volume Alternative)

Intersection #93 Tustin Ave and 17th St

Cycle (sec): 100 Critical Vol./Cap.(X): 0.748
 Loss Time (sec): 5 Average Delay (sec/veh): xxxxxx
 Optimal Cycle: 43 Level Of Service: C

Approach:	North Bound			South Bound			East Bound			West Bound		
Movement:	L	T	R	L	T	R	L	T	R	L	T	R
Control:	Protected			Protected			Protected			Protected		
Rights:	Ovl			Include			Include			Ovl		
Min. Green:	0	0	0	0	0	0	0	0	0	0	0	0
Y+R:	4.0	4.0	4.0	4.0	4.0	4.0	4.0	4.0	4.0	4.0	4.0	4.0
Lanes:	2	0	2	0	2	1	0	2	3	0	2	1

Volume Module:

Base Vol:	111	198	236	602	1737	19	187	738	126	488	770	188
Growth Adj:	1.00	1.00	1.00	1.00	1.00	1.00	1.00	1.00	1.00	1.00	1.00	1.00
Initial Bse:	111	198	236	602	1737	19	187	738	126	488	770	188
User Adj:	1.00	1.00	1.00	1.00	1.00	1.00	1.00	1.00	1.00	1.00	1.00	1.00
PHF Adj:	1.00	1.00	1.00	1.00	1.00	1.00	1.00	1.00	1.00	1.00	1.00	1.00
PHF Volume:	111	198	236	602	1737	19	187	738	126	488	770	188
Reduct Vol:	0	0	0	0	0	0	0	0	0	0	0	0
Reduced Vol:	111	198	236	602	1737	19	187	738	126	488	770	188
PCE Adj:	1.00	1.00	1.00	1.00	1.00	1.00	1.00	1.00	1.00	1.00	1.00	1.00
MLF Adj:	1.00	1.00	1.00	1.00	1.00	1.00	1.00	1.00	1.00	1.00	1.00	1.00
FinalVolume:	111	198	236	602	1737	19	187	738	126	488	770	188
OvlAdjVol:	0									0		

Saturation Flow Module:

Sat/Lane:	1600	1600	1600	1600	1600	1600	1600	1600	1600	1600	1600	1600
Adjustment:	1.00	1.06	1.00	1.00	1.04	1.00	1.00	1.06	1.00	1.00	1.06	1.00
Lanes:	2.00	2.00	1.00	2.00	2.97	0.03	2.00	3.00	1.00	2.00	3.00	1.00
Final Sat.:	3200	3400	1600	3200	4948	52	3200	5100	1600	3200	5100	1600

Capacity Analysis Module:

Vol/Sat:	0.03	0.06	0.15	0.19	0.35	0.37	0.06	0.14	0.08	0.15	0.15	0.12
OvlAdjV/S:	0.00									0.00		
Crit Moves:	****				****		****			****		

Santa Ana Circulation Element

Level Of Service Computation Report

ICU 1(Loss as Cycle Length %) Method (Base Volume Alternative)

Intersection #94 Tustin Ave and 4th St

Cycle (sec): 100 Critical Vol./Cap.(X): 0.701
 Loss Time (sec): 5 Average Delay (sec/veh): xxxxxx
 Optimal Cycle: 37 Level Of Service: C

Approach:	North Bound			South Bound			East Bound			West Bound		
Movement:	L	T	R	L	T	R	L	T	R	L	T	R
Control:	Protected			Protected			Protected			Protected		
Rights:	Include			Include			Include			Include		
Min. Green:	0	0	0	0	0	0	0	0	0	0	0	0
Y+R:	4.0	4.0	4.0	4.0	4.0	4.0	4.0	4.0	4.0	4.0	4.0	4.0
Lanes:	1	0	2	1	0	2	1	0	2	1	0	2

Volume Module:	North Bound			South Bound			East Bound			West Bound		
Base Vol:	48	245	219	664	845	262	114	676	28	103	579	376
Growth Adj:	1.00	1.00	1.00	1.00	1.00	1.00	1.00	1.00	1.00	1.00	1.00	1.00
Initial Bse:	48	245	219	664	845	262	114	676	28	103	579	376
User Adj:	1.00	1.00	1.00	1.00	1.00	1.00	1.00	1.00	1.00	1.00	1.00	1.00
PHF Adj:	1.00	1.00	1.00	1.00	1.00	1.00	1.00	1.00	1.00	1.00	1.00	1.00
PHF Volume:	48	245	219	664	845	262	114	676	28	103	579	376
Reduct Vol:	0	0	0	0	0	0	0	0	0	0	0	0
Reduced Vol:	48	245	219	664	845	262	114	676	28	103	579	376
PCE Adj:	1.00	1.00	1.00	1.00	1.00	1.00	1.00	1.00	1.00	1.00	1.00	1.00
MLF Adj:	1.00	1.00	1.00	1.00	1.00	1.00	1.00	1.00	1.00	1.00	1.00	1.00
FinalVolume:	48	245	219	664	845	262	114	676	28	103	579	376

Saturation Flow Module:	North Bound			South Bound			East Bound			West Bound		
Sat/Lane:	1600	1600	1600	1600	1600	1600	1600	1600	1600	1600	1600	1600
Adjustment:	1.00	1.06	1.00	1.00	1.06	1.00	1.00	1.04	1.00	1.00	1.06	1.00
Lanes:	1.00	2.00	1.00	2.00	2.00	1.00	1.00	2.88	0.12	1.00	2.00	1.00
Final Sat.:	1600	3400	1600	3200	3400	1600	1600	4809	191	1600	3400	1600

Capacity Analysis Module:	North Bound			South Bound			East Bound			West Bound		
Vol/Sat:	0.03	0.07	0.14	0.21	0.25	0.16	0.07	0.14	0.15	0.06	0.17	0.24
Crit Moves:			****	****			****					****

Santa Ana Circulation Element

Level Of Service Computation Report
 2000 HCM Operations Method (Base Volume Alternative)

 Intersection #95 SR-55 SB Ramps / Auto Mall Dr and Edinger Ave

Cycle (sec): 100 Critical Vol./Cap.(X): 0.558
 Loss Time (sec): 5 Average Delay (sec/veh): 24.4
 Optimal Cycle: 28 Level Of Service: C

Approach:	North Bound			South Bound			East Bound			West Bound		
Movement:	L	T	R	L	T	R	L	T	R	L	T	R
Control:	Split Phase			Split Phase			Protected			Protected		
Rights:	Include			Include			Ignore			Include		
Min. Green:	0	0	0	0	0	0	0	0	0	0	0	0
Y+R:	4.0	4.0	4.0	4.0	4.0	4.0	4.0	4.0	4.0	4.0	4.0	4.0
Lanes:	1	1	0	0	2	1	1	0	1	0	3	0

Volume Module:

Base Vol:	421	63	498	50	30	8	28	1104	408	399	940	123
Growth Adj:	1.00	1.00	1.00	1.00	1.00	1.00	1.00	1.00	1.00	1.00	1.00	1.00
Initial Bse:	421	63	498	50	30	8	28	1104	408	399	940	123
User Adj:	1.00	1.00	1.00	1.00	1.00	1.00	1.00	1.00	0.00	1.00	1.00	1.00
PHF Adj:	1.00	1.00	1.00	1.00	1.00	1.00	1.00	1.00	0.00	1.00	1.00	1.00
PHF Volume:	421	63	498	50	30	8	28	1104	0	399	940	123
Reduct Vol:	0	0	0	0	0	0	0	0	0	0	0	0
Reduced Vol:	421	63	498	50	30	8	28	1104	0	399	940	123
PCE Adj:	1.00	1.00	1.00	1.00	1.00	1.00	1.00	1.00	0.00	1.00	1.00	1.00
MLF Adj:	1.00	1.00	1.00	1.00	1.00	1.00	1.00	1.00	0.00	1.00	1.00	1.00
FinalVolume:	421	63	498	50	30	8	28	1104	0	399	940	123

Saturation Flow Module:

Sat/Lane:	1900	1900	1900	1900	1900	1900	1900	1900	1900	1900	1900	1900
Adjustment:	0.96	0.96	0.75	0.95	1.00	0.85	0.95	0.91	1.00	0.92	0.89	0.89
Lanes:	1.74	0.26	2.00	1.00	1.00	1.00	1.00	3.00	1.00	2.00	2.65	0.35
Final Sat.:	3167	474	2842	1805	1900	1615	1805	5187	1900	3502	4509	590

Capacity Analysis Module:

Vol/Sat:	0.13	0.13	0.18	0.03	0.02	0.00	0.02	0.21	0.00	0.11	0.21	0.21
Crit Moves:	****			****			****			****		
Green/Cycle:	0.31	0.31	0.31	0.05	0.05	0.05	0.04	0.38	0.00	0.20	0.55	0.55
Volume/Cap:	0.42	0.42	0.56	0.56	0.32	0.10	0.38	0.56	0.00	0.56	0.38	0.38
Delay/Veh:	27.4	27.4	29.3	54.0	47.8	45.9	50.1	24.6	0.0	36.7	13.1	13.1
User DelAdj:	1.00	1.00	1.00	1.00	1.00	1.00	1.00	1.00	1.00	1.00	1.00	1.00
AdjDel/Veh:	27.4	27.4	29.3	54.0	47.8	45.9	50.1	24.6	0.0	36.7	13.1	13.1
LOS by Move:	C	C	C	D	D	D	D	C	A	D	B	B
HCM2k85thQ:	9	9	12	4	2	1	2	15	0	10	11	11

Note: Queue reported is the number of cars per lane.

Santa Ana Circulation Element

Level Of Service Computation Report

2000 HCM Operations Method (Base Volume Alternative)

 Intersection #96 SR-55 NB Ramps / Del Amo Ave and Newport Avenue

Cycle (sec): 100 Critical Vol./Cap.(X): 0.463
 Loss Time (sec): 5 Average Delay (sec/veh): 24.0
 Optimal Cycle: 23 Level Of Service: C

Approach:	North Bound			South Bound			East Bound			West Bound		
Movement:	L	T	R	L	T	R	L	T	R	L	T	R
Control:	Protected			Protected			Protected			Protected		
Rights:	Include			Ovl			Include			Include		
Min. Green:	0	0	0	0	0	0	0	0	0	0	0	0
Y+R:	4.0	4.0	4.0	4.0	4.0	4.0	4.0	4.0	4.0	4.0	4.0	4.0
Lanes:	2	0	2	1	0	3	0	1	1	0	1	1

Volume Module:	North Bound			South Bound			East Bound			West Bound		
Base Vol:	227	60	38	14	344	504	253	153	146	8	223	4
Growth Adj:	1.00	1.00	1.00	1.00	1.00	1.00	1.00	1.00	1.00	1.00	1.00	1.00
Initial Bse:	227	60	38	14	344	504	253	153	146	8	223	4
User Adj:	1.00	1.00	1.00	1.00	1.00	1.00	1.00	1.00	1.00	1.00	1.00	1.00
PHF Adj:	1.00	1.00	1.00	1.00	1.00	1.00	1.00	1.00	1.00	1.00	1.00	1.00
PHF Volume:	227	60	38	14	344	504	253	153	146	8	223	4
Reduct Vol:	0	0	0	0	0	0	0	0	0	0	0	0
Reduced Vol:	227	60	38	14	344	504	253	153	146	8	223	4
PCE Adj:	1.00	1.00	1.00	1.00	1.00	1.00	1.00	1.00	1.00	1.00	1.00	1.00
MLF Adj:	1.00	1.00	1.00	1.00	1.00	1.00	1.00	1.00	1.00	1.00	1.00	1.00
FinalVolume:	227	60	38	14	344	504	253	153	146	8	223	4

Saturation Flow Module:	North Bound			South Bound			East Bound			West Bound		
Sat/Lane:	1900	1900	1900	1900	1900	1900	1900	1900	1900	1900	1900	1900
Adjustment:	0.92	0.86	0.86	0.95	0.91	0.85	0.92	0.88	0.88	0.95	0.95	0.95
Lanes:	2.00	2.00	1.00	1.00	3.00	1.00	2.00	1.02	0.98	1.00	1.96	0.04
Final Sat.:	3502	3257	1629	1805	5187	1615	3502	1712	1634	1805	3536	63

Capacity Analysis Module:	North Bound			South Bound			East Bound			West Bound		
Vol/Sat:	0.06	0.02	0.02	0.01	0.07	0.31	0.07	0.09	0.09	0.00	0.06	0.06
Crit Moves:	****					****	****			****		
Green/Cycle:	0.14	0.49	0.49	0.16	0.52	0.67	0.16	0.28	0.28	0.01	0.14	0.14
Volume/Cap:	0.46	0.04	0.05	0.05	0.13	0.46	0.46	0.32	0.32	0.32	0.46	0.46
Delay/Veh:	40.2	13.1	13.1	35.3	12.5	8.0	39.0	28.8	28.8	56.2	40.5	40.5
User DelAdj:	1.00	1.00	1.00	1.00	1.00	1.00	1.00	1.00	1.00	1.00	1.00	1.00
AdjDel/Veh:	40.2	13.1	13.1	35.3	12.5	8.0	39.0	28.8	28.8	56.2	40.5	40.5
LOS by Move:	D	B	B	D	B	A	D	C	C	E	D	D
HCM2k85thQ:	6	1	1	1	3	11	6	6	6	1	6	6

Note: Queue reported is the number of cars per lane.

Santa Ana Circulation Element

Level Of Service Computation Report

ICU 1(Loss as Cycle Length %) Method (Base Volume Alternative)

 Intersection #97 Red Hill Ave and Edinger Ave

Cycle (sec): 100 Critical Vol./Cap.(X): 0.569
 Loss Time (sec): 5 Average Delay (sec/veh): xxxxxx
 Optimal Cycle: 27 Level Of Service: A

Approach:	North Bound			South Bound			East Bound			West Bound		
Movement:	L	T	R	L	T	R	L	T	R	L	T	R
Control:	Protected			Protected			Protected			Protected		
Rights:	Include			Ovl			Ovl			Include		
Min. Green:	0	0	0	0	0	0	0	0	0	0	0	0
Y+R:	4.0	4.0	4.0	4.0	4.0	4.0	4.0	4.0	4.0	4.0	4.0	4.0
Lanes:	2	0	3	0	1		2	0	3	0	1	

Volume Module:

Base Vol:	81	299	85	226	960	450	190	611	130	224	1085	152	
Growth Adj:	1.00	1.00	1.00	1.00	1.00	1.00	1.00	1.00	1.00	1.00	1.00	1.00	
Initial Bse:	81	299	85	226	960	450	190	611	130	224	1085	152	
User Adj:	1.00	1.00	1.00	1.00	1.00	1.00	1.00	1.00	1.00	1.00	1.00	1.00	
PHF Adj:	1.00	1.00	1.00	1.00	1.00	1.00	1.00	1.00	1.00	1.00	1.00	1.00	
PHF Volume:	81	299	85	226	960	450	190	611	130	224	1085	152	
Reduct Vol:	0	0	0	0	0	0	0	0	0	0	0	0	
Reduced Vol:	81	299	85	226	960	450	190	611	130	224	1085	152	
PCE Adj:	1.00	1.00	1.00	1.00	1.00	1.00	1.00	1.00	1.00	1.00	1.00	1.00	
MLF Adj:	1.00	1.00	1.00	1.00	1.00	1.00	1.00	1.00	1.00	1.00	1.00	1.00	
FinalVolume:	81	299	85	226	960	450	190	611	130	224	1085	152	
OvlAdjVol:							355				89		

Saturation Flow Module:

Sat/Lane:	1600	1600	1600	1600	1600	1600	1600	1600	1600	1600	1600	1600
Adjustment:	1.00	1.06	1.00	1.00	1.06	1.00	1.00	1.06	1.00	1.00	1.06	1.00
Lanes:	2.00	3.00	1.00	2.00	3.00	1.00	2.00	3.00	1.00	2.00	3.00	1.00
Final Sat.:	3200	5100	1600	3200	5100	1600	3200	5100	1600	3200	5100	1600

Capacity Analysis Module:

Vol/Sat:	0.03	0.06	0.05	0.07	0.19	0.28	0.06	0.12	0.08	0.07	0.21	0.10	
OvlAdjV/S:							0.22				0.06		
Crit Moves:	****			****			****			****			

Santa Ana Circulation Element

Level Of Service Computation Report

ICU 1(Loss as Cycle Length %) Method (Base Volume Alternative)

Intersection #98 Red Hill Ave and Warner Ave

Cycle (sec): 100 Critical Vol./Cap.(X): 0.485
 Loss Time (sec): 5 Average Delay (sec/veh): xxxxxxx
 Optimal Cycle: 23 Level Of Service: A

Approach:	North Bound			South Bound			East Bound			West Bound		
Movement:	L	T	R	L	T	R	L	T	R	L	T	R
Control:	Protected			Protected			Protected			Protected		
Rights:	Include			Include			Include			Ovl		
Min. Green:	0	0	0	0	0	0	0	0	0	0	0	0
Y+R:	4.0	4.0	4.0	4.0	4.0	4.0	4.0	4.0	4.0	4.0	4.0	4.0
Lanes:	2	0	3	1	0	0	2	0	2	1	0	3

Volume Module:

Base Vol:	56	339	46	19	891	179	202	343	253	98	349	62
Growth Adj:	1.00	1.00	1.00	1.00	1.00	1.00	1.00	1.00	1.00	1.00	1.00	1.00
Initial Bse:	56	339	46	19	891	179	202	343	253	98	349	62
User Adj:	1.00	1.00	1.00	1.00	1.00	1.00	1.00	1.00	1.00	1.00	1.00	1.00
PHF Adj:	1.00	1.00	1.00	1.00	1.00	1.00	1.00	1.00	1.00	1.00	1.00	1.00
PHF Volume:	56	339	46	19	891	179	202	343	253	98	349	62
Reduct Vol:	0	0	0	0	0	0	0	0	0	0	0	0
Reduced Vol:	56	339	46	19	891	179	202	343	253	98	349	62
PCE Adj:	1.00	1.00	1.00	1.00	1.00	1.00	1.00	1.00	1.00	1.00	1.00	1.00
MLF Adj:	1.00	1.00	1.00	1.00	1.00	1.00	1.00	1.00	1.00	1.00	1.00	1.00
FinalVolume:	56	339	46	19	891	179	202	343	253	98	349	62
OvlAdjVol:												53

Saturation Flow Module:

Sat/Lane:	1600	1600	1600	1600	1600	1600	1600	1600	1600	1600	1600	1600
Adjustment:	1.00	1.05	1.00	1.00	1.05	1.00	1.00	1.06	1.00	1.00	1.06	1.00
Lanes:	2.00	3.52	0.48	2.00	2.50	0.50	1.00	2.00	1.00	2.00	3.00	1.00
Final Sat.:	3200	5935	765	3200	4197	803	1600	3400	1600	3200	5100	1600

Capacity Analysis Module:

Vol/Sat:	0.02	0.06	0.06	0.01	0.21	0.22	0.13	0.10	0.16	0.03	0.07	0.04
OvlAdjV/S:												0.03
Crit Moves:	****			****			****			****		

 Santa Ana Circulation Element

Level Of Service Computation Report

ICU 1(Loss as Cycle Length %) Method (Base Volume Alternative)

Intersection #99 Red Hill Ave and Dyer Rd / barranca Pkwy

Cycle (sec): 100 Critical Vol./Cap.(X): 0.575
 Loss Time (sec): 5 Average Delay (sec/veh): xxxxxxx
 Optimal Cycle: 27 Level Of Service: A

Approach:	North Bound			South Bound			East Bound			West Bound		
Movement:	L	T	R	L	T	R	L	T	R	L	T	R
Control:	Protected			Protected			Protected			Protected		
Rights:	Include			Include			Include			Include		
Min. Green:	0	0	0	0	0	0	0	0	0	0	0	0
Y+R:	4.0	4.0	4.0	4.0	4.0	4.0	4.0	4.0	4.0	4.0	4.0	4.0
Lanes:	2	0	4	0	1		2	0	4	0	1	

Volume Module:

Base Vol:	127	316	104	199	876	115	118	710	281	578	645	126
Growth Adj:	1.00	1.00	1.00	1.00	1.00	1.00	1.00	1.00	1.00	1.00	1.00	1.00
Initial Bse:	127	316	104	199	876	115	118	710	281	578	645	126
User Adj:	1.00	1.00	1.00	1.00	1.00	1.00	1.00	1.00	1.00	1.00	1.00	1.00
PHF Adj:	1.00	1.00	1.00	1.00	1.00	1.00	1.00	1.00	1.00	1.00	1.00	1.00
PHF Volume:	127	316	104	199	876	115	118	710	281	578	645	126
Reduct Vol:	0	0	0	0	0	0	0	0	0	0	0	0
Reduced Vol:	127	316	104	199	876	115	118	710	281	578	645	126
PCE Adj:	1.00	1.00	1.00	1.00	1.00	1.00	1.00	1.00	1.00	1.00	1.00	1.00
MLF Adj:	1.00	1.00	1.00	1.00	1.00	1.00	1.00	1.00	1.00	1.00	1.00	1.00
FinalVolume:	127	316	104	199	876	115	118	710	281	578	645	126

Saturation Flow Module:

Sat/Lane:	1600	1600	1600	1600	1600	1600	1600	1600	1600	1600	1600	1600
Adjustment:	1.00	1.06	1.00	1.00	1.06	1.00	1.00	1.06	1.00	1.00	1.06	1.00
Lanes:	2.00	4.00	1.00	2.00	4.00	1.00	2.00	3.00	1.00	2.00	4.00	1.00
Final Sat.:	3200	6800	1600	3200	6800	1600	3200	5100	1600	3200	6800	1600

Capacity Analysis Module:

Vol/Sat:	0.04	0.05	0.07	0.06	0.13	0.07	0.04	0.14	0.18	0.18	0.09	0.08
Crit Moves:	****			****			****		****	****		

Santa Ana Circulation Element

Level Of Service Computation Report

ICU 1(Loss as Cycle Length %) Method (Base Volume Alternative)

Intersection #100 Red Hill Ave and Alton Pkwy

Cycle (sec): 100 Critical Vol./Cap.(X): 0.524
 Loss Time (sec): 5 Average Delay (sec/veh): xxxxxx
 Optimal Cycle: 25 Level Of Service: A

Approach:	North Bound			South Bound			East Bound			West Bound		
Movement:	L	T	R	L	T	R	L	T	R	L	T	R
Control:	Protected			Protected			Protected			Protected		
Rights:	Include			Include			Include			Include		
Min. Green:	0	0	0	0	0	0	0	0	0	0	0	0
Y+R:	4.0	4.0	4.0	4.0	4.0	4.0	4.0	4.0	4.0	4.0	4.0	4.0
Lanes:	1	0	3	0	1	1	1	0	2	0	1	0

Volume Module:	North Bound			South Bound			East Bound			West Bound		
Base Vol:	174	512	321	251	1141	183	9	28	28	223	189	106
Growth Adj:	1.00	1.00	1.00	1.00	1.00	1.00	1.00	1.00	1.00	1.00	1.00	1.00
Initial Bse:	174	512	321	251	1141	183	9	28	28	223	189	106
User Adj:	1.00	1.00	1.00	1.00	1.00	1.00	1.00	1.00	1.00	1.00	1.00	1.00
PHF Adj:	1.00	1.00	1.00	1.00	1.00	1.00	1.00	1.00	1.00	1.00	1.00	1.00
PHF Volume:	174	512	321	251	1141	183	9	28	28	223	189	106
Reduct Vol:	0	0	0	0	0	0	0	0	0	0	0	0
Reduced Vol:	174	512	321	251	1141	183	9	28	28	223	189	106
PCE Adj:	1.00	1.00	1.00	1.00	1.00	1.00	1.00	1.00	1.00	1.00	1.00	1.00
MLF Adj:	1.00	1.00	1.00	1.00	1.00	1.00	1.00	1.00	1.00	1.00	1.00	1.00
FinalVolume:	174	512	321	251	1141	183	9	28	28	223	189	106

Saturation Flow Module:	North Bound			South Bound			East Bound			West Bound		
Sat/Lane:	1600	1600	1600	1600	1600	1600	1600	1600	1600	1600	1600	1600
Adjustment:	1.00	1.06	1.00	1.00	1.06	1.00	1.00	1.06	1.00	1.00	1.06	1.00
Lanes:	1.00	3.00	1.00	1.00	3.00	1.00	1.00	2.00	1.00	2.00	1.00	1.00
Final Sat.:	1600	5100	1600	1600	5100	1600	1600	3400	1600	3200	1700	1600

Capacity Analysis Module:	North Bound			South Bound			East Bound			West Bound		
Vol/Sat:	0.11	0.10	0.20	0.16	0.22	0.11	0.01	0.01	0.02	0.07	0.11	0.07
Crit Moves:	****			****			****			****		

Santa Ana Circulation Element

Level Of Service Computation Report

ICU 1(Loss as Cycle Length %) Method (Base Volume Alternative)

Intersection #101 Red Hill Ave and MacArthur Blvd

Cycle (sec): 100 Critical Vol./Cap.(X): 0.664
 Loss Time (sec): 5 Average Delay (sec/veh): xxxxxx
 Optimal Cycle: 34 Level Of Service: B

Approach:	North Bound			South Bound			East Bound			West Bound		
Movement:	L	T	R	L	T	R	L	T	R	L	T	R
Control:	Protected			Protected			Protected			Protected		
Rights:	Include			Ignore			Include			Ignore		
Min. Green:	0	0	0	0	0	0	0	0	0	0	0	0
Y+R:	4.0	4.0	4.0	4.0	4.0	4.0	4.0	4.0	4.0	4.0	4.0	4.0
Lanes:	2	0	2	1	0	0	2	0	3	0	1	0

Volume Module:	North Bound			South Bound			East Bound			West Bound		
Base Vol:	64	569	10	208	537	492	1248	645	106	23	223	571
Growth Adj:	1.00	1.00	1.00	1.00	1.00	1.00	1.00	1.00	1.00	1.00	1.00	1.00
Initial Bse:	64	569	10	208	537	492	1248	645	106	23	223	571
User Adj:	1.00	1.00	1.00	1.00	1.00	0.00	1.00	1.00	1.00	1.00	1.00	0.00
PHF Adj:	1.00	1.00	1.00	1.00	1.00	0.00	1.00	1.00	1.00	1.00	1.00	0.00
PHF Volume:	64	569	10	208	537	0	1248	645	106	23	223	0
Reduct Vol:	0	0	0	0	0	0	0	0	0	0	0	0
Reduced Vol:	64	569	10	208	537	0	1248	645	106	23	223	0
PCE Adj:	1.00	1.00	1.00	1.00	1.00	0.00	1.00	1.00	1.00	1.00	1.00	0.00
MLF Adj:	1.00	1.00	1.00	1.00	1.00	0.00	1.00	1.00	1.00	1.00	1.00	0.00
FinalVolume:	64	569	10	208	537	0	1248	645	106	23	223	0

Saturation Flow Module:	North Bound			South Bound			East Bound			West Bound		
Sat/Lane:	1600	1600	1600	1600	1600	1600	1600	1600	1600	1600	1600	1600
Adjustment:	1.00	1.04	1.00	1.00	1.06	1.00	1.00	1.06	1.00	1.00	1.06	1.00
Lanes:	2.00	2.95	0.05	2.00	3.00	1.00	2.00	3.00	1.00	1.00	3.00	1.00
Final Sat.:	3200	4917	83	3200	5100	1600	3200	5100	1600	1600	5100	1600

Capacity Analysis Module:	North Bound			South Bound			East Bound			West Bound		
Vol/Sat:	0.02	0.12	0.12	0.07	0.11	0.00	0.39	0.13	0.07	0.01	0.04	0.00
Crit Moves:	****			****			****			****		

Santa Ana Circulation Element

Level Of Service Computation Report

ICU 1(Loss as Cycle Length %) Method (Base Volume Alternative)

Intersection #102 Red Hill Ave and Main St

Cycle (sec): 100 Critical Vol./Cap.(X): 0.670
 Loss Time (sec): 5 Average Delay (sec/veh): xxxxxx
 Optimal Cycle: 34 Level Of Service: B

Approach:	North Bound			South Bound			East Bound			West Bound		
Movement:	L	T	R	L	T	R	L	T	R	L	T	R
Control:	Protected			Protected			Protected			Protected		
Rights:	Include			Include			Include			Include		
Min. Green:	0	0	0	0	0	0	0	0	0	0	0	0
Y+R:	4.0	4.0	4.0	4.0	4.0	4.0	4.0	4.0	4.0	4.0	4.0	4.0
Lanes:	2	0	2	0	2	0	1	2	0	2	1	0

Volume Module:

Base Vol:	162	556	361	67	313	108	139	1309	254	154	309	73
Growth Adj:	1.00	1.00	1.00	1.00	1.00	1.00	1.00	1.00	1.00	1.00	1.00	1.00
Initial Bse:	162	556	361	67	313	108	139	1309	254	154	309	73
User Adj:	1.00	1.00	1.00	1.00	1.00	1.00	1.00	1.00	1.00	1.00	1.00	1.00
PHF Adj:	1.00	1.00	1.00	1.00	1.00	1.00	1.00	1.00	1.00	1.00	1.00	1.00
PHF Volume:	162	556	361	67	313	108	139	1309	254	154	309	73
Reduct Vol:	0	0	0	0	0	0	0	0	0	0	0	0
Reduced Vol:	162	556	361	67	313	108	139	1309	254	154	309	73
PCE Adj:	1.00	1.00	1.00	1.00	1.00	1.00	1.00	1.00	1.00	1.00	1.00	1.00
MLF Adj:	1.00	1.00	1.00	1.00	1.00	1.00	1.00	1.00	1.00	1.00	1.00	1.00
FinalVolume:	162	556	361	67	313	108	139	1309	254	154	309	73

Saturation Flow Module:

Sat/Lane:	1600	1600	1600	1600	1600	1600	1600	1600	1600	1600	1600	1600
Adjustment:	1.00	1.06	1.00	1.00	1.06	1.00	1.00	1.05	1.00	1.00	1.05	1.00
Lanes:	2.00	2.00	1.00	2.00	2.00	1.00	2.00	2.51	0.49	2.00	2.43	0.57
Final Sat.:	3200	3400	1600	3200	3400	1600	3200	4220	780	3200	4083	917

Capacity Analysis Module:

Vol/Sat:	0.05	0.16	0.23	0.02	0.09	0.07	0.04	0.31	0.33	0.05	0.08	0.08
Crit Moves:			****	****					****	****		

Santa Ana Circulation Element

Level of Service Computation Report

2000 HCM Operations Method (Base Volume Alternative)

 Intersection #103 I-5 SB Ramps and Santa Ana Blvd

Cycle (sec): 100 Critical Vol./Cap.(X): 0.514
 Loss Time (sec): 5 Average Delay (sec/veh): 17.4
 Optimal Cycle: 25 Level Of Service: B

Approach:	North Bound			South Bound			East Bound			West Bound		
Movement:	L	T	R	L	T	R	L	T	R	L	T	R
Control:	Split Phase			Split Phase			Protected			Protected		
Rights:	Include			Ovl			Include			Include		
Min. Green:	0	0	0	0	0	0	0	0	0	0	0	0
Y+R:	4.0	4.0	4.0	4.0	4.0	4.0	4.0	4.0	4.0	4.0	4.0	4.0
Lanes:	0	0	0	2	0	0	2	0	3	0	0	2

Volume Module:

Base Vol:	0	0	0	367	0	36	323	554	0	0	1130	330
Growth Adj:	1.00	1.00	1.00	1.00	1.00	1.00	1.00	1.00	1.00	1.00	1.00	1.00
Initial Bse:	0	0	0	367	0	36	323	554	0	0	1130	330
User Adj:	1.00	1.00	1.00	1.00	1.00	1.00	1.00	1.00	1.00	1.00	1.00	1.00
PHF Adj:	1.00	1.00	1.00	1.00	1.00	1.00	1.00	1.00	1.00	1.00	1.00	1.00
PHF Volume:	0	0	0	367	0	36	323	554	0	0	1130	330
Reduct Vol:	0	0	0	0	0	0	0	0	0	0	0	0
Reduced Vol:	0	0	0	367	0	36	323	554	0	0	1130	330
PCE Adj:	1.00	1.00	1.00	1.00	1.00	1.00	1.00	1.00	1.00	1.00	1.00	1.00
MLF Adj:	1.00	1.00	1.00	1.00	1.00	1.00	1.00	1.00	1.00	1.00	1.00	1.00
FinalVolume:	0	0	0	367	0	36	323	554	0	0	1130	330

Saturation Flow Module:

Sat/Lane:	1900	1900	1900	1900	1900	1900	1900	1900	1900	1900	1900	1900
Adjustment:	1.00	1.00	1.00	0.92	1.00	0.85	0.92	0.91	1.00	1.00	0.88	0.88
Lanes:	0.00	0.00	0.00	2.00	0.00	1.00	2.00	3.00	0.00	0.00	2.32	0.68
Final Sat.:	0	0	0	3502	0	1615	3502	5187	0	0	3878	1133

Capacity Analysis Module:

Vol/Sat:	0.00	0.00	0.00	0.10	0.00	0.02	0.09	0.11	0.00	0.00	0.29	0.29
Crit Moves:				****			****			****		
Green/Cycle:	0.00	0.00	0.00	0.20	0.00	0.38	0.18	0.75	0.00	0.00	0.57	0.57
Volume/Cap:	0.00	0.00	0.00	0.51	0.00	0.06	0.51	0.14	0.00	0.00	0.51	0.51
Delay/Veh:	0.0	0.0	0.0	36.0	0.0	19.5	37.8	3.6	0.0	0.0	13.4	13.4
User DelAdj:	1.00	1.00	1.00	1.00	1.00	1.00	1.00	1.00	1.00	1.00	1.00	1.00

AdjDel/Veh:	0.0	0.0	0.0	36.0	0.0	19.5	37.8	3.6	0.0	0.0	13.4	13.4
LOS by Move:	A	A	A	D	A	B	D	A	A	A	B	B
HCM2k85thQ:	0	0	0	9	0	1	8	3	0	0	15	15

Note: Queue reported is the number of cars per lane.

Santa Ana Circulation Element

Level Of Service Computation Report

ICU 1(Loss as Cycle Length %) Method (Base Volume Alternative)

 Intersection #104 Tustin Ranch Rd and Warner Ave

Cycle (sec): 100 Critical Vol./Cap.(X): 0.475
 Loss Time (sec): 5 Average Delay (sec/veh): xxxxxx
 Optimal Cycle: 23 Level Of Service: A

Approach:	North Bound			South Bound			East Bound			West Bound		
Movement:	L	T	R	L	T	R	L	T	R	L	T	R
Control:	Split Phase			Split Phase			Protected			Protected		
Rights:	Ovl			Include			Include			Ovl		
Min. Green:	0	0	0	0	0	0	0	0	0	0	0	0
Y+R:	4.0	4.0	4.0	4.0	4.0	4.0	4.0	4.0	4.0	4.0	4.0	4.0
Lanes:	0	0	0	2	0	0	2	0	3	0	0	3

Volume Module:

Base Vol:	0	0	0	265	0	33	18	238	0	0	1717	395
Growth Adj:	1.00	1.00	1.00	1.00	1.00	1.00	1.00	1.00	1.00	1.00	1.00	1.00
Initial Bse:	0	0	0	265	0	33	18	238	0	0	1717	395
User Adj:	1.00	1.00	1.00	1.00	1.00	1.00	1.00	1.00	1.00	1.00	1.00	1.00
PHF Adj:	1.00	1.00	1.00	1.00	1.00	1.00	1.00	1.00	1.00	1.00	1.00	1.00
PHF Volume:	0	0	0	265	0	33	18	238	0	0	1717	395
Reduct Vol:	0	0	0	0	0	0	0	0	0	0	0	0
Reduced Vol:	0	0	0	265	0	33	18	238	0	0	1717	395
PCE Adj:	1.00	1.00	1.00	1.00	1.00	1.00	1.00	1.00	1.00	1.00	1.00	1.00
MLF Adj:	1.00	1.00	1.00	1.00	1.00	1.00	1.00	1.00	1.00	1.00	1.00	1.00
FinalVolume:	0	0	0	265	0	33	18	238	0	0	1717	395
OvlAdjVol:												263

Saturation Flow Module:

Sat/Lane:	1600	1600	1600	1600	1600	1600	1600	1600	1600	1600	1600	1600
Adjustment:	1.00	1.06	1.00	1.00	1.06	1.00	1.00	1.06	1.00	1.00	1.06	1.00
Lanes:	0.00	0.00	0.00	2.00	0.00	1.00	2.00	3.00	0.00	0.00	3.00	1.00
Final Sat.:	0	0	0	3200	0	1600	3200	5100	0	0	5100	1600

Capacity Analysis Module:

Vol/Sat:	0.00	0.00	0.00	0.08	0.00	0.02	0.01	0.05	0.00	0.00	0.34	0.25
OvlAdjV/S:												0.16
Crit Moves:				****				****				****

Santa Ana Circulation Element

Level Of Service Computation Report

ICU 1(Loss as Cycle Length %) Method (Base Volume Alternative)

Intersection #105 Von Karman Ave and Barranca Pkwy

Cycle (sec): 100 Critical Vol./Cap.(X): 0.762
 Loss Time (sec): 5 Average Delay (sec/veh): xxxxxxx
 Optimal Cycle: 45 Level Of Service: C

Approach:	North Bound			South Bound			East Bound			West Bound		
Movement:	L	T	R	L	T	R	L	T	R	L	T	R
Control:	Protected			Protected			Protected			Protected		
Rights:	Include			Ovl			Include			Include		
Min. Green:	0	0	0	0	0	0	0	0	0	0	0	0
Y+R:	4.0	4.0	4.0	4.0	4.0	4.0	4.0	4.0	4.0	4.0	4.0	4.0
Lanes:	2	0	1	1	0	0	2	0	3	0	1	2

Volume Module:

Base Vol:	107	142	85	119	1164	509	130	488	163	769	1263	39
Growth Adj:	1.00	1.00	1.00	1.00	1.00	1.00	1.00	1.00	1.00	1.00	1.00	1.00
Initial Bse:	107	142	85	119	1164	509	130	488	163	769	1263	39
User Adj:	1.00	1.00	1.00	1.00	1.00	1.00	1.00	1.00	1.00	1.00	1.00	1.00
PHF Adj:	1.00	1.00	1.00	1.00	1.00	1.00	1.00	1.00	1.00	1.00	1.00	1.00
PHF Volume:	107	142	85	119	1164	509	130	488	163	769	1263	39
Reduct Vol:	0	0	0	0	0	0	0	0	0	0	0	0
Reduced Vol:	107	142	85	119	1164	509	130	488	163	769	1263	39
PCE Adj:	1.00	1.00	1.00	1.00	1.00	1.00	1.00	1.00	1.00	1.00	1.00	1.00
MLF Adj:	1.00	1.00	1.00	1.00	1.00	1.00	1.00	1.00	1.00	1.00	1.00	1.00
FinalVolume:	107	142	85	119	1164	509	130	488	163	769	1263	39
OvlAdjVol:	379											

Saturation Flow Module:

Sat/Lane:	1600	1600	1600	1600	1600	1600	1600	1600	1600	1600	1600	1600
Adjustment:	1.00	1.05	1.00	1.00	1.06	1.00	1.00	1.06	1.00	1.00	1.06	1.00
Lanes:	2.00	1.25	0.75	2.00	2.00	2.00	2.00	3.00	1.00	2.00	4.00	1.00
Final Sat.:	3200	2102	1198	3200	3400	3200	3200	5100	1600	3200	6800	1600

Capacity Analysis Module:

Vol/Sat:	0.03	0.07	0.07	0.04	0.34	0.16	0.04	0.10	0.10	0.24	0.19	0.02	
OvlAdjV/S:	0.12												
Crit Moves:	****	****					****	****					

Santa Ana Circulation Element

Level Of Service Computation Report

ICU 1(Loss as Cycle Length %) Method (Base Volume Alternative)

Intersection #106 Red Hill Avenue and El Camino Real

Cycle (sec): 100 Critical Vol./Cap.(X): 0.706
 Loss Time (sec): 5 Average Delay (sec/veh): xxxxxx
 Optimal Cycle: 38 Level Of Service: C

Street Name:	Red Hill Avenue						El Camino Real					
Approach:	North Bound			South Bound			East Bound			West Bound		
Movement:	L	T	R	L	T	R	L	T	R	L	T	R
Control:	Protected			Protected			Protected			Protected		
Rights:	Include			Include			Include			Include		
Min. Green:	0	0	0	0	0	0	0	0	0	0	0	0
Y+R:	4.0	4.0	4.0	4.0	4.0	4.0	4.0	4.0	4.0	4.0	4.0	4.0
Lanes:	2	0	3	0	1	1	0	2	1	0	1	0

Volume Module:	Red Hill Avenue			South Bound			El Camino Real			West Bound		
Base Vol:	306	785	253	18	1303	80	69	156	164	271	222	16
Growth Adj:	1.00	1.00	1.00	1.00	1.00	1.00	1.00	1.00	1.00	1.00	1.00	1.00
Initial Bse:	306	785	253	18	1303	80	69	156	164	271	222	16
User Adj:	1.00	1.00	1.00	1.00	1.00	1.00	1.00	1.00	1.00	1.00	1.00	1.00
PHF Adj:	1.00	1.00	1.00	1.00	1.00	1.00	1.00	1.00	1.00	1.00	1.00	1.00
PHF Volume:	306	785	253	18	1303	80	69	156	164	271	222	16
Reduct Vol:	0	0	0	0	0	0	0	0	0	0	0	0
Reduced Vol:	306	785	253	18	1303	80	69	156	164	271	222	16
PCE Adj:	1.00	1.00	1.00	1.00	1.00	1.00	1.00	1.00	1.00	1.00	1.00	1.00
MLF Adj:	1.00	1.00	1.00	1.00	1.00	1.00	1.00	1.00	1.00	1.00	1.00	1.00
FinalVolume:	306	785	253	18	1303	80	69	156	164	271	222	16

Saturation Flow Module:	Red Hill Avenue			South Bound			El Camino Real			West Bound		
Sat/Lane:	1600	1600	1600	1600	1600	1600	1600	1600	1600	1600	1600	1600
Adjustment:	1.00	1.06	1.00	1.00	1.04	1.00	1.00	1.06	1.00	1.00	1.00	1.00
Lanes:	2.00	3.00	1.00	1.00	2.83	0.17	1.00	1.00	1.00	1.00	0.93	0.07
Final Sat.:	3200	5100	1600	1600	4722	278	1600	1700	1600	1600	1492	108

Capacity Analysis Module:	Red Hill Avenue			South Bound			El Camino Real			West Bound		
Vol/Sat:	0.10	0.15	0.16	0.01	0.28	0.29	0.04	0.09	0.10	0.17	0.15	0.15
Crit Moves:	****					****			****	****		

Santa Ana Circulation Element

Level Of Service Computation Report
 2000 HCM Operations Method (Base Volume Alternative)

 Intersection #107 Red Hill Avenue and I-5 NB Ramps

Cycle (sec): 100 Critical Vol./Cap.(X): 0.670
 Loss Time (sec): 5 Average Delay (sec/veh): 20.3
 Optimal Cycle: 36 Level Of Service: C

Street Name:	Red Hill Avenue						I-5 NB Ramps					
Approach:	North Bound			South Bound			East Bound			West Bound		
Movement:	L	T	R	L	T	R	L	T	R	L	T	R
Control:	Protected			Protected			Permitted			Permitted		
Rights:	Include			Include			Include			Include		
Min. Green:	0	0	0	0	0	0	0	0	0	0	0	0
Y+R:	4.0	4.0	4.0	4.0	4.0	4.0	4.0	4.0	4.0	4.0	4.0	4.0
Lanes:	1	0	3	0	0	3	0	0	0	2	0	0

Volume Module:												
Base Vol:	327	1084	0	0	1263	475	0	0	0	228	0	261
Growth Adj:	1.00	1.00	1.00	1.00	1.00	1.00	1.00	1.00	1.00	1.00	1.00	1.00
Initial Bse:	327	1084	0	0	1263	475	0	0	0	228	0	261
User Adj:	1.00	1.00	1.00	1.00	1.00	1.00	1.00	1.00	1.00	1.00	1.00	1.00
PHF Adj:	1.00	1.00	1.00	1.00	1.00	1.00	1.00	1.00	1.00	1.00	1.00	1.00
PHF Volume:	327	1084	0	0	1263	475	0	0	0	228	0	261
Reduct Vol:	0	0	0	0	0	0	0	0	0	0	0	0
Reduced Vol:	327	1084	0	0	1263	475	0	0	0	228	0	261
PCE Adj:	1.00	1.00	1.00	1.00	1.00	1.00	1.00	1.00	1.00	1.00	1.00	1.00
MLF Adj:	1.00	1.00	1.00	1.00	1.00	1.00	1.00	1.00	1.00	1.00	1.00	1.00
FinalVolume:	327	1084	0	0	1263	475	0	0	0	228	0	261

Saturation Flow Module:												
Sat/Lane:	1900	1900	1900	1900	1900	1900	1900	1900	1900	1900	1900	1900
Adjustment:	0.95	0.91	1.00	1.00	0.91	0.85	1.00	1.00	1.00	0.60	1.00	0.85
Lanes:	1.00	3.00	0.00	0.00	3.00	1.00	0.00	0.00	0.00	2.00	0.00	1.00
Final Sat.:	1805	5187	0	0	5187	1615	0	0	0	2278	0	1615

Capacity Analysis Module:												
Vol/Sat:	0.18	0.21	0.00	0.00	0.24	0.29	0.00	0.00	0.00	0.10	0.00	0.16
Crit Moves:	****					****						****
Green/Cycle:	0.27	0.71	0.00	0.00	0.44	0.44	0.00	0.00	0.00	0.24	0.00	0.24
Volume/Cap:	0.67	0.29	0.00	0.00	0.56	0.67	0.00	0.00	0.00	0.42	0.00	0.67
Delay/Veh:	36.1	5.4	0.0	0.0	21.1	24.8	0.0	0.0	0.0	32.5	0.0	38.8
User DelAdj:	1.00	1.00	1.00	1.00	1.00	1.00	1.00	1.00	1.00	1.00	1.00	1.00

AdjDel/Veh:	36.1	5.4	0.0	0.0	21.1	24.8	0.0	0.0	0.0	32.5	0.0	38.8
LOS by Move:	D	A	A	A	C	C	A	A	A	C	A	D
HCM2k85thQ:	15	7	0	0	16	19	0	0	0	5	0	13

Note: Queue reported is the number of cars per lane.

Santa Ana Circulation Element

Level of Service Computation Report
 2000 HCM Operations Method (Base Volume Alternative)

 Intersection #108 Red Hill Avenue and I-5 SB Ramps

Cycle (sec): 100 Critical Vol./Cap.(X): 0.784
 Loss Time (sec): 5 Average Delay (sec/veh): 22.0
 Optimal Cycle: 51 Level Of Service: C

Street Name:	Red Hill Avenue						I-5 SB Ramps					
	North Bound			South Bound			East Bound			West Bound		
Approach:	North Bound			South Bound			East Bound			West Bound		
Movement:	L	T	R	L	T	R	L	T	R	L	T	R
Control:	Protected			Protected			Permitted			Permitted		
Rights:	Include			Include			Include			Include		
Min. Green:	0	0	0	0	0	0	0	0	0	0	0	0
Y+R:	4.0	4.0	4.0	4.0	4.0	4.0	4.0	4.0	4.0	4.0	4.0	4.0
Lanes:	0	0	4	0	1	0	1	0	0	0	0	0

Volume Module:												
Base Vol:	0	1243	550	385	1105	0	168	4	309	0	0	0
Growth Adj:	1.00	1.00	1.00	1.00	1.00	1.00	1.00	1.00	1.00	1.00	1.00	1.00
Initial Bse:	0	1243	550	385	1105	0	168	4	309	0	0	0
User Adj:	1.00	1.00	1.00	1.00	1.00	1.00	1.00	1.00	1.00	1.00	1.00	1.00
PHF Adj:	1.00	1.00	1.00	1.00	1.00	1.00	1.00	1.00	1.00	1.00	1.00	1.00
PHF Volume:	0	1243	550	385	1105	0	168	4	309	0	0	0
Reduct Vol:	0	0	0	0	0	0	0	0	0	0	0	0
Reduced Vol:	0	1243	550	385	1105	0	168	4	309	0	0	0
PCE Adj:	1.00	1.00	1.00	1.00	1.00	1.00	1.00	1.00	1.00	1.00	1.00	1.00
MLF Adj:	1.00	1.00	1.00	1.00	1.00	1.00	1.00	1.00	1.00	1.00	1.00	1.00
FinalVolume:	0	1243	550	385	1105	0	168	4	309	0	0	0

Saturation Flow Module:												
Sat/Lane:	1900	1900	1900	1900	1900	1900	1900	1900	1900	1900	1900	1900
Adjustment:	1.00	0.91	0.85	0.95	0.91	1.00	0.95	0.95	0.85	1.00	1.00	1.00
Lanes:	0.00	4.00	1.00	1.00	3.00	0.00	0.98	0.02	1.00	0.00	0.00	0.00
Final Sat.:	0	6916	1615	1805	5187	0	1759	42	1615	0	0	0

Capacity Analysis Module:												
Vol/Sat:	0.00	0.18	0.34	0.21	0.21	0.00	0.10	0.10	0.19	0.00	0.00	0.00
Crit Moves:	****			****			****			****		
Green/Cycle:	0.00	0.43	0.43	0.27	0.71	0.00	0.24	0.24	0.24	0.00	0.00	0.00
Volume/Cap:	0.00	0.41	0.78	0.78	0.30	0.00	0.39	0.39	0.78	0.00	0.00	0.00
Delay/Veh:	0.0	19.6	30.1	41.8	5.5	0.0	32.2	32.2	45.3	0.0	0.0	0.0
User DelAdj:	1.00	1.00	1.00	1.00	1.00	1.00	1.00	1.00	1.00	1.00	1.00	1.00
AdjDel/Veh:	0.0	19.6	30.1	41.8	5.5	0.0	32.2	32.2	45.3	0.0	0.0	0.0
LOS by Move:	A	B	C	D	A	A	C	C	D	A	A	A
HCM2k85thQ:	0	11	24	19	7	0	7	7	16	0	0	0

 Note: Queue reported is the number of cars per lane.

Santa Ana Circulation Element

Level of Service Computation Report

ICU 1(Loss as Cycle Length %) Method (Base Volume Alternative)

Intersection #109 Red Hill Avenue and Nisson Road

Cycle (sec): 100 Critical Vol./Cap.(X): 0.653
 Loss Time (sec): 5 Average Delay (sec/veh): xxxxxx
 Optimal Cycle: 33 Level Of Service: B

Street Name:	Red Hill Avenue						Nisson Road					
	North Bound			South Bound			East Bound			West Bound		
Approach:	North Bound			South Bound			East Bound			West Bound		
Movement:	L	T	R	L	T	R	L	T	R	L	T	R
Control:	Protected			Protected			Split Phase			Split Phase		
Rights:	Include			Include			Include			Include		
Min. Green:	0	0	0	0	0	0	0	0	0	0	0	0
Y+R:	4.0	4.0	4.0	4.0	4.0	4.0	4.0	4.0	4.0	4.0	4.0	4.0
Lanes:	1	0	3	1	0	2	1	0	0	1	0	1

Volume Module:

Base Vol:	17	1298	24	152	1144	120	242	59	48	49	26	215
Growth Adj:	1.00	1.00	1.00	1.00	1.00	1.00	1.00	1.00	1.00	1.00	1.00	1.00
Initial Bse:	17	1298	24	152	1144	120	242	59	48	49	26	215
User Adj:	1.00	1.00	1.00	1.00	1.00	1.00	1.00	1.00	1.00	1.00	1.00	1.00
PHF Adj:	1.00	1.00	1.00	1.00	1.00	1.00	1.00	1.00	1.00	1.00	1.00	1.00
PHF Volume:	17	1298	24	152	1144	120	242	59	48	49	26	215
Reduct Vol:	0	0	0	0	0	0	0	0	0	0	0	0
Reduced Vol:	17	1298	24	152	1144	120	242	59	48	49	26	215
PCE Adj:	1.00	1.00	1.00	1.00	1.00	1.00	1.00	1.00	1.00	1.00	1.00	1.00
MLF Adj:	1.00	1.00	1.00	1.00	1.00	1.00	1.00	1.00	1.00	1.00	1.00	1.00
FinalVolume:	17	1298	24	152	1144	120	242	59	48	49	26	215

Saturation Flow Module:

Sat/Lane:	1600	1600	1600	1600	1600	1600	1600	1600	1600	1600	1600	1600
Adjustment:	1.00	1.05	1.00	1.00	1.05	1.00	1.00	1.00	1.00	1.00	1.00	1.00
Lanes:	1.00	3.93	0.07	1.00	2.72	0.28	1.00	0.55	0.45	1.00	0.11	0.89
Final Sat.:	1600	6584	116	1600	4544	456	1600	882	718	1600	173	1427

Capacity Analysis Module:

Vol/Sat:	0.01	0.20	0.21	0.10	0.25	0.26	0.15	0.07	0.07	0.03	0.15	0.15
Crit Moves:	****			****			****			****		

Santa Ana Circulation Element

Level Of Service Computation Report

ICU 1(Loss as Cycle Length %) Method (Base Volume Alternative)

Intersection #110 Red Hill Avenue and Walnut Avenue

Cycle (sec): 100 Critical Vol./Cap.(X): 0.684
 Loss Time (sec): 5 Average Delay (sec/veh): xxxxxx
 Optimal Cycle: 35 Level Of Service: B

Street Name:	Red Hill Avenue						Walnut Avenue					
Approach:	North Bound			South Bound			East Bound			West Bound		
Movement:	L	T	R	L	T	R	L	T	R	L	T	R
Control:	Protected			Protected			Protected			Protected		
Rights:	Include			Include			Include			Include		
Min. Green:	0	0	0	0	0	0	0	0	0	0	0	0
Y+R:	4.0	4.0	4.0	4.0	4.0	4.0	4.0	4.0	4.0	4.0	4.0	4.0
Lanes:	1	0	2	1	0	2	1	0	1	1	0	1

Volume Module:												
Base Vol:	135	525	99	104	1046	117	160	398	392	192	254	121
Growth Adj:	1.00	1.00	1.00	1.00	1.00	1.00	1.00	1.00	1.00	1.00	1.00	1.00
Initial Bse:	135	525	99	104	1046	117	160	398	392	192	254	121
User Adj:	1.00	1.00	1.00	1.00	1.00	1.00	1.00	1.00	1.00	1.00	1.00	1.00
PHF Adj:	1.00	1.00	1.00	1.00	1.00	1.00	1.00	1.00	1.00	1.00	1.00	1.00
PHF Volume:	135	525	99	104	1046	117	160	398	392	192	254	121
Reduct Vol:	0	0	0	0	0	0	0	0	0	0	0	0
Reduced Vol:	135	525	99	104	1046	117	160	398	392	192	254	121
PCE Adj:	1.00	1.00	1.00	1.00	1.00	1.00	1.00	1.00	1.00	1.00	1.00	1.00
MLF Adj:	1.00	1.00	1.00	1.00	1.00	1.00	1.00	1.00	1.00	1.00	1.00	1.00
FinalVolume:	135	525	99	104	1046	117	160	398	392	192	254	121

Saturation Flow Module:												
Sat/Lane:	1600	1600	1600	1600	1600	1600	1600	1600	1600	1600	1600	1600
Adjustment:	1.00	1.05	1.00	1.00	1.05	1.00	1.00	1.06	1.00	1.00	1.05	1.00
Lanes:	1.00	2.52	0.48	1.00	2.70	0.30	1.00	1.01	0.99	2.00	1.35	0.65
Final Sat.:	1600	4238	762	1600	4517	483	1600	1712	1588	3200	2267	1033

Capacity Analysis Module:												
Vol/Sat:	0.08	0.12	0.13	0.07	0.23	0.24	0.10	0.23	0.25	0.06	0.11	0.12
Crit Moves:	****					****			****	****		

Santa Ana Circulation Element

Level Of Service Computation Report

ICU 1(Loss as Cycle Length %) Method (Base Volume Alternative)

Intersection #111 Red Hill Avenue and Valencia Avenue

Cycle (sec): 100 Critical Vol./Cap.(X): 0.544
 Loss Time (sec): 5 Average Delay (sec/veh): xxxxxx
 Optimal Cycle: 26 Level Of Service: A

Street Name:	Red Hill Avenue						Valencia Avenue					
Approach:	North Bound			South Bound			East Bound			West Bound		
Movement:	L	T	R	L	T	R	L	T	R	L	T	R
Control:	Protected			Protected			Protected			Protected		
Rights:	Ovl			Include			Include			Ovl		
Min. Green:	0	0	0	0	0	0	0	0	0	0	0	0
Y+R:	4.0	4.0	4.0	4.0	4.0	4.0	4.0	4.0	4.0	4.0	4.0	4.0
Lanes:	1	0	3	1	0	2	1	0	1	2	0	1

Volume Module:

Base Vol:	77	325	105	120	1032	69	20	139	54	252	346	122
Growth Adj:	1.00	1.00	1.00	1.00	1.00	1.00	1.00	1.00	1.00	1.00	1.00	1.00
Initial Bse:	77	325	105	120	1032	69	20	139	54	252	346	122
User Adj:	1.00	1.00	1.00	1.00	1.00	1.00	1.00	1.00	1.00	1.00	1.00	1.00
PHF Adj:	1.00	1.00	1.00	1.00	1.00	1.00	1.00	1.00	1.00	1.00	1.00	1.00
PHF Volume:	77	325	105	120	1032	69	20	139	54	252	346	122
Reduct Vol:	0	0	0	0	0	0	0	0	0	0	0	0
Reduced Vol:	77	325	105	120	1032	69	20	139	54	252	346	122
PCE Adj:	1.00	1.00	1.00	1.00	1.00	1.00	1.00	1.00	1.00	1.00	1.00	1.00
MLF Adj:	1.00	1.00	1.00	1.00	1.00	1.00	1.00	1.00	1.00	1.00	1.00	1.00
FinalVolume:	77	325	105	120	1032	69	20	139	54	252	346	122
OvlAdjVol:	0									2		

Saturation Flow Module:

Sat/Lane:	1600	1600	1600	1600	1600	1600	1600	1600	1600	1600	1600	1600
Adjustment:	1.00	1.06	1.00	1.00	1.04	1.00	1.00	1.06	1.00	1.00	1.06	1.00
Lanes:	1.00	3.02	0.98	1.00	2.81	0.19	1.00	1.00	1.00	2.00	1.00	1.00
Final Sat.:	1600	5137	1563	1600	4699	301	1600	1700	1600	3200	1700	1600

Capacity Analysis Module:

Vol/Sat:	0.05	0.06	0.07	0.08	0.22	0.23	0.01	0.08	0.03	0.08	0.20	0.08
OvlAdjV/S:	0.00									0.00		
Crit Moves:	****						****	****			****	

Santa Ana Circulation Element

Level Of Service Computation Report

ICU 1(Loss as Cycle Length %) Method (Base Volume Alternative)

Intersection #112 Tustin Ranch Road and Warner Avenue North

Cycle (sec): 100 Critical Vol./Cap.(X): 0.426
 Loss Time (sec): 5 Average Delay (sec/veh): xxxxxx
 Optimal Cycle: 21 Level Of Service: A

Street Name:	Tustin Ranch Road						Warner Avenue North					
Approach:	North Bound			South Bound			East Bound			West Bound		
Movement:	L	T	R	L	T	R	L	T	R	L	T	R
Control:	Protected			Protected			Split Phase			Split Phase		
Rights:	Ovl			Include			Include			Ovl		
Min. Green:	0	0	0	0	0	0	0	0	0	0	0	0
Y+R:	4.0	4.0	4.0	4.0	4.0	4.0	4.0	4.0	4.0	4.0	4.0	4.0
Lanes:	0	0	3	0	1		2	0	3	0	0	

Volume Module:

Base Vol:	0	272	263	456	1289	0	0	0	0	591	0	174
Growth Adj:	1.00	1.00	1.00	1.00	1.00	1.00	1.00	1.00	1.00	1.00	1.00	1.00
Initial Bse:	0	272	263	456	1289	0	0	0	0	591	0	174
User Adj:	1.00	1.00	1.00	1.00	1.00	1.00	1.00	1.00	1.00	1.00	1.00	1.00
PHF Adj:	1.00	1.00	1.00	1.00	1.00	1.00	1.00	1.00	1.00	1.00	1.00	1.00
PHF Volume:	0	272	263	456	1289	0	0	0	0	591	0	174
Reduct Vol:	0	0	0	0	0	0	0	0	0	0	0	0
Reduced Vol:	0	272	263	456	1289	0	0	0	0	591	0	174
PCE Adj:	1.00	1.00	1.00	1.00	1.00	1.00	1.00	1.00	1.00	1.00	1.00	1.00
MLF Adj:	1.00	1.00	1.00	1.00	1.00	1.00	1.00	1.00	1.00	1.00	1.00	1.00
FinalVolume:	0	272	263	456	1289	0	0	0	0	591	0	174
OvlAdjVol:			66									0

Saturation Flow Module:

Sat/Lane:	1600	1600	1600	1600	1600	1600	1600	1600	1600	1600	1600	1600
Adjustment:	1.00	1.06	1.00	1.00	1.06	1.00	1.00	1.06	1.00	1.00	1.06	1.00
Lanes:	0.00	3.00	1.00	2.00	3.00	0.00	0.00	0.00	0.00	3.00	0.00	2.00
Final Sat.:	0	5100	1600	3200	5100	0	0	0	0	4800	0	3200

Capacity Analysis Module:

Vol/Sat:	0.00	0.05	0.16	0.14	0.25	0.00	0.00	0.00	0.00	0.12	0.00	0.05
OvlAdjV/S:			0.04									0.00
Crit Moves:	****				****					****		

Santa Ana Circulation Element

Level of Service Computation Report

ICU 1(Loss as Cycle Length %) Method (Base Volume Alternative)

Intersection #113 Tustin Ranch Road and Walnut Avenue

Cycle (sec): 100 Critical Vol./Cap.(X): 1.193
 Loss Time (sec): 5 Average Delay (sec/veh): xxxxxx
 Optimal Cycle: 180 Level Of Service: F

Street Name:	Tustin Ranch Road						Walnut Avenue					
Approach:	North Bound			South Bound			East Bound			West Bound		
Movement:	L	T	R	L	T	R	L	T	R	L	T	R
Control:	Protected			Protected			Protected			Protected		
Rights:	Ovl			Ovl			Include			Ovl		
Min. Green:	0	0	0	0	0	0	0	0	0	0	0	0
Y+R:	4.0	4.0	4.0	4.0	4.0	4.0	4.0	4.0	4.0	4.0	4.0	4.0
Lanes:	2	0	3	0	1		2	0	3	0	1	

Volume Module:

Base Vol:	123	756	377	1045	2921	389	702	917	554	231	341	288
Growth Adj:	1.00	1.00	1.00	1.00	1.00	1.00	1.00	1.00	1.00	1.00	1.00	1.00
Initial Bse:	123	756	377	1045	2921	389	702	917	554	231	341	288
User Adj:	1.00	1.00	1.00	1.00	1.00	1.00	1.00	1.00	1.00	1.00	1.00	1.00
PHF Adj:	1.00	1.00	1.00	1.00	1.00	1.00	1.00	1.00	1.00	1.00	1.00	1.00
PHF Volume:	123	756	377	1045	2921	389	702	917	554	231	341	288
Reduct Vol:	0	0	0	0	0	0	0	0	0	0	0	0
Reduced Vol:	123	756	377	1045	2921	389	702	917	554	231	341	288
PCE Adj:	1.00	1.00	1.00	1.00	1.00	1.00	1.00	1.00	1.00	1.00	1.00	1.00
MLF Adj:	1.00	1.00	1.00	1.00	1.00	1.00	1.00	1.00	1.00	1.00	1.00	1.00
FinalVolume:	123	756	377	1045	2921	389	702	917	554	231	341	288
OvlAdjVol:	262			38						0		

Saturation Flow Module:

Sat/Lane:	1600	1600	1600	1600	1600	1600	1600	1600	1600	1600	1600	1600
Adjustment:	1.00	1.06	1.00	1.00	1.06	1.00	1.00	1.05	1.00	1.00	1.06	1.00
Lanes:	2.00	3.00	1.00	2.00	3.00	1.00	2.00	1.25	0.75	2.00	2.00	1.00
Final Sat.:	3200	5100	1600	3200	5100	1600	3200	2095	1205	3200	3400	1600

Capacity Analysis Module:

Vol/Sat:	0.04	0.15	0.24	0.33	0.57	0.24	0.22	0.44	0.46	0.07	0.10	0.18
OvlAdjV/S:	0.16			0.02						0.00		
Crit Moves:	****			****			****			****		

Santa Ana Circulation Element

Level Of Service Computation Report

2000 HCM Operations Method (Base Volume Alternative)

 Intersection #114 SR-55 SB Ramps and Irvine Boulevard

Cycle (sec): 100 Critical Vol./Cap.(X): 0.970
 Loss Time (sec): 5 Average Delay (sec/veh): 23.2
 Optimal Cycle: 165 Level Of Service: C

Street Name:	SR-55 SB Ramps						Irvine Boulevard					
	North Bound			South Bound			East Bound			West Bound		
Approach:												
Movement:	L	T	R	L	T	R	L	T	R	L	T	R
Control:	Protected			Permitted			Protected			Protected		
Rights:	Include			Include			Include			Include		
Min. Green:	0	0	0	0	0	0	0	0	0	0	0	0
Y+R:	4.0	4.0	4.0	4.0	4.0	4.0	4.0	4.0	4.0	4.0	4.0	4.0
Lanes:	0	0	0	1	0	1	0	0	2	1	0	3

Volume Module:												
Base Vol:	0	0	0	62	0	68	0	575	1032	425	1063	0
Growth Adj:	1.00	1.00	1.00	1.00	1.00	1.00	1.00	1.00	1.00	1.00	1.00	1.00
Initial Bse:	0	0	0	62	0	68	0	575	1032	425	1063	0
User Adj:	1.00	1.00	1.00	1.00	1.00	1.00	1.00	1.00	1.00	1.00	1.00	1.00
PHF Adj:	1.00	1.00	1.00	1.00	1.00	1.00	1.00	1.00	1.00	1.00	1.00	1.00
PHF Volume:	0	0	0	62	0	68	0	575	1032	425	1063	0
Reduct Vol:	0	0	0	0	0	0	0	0	0	0	0	0
Reduced Vol:	0	0	0	62	0	68	0	575	1032	425	1063	0
PCE Adj:	1.00	1.00	1.00	1.00	1.00	1.00	1.00	1.00	1.00	1.00	1.00	1.00
MLF Adj:	1.00	1.00	1.00	1.00	1.00	1.00	1.00	1.00	1.00	1.00	1.00	1.00
FinalVolume:	0	0	0	62	0	68	0	575	1032	425	1063	0

Saturation Flow Module:												
Sat/Lane:	1900	1900	1900	1900	1900	1900	1900	1900	1900	1900	1900	1900
Adjustment:	1.00	1.00	1.00	0.88	1.00	0.77	1.00	0.82	0.82	0.95	0.91	1.00
Lanes:	0.00	0.00	0.00	1.44	0.00	1.56	0.00	2.00	1.00	1.00	3.00	0.00
Final Sat.:	0	0	0	2415	0	2277	0	3126	1563	1805	5187	0

Capacity Analysis Module:												
Vol/Sat:	0.00	0.00	0.00	0.03	0.00	0.03	0.00	0.18	0.66	0.24	0.20	0.00
Crit Moves:				****				****			****	
Green/Cycle:	0.00	0.00	0.00	0.03	0.00	0.05	0.00	0.68	0.68	0.24	0.92	0.00
Volume/Cap:	0.00	0.00	0.00	0.86	0.00	0.58	0.00	0.27	0.97	0.97	0.22	0.00
Delay/Veh:	0.0	0.0	0.0	84.9	0.0	50.0	0.0	6.3	30.4	72.4	0.4	0.0
User DelAdj:	1.00	1.00	1.00	1.00	1.00	1.00	1.00	1.00	1.00	1.00	1.00	1.00
AdjDel/Veh:	0.0	0.0	0.0	84.9	0.0	50.0	0.0	6.3	30.4	72.4	0.4	0.0
LOS by Move:	A	A	A	F	A	D	A	A	C	E	A	A

```
HCM2k85thQ:    0    0    0    5    0    4    0    6    54    27    2    0
*****
Note: Queue reported is the number of cars per lane.
*****
```

Santa Ana Circulation Element

Level of Service Computation Report
 2000 HCM Operations Method (Base Volume Alternative)

 Intersection #115 SR-55 NB Ramps and Irvine Boulevard

Cycle (sec): 100 Critical Vol./Cap.(X): 0.797
 Loss Time (sec): 5 Average Delay (sec/veh): 19.8
 Optimal Cycle: 54 Level Of Service: B

Street Name:	SR-55 NB Ramps						Irvine Boulevard					
	North Bound			South Bound			East Bound			West Bound		
Approach:												
Movement:	L	T	R	L	T	R	L	T	R	L	T	R
Control:	Permitted			Protected			Protected			Protected		
Rights:	Include			Include			Include			Include		
Min. Green:	0	0	0	0	0	0	0	0	0	0	0	0
Y+R:	4.0	4.0	4.0	4.0	4.0	4.0	4.0	4.0	4.0	4.0	4.0	4.0
Lanes:	1	0	1	0	0	0	1	0	3	0	0	2

Volume Module:

Base Vol:	410	0	394	0	0	0	187	444	0	0	1079	750
Growth Adj:	1.00	1.00	1.00	1.00	1.00	1.00	1.00	1.00	1.00	1.00	1.00	1.00
Initial Bse:	410	0	394	0	0	0	187	444	0	0	1079	750
User Adj:	1.00	1.00	1.00	1.00	1.00	1.00	1.00	1.00	1.00	1.00	1.00	1.00
PHF Adj:	1.00	1.00	1.00	1.00	1.00	1.00	1.00	1.00	1.00	1.00	1.00	1.00
PHF Volume:	410	0	394	0	0	0	187	444	0	0	1079	750
Reduct Vol:	0	0	0	0	0	0	0	0	0	0	0	0
Reduced Vol:	410	0	394	0	0	0	187	444	0	0	1079	750
PCE Adj:	1.00	1.00	1.00	1.00	1.00	1.00	1.00	1.00	1.00	1.00	1.00	1.00
MLF Adj:	1.00	1.00	1.00	1.00	1.00	1.00	1.00	1.00	1.00	1.00	1.00	1.00
FinalVolume:	410	0	394	0	0	0	187	444	0	0	1079	750

Saturation Flow Module:

Sat/Lane:	1900	1900	1900	1900	1900	1900	1900	1900	1900	1900	1900	1900
Adjustment:	0.75	1.00	0.74	1.00	1.00	1.00	0.95	0.91	1.00	1.00	0.85	0.85
Lanes:	1.51	0.00	1.49	0.00	0.00	0.00	1.00	3.00	0.00	0.00	2.00	1.00
Final Sat.:	2135	0	2095	0	0	0	1805	5187	0	0	3247	1624

Capacity Analysis Module:

Vol/Sat:	0.19	0.00	0.19	0.00	0.00	0.00	0.10	0.09	0.00	0.00	0.33	0.46
Crit Moves:	****						****			****		
Green/Cycle:	0.24	0.00	0.48	0.00	0.00	0.00	0.13	0.71	0.00	0.00	0.58	0.58
Volume/Cap:	0.80	0.00	0.39	0.00	0.00	0.00	0.80	0.12	0.00	0.00	0.57	0.80
Delay/Veh:	40.3	0.0	16.7	0.0	0.0	0.0	59.3	4.6	0.0	0.0	13.5	18.5
User DelAdj:	1.00	1.00	1.00	1.00	1.00	1.00	1.00	1.00	1.00	1.00	1.00	1.00
AdjDel/Veh:	40.3	0.0	16.7	0.0	0.0	0.0	59.3	4.6	0.0	0.0	13.5	18.5
LOS by Move:	D	A	B	A	A	A	E	A	A	A	B	B
HCM2k85thQ:	15	0	8	0	0	0	12	2	0	0	18	31

Note: Queue reported is the number of cars per lane.

Traffix 8.0.0715 (c) 2008 Dowling Assoc. Licensed to IBI GROUP, IRVINE, CA

APPENDIX D.2
ANALYSIS WORKSHEETS –
2020 NP (PM Peak Hour)

Santa Ana Circulation Element

Scenario Report

Scenario: 2020 NP PM Peak Hour
Command: Default Command
Volume: 2020 NP PM
Geometry: NP
Impact Fee: Default Impact Fee
Trip Generation: Default Trip Generation
Trip Distribution: Default Trip Distribution
Paths: Default Path
Routes: Default Route
Configuration: Default Configuration

 Santa Ana Circulation Element

 Impact Analysis Report
 Level Of Service

Intersection	Base		Future		Change in
	Del/	V/	Del/	V/	
	LOS	Veh C	LOS	Veh C	
# 1 Euclid St and 1st St	D	xxxxxx 0.865	D	xxxxxx 0.865	+ 0.000 V/C
# 2 Euclid St and McFadden Ave	D	xxxxxx 0.833	D	xxxxxx 0.833	+ 0.000 V/C
# 3 Euclid St and Edinger Ave	C	xxxxxx 0.787	C	xxxxxx 0.787	+ 0.000 V/C
# 4 Newhope St and Hazard Ave	B	xxxxxx 0.642	B	xxxxxx 0.642	+ 0.000 V/C
# 5 Newhope St and McFadden Ave	D	xxxxxx 0.838	D	xxxxxx 0.838	+ 0.000 V/C
# 6 Harbor Blvd and SR-22 WB Off-R	C	23.6 0.703	C	23.6 0.703	+ 0.000 D/V
# 7 Trask Avenue and SR-22 EB On-R	B	12.4 0.448	B	12.4 0.448	+ 0.000 D/V
# 8 Harbor Blvd and Westminster Av	C	xxxxxx 0.792	C	xxxxxx 0.792	+ 0.000 V/C
# 9 Harbor Blvd and 1st St	D	xxxxxx 0.833	D	xxxxxx 0.833	+ 0.000 V/C
# 10 Harbor Blvd and McFadden Ave	D	xxxxxx 0.809	D	xxxxxx 0.809	+ 0.000 V/C
# 11 Harbor Blvd and Edinger Ave	B	xxxxxx 0.697	B	xxxxxx 0.697	+ 0.000 V/C
# 12 Harbor Blvd and Warner Ave	F	xxxxxx 1.581	F	xxxxxx 1.581	+ 0.000 V/C
# 13 Harbor Blvd and Segerstrom Ave	D	xxxxxx 0.897	D	xxxxxx 0.897	+ 0.000 V/C
# 14 MacArthur Blvd and Hyland Ave	E	xxxxxx 0.917	E	xxxxxx 0.917	+ 0.000 V/C
# 15 MacArthur Blvd and Harbor Blvd	D	xxxxxx 0.819	D	xxxxxx 0.819	+ 0.000 V/C
# 16 Harbor Blvd and Sunflower Ave	C	xxxxxx 0.780	C	xxxxxx 0.780	+ 0.000 V/C
# 17 Harbor Blvd and I-405 WB Off-R	C	22.9 0.812	C	22.9 0.812	+ 0.000 D/V
# 18 Harbor Blvd and I-405 EB Off-R	B	16.2 0.630	B	16.2 0.630	+ 0.000 D/V
# 19 Fairview St and Civic Center D	B	xxxxxx 0.662	B	xxxxxx 0.662	+ 0.000 V/C
# 20 Fairview St and 1st St	D	xxxxxx 0.883	D	xxxxxx 0.883	+ 0.000 V/C
# 21 Fairview St and McFadden Ave	C	xxxxxx 0.798	C	xxxxxx 0.798	+ 0.000 V/C
# 22 Fairview St and Edinger Ave	D	xxxxxx 0.811	D	xxxxxx 0.811	+ 0.000 V/C
# 23 Fairview St and Warner Ave	D	xxxxxx 0.845	D	xxxxxx 0.845	+ 0.000 V/C
# 24 Fairview St and MacArthur Blvd	D	xxxxxx 0.826	D	xxxxxx 0.826	+ 0.000 V/C

 Santa Ana Circulation Element

Intersection	Base		Future		Change in
	Del/ LOS	V/ Veh	Del/ LOS	V/ Veh	
# 25 Fairview Rd and Sunflower Ave	C	xxxxxx 0.708	C	xxxxxx 0.708	+ 0.000 V/C
# 26 Greenville St and Edinger Ave	A	xxxxxx 0.586	A	xxxxxx 0.586	+ 0.000 V/C
# 27 Greenville St and Segerstrom A	B	xxxxxx 0.686	B	xxxxxx 0.686	+ 0.000 V/C
# 28 Raitt St and McFadden Ave	C	xxxxxx 0.722	C	xxxxxx 0.722	+ 0.000 V/C
# 29 Raitt St and Edinger Ave	D	xxxxxx 0.864	D	xxxxxx 0.864	+ 0.000 V/C
# 30 Bear St and MacArthur Blvd	D	xxxxxx 0.868	D	xxxxxx 0.868	+ 0.000 V/C
# 31 Bristol St and 17th St	B	xxxxxx 0.692	B	xxxxxx 0.692	+ 0.000 V/C
# 32 Bristol St and Civic Center Dr	D	xxxxxx 0.832	D	xxxxxx 0.832	+ 0.000 V/C
# 33 Bristol St and Santa Ana Blvd	B	xxxxxx 0.657	B	xxxxxx 0.657	+ 0.000 V/C
# 34 Bristol St and 1st St	C	xxxxxx 0.779	C	xxxxxx 0.779	+ 0.000 V/C
# 35 Bristol St and McFadden Ave	C	xxxxxx 0.752	C	xxxxxx 0.752	+ 0.000 V/C
# 36 Bristol St and Warner Ave	C	xxxxxx 0.790	C	xxxxxx 0.790	+ 0.000 V/C
# 37 Bristol St and Segerstrom Ave	E	xxxxxx 0.909	E	xxxxxx 0.909	+ 0.000 V/C
# 38 Bristol St and Alton Ave	B	xxxxxx 0.686	B	xxxxxx 0.686	+ 0.000 V/C
# 39 Bristol St and MacArthur Blvd	D	xxxxxx 0.812	D	xxxxxx 0.812	+ 0.000 V/C
# 40 Bristol St and Sunflower Ave	B	xxxxxx 0.689	B	xxxxxx 0.689	+ 0.000 V/C
# 41 Bristol St and I-405 WB Ramps	C	28.2 0.829	C	28.2 0.829	+ 0.000 D/V
# 42 Bristol St and I-405 EB Ramps	B	18.4 0.595	B	18.4 0.595	+ 0.000 D/V
# 43 Flower St and Santa Ana Blvd	A	xxxxxx 0.571	A	xxxxxx 0.571	+ 0.000 V/C
# 44 Flower St and 1st St	C	xxxxxx 0.752	C	xxxxxx 0.752	+ 0.000 V/C
# 45 Flower St and McFadden Ave	E	xxxxxx 0.920	E	xxxxxx 0.920	+ 0.000 V/C
# 46 Flower St and Segerstrom Ave	D	xxxxxx 0.897	D	xxxxxx 0.897	+ 0.000 V/C
# 47 Flower St and MacArthur Blvd	E	xxxxxx 0.906	E	xxxxxx 0.906	+ 0.000 V/C
# 48 Main St and La Veta Ave	B	xxxxxx 0.628	B	xxxxxx 0.628	+ 0.000 V/C
# 49 Main St and Mainplace Dr / Mem	A	xxxxxx 0.471	A	xxxxxx 0.471	+ 0.000 V/C
# 50 Main St and 17th St	C	xxxxxx 0.732	C	xxxxxx 0.732	+ 0.000 V/C

Traffix 8.0.0715 (c) 2008 Dowling Assoc. Licensed to IBI GROUP, IRVINE, CA

 Santa Ana Circulation Element

Intersection	Base		Future		Change in	
	Del/ LOS	V/ Veh C	Del/ LOS	V/ Veh C		
# 51 Main St and Civic Center Dr	D xxxxxx	0.801	D xxxxxx	0.801	+ 0.000	V/C
# 52 Main St and Santa Ana Blvd	B xxxxxx	0.607	B xxxxxx	0.607	+ 0.000	V/C
# 53 Main St and 4th St	A xxxxxx	0.537	A xxxxxx	0.537	+ 0.000	V/C
# 54 Main St and 1st St	C xxxxxx	0.799	C xxxxxx	0.799	+ 0.000	V/C
# 55 Main St and McFadden Ave	D xxxxxx	0.845	D xxxxxx	0.845	+ 0.000	V/C
# 56 Main St and Edinger Ave	D xxxxxx	0.847	D xxxxxx	0.847	+ 0.000	V/C
# 57 Main St and MacArthur Blvd	C xxxxxx	0.777	C xxxxxx	0.777	+ 0.000	V/C
# 58 Penn Wy and 17th St	C 20.7	0.770	C 20.7	0.770	+ 0.000	D/V
# 59 I-5 NB Off Ramps/17th Street	B 19.5	0.589	B 19.5	0.589	+ 0.000	D/V
# 60 Penn Wy and I-5 SB Ramps	C 22.0	0.423	C 22.0	0.423	+ 0.000	D/V
# 61 Santiago St and Civic Center D	C 17.1	0.674	C 17.1	0.674	+ 0.000	V/C
# 62 Santiago St and Santa Ana Blvd	A xxxxxx	0.569	A xxxxxx	0.569	+ 0.000	V/C
# 64 Standard Ave and 1st St	D xxxxxx	0.842	D xxxxxx	0.842	+ 0.000	V/C
# 65 Standard Ave and Mcfadden Ave	B xxxxxx	0.682	B xxxxxx	0.682	+ 0.000	V/C
# 66 Halladay St and Warner Ave	B xxxxxx	0.677	B xxxxxx	0.677	+ 0.000	V/C
# 67 Halladay St and Dyer Rd	C xxxxxx	0.784	C xxxxxx	0.784	+ 0.000	V/C
# 68 SR-55 SB Ramps and MacArthur B	B 17.3	0.569	B 17.3	0.569	+ 0.000	D/V
# 69 SR-55 NB Ramps and MacArthur B	B 14.8	0.497	B 14.8	0.497	+ 0.000	D/V
# 70 SR-55 SB Ramps and Dyer Rd	C 25.7	0.669	C 25.7	0.669	+ 0.000	D/V
# 71 Glassell St and La Veta Ave	B xxxxxx	0.620	B xxxxxx	0.620	+ 0.000	V/C
# 72 Glassell St and SR-22 WB Ramps	C 24.8	0.766	C 24.8	0.766	+ 0.000	D/V
# 73 Grand Ave / Glassell St and SR	C 26.5	0.812	C 26.5	0.812	+ 0.000	D/V
# 74 Grand Ave and Fairhaven Ave	B xxxxxx	0.675	B xxxxxx	0.675	+ 0.000	V/C
# 75 Grand Ave and Santa Clara Ave	C xxxxxx	0.748	C xxxxxx	0.748	+ 0.000	V/C
# 76 Grand Ave and 17th St	D xxxxxx	0.828	D xxxxxx	0.828	+ 0.000	V/C

 Santa Ana Circulation Element

Intersection	Base		Future		Change in	
	Del/ LOS	V/ Veh C	Del/ LOS	V/ Veh C		
# 77 Grand Ave and I-5 NB Ramps	A	10.0 0.518	A	10.0 0.518	+ 0.000	D/V
# 78 Grand Ave and Santa Ana Blvd	C	21.1 0.605	C	21.1 0.605	+ 0.000	D/V
# 79 Grand Ave and 1st St	C	xxxxxx 0.793	C	xxxxxx 0.793	+ 0.000	V/C
# 80 Grand Ave and Chestnut Ave	B	xxxxxx 0.615	B	xxxxxx 0.615	+ 0.000	V/C
# 81 Grand Ave and McFadden Ave	C	xxxxxx 0.759	C	xxxxxx 0.759	+ 0.000	V/C
# 82 Grand Ave and Edinger Ave	E	xxxxxx 0.909	E	xxxxxx 0.909	+ 0.000	V/C
# 83 Grand Ave and Warner Ave	C	xxxxxx 0.704	C	xxxxxx 0.704	+ 0.000	V/C
# 84 SR-55 NB Ramps and Dyer Rd	A	5.7 0.376	A	5.7 0.376	+ 0.000	D/V
# 85 Cambridge St and La Veta Ave	B	12.5 0.459	B	12.5 0.459	+ 0.000	V/C
# 86 Cambridge St and Fairhaven Ave	A	xxxxxx 0.488	A	xxxxxx 0.488	+ 0.000	V/C
# 87 Mabury St and 1st Street	C	26.1 0.703	C	26.1 0.703	+ 0.000	D/V
# 88 Tustin St and La Veta Ave	A	xxxxxx 0.444	A	xxxxxx 0.444	+ 0.000	V/C
# 89 Tustin St and SR-22 WB On-Ramp	B	12.1 0.446	B	12.1 0.446	+ 0.000	D/V
# 90 Tustin St and SR-22 EB Off-Ram	C	23.7 0.719	C	23.7 0.719	+ 0.000	D/V
# 91 Tustin Ave and Fairhaven Ave	B	xxxxxx 0.614	B	xxxxxx 0.614	+ 0.000	V/C
# 92 Tustin Ave and Santa Clara Ave	B	xxxxxx 0.647	B	xxxxxx 0.647	+ 0.000	V/C
# 93 Tustin Ave and 17th St	C	xxxxxx 0.717	C	xxxxxx 0.717	+ 0.000	V/C
# 94 Tustin Ave and 4th St	B	xxxxxx 0.692	B	xxxxxx 0.692	+ 0.000	V/C
# 95 SR-55 SB Ramps / Auto Mall Dr	C	25.1 0.583	C	25.1 0.583	+ 0.000	D/V
# 96 SR-55 NB Ramps / Del Amo Ave a	C	27.4 0.525	C	27.4 0.525	+ 0.000	D/V
# 97 Red Hill Ave and Edinger Ave	B	xxxxxx 0.667	B	xxxxxx 0.667	+ 0.000	V/C
# 98 Red Hill Ave and Warner Ave	A	xxxxxx 0.588	A	xxxxxx 0.588	+ 0.000	V/C
# 99 Red Hill Ave and Dyer Rd / bar	A	xxxxxx 0.563	A	xxxxxx 0.563	+ 0.000	V/C
#100 Red Hill Ave and Alton Pkwy	B	xxxxxx 0.671	B	xxxxxx 0.671	+ 0.000	V/C
#101 Red Hill Ave and MacArthur Blv	B	xxxxxx 0.657	B	xxxxxx 0.657	+ 0.000	V/C
#102 Red Hill Ave and Main St	C	xxxxxx 0.774	C	xxxxxx 0.774	+ 0.000	V/C

Traffix 8.0.0715 (c) 2008 Dowling Assoc. Licensed to IBI GROUP, IRVINE, CA

 Santa Ana Circulation Element

Intersection		Base		Future		Change in	
		Del/ LOS	V/ Veh C	Del/ LOS	V/ Veh C		
#103 I-5 SB Ramps and Santa Ana Blv	B	18.9	0.431	B 18.9	0.431	+ 0.000	D/V
#104 Tustin Ranch Rd and Warner Ave	B	xxxxx	0.606	B xxxxx	0.606	+ 0.000	V/C
#105 Von Karman Ave and Barranca Pk	D	xxxxx	0.874	D xxxxx	0.874	+ 0.000	V/C
#106 Red Hill Avenue and El Camino	B	xxxxx	0.624	B xxxxx	0.624	+ 0.000	V/C
#107 Red Hill Avenue and I-5 NB Ram	C	23.3	0.626	C 23.3	0.626	+ 0.000	D/V
#108 Red Hill Avenue and I-5 SB Ram	C	22.8	0.708	C 22.8	0.708	+ 0.000	D/V
#109 Red Hill Avenue and Nisson Roa	C	xxxxx	0.702	C xxxxx	0.702	+ 0.000	V/C
#110 Red Hill Avenue and Walnut Ave	C	xxxxx	0.785	C xxxxx	0.785	+ 0.000	V/C
#111 Red Hill Avenue and Valencia A	A	xxxxx	0.549	A xxxxx	0.549	+ 0.000	V/C
#112 Tustin Ranch Road and Warner A	C	xxxxx	0.757	C xxxxx	0.757	+ 0.000	V/C
#113 Tustin Ranch Road and Walnut A	F	xxxxx	1.630	F xxxxx	1.630	+ 0.000	V/C
#114 SR-55 SB Ramps and Irvine Boul	C	21.5	0.794	C 21.5	0.794	+ 0.000	D/V
#115 SR-55 NB Ramps and Irvine Boul	B	19.5	0.809	B 19.5	0.809	+ 0.000	D/V

Santa Ana Circulation Element

Level Of Service Computation Report

ICU 1(Loss as Cycle Length %) Method (Base Volume Alternative)

Intersection #1 Euclid St and 1st St

Cycle (sec): 100 Critical Vol./Cap.(X): 0.865
 Loss Time (sec): 5 Average Delay (sec/veh): xxxxxx
 Optimal Cycle: 70 Level Of Service: D

Approach:	North Bound			South Bound			East Bound			West Bound		
Movement:	L	T	R	L	T	R	L	T	R	L	T	R
Control:	Protected			Protected			Protected			Protected		
Rights:	Include			Include			WideBypass			WideBypass		
Min. Green:	0	0	0	0	0	0	0	0	0	0	0	0
Y+R:	4.0	4.0	4.0	4.0	4.0	4.0	4.0	4.0	4.0	4.0	4.0	4.0
Lanes:	1	0	2	1	0	2	1	0	2	1	0	2

Volume Module:

Base Vol:	159	1477	119	185	1053	199	212	678	106	217	909	217
Growth Adj:	1.00	1.00	1.00	1.00	1.00	1.00	1.00	1.00	1.00	1.00	1.00	1.00
Initial Bse:	159	1477	119	185	1053	199	212	678	106	217	909	217
User Adj:	1.00	1.00	1.00	1.00	1.00	1.00	1.00	1.00	1.00	1.00	1.00	1.00
PHF Adj:	1.00	1.00	1.00	1.00	1.00	1.00	1.00	1.00	1.00	1.00	1.00	1.00
PHF Volume:	159	1477	119	185	1053	199	212	678	106	217	909	217
Reduct Vol:	0	0	0	0	0	0	0	0	0	0	0	0
Reduced Vol:	159	1477	119	185	1053	199	212	678	106	217	909	217
PCE Adj:	1.00	1.00	1.00	1.00	1.00	1.00	1.00	1.00	1.00	1.00	1.00	1.00
MLF Adj:	1.00	1.00	1.00	1.00	1.00	1.00	1.00	1.00	1.00	1.00	1.00	1.00
FinalVolume:	159	1477	119	185	1053	199	212	678	106	217	909	217

Saturation Flow Module:

Sat/Lane:	1600	1600	1600	1600	1600	1600	1600	1600	1600	1600	1600	1600
Adjustment:	1.00	1.05	1.00	1.00	1.05	1.00	1.00	1.05	1.00	1.00	1.05	1.00
Lanes:	1.00	2.78	0.22	1.00	2.52	0.48	1.00	2.59	0.41	1.00	2.42	0.58
Final Sat.:	1600	4642	358	1600	4237	763	1600	4351	649	1600	4075	925

Capacity Analysis Module:

Vol/Sat:	0.10	0.32	0.33	0.12	0.25	0.26	0.13	0.16	0.16	0.14	0.22	0.23
Crit Moves:			****	****			****			****		

Santa Ana Circulation Element

Level Of Service Computation Report

ICU 1(Loss as Cycle Length %) Method (Base Volume Alternative)

Intersection #2 Euclid St and McFadden Ave

Cycle (sec): 100 Critical Vol./Cap.(X): 0.833
 Loss Time (sec): 5 Average Delay (sec/veh): xxxxxx
 Optimal Cycle: 60 Level Of Service: D

Approach:	North Bound			South Bound			East Bound			West Bound		
Movement:	L	T	R	L	T	R	L	T	R	L	T	R
Control:	Protected			Protected			Prot+Permit			Prot+Permit		
Rights:	WideBypass			Include			Include			Include		
Min. Green:	0	0	0	0	0	0	0	0	0	0	0	0
Y+R:	4.0	4.0	4.0	4.0	4.0	4.0	4.0	4.0	4.0	4.0	4.0	4.0
Lanes:	1	0	2	1	0	2	1	0	1	1	0	1

Volume Module:

Base Vol:	175	1426	92	110	1354	164	183	419	185	127	532	246
Growth Adj:	1.00	1.00	1.00	1.00	1.00	1.00	1.00	1.00	1.00	1.00	1.00	1.00
Initial Bse:	175	1426	92	110	1354	164	183	419	185	127	532	246
User Adj:	1.00	1.00	1.00	1.00	1.00	1.00	1.00	1.00	1.00	1.00	1.00	1.00
PHF Adj:	1.00	1.00	1.00	1.00	1.00	1.00	1.00	1.00	1.00	1.00	1.00	1.00
PHF Volume:	175	1426	92	110	1354	164	183	419	185	127	532	246
Reduct Vol:	0	0	0	0	0	0	0	0	0	0	0	0
Reduced Vol:	175	1426	92	110	1354	164	183	419	185	127	532	246
PCE Adj:	1.00	1.00	1.00	1.00	1.00	1.00	1.00	1.00	1.00	1.00	1.00	1.00
MLF Adj:	1.00	1.00	1.00	1.00	1.00	1.00	1.00	1.00	1.00	1.00	1.00	1.00
FinalVolume:	175	1426	92	110	1354	164	183	419	185	127	532	246

Saturation Flow Module:

Sat/Lane:	1600	1600	1600	1600	1600	1600	1600	1600	1600	1600	1600	1600
Adjustment:	1.00	1.04	1.00	1.00	1.05	1.00	1.00	1.05	1.00	1.00	1.05	1.00
Lanes:	1.00	2.82	0.18	1.00	2.68	0.32	1.00	1.39	0.61	1.00	1.37	0.63
Final Sat.:	1600	4709	291	1600	4481	519	1600	2320	980	1600	2288	1012

Capacity Analysis Module:

Vol/Sat:	0.11	0.30	0.32	0.07	0.30	0.32	0.11	0.18	0.19	0.08	0.23	0.24
Crit Moves:	****					****	****					****

Santa Ana Circulation Element

Level Of Service Computation Report

ICU 1(Loss as Cycle Length %) Method (Base Volume Alternative)

Intersection #3 Euclid St and Edinger Ave

Cycle (sec): 100 Critical Vol./Cap.(X): 0.787
Loss Time (sec): 5 Average Delay (sec/veh): xxxxxx
Optimal Cycle: 49 Level Of Service: C

Table with 4 columns: North Bound, South Bound, East Bound, West Bound. Rows include Movement, Control, Rights, Min. Green, Y+R, and Lanes.

Volume Module table with 12 columns representing different traffic movements and 10 rows of adjustment factors like Base Vol, Growth Adj, etc.

Saturation Flow Module table with 12 columns and 5 rows showing Sat/Lane, Adjustment, Lanes, and Final Sat.

Capacity Analysis Module table with 12 columns and 3 rows showing Vol/Sat, Crit Moves, and other metrics.

Santa Ana Circulation Element

Level Of Service Computation Report

ICU 1(Loss as Cycle Length %) Method (Base Volume Alternative)

Intersection #4 Newhope St and Hazard Ave

Cycle (sec): 100 Critical Vol./Cap.(X): 0.642
 Loss Time (sec): 5 Average Delay (sec/veh): xxxxxx
 Optimal Cycle: 32 Level Of Service: B

Approach:	North Bound			South Bound			East Bound			West Bound		
Movement:	L	T	R	L	T	R	L	T	R	L	T	R
Control:	Prot+Permit			Prot+Permit			Permitted			Permitted		
Rights:	Include			Include			Include			Include		
Min. Green:	0	0	0	0	0	0	0	0	0	0	0	0
Y+R:	4.0	4.0	4.0	4.0	4.0	4.0	4.0	4.0	4.0	4.0	4.0	4.0
Lanes:	1	0	1	1	0	1	1	0	1	1	0	1

Volume Module:

Base Vol:	116	1281	50	49	1038	124	108	214	131	32	202	58
Growth Adj:	1.00	1.00	1.00	1.00	1.00	1.00	1.00	1.00	1.00	1.00	1.00	1.00
Initial Bse:	116	1281	50	49	1038	124	108	214	131	32	202	58
User Adj:	1.00	1.00	1.00	1.00	1.00	1.00	1.00	1.00	1.00	1.00	1.00	1.00
PHF Adj:	1.00	1.00	1.00	1.00	1.00	1.00	1.00	1.00	1.00	1.00	1.00	1.00
PHF Volume:	116	1281	50	49	1038	124	108	214	131	32	202	58
Reduct Vol:	0	0	0	0	0	0	0	0	0	0	0	0
Reduced Vol:	116	1281	50	49	1038	124	108	214	131	32	202	58
PCE Adj:	1.00	1.00	1.00	1.00	1.00	1.00	1.00	1.00	1.00	1.00	1.00	1.00
MLF Adj:	1.00	1.00	1.00	1.00	1.00	1.00	1.00	1.00	1.00	1.00	1.00	1.00
FinalVolume:	116	1281	50	49	1038	124	108	214	131	32	202	58

Saturation Flow Module:

Sat/Lane:	1600	1600	1600	1600	1600	1600	1600	1600	1600	1600	1600	1600
Adjustment:	1.00	1.03	1.00	1.00	1.03	1.00	1.00	1.05	1.00	1.00	1.04	1.00
Lanes:	1.00	1.92	0.08	1.00	1.79	0.21	1.00	1.24	0.76	1.00	1.55	0.45
Final Sat.:	1600	3180	120	1600	2959	341	1600	2085	1215	1600	2586	714

Capacity Analysis Module:

Vol/Sat:	0.07	0.40	0.42	0.03	0.35	0.36	0.07	0.10	0.11	0.02	0.08	0.08
Crit Moves:			****	****			****			****		

Santa Ana Circulation Element

Level Of Service Computation Report

ICU 1(Loss as Cycle Length %) Method (Base Volume Alternative)

Intersection #5 Newhope St and McFadden Ave

Cycle (sec): 100 Critical Vol./Cap.(X): 0.838
Loss Time (sec): 5 Average Delay (sec/veh): xxxxxx
Optimal Cycle: 61 Level Of Service: D

Table with 4 columns: North Bound, South Bound, East Bound, West Bound. Rows include Movement, Control, Rights, Min. Green, Y+R, and Lanes.

Volume Module: Table with 12 columns representing different volume categories and their values.

Saturation Flow Module: Table with 12 columns representing saturation flow values for different lanes.

Capacity Analysis Module: Table with 12 columns representing capacity analysis values.

Santa Ana Circulation Element

Level Of Service Computation Report
 2000 HCM Operations Method (Base Volume Alternative)

 Intersection #6 Harbor Blvd and SR-22 WB Off-Ramp / Banner Dr

Cycle (sec): 100 Critical Vol./Cap.(X): 0.703
 Loss Time (sec): 5 Average Delay (sec/veh): 23.6
 Optimal Cycle: 39 Level Of Service: C

Approach:	North Bound			South Bound			East Bound			West Bound		
Movement:	L	T	R	L	T	R	L	T	R	L	T	R
Control:	Protected			Protected			Split Phase			Split Phase		
Rights:	Include			Include			Include			Include		
Min. Green:	0	0	0	0	0	0	0	0	0	0	0	0
Y+R:	4.0	4.0	4.0	4.0	4.0	4.0	4.0	4.0	4.0	4.0	4.0	4.0
Lanes:	1	0	3	0	0	2	1	0	0	1	1	0

Volume Module:

Base Vol:	88	1992	0	0	1519	49	93	0	78	593	80	170
Growth Adj:	1.00	1.00	1.00	1.00	1.00	1.00	1.00	1.00	1.00	1.00	1.00	1.00
Initial Bse:	88	1992	0	0	1519	49	93	0	78	593	80	170
User Adj:	1.00	1.00	1.00	1.00	1.00	1.00	1.00	1.00	1.00	1.00	1.00	1.00
PHF Adj:	1.00	1.00	1.00	1.00	1.00	1.00	1.00	1.00	1.00	1.00	1.00	1.00
PHF Volume:	88	1992	0	0	1519	49	93	0	78	593	80	170
Reduct Vol:	0	0	0	0	0	0	0	0	0	0	0	0
Reduced Vol:	88	1992	0	0	1519	49	93	0	78	593	80	170
PCE Adj:	1.00	1.00	1.00	1.00	1.00	1.00	1.00	1.00	1.00	1.00	1.00	1.00
MLF Adj:	1.00	1.00	1.00	1.00	1.00	1.00	1.00	1.00	1.00	1.00	1.00	1.00
FinalVolume:	88	1992	0	0	1519	49	93	0	78	593	80	170

Saturation Flow Module:

Sat/Lane:	1900	1900	1900	1900	1900	1900	1900	1900	1900	1900	1900	1900
Adjustment:	0.95	0.91	1.00	1.00	0.91	0.91	0.91	1.00	0.91	0.96	0.96	0.85
Lanes:	1.00	3.00	0.00	0.00	2.91	0.09	0.54	0.00	0.46	1.76	0.24	1.00
Final Sat.:	1805	5187	0	0	5000	161	944	0	792	3208	433	1615

Capacity Analysis Module:

Vol/Sat:	0.05	0.38	0.00	0.00	0.30	0.30	0.10	0.00	0.10	0.18	0.18	0.11
Crit Moves:	****			****			****			****		
Green/Cycle:	0.08	0.55	0.00	0.00	0.47	0.47	0.14	0.00	0.14	0.26	0.26	0.26
Volume/Cap:	0.64	0.70	0.00	0.00	0.64	0.64	0.70	0.00	0.70	0.70	0.70	0.40
Delay/Veh:	55.1	17.5	0.0	0.0	20.7	20.7	49.9	0.0	49.9	35.7	35.7	31.0
User DelAdj:	1.00	1.00	1.00	1.00	1.00	1.00	1.00	1.00	1.00	1.00	1.00	1.00
AdjDel/Veh:	55.1	17.5	0.0	0.0	20.7	20.7	49.9	0.0	49.9	35.7	35.7	31.0
LOS by Move:	E	B	A	A	C	C	D	A	D	D	D	C
HCM2k85thQ:	6	25	0	0	21	21	10	0	10	16	16	7

 Note: Queue reported is the number of cars per lane.

Santa Ana Circulation Element

Level Of Service Computation Report
 2000 HCM Operations Method (Base Volume Alternative)

 Intersection #7 Trask Avenue and SR-22 EB On-Ramp

Cycle (sec): 100 Critical Vol./Cap.(X): 0.448
 Loss Time (sec): 5 Average Delay (sec/veh): 12.4
 Optimal Cycle: 23 Level Of Service: B

Approach:	North Bound			South Bound			East Bound			West Bound		
Movement:	L	T	R	L	T	R	L	T	R	L	T	R
Control:	Protected			Protected			Protected			Protected		
Rights:	Include			Include			Include			Include		
Min. Green:	0	0	0	0	0	0	0	0	0	0	0	0
Y+R:	4.0	4.0	4.0	4.0	4.0	4.0	4.0	4.0	4.0	4.0	4.0	4.0
Lanes:	0	0	0	0	0	0	2	0	1	0	0	1

Volume Module:	North Bound			South Bound			East Bound			West Bound		
Base Vol:	0	0	0	0	0	0	838	628	0	0	606	57
Growth Adj:	1.00	1.00	1.00	1.00	1.00	1.00	1.00	1.00	1.00	1.00	1.00	1.00
Initial Bse:	0	0	0	0	0	0	838	628	0	0	606	57
User Adj:	1.00	1.00	1.00	1.00	1.00	1.00	1.00	1.00	1.00	1.00	1.00	1.00
PHF Adj:	1.00	1.00	1.00	1.00	1.00	1.00	1.00	1.00	1.00	1.00	1.00	1.00
PHF Volume:	0	0	0	0	0	0	838	628	0	0	606	57
Reduct Vol:	0	0	0	0	0	0	0	0	0	0	0	0
Reduced Vol:	0	0	0	0	0	0	838	628	0	0	606	57
PCE Adj:	1.00	1.00	1.00	1.00	1.00	1.00	1.00	1.00	1.00	1.00	1.00	1.00
MLF Adj:	1.00	1.00	1.00	1.00	1.00	1.00	1.00	1.00	1.00	1.00	1.00	1.00
FinalVolume:	0	0	0	0	0	0	838	628	0	0	606	57

Saturation Flow Module:	North Bound			South Bound			East Bound			West Bound		
Sat/Lane:	1900	1900	1900	1900	1900	1900	1900	1900	1900	1900	1900	1900
Adjustment:	1.00	1.00	1.00	1.00	1.00	1.00	0.92	1.00	1.00	1.00	0.94	0.94
Lanes:	0.00	0.00	0.00	0.00	0.00	0.00	2.00	1.00	0.00	0.00	1.83	0.17
Final Sat.:	0	0	0	0	0	0	3502	1900	0	0	3257	306

Capacity Analysis Module:	North Bound			South Bound			East Bound			West Bound		
Vol/Sat:	0.00	0.00	0.00	0.00	0.00	0.00	0.24	0.33	0.00	0.00	0.19	0.19
Crit Moves:							****				****	
Green/Cycle:	0.00	0.00	0.00	0.00	0.00	0.00	0.53	0.95	0.00	0.00	0.42	0.42
Volume/Cap:	0.00	0.00	0.00	0.00	0.00	0.00	0.45	0.35	0.00	0.00	0.45	0.45
Delay/Veh:	0.0	0.0	0.0	0.0	0.0	0.0	14.4	0.3	0.0	0.0	21.2	21.2
User DelAdj:	1.00	1.00	1.00	1.00	1.00	1.00	1.00	1.00	1.00	1.00	1.00	1.00
AdjDel/Veh:	0.0	0.0	0.0	0.0	0.0	0.0	14.4	0.3	0.0	0.0	21.2	21.2
LOS by Move:	A	A	A	A	A	A	B	A	A	A	C	C
HCM2k85thQ:	0	0	0	0	0	0	12	3	0	0	12	12

 Note: Queue reported is the number of cars per lane.

Santa Ana Circulation Element

Level Of Service Computation Report

ICU 1(Loss as Cycle Length %) Method (Base Volume Alternative)

Intersection #8 Harbor Blvd and Westminster Ave

Cycle (sec): 100 Critical Vol./Cap.(X): 0.792
Loss Time (sec): 5 Average Delay (sec/veh): xxxxxx
Optimal Cycle: 50 Level Of Service: C

Table with 4 columns: North Bound, South Bound, East Bound, West Bound. Rows include Movement (L-T-R), Control, Rights, Min. Green, Y+R, and Lanes.

Volume Module: Table with 12 columns representing different volume categories and their values.

Saturation Flow Module: Table with 12 columns representing saturation flow values for various lanes.

Capacity Analysis Module: Table with 12 columns representing capacity analysis values.

Santa Ana Circulation Element

Level Of Service Computation Report

ICU 1(Loss as Cycle Length %) Method (Base Volume Alternative)

Intersection #9 Harbor Blvd and 1st St

Cycle (sec): 100 Critical Vol./Cap.(X): 0.833
 Loss Time (sec): 5 Average Delay (sec/veh): xxxxxx
 Optimal Cycle: 60 Level Of Service: D

Approach:	North Bound			South Bound			East Bound			West Bound		
Movement:	L	T	R	L	T	R	L	T	R	L	T	R
Control:	Protected			Protected			Protected			Protected		
Rights:	Include			Include			Include			Include		
Min. Green:	0	0	0	0	0	0	0	0	0	0	0	0
Y+R:	4.0	4.0	4.0	4.0	4.0	4.0	4.0	4.0	4.0	4.0	4.0	4.0
Lanes:	1	0	3	0	1	1	2	0	2	1	0	2

Volume Module:

Base Vol:	287	1480	164	278	1218	164	188	766	145	230	1073	175
Growth Adj:	1.00	1.00	1.00	1.00	1.00	1.00	1.00	1.00	1.00	1.00	1.00	1.00
Initial Bse:	287	1480	164	278	1218	164	188	766	145	230	1073	175
User Adj:	1.00	1.00	1.00	1.00	1.00	1.00	1.00	1.00	1.00	1.00	1.00	1.00
PHF Adj:	1.00	1.00	1.00	1.00	1.00	1.00	1.00	1.00	1.00	1.00	1.00	1.00
PHF Volume:	287	1480	164	278	1218	164	188	766	145	230	1073	175
Reduct Vol:	0	0	0	0	0	0	0	0	0	0	0	0
Reduced Vol:	287	1480	164	278	1218	164	188	766	145	230	1073	175
PCE Adj:	1.00	1.00	1.00	1.00	1.00	1.00	1.00	1.00	1.00	1.00	1.00	1.00
MLF Adj:	1.00	1.00	1.00	1.00	1.00	1.00	1.00	1.00	1.00	1.00	1.00	1.00
FinalVolume:	287	1480	164	278	1218	164	188	766	145	230	1073	175

Saturation Flow Module:

Sat/Lane:	1600	1600	1600	1600	1600	1600	1600	1600	1600	1600	1600	1600
Adjustment:	1.00	1.06	1.00	1.00	1.06	1.00	1.00	1.05	1.00	1.00	1.05	1.00
Lanes:	1.00	3.00	1.00	1.00	3.00	1.00	2.00	2.52	0.48	2.00	2.58	0.42
Final Sat.:	1600	5100	1600	1600	5100	1600	3200	4236	764	3200	4327	673

Capacity Analysis Module:

Vol/Sat:	0.18	0.29	0.10	0.17	0.24	0.10	0.06	0.18	0.19	0.07	0.25	0.26
Crit Moves:	****			****			****			****		

Santa Ana Circulation Element

Level Of Service Computation Report

ICU 1(Loss as Cycle Length %) Method (Base Volume Alternative)

Intersection #10 Harbor Blvd and McFadden Ave

Cycle (sec): 100 Critical Vol./Cap.(X): 0.809
 Loss Time (sec): 5 Average Delay (sec/veh): xxxxxx
 Optimal Cycle: 54 Level Of Service: D

Approach:	North Bound			South Bound			East Bound			West Bound		
Movement:	L	T	R	L	T	R	L	T	R	L	T	R
Control:	Protected			Protected			Protected			Protected		
Rights:	Include			Include			Include			Include		
Min. Green:	0	0	0	0	0	0	0	0	0	0	0	0
Y+R:	4.0	4.0	4.0	4.0	4.0	4.0	4.0	4.0	4.0	4.0	4.0	4.0
Lanes:	2	0	3	0	1	0	2	0	2	1	0	1

Volume Module:

Base Vol:	167	1716	125	298	1273	115	214	520	65	211	506	146
Growth Adj:	1.00	1.00	1.00	1.00	1.00	1.00	1.00	1.00	1.00	1.00	1.00	1.00
Initial Bse:	167	1716	125	298	1273	115	214	520	65	211	506	146
User Adj:	1.00	1.00	1.00	1.00	1.00	1.00	1.00	1.00	1.00	1.00	1.00	1.00
PHF Adj:	1.00	1.00	1.00	1.00	1.00	1.00	1.00	1.00	1.00	1.00	1.00	1.00
PHF Volume:	167	1716	125	298	1273	115	214	520	65	211	506	146
Reduct Vol:	0	0	0	0	0	0	0	0	0	0	0	0
Reduced Vol:	167	1716	125	298	1273	115	214	520	65	211	506	146
PCE Adj:	1.00	1.00	1.00	1.00	1.00	1.00	1.00	1.00	1.00	1.00	1.00	1.00
MLF Adj:	1.00	1.00	1.00	1.00	1.00	1.00	1.00	1.00	1.00	1.00	1.00	1.00
FinalVolume:	167	1716	125	298	1273	115	214	520	65	211	506	146

Saturation Flow Module:

Sat/Lane:	1600	1600	1600	1600	1600	1600	1600	1600	1600	1600	1600	1600
Adjustment:	1.00	1.06	1.00	1.00	1.05	1.00	1.00	1.04	1.00	1.00	1.04	1.00
Lanes:	2.00	3.00	1.00	2.00	2.75	0.25	1.00	1.78	0.22	1.00	1.55	0.45
Final Sat.:	3200	5100	1600	3200	4602	398	1600	2944	356	1600	2583	717

Capacity Analysis Module:

Vol/Sat:	0.05	0.34	0.08	0.09	0.28	0.29	0.13	0.18	0.18	0.13	0.20	0.20
Crit Moves:	****			****			****			****		

Santa Ana Circulation Element

Level Of Service Computation Report

ICU 1(Loss as Cycle Length %) Method (Base Volume Alternative)

Intersection #11 Harbor Blvd and Edinger Ave

Cycle (sec): 100 Critical Vol./Cap.(X): 0.697
 Loss Time (sec): 5 Average Delay (sec/veh): xxxxxx
 Optimal Cycle: 37 Level Of Service: B

Approach:	North Bound			South Bound			East Bound			West Bound		
Movement:	L	T	R	L	T	R	L	T	R	L	T	R
Control:	Protected			Protected			Protected			Protected		
Rights:	Include			Include			Include			Include		
Min. Green:	0	0	0	0	0	0	0	0	0	0	0	0
Y+R:	4.0	4.0	4.0	4.0	4.0	4.0	4.0	4.0	4.0	4.0	4.0	4.0
Lanes:	2	0	3	0	1		2	0	3	0	1	

Volume Module:

Base Vol:	282	1773	214	283	822	75	134	564	100	140	813	271
Growth Adj:	1.00	1.00	1.00	1.00	1.00	1.00	1.00	1.00	1.00	1.00	1.00	1.00
Initial Bse:	282	1773	214	283	822	75	134	564	100	140	813	271
User Adj:	1.00	1.00	1.00	1.00	1.00	1.00	1.00	1.00	1.00	1.00	1.00	1.00
PHF Adj:	1.00	1.00	1.00	1.00	1.00	1.00	1.00	1.00	1.00	1.00	1.00	1.00
PHF Volume:	282	1773	214	283	822	75	134	564	100	140	813	271
Reduct Vol:	0	0	0	0	0	0	0	0	0	0	0	0
Reduced Vol:	282	1773	214	283	822	75	134	564	100	140	813	271
PCE Adj:	1.00	1.00	1.00	1.00	1.00	1.00	1.00	1.00	1.00	1.00	1.00	1.00
MLF Adj:	1.00	1.00	1.00	1.00	1.00	1.00	1.00	1.00	1.00	1.00	1.00	1.00
FinalVolume:	282	1773	214	283	822	75	134	564	100	140	813	271

Saturation Flow Module:

Sat/Lane:	1600	1600	1600	1600	1600	1600	1600	1600	1600	1600	1600	1600
Adjustment:	1.00	1.06	1.00	1.00	1.06	1.00	1.00	1.05	1.00	1.00	1.06	1.00
Lanes:	2.00	3.00	1.00	2.00	3.00	1.00	2.00	2.55	0.45	2.00	3.00	1.00
Final Sat.:	3200	5100	1600	3200	5100	1600	3200	4277	723	3200	5100	1600

Capacity Analysis Module:

Vol/Sat:	0.09	0.35	0.13	0.09	0.16	0.05	0.04	0.13	0.14	0.04	0.16	0.17
Crit Moves:	****			****			****			****		

Santa Ana Circulation Element

Level Of Service Computation Report

ICU 1(Loss as Cycle Length %) Method (Base Volume Alternative)

Intersection #12 Harbor Blvd and Warner Ave

Cycle (sec): 100 Critical Vol./Cap.(X): 1.581
Loss Time (sec): 5 Average Delay (sec/veh): xxxxxx
Optimal Cycle: 180 Level Of Service: F

Table with 4 columns: North Bound, South Bound, East Bound, West Bound. Rows include Movement (L-T-R), Control (Protected), Rights (Include), Min. Green, Y+R, and Lanes.

Volume Module table with 12 columns representing different traffic flows and 10 rows of adjustment factors like Growth Adj, PHF Adj, etc.

Saturation Flow Module table with 12 columns and 4 rows showing Sat/Lane, Adjustment, Lanes, and Final Sat.

Capacity Analysis Module table with 12 columns and 2 rows showing Vol/Sat and Crit Moves.

Santa Ana Circulation Element

Level Of Service Computation Report

ICU 1(Loss as Cycle Length %) Method (Base Volume Alternative)

Intersection #13 Harbor Blvd and Segerstrom Ave

Cycle (sec): 100 Critical Vol./Cap.(X): 0.897
 Loss Time (sec): 5 Average Delay (sec/veh): xxxxxx
 Optimal Cycle: 85 Level Of Service: D

Approach:	North Bound			South Bound			East Bound			West Bound		
Movement:	L	T	R	L	T	R	L	T	R	L	T	R
Control:	Protected			Protected			Prot+Permit			Prot+Permit		
Rights:	Include			Include			Include			Include		
Min. Green:	0	0	0	0	0	0	0	0	0	0	0	0
Y+R:	4.0	4.0	4.0	4.0	4.0	4.0	4.0	4.0	4.0	4.0	4.0	4.0
Lanes:	2	0	2	1	0	2	1	0	1	1	0	2

Volume Module:

Base Vol:	299	1881	60	91	1027	91	111	552	181	99	1074	390
Growth Adj:	1.00	1.00	1.00	1.00	1.00	1.00	1.00	1.00	1.00	1.00	1.00	1.00
Initial Bse:	299	1881	60	91	1027	91	111	552	181	99	1074	390
User Adj:	1.00	1.00	1.00	1.00	1.00	1.00	1.00	1.00	1.00	1.00	1.00	1.00
PHF Adj:	1.00	1.00	1.00	1.00	1.00	1.00	1.00	1.00	1.00	1.00	1.00	1.00
PHF Volume:	299	1881	60	91	1027	91	111	552	181	99	1074	390
Reduct Vol:	0	0	0	0	0	0	0	0	0	0	0	0
Reduced Vol:	299	1881	60	91	1027	91	111	552	181	99	1074	390
PCE Adj:	1.00	1.00	1.00	1.00	1.00	1.00	1.00	1.00	1.00	1.00	1.00	1.00
MLF Adj:	1.00	1.00	1.00	1.00	1.00	1.00	1.00	1.00	1.00	1.00	1.00	1.00
FinalVolume:	299	1881	60	91	1027	91	111	552	181	99	1074	390

Saturation Flow Module:

Sat/Lane:	1600	1600	1600	1600	1600	1600	1600	1600	1600	1600	1600	1600
Adjustment:	1.00	1.04	1.00	1.00	1.05	1.00	1.00	1.04	1.00	1.00	1.06	1.00
Lanes:	2.00	2.91	0.09	1.00	2.76	0.24	1.00	1.51	0.49	1.00	2.00	1.00
Final Sat.:	3200	4852	148	1600	4609	391	1600	2510	790	1600	3400	1600

Capacity Analysis Module:

Vol/Sat:	0.09	0.39	0.40	0.06	0.22	0.23	0.07	0.22	0.23	0.06	0.32	0.24
Crit Moves:			****	****			****			****		

Santa Ana Circulation Element

Level Of Service Computation Report

ICU 1(Loss as Cycle Length %) Method (Base Volume Alternative)

Intersection #14 MacArthur Blvd and Hyland Ave

Cycle (sec): 100 Critical Vol./Cap.(X): 0.917
 Loss Time (sec): 5 Average Delay (sec/veh): xxxxxx
 Optimal Cycle: 98 Level Of Service: E

Approach:	North Bound			South Bound			East Bound			West Bound		
Movement:	L	T	R	L	T	R	L	T	R	L	T	R
Control:	Protected			Protected			Prot+Permit			Prot+Permit		
Rights:	Include			Include			Include			Include		
Min. Green:	0	0	0	0	0	0	0	0	0	0	0	0
Y+R:	4.0	4.0	4.0	4.0	4.0	4.0	4.0	4.0	4.0	4.0	4.0	4.0
Lanes:	2	0	0	1	0	1	3	0	1	1	0	3

Volume Module:

Base Vol:	1201	7	70	12	4	14	36	891	160	25	2350	12
Growth Adj:	1.00	1.00	1.00	1.00	1.00	1.00	1.00	1.00	1.00	1.00	1.00	1.00
Initial Bse:	1201	7	70	12	4	14	36	891	160	25	2350	12
User Adj:	1.00	1.00	1.00	1.00	1.00	1.00	1.00	1.00	1.00	1.00	1.00	1.00
PHF Adj:	1.00	1.00	1.00	1.00	1.00	1.00	1.00	1.00	1.00	1.00	1.00	1.00
PHF Volume:	1201	7	70	12	4	14	36	891	160	25	2350	12
Reduct Vol:	0	0	0	0	0	0	0	0	0	0	0	0
Reduced Vol:	1201	7	70	12	4	14	36	891	160	25	2350	12
PCE Adj:	1.00	1.00	1.00	1.00	1.00	1.00	1.00	1.00	1.00	1.00	1.00	1.00
MLF Adj:	1.00	1.00	1.00	1.00	1.00	1.00	1.00	1.00	1.00	1.00	1.00	1.00
FinalVolume:	1201	7	70	12	4	14	36	891	160	25	2350	12

Saturation Flow Module:

Sat/Lane:	1600	1600	1600	1600	1600	1600	1600	1600	1600	1600	1600	1600
Adjustment:	1.00	1.00	1.00	1.00	1.06	1.00	1.00	1.06	1.00	1.00	1.06	1.00
Lanes:	2.00	0.09	0.91	1.00	1.00	1.00	1.00	3.00	1.00	1.00	3.00	1.00
Final Sat.:	3200	145	1455	1600	1700	1600	1600	5100	1600	1600	5100	1600

Capacity Analysis Module:

Vol/Sat:	0.38	0.05	0.05	0.01	0.00	0.01	0.02	0.17	0.10	0.02	0.46	0.01
Crit Moves:	****					****	****				****	

Santa Ana Circulation Element

Level Of Service Computation Report

ICU 1(Loss as Cycle Length %) Method (Base Volume Alternative)

Intersection #15 MacArthur Blvd and Harbor Blvd

Cycle (sec): 100 Critical Vol./Cap.(X): 0.819
 Loss Time (sec): 5 Average Delay (sec/veh): xxxxxx
 Optimal Cycle: 56 Level Of Service: D

Approach:	North Bound			South Bound			East Bound			West Bound		
Movement:	L	T	R	L	T	R	L	T	R	L	T	R
Control:	Protected			Protected			Protected			Protected		
Rights:	Include			Include			Include			Include		
Min. Green:	0	0	0	0	0	0	0	0	0	0	0	0
Y+R:	4.0	4.0	4.0	4.0	4.0	4.0	4.0	4.0	4.0	4.0	4.0	4.0
Lanes:	2	0	3	0	1		2	0	3	0	1	

Volume Module:

Base Vol:	588	1519	88	213	1073	176	140	489	181	87	1467	276
Growth Adj:	1.00	1.00	1.00	1.00	1.00	1.00	1.00	1.00	1.00	1.00	1.00	1.00
Initial Bse:	588	1519	88	213	1073	176	140	489	181	87	1467	276
User Adj:	1.00	1.00	1.00	1.00	1.00	1.00	1.00	1.00	1.00	1.00	1.00	1.00
PHF Adj:	1.00	1.00	1.00	1.00	1.00	1.00	1.00	1.00	1.00	1.00	1.00	1.00
PHF Volume:	588	1519	88	213	1073	176	140	489	181	87	1467	276
Reduct Vol:	0	0	0	0	0	0	0	0	0	0	0	0
Reduced Vol:	588	1519	88	213	1073	176	140	489	181	87	1467	276
PCE Adj:	1.00	1.00	1.00	1.00	1.00	1.00	1.00	1.00	1.00	1.00	1.00	1.00
MLF Adj:	1.00	1.00	1.00	1.00	1.00	1.00	1.00	1.00	1.00	1.00	1.00	1.00
FinalVolume:	588	1519	88	213	1073	176	140	489	181	87	1467	276

Saturation Flow Module:

Sat/Lane:	1600	1600	1600	1600	1600	1600	1600	1600	1600	1600	1600	1600
Adjustment:	1.00	1.06	1.00	1.00	1.06	1.00	1.00	1.06	1.00	1.00	1.06	1.00
Lanes:	2.00	3.00	1.00	2.00	3.00	1.00	1.00	3.00	1.00	1.00	3.00	1.00
Final Sat.:	3200	5100	1600	3200	5100	1600	1600	5100	1600	1600	5100	1600

Capacity Analysis Module:

Vol/Sat:	0.18	0.30	0.06	0.07	0.21	0.11	0.09	0.10	0.11	0.05	0.29	0.17
Crit Moves:	****				****		****				****	

Santa Ana Circulation Element

Level Of Service Computation Report

ICU 1(Loss as Cycle Length %) Method (Base Volume Alternative)

Intersection #16 Harbor Blvd and Sunflower Ave

Cycle (sec): 100 Critical Vol./Cap.(X): 0.780
 Loss Time (sec): 5 Average Delay (sec/veh): xxxxxx
 Optimal Cycle: 48 Level Of Service: C

Approach:	North Bound			South Bound			East Bound			West Bound		
Movement:	L	T	R	L	T	R	L	T	R	L	T	R
Control:	Protected			Protected			Split Phase			Split Phase		
Rights:	Include			Include			Include			Include		
Min. Green:	0	0	0	0	0	0	0	0	0	0	0	0
Y+R:	4.0	4.0	4.0	4.0	4.0	4.0	4.0	4.0	4.0	4.0	4.0	4.0
Lanes:	2	0	3	0	1	1	2	0	3	0	1	1

Volume Module:

Base Vol:	178	1771	263	112	1393	42	67	182	189	254	533	199
Growth Adj:	1.00	1.00	1.00	1.00	1.00	1.00	1.00	1.00	1.00	1.00	1.00	1.00
Initial Bse:	178	1771	263	112	1393	42	67	182	189	254	533	199
User Adj:	1.00	1.00	1.00	1.00	1.00	1.00	1.00	1.00	1.00	1.00	1.00	1.00
PHF Adj:	1.00	1.00	1.00	1.00	1.00	1.00	1.00	1.00	1.00	1.00	1.00	1.00
PHF Volume:	178	1771	263	112	1393	42	67	182	189	254	533	199
Reduct Vol:	0	0	0	0	0	0	0	0	0	0	0	0
Reduced Vol:	178	1771	263	112	1393	42	67	182	189	254	533	199
PCE Adj:	1.00	1.00	1.00	1.00	1.00	1.00	1.00	1.00	1.00	1.00	1.00	1.00
MLF Adj:	1.00	1.00	1.00	1.00	1.00	1.00	1.00	1.00	1.00	1.00	1.00	1.00
FinalVolume:	178	1771	263	112	1393	42	67	182	189	254	533	199

Saturation Flow Module:

Sat/Lane:	1600	1600	1600	1600	1600	1600	1600	1600	1600	1600	1600	1600
Adjustment:	1.00	1.06	1.00	1.00	1.06	1.00	1.00	1.06	1.00	1.00	1.04	1.00
Lanes:	2.00	3.00	1.00	2.00	3.00	1.00	1.00	1.00	1.00	1.00	1.39	0.61
Final Sat.:	3200	5100	1600	3200	5100	1600	1600	1700	1600	1600	2322	974

Capacity Analysis Module:

Vol/Sat:	0.06	0.35	0.16	0.04	0.27	0.03	0.04	0.11	0.12	0.16	0.23	0.20
Crit Moves:	****			****			****			****		

Santa Ana Circulation Element

Level Of Service Computation Report
 2000 HCM Operations Method (Base Volume Alternative)

 Intersection #17 Harbor Blvd and I-405 WB Off-Ramp

Cycle (sec): 100 Critical Vol./Cap.(X): 0.812
 Loss Time (sec): 5 Average Delay (sec/veh): 22.9
 Optimal Cycle: 57 Level Of Service: C

Approach:	North Bound			South Bound			East Bound			West Bound		
Movement:	L	T	R	L	T	R	L	T	R	L	T	R
Control:	Protected			Protected			Split Phase			Split Phase		
Rights:	Include			Include			Include			Include		
Min. Green:	0	0	0	0	0	0	0	0	0	0	0	0
Y+R:	4.0	4.0	4.0	4.0	4.0	4.0	4.0	4.0	4.0	4.0	4.0	4.0
Lanes:	0	0	4	0	0	4	0	0	0	1	0	1

Volume Module:

Base Vol:	0	1529	0	0	2475	0	0	0	0	701	0	1132
Growth Adj:	1.00	1.00	1.00	1.00	1.00	1.00	1.00	1.00	1.00	1.00	1.00	1.00
Initial Bse:	0	1529	0	0	2475	0	0	0	0	701	0	1132
User Adj:	1.00	1.00	1.00	1.00	1.00	1.00	1.00	1.00	1.00	1.00	1.00	1.00
PHF Adj:	1.00	1.00	1.00	1.00	1.00	1.00	1.00	1.00	1.00	1.00	1.00	1.00
PHF Volume:	0	1529	0	0	2475	0	0	0	0	701	0	1132
Reduct Vol:	0	0	0	0	0	0	0	0	0	0	0	0
Reduced Vol:	0	1529	0	0	2475	0	0	0	0	701	0	1132
PCE Adj:	1.00	1.00	1.00	1.00	1.00	1.00	1.00	1.00	1.00	1.00	1.00	1.00
MLF Adj:	1.00	1.00	1.00	1.00	1.00	1.00	1.00	1.00	1.00	1.00	1.00	1.00
FinalVolume:	0	1529	0	0	2475	0	0	0	0	701	0	1132

Saturation Flow Module:

Sat/Lane:	1900	1900	1900	1900	1900	1900	1900	1900	1900	1900	1900	1900
Adjustment:	1.00	0.91	1.00	1.00	0.91	1.00	1.00	1.00	1.00	0.89	1.00	0.89
Lanes:	0.00	4.00	0.00	0.00	4.00	0.00	0.00	0.00	0.00	1.38	0.00	1.62
Final Sat.:	0	6916	0	0	6916	0	0	0	0	2337	0	2735

Capacity Analysis Module:

Vol/Sat:	0.00	0.22	0.00	0.00	0.36	0.00	0.00	0.00	0.00	0.30	0.00	0.41
Crit Moves:	****			****								****
Green/Cycle:	0.00	0.44	0.00	0.00	0.44	0.00	0.00	0.00	0.00	0.51	0.00	0.51
Volume/Cap:	0.00	0.50	0.00	0.00	0.81	0.00	0.00	0.00	0.00	0.59	0.00	0.81
Delay/Veh:	0.0	20.2	0.0	0.0	26.1	0.0	0.0	0.0	0.0	17.5	0.0	22.9
User DelAdj:	1.00	1.00	1.00	1.00	1.00	1.00	1.00	1.00	1.00	1.00	1.00	1.00
AdjDel/Veh:	0.0	20.2	0.0	0.0	26.1	0.0	0.0	0.0	0.0	17.5	0.0	22.9
LOS by Move:	A	C	A	A	C	A	A	A	A	B	A	C
HCM2k85thQ:	0	14	0	0	29	0	0	0	0	17	0	29

 Note: Queue reported is the number of cars per lane.

Santa Ana Circulation Element

Level Of Service Computation Report
 2000 HCM Operations Method (Base Volume Alternative)

 Intersection #18 Harbor Blvd and I-405 EB Off-Ramp

Cycle (sec): 100 Critical Vol./Cap.(X): 0.630
 Loss Time (sec): 5 Average Delay (sec/veh): 16.2
 Optimal Cycle: 32 Level Of Service: B

Approach:	North Bound			South Bound			East Bound			West Bound		
Movement:	L	T	R	L	T	R	L	T	R	L	T	R
Control:	Protected			Protected			Split Phase			Split Phase		
Rights:	Ignore			Include			Include			Include		
Min. Green:	0	0	0	0	0	0	0	0	0	0	0	0
Y+R:	4.0	4.0	4.0	4.0	4.0	4.0	4.0	4.0	4.0	4.0	4.0	4.0
Lanes:	0	0	3	0	0	4	1	0	1	0	0	0

Volume Module:

Base Vol:	0	1861	0	0	2147	0	157	0	722	0	0	0
Growth Adj:	1.00	1.00	1.00	1.00	1.00	1.00	1.00	1.00	1.00	1.00	1.00	1.00
Initial Bse:	0	1861	0	0	2147	0	157	0	722	0	0	0
User Adj:	1.00	1.00	0.00	1.00	1.00	1.00	1.00	1.00	1.00	1.00	1.00	1.00
PHF Adj:	1.00	1.00	0.00	1.00	1.00	1.00	1.00	1.00	1.00	1.00	1.00	1.00
PHF Volume:	0	1861	0	0	2147	0	157	0	722	0	0	0
Reduct Vol:	0	0	0	0	0	0	0	0	0	0	0	0
Reduced Vol:	0	1861	0	0	2147	0	157	0	722	0	0	0
PCE Adj:	1.00	1.00	0.00	1.00	1.00	1.00	1.00	1.00	1.00	1.00	1.00	1.00
MLF Adj:	1.00	1.00	0.00	1.00	1.00	1.00	1.00	1.00	1.00	1.00	1.00	1.00
FinalVolume:	0	1861	0	0	2147	0	157	0	722	0	0	0

Saturation Flow Module:

Sat/Lane:	1900	1900	1900	1900	1900	1900	1900	1900	1900	1900	1900	1900
Adjustment:	1.00	0.91	1.00	1.00	0.91	1.00	0.87	1.00	0.87	1.00	1.00	1.00
Lanes:	0.00	3.00	1.00	0.00	4.00	0.00	1.18	0.00	1.82	0.00	0.00	0.00
Final Sat.:	0	5187	1900	0	6916	0	1946	0	3008	0	0	0

Capacity Analysis Module:

Vol/Sat:	0.00	0.36	0.00	0.00	0.31	0.00	0.08	0.00	0.24	0.00	0.00	0.00
Crit Moves:	****			****			****			****		
Green/Cycle:	0.00	0.57	0.00	0.00	0.57	0.00	0.38	0.00	0.38	0.00	0.00	0.00
Volume/Cap:	0.00	0.63	0.00	0.00	0.55	0.00	0.21	0.00	0.63	0.00	0.00	0.00
Delay/Veh:	0.0	14.9	0.0	0.0	13.6	0.0	20.9	0.0	26.2	0.0	0.0	0.0
User DelAdj:	1.00	1.00	1.00	1.00	1.00	1.00	1.00	1.00	1.00	1.00	1.00	1.00
AdjDel/Veh:	0.0	14.9	0.0	0.0	13.6	0.0	20.9	0.0	26.2	0.0	0.0	0.0
LOS by Move:	A	B	A	A	B	A	C	A	C	A	A	A
HCM2k85thQ:	0	21	0	0	17	0	4	0	16	0	0	0

 Note: Queue reported is the number of cars per lane.

Santa Ana Circulation Element

Level Of Service Computation Report

ICU 1(Loss as Cycle Length %) Method (Base Volume Alternative)

Intersection #19 Fairview St and Civic Center Dr

Cycle (sec): 100 Critical Vol./Cap.(X): 0.662
 Loss Time (sec): 5 Average Delay (sec/veh): xxxxxx
 Optimal Cycle: 34 Level Of Service: B

Approach:	North Bound			South Bound			East Bound			West Bound		
Movement:	L	T	R	L	T	R	L	T	R	L	T	R
Control:	Protected			Protected			Split Phase			Split Phase		
Rights:	WideBypass			Include			Include			Include		
Min. Green:	0	0	0	0	0	0	0	0	0	0	0	0
Y+R:	4.0	4.0	4.0	4.0	4.0	4.0	4.0	4.0	4.0	4.0	4.0	4.0
Lanes:	1	0	2	1	0	2	1	0	1	0	1	0

Volume Module:

Base Vol:	5	1430	402	144	1338	0	2	5	4	438	0	162
Growth Adj:	1.00	1.00	1.00	1.00	1.00	1.00	1.00	1.00	1.00	1.00	1.00	1.00
Initial Bse:	5	1430	402	144	1338	0	2	5	4	438	0	162
User Adj:	1.00	1.00	1.00	1.00	1.00	1.00	1.00	1.00	1.00	1.00	1.00	1.00
PHF Adj:	1.00	1.00	1.00	1.00	1.00	1.00	1.00	1.00	1.00	1.00	1.00	1.00
PHF Volume:	5	1430	402	144	1338	0	2	5	4	438	0	162
Reduct Vol:	0	0	0	0	0	0	0	0	0	0	0	0
Reduced Vol:	5	1430	402	144	1338	0	2	5	4	438	0	162
PCE Adj:	1.00	1.00	1.00	1.00	1.00	1.00	1.00	1.00	1.00	1.00	1.00	1.00
MLF Adj:	1.00	1.00	1.00	1.00	1.00	1.00	1.00	1.00	1.00	1.00	1.00	1.00
FinalVolume:	5	1430	402	144	1338	0	2	5	4	438	0	162

Saturation Flow Module:

Sat/Lane:	1600	1600	1600	1600	1600	1600	1600	1600	1600	1600	1600	1600
Adjustment:	1.00	1.05	1.00	1.00	1.04	1.00	1.00	1.00	1.00	1.00	1.06	1.00
Lanes:	1.00	2.34	0.66	1.00	3.00	0.00	0.36	0.91	0.73	2.00	0.00	1.00
Final Sat.:	1600	3947	1053	1600	5000	0	582	1455	1164	3200	0	1600

Capacity Analysis Module:

Vol/Sat:	0.00	0.36	0.38	0.09	0.27	0.00	0.00	0.00	0.00	0.14	0.00	0.10
Crit Moves:			****	****			****			****		

Santa Ana Circulation Element

Level Of Service Computation Report

ICU 1(Loss as Cycle Length %) Method (Base Volume Alternative)

Intersection #20 Fairview St and 1st St

Cycle (sec): 100 Critical Vol./Cap.(X): 0.883
 Loss Time (sec): 5 Average Delay (sec/veh): xxxxxx
 Optimal Cycle: 78 Level Of Service: D

Approach:	North Bound			South Bound			East Bound			West Bound		
Movement:	L	T	R	L	T	R	L	T	R	L	T	R
Control:	Protected			Protected			Protected			Protected		
Rights:	Include			WideBypass			Include			Include		
Min. Green:	0	0	0	0	0	0	0	0	0	0	0	0
Y+R:	4.0	4.0	4.0	4.0	4.0	4.0	4.0	4.0	4.0	4.0	4.0	4.0
Lanes:	1	0	3	0	1	1	0	1	2	1	0	2

Volume Module:

Base Vol:	149	1094	99	203	1264	251	215	870	151	159	1204	186
Growth Adj:	1.00	1.00	1.00	1.00	1.00	1.00	1.00	1.00	1.00	1.00	1.00	1.00
Initial Bse:	149	1094	99	203	1264	251	215	870	151	159	1204	186
User Adj:	1.00	1.00	1.00	1.00	1.00	1.00	1.00	1.00	1.00	1.00	1.00	1.00
PHF Adj:	1.00	1.00	1.00	1.00	1.00	1.00	1.00	1.00	1.00	1.00	1.00	1.00
PHF Volume:	149	1094	99	203	1264	251	215	870	151	159	1204	186
Reduct Vol:	0	0	0	0	0	0	0	0	0	0	0	0
Reduced Vol:	149	1094	99	203	1264	251	215	870	151	159	1204	186
PCE Adj:	1.00	1.00	1.00	1.00	1.00	1.00	1.00	1.00	1.00	1.00	1.00	1.00
MLF Adj:	1.00	1.00	1.00	1.00	1.00	1.00	1.00	1.00	1.00	1.00	1.00	1.00
FinalVolume:	149	1094	99	203	1264	251	215	870	151	159	1204	186

Saturation Flow Module:

Sat/Lane:	1600	1600	1600	1600	1600	1600	1600	1600	1600	1600	1600	1600
Adjustment:	1.00	1.06	1.00	1.00	1.05	1.00	1.00	1.05	1.00	1.00	1.05	1.00
Lanes:	1.00	3.00	1.00	1.00	2.50	0.50	1.00	2.56	0.44	1.00	2.60	0.40
Final Sat.:	1600	5100	1600	1600	4205	795	1600	4290	710	1600	4358	642

Capacity Analysis Module:

Vol/Sat:	0.09	0.21	0.06	0.13	0.30	0.32	0.13	0.20	0.21	0.10	0.28	0.29
Crit Moves:	****					****	****					****

Santa Ana Circulation Element

Level Of Service Computation Report

ICU 1(Loss as Cycle Length %) Method (Base Volume Alternative)

Intersection #21 Fairview St and McFadden Ave

Cycle (sec): 100 Critical Vol./Cap.(X): 0.798
 Loss Time (sec): 5 Average Delay (sec/veh): xxxxxx
 Optimal Cycle: 52 Level Of Service: C

Approach:	North Bound			South Bound			East Bound			West Bound		
Movement:	L	T	R	L	T	R	L	T	R	L	T	R
Control:	Protected			Protected			Protected			Protected		
Rights:	Include			Include			Include			Include		
Min. Green:	0	0	0	0	0	0	0	0	0	0	0	0
Y+R:	4.0	4.0	4.0	4.0	4.0	4.0	4.0	4.0	4.0	4.0	4.0	4.0
Lanes:	1	0	3	0	1	1	0	1	1	0	1	1

Volume Module:

Base Vol:	159	1462	127	155	1257	196	244	659	163	158	545	134
Growth Adj:	1.00	1.00	1.00	1.00	1.00	1.00	1.00	1.00	1.00	1.00	1.00	1.00
Initial Bse:	159	1462	127	155	1257	196	244	659	163	158	545	134
User Adj:	1.00	1.00	1.00	1.00	1.00	1.00	1.00	1.00	1.00	1.00	1.00	1.00
PHF Adj:	1.00	1.00	1.00	1.00	1.00	1.00	1.00	1.00	1.00	1.00	1.00	1.00
PHF Volume:	159	1462	127	155	1257	196	244	659	163	158	545	134
Reduct Vol:	0	0	0	0	0	0	0	0	0	0	0	0
Reduced Vol:	159	1462	127	155	1257	196	244	659	163	158	545	134
PCE Adj:	1.00	1.00	1.00	1.00	1.00	1.00	1.00	1.00	1.00	1.00	1.00	1.00
MLF Adj:	1.00	1.00	1.00	1.00	1.00	1.00	1.00	1.00	1.00	1.00	1.00	1.00
FinalVolume:	159	1462	127	155	1257	196	244	659	163	158	545	134

Saturation Flow Module:

Sat/Lane:	1600	1600	1600	1600	1600	1600	1600	1600	1600	1600	1600	1600
Adjustment:	1.00	1.06	1.00	1.00	1.06	1.00	1.00	1.04	1.00	1.00	1.04	1.00
Lanes:	1.00	3.00	1.00	1.00	3.00	1.00	1.00	1.60	0.40	1.00	1.61	0.39
Final Sat.:	1600	5100	1600	1600	5100	1600	1600	2665	635	1600	2668	632

Capacity Analysis Module:

Vol/Sat:	0.10	0.29	0.08	0.10	0.25	0.12	0.15	0.25	0.26	0.10	0.20	0.21
Crit Moves:	****			****			****			****		

Santa Ana Circulation Element

Level Of Service Computation Report

ICU 1(Loss as Cycle Length %) Method (Base Volume Alternative)

Intersection #22 Fairview St and Edinger Ave

Cycle (sec): 100 Critical Vol./Cap.(X): 0.811
 Loss Time (sec): 5 Average Delay (sec/veh): xxxxxx
 Optimal Cycle: 54 Level Of Service: D

Approach:	North Bound			South Bound			East Bound			West Bound		
Movement:	L	T	R	L	T	R	L	T	R	L	T	R
Control:	Protected			Protected			Protected			Protected		
Rights:	Include			Include			Include			Include		
Min. Green:	0	0	0	0	0	0	0	0	0	0	0	0
Y+R:	4.0	4.0	4.0	4.0	4.0	4.0	4.0	4.0	4.0	4.0	4.0	4.0
Lanes:	2	0	2	1	0	0	2	0	2	1	0	0

Volume Module:

Base Vol:	188	1793	110	198	616	151	230	703	188	373	789	173
Growth Adj:	1.00	1.00	1.00	1.00	1.00	1.00	1.00	1.00	1.00	1.00	1.00	1.00
Initial Bse:	188	1793	110	198	616	151	230	703	188	373	789	173
User Adj:	1.00	1.00	1.00	1.00	1.00	1.00	1.00	1.00	1.00	1.00	1.00	1.00
PHF Adj:	1.00	1.00	1.00	1.00	1.00	1.00	1.00	1.00	1.00	1.00	1.00	1.00
PHF Volume:	188	1793	110	198	616	151	230	703	188	373	789	173
Reduct Vol:	0	0	0	0	0	0	0	0	0	0	0	0
Reduced Vol:	188	1793	110	198	616	151	230	703	188	373	789	173
PCE Adj:	1.00	1.00	1.00	1.00	1.00	1.00	1.00	1.00	1.00	1.00	1.00	1.00
MLF Adj:	1.00	1.00	1.00	1.00	1.00	1.00	1.00	1.00	1.00	1.00	1.00	1.00
FinalVolume:	188	1793	110	198	616	151	230	703	188	373	789	173

Saturation Flow Module:

Sat/Lane:	1600	1600	1600	1600	1600	1600	1600	1600	1600	1600	1600	1600
Adjustment:	1.00	1.04	1.00	1.00	1.05	1.00	1.00	1.05	1.00	1.00	1.05	1.00
Lanes:	2.00	2.83	0.17	2.00	2.41	0.59	2.00	2.37	0.63	2.00	2.46	0.54
Final Sat.:	3200	4723	277	3200	4055	945	3200	3987	1013	3200	4137	863

Capacity Analysis Module:

Vol/Sat:	0.06	0.38	0.40	0.06	0.15	0.16	0.07	0.18	0.19	0.12	0.19	0.20
Crit Moves:			****	****					****	****		

Santa Ana Circulation Element

Level Of Service Computation Report

ICU 1(Loss as Cycle Length %) Method (Base Volume Alternative)

Intersection #23 Fairview St and Warner Ave

Cycle (sec): 100 Critical Vol./Cap.(X): 0.845
 Loss Time (sec): 5 Average Delay (sec/veh): xxxxxx
 Optimal Cycle: 63 Level Of Service: D

Approach:	North Bound			South Bound			East Bound			West Bound		
Movement:	L	T	R	L	T	R	L	T	R	L	T	R
Control:	Protected			Protected			Protected			Protected		
Rights:	Include			Include			Include			Include		
Min. Green:	0	0	0	0	0	0	0	0	0	0	0	0
Y+R:	4.0	4.0	4.0	4.0	4.0	4.0	4.0	4.0	4.0	4.0	4.0	4.0
Lanes:	2	0	2	1	0	0	2	0	2	1	0	0

Volume Module:

Base Vol:	217	1728	161	188	951	96	197	955	148	188	1108	240
Growth Adj:	1.00	1.00	1.00	1.00	1.00	1.00	1.00	1.00	1.00	1.00	1.00	1.00
Initial Bse:	217	1728	161	188	951	96	197	955	148	188	1108	240
User Adj:	1.00	1.00	1.00	1.00	1.00	1.00	1.00	1.00	1.00	1.00	1.00	1.00
PHF Adj:	1.00	1.00	1.00	1.00	1.00	1.00	1.00	1.00	1.00	1.00	1.00	1.00
PHF Volume:	217	1728	161	188	951	96	197	955	148	188	1108	240
Reduct Vol:	0	0	0	0	0	0	0	0	0	0	0	0
Reduced Vol:	217	1728	161	188	951	96	197	955	148	188	1108	240
PCE Adj:	1.00	1.00	1.00	1.00	1.00	1.00	1.00	1.00	1.00	1.00	1.00	1.00
MLF Adj:	1.00	1.00	1.00	1.00	1.00	1.00	1.00	1.00	1.00	1.00	1.00	1.00
FinalVolume:	217	1728	161	188	951	96	197	955	148	188	1108	240

Saturation Flow Module:

Sat/Lane:	1600	1600	1600	1600	1600	1600	1600	1600	1600	1600	1600	1600
Adjustment:	1.00	1.05	1.00	1.00	1.05	1.00	1.00	1.05	1.00	1.00	1.05	1.00
Lanes:	2.00	2.74	0.26	2.00	2.72	0.28	2.00	2.60	0.40	2.00	2.47	0.53
Final Sat.:	3200	4591	409	3200	4560	440	3200	4356	644	3200	4145	855

Capacity Analysis Module:

Vol/Sat:	0.07	0.38	0.39	0.06	0.21	0.22	0.06	0.22	0.23	0.06	0.27	0.28
Crit Moves:			****	****			****			****		

Santa Ana Circulation Element

Level Of Service Computation Report

ICU 1(Loss as Cycle Length %) Method (Base Volume Alternative)

Intersection #24 Fairview St and MacArthur Blvd

Cycle (sec): 100 Critical Vol./Cap.(X): 0.826
 Loss Time (sec): 5 Average Delay (sec/veh): xxxxxx
 Optimal Cycle: 58 Level Of Service: D

Approach:	North Bound			South Bound			East Bound			West Bound		
Movement:	L	T	R	L	T	R	L	T	R	L	T	R
Control:	Protected			Protected			Protected			Protected		
Rights:	Include			Include			Include			Include		
Min. Green:	0	0	0	0	0	0	0	0	0	0	0	0
Y+R:	4.0	4.0	4.0	4.0	4.0	4.0	4.0	4.0	4.0	4.0	4.0	4.0
Lanes:	2	0	2	1	0	0	2	0	3	0	1	0

Volume Module:

Base Vol:	243	1672	91	171	955	88	280	731	246	179	1365	239
Growth Adj:	1.00	1.00	1.00	1.00	1.00	1.00	1.00	1.00	1.00	1.00	1.00	1.00
Initial Bse:	243	1672	91	171	955	88	280	731	246	179	1365	239
User Adj:	1.00	1.00	1.00	1.00	1.00	1.00	1.00	1.00	1.00	1.00	1.00	1.00
PHF Adj:	1.00	1.00	1.00	1.00	1.00	1.00	1.00	1.00	1.00	1.00	1.00	1.00
PHF Volume:	243	1672	91	171	955	88	280	731	246	179	1365	239
Reduct Vol:	0	0	0	0	0	0	0	0	0	0	0	0
Reduced Vol:	243	1672	91	171	955	88	280	731	246	179	1365	239
PCE Adj:	1.00	1.00	1.00	1.00	1.00	1.00	1.00	1.00	1.00	1.00	1.00	1.00
MLF Adj:	1.00	1.00	1.00	1.00	1.00	1.00	1.00	1.00	1.00	1.00	1.00	1.00
FinalVolume:	243	1672	91	171	955	88	280	731	246	179	1365	239

Saturation Flow Module:

Sat/Lane:	1600	1600	1600	1600	1600	1600	1600	1600	1600	1600	1600	1600
Adjustment:	1.00	1.04	1.00	1.00	1.06	1.00	1.00	1.06	1.00	1.00	1.06	1.00
Lanes:	2.00	2.85	0.15	2.00	3.00	1.00	2.00	3.00	1.00	2.00	3.00	1.00
Final Sat.:	3200	4752	248	3200	5100	1600	3200	5100	1600	3200	5100	1600

Capacity Analysis Module:

Vol/Sat:	0.08	0.35	0.37	0.05	0.19	0.06	0.09	0.14	0.15	0.06	0.27	0.15
Crit Moves:			****	****			****			****		

Santa Ana Circulation Element

Level Of Service Computation Report

ICU 1(Loss as Cycle Length %) Method (Base Volume Alternative)

Intersection #25 Fairview Rd and Sunflower Ave

Cycle (sec): 100 Critical Vol./Cap.(X): 0.708
 Loss Time (sec): 5 Average Delay (sec/veh): xxxxxx
 Optimal Cycle: 38 Level Of Service: C

Approach:	North Bound			South Bound			East Bound			West Bound		
Movement:	L	T	R	L	T	R	L	T	R	L	T	R
Control:	Protected			Protected			Protected			Protected		
Rights:	Include			Include			Include			Include		
Min. Green:	0	0	0	0	0	0	0	0	0	0	0	0
Y+R:	4.0	4.0	4.0	4.0	4.0	4.0	4.0	4.0	4.0	4.0	4.0	4.0
Lanes:	2	0	3	0	1	1	0	2	1	1	0	2

Volume Module:

Base Vol:	201	1806	393	144	1196	83	203	430	95	265	664	173
Growth Adj:	1.00	1.00	1.00	1.00	1.00	1.00	1.00	1.00	1.00	1.00	1.00	1.00
Initial Bse:	201	1806	393	144	1196	83	203	430	95	265	664	173
User Adj:	1.00	1.00	1.00	1.00	1.00	1.00	1.00	1.00	1.00	1.00	1.00	1.00
PHF Adj:	1.00	1.00	1.00	1.00	1.00	1.00	1.00	1.00	1.00	1.00	1.00	1.00
PHF Volume:	201	1806	393	144	1196	83	203	430	95	265	664	173
Reduct Vol:	0	0	0	0	0	0	0	0	0	0	0	0
Reduced Vol:	201	1806	393	144	1196	83	203	430	95	265	664	173
PCE Adj:	1.00	1.00	1.00	1.00	1.00	1.00	1.00	1.00	1.00	1.00	1.00	1.00
MLF Adj:	1.00	1.00	1.00	1.00	1.00	1.00	1.00	1.00	1.00	1.00	1.00	1.00
FinalVolume:	201	1806	393	144	1196	83	203	430	95	265	664	173

Saturation Flow Module:

Sat/Lane:	1600	1600	1600	1600	1600	1600	1600	1600	1600	1600	1600	1600
Adjustment:	1.00	1.06	1.00	1.00	1.04	1.00	1.00	1.04	1.00	1.00	1.06	1.00
Lanes:	2.00	3.00	1.00	2.00	2.81	0.19	2.00	1.64	0.36	2.00	2.00	1.00
Final Sat.:	3200	5100	1600	3200	4689	311	3200	2721	579	3200	3400	1600

Capacity Analysis Module:

Vol/Sat:	0.06	0.35	0.25	0.05	0.26	0.27	0.06	0.16	0.16	0.08	0.20	0.11
Crit Moves:	****			****			****			****		

Santa Ana Circulation Element

Level Of Service Computation Report

ICU 1(Loss as Cycle Length %) Method (Base Volume Alternative)

Intersection #26 Greenville St and Edinger Ave

Cycle (sec): 100 Critical Vol./Cap.(X): 0.586
 Loss Time (sec): 5 Average Delay (sec/veh): xxxxxx
 Optimal Cycle: 28 Level Of Service: A

Approach:	North Bound			South Bound			East Bound			West Bound		
Movement:	L	T	R	L	T	R	L	T	R	L	T	R
Control:	Split Phase			Split Phase			Protected			Protected		
Rights:	Include			Include			Include			Include		
Min. Green:	0	0	0	0	0	0	0	0	0	0	0	0
Y+R:	4.0	4.0	4.0	4.0	4.0	4.0	4.0	4.0	4.0	4.0	4.0	4.0
Lanes:	1	0	0	0	0	0	0	0	2	1	0	0

Volume Module:

Base Vol:	327	0	218	0	0	0	0	982	200	95	1128	0
Growth Adj:	1.00	1.00	1.00	1.00	1.00	1.00	1.00	1.00	1.00	1.00	1.00	1.00
Initial Bse:	327	0	218	0	0	0	0	982	200	95	1128	0
User Adj:	1.00	1.00	1.00	1.00	1.00	1.00	1.00	1.00	1.00	1.00	1.00	1.00
PHF Adj:	1.00	1.00	1.00	1.00	1.00	1.00	1.00	1.00	1.00	1.00	1.00	1.00
PHF Volume:	327	0	218	0	0	0	0	982	200	95	1128	0
Reduct Vol:	0	0	0	0	0	0	0	0	0	0	0	0
Reduced Vol:	327	0	218	0	0	0	0	982	200	95	1128	0
PCE Adj:	1.00	1.00	1.00	1.00	1.00	1.00	1.00	1.00	1.00	1.00	1.00	1.00
MLF Adj:	1.00	1.00	1.00	1.00	1.00	1.00	1.00	1.00	1.00	1.00	1.00	1.00
FinalVolume:	327	0	218	0	0	0	0	982	200	95	1128	0

Saturation Flow Module:

Sat/Lane:	1600	1600	1600	1600	1600	1600	1600	1600	1600	1600	1600	1600
Adjustment:	1.00	1.06	1.00	1.00	1.06	1.00	1.00	1.05	1.00	1.00	1.06	1.00
Lanes:	1.00	0.00	1.00	0.00	0.00	0.00	0.00	2.49	0.51	1.00	2.00	0.00
Final Sat.:	1600	0	1600	0	0	0	0	4188	812	1600	3400	0

Capacity Analysis Module:

Vol/Sat:	0.20	0.00	0.14	0.00	0.00	0.00	0.00	0.23	0.25	0.06	0.33	0.00
Crit Moves:	****						****			****		

Santa Ana Circulation Element

Level Of Service Computation Report

ICU 1(Loss as Cycle Length %) Method (Base Volume Alternative)

Intersection #27 Greenville St and Segerstrom Ave

Cycle (sec): 100 Critical Vol./Cap.(X): 0.686
 Loss Time (sec): 5 Average Delay (sec/veh): xxxxxx
 Optimal Cycle: 36 Level Of Service: B

Approach:	North Bound			South Bound			East Bound			West Bound		
Movement:	L	T	R	L	T	R	L	T	R	L	T	R
Control:	Permitted			Permitted			Permitted			Permitted		
Rights:	Include			Include			WideBypass			WideBypass		
Min. Green:	0	0	0	0	0	0	0	0	0	0	0	0
Y+R:	4.0	4.0	4.0	4.0	4.0	4.0	4.0	4.0	4.0	4.0	4.0	4.0
Lanes:	1	0	1	1	0	1	1	0	1	1	0	1

Volume Module:

Base Vol:	57	476	36	61	200	61	108	823	47	27	1037	148
Growth Adj:	1.00	1.00	1.00	1.00	1.00	1.00	1.00	1.00	1.00	1.00	1.00	1.00
Initial Bse:	57	476	36	61	200	61	108	823	47	27	1037	148
User Adj:	1.00	1.00	1.00	1.00	1.00	1.00	1.00	1.00	1.00	1.00	1.00	1.00
PHF Adj:	1.00	1.00	1.00	1.00	1.00	1.00	1.00	1.00	1.00	1.00	1.00	1.00
PHF Volume:	57	476	36	61	200	61	108	823	47	27	1037	148
Reduct Vol:	0	0	0	0	0	0	0	0	0	0	0	0
Reduced Vol:	57	476	36	61	200	61	108	823	47	27	1037	148
PCE Adj:	1.00	1.00	1.00	1.00	1.00	1.00	1.00	1.00	1.00	1.00	1.00	1.00
MLF Adj:	1.00	1.00	1.00	1.00	1.00	1.00	1.00	1.00	1.00	1.00	1.00	1.00
FinalVolume:	57	476	36	61	200	61	108	823	47	27	1037	148

Saturation Flow Module:

Sat/Lane:	1600	1600	1600	1600	1600	1600	1600	1600	1600	1600	1600	1600
Adjustment:	1.00	1.03	1.00	1.00	1.06	1.00	1.00	1.03	1.00	1.00	1.04	1.00
Lanes:	1.00	1.86	0.14	1.00	1.00	1.00	1.00	1.89	0.11	1.00	1.75	0.25
Final Sat.:	1600	3075	225	1600	1700	1600	1600	3127	173	1600	2900	400

Capacity Analysis Module:

Vol/Sat:	0.04	0.15	0.16	0.04	0.12	0.04	0.07	0.26	0.27	0.02	0.36	0.37
Crit Moves:			****	****			****					****

Santa Ana Circulation Element

Level Of Service Computation Report

ICU 1(Loss as Cycle Length %) Method (Base Volume Alternative)

Intersection #28 Raitt St and McFadden Ave

Cycle (sec): 100 Critical Vol./Cap.(X): 0.722
 Loss Time (sec): 5 Average Delay (sec/veh): xxxxxx
 Optimal Cycle: 40 Level Of Service: C

Approach:	North Bound			South Bound			East Bound			West Bound		
Movement:	L	T	R	L	T	R	L	T	R	L	T	R
Control:	Protected			Protected			Protected			Protected		
Rights:	Include			Include			Include			Include		
Min. Green:	0	0	0	0	0	0	0	0	0	0	0	0
Y+R:	4.0	4.0	4.0	4.0	4.0	4.0	4.0	4.0	4.0	4.0	4.0	4.0
Lanes:	1	0	1	1	0	1	1	0	1	1	0	1

Volume Module:

Base Vol:	58	835	130	45	474	76	126	747	65	88	742	102
Growth Adj:	1.00	1.00	1.00	1.00	1.00	1.00	1.00	1.00	1.00	1.00	1.00	1.00
Initial Bse:	58	835	130	45	474	76	126	747	65	88	742	102
User Adj:	1.00	1.00	1.00	1.00	1.00	1.00	1.00	1.00	1.00	1.00	1.00	1.00
PHF Adj:	1.00	1.00	1.00	1.00	1.00	1.00	1.00	1.00	1.00	1.00	1.00	1.00
PHF Volume:	58	835	130	45	474	76	126	747	65	88	742	102
Reduct Vol:	0	0	0	0	0	0	0	0	0	0	0	0
Reduced Vol:	58	835	130	45	474	76	126	747	65	88	742	102
PCE Adj:	1.00	1.00	1.00	1.00	1.00	1.00	1.00	1.00	1.00	1.00	1.00	1.00
MLF Adj:	1.00	1.00	1.00	1.00	1.00	1.00	1.00	1.00	1.00	1.00	1.00	1.00
FinalVolume:	58	835	130	45	474	76	126	747	65	88	742	102

Saturation Flow Module:

Sat/Lane:	1600	1600	1600	1600	1600	1600	1600	1600	1600	1600	1600	1600
Adjustment:	1.00	1.04	1.00	1.00	1.04	1.00	1.00	1.03	1.00	1.00	1.04	1.00
Lanes:	1.00	1.73	0.27	1.00	1.72	0.28	1.00	1.84	0.16	1.00	1.76	0.24
Final Sat.:	1600	2869	431	1600	2858	442	1600	3044	256	1600	2913	387

Capacity Analysis Module:

Vol/Sat:	0.04	0.29	0.30	0.03	0.17	0.17	0.08	0.25	0.25	0.06	0.25	0.26
Crit Moves:			****	****			****			****		

Santa Ana Circulation Element

Level Of Service Computation Report

ICU 1(Loss as Cycle Length %) Method (Base Volume Alternative)

Intersection #29 Raitt St and Edinger Ave

Cycle (sec): 100 Critical Vol./Cap.(X): 0.864
 Loss Time (sec): 5 Average Delay (sec/veh): xxxxxx
 Optimal Cycle: 70 Level Of Service: D

Approach:	North Bound			South Bound			East Bound			West Bound		
Movement:	L	T	R	L	T	R	L	T	R	L	T	R
Control:	Protected			Protected			Protected			Protected		
Rights:	Include			Include			WideBypass			Include		
Min. Green:	0	0	0	0	0	0	0	0	0	0	0	0
Y+R:	4.0	4.0	4.0	4.0	4.0	4.0	4.0	4.0	4.0	4.0	4.0	4.0
Lanes:	1	0	1	1	0	1	1	0	1	1	0	1

Volume Module:

Base Vol:	190	816	229	111	384	96	139	961	137	86	972	87
Growth Adj:	1.00	1.00	1.00	1.00	1.00	1.00	1.00	1.00	1.00	1.00	1.00	1.00
Initial Bse:	190	816	229	111	384	96	139	961	137	86	972	87
User Adj:	1.00	1.00	1.00	1.00	1.00	1.00	1.00	1.00	1.00	1.00	1.00	1.00
PHF Adj:	1.00	1.00	1.00	1.00	1.00	1.00	1.00	1.00	1.00	1.00	1.00	1.00
PHF Volume:	190	816	229	111	384	96	139	961	137	86	972	87
Reduct Vol:	0	0	0	0	0	0	0	0	0	0	0	0
Reduced Vol:	190	816	229	111	384	96	139	961	137	86	972	87
PCE Adj:	1.00	1.00	1.00	1.00	1.00	1.00	1.00	1.00	1.00	1.00	1.00	1.00
MLF Adj:	1.00	1.00	1.00	1.00	1.00	1.00	1.00	1.00	1.00	1.00	1.00	1.00
FinalVolume:	190	816	229	111	384	96	139	961	137	86	972	87

Saturation Flow Module:

Sat/Lane:	1600	1600	1600	1600	1600	1600	1600	1600	1600	1600	1600	1600
Adjustment:	1.00	1.04	1.00	1.00	1.04	1.00	1.00	1.04	1.00	1.00	1.03	1.00
Lanes:	1.00	1.56	0.44	1.00	1.60	0.40	1.00	1.75	0.25	1.00	1.84	0.16
Final Sat.:	1600	2599	701	1600	2660	640	1600	2901	399	1600	3037	263

Capacity Analysis Module:

Vol/Sat:	0.12	0.31	0.33	0.07	0.14	0.15	0.09	0.33	0.34	0.05	0.32	0.33
Crit Moves:			****	****			****					****

Santa Ana Circulation Element

Level Of Service Computation Report

ICU 1(Loss as Cycle Length %) Method (Base Volume Alternative)

Intersection #30 Bear St and MacArthur Blvd

Cycle (sec): 100 Critical Vol./Cap.(X): 0.868
 Loss Time (sec): 5 Average Delay (sec/veh): xxxxxx
 Optimal Cycle: 71 Level Of Service: D

Approach:	North Bound			South Bound			East Bound			West Bound		
Movement:	L	T	R	L	T	R	L	T	R	L	T	R
Control:	Protected			Protected			Protected			Protected		
Rights:	Include			Include			Include			Include		
Min. Green:	0	0	0	0	0	0	0	0	0	0	0	0
Y+R:	4.0	4.0	4.0	4.0	4.0	4.0	4.0	4.0	4.0	4.0	4.0	4.0
Lanes:	1	0	2	0	1	0	1	0	2	1	0	2

Volume Module:

Base Vol:	200	962	251	112	271	82	97	910	94	93	1673	266
Growth Adj:	1.00	1.00	1.00	1.00	1.00	1.00	1.00	1.00	1.00	1.00	1.00	1.00
Initial Bse:	200	962	251	112	271	82	97	910	94	93	1673	266
User Adj:	1.00	1.00	1.00	1.00	1.00	1.00	1.00	1.00	1.00	1.00	1.00	1.00
PHF Adj:	1.00	1.00	1.00	1.00	1.00	1.00	1.00	1.00	1.00	1.00	1.00	1.00
PHF Volume:	200	962	251	112	271	82	97	910	94	93	1673	266
Reduct Vol:	0	0	0	0	0	0	0	0	0	0	0	0
Reduced Vol:	200	962	251	112	271	82	97	910	94	93	1673	266
PCE Adj:	1.00	1.00	1.00	1.00	1.00	1.00	1.00	1.00	1.00	1.00	1.00	1.00
MLF Adj:	1.00	1.00	1.00	1.00	1.00	1.00	1.00	1.00	1.00	1.00	1.00	1.00
FinalVolume:	200	962	251	112	271	82	97	910	94	93	1673	266

Saturation Flow Module:

Sat/Lane:	1600	1600	1600	1600	1600	1600	1600	1600	1600	1600	1600	1600
Adjustment:	1.00	1.06	1.00	1.00	1.06	1.00	1.00	1.05	1.00	1.00	1.05	1.00
Lanes:	1.00	2.00	1.00	1.00	2.00	1.00	1.00	2.72	0.28	1.00	2.59	0.41
Final Sat.:	1600	3400	1600	1600	3400	1600	1600	4551	449	1600	4342	658

Capacity Analysis Module:

Vol/Sat:	0.13	0.28	0.16	0.07	0.08	0.05	0.06	0.20	0.21	0.06	0.39	0.40
Crit Moves:	****			****			****			****		

Santa Ana Circulation Element

Level Of Service Computation Report

ICU 1(Loss as Cycle Length %) Method (Base Volume Alternative)

Intersection #31 Bristol St and 17th St

Cycle (sec): 100 Critical Vol./Cap.(X): 0.692
 Loss Time (sec): 5 Average Delay (sec/veh): xxxxxx
 Optimal Cycle: 36 Level Of Service: B

Approach:	North Bound			South Bound			East Bound			West Bound		
Movement:	L	T	R	L	T	R	L	T	R	L	T	R
Control:	Protected			Protected			Protected			Protected		
Rights:	Include			Include			Include			Ovl		
Min. Green:	0	0	0	0	0	0	0	0	0	0	0	0
Y+R:	4.0	4.0	4.0	4.0	4.0	4.0	4.0	4.0	4.0	4.0	4.0	4.0
Lanes:	2	0	3	0	1		2	0	3	0	1	

Volume Module:

Base Vol:	236	1148	191	243	1293	220	336	750	136	284	1069	362
Growth Adj:	1.00	1.00	1.00	1.00	1.00	1.00	1.00	1.00	1.00	1.00	1.00	1.00
Initial Bse:	236	1148	191	243	1293	220	336	750	136	284	1069	362
User Adj:	1.00	1.00	1.00	1.00	1.00	1.00	1.00	1.00	1.00	1.00	1.00	1.00
PHF Adj:	1.00	1.00	1.00	1.00	1.00	1.00	1.00	1.00	1.00	1.00	1.00	1.00
PHF Volume:	236	1148	191	243	1293	220	336	750	136	284	1069	362
Reduct Vol:	0	0	0	0	0	0	0	0	0	0	0	0
Reduced Vol:	236	1148	191	243	1293	220	336	750	136	284	1069	362
PCE Adj:	1.00	1.00	1.00	1.00	1.00	1.00	1.00	1.00	1.00	1.00	1.00	1.00
MLF Adj:	1.00	1.00	1.00	1.00	1.00	1.00	1.00	1.00	1.00	1.00	1.00	1.00
FinalVolume:	236	1148	191	243	1293	220	336	750	136	284	1069	362
OvlAdjVol:												241

Saturation Flow Module:

Sat/Lane:	1600	1600	1600	1600	1600	1600	1600	1600	1600	1600	1600	1600
Adjustment:	1.00	1.06	1.00	1.00	1.06	1.00	1.00	1.05	1.00	1.00	1.06	1.00
Lanes:	2.00	3.00	1.00	2.00	3.00	1.00	2.00	2.54	0.46	2.00	3.00	1.00
Final Sat.:	3200	5100	1600	3200	5100	1600	3200	4263	737	3200	5100	1600

Capacity Analysis Module:

Vol/Sat:	0.07	0.23	0.12	0.08	0.25	0.14	0.11	0.18	0.18	0.09	0.21	0.23	
OvlAdjV/S:												0.15	
Crit Moves:	****						****	****					****

Santa Ana Circulation Element

Level Of Service Computation Report

ICU 1(Loss as Cycle Length %) Method (Base Volume Alternative)

Intersection #32 Bristol St and Civic Center Dr

Cycle (sec): 100 Critical Vol./Cap.(X): 0.832
 Loss Time (sec): 5 Average Delay (sec/veh): xxxxxx
 Optimal Cycle: 60 Level Of Service: D

Approach:	North Bound			South Bound			East Bound			West Bound		
Movement:	L	T	R	L	T	R	L	T	R	L	T	R
Control:	Protected			Protected			Prot+Permit			Prot+Permit		
Rights:	Include			Include			Include			Include		
Min. Green:	0	0	0	0	0	0	0	0	0	0	0	0
Y+R:	4.0	4.0	4.0	4.0	4.0	4.0	4.0	4.0	4.0	4.0	4.0	4.0
Lanes:	1	0	2	1	0	2	1	0	1	1	0	1

Volume Module:

Base Vol:	200	1399	73	136	1250	128	190	534	63	169	723	82
Growth Adj:	1.00	1.00	1.00	1.00	1.00	1.00	1.00	1.00	1.00	1.00	1.00	1.00
Initial Bse:	200	1399	73	136	1250	128	190	534	63	169	723	82
User Adj:	1.00	1.00	1.00	1.00	1.00	1.00	1.00	1.00	1.00	1.00	1.00	1.00
PHF Adj:	1.00	1.00	1.00	1.00	1.00	1.00	1.00	1.00	1.00	1.00	1.00	1.00
PHF Volume:	200	1399	73	136	1250	128	190	534	63	169	723	82
Reduct Vol:	0	0	0	0	0	0	0	0	0	0	0	0
Reduced Vol:	200	1399	73	136	1250	128	190	534	63	169	723	82
PCE Adj:	1.00	1.00	1.00	1.00	1.00	1.00	1.00	1.00	1.00	1.00	1.00	1.00
MLF Adj:	1.00	1.00	1.00	1.00	1.00	1.00	1.00	1.00	1.00	1.00	1.00	1.00
FinalVolume:	200	1399	73	136	1250	128	190	534	63	169	723	82

Saturation Flow Module:

Sat/Lane:	1600	1600	1600	1600	1600	1600	1600	1600	1600	1600	1600	1600
Adjustment:	1.00	1.04	1.00	1.00	1.05	1.00	1.00	1.03	1.00	1.00	1.03	1.00
Lanes:	1.00	2.85	0.15	1.00	2.72	0.28	1.00	1.79	0.21	1.00	1.80	0.20
Final Sat.:	1600	4762	238	1600	4554	446	1600	2962	338	1600	2974	326

Capacity Analysis Module:

Vol/Sat:	0.13	0.29	0.31	0.09	0.27	0.29	0.12	0.18	0.19	0.11	0.24	0.25
Crit Moves:	****					****	****					****

Santa Ana Circulation Element

Level Of Service Computation Report

ICU 1(Loss as Cycle Length %) Method (Base Volume Alternative)

Intersection #33 Bristol St and Santa Ana Blvd

Cycle (sec): 100 Critical Vol./Cap.(X): 0.657
Loss Time (sec): 5 Average Delay (sec/veh): xxxxxx
Optimal Cycle: 33 Level Of Service: B

Table with 4 columns: North Bound, South Bound, East Bound, West Bound. Rows include Movement (L-T-R), Control, Rights, Min. Green, Y+R, and Lanes.

Volume Module: Table with 12 columns representing different volume categories and 11 rows of adjustment factors like Growth Adj, Initial Bse, User Adj, etc.

Saturation Flow Module: Table with 12 columns and 4 rows showing Sat/Lane, Adjustment, Lanes, and Final Sat.

Capacity Analysis Module: Table with 12 columns and 3 rows showing Vol/Sat, Crit Moves, and asterisks for critical moves.

Santa Ana Circulation Element

Level Of Service Computation Report

ICU 1(Loss as Cycle Length %) Method (Base Volume Alternative)

Intersection #34 Bristol St and 1st St

Cycle (sec): 100 Critical Vol./Cap.(X): 0.779
 Loss Time (sec): 5 Average Delay (sec/veh): xxxxxx
 Optimal Cycle: 48 Level Of Service: C

Approach:	North Bound			South Bound			East Bound			West Bound		
Movement:	L	T	R	L	T	R	L	T	R	L	T	R
Control:	Protected			Protected			Protected			Protected		
Rights:	Include			Include			Include			Include		
Min. Green:	0	0	0	0	0	0	0	0	0	0	0	0
Y+R:	4.0	4.0	4.0	4.0	4.0	4.0	4.0	4.0	4.0	4.0	4.0	4.0
Lanes:	2	0	3	0	1		2	0	3	0	1	

Volume Module:

Base Vol:	286	1235	182	206	1115	252	189	1062	136	217	1330	126
Growth Adj:	1.00	1.00	1.00	1.00	1.00	1.00	1.00	1.00	1.00	1.00	1.00	1.00
Initial Bse:	286	1235	182	206	1115	252	189	1062	136	217	1330	126
User Adj:	1.00	1.00	1.00	1.00	1.00	1.00	1.00	1.00	1.00	1.00	1.00	1.00
PHF Adj:	1.00	1.00	1.00	1.00	1.00	1.00	1.00	1.00	1.00	1.00	1.00	1.00
PHF Volume:	286	1235	182	206	1115	252	189	1062	136	217	1330	126
Reduct Vol:	0	0	0	0	0	0	0	0	0	0	0	0
Reduced Vol:	286	1235	182	206	1115	252	189	1062	136	217	1330	126
PCE Adj:	1.00	1.00	1.00	1.00	1.00	1.00	1.00	1.00	1.00	1.00	1.00	1.00
MLF Adj:	1.00	1.00	1.00	1.00	1.00	1.00	1.00	1.00	1.00	1.00	1.00	1.00
FinalVolume:	286	1235	182	206	1115	252	189	1062	136	217	1330	126

Saturation Flow Module:

Sat/Lane:	1600	1600	1600	1600	1600	1600	1600	1600	1600	1600	1600	1600
Adjustment:	1.00	1.06	1.00	1.00	1.06	1.00	1.00	1.05	1.00	1.00	1.05	1.00
Lanes:	2.00	3.00	1.00	2.00	3.00	1.00	1.00	2.66	0.34	1.00	2.74	0.26
Final Sat.:	3200	5100	1600	3200	5100	1600	1600	4455	545	1600	4585	415

Capacity Analysis Module:

Vol/Sat:	0.09	0.24	0.11	0.06	0.22	0.16	0.12	0.24	0.25	0.14	0.29	0.30
Crit Moves:	****				****		****				****	

Santa Ana Circulation Element

Level Of Service Computation Report

ICU 1(Loss as Cycle Length %) Method (Base Volume Alternative)

Intersection #35 Bristol St and McFadden Ave

Cycle (sec): 100 Critical Vol./Cap.(X): 0.752
 Loss Time (sec): 5 Average Delay (sec/veh): xxxxxx
 Optimal Cycle: 44 Level Of Service: C

Approach:	North Bound			South Bound			East Bound			West Bound		
Movement:	L	T	R	L	T	R	L	T	R	L	T	R
Control:	Protected			Protected			Prot+Permit			Prot+Permit		
Rights:	Include			Include			Include			Include		
Min. Green:	0	0	0	0	0	0	0	0	0	0	0	0
Y+R:	4.0	4.0	4.0	4.0	4.0	4.0	4.0	4.0	4.0	4.0	4.0	4.0
Lanes:	1	0	3	0	1	1	0	1	1	0	1	1

Volume Module:

Base Vol:	213	1566	85	84	1171	270	262	512	102	97	504	59
Growth Adj:	1.00	1.00	1.00	1.00	1.00	1.00	1.00	1.00	1.00	1.00	1.00	1.00
Initial Bse:	213	1566	85	84	1171	270	262	512	102	97	504	59
User Adj:	1.00	1.00	1.00	1.00	1.00	1.00	1.00	1.00	1.00	1.00	1.00	1.00
PHF Adj:	1.00	1.00	1.00	1.00	1.00	1.00	1.00	1.00	1.00	1.00	1.00	1.00
PHF Volume:	213	1566	85	84	1171	270	262	512	102	97	504	59
Reduct Vol:	0	0	0	0	0	0	0	0	0	0	0	0
Reduced Vol:	213	1566	85	84	1171	270	262	512	102	97	504	59
PCE Adj:	1.00	1.00	1.00	1.00	1.00	1.00	1.00	1.00	1.00	1.00	1.00	1.00
MLF Adj:	1.00	1.00	1.00	1.00	1.00	1.00	1.00	1.00	1.00	1.00	1.00	1.00
FinalVolume:	213	1566	85	84	1171	270	262	512	102	97	504	59

Saturation Flow Module:

Sat/Lane:	1600	1600	1600	1600	1600	1600	1600	1600	1600	1600	1600	1600
Adjustment:	1.00	1.06	1.00	1.00	1.06	1.00	1.00	1.04	1.00	1.00	1.03	1.00
Lanes:	1.00	3.00	1.00	1.00	3.00	1.00	1.00	1.67	0.33	1.00	1.79	0.21
Final Sat.:	1600	5100	1600	1600	5100	1600	1600	2768	532	1600	2965	335

Capacity Analysis Module:

Vol/Sat:	0.13	0.31	0.05	0.05	0.23	0.17	0.16	0.18	0.19	0.06	0.17	0.18
Crit Moves:	****				****		****				****	

Santa Ana Circulation Element

Level Of Service Computation Report

ICU 1(Loss as Cycle Length %) Method (Base Volume Alternative)

Intersection #36 Bristol St and Warner Ave

Cycle (sec): 100 Critical Vol./Cap.(X): 0.790
 Loss Time (sec): 5 Average Delay (sec/veh): xxxxxx
 Optimal Cycle: 50 Level Of Service: C

Approach:	North Bound			South Bound			East Bound			West Bound		
Movement:	L	T	R	L	T	R	L	T	R	L	T	R
Control:	Protected			Protected			Protected			Protected		
Rights:	Include			Include			Include			Include		
Min. Green:	0	0	0	0	0	0	0	0	0	0	0	0
Y+R:	4.0	4.0	4.0	4.0	4.0	4.0	4.0	4.0	4.0	4.0	4.0	4.0
Lanes:	2	0	2	0	2	1	0	1	0	3	0	1

Volume Module:

Base Vol:	309	1157	211	251	838	163	193	868	153	173	1021	299
Growth Adj:	1.00	1.00	1.00	1.00	1.00	1.00	1.00	1.00	1.00	1.00	1.00	1.00
Initial Bse:	309	1157	211	251	838	163	193	868	153	173	1021	299
User Adj:	1.00	1.00	1.00	1.00	1.00	1.00	1.00	1.00	1.00	1.00	1.00	1.00
PHF Adj:	1.00	1.00	1.00	1.00	1.00	1.00	1.00	1.00	1.00	1.00	1.00	1.00
PHF Volume:	309	1157	211	251	838	163	193	868	153	173	1021	299
Reduct Vol:	0	0	0	0	0	0	0	0	0	0	0	0
Reduced Vol:	309	1157	211	251	838	163	193	868	153	173	1021	299
PCE Adj:	1.00	1.00	1.00	1.00	1.00	1.00	1.00	1.00	1.00	1.00	1.00	1.00
MLF Adj:	1.00	1.00	1.00	1.00	1.00	1.00	1.00	1.00	1.00	1.00	1.00	1.00
FinalVolume:	309	1157	211	251	838	163	193	868	153	173	1021	299

Saturation Flow Module:

Sat/Lane:	1600	1600	1600	1600	1600	1600	1600	1600	1600	1600	1600	1600
Adjustment:	1.00	1.06	1.00	1.00	1.05	1.00	1.00	1.06	1.00	1.00	1.06	1.00
Lanes:	2.00	2.00	1.00	2.00	2.51	0.49	1.00	3.00	1.00	1.00	3.00	1.00
Final Sat.:	3200	3400	1600	3200	4218	782	1600	5100	1600	1600	5100	1600

Capacity Analysis Module:

Vol/Sat:	0.10	0.34	0.13	0.08	0.20	0.21	0.12	0.17	0.10	0.11	0.20	0.19
Crit Moves:	****			****			****			****		

Santa Ana Circulation Element

Level Of Service Computation Report

ICU 1(Loss as Cycle Length %) Method (Base Volume Alternative)

Intersection #37 Bristol St and Segerstrom Ave

Cycle (sec): 100 Critical Vol./Cap.(X): 0.909
 Loss Time (sec): 5 Average Delay (sec/veh): xxxxxx
 Optimal Cycle: 92 Level Of Service: E

Approach:	North Bound			South Bound			East Bound			West Bound		
Movement:	L	T	R	L	T	R	L	T	R	L	T	R
Control:	Protected			Protected			Protected			Protected		
Rights:	WideBypass			Include			Include			Include		
Min. Green:	0	0	0	0	0	0	0	0	0	0	0	0
Y+R:	4.0	4.0	4.0	4.0	4.0	4.0	4.0	4.0	4.0	4.0	4.0	4.0
Lanes:	1	0	2	1	0	2	1	0	1	1	0	1

Volume Module:

Base Vol:	179	1322	233	92	843	176	200	716	57	119	1074	54
Growth Adj:	1.00	1.00	1.00	1.00	1.00	1.00	1.00	1.00	1.00	1.00	1.00	1.00
Initial Bse:	179	1322	233	92	843	176	200	716	57	119	1074	54
User Adj:	1.00	1.00	1.00	1.00	1.00	1.00	1.00	1.00	1.00	1.00	1.00	1.00
PHF Adj:	1.00	1.00	1.00	1.00	1.00	1.00	1.00	1.00	1.00	1.00	1.00	1.00
PHF Volume:	179	1322	233	92	843	176	200	716	57	119	1074	54
Reduct Vol:	0	0	0	0	0	0	0	0	0	0	0	0
Reduced Vol:	179	1322	233	92	843	176	200	716	57	119	1074	54
PCE Adj:	1.00	1.00	1.00	1.00	1.00	1.00	1.00	1.00	1.00	1.00	1.00	1.00
MLF Adj:	1.00	1.00	1.00	1.00	1.00	1.00	1.00	1.00	1.00	1.00	1.00	1.00
FinalVolume:	179	1322	233	92	843	176	200	716	57	119	1074	54

Saturation Flow Module:

Sat/Lane:	1600	1600	1600	1600	1600	1600	1600	1600	1600	1600	1600	1600
Adjustment:	1.00	1.05	1.00	1.00	1.05	1.00	1.00	1.03	1.00	1.00	1.03	1.00
Lanes:	1.00	2.55	0.45	1.00	2.48	0.52	1.00	1.85	0.15	1.00	1.90	0.10
Final Sat.:	1600	4281	719	1600	4171	829	1600	3064	236	1600	3147	153

Capacity Analysis Module:

Vol/Sat:	0.11	0.31	0.32	0.06	0.20	0.21	0.13	0.23	0.24	0.07	0.34	0.35
Crit Moves:			****	****			****			****		

Santa Ana Circulation Element

Level Of Service Computation Report

ICU 1(Loss as Cycle Length %) Method (Base Volume Alternative)

Intersection #38 Bristol St and Alton Ave

Cycle (sec): 100 Critical Vol./Cap.(X): 0.686
 Loss Time (sec): 5 Average Delay (sec/veh): xxxxxx
 Optimal Cycle: 36 Level Of Service: B

Approach:	North Bound			South Bound			East Bound			West Bound		
Movement:	L	T	R	L	T	R	L	T	R	L	T	R
Control:	Protected			Protected			Permitted			Permitted		
Rights:	WideBypass			Include			Include			Include		
Min. Green:	0	0	0	0	0	0	0	0	0	0	0	0
Y+R:	4.0	4.0	4.0	4.0	4.0	4.0	4.0	4.0	4.0	4.0	4.0	4.0
Lanes:	1	0	2	1	0	3	1	0	1	1	0	1

Volume Module:

Base Vol:	43	1681	158	119	896	56	75	105	195	91	150	29
Growth Adj:	1.00	1.00	1.00	1.00	1.00	1.00	1.00	1.00	1.00	1.00	1.00	1.00
Initial Bse:	43	1681	158	119	896	56	75	105	195	91	150	29
User Adj:	1.00	1.00	1.00	1.00	1.00	1.00	1.00	1.00	1.00	1.00	1.00	1.00
PHF Adj:	1.00	1.00	1.00	1.00	1.00	1.00	1.00	1.00	1.00	1.00	1.00	1.00
PHF Volume:	43	1681	158	119	896	56	75	105	195	91	150	29
Reduct Vol:	0	0	0	0	0	0	0	0	0	0	0	0
Reduced Vol:	43	1681	158	119	896	56	75	105	195	91	150	29
PCE Adj:	1.00	1.00	1.00	1.00	1.00	1.00	1.00	1.00	1.00	1.00	1.00	1.00
MLF Adj:	1.00	1.00	1.00	1.00	1.00	1.00	1.00	1.00	1.00	1.00	1.00	1.00
FinalVolume:	43	1681	158	119	896	56	75	105	195	91	150	29

Saturation Flow Module:

Sat/Lane:	1600	1600	1600	1600	1600	1600	1600	1600	1600	1600	1600	1600
Adjustment:	1.00	1.05	1.00	1.00	1.06	1.00	1.00	1.06	1.00	1.00	1.00	1.00
Lanes:	1.00	2.74	0.26	1.00	3.00	1.00	1.00	1.00	1.00	1.00	0.84	0.16
Final Sat.:	1600	4588	412	1600	5100	1600	1600	1700	1600	1600	1341	259

Capacity Analysis Module:

Vol/Sat:	0.03	0.37	0.38	0.07	0.18	0.04	0.05	0.06	0.12	0.06	0.11	0.11
Crit Moves:			****	****					****	****		

Santa Ana Circulation Element

Level Of Service Computation Report

ICU 1(Loss as Cycle Length %) Method (Base Volume Alternative)

Intersection #39 Bristol St and MacArthur Blvd

Cycle (sec): 100 Critical Vol./Cap.(X): 0.812
 Loss Time (sec): 5 Average Delay (sec/veh): xxxxxx
 Optimal Cycle: 55 Level Of Service: D

Approach:	North Bound			South Bound			East Bound			West Bound								
Movement:	L	T	R	L	T	R	L	T	R	L	T	R						
Control:	Protected			Protected			Protected			Protected								
Rights:	Include			Include			Include			Include								
Min. Green:	0	0	0	0	0	0	0	0	0	0	0	0						
Y+R:	4.0	4.0	4.0	4.0	4.0	4.0	4.0	4.0	4.0	4.0	4.0	4.0						
Lanes:	2	0	3	0	1		2	0	2	1	0		2	0	3	0	1	

Volume Module:

Base Vol:	335	1428	260	223	821	129	357	796	169	265	1536	290
Growth Adj:	1.00	1.00	1.00	1.00	1.00	1.00	1.00	1.00	1.00	1.00	1.00	1.00
Initial Bse:	335	1428	260	223	821	129	357	796	169	265	1536	290
User Adj:	1.00	1.00	1.00	1.00	1.00	1.00	1.00	1.00	1.00	1.00	1.00	1.00
PHF Adj:	1.00	1.00	1.00	1.00	1.00	1.00	1.00	1.00	1.00	1.00	1.00	1.00
PHF Volume:	335	1428	260	223	821	129	357	796	169	265	1536	290
Reduct Vol:	0	0	0	0	0	0	0	0	0	0	0	0
Reduced Vol:	335	1428	260	223	821	129	357	796	169	265	1536	290
PCE Adj:	1.00	1.00	1.00	1.00	1.00	1.00	1.00	1.00	1.00	1.00	1.00	1.00
MLF Adj:	1.00	1.00	1.00	1.00	1.00	1.00	1.00	1.00	1.00	1.00	1.00	1.00
FinalVolume:	335	1428	260	223	821	129	357	796	169	265	1536	290

Saturation Flow Module:

Sat/Lane:	1600	1600	1600	1600	1600	1600	1600	1600	1600	1600	1600	1600
Adjustment:	1.00	1.06	1.00	1.00	1.05	1.00	1.00	1.06	1.00	1.00	1.06	1.00
Lanes:	2.00	3.00	1.00	2.00	2.59	0.41	2.00	3.00	1.00	2.00	3.00	1.00
Final Sat.:	3200	5100	1600	3200	4348	652	3200	5100	1600	3200	5100	1600

Capacity Analysis Module:

Vol/Sat:	0.10	0.28	0.16	0.07	0.19	0.20	0.11	0.16	0.11	0.08	0.30	0.18
Crit Moves:	****			****			****			****		

Santa Ana Circulation Element

Level Of Service Computation Report

ICU 1(Loss as Cycle Length %) Method (Base Volume Alternative)

Intersection #40 Bristol St and Sunflower Ave

Cycle (sec): 100 Critical Vol./Cap.(X): 0.689
 Loss Time (sec): 5 Average Delay (sec/veh): xxxxxx
 Optimal Cycle: 36 Level Of Service: B

Approach:	North Bound			South Bound			East Bound			West Bound												
Movement:	L	T	R	L	T	R	L	T	R	L	T	R										
Control:	Protected			Protected			Protected			Protected												
Rights:	Include			Include			Include			Include												
Min. Green:	0	0	0	0	0	0	0	0	0	0	0	0										
Y+R:	4.0	4.0	4.0	4.0	4.0	4.0	4.0	4.0	4.0	4.0	4.0	4.0										
Lanes:	2	0	2	1	1		2	0	3	0	1		2	0	2	1	1	2	0	3	0	1

Volume Module:

Base Vol:	645	1363	220	201	750	215	293	573	222	263	1012	322
Growth Adj:	1.00	1.00	1.00	1.00	1.00	1.00	1.00	1.00	1.00	1.00	1.00	1.00
Initial Bse:	645	1363	220	201	750	215	293	573	222	263	1012	322
User Adj:	1.00	1.00	1.00	1.00	1.00	1.00	1.00	1.00	1.00	1.00	1.00	1.00
PHF Adj:	1.00	1.00	1.00	1.00	1.00	1.00	1.00	1.00	1.00	1.00	1.00	1.00
PHF Volume:	645	1363	220	201	750	215	293	573	222	263	1012	322
Reduct Vol:	0	0	0	0	0	0	0	0	0	0	0	0
Reduced Vol:	645	1363	220	201	750	215	293	573	222	263	1012	322
PCE Adj:	1.00	1.00	1.00	1.00	1.00	1.00	1.00	1.00	1.00	1.00	1.00	1.00
MLF Adj:	1.00	1.00	1.00	1.00	1.00	1.00	1.00	1.00	1.00	1.00	1.00	1.00
FinalVolume:	645	1363	220	201	750	215	293	573	222	263	1012	322

Saturation Flow Module:

Sat/Lane:	1600	1600	1600	1600	1600	1600	1600	1600	1600	1600	1600	1600
Adjustment:	1.00	1.06	1.00	1.00	1.06	1.00	1.00	1.04	1.00	1.00	1.06	1.00
Lanes:	2.00	3.00	1.00	2.00	3.00	1.00	2.00	2.88	1.12	2.00	3.00	1.00
Final Sat.:	3200	5100	1600	3200	5100	1600	3200	4813	1787	3200	5100	1600

Capacity Analysis Module:

Vol/Sat:	0.20	0.27	0.14	0.06	0.15	0.13	0.09	0.12	0.12	0.08	0.20	0.20
Crit Moves:	****				****		****				****	

Santa Ana Circulation Element

Level Of Service Computation Report
 2000 HCM Operations Method (Base Volume Alternative)

 Intersection #41 Bristol St and I-405 WB Ramps

Cycle (sec): 100 Critical Vol./Cap.(X): 0.829
 Loss Time (sec): 5 Average Delay (sec/veh): 28.2
 Optimal Cycle: 61 Level Of Service: C

Approach:	North Bound			South Bound			East Bound			West Bound		
Movement:	L	T	R	L	T	R	L	T	R	L	T	R
Control:	Protected			Protected			Split Phase			Split Phase		
Rights:	Ignore			Include			Include			Ovl		
Min. Green:	0	0	0	0	0	0	0	0	0	0	0	0
Y+R:	4.0	4.0	4.0	4.0	4.0	4.0	4.0	4.0	4.0	4.0	4.0	4.0
Lanes:	0	0	4	0	0	4	0	0	0	1	1	0

Volume Module:	North Bound			South Bound			East Bound			West Bound		
Base Vol:	0	2094	183	0	2148	20	0	0	194	357	306	1184
Growth Adj:	1.00	1.00	1.00	1.00	1.00	1.00	1.00	1.00	1.00	1.00	1.00	1.00
Initial Bse:	0	2094	183	0	2148	20	0	0	194	357	306	1184
User Adj:	1.00	1.00	0.00	1.00	1.00	1.00	1.00	1.00	1.00	1.00	1.00	1.00
PHF Adj:	1.00	1.00	0.00	1.00	1.00	1.00	1.00	1.00	1.00	1.00	1.00	1.00
PHF Volume:	0	2094	0	0	2148	20	0	0	194	357	306	1184
Reduct Vol:	0	0	0	0	0	0	0	0	0	0	0	0
Reduced Vol:	0	2094	0	0	2148	20	0	0	194	357	306	1184
PCE Adj:	1.00	1.00	0.00	1.00	1.00	1.00	1.00	1.00	1.00	1.00	1.00	1.00
MLF Adj:	1.00	1.00	0.00	1.00	1.00	1.00	1.00	1.00	1.00	1.00	1.00	1.00
FinalVolume:	0	2094	0	0	2148	20	0	0	194	357	306	1184

Saturation Flow Module:	North Bound			South Bound			East Bound			West Bound		
Sat/Lane:	1900	1900	1900	1900	1900	1900	1900	1900	1900	1900	1900	1900
Adjustment:	1.00	0.91	1.00	1.00	0.91	0.91	1.00	1.00	0.75	0.93	0.93	0.75
Lanes:	0.00	4.00	1.00	0.00	4.95	0.05	0.00	0.00	2.00	1.62	1.38	2.00
Final Sat.:	0	6916	1900	0	8557	80	0	0	2842	2840	2434	2842

Capacity Analysis Module:	North Bound			South Bound			East Bound			West Bound		
Vol/Sat:	0.00	0.30	0.00	0.00	0.25	0.25	0.00	0.00	0.07	0.13	0.13	0.42
Crit Moves:	****			****			****			****		
Green/Cycle:	0.00	0.37	0.00	0.00	0.37	0.37	0.00	0.00	0.08	0.50	0.50	0.50
Volume/Cap:	0.00	0.83	0.00	0.00	0.69	0.69	0.00	0.00	0.83	0.25	0.25	0.83
Delay/Veh:	0.0	31.3	0.0	0.0	27.5	27.5	0.0	0.0	66.4	14.2	14.2	25.4
User DelAdj:	1.00	1.00	1.00	1.00	1.00	1.00	1.00	1.00	1.00	1.00	1.00	1.00
AdjDel/Veh:	0.0	31.3	0.0	0.0	27.5	27.5	0.0	0.0	66.4	14.2	14.2	25.4
LOS by Move:	A	C	A	A	C	C	A	A	E	B	B	C
HCM2k85thQ:	0	27	0	0	20	20	0	0	9	6	6	29

 Note: Queue reported is the number of cars per lane.

Santa Ana Circulation Element

Level Of Service Computation Report
 2000 HCM Operations Method (Base Volume Alternative)

 Intersection #42 Bristol St and I-405 EB Ramps

Cycle (sec): 100 Critical Vol./Cap.(X): 0.595
 Loss Time (sec): 5 Average Delay (sec/veh): 18.4
 Optimal Cycle: 30 Level Of Service: B

Approach:	North Bound			South Bound			East Bound			West Bound		
Movement:	L	T	R	L	T	R	L	T	R	L	T	R
Control:	Protected			Protected			Split Phase			Split Phase		
Rights:	Include			Ignore			Include			Include		
Min. Green:	0	0	0	0	0	0	0	0	0	0	0	0
Y+R:	4.0	4.0	4.0	4.0	4.0	4.0	4.0	4.0	4.0	4.0	4.0	4.0
Lanes:	1	0	4	0	0	2	1	1	3	0	0	0

Volume Module:

Base Vol:	127	1555	0	0	1506	880	740	0	331	0	0	0
Growth Adj:	1.00	1.00	1.00	1.00	1.00	1.00	1.00	1.00	1.00	1.00	1.00	1.00
Initial Bse:	127	1555	0	0	1506	880	740	0	331	0	0	0
User Adj:	1.00	1.00	1.00	1.00	1.00	0.00	1.00	1.00	1.00	1.00	1.00	1.00
PHF Adj:	1.00	1.00	1.00	1.00	1.00	0.00	1.00	1.00	1.00	1.00	1.00	1.00
PHF Volume:	127	1555	0	0	1506	0	740	0	331	0	0	0
Reduct Vol:	0	0	0	0	0	0	0	0	0	0	0	0
Reduced Vol:	127	1555	0	0	1506	0	740	0	331	0	0	0
PCE Adj:	1.00	1.00	1.00	1.00	1.00	0.00	1.00	1.00	1.00	1.00	1.00	1.00
MLF Adj:	1.00	1.00	1.00	1.00	1.00	0.00	1.00	1.00	1.00	1.00	1.00	1.00
FinalVolume:	127	1555	0	0	1506	0	740	0	331	0	0	0

Saturation Flow Module:

Sat/Lane:	1900	1900	1900	1900	1900	1900	1900	1900	1900	1900	1900	1900
Adjustment:	0.95	0.91	1.00	1.00	0.91	0.91	0.92	1.00	0.85	1.00	1.00	1.00
Lanes:	1.00	4.00	0.00	0.00	3.00	1.00	3.00	0.00	1.00	0.00	0.00	0.00
Final Sat.:	1805	6916	0	0	5187	1729	5253	0	1615	0	0	0

Capacity Analysis Module:

Vol/Sat:	0.07	0.22	0.00	0.00	0.29	0.00	0.14	0.00	0.20	0.00	0.00	0.00
Crit Moves:	****			****					****			
Green/Cycle:	0.12	0.61	0.00	0.00	0.49	0.00	0.34	0.00	0.34	0.00	0.00	0.00
Volume/Cap:	0.60	0.37	0.00	0.00	0.60	0.00	0.41	0.00	0.60	0.00	0.00	0.00
Delay/Veh:	46.3	10.1	0.0	0.0	18.9	0.0	25.2	0.0	28.8	0.0	0.0	0.0
User DelAdj:	1.00	1.00	1.00	1.00	1.00	1.00	1.00	1.00	1.00	1.00	1.00	1.00
AdjDel/Veh:	46.3	10.1	0.0	0.0	18.9	0.0	25.2	0.0	28.8	0.0	0.0	0.0
LOS by Move:	D	B	A	A	B	A	C	A	C	A	A	A
HCM2k85thQ:	7	10	0	0	19	0	9	0	14	0	0	0

 Note: Queue reported is the number of cars per lane.

Santa Ana Circulation Element

Level Of Service Computation Report

ICU 1(Loss as Cycle Length %) Method (Base Volume Alternative)

Intersection #43 Flower St and Santa Ana Blvd

Cycle (sec): 100 Critical Vol./Cap.(X): 0.571
 Loss Time (sec): 5 Average Delay (sec/veh): xxxxxx
 Optimal Cycle: 27 Level Of Service: A

Approach:	North Bound			South Bound			East Bound			West Bound		
Movement:	L	T	R	L	T	R	L	T	R	L	T	R
Control:	Prot+Permit			Prot+Permit			Prot+Permit			Prot+Permit		
Rights:	Include			Include			Include			Include		
Min. Green:	0	0	0	0	0	0	0	0	0	0	0	0
Y+R:	4.0	4.0	4.0	4.0	4.0	4.0	4.0	4.0	4.0	4.0	4.0	4.0
Lanes:	1	0	2	0	1	1	1	0	3	0	1	1

Volume Module:

Base Vol:	124	754	62	104	530	48	134	386	63	146	510	151
Growth Adj:	1.00	1.00	1.00	1.00	1.00	1.00	1.00	1.00	1.00	1.00	1.00	1.00
Initial Bse:	124	754	62	104	530	48	134	386	63	146	510	151
User Adj:	1.00	1.00	1.00	1.00	1.00	1.00	1.00	1.00	1.00	1.00	1.00	1.00
PHF Adj:	1.00	1.00	1.00	1.00	1.00	1.00	1.00	1.00	1.00	1.00	1.00	1.00
PHF Volume:	124	754	62	104	530	48	134	386	63	146	510	151
Reduct Vol:	0	0	0	0	0	0	0	0	0	0	0	0
Reduced Vol:	124	754	62	104	530	48	134	386	63	146	510	151
PCE Adj:	1.00	1.00	1.00	1.00	1.00	1.00	1.00	1.00	1.00	1.00	1.00	1.00
MLF Adj:	1.00	1.00	1.00	1.00	1.00	1.00	1.00	1.00	1.00	1.00	1.00	1.00
Final Volume:	124	754	62	104	530	48	134	386	63	146	510	151

Saturation Flow Module:

Sat/Lane:	1600	1600	1600	1600	1600	1600	1600	1600	1600	1600	1600	1600
Adjustment:	1.00	1.06	1.00	1.00	1.06	1.00	1.00	1.06	1.00	1.00	1.06	1.00
Lanes:	1.00	2.00	1.00	1.00	2.00	1.00	1.00	3.00	1.00	1.00	2.00	1.00
Final Sat.:	1600	3400	1600	1600	3400	1600	1600	5100	1600	1600	3400	1600

Capacity Analysis Module:

Vol/Sat:	0.08	0.22	0.04	0.07	0.16	0.03	0.08	0.08	0.04	0.09	0.15	0.09
Crit Moves:	****			****			****			****		

Santa Ana Circulation Element

Level Of Service Computation Report

ICU 1(Loss as Cycle Length %) Method (Base Volume Alternative)

Intersection #44 Flower St and 1st St

Cycle (sec): 100 Critical Vol./Cap.(X): 0.752
 Loss Time (sec): 5 Average Delay (sec/veh): xxxxxx
 Optimal Cycle: 44 Level Of Service: C

Approach:	North Bound			South Bound			East Bound			West Bound		
Movement:	L	T	R	L	T	R	L	T	R	L	T	R
Control:	Protected			Protected			Protected			Protected		
Rights:	Include			Include			Include			Include		
Min. Green:	0	0	0	0	0	0	0	0	0	0	0	0
Y+R:	4.0	4.0	4.0	4.0	4.0	4.0	4.0	4.0	4.0	4.0	4.0	4.0
Lanes:	1	0	2	0	1	1	0	1	0	1	0	2

Volume Module:

Base Vol:	132	625	149	170	466	135	139	1217	101	210	1415	147
Growth Adj:	1.00	1.00	1.00	1.00	1.00	1.00	1.00	1.00	1.00	1.00	1.00	1.00
Initial Bse:	132	625	149	170	466	135	139	1217	101	210	1415	147
User Adj:	1.00	1.00	1.00	1.00	1.00	1.00	1.00	1.00	1.00	1.00	1.00	1.00
PHF Adj:	1.00	1.00	1.00	1.00	1.00	1.00	1.00	1.00	1.00	1.00	1.00	1.00
PHF Volume:	132	625	149	170	466	135	139	1217	101	210	1415	147
Reduct Vol:	0	0	0	0	0	0	0	0	0	0	0	0
Reduced Vol:	132	625	149	170	466	135	139	1217	101	210	1415	147
PCE Adj:	1.00	1.00	1.00	1.00	1.00	1.00	1.00	1.00	1.00	1.00	1.00	1.00
MLF Adj:	1.00	1.00	1.00	1.00	1.00	1.00	1.00	1.00	1.00	1.00	1.00	1.00
FinalVolume:	132	625	149	170	466	135	139	1217	101	210	1415	147

Saturation Flow Module:

Sat/Lane:	1600	1600	1600	1600	1600	1600	1600	1600	1600	1600	1600	1600
Adjustment:	1.00	1.06	1.00	1.00	1.04	1.00	1.00	1.05	1.00	1.00	1.05	1.00
Lanes:	1.00	2.00	1.00	1.00	1.55	0.45	1.00	2.77	0.23	1.00	2.72	0.28
Final Sat.:	1600	3400	1600	1600	2581	719	1600	4632	368	1600	4548	452

Capacity Analysis Module:

Vol/Sat:	0.08	0.18	0.09	0.11	0.18	0.19	0.09	0.26	0.27	0.13	0.31	0.33
Crit Moves:	****			****			****			****		

Santa Ana Circulation Element

Level Of Service Computation Report

ICU 1(Loss as Cycle Length %) Method (Base Volume Alternative)

Intersection #45 Flower St and McFadden Ave

Cycle (sec): 100 Critical Vol./Cap.(X): 0.920
 Loss Time (sec): 5 Average Delay (sec/veh): xxxxxx
 Optimal Cycle: 100 Level Of Service: E

Approach:	North Bound			South Bound			East Bound			West Bound		
Movement:	L	T	R	L	T	R	L	T	R	L	T	R
Control:	Permitted			Permitted			Permitted			Permitted		
Rights:	Include			Include			Include			Include		
Min. Green:	0	0	0	0	0	0	0	0	0	0	0	0
Y+R:	4.0	4.0	4.0	4.0	4.0	4.0	4.0	4.0	4.0	4.0	4.0	4.0
Lanes:	1	0	0	1	0	0	1	0	0	1	0	0

Volume Module:

Base Vol:	42	567	35	46	352	57	64	478	19	48	595	85
Growth Adj:	1.00	1.00	1.00	1.00	1.00	1.00	1.00	1.00	1.00	1.00	1.00	1.00
Initial Bse:	42	567	35	46	352	57	64	478	19	48	595	85
User Adj:	1.00	1.00	1.00	1.00	1.00	1.00	1.00	1.00	1.00	1.00	1.00	1.00
PHF Adj:	1.00	1.00	1.00	1.00	1.00	1.00	1.00	1.00	1.00	1.00	1.00	1.00
PHF Volume:	42	567	35	46	352	57	64	478	19	48	595	85
Reduct Vol:	0	0	0	0	0	0	0	0	0	0	0	0
Reduced Vol:	42	567	35	46	352	57	64	478	19	48	595	85
PCE Adj:	1.00	1.00	1.00	1.00	1.00	1.00	1.00	1.00	1.00	1.00	1.00	1.00
MLF Adj:	1.00	1.00	1.00	1.00	1.00	1.00	1.00	1.00	1.00	1.00	1.00	1.00
FinalVolume:	42	567	35	46	352	57	64	478	19	48	595	85

Saturation Flow Module:

Sat/Lane:	1600	1600	1600	1600	1600	1600	1600	1600	1600	1600	1600	1600
Adjustment:	1.00	1.00	1.00	1.00	1.00	1.00	1.00	1.00	1.00	1.00	1.00	1.00
Lanes:	1.00	0.94	0.06	1.00	0.86	0.14	1.00	0.96	0.04	1.00	0.88	0.12
Final Sat.:	1600	1507	93	1600	1377	223	1600	1539	61	1600	1400	200

Capacity Analysis Module:

Vol/Sat:	0.03	0.38	0.38	0.03	0.26	0.26	0.04	0.31	0.31	0.03	0.43	0.43
Crit Moves:	****			****			****			****		

Santa Ana Circulation Element

Level Of Service Computation Report

ICU 1(Loss as Cycle Length %) Method (Base Volume Alternative)

Intersection #46 Flower St and Segerstrom Ave

Cycle (sec): 100 Critical Vol./Cap.(X): 0.897
 Loss Time (sec): 5 Average Delay (sec/veh): xxxxxx
 Optimal Cycle: 85 Level Of Service: D

Approach:	North Bound			South Bound			East Bound			West Bound		
Movement:	L	T	R	L	T	R	L	T	R	L	T	R
Control:	Permitted			Permitted			Protected			Protected		
Rights:	Include			Include			Include			Include		
Min. Green:	0	0	0	0	0	0	0	0	0	0	0	0
Y+R:	4.0	4.0	4.0	4.0	4.0	4.0	4.0	4.0	4.0	4.0	4.0	4.0
Lanes:	1	0	1	1	0	1	1	0	1	1	0	1

Volume Module:

Base Vol:	120	843	80	66	369	106	158	786	83	75	1258	81
Growth Adj:	1.00	1.00	1.00	1.00	1.00	1.00	1.00	1.00	1.00	1.00	1.00	1.00
Initial Bse:	120	843	80	66	369	106	158	786	83	75	1258	81
User Adj:	1.00	1.00	1.00	1.00	1.00	1.00	1.00	1.00	1.00	1.00	1.00	1.00
PHF Adj:	1.00	1.00	1.00	1.00	1.00	1.00	1.00	1.00	1.00	1.00	1.00	1.00
PHF Volume:	120	843	80	66	369	106	158	786	83	75	1258	81
Reduct Vol:	0	0	0	0	0	0	0	0	0	0	0	0
Reduced Vol:	120	843	80	66	369	106	158	786	83	75	1258	81
PCE Adj:	1.00	1.00	1.00	1.00	1.00	1.00	1.00	1.00	1.00	1.00	1.00	1.00
MLF Adj:	1.00	1.00	1.00	1.00	1.00	1.00	1.00	1.00	1.00	1.00	1.00	1.00
Final Volume:	120	843	80	66	369	106	158	786	83	75	1258	81

Saturation Flow Module:

Sat/Lane:	1600	1600	1600	1600	1600	1600	1600	1600	1600	1600	1600	1600
Adjustment:	1.00	1.03	1.00	1.00	1.04	1.00	1.00	1.03	1.00	1.00	1.03	1.00
Lanes:	1.00	1.83	0.17	1.00	1.55	0.45	1.00	1.81	0.19	1.00	1.88	0.12
Final Sat.:	1600	3023	277	1600	2586	714	1600	2994	306	1600	3106	194

Capacity Analysis Module:

Vol/Sat:	0.08	0.28	0.29	0.04	0.14	0.15	0.10	0.26	0.27	0.05	0.40	0.42
Crit Moves:			****	****			****			****		

Santa Ana Circulation Element

Level Of Service Computation Report

ICU 1(Loss as Cycle Length %) Method (Base Volume Alternative)

Intersection #47 Flower St and MacArthur Blvd

Cycle (sec): 100 Critical Vol./Cap.(X): 0.906
 Loss Time (sec): 5 Average Delay (sec/veh): xxxxxx
 Optimal Cycle: 90 Level Of Service: E

Approach:	North Bound			South Bound			East Bound			West Bound		
Movement:	L	T	R	L	T	R	L	T	R	L	T	R
Control:	Permitted			Permitted			Protected			Protected		
Rights:	Include			Include			Include			Include		
Min. Green:	0	0	0	0	0	0	0	0	0	0	0	0
Y+R:	4.0	4.0	4.0	4.0	4.0	4.0	4.0	4.0	4.0	4.0	4.0	4.0
Lanes:	1	0	1	1	0	1	2	1	0	1	0	2

Volume Module:

Base Vol:	133	634	74	85	205	197	209	994	63	62	1989	177
Growth Adj:	1.00	1.00	1.00	1.00	1.00	1.00	1.00	1.00	1.00	1.00	1.00	1.00
Initial Bse:	133	634	74	85	205	197	209	994	63	62	1989	177
User Adj:	1.00	1.00	1.00	1.00	1.00	1.00	1.00	1.00	1.00	1.00	1.00	1.00
PHF Adj:	1.00	1.00	1.00	1.00	1.00	1.00	1.00	1.00	1.00	1.00	1.00	1.00
PHF Volume:	133	634	74	85	205	197	209	994	63	62	1989	177
Reduct Vol:	0	0	0	0	0	0	0	0	0	0	0	0
Reduced Vol:	133	634	74	85	205	197	209	994	63	62	1989	177
PCE Adj:	1.00	1.00	1.00	1.00	1.00	1.00	1.00	1.00	1.00	1.00	1.00	1.00
MLF Adj:	1.00	1.00	1.00	1.00	1.00	1.00	1.00	1.00	1.00	1.00	1.00	1.00
FinalVolume:	133	634	74	85	205	197	209	994	63	62	1989	177

Saturation Flow Module:

Sat/Lane:	1600	1600	1600	1600	1600	1600	1600	1600	1600	1600	1600	1600
Adjustment:	1.00	1.03	1.00	1.00	1.06	1.00	1.00	1.04	1.00	1.00	1.05	1.00
Lanes:	1.00	1.79	0.21	1.00	1.02	0.98	1.00	2.82	0.18	1.00	2.75	0.25
Final Sat.:	1600	2966	334	1600	1732	1568	1600	4714	286	1600	4608	392

Capacity Analysis Module:

Vol/Sat:	0.08	0.21	0.22	0.05	0.12	0.13	0.13	0.21	0.22	0.04	0.43	0.45
Crit Moves:			****	****			****					****

Santa Ana Circulation Element

Level Of Service Computation Report

ICU 1(Loss as Cycle Length %) Method (Base Volume Alternative)

Intersection #48 Main St and La Veta Ave

Cycle (sec): 100 Critical Vol./Cap.(X): 0.628
 Loss Time (sec): 5 Average Delay (sec/veh): xxxxxx
 Optimal Cycle: 31 Level Of Service: B

Approach:	North Bound			South Bound			East Bound			West Bound								
Movement:	L	T	R	L	T	R	L	T	R	L	T	R						
Control:	Protected			Protected			Protected			Protected								
Rights:	Ovl			Include			Include			Ovl								
Min. Green:	0	0	0	0	0	0	0	0	0	0	0	0						
Y+R:	4.0	4.0	4.0	4.0	4.0	4.0	4.0	4.0	4.0	4.0	4.0	4.0						
Lanes:	2	0	3	0	1		2	0	2	1	0		2	0	2	0	1	

Volume Module:

Base Vol:	307	938	439	145	911	235	296	422	189	257	513	206
Growth Adj:	1.00	1.00	1.00	1.00	1.00	1.00	1.00	1.00	1.00	1.00	1.00	1.00
Initial Bse:	307	938	439	145	911	235	296	422	189	257	513	206
User Adj:	1.00	1.00	1.00	1.00	1.00	1.00	1.00	1.00	1.00	1.00	1.00	1.00
PHF Adj:	1.00	1.00	1.00	1.00	1.00	1.00	1.00	1.00	1.00	1.00	1.00	1.00
PHF Volume:	307	938	439	145	911	235	296	422	189	257	513	206
Reduct Vol:	0	0	0	0	0	0	0	0	0	0	0	0
Reduced Vol:	307	938	439	145	911	235	296	422	189	257	513	206
PCE Adj:	1.00	1.00	1.00	1.00	1.00	1.00	1.00	1.00	1.00	1.00	1.00	1.00
MLF Adj:	1.00	1.00	1.00	1.00	1.00	1.00	1.00	1.00	1.00	1.00	1.00	1.00
FinalVolume:	307	938	439	145	911	235	296	422	189	257	513	206
OvlAdjVol:	310			134								

Saturation Flow Module:

Sat/Lane:	1600	1600	1600	1600	1600	1600	1600	1600	1600	1600	1600	1600
Adjustment:	1.00	1.06	1.00	1.00	1.05	1.00	1.00	1.06	1.00	1.00	1.06	1.00
Lanes:	2.00	3.00	1.00	2.00	2.38	0.62	2.00	2.07	0.93	2.00	2.00	1.00
Final Sat.:	3200	5100	1600	3200	4016	984	3200	3515	1485	3200	3400	1600

Capacity Analysis Module:

Vol/Sat:	0.10	0.18	0.27	0.05	0.23	0.24	0.09	0.12	0.13	0.08	0.15	0.13
OvlAdjV/S:	0.19											
Crit Moves:	****			****			****			****		

Santa Ana Circulation Element

Level Of Service Computation Report

ICU 1(Loss as Cycle Length %) Method (Base Volume Alternative)

Intersection #49 Main St and Mainplace Dr / Memory Ln

Cycle (sec): 100 Critical Vol./Cap.(X): 0.471
 Loss Time (sec): 5 Average Delay (sec/veh): xxxxxx
 Optimal Cycle: 22 Level Of Service: A

Approach:	North Bound			South Bound			East Bound			West Bound		
Movement:	L	T	R	L	T	R	L	T	R	L	T	R
Control:	Protected			Protected			Protected			Protected		
Rights:	Include			Include			Include			Include		
Min. Green:	0	0	0	0	0	0	0	0	0	0	0	0
Y+R:	4.0	4.0	4.0	4.0	4.0	4.0	4.0	4.0	4.0	4.0	4.0	4.0
Lanes:	2	0	2	1	0	0	2	0	2	1	0	1

Volume Module:

Base Vol:	90	945	179	51	1055	139	293	325	87	185	151	73
Growth Adj:	1.00	1.00	1.00	1.00	1.00	1.00	1.00	1.00	1.00	1.00	1.00	1.00
Initial Bse:	90	945	179	51	1055	139	293	325	87	185	151	73
User Adj:	1.00	1.00	1.00	1.00	1.00	1.00	1.00	1.00	1.00	1.00	1.00	1.00
PHF Adj:	1.00	1.00	1.00	1.00	1.00	1.00	1.00	1.00	1.00	1.00	1.00	1.00
PHF Volume:	90	945	179	51	1055	139	293	325	87	185	151	73
Reduct Vol:	0	0	0	0	0	0	0	0	0	0	0	0
Reduced Vol:	90	945	179	51	1055	139	293	325	87	185	151	73
PCE Adj:	1.00	1.00	1.00	1.00	1.00	1.00	1.00	1.00	1.00	1.00	1.00	1.00
MLF Adj:	1.00	1.00	1.00	1.00	1.00	1.00	1.00	1.00	1.00	1.00	1.00	1.00
FinalVolume:	90	945	179	51	1055	139	293	325	87	185	151	73

Saturation Flow Module:

Sat/Lane:	1600	1600	1600	1600	1600	1600	1600	1600	1600	1600	1600	1600
Adjustment:	1.00	1.05	1.00	1.00	1.05	1.00	1.00	1.05	1.00	1.00	1.06	1.00
Lanes:	2.00	2.52	0.48	2.00	2.65	0.35	2.00	2.37	0.63	2.00	2.00	1.00
Final Sat.:	3200	4236	764	3200	4441	559	3200	3986	1014	3200	3400	1600

Capacity Analysis Module:

Vol/Sat:	0.03	0.22	0.23	0.02	0.24	0.25	0.09	0.08	0.09	0.06	0.04	0.05
Crit Moves:	****					****			****	****		

Santa Ana Circulation Element

Level Of Service Computation Report

ICU 1(Loss as Cycle Length %) Method (Base Volume Alternative)

Intersection #50 Main St and 17th St

Cycle (sec): 100 Critical Vol./Cap.(X): 0.732
Loss Time (sec): 5 Average Delay (sec/veh): xxxxxx
Optimal Cycle: 41 Level Of Service: C

Table with 4 columns: North Bound, South Bound, East Bound, West Bound. Rows include Movement, Control, Rights, Min. Green, Y+R, and Lanes.

Volume Module: Table with 12 columns representing different volume categories and their values.

Saturation Flow Module: Table with 12 columns representing saturation flow values for various lanes.

Capacity Analysis Module: Table with 12 columns representing capacity analysis values.

Santa Ana Circulation Element

Level Of Service Computation Report

ICU 1(Loss as Cycle Length %) Method (Base Volume Alternative)

Intersection #51 Main St and Civic Center Dr

Cycle (sec): 100 Critical Vol./Cap.(X): 0.801
Loss Time (sec): 5 Average Delay (sec/veh): xxxxxx
Optimal Cycle: 52 Level Of Service: D

Table with 4 columns: North Bound, South Bound, East Bound, West Bound. Rows include Movement (L-T-R), Control (Permitted), Rights (Include), Min. Green, Y+R, and Lanes.

Volume Module table with 12 columns and 12 rows including Base Vol, Growth Adj, Initial Bse, User Adj, PHF Adj, PHF Volume, Reduct Vol, Reduced Vol, PCE Adj, MLF Adj, and Final Volume.

Saturation Flow Module table with 12 columns and 4 rows including Sat/Lane, Adjustment, Lanes, and Final Sat.

Capacity Analysis Module table with 12 columns and 2 rows including Vol/Sat and Crit Moves.

Santa Ana Circulation Element

Level Of Service Computation Report

ICU 1(Loss as Cycle Length %) Method (Base Volume Alternative)

Intersection #52 Main St and Santa Ana Blvd

Cycle (sec): 100 Critical Vol./Cap.(X): 0.607
 Loss Time (sec): 5 Average Delay (sec/veh): xxxxxx
 Optimal Cycle: 29 Level Of Service: B

Approach:	North Bound			South Bound			East Bound			West Bound		
Movement:	L	T	R	L	T	R	L	T	R	L	T	R
Control:	Permitted			Permitted			Permitted			Permitted		
Rights:	Include			Include			Include			Include		
Min. Green:	0	0	0	0	0	0	0	0	0	0	0	0
Y+R:	4.0	4.0	4.0	4.0	4.0	4.0	4.0	4.0	4.0	4.0	4.0	4.0
Lanes:	1	0	2	0	0	1	0	0	0	0	1	1

Volume Module:

Base Vol:	54	1229	0	0	1083	53	0	0	0	65	656	85
Growth Adj:	1.00	1.00	1.00	1.00	1.00	1.00	1.00	1.00	1.00	1.00	1.00	1.00
Initial Bse:	54	1229	0	0	1083	53	0	0	0	65	656	85
User Adj:	1.00	1.00	1.00	1.00	1.00	1.00	1.00	1.00	1.00	1.00	1.00	1.00
PHF Adj:	1.00	1.00	1.00	1.00	1.00	1.00	1.00	1.00	1.00	1.00	1.00	1.00
PHF Volume:	54	1229	0	0	1083	53	0	0	0	65	656	85
Reduct Vol:	0	0	0	0	0	0	0	0	0	0	0	0
Reduced Vol:	54	1229	0	0	1083	53	0	0	0	65	656	85
PCE Adj:	1.00	1.00	1.00	1.00	1.00	1.00	1.00	1.00	1.00	1.00	1.00	1.00
MLF Adj:	1.00	1.00	1.00	1.00	1.00	1.00	1.00	1.00	1.00	1.00	1.00	1.00
FinalVolume:	54	1229	0	0	1083	53	0	0	0	65	656	85

Saturation Flow Module:

Sat/Lane:	1600	1600	1600	1600	1600	1600	1600	1600	1600	1600	1600	1600
Adjustment:	1.00	1.06	1.00	1.00	1.03	1.00	1.00	1.06	1.00	1.00	1.03	1.00
Lanes:	1.00	2.00	0.00	0.00	1.91	0.09	0.00	0.00	0.00	0.24	2.44	0.32
Final Sat.:	1600	3400	0	0	3151	149	0	0	0	387	4007	506

Capacity Analysis Module:

Vol/Sat:	0.03	0.36	0.00	0.00	0.34	0.36	0.00	0.00	0.00	0.04	0.16	0.17
Crit Moves:	****					****						****

Santa Ana Circulation Element

Level Of Service Computation Report

ICU 1(Loss as Cycle Length %) Method (Base Volume Alternative)

Intersection #53 Main St and 4th St

Cycle (sec): 100 Critical Vol./Cap.(X): 0.537
 Loss Time (sec): 5 Average Delay (sec/veh): xxxxxx
 Optimal Cycle: 25 Level Of Service: A

Approach:	North Bound			South Bound			East Bound			West Bound		
Movement:	L	T	R	L	T	R	L	T	R	L	T	R
Control:	Permitted			Permitted			Permitted			Permitted		
Rights:	Include			Include			Include			Include		
Min. Green:	0	0	0	0	0	0	0	0	0	0	0	0
Y+R:	4.0	4.0	4.0	4.0	4.0	4.0	4.0	4.0	4.0	4.0	4.0	4.0
Lanes:	0	0	1	1	0	0	0	0	1	0	0	1

Volume Module:

Base Vol:	0	1055	50	0	1037	47	0	98	55	0	181	46
Growth Adj:	1.00	1.00	1.00	1.00	1.00	1.00	1.00	1.00	1.00	1.00	1.00	1.00
Initial Bse:	0	1055	50	0	1037	47	0	98	55	0	181	46
User Adj:	1.00	1.00	1.00	1.00	1.00	1.00	1.00	1.00	1.00	1.00	1.00	1.00
PHF Adj:	1.00	1.00	1.00	1.00	1.00	1.00	1.00	1.00	1.00	1.00	1.00	1.00
PHF Volume:	0	1055	50	0	1037	47	0	98	55	0	181	46
Reduct Vol:	0	0	0	0	0	0	0	0	0	0	0	0
Reduced Vol:	0	1055	50	0	1037	47	0	98	55	0	181	46
PCE Adj:	1.00	1.00	1.00	1.00	1.00	1.00	1.00	1.00	1.00	1.00	1.00	1.00
MLF Adj:	1.00	1.00	1.00	1.00	1.00	1.00	1.00	1.00	1.00	1.00	1.00	1.00
FinalVolume:	0	1055	50	0	1037	47	0	98	55	0	181	46

Saturation Flow Module:

Sat/Lane:	1600	1600	1600	1600	1600	1600	1600	1600	1600	1600	1600	1600
Adjustment:	1.00	1.03	1.00	1.00	1.03	1.00	1.00	1.00	1.00	1.00	1.00	1.00
Lanes:	0.00	1.91	0.09	0.00	1.91	0.09	0.00	0.64	0.36	0.00	0.80	0.20
Final Sat.:	0	3155	145	0	3161	139	0	1025	575	0	1276	324

Capacity Analysis Module:

Vol/Sat:	0.00	0.33	0.35	0.00	0.33	0.34	0.00	0.10	0.10	0.00	0.14	0.14
Crit Moves:			****	****			****			****		

Santa Ana Circulation Element

Level Of Service Computation Report

ICU 1(Loss as Cycle Length %) Method (Base Volume Alternative)

Intersection #54 Main St and 1st St

Cycle (sec): 100 Critical Vol./Cap.(X): 0.799
 Loss Time (sec): 5 Average Delay (sec/veh): xxxxxx
 Optimal Cycle: 52 Level Of Service: C

Approach:	North Bound			South Bound			East Bound			West Bound		
Movement:	L	T	R	L	T	R	L	T	R	L	T	R
Control:	Protected			Protected			Protected			Protected		
Rights:	Include			Include			Include			Include		
Min. Green:	0	0	0	0	0	0	0	0	0	0	0	0
Y+R:	4.0	4.0	4.0	4.0	4.0	4.0	4.0	4.0	4.0	4.0	4.0	4.0
Lanes:	1	0	1	1	0	1	1	0	1	1	0	1

Volume Module:

Base Vol:	169	826	72	175	671	143	120	1214	90	114	1275	89
Growth Adj:	1.00	1.00	1.00	1.00	1.00	1.00	1.00	1.00	1.00	1.00	1.00	1.00
Initial Bse:	169	826	72	175	671	143	120	1214	90	114	1275	89
User Adj:	1.00	1.00	1.00	1.00	1.00	1.00	1.00	1.00	1.00	1.00	1.00	1.00
PHF Adj:	1.00	1.00	1.00	1.00	1.00	1.00	1.00	1.00	1.00	1.00	1.00	1.00
PHF Volume:	169	826	72	175	671	143	120	1214	90	114	1275	89
Reduct Vol:	0	0	0	0	0	0	0	0	0	0	0	0
Reduced Vol:	169	826	72	175	671	143	120	1214	90	114	1275	89
PCE Adj:	1.00	1.00	1.00	1.00	1.00	1.00	1.00	1.00	1.00	1.00	1.00	1.00
MLF Adj:	1.00	1.00	1.00	1.00	1.00	1.00	1.00	1.00	1.00	1.00	1.00	1.00
FinalVolume:	169	826	72	175	671	143	120	1214	90	114	1275	89

Saturation Flow Module:

Sat/Lane:	1600	1600	1600	1600	1600	1600	1600	1600	1600	1600	1600	1600
Adjustment:	1.00	1.03	1.00	1.00	1.06	1.00	1.00	1.04	1.00	1.00	1.04	1.00
Lanes:	1.00	1.84	0.16	1.00	2.00	1.00	1.00	2.79	0.21	1.00	2.80	0.20
Final Sat.:	1600	3043	257	1600	3400	1600	1600	4669	331	1600	4687	313

Capacity Analysis Module:

Vol/Sat:	0.11	0.27	0.28	0.11	0.20	0.09	0.08	0.26	0.27	0.07	0.27	0.28
Crit Moves:			****	****			****			****		

Santa Ana Circulation Element

Level Of Service Computation Report

ICU 1(Loss as Cycle Length %) Method (Base Volume Alternative)

Intersection #55 Main St and McFadden Ave

Cycle (sec): 100 Critical Vol./Cap.(X): 0.845
 Loss Time (sec): 5 Average Delay (sec/veh): xxxxxx
 Optimal Cycle: 64 Level Of Service: D

Approach:	North Bound			South Bound			East Bound			West Bound		
Movement:	L	T	R	L	T	R	L	T	R	L	T	R
Control:	Prot+Permit			Prot+Permit			Protected			Protected		
Rights:	Include			Include			Include			Include		
Min. Green:	0	0	0	0	0	0	0	0	0	0	0	0
Y+R:	4.0	4.0	4.0	4.0	4.0	4.0	4.0	4.0	4.0	4.0	4.0	4.0
Lanes:	1	0	1	1	0	1	0	0	1	1	0	1

Volume Module:

Base Vol:	146	1147	71	134	908	66	78	345	42	85	480	216
Growth Adj:	1.00	1.00	1.00	1.00	1.00	1.00	1.00	1.00	1.00	1.00	1.00	1.00
Initial Bse:	146	1147	71	134	908	66	78	345	42	85	480	216
User Adj:	1.00	1.00	1.00	1.00	1.00	1.00	1.00	1.00	1.00	1.00	1.00	1.00
PHF Adj:	1.00	1.00	1.00	1.00	1.00	1.00	1.00	1.00	1.00	1.00	1.00	1.00
PHF Volume:	146	1147	71	134	908	66	78	345	42	85	480	216
Reduct Vol:	0	0	0	0	0	0	0	0	0	0	0	0
Reduced Vol:	146	1147	71	134	908	66	78	345	42	85	480	216
PCE Adj:	1.00	1.00	1.00	1.00	1.00	1.00	1.00	1.00	1.00	1.00	1.00	1.00
MLF Adj:	1.00	1.00	1.00	1.00	1.00	1.00	1.00	1.00	1.00	1.00	1.00	1.00
FinalVolume:	146	1147	71	134	908	66	78	345	42	85	480	216

Saturation Flow Module:

Sat/Lane:	1600	1600	1600	1600	1600	1600	1600	1600	1600	1600	1600	1600
Adjustment:	1.00	1.03	1.00	1.00	1.03	1.00	1.00	1.00	1.00	1.00	1.06	1.00
Lanes:	1.00	1.88	0.12	1.00	1.86	0.14	1.00	0.89	0.11	1.00	1.00	1.00
Final Sat.:	1600	3113	187	1600	3083	217	1600	1426	174	1600	1700	1600

Capacity Analysis Module:

Vol/Sat:	0.09	0.37	0.38	0.08	0.29	0.30	0.05	0.24	0.24	0.05	0.28	0.14
Crit Moves:			****	****			****			****		

Santa Ana Circulation Element

Level Of Service Computation Report

ICU 1(Loss as Cycle Length %) Method (Base Volume Alternative)

Intersection #56 Main St and Edinger Ave

Cycle (sec): 100 Critical Vol./Cap.(X): 0.847
Loss Time (sec): 5 Average Delay (sec/veh): xxxxxx
Optimal Cycle: 64 Level Of Service: D

Table with 4 columns: North Bound, South Bound, East Bound, West Bound. Rows include Movement (L-T-R), Control (Protected), Rights (Include), Min. Green, Y+R, and Lanes.

Volume Module: Table with 12 columns representing volume and adjustment factors for various traffic conditions.

Saturation Flow Module: Table with 12 columns representing saturation flow and adjustment factors.

Capacity Analysis Module: Table with 12 columns representing capacity analysis metrics.

Santa Ana Circulation Element

Level Of Service Computation Report

ICU 1(Loss as Cycle Length %) Method (Base Volume Alternative)

Intersection #57 Main St and MacArthur Blvd

Cycle (sec): 100 Critical Vol./Cap.(X): 0.777
 Loss Time (sec): 5 Average Delay (sec/veh): xxxxxx
 Optimal Cycle: 48 Level Of Service: C

Approach:	North Bound			South Bound			East Bound			West Bound		
Movement:	L	T	R	L	T	R	L	T	R	L	T	R
Control:	Protected			Protected			Protected			Protected		
Rights:	Include			Include			Include			Include		
Min. Green:	0	0	0	0	0	0	0	0	0	0	0	0
Y+R:	4.0	4.0	4.0	4.0	4.0	4.0	4.0	4.0	4.0	4.0	4.0	4.0
Lanes:	2	0	3	0	1		2	0	3	0	1	

Volume Module:

Base Vol:	488	1169	321	283	368	278	298	613	59	198	1570	456
Growth Adj:	1.00	1.00	1.00	1.00	1.00	1.00	1.00	1.00	1.00	1.00	1.00	1.00
Initial Bse:	488	1169	321	283	368	278	298	613	59	198	1570	456
User Adj:	1.00	1.00	1.00	1.00	1.00	1.00	1.00	1.00	1.00	1.00	1.00	1.00
PHF Adj:	1.00	1.00	1.00	1.00	1.00	1.00	1.00	1.00	1.00	1.00	1.00	1.00
PHF Volume:	488	1169	321	283	368	278	298	613	59	198	1570	456
Reduct Vol:	0	0	0	0	0	0	0	0	0	0	0	0
Reduced Vol:	488	1169	321	283	368	278	298	613	59	198	1570	456
PCE Adj:	1.00	1.00	1.00	1.00	1.00	1.00	1.00	1.00	1.00	1.00	1.00	1.00
MLF Adj:	1.00	1.00	1.00	1.00	1.00	1.00	1.00	1.00	1.00	1.00	1.00	1.00
Final Volume:	488	1169	321	283	368	278	298	613	59	198	1570	456

Saturation Flow Module:

Sat/Lane:	1600	1600	1600	1600	1600	1600	1600	1600	1600	1600	1600	1600
Adjustment:	1.00	1.06	1.00	1.00	1.06	1.00	1.00	1.06	1.00	1.00	1.06	1.00
Lanes:	2.00	3.00	1.00	2.00	3.00	1.00	2.00	3.00	1.00	2.00	3.00	1.00
Final Sat.:	3200	5100	1600	3200	5100	1600	3200	5100	1600	3200	5100	1600

Capacity Analysis Module:

Vol/Sat:	0.15	0.23	0.20	0.09	0.07	0.17	0.09	0.12	0.04	0.06	0.31	0.28
Crit Moves:	****					****	****				****	

Santa Ana Circulation Element

Level Of Service Computation Report
 2000 HCM Operations Method (Base Volume Alternative)

 Intersection #58 Penn Wy and 17th St

Cycle (sec): 100 Critical Vol./Cap.(X): 0.770
 Loss Time (sec): 5 Average Delay (sec/veh): 20.7
 Optimal Cycle: 48 Level Of Service: C

Approach:	North Bound			South Bound			East Bound			West Bound		
Movement:	L	T	R	L	T	R	L	T	R	L	T	R
Control:	Split Phase			Split Phase			Protected			Protected		
Rights:	Include			Include			Include			Include		
Min. Green:	0	0	0	0	0	0	0	0	0	0	0	0
Y+R:	4.0	4.0	4.0	4.0	4.0	4.0	4.0	4.0	4.0	4.0	4.0	4.0
Lanes:	2	0	0	0	0	0	0	0	2	1	0	0

Volume Module:

Base Vol:	848	0	414	0	0	0	0	1590	513	123	1440	0
Growth Adj:	1.00	1.00	1.00	1.00	1.00	1.00	1.00	1.00	1.00	1.00	1.00	1.00
Initial Bse:	848	0	414	0	0	0	0	1590	513	123	1440	0
User Adj:	1.00	1.00	1.00	1.00	1.00	1.00	1.00	1.00	1.00	1.00	1.00	1.00
PHF Adj:	1.00	1.00	1.00	1.00	1.00	1.00	1.00	1.00	1.00	1.00	1.00	1.00
PHF Volume:	848	0	414	0	0	0	0	1590	513	123	1440	0
Reduct Vol:	0	0	0	0	0	0	0	0	0	0	0	0
Reduced Vol:	848	0	414	0	0	0	0	1590	513	123	1440	0
PCE Adj:	1.00	1.00	1.00	1.00	1.00	1.00	1.00	1.00	1.00	1.00	1.00	1.00
MLF Adj:	1.00	1.00	1.00	1.00	1.00	1.00	1.00	1.00	1.00	1.00	1.00	1.00
FinalVolume:	848	0	414	0	0	0	0	1590	513	123	1440	0

Saturation Flow Module:

Sat/Lane:	1900	1900	1900	1900	1900	1900	1900	1900	1900	1900	1900	1900
Adjustment:	0.92	1.00	0.75	1.00	1.00	1.00	1.00	0.88	0.88	0.95	0.91	1.00
Lanes:	2.00	0.00	2.00	0.00	0.00	0.00	0.00	2.27	0.73	1.00	3.00	0.00
Final Sat.:	3502	0	2842	0	0	0	0	3777	1218	1805	5187	0

Capacity Analysis Module:

Vol/Sat:	0.24	0.00	0.15	0.00	0.00	0.00	0.00	0.42	0.42	0.07	0.28	0.00
Crit Moves:	****							****		****		
Green/Cycle:	0.31	0.00	0.31	0.00	0.00	0.00	0.00	0.55	0.55	0.09	0.64	0.00
Volume/Cap:	0.77	0.00	0.46	0.00	0.00	0.00	0.00	0.77	0.77	0.77	0.44	0.00
Delay/Veh:	34.4	0.0	27.9	0.0	0.0	0.0	0.0	19.1	19.1	64.7	9.3	0.0
User DelAdj:	1.00	1.00	1.00	1.00	1.00	1.00	1.00	1.00	1.00	1.00	1.00	1.00
AdjDel/Veh:	34.4	0.0	27.9	0.0	0.0	0.0	0.0	19.1	19.1	64.7	9.3	0.0
LOS by Move:	C	A	C	A	A	A	A	B	B	E	A	A
HCM2k85thQ:	21	0	9	0	0	0	0	29	29	9	12	0

 Note: Queue reported is the number of cars per lane.

Santa Ana Circulation Element

Level Of Service Computation Report

2000 HCM Operations Method (Base Volume Alternative)

Intersection #59 I-5 NB Off Ramps/17th Street

Cycle (sec): 100 Critical Vol./Cap.(X): 0.589
 Loss Time (sec): 5 Average Delay (sec/veh): 19.5
 Optimal Cycle: 30 Level Of Service: B

Street Name:	I-5 NB Off Ramps						17th Street													
Approach:	North Bound			South Bound			East Bound			West Bound										
Movement:	L	T	R	L	T	R	L	T	R	L	T	R								
Control:	Split Phase			Split Phase			Protected			Permitted										
Rights:	Include			Include			Ignore			Include										
Min. Green:	0	0	0	0	0	0	0	0	0	0	0	0								
Y+R:	4.0	4.0	4.0	4.0	4.0	4.0	4.0	4.0	4.0	4.0	4.0	4.0								
Lanes:	1	1	0	0	1	1	0	0	0	1	1	0	3	0	1	0	0	2	1	0

Volume Module:

Base Vol:	345	46	18	51	0	133	120	1099	722	0	1525	41
Growth Adj:	1.00	1.00	1.00	1.00	1.00	1.00	1.00	1.00	1.00	1.00	1.00	1.00
Initial Bse:	345	46	18	51	0	133	120	1099	722	0	1525	41
User Adj:	1.00	1.00	1.00	1.00	1.00	1.00	1.00	1.00	0.00	1.00	1.00	1.00
PHF Adj:	1.00	1.00	1.00	1.00	1.00	1.00	1.00	1.00	0.00	1.00	1.00	1.00
PHF Volume:	345	46	18	51	0	133	120	1099	0	0	1525	41
Reduct Vol:	0	0	0	0	0	0	0	0	0	0	0	0
Reduced Vol:	345	46	18	51	0	133	120	1099	0	0	1525	41
PCE Adj:	1.00	1.00	1.00	1.00	1.00	1.00	1.00	1.00	0.00	1.00	1.00	1.00
MLF Adj:	1.00	1.00	1.00	1.00	1.00	1.00	1.00	1.00	0.00	1.00	1.00	1.00
Final Volume:	345	46	18	51	0	133	120	1099	0	0	1525	41

Saturation Flow Module:

Sat/Lane:	1900	1900	1900	1900	1900	1900	1900	1900	1900	1900	1900	1900
Adjustment:	0.96	0.96	0.85	0.95	1.00	0.85	0.95	0.91	1.00	1.00	0.91	0.91
Lanes:	1.76	0.24	1.00	1.00	0.00	1.00	1.00	3.00	1.00	0.00	2.92	0.08
Final Sat.:	3212	428	1615	1805	0	1615	1805	5187	1900	0	5031	135

Capacity Analysis Module:

Vol/Sat:	0.11	0.11	0.01	0.03	0.00	0.08	0.07	0.21	0.00	0.00	0.30	0.30
Crit Moves:	****			****			****			****		
Green/Cycle:	0.18	0.18	0.18	0.14	0.00	0.14	0.11	0.63	0.00	0.00	0.51	0.51
Volume/Cap:	0.59	0.59	0.06	0.20	0.00	0.59	0.59	0.34	0.00	0.00	0.59	0.59
Delay/Veh:	38.8	38.8	33.9	38.5	0.0	44.3	46.6	8.9	0.0	0.0	17.2	17.2
User DelAdj:	1.00	1.00	1.00	1.00	1.00	1.00	1.00	1.00	1.00	1.00	1.00	1.00
AdjDel/Veh:	38.8	38.8	33.9	38.5	0.0	44.3	46.6	8.9	0.0	0.0	17.2	17.2
LOS by Move:	D	D	C	D	A	D	D	A	A	A	B	B
HCM2k85thQ:	10	10	1	2	0	7	7	9	0	0	19	19

Note: Queue reported is the number of cars per lane.

Santa Ana Circulation Element

Level Of Service Computation Report
 2000 HCM Operations Method (Base Volume Alternative)

 Intersection #60 Penn Wy and I-5 SB Ramps

Cycle (sec): 100 Critical Vol./Cap.(X): 0.423
 Loss Time (sec): 5 Average Delay (sec/veh): 22.0
 Optimal Cycle: 22 Level Of Service: C

Approach:	North Bound			South Bound			East Bound			West Bound		
Movement:	L	T	R	L	T	R	L	T	R	L	T	R
Control:	Protected			Protected			Split Phase			Split Phase		
Rights:	Include			Include			Include			Ovl		
Min. Green:	0	0	0	0	0	0	0	0	0	0	0	0
Y+R:	4.0	4.0	4.0	4.0	4.0	4.0	4.0	4.0	4.0	4.0	4.0	4.0
Lanes:	0	0	2	0	1	1	2	0	0	0	0	2

Volume Module:

Base Vol:	0	363	238	550	127	0	0	0	0	175	0	150
Growth Adj:	1.00	1.00	1.00	1.00	1.00	1.00	1.00	1.00	1.00	1.00	1.00	1.00
Initial Bse:	0	363	238	550	127	0	0	0	0	175	0	150
User Adj:	1.00	1.00	1.00	1.00	1.00	1.00	1.00	1.00	1.00	1.00	1.00	1.00
PHF Adj:	1.00	1.00	1.00	1.00	1.00	1.00	1.00	1.00	1.00	1.00	1.00	1.00
PHF Volume:	0	363	238	550	127	0	0	0	0	175	0	150
Reduct Vol:	0	0	0	0	0	0	0	0	0	0	0	0
Reduced Vol:	0	363	238	550	127	0	0	0	0	175	0	150
PCE Adj:	1.00	1.00	1.00	1.00	1.00	1.00	1.00	1.00	1.00	1.00	1.00	1.00
MLF Adj:	1.00	1.00	1.00	1.00	1.00	1.00	1.00	1.00	1.00	1.00	1.00	1.00
Final Volume:	0	363	238	550	127	0	0	0	0	175	0	150

Saturation Flow Module:

Sat/Lane:	1900	1900	1900	1900	1900	1900	1900	1900	1900	1900	1900	1900
Adjustment:	1.00	0.95	0.85	0.92	0.95	1.00	1.00	1.00	1.00	0.95	1.00	0.75
Lanes:	0.00	2.00	1.00	2.00	2.00	0.00	0.00	0.00	0.00	1.00	0.00	2.00
Final Sat.:	0	3610	1615	3502	3610	0	0	0	0	1805	0	2842

Capacity Analysis Module:

Vol/Sat:	0.00	0.10	0.15	0.16	0.04	0.00	0.00	0.00	0.00	0.10	0.00	0.05
Crit Moves:	****			****						****		
Green/Cycle:	0.00	0.35	0.35	0.37	0.72	0.00	0.00	0.00	0.00	0.23	0.00	0.60
Volume/Cap:	0.00	0.29	0.42	0.42	0.05	0.00	0.00	0.00	0.00	0.42	0.00	0.09
Delay/Veh:	0.0	23.7	25.4	23.6	4.1	0.0	0.0	0.0	0.0	33.6	0.0	8.4
User DelAdj:	1.00	1.00	1.00	1.00	1.00	1.00	1.00	1.00	1.00	1.00	1.00	1.00
AdjDel/Veh:	0.0	23.7	25.4	23.6	4.1	0.0	0.0	0.0	0.0	33.6	0.0	8.4
LOS by Move:	A	C	C	C	A	A	A	A	A	C	A	A
HCM2k85thQ:	0	7	9	10	1	0	0	0	0	8	0	2

 Note: Queue reported is the number of cars per lane.

Santa Ana Circulation Element

Level Of Service Computation Report
 2000 HCM 4-Way Stop Method (Base Volume Alternative)

 Intersection #61 Santiago St and Civic Center Dr

Cycle (sec): 100 Critical Vol./Cap.(X): 0.674
 Loss Time (sec): 5 Average Delay (sec/veh): 17.1
 Optimal Cycle: 0 Level Of Service: C

Approach:	North Bound			South Bound			East Bound			West Bound		
Movement:	L	T	R	L	T	R	L	T	R	L	T	R
Control:	Stop Sign			Stop Sign			Stop Sign			Stop Sign		
Rights:	Include			Include			Include			Include		
Min. Green:	0	0	0	0	0	0	0	0	0	0	0	0
Lanes:	1	0	0	1	0	0	0	1	0	0	0	1

Volume Module:	North Bound			South Bound			East Bound			West Bound		
Base Vol:	97	299	30	13	187	48	266	76	269	14	19	18
Growth Adj:	1.00	1.00	1.00	1.00	1.00	1.00	1.00	1.00	1.00	1.00	1.00	1.00
Initial Bse:	97	299	30	13	187	48	266	76	269	14	19	18
User Adj:	1.00	1.00	1.00	1.00	1.00	1.00	1.00	1.00	1.00	1.00	1.00	1.00
PHF Adj:	1.00	1.00	1.00	1.00	1.00	1.00	1.00	1.00	1.00	1.00	1.00	1.00
PHF Volume:	97	299	30	13	187	48	266	76	269	14	19	18
Reduct Vol:	0	0	0	0	0	0	0	0	0	0	0	0
Reduced Vol:	97	299	30	13	187	48	266	76	269	14	19	18
PCE Adj:	1.00	1.00	1.00	1.00	1.00	1.00	1.00	1.00	1.00	1.00	1.00	1.00
MLF Adj:	1.00	1.00	1.00	1.00	1.00	1.00	1.00	1.00	1.00	1.00	1.00	1.00
FinalVolume:	97	299	30	13	187	48	266	76	269	14	19	18

Saturation Flow Module:	North Bound			South Bound			East Bound			West Bound		
Adjustment:	1.00	1.00	1.00	1.00	1.00	1.00	1.00	1.00	1.00	1.00	1.00	1.00
Lanes:	1.00	0.91	0.09	1.00	0.80	0.20	0.78	0.22	1.00	0.27	0.38	0.35
Final Sat.:	481	478	48	458	401	103	395	113	597	122	166	157

Capacity Analysis Module:	North Bound			South Bound			East Bound			West Bound		
Vol/Sat:	0.20	0.63	0.63	0.03	0.47	0.47	0.67	0.67	0.45	0.11	0.11	0.11
Crit Moves:	****			****			****			****		
Delay/Veh:	11.7	19.4	19.4	10.4	15.1	15.1	22.2	22.2	13.1	11.2	11.2	11.2
Delay Adj:	1.00	1.00	1.00	1.00	1.00	1.00	1.00	1.00	1.00	1.00	1.00	1.00
AdjDel/Veh:	11.7	19.4	19.4	10.4	15.1	15.1	22.2	22.2	13.1	11.2	11.2	11.2
LOS by Move:	B	C	C	B	C	C	C	C	B	B	B	B
ApproachDel:	17.6			14.8			18.2			11.2		
Delay Adj:	1.00			1.00			1.00			1.00		
ApprAdjDel:	17.6			14.8			18.2			11.2		
LOS by Appr:	C			B			C			B		
AllWayAvgQ:	0.2	1.5	1.5	0.0	0.8	0.8	1.8	1.8	0.7	0.1	0.1	0.1

 Note: Queue reported is the number of cars per lane.

Santa Ana Circulation Element

Level Of Service Computation Report

ICU 1(Loss as Cycle Length %) Method (Base Volume Alternative)

Intersection #62 Santiago St and Santa Ana Blvd

Cycle (sec): 100 Critical Vol./Cap.(X): 0.569
 Loss Time (sec): 5 Average Delay (sec/veh): xxxxxx
 Optimal Cycle: 27 Level Of Service: A

Approach:	North Bound			South Bound			East Bound			West Bound		
Movement:	L	T	R	L	T	R	L	T	R	L	T	R
Control:	Permitted			Permitted			Protected			Protected		
Rights:	Include			Include			Include			Include		
Min. Green:	0	0	0	0	0	0	0	0	0	0	0	0
Y+R:	4.0	4.0	4.0	4.0	4.0	4.0	4.0	4.0	4.0	4.0	4.0	4.0
Lanes:	1	0	1	0	1	0	1	1	0	1	0	1

Volume Module:

Base Vol:	36	133	84	297	120	61	71	649	20	73	492	187
Growth Adj:	1.00	1.00	1.00	1.00	1.00	1.00	1.00	1.00	1.00	1.00	1.00	1.00
Initial Bse:	36	133	84	297	120	61	71	649	20	73	492	187
User Adj:	1.00	1.00	1.00	1.00	1.00	1.00	1.00	1.00	1.00	1.00	1.00	1.00
PHF Adj:	1.00	1.00	1.00	1.00	1.00	1.00	1.00	1.00	1.00	1.00	1.00	1.00
PHF Volume:	36	133	84	297	120	61	71	649	20	73	492	187
Reduct Vol:	0	0	0	0	0	0	0	0	0	0	0	0
Reduced Vol:	36	133	84	297	120	61	71	649	20	73	492	187
PCE Adj:	1.00	1.00	1.00	1.00	1.00	1.00	1.00	1.00	1.00	1.00	1.00	1.00
MLF Adj:	1.00	1.00	1.00	1.00	1.00	1.00	1.00	1.00	1.00	1.00	1.00	1.00
FinalVolume:	36	133	84	297	120	61	71	649	20	73	492	187

Saturation Flow Module:

Sat/Lane:	1600	1600	1600	1600	1600	1600	1600	1600	1600	1600	1600	1600
Adjustment:	1.00	1.06	1.00	1.00	1.06	1.00	1.00	1.03	1.00	1.00	1.06	1.00
Lanes:	1.00	1.00	1.00	1.00	1.00	1.00	1.00	1.94	0.06	1.00	2.00	1.00
Final Sat.:	1600	1700	1600	1600	1700	1600	1600	3204	96	1600	3400	1600

Capacity Analysis Module:

Vol/Sat:	0.02	0.08	0.05	0.19	0.07	0.04	0.04	0.20	0.21	0.05	0.14	0.12
Crit Moves:	****			****			****			****		

Santa Ana Circulation Element

Level Of Service Computation Report

ICU 1(Loss as Cycle Length %) Method (Base Volume Alternative)

Intersection #64 Standard Ave and 1st St

Cycle (sec): 100 Critical Vol./Cap.(X): 0.842
 Loss Time (sec): 5 Average Delay (sec/veh): xxxxxx
 Optimal Cycle: 62 Level Of Service: D

Approach:	North Bound			South Bound			East Bound			West Bound		
Movement:	L	T	R	L	T	R	L	T	R	L	T	R
Control:	Permitted			Permitted			Protected			Protected		
Rights:	Include			Include			Include			Include		
Min. Green:	0	0	0	0	0	0	0	0	0	0	0	0
Y+R:	4.0	4.0	4.0	4.0	4.0	4.0	4.0	4.0	4.0	4.0	4.0	4.0
Lanes:	1	0	0	1	0	0	1	0	1	1	0	1

Volume Module:

Base Vol:	185	367	119	19	189	23	177	1218	129	91	1148	21
Growth Adj:	1.00	1.00	1.00	1.00	1.00	1.00	1.00	1.00	1.00	1.00	1.00	1.00
Initial Bse:	185	367	119	19	189	23	177	1218	129	91	1148	21
User Adj:	1.00	1.00	1.00	1.00	1.00	1.00	1.00	1.00	1.00	1.00	1.00	1.00
PHF Adj:	1.00	1.00	1.00	1.00	1.00	1.00	1.00	1.00	1.00	1.00	1.00	1.00
PHF Volume:	185	367	119	19	189	23	177	1218	129	91	1148	21
Reduct Vol:	0	0	0	0	0	0	0	0	0	0	0	0
Reduced Vol:	185	367	119	19	189	23	177	1218	129	91	1148	21
PCE Adj:	1.00	1.00	1.00	1.00	1.00	1.00	1.00	1.00	1.00	1.00	1.00	1.00
MLF Adj:	1.00	1.00	1.00	1.00	1.00	1.00	1.00	1.00	1.00	1.00	1.00	1.00
FinalVolume:	185	367	119	19	189	23	177	1218	129	91	1148	21

Saturation Flow Module:

Sat/Lane:	1600	1600	1600	1600	1600	1600	1600	1600	1600	1600	1600	1600
Adjustment:	1.00	1.00	1.00	1.00	1.00	1.00	1.00	1.03	1.00	1.00	1.03	1.00
Lanes:	1.00	0.76	0.24	0.08	0.82	0.10	1.00	1.81	0.19	1.00	1.96	0.04
Final Sat.:	1600	1208	392	132	1309	159	1600	2994	306	1600	3243	57

Capacity Analysis Module:

Vol/Sat:	0.12	0.30	0.30	0.01	0.14	0.14	0.11	0.41	0.42	0.06	0.35	0.37
Crit Moves:	****			****			****			****		

Santa Ana Circulation Element

Level Of Service Computation Report

ICU 1(Loss as Cycle Length %) Method (Base Volume Alternative)

Intersection #65 Standard Ave and Mcfadden Ave

Cycle (sec): 100 Critical Vol./Cap.(X): 0.682
 Loss Time (sec): 5 Average Delay (sec/veh): xxxxxx
 Optimal Cycle: 35 Level Of Service: B

Approach:	North Bound			South Bound			East Bound			West Bound		
Movement:	L	T	R	L	T	R	L	T	R	L	T	R
Control:	Protected			Protected			Protected			Protected		
Rights:	Include			Include			Include			Include		
Min. Green:	0	0	0	0	0	0	0	0	0	0	0	0
Y+R:	4.0	4.0	4.0	4.0	4.0	4.0	4.0	4.0	4.0	4.0	4.0	4.0
Lanes:	1	0	1	1	0	1	1	0	1	1	0	1

Volume Module:

Base Vol:	169	667	82	137	300	52	53	351	60	117	712	206
Growth Adj:	1.00	1.00	1.00	1.00	1.00	1.00	1.00	1.00	1.00	1.00	1.00	1.00
Initial Bse:	169	667	82	137	300	52	53	351	60	117	712	206
User Adj:	1.00	1.00	1.00	1.00	1.00	1.00	1.00	1.00	1.00	1.00	1.00	1.00
PHF Adj:	1.00	1.00	1.00	1.00	1.00	1.00	1.00	1.00	1.00	1.00	1.00	1.00
PHF Volume:	169	667	82	137	300	52	53	351	60	117	712	206
Reduct Vol:	0	0	0	0	0	0	0	0	0	0	0	0
Reduced Vol:	169	667	82	137	300	52	53	351	60	117	712	206
PCE Adj:	1.00	1.00	1.00	1.00	1.00	1.00	1.00	1.00	1.00	1.00	1.00	1.00
MLF Adj:	1.00	1.00	1.00	1.00	1.00	1.00	1.00	1.00	1.00	1.00	1.00	1.00
FinalVolume:	169	667	82	137	300	52	53	351	60	117	712	206

Saturation Flow Module:

Sat/Lane:	1600	1600	1600	1600	1600	1600	1600	1600	1600	1600	1600	1600
Adjustment:	1.00	1.04	1.00	1.00	1.04	1.00	1.00	1.04	1.00	1.00	1.04	1.00
Lanes:	1.00	1.78	0.22	1.00	1.70	0.30	1.00	1.71	0.29	1.00	1.55	0.45
Final Sat.:	1600	2950	350	1600	2827	473	1600	2833	467	1600	2582	718

Capacity Analysis Module:

Vol/Sat:	0.11	0.23	0.23	0.09	0.11	0.11	0.03	0.12	0.13	0.07	0.28	0.29
Crit Moves:	****			****			****			****		

Santa Ana Circulation Element

Level Of Service Computation Report

ICU 1(Loss as Cycle Length %) Method (Base Volume Alternative)

Intersection #66 Halladay St and Warner Ave

Cycle (sec): 100 Critical Vol./Cap.(X): 0.677
Loss Time (sec): 5 Average Delay (sec/veh): xxxxxx
Optimal Cycle: 35 Level Of Service: B

Table with 4 columns: North Bound, South Bound, East Bound, West Bound. Rows include Movement (L-T-R), Control (Permitted), Rights (Include), Min. Green, Y+R, and Lanes.

Volume Module table with 12 columns representing different volume categories and 12 rows for various adjustment factors like Base Vol, Growth Adj, PHF Adj, etc.

Saturation Flow Module table with 12 columns and 4 rows showing Sat/Lane, Adjustment, Lanes, and Final Sat.

Capacity Analysis Module table with 12 columns and 2 rows showing Vol/Sat and Crit Moves.

Santa Ana Circulation Element

Level Of Service Computation Report

ICU 1(Loss as Cycle Length %) Method (Base Volume Alternative)

Intersection #67 Halladay St and Dyer Rd

Cycle (sec): 100 Critical Vol./Cap.(X): 0.784
 Loss Time (sec): 5 Average Delay (sec/veh): xxxxxx
 Optimal Cycle: 49 Level Of Service: C

Approach:	North Bound			South Bound			East Bound			West Bound		
Movement:	L	T	R	L	T	R	L	T	R	L	T	R
Control:	Split Phase			Split Phase			Protected			Protected		
Rights:	Include			Include			Include			Include		
Min. Green:	0	0	0	0	0	0	0	0	0	0	0	0
Y+R:	4.0	4.0	4.0	4.0	4.0	4.0	4.0	4.0	4.0	4.0	4.0	4.0
Lanes:	1	0	0	1	0	0	1	0	2	1	0	2

Volume Module:

Base Vol:	41	180	208	114	15	32	150	1298	9	45	1451	116
Growth Adj:	1.00	1.00	1.00	1.00	1.00	1.00	1.00	1.00	1.00	1.00	1.00	1.00
Initial Bse:	41	180	208	114	15	32	150	1298	9	45	1451	116
User Adj:	1.00	1.00	1.00	1.00	1.00	1.00	1.00	1.00	1.00	1.00	1.00	1.00
PHF Adj:	1.00	1.00	1.00	1.00	1.00	1.00	1.00	1.00	1.00	1.00	1.00	1.00
PHF Volume:	41	180	208	114	15	32	150	1298	9	45	1451	116
Reduct Vol:	0	0	0	0	0	0	0	0	0	0	0	0
Reduced Vol:	41	180	208	114	15	32	150	1298	9	45	1451	116
PCE Adj:	1.00	1.00	1.00	1.00	1.00	1.00	1.00	1.00	1.00	1.00	1.00	1.00
MLF Adj:	1.00	1.00	1.00	1.00	1.00	1.00	1.00	1.00	1.00	1.00	1.00	1.00
FinalVolume:	41	180	208	114	15	32	150	1298	9	45	1451	116

Saturation Flow Module:

Sat/Lane:	1600	1600	1600	1600	1600	1600	1600	1600	1600	1600	1600	1600
Adjustment:	1.00	1.00	1.00	1.00	1.00	1.00	1.00	1.04	1.00	1.00	1.04	1.00
Lanes:	1.00	0.46	0.54	1.00	0.32	0.68	1.00	2.98	0.02	1.00	2.78	0.22
Final Sat.:	1600	742	858	1600	511	1089	1600	4967	33	1600	4645	355

Capacity Analysis Module:

Vol/Sat:	0.03	0.24	0.24	0.07	0.03	0.03	0.09	0.26	0.27	0.03	0.31	0.33
Crit Moves:	****			****			****			****		

Santa Ana Circulation Element

Level Of Service Computation Report
 2000 HCM Operations Method (Base Volume Alternative)

 Intersection #68 SR-55 SB Ramps and MacArthur Blvd

Cycle (sec): 100 Critical Vol./Cap.(X): 0.569
 Loss Time (sec): 5 Average Delay (sec/veh): 17.3
 Optimal Cycle: 28 Level Of Service: B

Approach:	North Bound			South Bound			East Bound			West Bound		
Movement:	L	T	R	L	T	R	L	T	R	L	T	R
Control:	Split Phase			Split Phase			Protected			Protected		
Rights:	Include			Include			Ignore			Ignore		
Min. Green:	0	0	0	0	0	0	0	0	0	0	0	0
Y+R:	4.0	4.0	4.0	4.0	4.0	4.0	4.0	4.0	4.0	4.0	4.0	4.0
Lanes:	0	0	0	2	0	0	0	0	2	1	1	0

Volume Module:

Base Vol:	0	0	0	288	0	697	0	1167	1040	0	1532	602
Growth Adj:	1.00	1.00	1.00	1.00	1.00	1.00	1.00	1.00	1.00	1.00	1.00	1.00
Initial Bse:	0	0	0	288	0	697	0	1167	1040	0	1532	602
User Adj:	1.00	1.00	1.00	1.00	1.00	1.00	1.00	1.00	0.00	1.00	1.00	0.00
PHF Adj:	1.00	1.00	1.00	1.00	1.00	1.00	1.00	1.00	0.00	1.00	1.00	0.00
PHF Volume:	0	0	0	288	0	697	0	1167	0	0	1532	0
Reduct Vol:	0	0	0	0	0	0	0	0	0	0	0	0
Reduced Vol:	0	0	0	288	0	697	0	1167	0	0	1532	0
PCE Adj:	1.00	1.00	1.00	1.00	1.00	1.00	1.00	1.00	0.00	1.00	1.00	0.00
MLF Adj:	1.00	1.00	1.00	1.00	1.00	1.00	1.00	1.00	0.00	1.00	1.00	0.00
FinalVolume:	0	0	0	288	0	697	0	1167	0	0	1532	0

Saturation Flow Module:

Sat/Lane:	1900	1900	1900	1900	1900	1900	1900	1900	1900	1900	1900	1900
Adjustment:	1.00	1.00	1.00	0.92	1.00	0.75	1.00	0.91	0.91	1.00	0.91	1.00
Lanes:	0.00	0.00	0.00	2.00	0.00	2.00	0.00	3.00	1.00	0.00	3.00	1.00
Final Sat.:	0	0	0	3502	0	2842	0	5187	1729	0	5187	1900

Capacity Analysis Module:

Vol/Sat:	0.00	0.00	0.00	0.08	0.00	0.25	0.00	0.22	0.00	0.00	0.30	0.00
Crit Moves:						****	****				****	
Green/Cycle:	0.00	0.00	0.00	0.43	0.00	0.43	0.00	0.52	0.00	0.00	0.52	0.00
Volume/Cap:	0.00	0.00	0.00	0.19	0.00	0.57	0.00	0.43	0.00	0.00	0.57	0.00
Delay/Veh:	0.0	0.0	0.0	17.7	0.0	22.1	0.0	15.0	0.0	0.0	16.7	0.0
User DelAdj:	1.00	1.00	1.00	1.00	1.00	1.00	1.00	1.00	1.00	1.00	1.00	1.00
AdjDel/Veh:	0.0	0.0	0.0	17.7	0.0	22.1	0.0	15.0	0.0	0.0	16.7	0.0
LOS by Move:	A	A	A	B	A	C	A	B	A	A	B	A
HCM2k85thQ:	0	0	0	4	0	15	0	12	0	0	18	0

 Note: Queue reported is the number of cars per lane.

Santa Ana Circulation Element

Level Of Service Computation Report
 2000 HCM Operations Method (Base Volume Alternative)

 Intersection #69 SR-55 NB Ramps and MacArthur Blvd

Cycle (sec): 100 Critical Vol./Cap.(X): 0.497
 Loss Time (sec): 5 Average Delay (sec/veh): 14.8
 Optimal Cycle: 25 Level Of Service: B

Approach:	North Bound			South Bound			East Bound			West Bound		
Movement:	L	T	R	L	T	R	L	T	R	L	T	R
Control:	Split Phase			Split Phase			Protected			Protected		
Rights:	Ignore			Include			Ignore			Ignore		
Min. Green:	0	0	0	0	0	0	0	0	0	0	0	0
Y+R:	4.0	4.0	4.0	4.0	4.0	4.0	4.0	4.0	4.0	4.0	4.0	4.0
Lanes:	2	0	0	0	0	0	0	0	2	0	0	3

Volume Module:

Base Vol:	641	0	426	0	0	0	0	711	731	0	1501	1081
Growth Adj:	1.00	1.00	1.00	1.00	1.00	1.00	1.00	1.00	1.00	1.00	1.00	1.00
Initial Bse:	641	0	426	0	0	0	0	711	731	0	1501	1081
User Adj:	1.00	1.00	0.00	1.00	1.00	1.00	1.00	1.00	0.00	1.00	1.00	0.00
PHF Adj:	1.00	1.00	0.00	1.00	1.00	1.00	1.00	1.00	0.00	1.00	1.00	0.00
PHF Volume:	641	0	0	0	0	0	0	711	0	0	1501	0
Reduct Vol:	0	0	0	0	0	0	0	0	0	0	0	0
Reduced Vol:	641	0	0	0	0	0	0	711	0	0	1501	0
PCE Adj:	1.00	1.00	0.00	1.00	1.00	1.00	1.00	1.00	0.00	1.00	1.00	0.00
MLF Adj:	1.00	1.00	0.00	1.00	1.00	1.00	1.00	1.00	0.00	1.00	1.00	0.00
FinalVolume:	641	0	0	0	0	0	0	711	0	0	1501	0

Saturation Flow Module:

Sat/Lane:	1900	1900	1900	1900	1900	1900	1900	1900	1900	1900	1900	1900
Adjustment:	0.92	1.00	1.00	1.00	1.00	1.00	1.00	0.95	0.88	1.00	0.91	1.00
Lanes:	2.00	0.00	1.00	0.00	0.00	0.00	0.00	2.00	2.00	0.00	3.00	1.00
Final Sat.:	3502	0	1900	0	0	0	0	3610	3344	0	5187	1900

Capacity Analysis Module:

Vol/Sat:	0.18	0.00	0.00	0.00	0.00	0.00	0.00	0.20	0.00	0.00	0.29	0.00
Crit Moves:	****						****			****		
Green/Cycle:	0.37	0.00	0.00	0.00	0.00	0.00	0.00	0.58	0.00	0.00	0.58	0.00
Volume/Cap:	0.50	0.00	0.00	0.00	0.00	0.00	0.00	0.34	0.00	0.00	0.50	0.00
Delay/Veh:	24.7	0.0	0.0	0.0	0.0	0.0	0.0	11.0	0.0	0.0	12.4	0.0
User DelAdj:	1.00	1.00	1.00	1.00	1.00	1.00	1.00	1.00	1.00	1.00	1.00	1.00
AdjDel/Veh:	24.7	0.0	0.0	0.0	0.0	0.0	0.0	11.0	0.0	0.0	12.4	0.0
LOS by Move:	C	A	A	A	A	A	A	B	A	A	B	A
HCM2k85thQ:	12	0	0	0	0	0	0	9	0	0	15	0

 Note: Queue reported is the number of cars per lane.

Santa Ana Circulation Element

Level Of Service Computation Report
2000 HCM Operations Method (Base Volume Alternative)

Intersection #70 SR-55 SB Ramps and Dyer Rd

Cycle (sec): 100 Critical Vol./Cap.(X): 0.669
Loss Time (sec): 5 Average Delay (sec/veh): 25.7
Optimal Cycle: 36 Level Of Service: C

Table with 4 columns: North Bound, South Bound, East Bound, West Bound. Rows include Movement, Control, Rights, Min. Green, Y+R, and Lanes.

Volume Module: Table with 12 columns representing different traffic volumes and adjustment factors like Base Vol, Growth Adj, etc.

Saturation Flow Module: Table with 12 columns showing saturation flow rates and adjustment factors like Sat/Lane, Adjustment, etc.

Capacity Analysis Module: Table with 12 columns showing capacity analysis metrics like Vol/Sat, Crit Moves, Green/Cycle, etc.

Note: Queue reported is the number of cars per lane.

Santa Ana Circulation Element

Level Of Service Computation Report

ICU 1(Loss as Cycle Length %) Method (Base Volume Alternative)

Intersection #71 Glassell St and La Veta Ave

Cycle (sec): 100 Critical Vol./Cap.(X): 0.620
 Loss Time (sec): 5 Average Delay (sec/veh): xxxxxx
 Optimal Cycle: 30 Level Of Service: B

Approach:	North Bound			South Bound			East Bound			West Bound		
Movement:	L	T	R	L	T	R	L	T	R	L	T	R
Control:	Protected			Protected			Protected			Protected		
Rights:	Ovl			Include			Ovl			Include		
Min. Green:	0	0	0	0	0	0	0	0	0	0	0	0
Y+R:	4.0	4.0	4.0	4.0	4.0	4.0	4.0	4.0	4.0	4.0	4.0	4.0
Lanes:	2	0	1	0	1	0	1	0	1	0	1	0

Volume Module:

Base Vol:	472	490	160	15	499	37	82	268	461	155	280	11
Growth Adj:	1.00	1.00	1.00	1.00	1.00	1.00	1.00	1.00	1.00	1.00	1.00	1.00
Initial Bse:	472	490	160	15	499	37	82	268	461	155	280	11
User Adj:	1.00	1.00	1.00	1.00	1.00	1.00	1.00	1.00	1.00	1.00	1.00	1.00
PHF Adj:	1.00	1.00	1.00	1.00	1.00	1.00	1.00	1.00	1.00	1.00	1.00	1.00
PHF Volume:	472	490	160	15	499	37	82	268	461	155	280	11
Reduct Vol:	0	0	0	0	0	0	0	0	0	0	0	0
Reduced Vol:	472	490	160	15	499	37	82	268	461	155	280	11
PCE Adj:	1.00	1.00	1.00	1.00	1.00	1.00	1.00	1.00	1.00	1.00	1.00	1.00
MLF Adj:	1.00	1.00	1.00	1.00	1.00	1.00	1.00	1.00	1.00	1.00	1.00	1.00
FinalVolume:	472	490	160	15	499	37	82	268	461	155	280	11
OvlAdjVol:	5						225					

Saturation Flow Module:

Sat/Lane:	1600	1600	1600	1600	1600	1600	1600	1600	1600	1600	1600	1600
Adjustment:	1.00	1.06	1.00	1.00	1.03	1.00	1.00	1.06	1.00	1.00	1.03	1.00
Lanes:	2.00	1.00	1.00	1.00	1.86	0.14	1.00	1.00	1.00	1.00	1.92	0.08
Final Sat.:	3200	1700	1600	1600	3079	221	1600	1700	1600	1600	3179	121

Capacity Analysis Module:

Vol/Sat:	0.15	0.29	0.10	0.01	0.16	0.17	0.05	0.16	0.29	0.10	0.09	0.09
OvlAdjV/S:	0.00						0.14					
Crit Moves:	****			****			****			****		

Santa Ana Circulation Element

Level Of Service Computation Report
 2000 HCM Operations Method (Base Volume Alternative)

 Intersection #72 Glassell St and SR-22 WB Ramps

Cycle (sec): 100 Critical Vol./Cap.(X): 0.766
 Loss Time (sec): 5 Average Delay (sec/veh): 24.8
 Optimal Cycle: 48 Level Of Service: C

Approach:	North Bound			South Bound			East Bound			West Bound		
Movement:	L	T	R	L	T	R	L	T	R	L	T	R
Control:	Protected			Permitted			Split Phase			Split Phase		
Rights:	Include			Include			Include			Include		
Min. Green:	0	0	0	0	0	0	0	0	0	0	0	0
Y+R:	4.0	4.0	4.0	4.0	4.0	4.0	4.0	4.0	4.0	4.0	4.0	4.0
Lanes:	1	0	2	0	0	2	0	0	0	1	0	1

Volume Module:

Base Vol:	557	910	0	0	878	255	0	0	0	201	7	357
Growth Adj:	1.00	1.00	1.00	1.00	1.00	1.00	1.00	1.00	1.00	1.00	1.00	1.00
Initial Bse:	557	910	0	0	878	255	0	0	0	201	7	357
User Adj:	1.00	1.00	1.00	1.00	1.00	1.00	1.00	1.00	1.00	1.00	1.00	1.00
PHF Adj:	1.00	1.00	1.00	1.00	1.00	1.00	1.00	1.00	1.00	1.00	1.00	1.00
PHF Volume:	557	910	0	0	878	255	0	0	0	201	7	357
Reduct Vol:	0	0	0	0	0	0	0	0	0	0	0	0
Reduced Vol:	557	910	0	0	878	255	0	0	0	201	7	357
PCE Adj:	1.00	1.00	1.00	1.00	1.00	1.00	1.00	1.00	1.00	1.00	1.00	1.00
MLF Adj:	1.00	1.00	1.00	1.00	1.00	1.00	1.00	1.00	1.00	1.00	1.00	1.00
Final Volume:	557	910	0	0	878	255	0	0	0	201	7	357

Saturation Flow Module:

Sat/Lane:	1900	1900	1900	1900	1900	1900	1900	1900	1900	1900	1900	1900
Adjustment:	0.95	0.95	1.00	1.00	0.95	0.85	1.00	1.00	1.00	0.86	0.86	0.86
Lanes:	1.00	2.00	0.00	0.00	2.00	1.00	0.00	0.00	0.00	1.35	0.02	1.63
Final Sat.:	1805	3610	0	0	3610	1615	0	0	0	2201	40	2645

Capacity Analysis Module:

Vol/Sat:	0.31	0.25	0.00	0.00	0.24	0.16	0.00	0.00	0.00	0.09	0.18	0.13
Crit Moves:	****				****						****	
Green/Cycle:	0.40	0.72	0.00	0.00	0.32	0.32	0.00	0.00	0.00	0.23	0.23	0.23
Volume/Cap:	0.77	0.35	0.00	0.00	0.77	0.50	0.00	0.00	0.00	0.40	0.77	0.59
Delay/Veh:	30.7	5.3	0.0	0.0	33.9	28.4	0.0	0.0	0.0	32.9	40.8	35.3
User DelAdj:	1.00	1.00	1.00	1.00	1.00	1.00	1.00	1.00	1.00	1.00	1.00	1.00
AdjDel/Veh:	30.7	5.3	0.0	0.0	33.9	28.4	0.0	0.0	0.0	32.9	40.8	35.3
LOS by Move:	C	A	A	A	C	C	A	A	A	C	D	D
HCM2k85thQ:	24	9	0	0	21	10	0	0	0	6	15	10

 Note: Queue reported is the number of cars per lane.

Santa Ana Circulation Element

Level Of Service Computation Report
 2000 HCM Operations Method (Base Volume Alternative)

 Intersection #73 Grand Ave / Glassell St and SR-22 EB Ramps

Cycle (sec): 100 Critical Vol./Cap.(X): 0.812
 Loss Time (sec): 5 Average Delay (sec/veh): 26.5
 Optimal Cycle: 57 Level Of Service: C

Approach:	North Bound			South Bound			East Bound			West Bound		
Movement:	L	T	R	L	T	R	L	T	R	L	T	R
Control:	Permitted			Protected			Split Phase			Split Phase		
Rights:	Include			Include			Include			Include		
Min. Green:	0	0	0	0	0	0	0	0	0	0	0	0
Y+R:	4.0	4.0	4.0	4.0	4.0	4.0	4.0	4.0	4.0	4.0	4.0	4.0
Lanes:	0	0	2	0	1	0	1	0	1	0	0	0

Volume Module:

Base Vol:	0	1202	307	381	681	0	229	4	503	0	0	0
Growth Adj:	1.00	1.00	1.00	1.00	1.00	1.00	1.00	1.00	1.00	1.00	1.00	1.00
Initial Bse:	0	1202	307	381	681	0	229	4	503	0	0	0
User Adj:	1.00	1.00	1.00	1.00	1.00	1.00	1.00	1.00	1.00	1.00	1.00	1.00
PHF Adj:	1.00	1.00	1.00	1.00	1.00	1.00	1.00	1.00	1.00	1.00	1.00	1.00
PHF Volume:	0	1202	307	381	681	0	229	4	503	0	0	0
Reduct Vol:	0	0	0	0	0	0	0	0	0	0	0	0
Reduced Vol:	0	1202	307	381	681	0	229	4	503	0	0	0
PCE Adj:	1.00	1.00	1.00	1.00	1.00	1.00	1.00	1.00	1.00	1.00	1.00	1.00
MLF Adj:	1.00	1.00	1.00	1.00	1.00	1.00	1.00	1.00	1.00	1.00	1.00	1.00
FinalVolume:	0	1202	307	381	681	0	229	4	503	0	0	0

Saturation Flow Module:

Sat/Lane:	1900	1900	1900	1900	1900	1900	1900	1900	1900	1900	1900	1900
Adjustment:	1.00	0.95	0.85	0.95	0.95	1.00	0.86	0.86	0.86	1.00	1.00	1.00
Lanes:	0.00	2.00	1.00	1.00	2.00	0.00	1.31	0.01	1.68	0.00	0.00	0.00
Final Sat.:	0	3610	1615	1805	3610	0	2129	18	2731	0	0	0

Capacity Analysis Module:

Vol/Sat:	0.00	0.33	0.19	0.21	0.19	0.00	0.11	0.23	0.18	0.00	0.00	0.00
Crit Moves:	****			****			****					
Green/Cycle:	0.00	0.41	0.41	0.26	0.67	0.00	0.28	0.28	0.28	0.00	0.00	0.00
Volume/Cap:	0.00	0.81	0.46	0.81	0.28	0.00	0.38	0.81	0.66	0.00	0.00	0.00
Delay/Veh:	0.0	29.6	22.0	45.1	6.8	0.0	29.2	39.2	33.2	0.0	0.0	0.0
User DelAdj:	1.00	1.00	1.00	1.00	1.00	1.00	1.00	1.00	1.00	1.00	1.00	1.00
AdjDel/Veh:	0.0	29.6	22.0	45.1	6.8	0.0	29.2	39.2	33.2	0.0	0.0	0.0
LOS by Move:	A	C	C	D	A	A	C	D	C	A	A	A
HCM2k85thQ:	0	28	11	20	7	0	7	19	14	0	0	0

 Note: Queue reported is the number of cars per lane.

Santa Ana Circulation Element

Level Of Service Computation Report

ICU 1(Loss as Cycle Length %) Method (Base Volume Alternative)

Intersection #74 Grand Ave and Fairhaven Ave

Cycle (sec): 100 Critical Vol./Cap.(X): 0.675
 Loss Time (sec): 5 Average Delay (sec/veh): xxxxxx
 Optimal Cycle: 35 Level Of Service: B

Approach:	North Bound			South Bound			East Bound			West Bound		
Movement:	L	T	R	L	T	R	L	T	R	L	T	R
Control:	Protected			Protected			Permitted			Permitted		
Rights:	Include			Include			Include			Include		
Min. Green:	0	0	0	0	0	0	0	0	0	0	0	0
Y+R:	4.0	4.0	4.0	4.0	4.0	4.0	4.0	4.0	4.0	4.0	4.0	4.0
Lanes:	1	0	2	1	0	2	1	0	1	1	0	1

Volume Module:

Base Vol:	46	1214	243	222	894	82	79	45	33	255	48	181
Growth Adj:	1.00	1.00	1.00	1.00	1.00	1.00	1.00	1.00	1.00	1.00	1.00	1.00
Initial Bse:	46	1214	243	222	894	82	79	45	33	255	48	181
User Adj:	1.00	1.00	1.00	1.00	1.00	1.00	1.00	1.00	1.00	1.00	1.00	1.00
PHF Adj:	1.00	1.00	1.00	1.00	1.00	1.00	1.00	1.00	1.00	1.00	1.00	1.00
PHF Volume:	46	1214	243	222	894	82	79	45	33	255	48	181
Reduct Vol:	0	0	0	0	0	0	0	0	0	0	0	0
Reduced Vol:	46	1214	243	222	894	82	79	45	33	255	48	181
PCE Adj:	1.00	1.00	1.00	1.00	1.00	1.00	1.00	1.00	1.00	1.00	1.00	1.00
MLF Adj:	1.00	1.00	1.00	1.00	1.00	1.00	1.00	1.00	1.00	1.00	1.00	1.00
Final Volume:	46	1214	243	222	894	82	79	45	33	255	48	181

Saturation Flow Module:

Sat/Lane:	1600	1600	1600	1600	1600	1600	1600	1600	1600	1600	1600	1600
Adjustment:	1.00	1.05	1.00	1.00	1.06	1.00	1.00	1.05	1.00	1.00	1.06	1.00
Lanes:	1.00	2.50	0.50	1.00	2.00	1.00	1.00	1.15	0.85	1.00	1.00	1.00
Final Sat.:	1600	4199	801	1600	3400	1600	1600	1946	1354	1600	1700	1600

Capacity Analysis Module:

Vol/Sat:	0.03	0.29	0.30	0.14	0.26	0.05	0.05	0.02	0.02	0.16	0.03	0.11
Crit Moves:			****	****			****			****		

Santa Ana Circulation Element

Level Of Service Computation Report

ICU 1(Loss as Cycle Length %) Method (Base Volume Alternative)

Intersection #75 Grand Ave and Santa Clara Ave

Cycle (sec): 100 Critical Vol./Cap.(X): 0.748
 Loss Time (sec): 5 Average Delay (sec/veh): xxxxxx
 Optimal Cycle: 43 Level Of Service: C

Approach:	North Bound			South Bound			East Bound			West Bound		
Movement:	L	T	R	L	T	R	L	T	R	L	T	R
Control:	Protected			Protected			Permitted			Permitted		
Rights:	Include			WideBypass			Include			Include		
Min. Green:	0	0	0	0	0	0	0	0	0	0	0	0
Y+R:	4.0	4.0	4.0	4.0	4.0	4.0	4.0	4.0	4.0	4.0	4.0	4.0
Lanes:	1	0	2	1	0	1	1	0	0	1	0	1

Volume Module:

Base Vol:	88	1185	246	220	868	220	159	194	36	136	244	260
Growth Adj:	1.00	1.00	1.00	1.00	1.00	1.00	1.00	1.00	1.00	1.00	1.00	1.00
Initial Bse:	88	1185	246	220	868	220	159	194	36	136	244	260
User Adj:	1.00	1.00	1.00	1.00	1.00	1.00	1.00	1.00	1.00	1.00	1.00	1.00
PHF Adj:	1.00	1.00	1.00	1.00	1.00	1.00	1.00	1.00	1.00	1.00	1.00	1.00
PHF Volume:	88	1185	246	220	868	220	159	194	36	136	244	260
Reduct Vol:	0	0	0	0	0	0	0	0	0	0	0	0
Reduced Vol:	88	1185	246	220	868	220	159	194	36	136	244	260
PCE Adj:	1.00	1.00	1.00	1.00	1.00	1.00	1.00	1.00	1.00	1.00	1.00	1.00
MLF Adj:	1.00	1.00	1.00	1.00	1.00	1.00	1.00	1.00	1.00	1.00	1.00	1.00
FinalVolume:	88	1185	246	220	868	220	159	194	36	136	244	260

Saturation Flow Module:

Sat/Lane:	1600	1600	1600	1600	1600	1600	1600	1600	1600	1600	1600	1600
Adjustment:	1.00	1.05	1.00	1.00	1.04	1.00	1.00	1.00	1.00	1.00	1.06	1.00
Lanes:	1.00	2.48	0.52	1.00	1.60	0.40	1.00	0.84	0.16	1.00	1.00	1.00
Final Sat.:	1600	4175	825	1600	2653	647	1600	1350	250	1600	1700	1600

Capacity Analysis Module:

Vol/Sat:	0.06	0.28	0.30	0.14	0.33	0.34	0.10	0.14	0.14	0.09	0.14	0.16
Crit Moves:			****	****			****					****

Santa Ana Circulation Element

Level Of Service Computation Report

ICU 1(Loss as Cycle Length %) Method (Base Volume Alternative)

Intersection #76 Grand Ave and 17th St

Cycle (sec): 100 Critical Vol./Cap.(X): 0.828
 Loss Time (sec): 5 Average Delay (sec/veh): xxxxxx
 Optimal Cycle: 59 Level Of Service: D

Approach:	North Bound			South Bound			East Bound			West Bound		
Movement:	L	T	R	L	T	R	L	T	R	L	T	R
Control:	Protected			Protected			Protected			Protected		
Rights:	Include			Include			Include			Include		
Min. Green:	0	0	0	0	0	0	0	0	0	0	0	0
Y+R:	4.0	4.0	4.0	4.0	4.0	4.0	4.0	4.0	4.0	4.0	4.0	4.0
Lanes:	1	0	2	1	0	2	2	0	2	2	0	2

Volume Module:

Base Vol:	246	877	221	270	582	128	346	886	149	300	1107	201
Growth Adj:	1.00	1.00	1.00	1.00	1.00	1.00	1.00	1.00	1.00	1.00	1.00	1.00
Initial Bse:	246	877	221	270	582	128	346	886	149	300	1107	201
User Adj:	1.00	1.00	1.00	1.00	1.00	1.00	1.00	1.00	1.00	1.00	1.00	1.00
PHF Adj:	1.00	1.00	1.00	1.00	1.00	1.00	1.00	1.00	1.00	1.00	1.00	1.00
PHF Volume:	246	877	221	270	582	128	346	886	149	300	1107	201
Reduct Vol:	0	0	0	0	0	0	0	0	0	0	0	0
Reduced Vol:	246	877	221	270	582	128	346	886	149	300	1107	201
PCE Adj:	1.00	1.00	1.00	1.00	1.00	1.00	1.00	1.00	1.00	1.00	1.00	1.00
MLF Adj:	1.00	1.00	1.00	1.00	1.00	1.00	1.00	1.00	1.00	1.00	1.00	1.00
FinalVolume:	246	877	221	270	582	128	346	886	149	300	1107	201

Saturation Flow Module:

Sat/Lane:	1600	1600	1600	1600	1600	1600	1600	1600	1600	1600	1600	1600
Adjustment:	1.00	1.05	1.00	1.00	1.06	1.00	1.00	1.05	1.00	1.00	1.05	1.00
Lanes:	1.00	2.40	0.60	1.00	2.00	1.00	2.00	2.57	0.43	2.00	2.54	0.46
Final Sat.:	1600	4034	966	1600	3400	1600	3200	4309	691	3200	4262	738

Capacity Analysis Module:

Vol/Sat:	0.15	0.22	0.23	0.17	0.17	0.08	0.11	0.21	0.22	0.09	0.26	0.27
Crit Moves:			****	****			****					****

Santa Ana Circulation Element

Level Of Service Computation Report

2000 HCM Operations Method (Base Volume Alternative)

Intersection #77 Grand Ave and I-5 NB Ramps

Cycle (sec): 100 Critical Vol./Cap.(X): 0.518
 Loss Time (sec): 5 Average Delay (sec/veh): 10.0
 Optimal Cycle: 26 Level Of Service: A

Approach:	North Bound			South Bound			East Bound			West Bound					
Movement:	L	T	R	L	T	R	L	T	R	L	T	R			
Control:	Protected			Protected			Split Phase			Split Phase					
Rights:	Ignore			Include			Include			Include					
Min. Green:	0	0	0	0	0	0	0	0	0	0	0	0			
Y+R:	4.0	4.0	4.0	4.0	4.0	4.0	4.0	4.0	4.0	4.0	4.0	4.0			
Lanes:	0	0	2	0	1	0	1	0	3	0	0	0	2	0	0

Volume Module:

Base Vol:	0	1297	1001	48	1164	0	0	0	0	143	0	172
Growth Adj:	1.00	1.00	1.00	1.00	1.00	1.00	1.00	1.00	1.00	1.00	1.00	1.00
Initial Bse:	0	1297	1001	48	1164	0	0	0	0	143	0	172
User Adj:	1.00	1.00	0.00	1.00	1.00	1.00	1.00	1.00	1.00	1.00	1.00	1.00
PHF Adj:	1.00	1.00	0.00	1.00	1.00	1.00	1.00	1.00	1.00	1.00	1.00	1.00
PHF Volume:	0	1297	0	48	1164	0	0	0	0	143	0	172
Reduct Vol:	0	0	0	0	0	0	0	0	0	0	0	0
Reduced Vol:	0	1297	0	48	1164	0	0	0	0	143	0	172
PCE Adj:	1.00	1.00	0.00	1.00	1.00	1.00	1.00	1.00	1.00	1.00	1.00	1.00
MLF Adj:	1.00	1.00	0.00	1.00	1.00	1.00	1.00	1.00	1.00	1.00	1.00	1.00
FinalVolume:	0	1297	0	48	1164	0	0	0	0	143	0	172

Saturation Flow Module:

Sat/Lane:	1900	1900	1900	1900	1900	1900	1900	1900	1900	1900	1900	1900
Adjustment:	1.00	0.95	1.00	0.95	0.91	1.00	1.00	1.00	1.00	0.92	1.00	0.85
Lanes:	0.00	2.00	1.00	1.00	3.00	0.00	0.00	0.00	0.00	2.00	0.00	1.00
Final Sat.:	0	3610	1900	1805	5187	0	0	0	0	3502	0	1615

Capacity Analysis Module:

Vol/Sat:	0.00	0.36	0.00	0.03	0.22	0.00	0.00	0.00	0.00	0.04	0.00	0.11
Crit Moves:	****			****						****		
Green/Cycle:	0.00	0.69	0.00	0.05	0.74	0.00	0.00	0.00	0.00	0.21	0.00	0.21
Volume/Cap:	0.00	0.52	0.00	0.52	0.30	0.00	0.00	0.00	0.00	0.20	0.00	0.52
Delay/Veh:	0.0	7.5	0.0	51.3	4.3	0.0	0.0	0.0	0.0	33.0	0.0	36.8
User DelAdj:	1.00	1.00	1.00	1.00	1.00	1.00	1.00	1.00	1.00	1.00	1.00	1.00
AdjDel/Veh:	0.0	7.5	0.0	51.3	4.3	0.0	0.0	0.0	0.0	33.0	0.0	36.8
LOS by Move:	A	A	A	D	A	A	A	A	A	C	A	D
HCM2k85thQ:	0	15	0	4	7	0	0	0	0	3	0	8

Note: Queue reported is the number of cars per lane.

Santa Ana Circulation Element

Level Of Service Computation Report
 2000 HCM Operations Method (Base Volume Alternative)

 Intersection #78 Grand Ave and Santa Ana Blvd

Cycle (sec): 100 Critical Vol./Cap.(X): 0.605
 Loss Time (sec): 5 Average Delay (sec/veh): 21.1
 Optimal Cycle: 31 Level Of Service: C

Approach:	North Bound			South Bound			East Bound			West Bound		
Movement:	L	T	R	L	T	R	L	T	R	L	T	R

Control:	Protected			Protected			Split Phase			Split Phase		
Rights:	Include			Ovl			Include			Include		
Min. Green:	0	0	0	0	0	0	0	0	0	0	0	0
Y+R:	4.0	4.0	4.0	4.0	4.0	4.0	4.0	4.0	4.0	4.0	4.0	4.0
Lanes:	1	0	2	1	0	2	2	0	1	0	1	0

Volume Module:

Base Vol:	167	1888	31	34	750	532	328	200	316	20	134	97
Growth Adj:	1.00	1.00	1.00	1.00	1.00	1.00	1.00	1.00	1.00	1.00	1.00	1.00
Initial Bse:	167	1888	31	34	750	532	328	200	316	20	134	97
User Adj:	1.00	1.00	1.00	1.00	1.00	1.00	1.00	1.00	1.00	1.00	1.00	1.00
PHF Adj:	1.00	1.00	1.00	1.00	1.00	1.00	1.00	1.00	1.00	1.00	1.00	1.00
PHF Volume:	167	1888	31	34	750	532	328	200	316	20	134	97
Reduct Vol:	0	0	0	0	0	0	0	0	0	0	0	0
Reduced Vol:	167	1888	31	34	750	532	328	200	316	20	134	97
PCE Adj:	1.00	1.00	1.00	1.00	1.00	1.00	1.00	1.00	1.00	1.00	1.00	1.00
MLF Adj:	1.00	1.00	1.00	1.00	1.00	1.00	1.00	1.00	1.00	1.00	1.00	1.00
FinalVolume:	167	1888	31	34	750	532	328	200	316	20	134	97

Saturation Flow Module:

Sat/Lane:	1900	1900	1900	1900	1900	1900	1900	1900	1900	1900	1900	1900
Adjustment:	0.95	0.91	0.91	0.95	0.95	0.75	0.92	1.00	0.75	0.89	0.89	0.89
Lanes:	1.00	2.95	0.05	1.00	2.00	2.00	2.00	1.00	2.00	0.16	1.07	0.77
Final Sat.:	1805	5093	84	1805	3610	2842	3502	1900	2842	270	1808	1309

Capacity Analysis Module:

Vol/Sat:	0.09	0.37	0.37	0.02	0.21	0.19	0.09	0.11	0.11	0.07	0.07	0.07
Crit Moves:	****			****			****			****		
Green/Cycle:	0.20	0.61	0.61	0.03	0.45	0.63	0.18	0.18	0.18	0.12	0.12	0.12
Volume/Cap:	0.47	0.61	0.61	0.61	0.47	0.30	0.51	0.57	0.61	0.61	0.61	0.61
Delay/Veh:	36.4	12.3	12.3	65.2	19.6	8.6	37.4	39.5	39.5	44.1	44.1	44.1
User DelAdj:	1.00	1.00	1.00	1.00	1.00	1.00	1.00	1.00	1.00	1.00	1.00	1.00
AdjDel/Veh:	36.4	12.3	12.3	65.2	19.6	8.6	37.4	39.5	39.5	44.1	44.1	44.1
LOS by Move:	D	B	B	E	B	A	D	D	D	D	D	D
HCM2k85thQ:	8	20	20	3	13	7	8	10	9	8	8	8

Note: Queue reported is the number of cars per lane.

Santa Ana Circulation Element

Level Of Service Computation Report

ICU 1(Loss as Cycle Length %) Method (Base Volume Alternative)

Intersection #79 Grand Ave and 1st St

Cycle (sec): 100 Critical Vol./Cap.(X): 0.793
 Loss Time (sec): 5 Average Delay (sec/veh): xxxxxx
 Optimal Cycle: 51 Level Of Service: C

Approach:	North Bound			South Bound			East Bound			West Bound		
Movement:	L	T	R	L	T	R	L	T	R	L	T	R

Control:	Protected			Protected			Protected			Protected		
Rights:	Include			Include			Include			Include		
Min. Green:	0	0	0	0	0	0	0	0	0	0	0	0
Y+R:	4.0	4.0	4.0	4.0	4.0	4.0	4.0	4.0	4.0	4.0	4.0	4.0
Lanes:	2	0	2	1	0	0	2	0	3	0	1	0

Volume Module:

Base Vol:	165	1261	38	120	706	282	277	918	91	151	941	173
Growth Adj:	1.00	1.00	1.00	1.00	1.00	1.00	1.00	1.00	1.00	1.00	1.00	1.00
Initial Bse:	165	1261	38	120	706	282	277	918	91	151	941	173
User Adj:	1.00	1.00	1.00	1.00	1.00	1.00	1.00	1.00	1.00	1.00	1.00	1.00
PHF Adj:	1.00	1.00	1.00	1.00	1.00	1.00	1.00	1.00	1.00	1.00	1.00	1.00
PHF Volume:	165	1261	38	120	706	282	277	918	91	151	941	173
Reduct Vol:	0	0	0	0	0	0	0	0	0	0	0	0
Reduced Vol:	165	1261	38	120	706	282	277	918	91	151	941	173
PCE Adj:	1.00	1.00	1.00	1.00	1.00	1.00	1.00	1.00	1.00	1.00	1.00	1.00
MLF Adj:	1.00	1.00	1.00	1.00	1.00	1.00	1.00	1.00	1.00	1.00	1.00	1.00
FinalVolume:	165	1261	38	120	706	282	277	918	91	151	941	173

Saturation Flow Module:

Sat/Lane:	1600	1600	1600	1600	1600	1600	1600	1600	1600	1600	1600	1600
Adjustment:	1.00	1.04	1.00	1.00	1.06	1.00	1.00	1.05	1.00	1.00	1.04	1.00
Lanes:	2.00	2.91	0.09	2.00	3.00	1.00	2.00	2.73	0.27	2.00	1.69	0.31
Final Sat.:	3200	4860	140	3200	5100	1600	3200	4567	433	3200	2803	497

Capacity Analysis Module:

Vol/Sat:	0.05	0.26	0.27	0.04	0.14	0.18	0.09	0.20	0.21	0.05	0.34	0.35
Crit Moves:		****	****		****	****		****	****		****	****

Santa Ana Circulation Element

Level Of Service Computation Report

ICU 1(Loss as Cycle Length %) Method (Base Volume Alternative)

Intersection #80 Grand Ave and Chestnut Ave

Cycle (sec): 100 Critical Vol./Cap.(X): 0.615
 Loss Time (sec): 5 Average Delay (sec/veh): xxxxxx
 Optimal Cycle: 30 Level Of Service: B

Approach:	North Bound			South Bound			East Bound			West Bound		
Movement:	L	T	R	L	T	R	L	T	R	L	T	R
Control:	Protected			Protected			Permitted			Permitted		
Rights:	Include			Include			Include			Include		
Min. Green:	0	0	0	0	0	0	0	0	0	0	0	0
Y+R:	4.0	4.0	4.0	4.0	4.0	4.0	4.0	4.0	4.0	4.0	4.0	4.0
Lanes:	1	0	2	1	0	2	1	0	1	1	0	1

Volume Module:

Base Vol:	140	1050	182	149	664	112	93	285	62	107	333	194
Growth Adj:	1.00	1.00	1.00	1.00	1.00	1.00	1.00	1.00	1.00	1.00	1.00	1.00
Initial Bse:	140	1050	182	149	664	112	93	285	62	107	333	194
User Adj:	1.00	1.00	1.00	1.00	1.00	1.00	1.00	1.00	1.00	1.00	1.00	1.00
PHF Adj:	1.00	1.00	1.00	1.00	1.00	1.00	1.00	1.00	1.00	1.00	1.00	1.00
PHF Volume:	140	1050	182	149	664	112	93	285	62	107	333	194
Reduct Vol:	0	0	0	0	0	0	0	0	0	0	0	0
Reduced Vol:	140	1050	182	149	664	112	93	285	62	107	333	194
PCE Adj:	1.00	1.00	1.00	1.00	1.00	1.00	1.00	1.00	1.00	1.00	1.00	1.00
MLF Adj:	1.00	1.00	1.00	1.00	1.00	1.00	1.00	1.00	1.00	1.00	1.00	1.00
FinalVolume:	140	1050	182	149	664	112	93	285	62	107	333	194

Saturation Flow Module:

Sat/Lane:	1600	1600	1600	1600	1600	1600	1600	1600	1600	1600	1600	1600
Adjustment:	1.00	1.05	1.00	1.00	1.05	1.00	1.00	1.04	1.00	1.00	1.05	1.00
Lanes:	1.00	2.56	0.44	1.00	2.57	0.43	1.00	1.64	0.36	1.00	1.26	0.74
Final Sat.:	1600	4291	709	1600	4307	693	1600	2728	572	1600	2122	1178

Capacity Analysis Module:

Vol/Sat:	0.09	0.24	0.26	0.09	0.15	0.16	0.06	0.10	0.11	0.07	0.16	0.16
Crit Moves:	****			****			****			****		

Santa Ana Circulation Element

Level Of Service Computation Report

ICU 1(Loss as Cycle Length %) Method (Base Volume Alternative)

Intersection #81 Grand Ave and McFadden Ave

Cycle (sec): 100 Critical Vol./Cap.(X): 0.759
 Loss Time (sec): 5 Average Delay (sec/veh): xxxxxx
 Optimal Cycle: 45 Level Of Service: C

Approach:	North Bound			South Bound			East Bound			West Bound		
Movement:	L	T	R	L	T	R	L	T	R	L	T	R
Control:	Protected			Protected			Protected			Protected		
Rights:	Include			Include			Include			Include		
Min. Green:	0	0	0	0	0	0	0	0	0	0	0	0
Y+R:	4.0	4.0	4.0	4.0	4.0	4.0	4.0	4.0	4.0	4.0	4.0	4.0
Lanes:	1	0	2	1	0	2	1	0	1	1	0	1

Volume Module:

Base Vol:	202	1150	198	138	626	168	128	476	83	86	686	151
Growth Adj:	1.00	1.00	1.00	1.00	1.00	1.00	1.00	1.00	1.00	1.00	1.00	1.00
Initial Bse:	202	1150	198	138	626	168	128	476	83	86	686	151
User Adj:	1.00	1.00	1.00	1.00	1.00	1.00	1.00	1.00	1.00	1.00	1.00	1.00
PHF Adj:	1.00	1.00	1.00	1.00	1.00	1.00	1.00	1.00	1.00	1.00	1.00	1.00
PHF Volume:	202	1150	198	138	626	168	128	476	83	86	686	151
Reduct Vol:	0	0	0	0	0	0	0	0	0	0	0	0
Reduced Vol:	202	1150	198	138	626	168	128	476	83	86	686	151
PCE Adj:	1.00	1.00	1.00	1.00	1.00	1.00	1.00	1.00	1.00	1.00	1.00	1.00
MLF Adj:	1.00	1.00	1.00	1.00	1.00	1.00	1.00	1.00	1.00	1.00	1.00	1.00
FinalVolume:	202	1150	198	138	626	168	128	476	83	86	686	151

Saturation Flow Module:

Sat/Lane:	1600	1600	1600	1600	1600	1600	1600	1600	1600	1600	1600	1600
Adjustment:	1.00	1.05	1.00	1.00	1.05	1.00	1.00	1.04	1.00	1.00	1.04	1.00
Lanes:	1.00	2.56	0.44	1.00	2.37	0.63	1.00	1.70	0.30	1.00	1.64	0.36
Final Sat.:	1600	4295	705	1600	3984	1016	1600	2825	475	1600	2723	577

Capacity Analysis Module:

Vol/Sat:	0.13	0.27	0.28	0.09	0.16	0.17	0.08	0.17	0.17	0.05	0.25	0.26
Crit Moves:		****	****		****	****		****	****		****	****

Santa Ana Circulation Element

Level Of Service Computation Report

ICU 1(Loss as Cycle Length %) Method (Base Volume Alternative)

Intersection #82 Grand Ave and Edinger Ave

Cycle (sec): 100 Critical Vol./Cap.(X): 0.909
 Loss Time (sec): 5 Average Delay (sec/veh): xxxxxx
 Optimal Cycle: 92 Level Of Service: E

Approach:	North Bound			South Bound			East Bound			West Bound		
Movement:	L	T	R	L	T	R	L	T	R	L	T	R
Control:	Protected			Protected			Protected			Protected		
Rights:	Include			Include			Include			Include		
Min. Green:	0	0	0	0	0	0	0	0	0	0	0	0
Y+R:	4.0	4.0	4.0	4.0	4.0	4.0	4.0	4.0	4.0	4.0	4.0	4.0
Lanes:	1	0	2	1	0	2	1	0	2	1	0	2

Volume Module:

Base Vol:	242	1397	121	165	408	229	201	868	70	74	1333	173
Growth Adj:	1.00	1.00	1.00	1.00	1.00	1.00	1.00	1.00	1.00	1.00	1.00	1.00
Initial Bse:	242	1397	121	165	408	229	201	868	70	74	1333	173
User Adj:	1.00	1.00	1.00	1.00	1.00	1.00	1.00	1.00	1.00	1.00	1.00	1.00
PHF Adj:	1.00	1.00	1.00	1.00	1.00	1.00	1.00	1.00	1.00	1.00	1.00	1.00
PHF Volume:	242	1397	121	165	408	229	201	868	70	74	1333	173
Reduct Vol:	0	0	0	0	0	0	0	0	0	0	0	0
Reduced Vol:	242	1397	121	165	408	229	201	868	70	74	1333	173
PCE Adj:	1.00	1.00	1.00	1.00	1.00	1.00	1.00	1.00	1.00	1.00	1.00	1.00
MLF Adj:	1.00	1.00	1.00	1.00	1.00	1.00	1.00	1.00	1.00	1.00	1.00	1.00
FinalVolume:	242	1397	121	165	408	229	201	868	70	74	1333	173

Saturation Flow Module:

Sat/Lane:	1600	1600	1600	1600	1600	1600	1600	1600	1600	1600	1600	1600
Adjustment:	1.00	1.05	1.00	1.00	1.06	1.00	1.00	1.05	1.00	1.00	1.05	1.00
Lanes:	1.00	2.76	0.24	1.00	2.00	1.00	1.00	2.78	0.22	1.00	2.66	0.34
Final Sat.:	1600	4617	383	1600	3400	1600	1600	4642	358	1600	4449	551

Capacity Analysis Module:

Vol/Sat:	0.15	0.30	0.32	0.10	0.12	0.14	0.13	0.19	0.20	0.05	0.30	0.31
Crit Moves:			****	****			****					****

Santa Ana Circulation Element

Level of Service Computation Report

ICU 1(Loss as Cycle Length %) Method (Base Volume Alternative)

Intersection #83 Grand Ave and Warner Ave

Cycle (sec): 100 Critical Vol./Cap.(X): 0.704
 Loss Time (sec): 0 Average Delay (sec/veh): xxxxxxx
 Optimal Cycle: 77 Level Of Service: C

Approach:	North Bound			South Bound			East Bound			West Bound		
Movement:	L	T	R	L	T	R	L	T	R	L	T	R
Control:	Protected			Protected			Protected			Protected		
Rights:	Include			Include			Include			Include		
Min. Green:	0	0	0	0	0	0	0	0	0	0	0	0
Y+R:	4.0	4.0	4.0	4.0	4.0	4.0	4.0	4.0	4.0	4.0	4.0	4.0
Lanes:	1	0	2	1	0	2	2	0	3	2	0	2

Volume Module:	North Bound			South Bound			East Bound			West Bound		
Base Vol:	242	873	193	146	471	217	342	656	142	151	964	316
Growth Adj:	1.00	1.00	1.00	1.00	1.00	1.00	1.00	1.00	1.00	1.00	1.00	1.00
Initial Bse:	242	873	193	146	471	217	342	656	142	151	964	316
User Adj:	1.00	1.00	1.00	1.00	1.00	1.00	1.00	1.00	1.00	1.00	1.00	1.00
PHF Adj:	1.00	1.00	1.00	1.00	1.00	1.00	1.00	1.00	1.00	1.00	1.00	1.00
PHF Volume:	242	873	193	146	471	217	342	656	142	151	964	316
Reduct Vol:	0	0	0	0	0	0	0	0	0	0	0	0
Reduced Vol:	242	873	193	146	471	217	342	656	142	151	964	316
PCE Adj:	1.00	1.00	1.00	1.00	1.00	1.00	1.00	1.00	1.00	1.00	1.00	1.00
MLF Adj:	1.00	1.00	1.00	1.00	1.00	1.00	1.00	1.00	1.00	1.00	1.00	1.00
FinalVolume:	242	873	193	146	471	217	342	656	142	151	964	316

Saturation Flow Module:	North Bound			South Bound			East Bound			West Bound		
Sat/Lane:	1600	1600	1600	1600	1600	1600	1600	1600	1600	1600	1600	1600
Adjustment:	1.00	1.05	1.00	1.00	1.06	1.00	1.00	1.06	1.00	1.00	1.06	1.00
Lanes:	1.00	2.46	0.54	1.00	2.05	0.95	2.00	3.00	1.00	2.00	2.00	1.00
Final Sat.:	1600	4131	869	1600	3486	1514	3200	5100	1600	3200	3400	1600

Capacity Analysis Module:	North Bound			South Bound			East Bound			West Bound		
Vol/Sat:	0.15	0.21	0.22	0.09	0.14	0.14	0.11	0.13	0.09	0.05	0.28	0.20
Crit Moves:			****	****			****			****		

Santa Ana Circulation Element

Level Of Service Computation Report

2000 HCM Operations Method (Base Volume Alternative)

 Intersection #84 SR-55 NB Ramps and Dyer Rd

Cycle (sec): 100 Critical Vol./Cap.(X): 0.376
 Loss Time (sec): 5 Average Delay (sec/veh): 5.7
 Optimal Cycle: 20 Level Of Service: A

Approach:	North Bound			South Bound			East Bound			West Bound		
Movement:	L	T	R	L	T	R	L	T	R	L	T	R
Control:	Split Phase			Split Phase			Protected			Protected		
Rights:	Include			Include			Ignore			Ignore		
Min. Green:	0	0	0	0	0	0	0	0	0	0	0	0
Y+R:	4.0	4.0	4.0	4.0	4.0	4.0	4.0	4.0	4.0	4.0	4.0	4.0
Lanes:	1	0	1	0	0	0	0	0	3	0	2	1

Volume Module:	North Bound			South Bound			East Bound			West Bound		
Base Vol:	188	0	51	0	0	0	0	1339	681	0	1545	965
Growth Adj:	1.00	1.00	1.00	1.00	1.00	1.00	1.00	1.00	1.00	1.00	1.00	1.00
Initial Bse:	188	0	51	0	0	0	0	1339	681	0	1545	965
User Adj:	1.00	1.00	1.00	1.00	1.00	1.00	1.00	1.00	0.00	1.00	1.00	0.00
PHF Adj:	1.00	1.00	1.00	1.00	1.00	1.00	1.00	1.00	0.00	1.00	1.00	0.00
PHF Volume:	188	0	51	0	0	0	0	1339	0	0	1545	0
Reduct Vol:	0	0	0	0	0	0	0	0	0	0	0	0
Reduced Vol:	188	0	51	0	0	0	0	1339	0	0	1545	0
PCE Adj:	1.00	1.00	1.00	1.00	1.00	1.00	1.00	1.00	0.00	1.00	1.00	0.00
MLF Adj:	1.00	1.00	1.00	1.00	1.00	1.00	1.00	1.00	0.00	1.00	1.00	0.00
Final Volume:	188	0	51	0	0	0	0	1339	0	0	1545	0

Saturation Flow Module:	North Bound			South Bound			East Bound			West Bound		
Sat/Lane:	1900	1900	1900	1900	1900	1900	1900	1900	1900	1900	1900	1900
Adjustment:	0.93	1.00	0.93	1.00	1.00	1.00	1.00	0.91	1.00	1.00	0.91	0.91
Lanes:	1.79	0.00	1.21	0.00	0.00	0.00	0.00	3.00	1.00	0.00	3.00	0.00
Final Sat.:	3161	0	2147	0	0	0	0	5187	1900	0	5187	0

Capacity Analysis Module:	North Bound			South Bound			East Bound			West Bound		
Vol/Sat:	0.06	0.00	0.02	0.00	0.00	0.00	0.00	0.26	0.00	0.00	0.30	0.00
Crit Moves:	****			****			****			****		
Green/Cycle:	0.16	0.00	0.16	0.00	0.00	0.00	0.00	0.79	0.00	0.00	0.79	0.00
Volume/Cap:	0.38	0.00	0.15	0.00	0.00	0.00	0.00	0.33	0.00	0.00	0.38	0.00
Delay/Veh:	38.1	0.0	36.3	0.0	0.0	0.0	0.0	3.0	0.0	0.0	3.1	0.0
User DelAdj:	1.00	1.00	1.00	1.00	1.00	1.00	1.00	1.00	1.00	1.00	1.00	1.00
AdjDel/Veh:	38.1	0.0	36.3	0.0	0.0	0.0	0.0	3.0	0.0	0.0	3.1	0.0
LOS by Move:	D	A	D	A	A	A	A	A	A	A	A	A
HCM2k85thQ:	5	0	2	0	0	0	0	7	0	0	8	0

Note: Queue reported is the number of cars per lane.

Santa Ana Circulation Element

Level Of Service Computation Report
 2000 HCM 4-Way Stop Method (Base Volume Alternative)

 Intersection #85 Cambridge St and La Veta Ave

Cycle (sec): 100 Critical Vol./Cap.(X): 0.459
 Loss Time (sec): 5 Average Delay (sec/veh): 12.5
 Optimal Cycle: 0 Level Of Service: B

Approach:	North Bound			South Bound			East Bound			West Bound		
Movement:	L	T	R	L	T	R	L	T	R	L	T	R
Control:	Stop Sign			Stop Sign			Stop Sign			Stop Sign		
Rights:	Include			Include			Include			Include		
Min. Green:	0	0	0	0	0	0	0	0	0	0	0	0
Lanes:	1	0	1	0	0	1	1	0	0	0	0	0

Volume Module:	North Bound			South Bound			East Bound			West Bound		
Base Vol:	191	266	0	0	196	181	219	0	144	0	0	0
Growth Adj:	1.00	1.00	1.00	1.00	1.00	1.00	1.00	1.00	1.00	1.00	1.00	1.00
Initial Bse:	191	266	0	0	196	181	219	0	144	0	0	0
User Adj:	1.00	1.00	1.00	1.00	1.00	1.00	1.00	1.00	1.00	1.00	1.00	1.00
PHF Adj:	1.00	1.00	1.00	1.00	1.00	1.00	1.00	1.00	1.00	1.00	1.00	1.00
PHF Volume:	191	266	0	0	196	181	219	0	144	0	0	0
Reduct Vol:	0	0	0	0	0	0	0	0	0	0	0	0
Reduced Vol:	191	266	0	0	196	181	219	0	144	0	0	0
PCE Adj:	1.00	1.00	1.00	1.00	1.00	1.00	1.00	1.00	1.00	1.00	1.00	1.00
MLF Adj:	1.00	1.00	1.00	1.00	1.00	1.00	1.00	1.00	1.00	1.00	1.00	1.00
FinalVolume:	191	266	0	0	196	181	219	0	144	0	0	0

Saturation Flow Module:	North Bound			South Bound			East Bound			West Bound		
Adjustment:	1.00	1.00	1.00	1.00	1.00	1.00	1.00	1.00	1.00	1.00	1.00	1.00
Lanes:	1.00	1.00	0.00	0.00	1.00	1.00	1.00	0.00	1.00	0.00	0.00	0.00
Final Sat.:	535	579	0	0	563	631	500	0	595	0	0	0

Capacity Analysis Module:	North Bound			South Bound			East Bound			West Bound		
Vol/Sat:	0.36	0.46	xxxx	xxxx	0.35	0.29	0.44	xxxx	0.24	xxxx	xxxx	xxxx
Crit Moves:	****			****			****			****		
Delay/Veh:	12.7	13.6	0.0	0.0	12.0	10.3	14.7	0.0	10.2	0.0	0.0	0.0
Delay Adj:	1.00	1.00	1.00	1.00	1.00	1.00	1.00	1.00	1.00	1.00	1.00	1.00
AdjDel/Veh:	12.7	13.6	0.0	0.0	12.0	10.3	14.7	0.0	10.2	0.0	0.0	0.0
LOS by Move:	B	B	*	*	B	B	B	*	B	*	*	*
ApproachDel:	13.3			11.2			12.9			xxxxxx		
Delay Adj:	1.00			1.00			1.00			xxxxxx		
ApprAdjDel:	13.3			11.2			12.9			xxxxxx		
LOS by Appr:	B			B			B			*		
AllWayAvgQ:	0.5	0.8	0.0	0.0	0.5	0.4	0.7	0.0	0.3	0.0	0.0	0.0

Note: Queue reported is the number of cars per lane.

Santa Ana Circulation Element

Level Of Service Computation Report

ICU 1(Loss as Cycle Length %) Method (Base Volume Alternative)

 Intersection #86 Cambridge St and Fairhaven Ave

Cycle (sec): 100 Critical Vol./Cap.(X): 0.488
 Loss Time (sec): 5 Average Delay (sec/veh): xxxxxx
 Optimal Cycle: 23 Level Of Service: A

Approach:	North Bound			South Bound			East Bound			West Bound		
Movement:	L	T	R	L	T	R	L	T	R	L	T	R
Control:	Permitted			Permitted			Permitted			Permitted		
Rights:	Include			Include			Include			Include		
Min. Green:	0	0	0	0	0	0	0	0	0	0	0	0
Y+R:	4.0	4.0	4.0	4.0	4.0	4.0	4.0	4.0	4.0	4.0	4.0	4.0
Lanes:	0	0	0	1	0	0	1	0	2	0	0	1

Volume Module:	North Bound			South Bound			East Bound			West Bound		
Base Vol:	0	0	0	219	0	76	141	246	0	0	273	340
Growth Adj:	1.00	1.00	1.00	1.00	1.00	1.00	1.00	1.00	1.00	1.00	1.00	1.00
Initial Bse:	0	0	0	219	0	76	141	246	0	0	273	340
User Adj:	1.00	1.00	1.00	1.00	1.00	1.00	1.00	1.00	1.00	1.00	1.00	1.00
PHF Adj:	1.00	1.00	1.00	1.00	1.00	1.00	1.00	1.00	1.00	1.00	1.00	1.00
PHF Volume:	0	0	0	219	0	76	141	246	0	0	273	340
Reduct Vol:	0	0	0	0	0	0	0	0	0	0	0	0
Reduced Vol:	0	0	0	219	0	76	141	246	0	0	273	340
PCE Adj:	1.00	1.00	1.00	1.00	1.00	1.00	1.00	1.00	1.00	1.00	1.00	1.00
MLF Adj:	1.00	1.00	1.00	1.00	1.00	1.00	1.00	1.00	1.00	1.00	1.00	1.00
FinalVolume:	0	0	0	219	0	76	141	246	0	0	273	340

Saturation Flow Module:	North Bound			South Bound			East Bound			West Bound		
Sat/Lane:	1600	1600	1600	1600	1600	1600	1600	1600	1600	1600	1600	1600
Adjustment:	1.00	1.06	1.00	1.00	1.06	1.00	1.00	1.06	1.00	1.00	1.06	1.00
Lanes:	0.00	0.00	0.00	1.00	0.00	1.00	1.00	2.00	0.00	0.00	1.00	1.00
Final Sat.:	0	0	0	1600	0	1600	1600	3400	0	0	1700	1600

Capacity Analysis Module:	North Bound			South Bound			East Bound			West Bound		
Vol/Sat:	0.00	0.00	0.00	0.14	0.00	0.05	0.09	0.07	0.00	0.00	0.16	0.21
Crit Moves:				****			****					****

Santa Ana Circulation Element

Level Of Service Computation Report
 2000 HCM Operations Method (Base Volume Alternative)

 Intersection #87 Mabury St and 1st Street

Cycle (sec): 100 Critical Vol./Cap.(X): 0.703
 Loss Time (sec): 0 Average Delay (sec/veh): 26.1
 Optimal Cycle: 77 Level Of Service: C

Street Name:	Mabury						1st Street					
Approach:	North Bound			South Bound			East Bound			West Bound		
Movement:	L	T	R	L	T	R	L	T	R	L	T	R
Control:	Split Phase			Split Phase			Protected			Protected		
Rights:	Include			Include			Include			Include		
Min. Green:	0	0	0	0	0	0	0	0	0	0	0	0
Y+R:	4.0	4.0	4.0	4.0	4.0	4.0	4.0	4.0	4.0	4.0	4.0	4.0
Lanes:	1	0	0	0	1	0	0	0	2	1	0	2

Volume Module:	Mabury			Mabury			1st Street			1st Street		
Base Vol:	25	0	256	207	88	390	0	1512	24	40	549	0
Growth Adj:	1.00	1.00	1.00	1.00	1.00	1.00	1.00	1.00	1.00	1.00	1.00	1.00
Initial Bse:	25	0	256	207	88	390	0	1512	24	40	549	0
User Adj:	1.00	1.00	1.00	1.00	1.00	1.00	1.00	1.00	1.00	1.00	1.00	1.00
PHF Adj:	1.00	1.00	1.00	1.00	1.00	1.00	1.00	1.00	1.00	1.00	1.00	1.00
PHF Volume:	25	0	256	207	88	390	0	1512	24	40	549	0
Reduct Vol:	0	0	0	0	0	0	0	0	0	0	0	0
Reduced Vol:	25	0	256	207	88	390	0	1512	24	40	549	0
PCE Adj:	1.00	1.00	1.00	1.00	1.00	1.00	1.00	1.00	1.00	1.00	1.00	1.00
MLF Adj:	1.00	1.00	1.00	1.00	1.00	1.00	1.00	1.00	1.00	1.00	1.00	1.00
Final Volume:	25	0	256	207	88	390	0	1512	24	40	549	0

Saturation Flow Module:	Mabury			Mabury			1st Street			1st Street		
Sat/Lane:	1900	1900	1900	1900	1900	1900	1900	1900	1900	1900	1900	1900
Adjustment:	0.95	1.00	0.85	0.90	0.90	0.90	1.00	0.91	0.91	0.95	0.91	0.91
Lanes:	1.00	0.00	1.00	1.27	0.23	1.50	0.00	2.95	0.05	1.00	3.00	0.00
Final Sat.:	1805	0	1615	2171	390	2576	0	5096	81	1805	5187	0

Capacity Analysis Module:	Mabury			Mabury			1st Street			1st Street		
Vol/Sat:	0.01	0.00	0.16	0.10	0.23	0.15	0.00	0.30	0.30	0.02	0.11	0.00
Crit Moves:	****			****			****			****		
Green/Cycle:	0.23	0.00	0.23	0.32	0.32	0.32	0.00	0.42	0.42	0.03	0.45	0.00
Volume/Cap:	0.06	0.00	0.70	0.30	0.70	0.47	0.00	0.70	0.70	0.70	0.23	0.00
Delay/Veh:	30.5	0.0	41.7	25.6	32.1	27.4	0.0	24.8	24.8	80.7	16.7	0.0
User DelAdj:	1.00	1.00	1.00	1.00	1.00	1.00	1.00	1.00	1.00	1.00	1.00	1.00
AdjDel/Veh:	30.5	0.0	41.7	25.6	32.1	27.4	0.0	24.8	24.8	80.7	16.7	0.0
LOS by Move:	C	A	D	C	C	C	A	C	C	F	B	A
HCM2k85thQ:	1	0	13	6	17	10	0	22	22	4	6	0

Note: Queue reported is the number of cars per lane.

Santa Ana Circulation Element

Level Of Service Computation Report

ICU 1(Loss as Cycle Length %) Method (Base Volume Alternative)

Intersection #88 Tustin St and La Veta Ave

Cycle (sec): 100 Critical Vol./Cap.(X): 0.444
 Loss Time (sec): 5 Average Delay (sec/veh): xxxxxx
 Optimal Cycle: 21 Level Of Service: A

Approach:	North Bound			South Bound			East Bound			West Bound		
Movement:	L	T	R	L	T	R	L	T	R	L	T	R
Control:	Protected			Protected			Split Phase			Split Phase		
Rights:	Include			Include			Include			Ovl		
Min. Green:	0	0	0	0	0	0	0	0	0	0	0	0
Y+R:	4.0	4.0	4.0	4.0	4.0	4.0	4.0	4.0	4.0	4.0	4.0	4.0
Lanes:	1	0	2	1	0	2	1	0	1	1	0	0

Volume Module:

Base Vol:	46	1033	245	90	801	15	13	5	20	183	5	112
Growth Adj:	1.00	1.00	1.00	1.00	1.00	1.00	1.00	1.00	1.00	1.00	1.00	1.00
Initial Bse:	46	1033	245	90	801	15	13	5	20	183	5	112
User Adj:	1.00	1.00	1.00	1.00	1.00	1.00	1.00	1.00	1.00	1.00	1.00	1.00
PHF Adj:	1.00	1.00	1.00	1.00	1.00	1.00	1.00	1.00	1.00	1.00	1.00	1.00
PHF Volume:	46	1033	245	90	801	15	13	5	20	183	5	112
Reduct Vol:	0	0	0	0	0	0	0	0	0	0	0	0
Reduced Vol:	46	1033	245	90	801	15	13	5	20	183	5	112
PCE Adj:	1.00	1.00	1.00	1.00	1.00	1.00	1.00	1.00	1.00	1.00	1.00	1.00
MLF Adj:	1.00	1.00	1.00	1.00	1.00	1.00	1.00	1.00	1.00	1.00	1.00	1.00
FinalVolume:	46	1033	245	90	801	15	13	5	20	183	5	112
OvlAdjVol:												22

Saturation Flow Module:

Sat/Lane:	1600	1600	1600	1600	1600	1600	1600	1600	1600	1600	1600	1600
Adjustment:	1.00	1.05	1.00	1.00	1.04	1.00	1.00	1.06	1.00	1.00	1.00	1.00
Lanes:	1.00	2.42	0.58	1.00	2.94	0.06	1.00	1.00	1.00	1.95	0.05	1.00
Final Sat.:	1600	4080	920	1600	4912	88	1600	1700	1600	3115	85	1600

Capacity Analysis Module:

Vol/Sat:	0.03	0.25	0.27	0.06	0.16	0.17	0.01	0.00	0.01	0.06	0.06	0.07
OvlAdjV/S:												0.01

Crit Moves: **** *

Santa Ana Circulation Element

Level of Service Computation Report
 2000 HCM Operations Method (Base Volume Alternative)

 Intersection #89 Tustin St and SR-22 WB On-Ramp

Cycle (sec): 100 Critical Vol./Cap.(X): 0.446
 Loss Time (sec): 5 Average Delay (sec/veh): 12.1
 Optimal Cycle: 36 Level of Service: B

Approach:	North Bound			South Bound			East Bound			West Bound		
Movement:	L	T	R	L	T	R	L	T	R	L	T	R
Control:	Protected			Permitted			Protected			Protected		
Rights:	Include			Include			Include			Include		
Min. Green:	0	0	0	0	0	0	0	0	0	0	0	0
Y+R:	4.0	4.0	4.0	4.0	4.0	4.0	4.0	4.0	4.0	4.0	4.0	4.0
Lanes:	2	0	2	0	0	2	1	0	0	0	0	0

Volume Module:

Base Vol:	532	1529	0	0	711	365	0	0	0	0	0	0
Growth Adj:	1.00	1.00	1.00	1.00	1.00	1.00	1.00	1.00	1.00	1.00	1.00	1.00
Initial Bse:	532	1529	0	0	711	365	0	0	0	0	0	0
User Adj:	1.00	1.00	1.00	1.00	1.00	1.00	1.00	1.00	1.00	1.00	1.00	1.00
PHF Adj:	1.00	1.00	1.00	1.00	1.00	1.00	1.00	1.00	1.00	1.00	1.00	1.00
PHF Volume:	532	1529	0	0	711	365	0	0	0	0	0	0
Reduct Vol:	0	0	0	0	0	0	0	0	0	0	0	0
Reduced Vol:	532	1529	0	0	711	365	0	0	0	0	0	0
PCE Adj:	1.00	1.00	1.00	1.00	1.00	1.00	1.00	1.00	1.00	1.00	1.00	1.00
MLF Adj:	1.00	1.00	1.00	1.00	1.00	1.00	1.00	1.00	1.00	1.00	1.00	1.00
Final Volume:	532	1529	0	0	711	365	0	0	0	0	0	0

Saturation Flow Module:

Sat/Lane:	1900	1900	1900	1900	1900	1900	1900	1900	1900	1900	1900	1900
Adjustment:	0.92	0.95	1.00	1.00	0.86	0.86	1.00	1.00	1.00	1.00	1.00	1.00
Lanes:	2.00	2.00	0.00	0.00	2.00	1.00	0.00	0.00	0.00	0.00	0.00	0.00
Final Sat.:	3502	3610	0	0	3282	1641	0	0	0	0	0	0

Capacity Analysis Module:

Vol/Sat:	0.15	0.42	0.00	0.00	0.22	0.22	0.00	0.00	0.00	0.00	0.00	0.00
Crit Moves:	****											
Green/Cycle:	0.63	0.95	0.00	0.00	0.32	0.32	0.00	0.00	0.00	0.00	0.00	0.00
Volume/Cap:	0.24	0.45	0.00	0.00	0.67	0.69	0.00	0.00	0.00	0.00	0.00	0.00
Delay/Veh:	8.2	0.3	0.0	0.0	30.5	31.0	0.0	0.0	0.0	0.0	0.0	0.0
User DelAdj:	1.00	1.00	1.00	1.00	1.00	1.00	1.00	1.00	1.00	1.00	1.00	1.00
AdjDel/Veh:	8.2	0.3	0.0	0.0	30.5	31.0	0.0	0.0	0.0	0.0	0.0	0.0
LOS by Move:	A	A	A	A	C	C	A	A	A	A	A	A
HCM2k85thQ:	6	4	0	0	17	18	0	0	0	0	0	0

Note: Queue reported is the number of cars per lane.

Santa Ana Circulation Element

Level Of Service Computation Report

2000 HCM Operations Method (Base Volume Alternative)

 Intersection #90 Tustin St and SR-22 EB Off-Ramp / Seba Ave

Cycle (sec): 100 Critical Vol./Cap.(X): 0.719
 Loss Time (sec): 5 Average Delay (sec/veh): 23.7
 Optimal Cycle: 41 Level Of Service: C

Approach:	North Bound			South Bound			East Bound			West Bound		
Movement:	L	T	R	L	T	R	L	T	R	L	T	R
Control:	Permitted			Permitted			Split Phase			Split Phase		
Rights:	Include			Include			Include			Include		
Min. Green:	0	0	0	0	0	0	0	0	0	0	0	0
Y+R:	4.0	4.0	4.0	4.0	4.0	4.0	4.0	4.0	4.0	4.0	4.0	4.0
Lanes:	0	0	2	1	0	3	0	1	0	1	0	0

Volume Module:

Base Vol:	0	1547	4	52	707	0	458	41	581	28	0	67
Growth Adj:	1.00	1.00	1.00	1.00	1.00	1.00	1.00	1.00	1.00	1.00	1.00	1.00
Initial Bse:	0	1547	4	52	707	0	458	41	581	28	0	67
User Adj:	1.00	1.00	1.00	1.00	1.00	1.00	1.00	1.00	1.00	1.00	1.00	1.00
PHF Adj:	1.00	1.00	1.00	1.00	1.00	1.00	1.00	1.00	1.00	1.00	1.00	1.00
PHF Volume:	0	1547	4	52	707	0	458	41	581	28	0	67
Reduct Vol:	0	0	0	0	0	0	0	0	0	0	0	0
Reduced Vol:	0	1547	4	52	707	0	458	41	581	28	0	67
PCE Adj:	1.00	1.00	1.00	1.00	1.00	1.00	1.00	1.00	1.00	1.00	1.00	1.00
MLF Adj:	1.00	1.00	1.00	1.00	1.00	1.00	1.00	1.00	1.00	1.00	1.00	1.00
FinalVolume:	0	1547	4	52	707	0	458	41	581	28	0	67

Saturation Flow Module:

Sat/Lane:	1900	1900	1900	1900	1900	1900	1900	1900	1900	1900	1900	1900
Adjustment:	1.00	0.91	0.91	0.10	0.91	1.00	0.90	0.90	0.90	0.89	1.00	0.89
Lanes:	0.00	2.99	0.01	1.00	3.00	0.00	1.41	0.07	1.52	0.29	0.00	0.71
Final Sat.:	0	5174	13	182	5187	0	2408	125	2595	499	0	1195

Capacity Analysis Module:

Vol/Sat:	0.00	0.30	0.30	0.29	0.14	0.00	0.19	0.33	0.22	0.06	0.00	0.06
Crit Moves:	****						****			****		
Green/Cycle:	0.00	0.42	0.42	0.42	0.42	0.00	0.46	0.46	0.46	0.08	0.00	0.08
Volume/Cap:	0.00	0.72	0.72	0.69	0.33	0.00	0.42	0.72	0.49	0.72	0.00	0.72
Delay/Veh:	0.0	25.5	25.5	46.8	19.8	0.0	18.4	23.7	19.2	62.4	0.0	62.4
User DelAdj:	1.00	1.00	1.00	1.00	1.00	1.00	1.00	1.00	1.00	1.00	1.00	1.00
AdjDel/Veh:	0.0	25.5	25.5	46.8	19.8	0.0	18.4	23.7	19.2	62.4	0.0	62.4
LOS by Move:	A	C	C	D	B	A	B	C	B	E	A	E
HCM2k85thQ:	0	23	23	4	8	0	10	22	13	7	0	7

Note: Queue reported is the number of cars per lane.

Santa Ana Circulation Element

Level Of Service Computation Report

ICU 1(Loss as Cycle Length %) Method (Base Volume Alternative)

 Intersection #91 Tustin Ave and Fairhaven Ave

Cycle (sec): 100 Critical Vol./Cap.(X): 0.614
 Loss Time (sec): 5 Average Delay (sec/veh): xxxxxx
 Optimal Cycle: 30 Level Of Service: B

Approach:	North Bound			South Bound			East Bound			West Bound		
Movement:	L	T	R	L	T	R	L	T	R	L	T	R
Control:	Protected			Protected			Protected			Protected		
Rights:	Include			Include			Include			Ovl		
Min. Green:	0	0	0	0	0	0	0	0	0	0	0	0
Y+R:	4.0	4.0	4.0	4.0	4.0	4.0	4.0	4.0	4.0	4.0	4.0	4.0
Lanes:	2	0	2	1	0	0	2	0	2	1	0	1

Volume Module:

Base Vol:	239	1275	113	327	862	99	80	180	147	94	208	196
Growth Adj:	1.00	1.00	1.00	1.00	1.00	1.00	1.00	1.00	1.00	1.00	1.00	1.00
Initial Bse:	239	1275	113	327	862	99	80	180	147	94	208	196
User Adj:	1.00	1.00	1.00	1.00	1.00	1.00	1.00	1.00	1.00	1.00	1.00	1.00
PHF Adj:	1.00	1.00	1.00	1.00	1.00	1.00	1.00	1.00	1.00	1.00	1.00	1.00
PHF Volume:	239	1275	113	327	862	99	80	180	147	94	208	196
Reduct Vol:	0	0	0	0	0	0	0	0	0	0	0	0
Reduced Vol:	239	1275	113	327	862	99	80	180	147	94	208	196
PCE Adj:	1.00	1.00	1.00	1.00	1.00	1.00	1.00	1.00	1.00	1.00	1.00	1.00
MLF Adj:	1.00	1.00	1.00	1.00	1.00	1.00	1.00	1.00	1.00	1.00	1.00	1.00
FinalVolume:	239	1275	113	327	862	99	80	180	147	94	208	196
OvlAdjVol:	32											

Saturation Flow Module:

Sat/Lane:	1600	1600	1600	1600	1600	1600	1600	1600	1600	1600	1600	1600
Adjustment:	1.00	1.05	1.00	1.00	1.05	1.00	1.00	1.06	1.00	1.00	1.06	1.00
Lanes:	2.00	2.76	0.24	2.00	2.69	0.31	1.00	1.10	0.90	1.00	1.00	1.00
Final Sat.:	3200	4609	391	3200	4506	494	1600	1861	1439	1600	1700	1600

Capacity Analysis Module:

Vol/Sat:	0.07	0.28	0.29	0.10	0.19	0.20	0.05	0.10	0.10	0.06	0.12	0.12
OvlAdjV/S:	0.02											
Crit Moves:	****			****			****			****		

Santa Ana Circulation Element

Level Of Service Computation Report

ICU 1(Loss as Cycle Length %) Method (Base Volume Alternative)

Intersection #92 Tustin Ave and Santa Clara Ave

Cycle (sec): 100 Critical Vol./Cap.(X): 0.647
 Loss Time (sec): 5 Average Delay (sec/veh): xxxxxx
 Optimal Cycle: 32 Level Of Service: B

Approach:	North Bound			South Bound			East Bound			West Bound		
Movement:	L	T	R	L	T	R	L	T	R	L	T	R
Control:	Protected			Protected			Permitted			Permitted		
Rights:	Include			Include			Include			Include		
Min. Green:	0	0	0	0	0	0	0	0	0	0	0	0
Y+R:	4.0	4.0	4.0	4.0	4.0	4.0	4.0	4.0	4.0	4.0	4.0	4.0
Lanes:	1	0	2	1	0	2	1	0	1	1	0	1

Volume Module:

Base Vol:	163	789	121	183	1444	100	61	192	113	125	157	148
Growth Adj:	1.00	1.00	1.00	1.00	1.00	1.00	1.00	1.00	1.00	1.00	1.00	1.00
Initial Bse:	163	789	121	183	1444	100	61	192	113	125	157	148
User Adj:	1.00	1.00	1.00	1.00	1.00	1.00	1.00	1.00	1.00	1.00	1.00	1.00
PHF Adj:	1.00	1.00	1.00	1.00	1.00	1.00	1.00	1.00	1.00	1.00	1.00	1.00
PHF Volume:	163	789	121	183	1444	100	61	192	113	125	157	148
Reduct Vol:	0	0	0	0	0	0	0	0	0	0	0	0
Reduced Vol:	163	789	121	183	1444	100	61	192	113	125	157	148
PCE Adj:	1.00	1.00	1.00	1.00	1.00	1.00	1.00	1.00	1.00	1.00	1.00	1.00
MLF Adj:	1.00	1.00	1.00	1.00	1.00	1.00	1.00	1.00	1.00	1.00	1.00	1.00
FinalVolume:	163	789	121	183	1444	100	61	192	113	125	157	148

Saturation Flow Module:

Sat/Lane:	1600	1600	1600	1600	1600	1600	1600	1600	1600	1600	1600	1600
Adjustment:	1.00	1.05	1.00	1.00	1.04	1.00	1.00	1.05	1.00	1.00	1.06	1.00
Lanes:	1.00	2.60	0.40	2.00	2.81	0.19	1.00	1.26	0.74	1.00	1.03	0.97
Final Sat.:	1600	4362	638	3200	4689	311	1600	2114	1186	1600	1747	1553

Capacity Analysis Module:

Vol/Sat:	0.10	0.18	0.19	0.06	0.31	0.32	0.04	0.09	0.10	0.08	0.09	0.10
Crit Moves:	****					****			****	****		

Santa Ana Circulation Element

Level Of Service Computation Report

ICU 1(Loss as Cycle Length %) Method (Base Volume Alternative)

Intersection #93 Tustin Ave and 17th St

Cycle (sec): 100 Critical Vol./Cap.(X): 0.717
 Loss Time (sec): 5 Average Delay (sec/veh): xxxxxx
 Optimal Cycle: 39 Level Of Service: C

Approach:	North Bound			South Bound			East Bound			West Bound		
Movement:	L	T	R	L	T	R	L	T	R	L	T	R
Control:	Protected			Protected			Protected			Protected		
Rights:	Ovl			Include			Include			Ovl		
Min. Green:	0	0	0	0	0	0	0	0	0	0	0	0
Y+R:	4.0	4.0	4.0	4.0	4.0	4.0	4.0	4.0	4.0	4.0	4.0	4.0
Lanes:	2	0	2	0	1	0	2	0	3	0	1	2

Volume Module:

Base Vol:	216	926	476	346	371	37	444	872	118	229	753	419
Growth Adj:	1.00	1.00	1.00	1.00	1.00	1.00	1.00	1.00	1.00	1.00	1.00	1.00
Initial Bse:	216	926	476	346	371	37	444	872	118	229	753	419
User Adj:	1.00	1.00	1.00	1.00	1.00	1.00	1.00	1.00	1.00	1.00	1.00	1.00
PHF Adj:	1.00	1.00	1.00	1.00	1.00	1.00	1.00	1.00	1.00	1.00	1.00	1.00
PHF Volume:	216	926	476	346	371	37	444	872	118	229	753	419
Reduct Vol:	0	0	0	0	0	0	0	0	0	0	0	0
Reduced Vol:	216	926	476	346	371	37	444	872	118	229	753	419
PCE Adj:	1.00	1.00	1.00	1.00	1.00	1.00	1.00	1.00	1.00	1.00	1.00	1.00
MLF Adj:	1.00	1.00	1.00	1.00	1.00	1.00	1.00	1.00	1.00	1.00	1.00	1.00
FinalVolume:	216	926	476	346	371	37	444	872	118	229	753	419
OvlAdjVol:	362									246		

Saturation Flow Module:

Sat/Lane:	1600	1600	1600	1600	1600	1600	1600	1600	1600	1600	1600	1600
Adjustment:	1.00	1.06	1.00	1.00	1.05	1.00	1.00	1.06	1.00	1.00	1.06	1.00
Lanes:	2.00	2.00	1.00	2.00	2.73	0.27	2.00	3.00	1.00	2.00	3.00	1.00
Final Sat.:	3200	3400	1600	3200	4565	435	3200	5100	1600	3200	5100	1600

Capacity Analysis Module:

Vol/Sat:	0.07	0.27	0.30	0.11	0.08	0.08	0.14	0.17	0.07	0.07	0.15	0.26
OvlAdjV/S:	0.23									0.15		
Crit Moves:	****			****			****			****		

Santa Ana Circulation Element

Level Of Service Computation Report

ICU 1(Loss as Cycle Length %) Method (Base Volume Alternative)

Intersection #94 Tustin Ave and 4th St

Cycle (sec): 100 Critical Vol./Cap.(X): 0.692
 Loss Time (sec): 5 Average Delay (sec/veh): xxxxxx
 Optimal Cycle: 36 Level Of Service: B

Approach:	North Bound			South Bound			East Bound			West Bound		
Movement:	L	T	R	L	T	R	L	T	R	L	T	R
Control:	Protected			Protected			Protected			Protected		
Rights:	Include			Include			Include			Include		
Min. Green:	0	0	0	0	0	0	0	0	0	0	0	0
Y+R:	4.0	4.0	4.0	4.0	4.0	4.0	4.0	4.0	4.0	4.0	4.0	4.0
Lanes:	1	0	2	1	0	2	1	0	2	1	0	2

Volume Module:

Base Vol:	55	598	194	459	339	124	180	642	33	88	596	367
Growth Adj:	1.00	1.00	1.00	1.00	1.00	1.00	1.00	1.00	1.00	1.00	1.00	1.00
Initial Bse:	55	598	194	459	339	124	180	642	33	88	596	367
User Adj:	1.00	1.00	1.00	1.00	1.00	1.00	1.00	1.00	1.00	1.00	1.00	1.00
PHF Adj:	1.00	1.00	1.00	1.00	1.00	1.00	1.00	1.00	1.00	1.00	1.00	1.00
PHF Volume:	55	598	194	459	339	124	180	642	33	88	596	367
Reduct Vol:	0	0	0	0	0	0	0	0	0	0	0	0
Reduced Vol:	55	598	194	459	339	124	180	642	33	88	596	367
PCE Adj:	1.00	1.00	1.00	1.00	1.00	1.00	1.00	1.00	1.00	1.00	1.00	1.00
MLF Adj:	1.00	1.00	1.00	1.00	1.00	1.00	1.00	1.00	1.00	1.00	1.00	1.00
FinalVolume:	55	598	194	459	339	124	180	642	33	88	596	367

Saturation Flow Module:

Sat/Lane:	1600	1600	1600	1600	1600	1600	1600	1600	1600	1600	1600	1600
Adjustment:	1.00	1.06	1.00	1.00	1.06	1.00	1.00	1.04	1.00	1.00	1.06	1.00
Lanes:	1.00	2.27	0.73	2.00	2.00	1.00	1.00	2.85	0.15	1.00	2.00	1.00
Final Sat.:	1600	3824	1176	3200	3400	1600	1600	4765	235	1600	3400	1600

Capacity Analysis Module:

Vol/Sat:	0.03	0.16	0.16	0.14	0.10	0.08	0.11	0.13	0.14	0.06	0.18	0.23
Crit Moves:	****			****			****			****		

Santa Ana Circulation Element

Level Of Service Computation Report
 2000 HCM Operations Method (Base Volume Alternative)

 Intersection #95 SR-55 SB Ramps / Auto Mall Dr and Edinger Ave

Cycle (sec): 100 Critical Vol./Cap.(X): 0.583
 Loss Time (sec): 5 Average Delay (sec/veh): 25.1
 Optimal Cycle: 29 Level Of Service: C

Approach:	North Bound			South Bound			East Bound			West Bound		
Movement:	L	T	R	L	T	R	L	T	R	L	T	R
Control:	Split Phase			Split Phase			Protected			Protected		
Rights:	Include			Include			Ignore			Include		
Min. Green:	0	0	0	0	0	0	0	0	0	0	0	0
Y+R:	4.0	4.0	4.0	4.0	4.0	4.0	4.0	4.0	4.0	4.0	4.0	4.0
Lanes:	1	1	0	0	2	1	1	0	1	0	3	0

Volume Module:

Base Vol:	377	30	398	110	50	37	35	1258	354	385	1003	120
Growth Adj:	1.00	1.00	1.00	1.00	1.00	1.00	1.00	1.00	1.00	1.00	1.00	1.00
Initial Bse:	377	30	398	110	50	37	35	1258	354	385	1003	120
User Adj:	1.00	1.00	1.00	1.00	1.00	1.00	1.00	1.00	0.00	1.00	1.00	1.00
PHF Adj:	1.00	1.00	1.00	1.00	1.00	1.00	1.00	1.00	0.00	1.00	1.00	1.00
PHF Volume:	377	30	398	110	50	37	35	1258	0	385	1003	120
Reduct Vol:	0	0	0	0	0	0	0	0	0	0	0	0
Reduced Vol:	377	30	398	110	50	37	35	1258	0	385	1003	120
PCE Adj:	1.00	1.00	1.00	1.00	1.00	1.00	1.00	1.00	0.00	1.00	1.00	1.00
MLF Adj:	1.00	1.00	1.00	1.00	1.00	1.00	1.00	1.00	0.00	1.00	1.00	1.00
FinalVolume:	377	30	398	110	50	37	35	1258	0	385	1003	120

Saturation Flow Module:

Sat/Lane:	1900	1900	1900	1900	1900	1900	1900	1900	1900	1900	1900	1900
Adjustment:	0.96	0.96	0.75	0.95	1.00	0.85	0.95	0.91	1.00	0.92	0.90	0.90
Lanes:	1.85	0.15	2.00	1.00	1.00	1.00	1.00	3.00	1.00	2.00	2.68	0.32
Final Sat.:	3365	268	2842	1805	1900	1615	1805	5187	1900	3502	4559	545

Capacity Analysis Module:

Vol/Sat:	0.11	0.11	0.14	0.06	0.03	0.02	0.02	0.24	0.00	0.11	0.22	0.22
Crit Moves:	****			****			****			****		
Green/Cycle:	0.24	0.24	0.24	0.10	0.10	0.10	0.05	0.42	0.00	0.19	0.56	0.56
Volume/Cap:	0.47	0.47	0.58	0.58	0.25	0.22	0.40	0.58	0.00	0.58	0.40	0.40
Delay/Veh:	32.9	32.9	34.8	47.3	41.8	41.7	49.0	22.9	0.0	38.3	12.7	12.7
User DelAdj:	1.00	1.00	1.00	1.00	1.00	1.00	1.00	1.00	1.00	1.00	1.00	1.00
AdjDel/Veh:	32.9	32.9	34.8	47.3	41.8	41.7	49.0	22.9	0.0	38.3	12.7	12.7
LOS by Move:	C	C	C	D	D	D	D	C	A	D	B	B
HCM2k85thQ:	9	9	11	6	3	2	2	17	0	10	11	11

Note: Queue reported is the number of cars per lane.

Santa Ana Circulation Element

Level Of Service Computation Report

2000 HCM Operations Method (Base Volume Alternative)

 Intersection #96 SR-55 NB Ramps / Del Amo Ave and Newport Avenue

Cycle (sec): 100 Critical Vol./Cap.(X): 0.525
 Loss Time (sec): 5 Average Delay (sec/veh): 27.4
 Optimal Cycle: 26 Level Of Service: C

Approach:	North Bound			South Bound			East Bound			West Bound		
Movement:	L	T	R	L	T	R	L	T	R	L	T	R
Control:	Protected			Protected			Protected			Protected		
Rights:	Include			Ovl			Include			Include		
Min. Green:	0	0	0	0	0	0	0	0	0	0	0	0
Y+R:	4.0	4.0	4.0	4.0	4.0	4.0	4.0	4.0	4.0	4.0	4.0	4.0
Lanes:	2	0	2	1	0	3	0	1	1	0	1	1

Volume Module:	North Bound			South Bound			East Bound			West Bound		
Base Vol:	583	174	34	8	97	373	104	36	21	23	348	16
Growth Adj:	1.00	1.00	1.00	1.00	1.00	1.00	1.00	1.00	1.00	1.00	1.00	1.00
Initial Bse:	583	174	34	8	97	373	104	36	21	23	348	16
User Adj:	1.00	1.00	1.00	1.00	1.00	1.00	1.00	1.00	1.00	1.00	1.00	1.00
PHF Adj:	1.00	1.00	1.00	1.00	1.00	1.00	1.00	1.00	1.00	1.00	1.00	1.00
PHF Volume:	583	174	34	8	97	373	104	36	21	23	348	16
Reduct Vol:	0	0	0	0	0	0	0	0	0	0	0	0
Reduced Vol:	583	174	34	8	97	373	104	36	21	23	348	16
PCE Adj:	1.00	1.00	1.00	1.00	1.00	1.00	1.00	1.00	1.00	1.00	1.00	1.00
MLF Adj:	1.00	1.00	1.00	1.00	1.00	1.00	1.00	1.00	1.00	1.00	1.00	1.00
FinalVolume:	583	174	34	8	97	373	104	36	21	23	348	16

Saturation Flow Module:	North Bound			South Bound			East Bound			West Bound		
Sat/Lane:	1900	1900	1900	1900	1900	1900	1900	1900	1900	1900	1900	1900
Adjustment:	0.92	0.89	0.89	0.95	0.91	0.85	0.92	0.90	0.90	0.95	0.94	0.94
Lanes:	2.00	2.51	0.49	1.00	3.00	1.00	2.00	1.26	0.74	1.00	1.91	0.09
Final Sat.:	3502	4235	828	1805	5187	1615	3502	2155	1257	1805	3427	158

Capacity Analysis Module:	North Bound			South Bound			East Bound			West Bound		
Vol/Sat:	0.17	0.04	0.04	0.00	0.02	0.23	0.03	0.02	0.02	0.01	0.10	0.10
Crit Moves:	****					****	****				****	
Green/Cycle:	0.32	0.63	0.63	0.07	0.38	0.44	0.06	0.14	0.14	0.11	0.19	0.19
Volume/Cap:	0.53	0.07	0.07	0.07	0.05	0.53	0.53	0.12	0.12	0.12	0.53	0.53
Delay/Veh:	28.5	7.1	7.1	43.8	19.4	21.1	48.5	37.6	37.6	40.6	37.0	37.0
User DelAdj:	1.00	1.00	1.00	1.00	1.00	1.00	1.00	1.00	1.00	1.00	1.00	1.00
AdjDel/Veh:	28.5	7.1	7.1	43.8	19.4	21.1	48.5	37.6	37.6	40.6	37.0	37.0
LOS by Move:	C	A	A	D	B	C	D	D	D	D	D	D
HCM2k85thQ:	12	1	1	0	1	13	4	1	1	1	9	9

Note: Queue reported is the number of cars per lane.

Santa Ana Circulation Element

Level Of Service Computation Report

ICU 1(Loss as Cycle Length %) Method (Base Volume Alternative)

 Intersection #97 Red Hill Ave and Edinger Ave

Cycle (sec): 100 Critical Vol./Cap.(X): 0.667
 Loss Time (sec): 5 Average Delay (sec/veh): xxxxxx
 Optimal Cycle: 34 Level Of Service: B

Approach:	North Bound			South Bound			East Bound			West Bound		
Movement:	L	T	R	L	T	R	L	T	R	L	T	R
Control:	Protected			Protected			Protected			Protected		
Rights:	Include			Ovl			Ovl			Include		
Min. Green:	0	0	0	0	0	0	0	0	0	0	0	0
Y+R:	4.0	4.0	4.0	4.0	4.0	4.0	4.0	4.0	4.0	4.0	4.0	4.0
Lanes:	2	0	3	0	1		2	0	3	0	1	

Volume Module:

Base Vol:	159	1146	182	145	289	234	327	838	102	62	803	392
Growth Adj:	1.00	1.00	1.00	1.00	1.00	1.00	1.00	1.00	1.00	1.00	1.00	1.00
Initial Bse:	159	1146	182	145	289	234	327	838	102	62	803	392
User Adj:	1.00	1.00	1.00	1.00	1.00	1.00	1.00	1.00	1.00	1.00	1.00	1.00
PHF Adj:	1.00	1.00	1.00	1.00	1.00	1.00	1.00	1.00	1.00	1.00	1.00	1.00
PHF Volume:	159	1146	182	145	289	234	327	838	102	62	803	392
Reduct Vol:	0	0	0	0	0	0	0	0	0	0	0	0
Reduced Vol:	159	1146	182	145	289	234	327	838	102	62	803	392
PCE Adj:	1.00	1.00	1.00	1.00	1.00	1.00	1.00	1.00	1.00	1.00	1.00	1.00
MLF Adj:	1.00	1.00	1.00	1.00	1.00	1.00	1.00	1.00	1.00	1.00	1.00	1.00
FinalVolume:	159	1146	182	145	289	234	327	838	102	62	803	392
OvlAdjVol:	70						22					

Saturation Flow Module:

Sat/Lane:	1600	1600	1600	1600	1600	1600	1600	1600	1600	1600	1600	1600
Adjustment:	1.00	1.06	1.00	1.00	1.06	1.00	1.00	1.06	1.00	1.00	1.06	1.00
Lanes:	2.00	3.00	1.00	2.00	3.00	1.00	2.00	3.00	1.00	2.00	3.00	1.00
Final Sat.:	3200	5100	1600	3200	5100	1600	3200	5100	1600	3200	5100	1600

Capacity Analysis Module:

Vol/Sat:	0.05	0.22	0.11	0.05	0.06	0.15	0.10	0.16	0.06	0.02	0.16	0.25
OvlAdjV/S:	0.04						0.01					
Crit Moves:	****			****			****			****		

Santa Ana Circulation Element

Level Of Service Computation Report

ICU 1(Loss as Cycle Length %) Method (Base Volume Alternative)

Intersection #98 Red Hill Ave and Warner Ave

Cycle (sec): 100 Critical Vol./Cap.(X): 0.588
 Loss Time (sec): 5 Average Delay (sec/veh): xxxxxxx
 Optimal Cycle: 28 Level Of Service: A

Approach:	North Bound			South Bound			East Bound			West Bound		
Movement:	L	T	R	L	T	R	L	T	R	L	T	R
Control:	Protected			Protected			Protected			Protected		
Rights:	Include			Include			Include			Ovl		
Min. Green:	0	0	0	0	0	0	0	0	0	0	0	0
Y+R:	4.0	4.0	4.0	4.0	4.0	4.0	4.0	4.0	4.0	4.0	4.0	4.0
Lanes:	2	0	3	1	0	0	2	0	2	1	0	3

Volume Module:

Base Vol:	382	1308	150	58	223	283	222	603	94	25	525	69
Growth Adj:	1.00	1.00	1.00	1.00	1.00	1.00	1.00	1.00	1.00	1.00	1.00	1.00
Initial Bse:	382	1308	150	58	223	283	222	603	94	25	525	69
User Adj:	1.00	1.00	1.00	1.00	1.00	1.00	1.00	1.00	1.00	1.00	1.00	1.00
PHF Adj:	1.00	1.00	1.00	1.00	1.00	1.00	1.00	1.00	1.00	1.00	1.00	1.00
PHF Volume:	382	1308	150	58	223	283	222	603	94	25	525	69
Reduct Vol:	0	0	0	0	0	0	0	0	0	0	0	0
Reduced Vol:	382	1308	150	58	223	283	222	603	94	25	525	69
PCE Adj:	1.00	1.00	1.00	1.00	1.00	1.00	1.00	1.00	1.00	1.00	1.00	1.00
MLF Adj:	1.00	1.00	1.00	1.00	1.00	1.00	1.00	1.00	1.00	1.00	1.00	1.00
FinalVolume:	382	1308	150	58	223	283	222	603	94	25	525	69
OvlAdjVol:	40											

Saturation Flow Module:

Sat/Lane:	1600	1600	1600	1600	1600	1600	1600	1600	1600	1600	1600	1600
Adjustment:	1.00	1.05	1.00	1.00	1.06	1.00	1.00	1.05	1.00	1.00	1.06	1.00
Lanes:	2.00	3.59	0.41	2.00	2.00	1.00	1.00	2.60	0.40	2.00	3.00	1.00
Final Sat.:	3200	6042	658	3200	3400	1600	1600	4353	647	3200	5100	1600

Capacity Analysis Module:

Vol/Sat:	0.12	0.22	0.23	0.02	0.07	0.18	0.14	0.14	0.15	0.01	0.10	0.04
OvlAdjV/S:	0.03											
Crit Moves:	****			****			****			****		

Santa Ana Circulation Element

Level Of Service Computation Report

ICU 1(Loss as Cycle Length %) Method (Base Volume Alternative)

Intersection #99 Red Hill Ave and Dyer Rd / barranca Pkwy

Cycle (sec): 100 Critical Vol./Cap.(X): 0.563
 Loss Time (sec): 5 Average Delay (sec/veh): xxxxxxx
 Optimal Cycle: 27 Level Of Service: A

Approach:	North Bound			South Bound			East Bound			West Bound		
Movement:	L	T	R	L	T	R	L	T	R	L	T	R
Control:	Protected			Protected			Protected			Protected		
Rights:	Include			Include			Include			Include		
Min. Green:	0	0	0	0	0	0	0	0	0	0	0	0
Y+R:	4.0	4.0	4.0	4.0	4.0	4.0	4.0	4.0	4.0	4.0	4.0	4.0
Lanes:	2	0	4	0	1		2	0	4	0	1	

Volume Module:

Base Vol:	356	1339	345	185	313	147	203	753	99	127	966	282
Growth Adj:	1.00	1.00	1.00	1.00	1.00	1.00	1.00	1.00	1.00	1.00	1.00	1.00
Initial Bse:	356	1339	345	185	313	147	203	753	99	127	966	282
User Adj:	1.00	1.00	1.00	1.00	1.00	1.00	1.00	1.00	1.00	1.00	1.00	1.00
PHF Adj:	1.00	1.00	1.00	1.00	1.00	1.00	1.00	1.00	1.00	1.00	1.00	1.00
PHF Volume:	356	1339	345	185	313	147	203	753	99	127	966	282
Reduct Vol:	0	0	0	0	0	0	0	0	0	0	0	0
Reduced Vol:	356	1339	345	185	313	147	203	753	99	127	966	282
PCE Adj:	1.00	1.00	1.00	1.00	1.00	1.00	1.00	1.00	1.00	1.00	1.00	1.00
MLF Adj:	1.00	1.00	1.00	1.00	1.00	1.00	1.00	1.00	1.00	1.00	1.00	1.00
FinalVolume:	356	1339	345	185	313	147	203	753	99	127	966	282

Saturation Flow Module:

Sat/Lane:	1600	1600	1600	1600	1600	1600	1600	1600	1600	1600	1600	1600
Adjustment:	1.00	1.06	1.00	1.00	1.06	1.00	1.00	1.05	1.00	1.00	1.06	1.00
Lanes:	2.00	4.00	1.00	2.00	4.00	1.00	2.00	3.54	0.46	2.00	4.00	1.00
Final Sat.:	3200	6800	1600	3200	6800	1600	3200	5956	744	3200	6800	1600

Capacity Analysis Module:

Vol/Sat:	0.11	0.20	0.22	0.06	0.05	0.09	0.06	0.13	0.13	0.04	0.14	0.18
Crit Moves:			****	****			****			****		

Santa Ana Circulation Element

Level Of Service Computation Report

ICU 1(Loss as Cycle Length %) Method (Base Volume Alternative)

Intersection #100 Red Hill Ave and Alton Pkwy

Cycle (sec): 100 Critical Vol./Cap.(X): 0.671
 Loss Time (sec): 5 Average Delay (sec/veh): xxxxxx
 Optimal Cycle: 34 Level Of Service: B

Approach:	North Bound			South Bound			East Bound			West Bound		
Movement:	L	T	R	L	T	R	L	T	R	L	T	R
Control:	Protected			Protected			Protected			Protected		
Rights:	Include			Include			Include			Include		
Min. Green:	0	0	0	0	0	0	0	0	0	0	0	0
Y+R:	4.0	4.0	4.0	4.0	4.0	4.0	4.0	4.0	4.0	4.0	4.0	4.0
Lanes:	1	0	3	0	1	1	1	0	2	0	1	0

Volume Module:

Base Vol:	27	1499	217	124	528	4	132	324	166	433	74	267
Growth Adj:	1.00	1.00	1.00	1.00	1.00	1.00	1.00	1.00	1.00	1.00	1.00	1.00
Initial Bse:	27	1499	217	124	528	4	132	324	166	433	74	267
User Adj:	1.00	1.00	1.00	1.00	1.00	1.00	1.00	1.00	1.00	1.00	1.00	1.00
PHF Adj:	1.00	1.00	1.00	1.00	1.00	1.00	1.00	1.00	1.00	1.00	1.00	1.00
PHF Volume:	27	1499	217	124	528	4	132	324	166	433	74	267
Reduct Vol:	0	0	0	0	0	0	0	0	0	0	0	0
Reduced Vol:	27	1499	217	124	528	4	132	324	166	433	74	267
PCE Adj:	1.00	1.00	1.00	1.00	1.00	1.00	1.00	1.00	1.00	1.00	1.00	1.00
MLF Adj:	1.00	1.00	1.00	1.00	1.00	1.00	1.00	1.00	1.00	1.00	1.00	1.00
FinalVolume:	27	1499	217	124	528	4	132	324	166	433	74	267

Saturation Flow Module:

Sat/Lane:	1600	1600	1600	1600	1600	1600	1600	1600	1600	1600	1600	1600
Adjustment:	1.00	1.06	1.00	1.00	1.06	1.00	1.00	1.06	1.00	1.00	1.06	1.00
Lanes:	1.00	3.00	1.00	1.00	3.00	1.00	1.00	2.00	1.00	2.00	1.00	1.00
Final Sat.:	1600	5100	1600	1600	5100	1600	1600	3400	1600	3200	1700	1600

Capacity Analysis Module:

Vol/Sat:	0.02	0.29	0.14	0.08	0.10	0.00	0.08	0.10	0.10	0.14	0.04	0.17
Crit Moves:	****			****			****			****		

Santa Ana Circulation Element

Level Of Service Computation Report

ICU 1(Loss as Cycle Length %) Method (Base Volume Alternative)

Intersection #101 Red Hill Ave and MacArthur Blvd

Cycle (sec): 100 Critical Vol./Cap.(X): 0.657
 Loss Time (sec): 5 Average Delay (sec/veh): xxxxxx
 Optimal Cycle: 33 Level Of Service: B

Approach:	North Bound			South Bound			East Bound			West Bound		
Movement:	L	T	R	L	T	R	L	T	R	L	T	R
Control:	Protected			Protected			Protected			Protected		
Rights:	Include			Ignore			Include			Ignore		
Min. Green:	0	0	0	0	0	0	0	0	0	0	0	0
Y+R:	4.0	4.0	4.0	4.0	4.0	4.0	4.0	4.0	4.0	4.0	4.0	4.0
Lanes:	2	0	2	1	0	0	2	0	3	0	1	0

Volume Module:	North Bound			South Bound			East Bound			West Bound		
Base Vol:	125	809	10	286	594	1042	597	275	42	39	818	574
Growth Adj:	1.00	1.00	1.00	1.00	1.00	1.00	1.00	1.00	1.00	1.00	1.00	1.00
Initial Bse:	125	809	10	286	594	1042	597	275	42	39	818	574
User Adj:	1.00	1.00	1.00	1.00	1.00	0.00	1.00	1.00	1.00	1.00	1.00	0.00
PHF Adj:	1.00	1.00	1.00	1.00	1.00	0.00	1.00	1.00	1.00	1.00	1.00	0.00
PHF Volume:	125	809	10	286	594	0	597	275	42	39	818	0
Reduct Vol:	0	0	0	0	0	0	0	0	0	0	0	0
Reduced Vol:	125	809	10	286	594	0	597	275	42	39	818	0
PCE Adj:	1.00	1.00	1.00	1.00	1.00	0.00	1.00	1.00	1.00	1.00	1.00	0.00
MLF Adj:	1.00	1.00	1.00	1.00	1.00	0.00	1.00	1.00	1.00	1.00	1.00	0.00
FinalVolume:	125	809	10	286	594	0	597	275	42	39	818	0

Saturation Flow Module:	North Bound			South Bound			East Bound			West Bound		
Sat/Lane:	1600	1600	1600	1600	1600	1600	1600	1600	1600	1600	1600	1600
Adjustment:	1.00	1.04	1.00	1.00	1.06	1.00	1.00	1.06	1.00	1.00	1.06	1.00
Lanes:	2.00	2.96	0.04	2.00	3.00	1.00	2.00	3.00	1.00	1.00	3.00	1.00
Final Sat.:	3200	4941	59	3200	5100	1600	3200	5100	1600	1600	5100	1600

Capacity Analysis Module:	North Bound			South Bound			East Bound			West Bound		
Vol/Sat:	0.04	0.16	0.17	0.09	0.12	0.00	0.19	0.05	0.03	0.02	0.16	0.00
Crit Moves:	****			****			****			****		

Santa Ana Circulation Element

Level Of Service Computation Report

ICU 1(Loss as Cycle Length %) Method (Base Volume Alternative)

Intersection #102 Red Hill Ave and Main St

Cycle (sec): 100 Critical Vol./Cap.(X): 0.774
 Loss Time (sec): 5 Average Delay (sec/veh): xxxxxx
 Optimal Cycle: 47 Level Of Service: C

Approach:	North Bound			South Bound			East Bound			West Bound		
Movement:	L	T	R	L	T	R	L	T	R	L	T	R
Control:	Protected			Protected			Protected			Protected		
Rights:	Include			Include			Include			Include		
Min. Green:	0	0	0	0	0	0	0	0	0	0	0	0
Y+R:	4.0	4.0	4.0	4.0	4.0	4.0	4.0	4.0	4.0	4.0	4.0	4.0
Lanes:	2	0	2	0	2	0	1	2	0	2	1	0

Volume Module:

Base Vol:	416	897	242	74	538	292	198	705	191	279	1589	89
Growth Adj:	1.00	1.00	1.00	1.00	1.00	1.00	1.00	1.00	1.00	1.00	1.00	1.00
Initial Bse:	416	897	242	74	538	292	198	705	191	279	1589	89
User Adj:	1.00	1.00	1.00	1.00	1.00	1.00	1.00	1.00	1.00	1.00	1.00	1.00
PHF Adj:	1.00	1.00	1.00	1.00	1.00	1.00	1.00	1.00	1.00	1.00	1.00	1.00
PHF Volume:	416	897	242	74	538	292	198	705	191	279	1589	89
Reduct Vol:	0	0	0	0	0	0	0	0	0	0	0	0
Reduced Vol:	416	897	242	74	538	292	198	705	191	279	1589	89
PCE Adj:	1.00	1.00	1.00	1.00	1.00	1.00	1.00	1.00	1.00	1.00	1.00	1.00
MLF Adj:	1.00	1.00	1.00	1.00	1.00	1.00	1.00	1.00	1.00	1.00	1.00	1.00
FinalVolume:	416	897	242	74	538	292	198	705	191	279	1589	89

Saturation Flow Module:

Sat/Lane:	1600	1600	1600	1600	1600	1600	1600	1600	1600	1600	1600	1600
Adjustment:	1.00	1.06	1.00	1.00	1.06	1.00	1.00	1.05	1.00	1.00	1.04	1.00
Lanes:	2.00	2.00	1.00	2.00	2.00	1.00	2.00	2.36	0.64	2.00	2.84	0.16
Final Sat.:	3200	3400	1600	3200	3400	1600	3200	3977	1023	3200	4745	255

Capacity Analysis Module:

Vol/Sat:	0.13	0.26	0.15	0.02	0.16	0.18	0.06	0.18	0.19	0.09	0.33	0.35
Crit Moves:	****					****	****					****

Santa Ana Circulation Element

Level Of Service Computation Report

2000 HCM Operations Method (Base Volume Alternative)

 Intersection #103 I-5 SB Ramps and Santa Ana Blvd

Cycle (sec): 100 Critical Vol./Cap.(X): 0.431
 Loss Time (sec): 5 Average Delay (sec/veh): 18.9
 Optimal Cycle: 22 Level Of Service: B

Approach:	North Bound			South Bound			East Bound			West Bound		
Movement:	L	T	R	L	T	R	L	T	R	L	T	R
Control:	Split Phase			Split Phase			Protected			Protected		
Rights:	Include			Ovl			Include			Include		
Min. Green:	0	0	0	0	0	0	0	0	0	0	0	0
Y+R:	4.0	4.0	4.0	4.0	4.0	4.0	4.0	4.0	4.0	4.0	4.0	4.0
Lanes:	0	0	0	2	0	0	2	0	3	0	0	2

Volume Module:	North Bound			South Bound			East Bound			West Bound		
Base Vol:	0	0	0	278	0	61	561	634	0	0	668	183
Growth Adj:	1.00	1.00	1.00	1.00	1.00	1.00	1.00	1.00	1.00	1.00	1.00	1.00
Initial Bse:	0	0	0	278	0	61	561	634	0	0	668	183
User Adj:	1.00	1.00	1.00	1.00	1.00	1.00	1.00	1.00	1.00	1.00	1.00	1.00
PHF Adj:	1.00	1.00	1.00	1.00	1.00	1.00	1.00	1.00	1.00	1.00	1.00	1.00
PHF Volume:	0	0	0	278	0	61	561	634	0	0	668	183
Reduct Vol:	0	0	0	0	0	0	0	0	0	0	0	0
Reduced Vol:	0	0	0	278	0	61	561	634	0	0	668	183
PCE Adj:	1.00	1.00	1.00	1.00	1.00	1.00	1.00	1.00	1.00	1.00	1.00	1.00
MLF Adj:	1.00	1.00	1.00	1.00	1.00	1.00	1.00	1.00	1.00	1.00	1.00	1.00
FinalVolume:	0	0	0	278	0	61	561	634	0	0	668	183

Saturation Flow Module:	North Bound			South Bound			East Bound			West Bound		
Sat/Lane:	1900	1900	1900	1900	1900	1900	1900	1900	1900	1900	1900	1900
Adjustment:	1.00	1.00	1.00	0.92	1.00	0.85	0.92	0.91	1.00	1.00	0.88	0.88
Lanes:	0.00	0.00	0.00	2.00	0.00	1.00	2.00	3.00	0.00	0.00	2.35	0.65
Final Sat.:	0	0	0	3502	0	1615	3502	5187	0	0	3941	1080

Capacity Analysis Module:	North Bound			South Bound			East Bound			West Bound		
Vol/Sat:	0.00	0.00	0.00	0.08	0.00	0.04	0.16	0.12	0.00	0.00	0.17	0.17
Crit Moves:				****			****				****	
Green/Cycle:	0.00	0.00	0.00	0.18	0.00	0.56	0.37	0.77	0.00	0.00	0.39	0.39
Volume/Cap:	0.00	0.00	0.00	0.43	0.00	0.07	0.43	0.16	0.00	0.00	0.43	0.43
Delay/Veh:	0.0	0.0	0.0	36.6	0.0	10.3	23.7	3.1	0.0	0.0	22.3	22.3
User DelAdj:	1.00	1.00	1.00	1.00	1.00	1.00	1.00	1.00	1.00	1.00	1.00	1.00

AdjDel/Veh:	0.0	0.0	0.0	36.6	0.0	10.3	23.7	3.1	0.0	0.0	22.3	22.3
LOS by Move:	A	A	A	D	A	B	C	A	A	A	C	C
HCM2k85thQ:	0	0	0	7	0	1	10	3	0	0	11	11

Note: Queue reported is the number of cars per lane.

Santa Ana Circulation Element

Level Of Service Computation Report

ICU 1(Loss as Cycle Length %) Method (Base Volume Alternative)

 Intersection #104 Tustin Ranch Rd and Warner Ave

Cycle (sec): 100 Critical Vol./Cap.(X): 0.606
 Loss Time (sec): 5 Average Delay (sec/veh): xxxxxx
 Optimal Cycle: 29 Level Of Service: B

Approach:	North Bound			South Bound			East Bound			West Bound		
Movement:	L	T	R	L	T	R	L	T	R	L	T	R
Control:	Split Phase			Split Phase			Protected			Protected		
Rights:	Ovl			Include			Include			Ovl		
Min. Green:	0	0	0	0	0	0	0	0	0	0	0	0
Y+R:	4.0	4.0	4.0	4.0	4.0	4.0	4.0	4.0	4.0	4.0	4.0	4.0
Lanes:	0	0	0	2	0	0	2	0	3	0	0	3

Volume Module:

Base Vol:	0	0	0	653	0	45	54	1795	0	0	548	236
Growth Adj:	1.00	1.00	1.00	1.00	1.00	1.00	1.00	1.00	1.00	1.00	1.00	1.00
Initial Bse:	0	0	0	653	0	45	54	1795	0	0	548	236
User Adj:	1.00	1.00	1.00	1.00	1.00	1.00	1.00	1.00	1.00	1.00	1.00	1.00
PHF Adj:	1.00	1.00	1.00	1.00	1.00	1.00	1.00	1.00	1.00	1.00	1.00	1.00
PHF Volume:	0	0	0	653	0	45	54	1795	0	0	548	236
Reduct Vol:	0	0	0	0	0	0	0	0	0	0	0	0
Reduced Vol:	0	0	0	653	0	45	54	1795	0	0	548	236
PCE Adj:	1.00	1.00	1.00	1.00	1.00	1.00	1.00	1.00	1.00	1.00	1.00	1.00
MLF Adj:	1.00	1.00	1.00	1.00	1.00	1.00	1.00	1.00	1.00	1.00	1.00	1.00
FinalVolume:	0	0	0	653	0	45	54	1795	0	0	548	236
OvlAdjVol:	0											

Saturation Flow Module:

Sat/Lane:	1600	1600	1600	1600	1600	1600	1600	1600	1600	1600	1600	1600
Adjustment:	1.00	1.06	1.00	1.00	1.06	1.00	1.00	1.06	1.00	1.00	1.06	1.00
Lanes:	0.00	0.00	0.00	2.00	0.00	1.00	2.00	3.00	0.00	0.00	3.00	1.00
Final Sat.:	0	0	0	3200	0	1600	3200	5100	0	0	5100	1600

Capacity Analysis Module:

Vol/Sat:	0.00	0.00	0.00	0.20	0.00	0.03	0.02	0.35	0.00	0.00	0.11	0.15
OvlAdjV/S:	0.00											
Crit Moves:				****				****				****

Santa Ana Circulation Element

Level Of Service Computation Report

ICU 1(Loss as Cycle Length %) Method (Base Volume Alternative)

Intersection #105 Von Karman Ave and Barranca Pkwy

Cycle (sec): 100 Critical Vol./Cap.(X): 0.874
 Loss Time (sec): 5 Average Delay (sec/veh): xxxxxxx
 Optimal Cycle: 74 Level Of Service: D

Approach:	North Bound			South Bound			East Bound			West Bound							
Movement:	L	T	R	L	T	R	L	T	R	L	T	R					
Control:	Protected			Protected			Protected			Protected							
Rights:	Include			Ovl			Include			Include							
Min. Green:	0	0	0	0	0	0	0	0	0	0	0	0					
Y+R:	4.0	4.0	4.0	4.0	4.0	4.0	4.0	4.0	4.0	4.0	4.0	4.0					
Lanes:	2	0	1	1	0	0	2	0	2	0	2	1	2	0	4	0	1

Volume Module:

Base Vol:	224	1290	281	67	343	236	560	1023	143	204	646	220
Growth Adj:	1.00	1.00	1.00	1.00	1.00	1.00	1.00	1.00	1.00	1.00	1.00	1.00
Initial Bse:	224	1290	281	67	343	236	560	1023	143	204	646	220
User Adj:	1.00	1.00	1.00	1.00	1.00	1.00	1.00	1.00	1.00	1.00	1.00	1.00
PHF Adj:	1.00	1.00	1.00	1.00	1.00	1.00	1.00	1.00	1.00	1.00	1.00	1.00
PHF Volume:	224	1290	281	67	343	236	560	1023	143	204	646	220
Reduct Vol:	0	0	0	0	0	0	0	0	0	0	0	0
Reduced Vol:	224	1290	281	67	343	236	560	1023	143	204	646	220
PCE Adj:	1.00	1.00	1.00	1.00	1.00	1.00	1.00	1.00	1.00	1.00	1.00	1.00
MLF Adj:	1.00	1.00	1.00	1.00	1.00	1.00	1.00	1.00	1.00	1.00	1.00	1.00
FinalVolume:	224	1290	281	67	343	236	560	1023	143	204	646	220
OvlAdjVol:	0											

Saturation Flow Module:

Sat/Lane:	1600	1600	1600	1600	1600	1600	1600	1600	1600	1600	1600	1600
Adjustment:	1.00	1.04	1.00	1.00	1.06	1.00	1.00	1.06	1.00	1.00	1.06	1.00
Lanes:	2.00	1.64	0.36	2.00	2.00	2.00	2.00	3.00	1.00	2.00	4.00	1.00
Final Sat.:	3200	2728	572	3200	3400	3200	3200	5100	1600	3200	6800	1600

Capacity Analysis Module:

Vol/Sat:	0.07	0.47	0.49	0.02	0.10	0.07	0.17	0.20	0.09	0.06	0.10	0.14
OvlAdjV/S:							0.00					
Crit Moves:	****			****			****			****		

Santa Ana Circulation Element

Level Of Service Computation Report

ICU 1(Loss as Cycle Length %) Method (Base Volume Alternative)

Intersection #106 Red Hill Avenue and El Camino Real

Cycle (sec): 100 Critical Vol./Cap.(X): 0.624
 Loss Time (sec): 5 Average Delay (sec/veh): xxxxxx
 Optimal Cycle: 31 Level Of Service: B

Street Name:	Red Hill Avenue						El Camino Real					
Approach:	North Bound			South Bound			East Bound			West Bound		
Movement:	L	T	R	L	T	R	L	T	R	L	T	R
Control:	Protected			Protected			Protected			Protected		
Rights:	Include			Include			Include			Include		
Min. Green:	0	0	0	0	0	0	0	0	0	0	0	0
Y+R:	4.0	4.0	4.0	4.0	4.0	4.0	4.0	4.0	4.0	4.0	4.0	4.0
Lanes:	2	0	3	0	1	1	0	1	0	1	0	1

Volume Module:	Red Hill Avenue			South Bound			El Camino Real			West Bound		
Base Vol:	415	1315	242	20	728	96	70	153	201	199	329	38
Growth Adj:	1.00	1.00	1.00	1.00	1.00	1.00	1.00	1.00	1.00	1.00	1.00	1.00
Initial Bse:	415	1315	242	20	728	96	70	153	201	199	329	38
User Adj:	1.00	1.00	1.00	1.00	1.00	1.00	1.00	1.00	1.00	1.00	1.00	1.00
PHF Adj:	1.00	1.00	1.00	1.00	1.00	1.00	1.00	1.00	1.00	1.00	1.00	1.00
PHF Volume:	415	1315	242	20	728	96	70	153	201	199	329	38
Reduct Vol:	0	0	0	0	0	0	0	0	0	0	0	0
Reduced Vol:	415	1315	242	20	728	96	70	153	201	199	329	38
PCE Adj:	1.00	1.00	1.00	1.00	1.00	1.00	1.00	1.00	1.00	1.00	1.00	1.00
MLF Adj:	1.00	1.00	1.00	1.00	1.00	1.00	1.00	1.00	1.00	1.00	1.00	1.00
FinalVolume:	415	1315	242	20	728	96	70	153	201	199	329	38

Saturation Flow Module:	Red Hill Avenue			South Bound			El Camino Real			West Bound		
Sat/Lane:	1600	1600	1600	1600	1600	1600	1600	1600	1600	1600	1600	1600
Adjustment:	1.00	1.06	1.00	1.00	1.05	1.00	1.00	1.06	1.00	1.00	1.00	1.00
Lanes:	2.00	3.00	1.00	1.00	2.65	0.35	1.00	1.00	1.00	1.00	0.90	0.10
Final Sat.:	3200	5100	1600	1600	4441	559	1600	1700	1600	1600	1434	166

Capacity Analysis Module:	Red Hill Avenue			South Bound			El Camino Real			West Bound		
Vol/Sat:	0.13	0.26	0.15	0.01	0.16	0.17	0.04	0.09	0.13	0.12	0.23	0.23
Crit Moves:	****					****	****				****	

Santa Ana Circulation Element

Level Of Service Computation Report
 2000 HCM Operations Method (Base Volume Alternative)

 Intersection #107 Red Hill Avenue and I-5 NB Ramps

Cycle (sec): 100 Critical Vol./Cap.(X): 0.626
 Loss Time (sec): 5 Average Delay (sec/veh): 23.3
 Optimal Cycle: 32 Level Of Service: C

Street Name:	Red Hill Avenue						I-5 NB Ramps					
Approach:	North Bound			South Bound			East Bound			West Bound		
Movement:	L	T	R	L	T	R	L	T	R	L	T	R
Control:	Protected			Protected			Permitted			Permitted		
Rights:	Include			Include			Include			Include		
Min. Green:	0	0	0	0	0	0	0	0	0	0	0	0
Y+R:	4.0	4.0	4.0	4.0	4.0	4.0	4.0	4.0	4.0	4.0	4.0	4.0
Lanes:	1	0	3	0	0	3	0	0	0	1	1	0

Volume Module:												
Base Vol:	272	1557	0	0	939	190	0	0	0	256	96	415
Growth Adj:	1.00	1.00	1.00	1.00	1.00	1.00	1.00	1.00	1.00	1.00	1.00	1.00
Initial Bse:	272	1557	0	0	939	190	0	0	0	256	96	415
User Adj:	1.00	1.00	1.00	1.00	1.00	1.00	1.00	1.00	1.00	1.00	1.00	1.00
PHF Adj:	1.00	1.00	1.00	1.00	1.00	1.00	1.00	1.00	1.00	1.00	1.00	1.00
PHF Volume:	272	1557	0	0	939	190	0	0	0	256	96	415
Reduct Vol:	0	0	0	0	0	0	0	0	0	0	0	0
Reduced Vol:	272	1557	0	0	939	190	0	0	0	256	96	415
PCE Adj:	1.00	1.00	1.00	1.00	1.00	1.00	1.00	1.00	1.00	1.00	1.00	1.00
MLF Adj:	1.00	1.00	1.00	1.00	1.00	1.00	1.00	1.00	1.00	1.00	1.00	1.00
FinalVolume:	272	1557	0	0	939	190	0	0	0	256	96	415

Saturation Flow Module:												
Sat/Lane:	1900	1900	1900	1900	1900	1900	1900	1900	1900	1900	1900	1900
Adjustment:	0.95	0.91	1.00	1.00	0.91	0.85	1.00	1.00	1.00	0.83	0.83	0.83
Lanes:	1.00	3.00	0.00	0.00	3.00	1.00	0.00	0.00	0.00	1.45	0.55	1.00
Final Sat.:	1805	5187	0	0	5187	1615	0	0	0	2292	860	1576

Capacity Analysis Module:												
Vol/Sat:	0.15	0.30	0.00	0.00	0.18	0.12	0.00	0.00	0.00	0.11	0.11	0.26
Crit Moves:	****				****							****
Green/Cycle:	0.24	0.53	0.00	0.00	0.29	0.29	0.00	0.00	0.00	0.42	0.42	0.42
Volume/Cap:	0.63	0.57	0.00	0.00	0.63	0.41	0.00	0.00	0.00	0.27	0.27	0.63
Delay/Veh:	36.8	16.1	0.0	0.0	31.7	29.2	0.0	0.0	0.0	19.0	19.0	23.8
User DelAdj:	1.00	1.00	1.00	1.00	1.00	1.00	1.00	1.00	1.00	1.00	1.00	1.00

AdjDel/Veh:	36.8	16.1	0.0	0.0	31.7	29.2	0.0	0.0	0.0	19.0	19.0	23.8
LOS by Move:	D	B	A	A	C	C	A	A	A	B	B	C
HCM2k85thQ:	13	18	0	0	15	8	0	0	0	6	6	17

Note: Queue reported is the number of cars per lane.

Santa Ana Circulation Element

Level of Service Computation Report

2000 HCM Operations Method (Base Volume Alternative)

 Intersection #108 Red Hill Avenue and I-5 SB Ramps

Cycle (sec): 100 Critical Vol./Cap.(X): 0.708
 Loss Time (sec): 5 Average Delay (sec/veh): 22.8
 Optimal Cycle: 40 Level Of Service: C

Street Name:	Red Hill Avenue						I-5 SB Ramps					
	North Bound			South Bound			East Bound			West Bound		
Approach:	North Bound			South Bound			East Bound			West Bound		
Movement:	L	T	R	L	T	R	L	T	R	L	T	R
Control:	Protected			Protected			Permitted			Permitted		
Rights:	Include			Include			Include			Include		
Min. Green:	0	0	0	0	0	0	0	0	0	0	0	0
Y+R:	4.0	4.0	4.0	4.0	4.0	4.0	4.0	4.0	4.0	4.0	4.0	4.0
Lanes:	0	0	4	0	1	0	1	0	0	1	0	0

Volume Module:												
Base Vol:	0	1521	483	352	846	0	309	3	277	0	0	0
Growth Adj:	1.00	1.00	1.00	1.00	1.00	1.00	1.00	1.00	1.00	1.00	1.00	1.00
Initial Bse:	0	1521	483	352	846	0	309	3	277	0	0	0
User Adj:	1.00	1.00	1.00	1.00	1.00	1.00	1.00	1.00	1.00	1.00	1.00	1.00
PHF Adj:	1.00	1.00	1.00	1.00	1.00	1.00	1.00	1.00	1.00	1.00	1.00	1.00
PHF Volume:	0	1521	483	352	846	0	309	3	277	0	0	0
Reduct Vol:	0	0	0	0	0	0	0	0	0	0	0	0
Reduced Vol:	0	1521	483	352	846	0	309	3	277	0	0	0
PCE Adj:	1.00	1.00	1.00	1.00	1.00	1.00	1.00	1.00	1.00	1.00	1.00	1.00
MLF Adj:	1.00	1.00	1.00	1.00	1.00	1.00	1.00	1.00	1.00	1.00	1.00	1.00
FinalVolume:	0	1521	483	352	846	0	309	3	277	0	0	0

Saturation Flow Module:												
Sat/Lane:	1900	1900	1900	1900	1900	1900	1900	1900	1900	1900	1900	1900
Adjustment:	1.00	0.91	0.85	0.95	0.91	1.00	0.92	0.92	0.85	1.00	1.00	1.00
Lanes:	0.00	4.00	1.00	1.00	3.00	0.00	0.99	0.01	1.00	0.00	0.00	0.00
Final Sat.:	0	6916	1615	1805	5187	0	1733	17	1615	0	0	0

Capacity Analysis Module:												
Vol/Sat:	0.00	0.22	0.30	0.20	0.16	0.00	0.18	0.18	0.17	0.00	0.00	0.00
Crit Moves:	****			****			****			****		
Green/Cycle:	0.00	0.42	0.42	0.28	0.70	0.00	0.25	0.25	0.25	0.00	0.00	0.00
Volume/Cap:	0.00	0.52	0.71	0.71	0.23	0.00	0.71	0.71	0.68	0.00	0.00	0.00
Delay/Veh:	0.0	21.5	27.2	37.3	5.5	0.0	39.3	39.3	38.4	0.0	0.0	0.0
User DelAdj:	1.00	1.00	1.00	1.00	1.00	1.00	1.00	1.00	1.00	1.00	1.00	1.00
AdjDel/Veh:	0.0	21.5	27.2	37.3	5.5	0.0	39.3	39.3	38.4	0.0	0.0	0.0
LOS by Move:	A	C	C	D	A	A	D	D	D	A	A	A
HCM2k85thQ:	0	15	20	17	5	0	15	15	13	0	0	0

Note: Queue reported is the number of cars per lane.

Santa Ana Circulation Element

Level of Service Computation Report

ICU 1(Loss as Cycle Length %) Method (Base Volume Alternative)

Intersection #109 Red Hill Avenue and Nisson Road

Cycle (sec): 100 Critical Vol./Cap.(X): 0.702
 Loss Time (sec): 5 Average Delay (sec/veh): xxxxxx
 Optimal Cycle: 37 Level Of Service: C

Street Name:	Red Hill Avenue						Nisson Road					
	North Bound			South Bound			East Bound			West Bound		
Approach:	North Bound			South Bound			East Bound			West Bound		
Movement:	L	T	R	L	T	R	L	T	R	L	T	R
Control:	Protected			Protected			Split Phase			Split Phase		
Rights:	Include			Include			Include			Include		
Min. Green:	0	0	0	0	0	0	0	0	0	0	0	0
Y+R:	4.0	4.0	4.0	4.0	4.0	4.0	4.0	4.0	4.0	4.0	4.0	4.0
Lanes:	1	0	3	1	0	2	1	0	0	1	0	0

Volume Module:												
Base Vol:	30	1583	32	168	865	87	247	90	40	48	83	141
Growth Adj:	1.00	1.00	1.00	1.00	1.00	1.00	1.00	1.00	1.00	1.00	1.00	1.00
Initial Bse:	30	1583	32	168	865	87	247	90	40	48	83	141
User Adj:	1.00	1.00	1.00	1.00	1.00	1.00	1.00	1.00	1.00	1.00	1.00	1.00
PHF Adj:	1.00	1.00	1.00	1.00	1.00	1.00	1.00	1.00	1.00	1.00	1.00	1.00
PHF Volume:	30	1583	32	168	865	87	247	90	40	48	83	141
Reduct Vol:	0	0	0	0	0	0	0	0	0	0	0	0
Reduced Vol:	30	1583	32	168	865	87	247	90	40	48	83	141
PCE Adj:	1.00	1.00	1.00	1.00	1.00	1.00	1.00	1.00	1.00	1.00	1.00	1.00
MLF Adj:	1.00	1.00	1.00	1.00	1.00	1.00	1.00	1.00	1.00	1.00	1.00	1.00
FinalVolume:	30	1583	32	168	865	87	247	90	40	48	83	141

Saturation Flow Module:												
Sat/Lane:	1600	1600	1600	1600	1600	1600	1600	1600	1600	1600	1600	1600
Adjustment:	1.00	1.05	1.00	1.00	1.05	1.00	1.00	1.00	1.00	1.00	1.00	1.00
Lanes:	1.00	3.92	0.08	1.00	2.73	0.27	1.00	0.69	0.31	1.00	0.37	0.63
Final Sat.:	1600	6573	127	1600	4561	439	1600	1108	492	1600	593	1007

Capacity Analysis Module:												
Vol/Sat:	0.02	0.24	0.25	0.11	0.19	0.20	0.15	0.08	0.08	0.03	0.14	0.14
Crit Moves:			****	****			****			****		

Santa Ana Circulation Element

Level Of Service Computation Report

ICU 1(Loss as Cycle Length %) Method (Base Volume Alternative)

Intersection #110 Red Hill Avenue and Walnut Avenue

Cycle (sec): 100 Critical Vol./Cap.(X): 0.785
 Loss Time (sec): 5 Average Delay (sec/veh): xxxxxx
 Optimal Cycle: 49 Level Of Service: C

Street Name:	Red Hill Avenue						Walnut Avenue					
Approach:	North Bound			South Bound			East Bound			West Bound		
Movement:	L	T	R	L	T	R	L	T	R	L	T	R
Control:	Protected			Protected			Protected			Protected		
Rights:	Include			Include			Include			Include		
Min. Green:	0	0	0	0	0	0	0	0	0	0	0	0
Y+R:	4.0	4.0	4.0	4.0	4.0	4.0	4.0	4.0	4.0	4.0	4.0	4.0
Lanes:	1	0	2	1	0	2	1	0	1	1	0	1

Volume Module:

Base Vol:	287	1395	100	136	422	176	112	269	111	205	682	178
Growth Adj:	1.00	1.00	1.00	1.00	1.00	1.00	1.00	1.00	1.00	1.00	1.00	1.00
Initial Bse:	287	1395	100	136	422	176	112	269	111	205	682	178
User Adj:	1.00	1.00	1.00	1.00	1.00	1.00	1.00	1.00	1.00	1.00	1.00	1.00
PHF Adj:	1.00	1.00	1.00	1.00	1.00	1.00	1.00	1.00	1.00	1.00	1.00	1.00
PHF Volume:	287	1395	100	136	422	176	112	269	111	205	682	178
Reduct Vol:	0	0	0	0	0	0	0	0	0	0	0	0
Reduced Vol:	287	1395	100	136	422	176	112	269	111	205	682	178
PCE Adj:	1.00	1.00	1.00	1.00	1.00	1.00	1.00	1.00	1.00	1.00	1.00	1.00
MLF Adj:	1.00	1.00	1.00	1.00	1.00	1.00	1.00	1.00	1.00	1.00	1.00	1.00
FinalVolume:	287	1395	100	136	422	176	112	269	111	205	682	178

Saturation Flow Module:

Sat/Lane:	1600	1600	1600	1600	1600	1600	1600	1600	1600	1600	1600	1600
Adjustment:	1.00	1.04	1.00	1.00	1.06	1.00	1.00	1.04	1.00	1.00	1.04	1.00
Lanes:	1.00	2.80	0.20	1.00	2.12	0.88	1.00	1.42	0.58	2.00	1.59	0.41
Final Sat.:	1600	4679	321	1600	3587	1413	1600	2365	935	3200	2638	662

Capacity Analysis Module:

Vol/Sat:	0.18	0.30	0.31	0.09	0.12	0.12	0.07	0.11	0.12	0.06	0.26	0.27
Crit Moves:			****	****			****					****

Santa Ana Circulation Element

Level Of Service Computation Report

ICU 1(Loss as Cycle Length %) Method (Base Volume Alternative)

Intersection #111 Red Hill Avenue and Valencia Avenue

Cycle (sec): 100 Critical Vol./Cap.(X): 0.549
 Loss Time (sec): 5 Average Delay (sec/veh): xxxxxx
 Optimal Cycle: 26 Level Of Service: A

Street Name:	Red Hill Avenue						Valencia Avenue					
Approach:	North Bound			South Bound			East Bound			West Bound		
Movement:	L	T	R	L	T	R	L	T	R	L	T	R
Control:	Protected			Protected			Protected			Protected		
Rights:	Ovl			Include			Include			Ovl		
Min. Green:	0	0	0	0	0	0	0	0	0	0	0	0
Y+R:	4.0	4.0	4.0	4.0	4.0	4.0	4.0	4.0	4.0	4.0	4.0	4.0
Lanes:	1	0	3	1	0	2	1	0	1	2	0	1

Volume Module:												
Base Vol:	220	1637	270	109	438	49	70	189	83	118	171	113
Growth Adj:	1.00	1.00	1.00	1.00	1.00	1.00	1.00	1.00	1.00	1.00	1.00	1.00
Initial Bse:	220	1637	270	109	438	49	70	189	83	118	171	113
User Adj:	1.00	1.00	1.00	1.00	1.00	1.00	1.00	1.00	1.00	1.00	1.00	1.00
PHF Adj:	1.00	1.00	1.00	1.00	1.00	1.00	1.00	1.00	1.00	1.00	1.00	1.00
PHF Volume:	220	1637	270	109	438	49	70	189	83	118	171	113
Reduct Vol:	0	0	0	0	0	0	0	0	0	0	0	0
Reduced Vol:	220	1637	270	109	438	49	70	189	83	118	171	113
PCE Adj:	1.00	1.00	1.00	1.00	1.00	1.00	1.00	1.00	1.00	1.00	1.00	1.00
MLF Adj:	1.00	1.00	1.00	1.00	1.00	1.00	1.00	1.00	1.00	1.00	1.00	1.00
FinalVolume:	220	1637	270	109	438	49	70	189	83	118	171	113
OvlAdjVol:												4

Saturation Flow Module:												
Sat/Lane:	1600	1600	1600	1600	1600	1600	1600	1600	1600	1600	1600	1600
Adjustment:	1.00	1.05	1.00	1.00	1.05	1.00	1.00	1.06	1.00	1.00	1.06	1.00
Lanes:	1.00	3.43	0.57	1.00	2.70	0.30	1.00	1.00	1.00	2.00	1.00	1.00
Final Sat.:	1600	5794	906	1600	4517	483	1600	1700	1600	3200	1700	1600

Capacity Analysis Module:												
Vol/Sat:	0.14	0.28	0.30	0.07	0.10	0.10	0.04	0.11	0.05	0.04	0.10	0.07
OvlAdjV/S:												0.00
Crit Moves:	****			****			****			****		

Santa Ana Circulation Element

Level of Service Computation Report

ICU 1(Loss as Cycle Length %) Method (Base Volume Alternative)

Intersection #112 Tustin Ranch Road and Warner Avenue North

Cycle (sec): 100 Critical Vol./Cap.(X): 0.757

Loss Time (sec): 5 Average Delay (sec/veh): xxxxxx

Optimal Cycle: 44 Level Of Service: C

Street Name:	Tustin Ranch Road						Warner Avenue North					
Approach:	North Bound			South Bound			East Bound			West Bound		
Movement:	L	T	R	L	T	R	L	T	R	L	T	R
Control:	Protected			Protected			Split Phase			Split Phase		
Rights:	Ovl			Include			Include			Ovl		
Min. Green:	0	0	0	0	0	0	0	0	0	0	0	0
Y+R:	4.0	4.0	4.0	4.0	4.0	4.0	4.0	4.0	4.0	4.0	4.0	4.0
Lanes:	0	0	3	0	1		2	0	3	0	0	2

Volume Module:	Tustin Ranch Road			Tustin Ranch Road			Warner Avenue North			Warner Avenue North		
Base Vol:	0	1623	956	351	516	0	0	0	0	479	0	433
Growth Adj:	1.00	1.00	1.00	1.00	1.00	1.00	1.00	1.00	1.00	1.00	1.00	1.00
Initial Bse:	0	1623	956	351	516	0	0	0	0	479	0	433
User Adj:	1.00	1.00	1.00	1.00	1.00	1.00	1.00	1.00	1.00	1.00	1.00	1.00
PHF Adj:	1.00	1.00	1.00	1.00	1.00	1.00	1.00	1.00	1.00	1.00	1.00	1.00
PHF Volume:	0	1623	956	351	516	0	0	0	0	479	0	433
Reduct Vol:	0	0	0	0	0	0	0	0	0	0	0	0
Reduced Vol:	0	1623	956	351	516	0	0	0	0	479	0	433
PCE Adj:	1.00	1.00	1.00	1.00	1.00	1.00	1.00	1.00	1.00	1.00	1.00	1.00
MLF Adj:	1.00	1.00	1.00	1.00	1.00	1.00	1.00	1.00	1.00	1.00	1.00	1.00
FinalVolume:	0	1623	956	351	516	0	0	0	0	479	0	433
OvlAdjVol:	796									82		

Saturation Flow Module:	Tustin Ranch Road			Tustin Ranch Road			Warner Avenue North			Warner Avenue North		
Sat/Lane:	1600	1600	1600	1600	1600	1600	1600	1600	1600	1600	1600	1600
Adjustment:	1.00	1.06	1.00	1.00	1.06	1.00	1.00	1.06	1.00	1.00	1.06	1.00
Lanes:	0.00	3.00	1.00	2.00	3.00	0.00	0.00	0.00	0.00	3.00	0.00	2.00
Final Sat.:	0	5100	1600	3200	5100	0	0	0	0	4800	0	3200

Capacity Analysis Module:	Tustin Ranch Road			Tustin Ranch Road			Warner Avenue North			Warner Avenue North		
Vol/Sat:	0.00	0.32	0.60	0.11	0.10	0.00	0.00	0.00	0.00	0.10	0.00	0.14
OvlAdjV/S:	0.50									0.03		
Crit Moves:	****			****						****		

Santa Ana Circulation Element

Level Of Service Computation Report

ICU 1(Loss as Cycle Length %) Method (Base Volume Alternative)

Intersection #113 Tustin Ranch Road and Walnut Avenue

Cycle (sec): 100 Critical Vol./Cap.(X): 1.630
 Loss Time (sec): 5 Average Delay (sec/veh): xxxxxx
 Optimal Cycle: 180 Level Of Service: F

Street Name:	Tustin Ranch Road						Walnut Avenue					
Approach:	North Bound			South Bound			East Bound			West Bound		
Movement:	L	T	R	L	T	R	L	T	R	L	T	R
Control:	Protected			Protected			Protected			Protected		
Rights:	Ovl			Ovl			Include			Ovl		
Min. Green:	0	0	0	0	0	0	0	0	0	0	0	0
Y+R:	4.0	4.0	4.0	4.0	4.0	4.0	4.0	4.0	4.0	4.0	4.0	4.0
Lanes:	2	0	3	0	1		2	0	3	0	1	

Volume Module:	Tustin Ranch Road			Tustin Ranch Road			Walnut Avenue			Walnut Avenue		
Base Vol:	762	3319	349	454	1206	782	365	447	255	287	1646	1304
Growth Adj:	1.00	1.00	1.00	1.00	1.00	1.00	1.00	1.00	1.00	1.00	1.00	1.00
Initial Bse:	762	3319	349	454	1206	782	365	447	255	287	1646	1304
User Adj:	1.00	1.00	1.00	1.00	1.00	1.00	1.00	1.00	1.00	1.00	1.00	1.00
PHF Adj:	1.00	1.00	1.00	1.00	1.00	1.00	1.00	1.00	1.00	1.00	1.00	1.00
PHF Volume:	762	3319	349	454	1206	782	365	447	255	287	1646	1304
Reduct Vol:	0	0	0	0	0	0	0	0	0	0	0	0
Reduced Vol:	762	3319	349	454	1206	782	365	447	255	287	1646	1304
PCE Adj:	1.00	1.00	1.00	1.00	1.00	1.00	1.00	1.00	1.00	1.00	1.00	1.00
MLF Adj:	1.00	1.00	1.00	1.00	1.00	1.00	1.00	1.00	1.00	1.00	1.00	1.00
FinalVolume:	762	3319	349	454	1206	782	365	447	255	287	1646	1304
OvlAdjVol:	206			600						1077		

Saturation Flow Module:	Tustin Ranch Road			Tustin Ranch Road			Walnut Avenue			Walnut Avenue		
Sat/Lane:	1600	1600	1600	1600	1600	1600	1600	1600	1600	1600	1600	1600
Adjustment:	1.00	1.06	1.00	1.00	1.06	1.00	1.00	1.05	1.00	1.00	1.06	1.00
Lanes:	2.00	3.00	1.00	2.00	3.00	1.00	2.00	1.27	0.73	2.00	2.00	1.00
Final Sat.:	3200	5100	1600	3200	5100	1600	3200	2138	1162	3200	3400	1600

Capacity Analysis Module:	Tustin Ranch Road			Tustin Ranch Road			Walnut Avenue			Walnut Avenue		
Vol/Sat:	0.24	0.65	0.22	0.14	0.24	0.49	0.11	0.21	0.22	0.09	0.48	0.82
OvlAdjV/S:	0.13			0.37						0.67		
Crit Moves:	****			****			****			****		

Santa Ana Circulation Element

Level Of Service Computation Report

2000 HCM Operations Method (Base Volume Alternative)

Intersection #114 SR-55 SB Ramps and Irvine Boulevard

Cycle (sec): 100 Critical Vol./Cap.(X): 0.794
 Loss Time (sec): 5 Average Delay (sec/veh): 21.5
 Optimal Cycle: 53 Level Of Service: C

Street Name:	SR-55 SB Ramps						Irvine Boulevard					
Approach:	North Bound			South Bound			East Bound			West Bound		
Movement:	L	T	R	L	T	R	L	T	R	L	T	R
Control:	Protected			Permitted			Protected			Protected		
Rights:	Include			Include			Include			Include		
Min. Green:	0	0	0	0	0	0	0	0	0	0	0	0
Y+R:	4.0	4.0	4.0	4.0	4.0	4.0	4.0	4.0	4.0	4.0	4.0	4.0
Lanes:	0	0	0	1	0	1	0	0	2	1	0	3

Volume Module:	SR-55 SB Ramps			SR-55 SB Ramps			Irvine Boulevard			Irvine Boulevard		
Base Vol:	0	0	0	434	0	259	0	862	581	372	1069	0
Growth Adj:	1.00	1.00	1.00	1.00	1.00	1.00	1.00	1.00	1.00	1.00	1.00	1.00
Initial Bse:	0	0	0	434	0	259	0	862	581	372	1069	0
User Adj:	1.00	1.00	1.00	1.00	1.00	1.00	1.00	1.00	1.00	1.00	1.00	1.00
PHF Adj:	1.00	1.00	1.00	1.00	1.00	1.00	1.00	1.00	1.00	1.00	1.00	1.00
PHF Volume:	0	0	0	434	0	259	0	862	581	372	1069	0
Reduct Vol:	0	0	0	0	0	0	0	0	0	0	0	0
Reduced Vol:	0	0	0	434	0	259	0	862	581	372	1069	0
PCE Adj:	1.00	1.00	1.00	1.00	1.00	1.00	1.00	1.00	1.00	1.00	1.00	1.00
MLF Adj:	1.00	1.00	1.00	1.00	1.00	1.00	1.00	1.00	1.00	1.00	1.00	1.00
FinalVolume:	0	0	0	434	0	259	0	862	581	372	1069	0

Saturation Flow Module:	SR-55 SB Ramps			SR-55 SB Ramps			Irvine Boulevard			Irvine Boulevard		
Sat/Lane:	1900	1900	1900	1900	1900	1900	1900	1900	1900	1900	1900	1900
Adjustment:	1.00	1.00	1.00	0.74	1.00	0.73	1.00	0.86	0.86	0.95	0.91	1.00
Lanes:	0.00	0.00	0.00	1.62	0.00	1.38	0.00	2.00	1.00	1.00	3.00	0.00
Final Sat.:	0	0	0	2276	0	1912	0	3251	1625	1805	5187	0

Capacity Analysis Module:	SR-55 SB Ramps			SR-55 SB Ramps			Irvine Boulevard			Irvine Boulevard		
Vol/Sat:	0.00	0.00	0.00	0.19	0.00	0.14	0.00	0.27	0.36	0.21	0.21	0.00
Crit Moves:				****					****	****		
Green/Cycle:	0.00	0.00	0.00	0.24	0.00	0.48	0.00	0.45	0.45	0.26	0.71	0.00
Volume/Cap:	0.00	0.00	0.00	0.79	0.00	0.28	0.00	0.59	0.79	0.79	0.29	0.00
Delay/Veh:	0.0	0.0	0.0	40.8	0.0	15.7	0.0	20.9	26.0	43.6	5.3	0.0
User DelAdj:	1.00	1.00	1.00	1.00	1.00	1.00	1.00	1.00	1.00	1.00	1.00	1.00
AdjDel/Veh:	0.0	0.0	0.0	40.8	0.0	15.7	0.0	20.9	26.0	43.6	5.3	0.0
LOS by Move:	A	A	A	D	A	B	A	C	C	D	A	A

```
HCM2k85thQ:    0    0    0   15    0    6    0   17   27   19    7    0
*****
Note: Queue reported is the number of cars per lane.
*****
```

Santa Ana Circulation Element

Level of Service Computation Report

2000 HCM Operations Method (Base Volume Alternative)

 Intersection #115 SR-55 NB Ramps and Irvine Boulevard

Cycle (sec): 100 Critical Vol./Cap.(X): 0.809
 Loss Time (sec): 5 Average Delay (sec/veh): 19.5
 Optimal Cycle: 56 Level Of Service: B

Street Name:	SR-55 NB Ramps						Irvine Boulevard					
Approach:	North Bound			South Bound			East Bound			West Bound		
Movement:	L	T	R	L	T	R	L	T	R	L	T	R
Control:	Permitted			Protected			Protected			Protected		
Rights:	Include			Include			Include			Include		
Min. Green:	0	0	0	0	0	0	0	0	0	0	0	0
Y+R:	4.0	4.0	4.0	4.0	4.0	4.0	4.0	4.0	4.0	4.0	4.0	4.0
Lanes:	1	0	1	0	0	0	1	0	3	0	0	2

Volume Module:

Base Vol:	328	16	298	0	0	0	229	1048	0	0	1132	716
Growth Adj:	1.00	1.00	1.00	1.00	1.00	1.00	1.00	1.00	1.00	1.00	1.00	1.00
Initial Bse:	328	16	298	0	0	0	229	1048	0	0	1132	716
User Adj:	1.00	1.00	1.00	1.00	1.00	1.00	1.00	1.00	1.00	1.00	1.00	1.00
PHF Adj:	1.00	1.00	1.00	1.00	1.00	1.00	1.00	1.00	1.00	1.00	1.00	1.00
PHF Volume:	328	16	298	0	0	0	229	1048	0	0	1132	716
Reduct Vol:	0	0	0	0	0	0	0	0	0	0	0	0
Reduced Vol:	328	16	298	0	0	0	229	1048	0	0	1132	716
PCE Adj:	1.00	1.00	1.00	1.00	1.00	1.00	1.00	1.00	1.00	1.00	1.00	1.00
MLF Adj:	1.00	1.00	1.00	1.00	1.00	1.00	1.00	1.00	1.00	1.00	1.00	1.00
FinalVolume:	328	16	298	0	0	0	229	1048	0	0	1132	716

Saturation Flow Module:

Sat/Lane:	1900	1900	1900	1900	1900	1900	1900	1900	1900	1900	1900	1900
Adjustment:	0.86	0.86	0.86	1.00	1.00	1.00	0.95	0.91	1.00	1.00	0.86	0.86
Lanes:	1.50	0.05	1.45	0.00	0.00	0.00	1.00	3.00	0.00	0.00	2.00	1.00
Final Sat.:	2444	79	2370	0	0	0	1805	5187	0	0	3257	1629

Capacity Analysis Module:

Vol/Sat:	0.13	0.20	0.13	0.00	0.00	0.00	0.13	0.20	0.00	0.00	0.35	0.44
Crit Moves:	****						****			****		
Green/Cycle:	0.25	0.25	0.25	0.00	0.00	0.00	0.16	0.70	0.00	0.00	0.54	0.54
Volume/Cap:	0.54	0.81	0.50	0.00	0.00	0.00	0.81	0.29	0.00	0.00	0.64	0.81
Delay/Veh:	33.0	41.5	32.5	0.0	0.0	0.0	56.5	5.7	0.0	0.0	16.4	20.8
User DelAdj:	1.00	1.00	1.00	1.00	1.00	1.00	1.00	1.00	1.00	1.00	1.00	1.00
AdjDel/Veh:	33.0	41.5	32.5	0.0	0.0	0.0	56.5	5.7	0.0	0.0	16.4	20.8
LOS by Move:	C	D	C	A	A	A	E	A	A	A	B	C
HCM2k85thQ:	10	18	9	0	0	0	14	7	0	0	21	31

Note: Queue reported is the number of cars per lane.

Traffix 8.0.0715 (c) 2008 Dowling Assoc. Licensed to IBI GROUP, IRVINE, CA

APPENDIX D.3
ANALYSIS WORKSHEETS –
2045 NP (AM Peak Hour)

Santa Ana Circulation Element

Scenario Report

Scenario: 2045 NP AM Peak Hour

Command: Default Command

Volume: 2045 NP AM

Geometry: MPAH

Impact Fee: Default Impact Fee

Trip Generation: Default Trip Generation

Trip Distribution: Default Trip Distribution

Paths: Default Path

Routes: Default Route

Configuration: Default Configuration

 Santa Ana Circulation Element

 Impact Analysis Report
 Level Of Service

Intersection	Base		Future		Change in
	Del/	V/	Del/	V/	
	LOS	Veh C	LOS	Veh C	
# 1 Euclid St and 1st St	D	xxxxxx 0.858	D	xxxxxx 0.858	+ 0.000 V/C
# 2 Euclid St and McFadden Ave	E	xxxxxx 0.975	E	xxxxxx 0.975	+ 0.000 V/C
# 3 Euclid St and Edinger Ave	E	xxxxxx 0.991	E	xxxxxx 0.991	+ 0.000 V/C
# 4 Newhope St and Hazard Ave	C	xxxxxx 0.777	C	xxxxxx 0.777	+ 0.000 V/C
# 5 Newhope St and McFadden Ave	D	xxxxxx 0.827	D	xxxxxx 0.827	+ 0.000 V/C
# 6 Harbor Blvd and SR-22 WB Off-R	C	28.4 0.738	C	28.4 0.738	+ 0.000 D/V
# 7 Trask Avenue and SR-22 EB On-R	B	12.0 0.516	B	12.0 0.516	+ 0.000 D/V
# 8 Harbor Blvd and Westminster Av	E	xxxxxx 0.985	E	xxxxxx 0.985	+ 0.000 V/C
# 9 Harbor Blvd and 1st St	C	xxxxxx 0.789	C	xxxxxx 0.789	+ 0.000 V/C
# 10 Harbor Blvd and McFadden Ave	C	xxxxxx 0.788	C	xxxxxx 0.788	+ 0.000 V/C
# 11 Harbor Blvd and Edinger Ave	D	xxxxxx 0.836	D	xxxxxx 0.836	+ 0.000 V/C
# 12 Harbor Blvd and Warner Ave	C	xxxxxx 0.789	C	xxxxxx 0.789	+ 0.000 V/C
# 13 Harbor Blvd and Segerstrom Ave	E	xxxxxx 0.965	E	xxxxxx 0.965	+ 0.000 V/C
# 14 MacArthur Blvd and Hyland Ave	B	xxxxxx 0.611	B	xxxxxx 0.611	+ 0.000 V/C
# 15 MacArthur Blvd and Harbor Blvd	C	xxxxxx 0.736	C	xxxxxx 0.736	+ 0.000 V/C
# 16 Harbor Blvd and Sunflower Ave	C	xxxxxx 0.704	C	xxxxxx 0.704	+ 0.000 V/C
# 17 Harbor Blvd and I-405 NB Off-R	B	18.0 0.569	B	18.0 0.569	+ 0.000 D/V
# 18 Harbor Blvd and I-405 SB Off-R	B	15.0 0.612	B	15.0 0.612	+ 0.000 D/V
# 19 Fairview St and Civic Center D	C	xxxxxx 0.741	C	xxxxxx 0.741	+ 0.000 V/C
# 20 Fairview St and 1st St	D	xxxxxx 0.859	D	xxxxxx 0.859	+ 0.000 V/C
# 21 Fairview St and McFadden Ave	C	xxxxxx 0.799	C	xxxxxx 0.799	+ 0.000 V/C
# 22 Fairview St and Edinger Ave	D	xxxxxx 0.861	D	xxxxxx 0.861	+ 0.000 V/C
# 23 Fairview St and Warner Ave	D	xxxxxx 0.816	D	xxxxxx 0.816	+ 0.000 V/C
# 24 Fairview St and MacArthur Blvd	B	xxxxxx 0.684	B	xxxxxx 0.684	+ 0.000 V/C

 Santa Ana Circulation Element

Intersection	Base		Future		Change in
	Del/ LOS	V/ Veh	Del/ LOS	V/ Veh	
# 25 Fairview Rd and Sunflower Ave	B	xxxxxx 0.697	B	xxxxxx 0.697	+ 0.000 V/C
# 26 Greenville St and Edinger Ave	C	xxxxxx 0.774	C	xxxxxx 0.774	+ 0.000 V/C
# 27 Greenville St and Segerstrom A	D	xxxxxx 0.843	D	xxxxxx 0.843	+ 0.000 V/C
# 28 Raitt St and McFadden Ave	C	xxxxxx 0.778	C	xxxxxx 0.778	+ 0.000 V/C
# 29 Raitt St and Edinger Ave	E	xxxxxx 0.990	E	xxxxxx 0.990	+ 0.000 V/C
# 30 Bear St and MacArthur Blvd	C	xxxxxx 0.707	C	xxxxxx 0.707	+ 0.000 V/C
# 31 Bristol St and 17th St	D	xxxxxx 0.869	D	xxxxxx 0.869	+ 0.000 V/C
# 32 Bristol St and Civic Center Dr	E	xxxxxx 0.942	E	xxxxxx 0.942	+ 0.000 V/C
# 33 Bristol St and Santa Ana Blvd	D	xxxxxx 0.806	D	xxxxxx 0.806	+ 0.000 V/C
# 34 Bristol St and 1st St	C	xxxxxx 0.767	C	xxxxxx 0.767	+ 0.000 V/C
# 35 Bristol St and McFadden Ave	E	xxxxxx 0.956	E	xxxxxx 0.956	+ 0.000 V/C
# 36 Bristol St and Warner Ave	E	xxxxxx 0.915	E	xxxxxx 0.915	+ 0.000 V/C
# 37 Bristol St and Segerstrom Ave	D	xxxxxx 0.811	D	xxxxxx 0.811	+ 0.000 V/C
# 38 Bristol St and Alton Ave	A	xxxxxx 0.545	A	xxxxxx 0.545	+ 0.000 V/C
# 39 Bristol St and MacArthur Blvd	B	xxxxxx 0.697	B	xxxxxx 0.697	+ 0.000 V/C
# 40 Bristol St and Sunflower Ave	B	xxxxxx 0.649	B	xxxxxx 0.649	+ 0.000 V/C
# 41 Bristol St and I-405 NB Ramps	C	20.8 0.557	C	20.8 0.557	+ 0.000 D/V
# 42 Bristol St and I-405 SB Ramps	C	23.9 0.696	C	23.9 0.696	+ 0.000 D/V
# 43 Flower St and Santa Ana Blvd	D	xxxxxx 0.806	D	xxxxxx 0.806	+ 0.000 V/C
# 44 Flower St and 1st St	E	xxxxxx 0.926	E	xxxxxx 0.926	+ 0.000 V/C
# 45 Flower St and McFadden Ave	E	xxxxxx 0.900	E	xxxxxx 0.900	+ 0.000 V/C
# 46 Flower St and Segerstrom Ave	C	xxxxxx 0.784	C	xxxxxx 0.784	+ 0.000 V/C
# 47 Flower St and MacArthur Blvd	B	xxxxxx 0.675	B	xxxxxx 0.675	+ 0.000 V/C
# 48 Main St and La Veta Ave	A	xxxxxx 0.586	A	xxxxxx 0.586	+ 0.000 V/C
# 49 Main St and Mainplace Dr / Mem	A	xxxxxx 0.512	A	xxxxxx 0.512	+ 0.000 V/C
# 50 Main St and 17th St	D	xxxxxx 0.884	D	xxxxxx 0.884	+ 0.000 V/C

Traffix 8.0.0715 (c) 2008 Dowling Assoc. Licensed to IBI GROUP, IRVINE, CA

 Santa Ana Circulation Element

Intersection	Base		Future		Change in
	Del/ LOS	V/ Veh C	Del/ LOS	V/ Veh C	
# 51 Main St and Civic Center Dr	C	xxxxxx 0.783	C	xxxxxx 0.783	+ 0.000 V/C
# 52 Main St and Santa Ana Blvd	E	xxxxxx 0.926	E	xxxxxx 0.926	+ 0.000 V/C
# 53 Main St and 4th St	A	xxxxxx 0.410	A	xxxxxx 0.410	+ 0.000 V/C
# 54 Main St and 1st St	B	xxxxxx 0.681	B	xxxxxx 0.681	+ 0.000 V/C
# 55 Main St and McFadden Ave	D	xxxxxx 0.894	D	xxxxxx 0.894	+ 0.000 V/C
# 56 Main St and Edinger Ave	C	xxxxxx 0.795	C	xxxxxx 0.795	+ 0.000 V/C
# 57 Main St and MacArthur Blvd	B	xxxxxx 0.680	B	xxxxxx 0.680	+ 0.000 V/C
# 58 Penn Wy and 17th St	B	12.2 0.660	B	12.2 0.660	+ 0.000 D/V
# 59 I-5 NB Off Ramps/17th Street	C	30.0 0.710	C	30.0 0.710	+ 0.000 D/V
# 60 Penn Wy and I-5 SB Ramps	C	21.2 0.550	C	21.2 0.550	+ 0.000 D/V
# 61 Santiago St and Civic Center D	F	159.2 1.769	F	159.2 1.769	+ 0.000 V/C
# 62 Santiago St and Santa Ana Blvd	F	xxxxxx 1.037	F	xxxxxx 1.037	+ 0.000 V/C
# 63 Standard Ave and 4th St	E	xxxxxx 0.939	E	xxxxxx 0.939	+ 0.000 V/C
# 64 Standard Ave and 1st St	E	xxxxxx 0.976	E	xxxxxx 0.976	+ 0.000 V/C
# 65 Standard Ave and Mcfadden Ave	D	xxxxxx 0.854	D	xxxxxx 0.854	+ 0.000 V/C
# 66 Halladay St and Warner Ave	C	xxxxxx 0.775	C	xxxxxx 0.775	+ 0.000 V/C
# 67 Halladay St and Dyer Rd	C	xxxxxx 0.774	C	xxxxxx 0.774	+ 0.000 V/C
# 68 SR-55 SB Ramps and MacArthur B	B	19.9 0.608	B	19.9 0.608	+ 0.000 D/V
# 69 SR-55 NB Ramps and MacArthur B	B	19.3 0.712	B	19.3 0.712	+ 0.000 D/V
# 70 SR-55 SB Ramps and Dyer Rd	C	25.7 0.617	C	25.7 0.617	+ 0.000 D/V
# 71 Glassell St and La Veta Ave	D	xxxxxx 0.800	D	xxxxxx 0.800	+ 0.000 V/C
# 72 Glassell St and SR-22 WB Ramps	C	32.6 0.871	C	32.6 0.871	+ 0.000 D/V
# 73 Grand Ave / Glassell St and SR	C	30.6 0.860	C	30.6 0.860	+ 0.000 D/V
# 74 Grand Ave and Fairhaven Ave	B	xxxxxx 0.611	B	xxxxxx 0.611	+ 0.000 V/C
# 75 Grand Ave and Santa Clara Ave	D	xxxxxx 0.843	D	xxxxxx 0.843	+ 0.000 V/C

 Santa Ana Circulation Element

Intersection	Base		Future		Change in
	Del/ LOS	V/ Veh C	Del/ LOS	V/ Veh C	
# 76 Grand Ave and 17th St	C	xxxxxx 0.794	C	xxxxxx 0.794	+ 0.000 V/C
# 77 Grand Ave and I-5 NB Ramps	B	13.2 0.740	B	13.2 0.740	+ 0.000 D/V
# 78 Grand Ave and Santa Ana Blvd	C	26.0 0.832	C	26.0 0.832	+ 0.000 D/V
# 79 Grand Ave and 1st St	C	xxxxxx 0.742	C	xxxxxx 0.742	+ 0.000 V/C
# 80 Grand Ave and Chestnut Ave	C	xxxxxx 0.704	C	xxxxxx 0.704	+ 0.000 V/C
# 81 Grand Ave and McFadden Ave	D	xxxxxx 0.892	D	xxxxxx 0.892	+ 0.000 V/C
# 82 Grand Ave and Edinger Ave	D	xxxxxx 0.838	D	xxxxxx 0.838	+ 0.000 V/C
# 83 Grand Ave and Warner Ave	B	xxxxxx 0.613	B	xxxxxx 0.613	+ 0.000 V/C
# 84 SR-55 NB Ramps and Dyer Rd	B	17.1 0.569	B	17.1 0.569	+ 0.000 D/V
# 85 Cambridge St and La Veta Ave	D	31.6 0.971	D	31.6 0.971	+ 0.000 V/C
# 86 Cambridge St and Fairhaven Ave	A	xxxxxx 0.563	A	xxxxxx 0.563	+ 0.000 V/C
# 87 Mabury St and 1st Street	C	27.4 0.714	C	27.4 0.714	+ 0.000 D/V
# 88 Tustin St and La Veta Ave	A	xxxxxx 0.446	A	xxxxxx 0.446	+ 0.000 V/C
# 89 Tustin St and SR-22 WB On-Ramp	B	12.2 0.635	B	12.2 0.635	+ 0.000 D/V
# 90 Tustin St and SR-22 EB Off-Ram	C	25.0 0.723	C	25.0 0.723	+ 0.000 D/V
# 91 Tustin Ave and Fairhaven Ave	F	xxxxxx 1.195	F	xxxxxx 1.195	+ 0.000 V/C
# 92 Tustin Ave and Santa Clara Ave	F	xxxxxx 1.037	F	xxxxxx 1.037	+ 0.000 V/C
# 93 Tustin Ave and 17th St	E	xxxxxx 0.911	E	xxxxxx 0.911	+ 0.000 V/C
# 94 Tustin Ave and 4th St	D	xxxxxx 0.830	D	xxxxxx 0.830	+ 0.000 V/C
# 95 SR-55 SB Ramps / Auto Mall Dr	C	25.2 0.672	C	25.2 0.672	+ 0.000 D/V
# 96 SR-55 NB Ramps / Del Amo Ave a	C	25.4 0.673	C	25.4 0.673	+ 0.000 D/V
# 97 Red Hill Ave and Edinger Ave	B	xxxxxx 0.610	B	xxxxxx 0.610	+ 0.000 V/C
# 98 Red Hill Ave and Warner Ave	A	xxxxxx 0.560	A	xxxxxx 0.560	+ 0.000 V/C
# 99 Red Hill Ave and Dyer Rd / bar	A	xxxxxx 0.548	A	xxxxxx 0.548	+ 0.000 V/C
#100 Red Hill Ave and Alton Pkwy	D	xxxxxx 0.855	D	xxxxxx 0.855	+ 0.000 V/C
#101 Red Hill Ave and MacArthur Blv	B	xxxxxx 0.686	B	xxxxxx 0.686	+ 0.000 V/C

Traffix 8.0.0715 (c) 2008 Dowling Assoc. Licensed to IBI GROUP, IRVINE, CA

 Santa Ana Circulation Element

Intersection	Base		Future		Change in
	Del/ LOS	V/ Veh C	Del/ LOS	V/ Veh C	
#102 Red Hill Ave and Main St	C	xxxxxx 0.722	C	xxxxxx 0.722	+ 0.000 V/C
#103 I-5 SB Ramps and Santa Ana Blv	B	17.4 0.559	B	17.4 0.559	+ 0.000 D/V
#104 Tustin Ranch Rd and Warner Ave	A	xxxxxx 0.520	A	xxxxxx 0.520	+ 0.000 V/C
#105 Von Karman Ave and Barranca Pk	E	xxxxxx 0.929	E	xxxxxx 0.929	+ 0.000 V/C
#106 Red Hill Avenue and El Camino	B	xxxxxx 0.650	B	xxxxxx 0.650	+ 0.000 V/C
#107 Red Hill Avenue and I-5 NB Ram	C	20.8 0.627	C	20.8 0.627	+ 0.000 D/V
#108 Red Hill Avenue and I-5 SB Ram	C	23.7 0.799	C	23.7 0.799	+ 0.000 D/V
#109 Red Hill Avenue and Nisson Roa	B	xxxxxx 0.651	B	xxxxxx 0.651	+ 0.000 V/C
#110 Red Hill Avenue and Walnut Ave	B	xxxxxx 0.636	B	xxxxxx 0.636	+ 0.000 V/C
#111 Red Hill Avenue and Valencia A	B	xxxxxx 0.652	B	xxxxxx 0.652	+ 0.000 V/C
#112 Tustin Ranch Road and Warner A	A	xxxxxx 0.449	A	xxxxxx 0.449	+ 0.000 V/C
#113 Tustin Ranch Road and Walnut A	F	xxxxxx 1.273	F	xxxxxx 1.273	+ 0.000 V/C
#114 SR-55 SB Ramps and Irvine Boul	D	41.0 1.099	D	41.0 1.099	+ 0.000 D/V
#115 SR-55 NB Ramps and Irvine Boul	C	23.5 0.906	C	23.5 0.906	+ 0.000 D/V

Santa Ana Circulation Element

Level Of Service Computation Report

ICU 1(Loss as Cycle Length %) Method (Base Volume Alternative)

Intersection #1 Euclid St and 1st St

Cycle (sec): 100 Critical Vol./Cap.(X): 0.858
Loss Time (sec): 5 Average Delay (sec/veh): xxxxxx
Optimal Cycle: 68 Level Of Service: D

Table with 4 columns: North Bound, South Bound, East Bound, West Bound. Rows include Movement (L-T-R), Control (Protected), Rights (Include), Min. Green, Y+R, and Lanes.

Volume Module table with 12 columns representing different traffic volumes and adjustment factors like Growth Adj, User Adj, PHF Adj, etc.

Saturation Flow Module table with 12 columns showing saturation flow rates and adjustment factors for different lanes.

Capacity Analysis Module table with 12 columns showing volume-to-saturation ratios and critical moves.

Santa Ana Circulation Element

Level Of Service Computation Report

ICU 1(Loss as Cycle Length %) Method (Base Volume Alternative)

Intersection #2 Euclid St and McFadden Ave

Cycle (sec): 100 Critical Vol./Cap.(X): 0.975
 Loss Time (sec): 5 Average Delay (sec/veh): xxxxxx
 Optimal Cycle: 172 Level Of Service: E

Approach:	North Bound			South Bound			East Bound			West Bound		
Movement:	L	T	R	L	T	R	L	T	R	L	T	R
Control:	Protected			Protected			Prot+Permit			Prot+Permit		
Rights:	WideBypass			Include			Include			Include		
Min. Green:	0	0	0	0	0	0	0	0	0	0	0	0
Y+R:	4.0	4.0	4.0	4.0	4.0	4.0	4.0	4.0	4.0	4.0	4.0	4.0
Lanes:	1	0	2	1	0	2	1	0	1	1	0	1

Volume Module:

Base Vol:	162	1227	146	148	2062	171	255	521	323	151	335	127
Growth Adj:	1.00	1.00	1.00	1.00	1.00	1.00	1.00	1.00	1.00	1.00	1.00	1.00
Initial Bse:	162	1227	146	148	2062	171	255	521	323	151	335	127
User Adj:	1.00	1.00	1.00	1.00	1.00	1.00	1.00	1.00	1.00	1.00	1.00	1.00
PHF Adj:	1.00	1.00	1.00	1.00	1.00	1.00	1.00	1.00	1.00	1.00	1.00	1.00
PHF Volume:	162	1227	146	148	2062	171	255	521	323	151	335	127
Reduct Vol:	0	0	0	0	0	0	0	0	0	0	0	0
Reduced Vol:	162	1227	146	148	2062	171	255	521	323	151	335	127
PCE Adj:	1.00	1.00	1.00	1.00	1.00	1.00	1.00	1.00	1.00	1.00	1.00	1.00
MLF Adj:	1.00	1.00	1.00	1.00	1.00	1.00	1.00	1.00	1.00	1.00	1.00	1.00
FinalVolume:	162	1227	146	148	2062	171	255	521	323	151	335	127

Saturation Flow Module:

Sat/Lane:	1600	1600	1600	1600	1600	1600	1600	1600	1600	1600	1600	1600
Adjustment:	1.00	1.05	1.00	1.00	1.05	1.00	1.00	1.05	1.00	1.00	1.04	1.00
Lanes:	1.00	2.68	0.32	1.00	2.77	0.23	1.00	1.23	0.77	1.00	1.45	0.55
Final Sat.:	1600	4490	510	1600	4632	368	1600	2075	1225	1600	2420	880

Capacity Analysis Module:

Vol/Sat:	0.10	0.27	0.29	0.09	0.45	0.47	0.16	0.25	0.26	0.09	0.14	0.14
Crit Moves:	****					****			****	****		

Santa Ana Circulation Element

Level Of Service Computation Report

ICU 1(Loss as Cycle Length %) Method (Base Volume Alternative)

Intersection #3 Euclid St and Edinger Ave

Cycle (sec): 100 Critical Vol./Cap.(X): 0.991
Loss Time (sec): 5 Average Delay (sec/veh): xxxxxx
Optimal Cycle: 180 Level Of Service: E

Table with 4 columns: North Bound, South Bound, East Bound, West Bound. Rows include Movement, Control, Rights, Min. Green, Y+R, and Lanes.

Volume Module: Table with 12 columns representing different volume categories and their values.

Saturation Flow Module: Table with 12 columns representing saturation flow values.

Capacity Analysis Module: Table with 12 columns representing capacity analysis values.

Santa Ana Circulation Element

Level Of Service Computation Report

ICU 1(Loss as Cycle Length %) Method (Base Volume Alternative)

Intersection #4 Newhope St and Hazard Ave

Cycle (sec): 100 Critical Vol./Cap.(X): 0.777
 Loss Time (sec): 5 Average Delay (sec/veh): xxxxxx
 Optimal Cycle: 48 Level Of Service: C

Approach:	North Bound			South Bound			East Bound			West Bound		
Movement:	L	T	R	L	T	R	L	T	R	L	T	R
Control:	Prot+Permit			Prot+Permit			Permitted			Permitted		
Rights:	Include			Include			Include			Include		
Min. Green:	0	0	0	0	0	0	0	0	0	0	0	0
Y+R:	4.0	4.0	4.0	4.0	4.0	4.0	4.0	4.0	4.0	4.0	4.0	4.0
Lanes:	1	0	1	1	0	1	1	0	1	1	0	1

Volume Module:

Base Vol:	78	590	84	88	1302	119	108	276	204	119	397	159
Growth Adj:	1.00	1.00	1.00	1.00	1.00	1.00	1.00	1.00	1.00	1.00	1.00	1.00
Initial Bse:	78	590	84	88	1302	119	108	276	204	119	397	159
User Adj:	1.00	1.00	1.00	1.00	1.00	1.00	1.00	1.00	1.00	1.00	1.00	1.00
PHF Adj:	1.00	1.00	1.00	1.00	1.00	1.00	1.00	1.00	1.00	1.00	1.00	1.00
PHF Volume:	78	590	84	88	1302	119	108	276	204	119	397	159
Reduct Vol:	0	0	0	0	0	0	0	0	0	0	0	0
Reduced Vol:	78	590	84	88	1302	119	108	276	204	119	397	159
PCE Adj:	1.00	1.00	1.00	1.00	1.00	1.00	1.00	1.00	1.00	1.00	1.00	1.00
MLF Adj:	1.00	1.00	1.00	1.00	1.00	1.00	1.00	1.00	1.00	1.00	1.00	1.00
FinalVolume:	78	590	84	88	1302	119	108	276	204	119	397	159

Saturation Flow Module:

Sat/Lane:	1600	1600	1600	1600	1600	1600	1600	1600	1600	1600	1600	1600
Adjustment:	1.00	1.04	1.00	1.00	1.03	1.00	1.00	1.05	1.00	1.00	1.04	1.00
Lanes:	1.00	1.75	0.25	1.00	1.83	0.17	1.00	1.15	0.85	1.00	1.43	0.57
Final Sat.:	1600	2901	399	1600	3032	268	1600	1940	1360	1600	2385	915

Capacity Analysis Module:

Vol/Sat:	0.05	0.20	0.21	0.06	0.43	0.44	0.07	0.14	0.15	0.07	0.17	0.17
Crit Moves:	****					****	****				****	

Santa Ana Circulation Element

Level Of Service Computation Report

ICU 1(Loss as Cycle Length %) Method (Base Volume Alternative)

Intersection #5 Newhope St and McFadden Ave

Cycle (sec): 100 Critical Vol./Cap.(X): 0.827
 Loss Time (sec): 5 Average Delay (sec/veh): xxxxxx
 Optimal Cycle: 58 Level Of Service: D

Approach:	North Bound			South Bound			East Bound			West Bound		
Movement:	L	T	R	L	T	R	L	T	R	L	T	R
Control:	Protected			Protected			Prot+Permit			Prot+Permit		
Rights:	Include			Include			Include			Include		
Min. Green:	0	0	0	0	0	0	0	0	0	0	0	0
Y+R:	4.0	4.0	4.0	4.0	4.0	4.0	4.0	4.0	4.0	4.0	4.0	4.0
Lanes:	1	0	1	1	0	1	1	0	1	1	0	1

Volume Module:

Base Vol:	77	342	120	122	1213	113	135	492	160	190	484	108
Growth Adj:	1.00	1.00	1.00	1.00	1.00	1.00	1.00	1.00	1.00	1.00	1.00	1.00
Initial Bse:	77	342	120	122	1213	113	135	492	160	190	484	108
User Adj:	1.00	1.00	1.00	1.00	1.00	1.00	1.00	1.00	1.00	1.00	1.00	1.00
PHF Adj:	1.00	1.00	1.00	1.00	1.00	1.00	1.00	1.00	1.00	1.00	1.00	1.00
PHF Volume:	77	342	120	122	1213	113	135	492	160	190	484	108
Reduct Vol:	0	0	0	0	0	0	0	0	0	0	0	0
Reduced Vol:	77	342	120	122	1213	113	135	492	160	190	484	108
PCE Adj:	1.00	1.00	1.00	1.00	1.00	1.00	1.00	1.00	1.00	1.00	1.00	1.00
MLF Adj:	1.00	1.00	1.00	1.00	1.00	1.00	1.00	1.00	1.00	1.00	1.00	1.00
FinalVolume:	77	342	120	122	1213	113	135	492	160	190	484	108

Saturation Flow Module:

Sat/Lane:	1600	1600	1600	1600	1600	1600	1600	1600	1600	1600	1600	1600
Adjustment:	1.00	1.04	1.00	1.00	1.03	1.00	1.00	1.04	1.00	1.00	1.04	1.00
Lanes:	1.00	1.48	0.52	1.00	1.83	0.17	1.00	1.51	0.49	1.00	1.64	0.36
Final Sat.:	1600	2469	831	1600	3027	273	1600	2515	785	1600	2716	584

Capacity Analysis Module:

Vol/Sat:	0.05	0.14	0.14	0.08	0.40	0.41	0.08	0.20	0.20	0.12	0.18	0.19
Crit Moves:	****					****		****		****		

Santa Ana Circulation Element

Level Of Service Computation Report
 2000 HCM Operations Method (Base Volume Alternative)

 Intersection #6 Harbor Blvd and SR-22 WB Off-Ramp / Banner Dr

Cycle (sec): 100 Critical Vol./Cap.(X): 0.738
 Loss Time (sec): 5 Average Delay (sec/veh): 28.4
 Optimal Cycle: 43 Level Of Service: C

Approach:	North Bound			South Bound			East Bound			West Bound		
Movement:	L	T	R	L	T	R	L	T	R	L	T	R
Control:	Protected			Protected			Split Phase			Split Phase		
Rights:	Include			Include			Include			Include		
Min. Green:	0	0	0	0	0	0	0	0	0	0	0	0
Y+R:	4.0	4.0	4.0	4.0	4.0	4.0	4.0	4.0	4.0	4.0	4.0	4.0
Lanes:	1	0	3	0	0	2	1	0	0	1	1	0

Volume Module:

Base Vol:	84	1534	0	0	1465	19	81	0	133	836	44	117
Growth Adj:	1.00	1.00	1.00	1.00	1.00	1.00	1.00	1.00	1.00	1.00	1.00	1.00
Initial Bse:	84	1534	0	0	1465	19	81	0	133	836	44	117
User Adj:	1.00	1.00	1.00	1.00	1.00	1.00	1.00	1.00	1.00	1.00	1.00	1.00
PHF Adj:	1.00	1.00	1.00	1.00	1.00	1.00	1.00	1.00	1.00	1.00	1.00	1.00
PHF Volume:	84	1534	0	0	1465	19	81	0	133	836	44	117
Reduct Vol:	0	0	0	0	0	0	0	0	0	0	0	0
Reduced Vol:	84	1534	0	0	1465	19	81	0	133	836	44	117
PCE Adj:	1.00	1.00	1.00	1.00	1.00	1.00	1.00	1.00	1.00	1.00	1.00	1.00
MLF Adj:	1.00	1.00	1.00	1.00	1.00	1.00	1.00	1.00	1.00	1.00	1.00	1.00
FinalVolume:	84	1534	0	0	1465	19	81	0	133	836	44	117

Saturation Flow Module:

Sat/Lane:	1900	1900	1900	1900	1900	1900	1900	1900	1900	1900	1900	1900
Adjustment:	0.95	0.91	1.00	1.00	0.91	0.91	0.90	1.00	0.90	0.96	0.96	0.85
Lanes:	1.00	3.00	0.00	0.00	2.96	0.04	0.38	0.00	0.62	1.90	0.10	1.00
Final Sat.:	1805	5187	0	0	5110	66	646	0	1061	3448	181	1615

Capacity Analysis Module:

Vol/Sat:	0.05	0.30	0.00	0.00	0.29	0.29	0.13	0.00	0.13	0.24	0.24	0.07
Crit Moves:	****			****			****			****		
Green/Cycle:	0.06	0.45	0.00	0.00	0.39	0.39	0.17	0.00	0.17	0.33	0.33	0.33
Volume/Cap:	0.74	0.65	0.00	0.00	0.74	0.74	0.74	0.00	0.74	0.74	0.74	0.22
Delay/Veh:	68.3	22.0	0.0	0.0	27.7	27.7	49.0	0.0	49.0	32.2	32.2	24.5
User DelAdj:	1.00	1.00	1.00	1.00	1.00	1.00	1.00	1.00	1.00	1.00	1.00	1.00
AdjDel/Veh:	68.3	22.0	0.0	0.0	27.7	27.7	49.0	0.0	49.0	32.2	32.2	24.5
LOS by Move:	E	C	A	A	C	C	D	A	D	C	C	C
HCM2k85thQ:	7	21	0	0	23	23	12	0	12	20	20	4

 Note: Queue reported is the number of cars per lane.

Santa Ana Circulation Element

Level Of Service Computation Report
 2000 HCM Operations Method (Base Volume Alternative)

 Intersection #7 Trask Avenue and SR-22 EB On-Ramp

Cycle (sec): 100 Critical Vol./Cap.(X): 0.516
 Loss Time (sec): 5 Average Delay (sec/veh): 12.0
 Optimal Cycle: 26 Level Of Service: B

Approach:	North Bound			South Bound			East Bound			West Bound		
Movement:	L	T	R	L	T	R	L	T	R	L	T	R
Control:	Protected			Protected			Protected			Protected		
Rights:	Include			Include			Include			Include		
Min. Green:	0	0	0	0	0	0	0	0	0	0	0	0
Y+R:	4.0	4.0	4.0	4.0	4.0	4.0	4.0	4.0	4.0	4.0	4.0	4.0
Lanes:	0	0	0	0	0	0	2	0	1	0	0	1

Volume Module:	North Bound			South Bound			East Bound			West Bound		
Base Vol:	0	0	0	0	0	0	713	893	0	0	852	159
Growth Adj:	1.00	1.00	1.00	1.00	1.00	1.00	1.00	1.00	1.00	1.00	1.00	1.00
Initial Bse:	0	0	0	0	0	0	713	893	0	0	852	159
User Adj:	1.00	1.00	1.00	1.00	1.00	1.00	1.00	1.00	1.00	1.00	1.00	1.00
PHF Adj:	1.00	1.00	1.00	1.00	1.00	1.00	1.00	1.00	1.00	1.00	1.00	1.00
PHF Volume:	0	0	0	0	0	0	713	893	0	0	852	159
Reduct Vol:	0	0	0	0	0	0	0	0	0	0	0	0
Reduced Vol:	0	0	0	0	0	0	713	893	0	0	852	159
PCE Adj:	1.00	1.00	1.00	1.00	1.00	1.00	1.00	1.00	1.00	1.00	1.00	1.00
MLF Adj:	1.00	1.00	1.00	1.00	1.00	1.00	1.00	1.00	1.00	1.00	1.00	1.00
FinalVolume:	0	0	0	0	0	0	713	893	0	0	852	159

Saturation Flow Module:	North Bound			South Bound			East Bound			West Bound		
Sat/Lane:	1900	1900	1900	1900	1900	1900	1900	1900	1900	1900	1900	1900
Adjustment:	1.00	1.00	1.00	1.00	1.00	1.00	0.92	1.00	1.00	1.00	0.93	0.93
Lanes:	0.00	0.00	0.00	0.00	0.00	0.00	2.00	1.00	0.00	0.00	1.69	0.31
Final Sat.:	0	0	0	0	0	0	3502	1900	0	0	2969	554

Capacity Analysis Module:	North Bound			South Bound			East Bound			West Bound		
Vol/Sat:	0.00	0.00	0.00	0.00	0.00	0.00	0.20	0.47	0.00	0.00	0.29	0.29
Crit Moves:							****				****	
Green/Cycle:	0.00	0.00	0.00	0.00	0.00	0.00	0.39	0.95	0.00	0.00	0.56	0.56
Volume/Cap:	0.00	0.00	0.00	0.00	0.00	0.00	0.52	0.49	0.00	0.00	0.52	0.52
Delay/Veh:	0.0	0.0	0.0	0.0	0.0	0.0	23.4	0.5	0.0	0.0	14.1	14.1
User DelAdj:	1.00	1.00	1.00	1.00	1.00	1.00	1.00	1.00	1.00	1.00	1.00	1.00
AdjDel/Veh:	0.0	0.0	0.0	0.0	0.0	0.0	23.4	0.5	0.0	0.0	14.1	14.1
LOS by Move:	A	A	A	A	A	A	C	A	A	A	B	B
HCM2k85thQ:	0	0	0	0	0	0	13	5	0	0	16	16

 Note: Queue reported is the number of cars per lane.

Santa Ana Circulation Element

Level Of Service Computation Report

ICU 1(Loss as Cycle Length %) Method (Base Volume Alternative)

Intersection #8 Harbor Blvd and Westminster Ave

Cycle (sec):	100	Critical Vol./Cap.(X):	0.985
Loss Time (sec):	0	Average Delay (sec/veh):	xxxxxx
Optimal Cycle:	180	Level Of Service:	E

Approach:	North Bound			South Bound			East Bound			West Bound					
Movement:	L	T	R	L	T	R	L	T	R	L	T	R			
Control:	Protected			Protected			Protected			Protected					
Rights:	WideBypass			Include			Include			Include					
Min. Green:	0	0	0	0	0	0	0	0	0	0	0	0			
Y+R:	4.0	4.0	4.0	4.0	4.0	4.0	4.0	4.0	4.0	4.0	4.0	4.0			
Lanes:	1	0	3	0	1	1	0	3	0	1	0	2	1	0	3

Volume Module:

Base Vol:	178	1173	251	258	2021	115	192	1010	36	415	1124	306
Growth Adj:	1.00	1.00	1.00	1.00	1.00	1.00	1.00	1.00	1.00	1.00	1.00	1.00
Initial Bse:	178	1173	251	258	2021	115	192	1010	36	415	1124	306
User Adj:	1.00	1.00	1.00	1.00	1.00	1.00	1.00	1.00	1.00	1.00	1.00	1.00
PHF Adj:	1.00	1.00	1.00	1.00	1.00	1.00	1.00	1.00	1.00	1.00	1.00	1.00
PHF Volume:	178	1173	251	258	2021	115	192	1010	36	415	1124	306
Reduct Vol:	0	0	0	0	0	0	0	0	0	0	0	0
Reduced Vol:	178	1173	251	258	2021	115	192	1010	36	415	1124	306
PCE Adj:	1.00	1.00	1.00	1.00	1.00	1.00	1.00	1.00	1.00	1.00	1.00	1.00
MLF Adj:	1.00	1.00	1.00	1.00	1.00	1.00	1.00	1.00	1.00	1.00	1.00	1.00
FinalVolume:	178	1173	251	258	2021	115	192	1010	36	415	1124	306

Saturation Flow Module:

Sat/Lane:	1600	1600	1600	1600	1600	1600	1600	1600	1600	1600	1600	1600
Adjustment:	1.00	1.06	1.00	1.00	1.06	1.00	1.00	1.04	1.00	1.00	1.06	1.00
Lanes:	1.00	3.00	1.00	1.00	3.00	1.00	1.00	2.90	0.10	1.00	3.00	1.00
Final Sat.:	1600	5100	1600	1600	5100	1600	1600	4835	165	1600	5100	1600

Capacity Analysis Module:

Vol/Sat:	0.11	0.23	0.16	0.16	0.40	0.07	0.12	0.21	0.22	0.26	0.22	0.19
Crit Moves:	****				****				****	****		

Santa Ana Circulation Element

Level Of Service Computation Report

ICU 1(Loss as Cycle Length %) Method (Base Volume Alternative)

Intersection #9 Harbor Blvd and 1st St

Cycle (sec): 100 Critical Vol./Cap.(X): 0.789
Loss Time (sec): 5 Average Delay (sec/veh): xxxxxx
Optimal Cycle: 50 Level Of Service: C

Table with 4 columns: North Bound, South Bound, East Bound, West Bound. Rows include Movement (L-T-R), Control (Protected), Rights (Include), Min. Green, Y+R, and Lanes.

Volume Module: Table with 12 columns representing different volume categories and their values.

Saturation Flow Module: Table with 12 columns representing saturation flow values for various lanes.

Capacity Analysis Module: Table with 12 columns representing capacity analysis values.

Santa Ana Circulation Element

Level Of Service Computation Report

ICU 1(Loss as Cycle Length %) Method (Base Volume Alternative)

Intersection #10 Harbor Blvd and McFadden Ave

Cycle (sec): 100 Critical Vol./Cap.(X): 0.788
 Loss Time (sec): 5 Average Delay (sec/veh): xxxxxx
 Optimal Cycle: 50 Level Of Service: C

Approach:	North Bound			South Bound			East Bound			West Bound		
Movement:	L	T	R	L	T	R	L	T	R	L	T	R
Control:	Protected			Protected			Protected			Protected		
Rights:	Include			Include			Include			Include		
Min. Green:	0	0	0	0	0	0	0	0	0	0	0	0
Y+R:	4.0	4.0	4.0	4.0	4.0	4.0	4.0	4.0	4.0	4.0	4.0	4.0
Lanes:	2	0	3	0	1	0	2	0	2	1	0	1

Volume Module:

Base Vol:	104	1059	101	190	2004	67	177	462	138	138	311	89
Growth Adj:	1.00	1.00	1.00	1.00	1.00	1.00	1.00	1.00	1.00	1.00	1.00	1.00
Initial Bse:	104	1059	101	190	2004	67	177	462	138	138	311	89
User Adj:	1.00	1.00	1.00	1.00	1.00	1.00	1.00	1.00	1.00	1.00	1.00	1.00
PHF Adj:	1.00	1.00	1.00	1.00	1.00	1.00	1.00	1.00	1.00	1.00	1.00	1.00
PHF Volume:	104	1059	101	190	2004	67	177	462	138	138	311	89
Reduct Vol:	0	0	0	0	0	0	0	0	0	0	0	0
Reduced Vol:	104	1059	101	190	2004	67	177	462	138	138	311	89
PCE Adj:	1.00	1.00	1.00	1.00	1.00	1.00	1.00	1.00	1.00	1.00	1.00	1.00
MLF Adj:	1.00	1.00	1.00	1.00	1.00	1.00	1.00	1.00	1.00	1.00	1.00	1.00
FinalVolume:	104	1059	101	190	2004	67	177	462	138	138	311	89

Saturation Flow Module:

Sat/Lane:	1600	1600	1600	1600	1600	1600	1600	1600	1600	1600	1600	1600
Adjustment:	1.00	1.06	1.00	1.00	1.04	1.00	1.00	1.04	1.00	1.00	1.04	1.00
Lanes:	2.00	3.00	1.00	2.00	2.90	0.10	1.00	1.54	0.46	1.00	1.56	0.44
Final Sat.:	3200	5100	1600	3200	4845	155	1600	2564	736	1600	2588	712

Capacity Analysis Module:

Vol/Sat:	0.03	0.21	0.06	0.06	0.41	0.43	0.11	0.18	0.19	0.09	0.12	0.13
Crit Moves:	****					****			****	****		

Santa Ana Circulation Element

Level Of Service Computation Report

ICU 1(Loss as Cycle Length %) Method (Base Volume Alternative)

Intersection #11 Harbor Blvd and Edinger Ave

Cycle (sec): 100 Critical Vol./Cap.(X): 0.836
 Loss Time (sec): 5 Average Delay (sec/veh): xxxxxx
 Optimal Cycle: 61 Level Of Service: D

Approach:	North Bound			South Bound			East Bound			West Bound		
Movement:	L	T	R	L	T	R	L	T	R	L	T	R
Control:	Protected			Protected			Protected			Protected		
Rights:	Include			Include			Include			Include		
Min. Green:	0	0	0	0	0	0	0	0	0	0	0	0
Y+R:	4.0	4.0	4.0	4.0	4.0	4.0	4.0	4.0	4.0	4.0	4.0	4.0
Lanes:	2	0	3	0	1		2	0	3	0	1	

Volume Module:

Base Vol:	103	772	146	204	2349	68	123	743	373	191	424	176
Growth Adj:	1.00	1.00	1.00	1.00	1.00	1.00	1.00	1.00	1.00	1.00	1.00	1.00
Initial Bse:	103	772	146	204	2349	68	123	743	373	191	424	176
User Adj:	1.00	1.00	1.00	1.00	1.00	1.00	1.00	1.00	1.00	1.00	1.00	1.00
PHF Adj:	1.00	1.00	1.00	1.00	1.00	1.00	1.00	1.00	1.00	1.00	1.00	1.00
PHF Volume:	103	772	146	204	2349	68	123	743	373	191	424	176
Reduct Vol:	0	0	0	0	0	0	0	0	0	0	0	0
Reduced Vol:	103	772	146	204	2349	68	123	743	373	191	424	176
PCE Adj:	1.00	1.00	1.00	1.00	1.00	1.00	1.00	1.00	1.00	1.00	1.00	1.00
MLF Adj:	1.00	1.00	1.00	1.00	1.00	1.00	1.00	1.00	1.00	1.00	1.00	1.00
FinalVolume:	103	772	146	204	2349	68	123	743	373	191	424	176

Saturation Flow Module:

Sat/Lane:	1600	1600	1600	1600	1600	1600	1600	1600	1600	1600	1600	1600
Adjustment:	1.00	1.06	1.00	1.00	1.06	1.00	1.00	1.06	1.00	1.00	1.06	1.00
Lanes:	2.00	3.00	1.00	2.00	3.00	1.00	2.00	2.00	1.00	2.00	3.00	1.00
Final Sat.:	3200	5100	1600	3200	5100	1600	3200	3400	1600	3200	5100	1600

Capacity Analysis Module:

Vol/Sat:	0.03	0.15	0.09	0.06	0.46	0.04	0.04	0.22	0.23	0.06	0.08	0.11
Crit Moves:	****			****					****	****		

Santa Ana Circulation Element

Level Of Service Computation Report

ICU 1(Loss as Cycle Length %) Method (Base Volume Alternative)

Intersection #12 Harbor Blvd and Warner Ave

Cycle (sec): 100 Critical Vol./Cap.(X): 0.789
 Loss Time (sec): 5 Average Delay (sec/veh): xxxxxx
 Optimal Cycle: 50 Level Of Service: C

Approach:	North Bound			South Bound			East Bound			West Bound		
Movement:	L	T	R	L	T	R	L	T	R	L	T	R
Control:	Protected			Protected			Protected			Protected		
Rights:	Include			Include			Include			Include		
Min. Green:	0	0	0	0	0	0	0	0	0	0	0	0
Y+R:	4.0	4.0	4.0	4.0	4.0	4.0	4.0	4.0	4.0	4.0	4.0	4.0
Lanes:	2	0	2	1	0	0	2	0	3	0	1	0

Volume Module:

Base Vol:	109	665	169	429	1933	116	101	1440	379	138	723	122
Growth Adj:	1.00	1.00	1.00	1.00	1.00	1.00	1.00	1.00	1.00	1.00	1.00	1.00
Initial Bse:	109	665	169	429	1933	116	101	1440	379	138	723	122
User Adj:	1.00	1.00	1.00	1.00	1.00	1.00	1.00	1.00	1.00	1.00	1.00	1.00
PHF Adj:	1.00	1.00	1.00	1.00	1.00	1.00	1.00	1.00	1.00	1.00	1.00	1.00
PHF Volume:	109	665	169	429	1933	116	101	1440	379	138	723	122
Reduct Vol:	0	0	0	0	0	0	0	0	0	0	0	0
Reduced Vol:	109	665	169	429	1933	116	101	1440	379	138	723	122
PCE Adj:	1.00	1.00	1.00	1.00	1.00	1.00	1.00	1.00	1.00	1.00	1.00	1.00
MLF Adj:	1.00	1.00	1.00	1.00	1.00	1.00	1.00	1.00	1.00	1.00	1.00	1.00
FinalVolume:	109	665	169	429	1933	116	101	1440	379	138	723	122

Saturation Flow Module:

Sat/Lane:	1600	1600	1600	1600	1600	1600	1600	1600	1600	1600	1600	1600
Adjustment:	1.00	1.05	1.00	1.00	1.06	1.00	1.00	1.06	1.00	1.00	1.06	1.00
Lanes:	2.00	2.39	0.61	2.00	3.00	1.00	2.00	3.00	1.00	2.00	3.00	1.00
Final Sat.:	3200	4027	973	3200	5100	1600	3200	5100	1600	3200	5100	1600

Capacity Analysis Module:

Vol/Sat:	0.03	0.17	0.17	0.13	0.38	0.07	0.03	0.28	0.24	0.04	0.14	0.08
Crit Moves:	****			****			****			****		

Santa Ana Circulation Element

Level Of Service Computation Report

ICU 1(Loss as Cycle Length %) Method (Base Volume Alternative)

Intersection #13 Harbor Blvd and Segerstrom Ave

Cycle (sec): 100 Critical Vol./Cap.(X): 0.965
 Loss Time (sec): 5 Average Delay (sec/veh): xxxxxx
 Optimal Cycle: 152 Level Of Service: E

Approach:	North Bound			South Bound			East Bound			West Bound		
Movement:	L	T	R	L	T	R	L	T	R	L	T	R
Control:	Protected			Protected			Prot+Permit			Prot+Permit		
Rights:	Include			Include			Include			Include		
Min. Green:	0	0	0	0	0	0	0	0	0	0	0	0
Y+R:	4.0	4.0	4.0	4.0	4.0	4.0	4.0	4.0	4.0	4.0	4.0	4.0
Lanes:	2	0	2	1	0	2	1	0	1	1	0	2

Volume Module:

Base Vol:	107	759	48	169	2274	85	82	689	278	140	434	98
Growth Adj:	1.00	1.00	1.00	1.00	1.00	1.00	1.00	1.00	1.00	1.00	1.00	1.00
Initial Bse:	107	759	48	169	2274	85	82	689	278	140	434	98
User Adj:	1.00	1.00	1.00	1.00	1.00	1.00	1.00	1.00	1.00	1.00	1.00	1.00
PHF Adj:	1.00	1.00	1.00	1.00	1.00	1.00	1.00	1.00	1.00	1.00	1.00	1.00
PHF Volume:	107	759	48	169	2274	85	82	689	278	140	434	98
Reduct Vol:	0	0	0	0	0	0	0	0	0	0	0	0
Reduced Vol:	107	759	48	169	2274	85	82	689	278	140	434	98
PCE Adj:	1.00	1.00	1.00	1.00	1.00	1.00	1.00	1.00	1.00	1.00	1.00	1.00
MLF Adj:	1.00	1.00	1.00	1.00	1.00	1.00	1.00	1.00	1.00	1.00	1.00	1.00
FinalVolume:	107	759	48	169	2274	85	82	689	278	140	434	98

Saturation Flow Module:

Sat/Lane:	1600	1600	1600	1600	1600	1600	1600	1600	1600	1600	1600	1600
Adjustment:	1.00	1.04	1.00	1.00	1.04	1.00	1.00	1.04	1.00	1.00	1.06	1.00
Lanes:	2.00	2.82	0.18	1.00	2.89	0.11	1.00	1.43	0.57	1.00	2.00	1.00
Final Sat.:	3200	4714	286	1600	4827	173	1600	2380	920	1600	3400	1600

Capacity Analysis Module:

Vol/Sat:	0.03	0.16	0.17	0.11	0.47	0.49	0.05	0.29	0.30	0.09	0.13	0.06
Crit Moves:	****					****			****	****		

Santa Ana Circulation Element

Level Of Service Computation Report

ICU 1(Loss as Cycle Length %) Method (Base Volume Alternative)

Intersection #14 MacArthur Blvd and Hyland Ave

Cycle (sec): 100 Critical Vol./Cap.(X): 0.611
Loss Time (sec): 5 Average Delay (sec/veh): xxxxxx
Optimal Cycle: 30 Level Of Service: B

Table with 4 columns: North Bound, South Bound, East Bound, West Bound. Rows include Movement (L-T-R), Control, Rights, Min. Green, Y+R, and Lanes.

Volume Module: Table with 12 columns representing different movement and lane volumes. Rows include Base Vol, Growth Adj, Initial Bse, User Adj, PHF Adj, PHF Volume, Reduct Vol, Reduced Vol, PCE Adj, MLF Adj, and Final Volume.

Saturation Flow Module: Table with 12 columns representing saturation flow rates. Rows include Sat/Lane, Adjustment, Lanes, and Final Sat.

Capacity Analysis Module: Table with 12 columns representing capacity analysis metrics. Rows include Vol/Sat and Crit Moves.

Santa Ana Circulation Element

Level Of Service Computation Report

ICU 1(Loss as Cycle Length %) Method (Base Volume Alternative)

Intersection #15 MacArthur Blvd and Harbor Blvd

Cycle (sec): 100 Critical Vol./Cap.(X): 0.736
Loss Time (sec): 5 Average Delay (sec/veh): xxxxxx
Optimal Cycle: 41 Level Of Service: C

Table with 4 columns: North Bound, South Bound, East Bound, West Bound. Rows include Movement (L-T-R), Control, Rights, Min. Green, Y+R, and Lanes.

Volume Module: Table with 12 columns representing different volume categories and their values.

Saturation Flow Module: Table with 12 columns representing saturation flow values.

Capacity Analysis Module: Table with 12 columns representing capacity analysis values.

Santa Ana Circulation Element

Level Of Service Computation Report

ICU 1(Loss as Cycle Length %) Method (Base Volume Alternative)

Intersection #16 Harbor Blvd and Sunflower Ave

Cycle (sec): 100 Critical Vol./Cap.(X): 0.704
 Loss Time (sec): 5 Average Delay (sec/veh): xxxxxx
 Optimal Cycle: 38 Level Of Service: C

Approach:	North Bound			South Bound			East Bound			West Bound		
Movement:	L	T	R	L	T	R	L	T	R	L	T	R
Control:	Protected			Protected			Protected			Protected		
Rights:	Include			Include			Include			Include		
Min. Green:	0	0	0	0	0	0	0	0	0	0	0	0
Y+R:	4.0	4.0	4.0	4.0	4.0	4.0	4.0	4.0	4.0	4.0	4.0	4.0
Lanes:	2	0	3	0	1		2	0	3	0	1	

Volume Module:

Base Vol:	221	1128	209	233	2204	54	13	153	59	139	178	101
Growth Adj:	1.00	1.00	1.00	1.00	1.00	1.00	1.00	1.00	1.00	1.00	1.00	1.00
Initial Bse:	221	1128	209	233	2204	54	13	153	59	139	178	101
User Adj:	1.00	1.00	1.00	1.00	1.00	1.00	1.00	1.00	1.00	1.00	1.00	1.00
PHF Adj:	1.00	1.00	1.00	1.00	1.00	1.00	1.00	1.00	1.00	1.00	1.00	1.00
PHF Volume:	221	1128	209	233	2204	54	13	153	59	139	178	101
Reduct Vol:	0	0	0	0	0	0	0	0	0	0	0	0
Reduced Vol:	221	1128	209	233	2204	54	13	153	59	139	178	101
PCE Adj:	1.00	1.00	1.00	1.00	1.00	1.00	1.00	1.00	1.00	1.00	1.00	1.00
MLF Adj:	1.00	1.00	1.00	1.00	1.00	1.00	1.00	1.00	1.00	1.00	1.00	1.00
FinalVolume:	221	1128	209	233	2204	54	13	153	59	139	178	101

Saturation Flow Module:

Sat/Lane:	1600	1600	1600	1600	1600	1600	1600	1600	1600	1600	1600	1600
Adjustment:	1.00	1.06	1.00	1.00	1.06	1.00	1.00	1.04	1.00	1.00	1.05	1.00
Lanes:	2.00	3.00	1.00	2.00	3.00	1.00	1.00	1.44	0.56	1.00	1.28	0.72
Final Sat.:	3200	5100	1600	3200	5100	1600	1600	2409	891	1601	2146	1153

Capacity Analysis Module:

Vol/Sat:	0.07	0.22	0.13	0.07	0.43	0.03	0.01	0.06	0.07	0.09	0.08	0.09
Crit Moves:	****			****			****		****	****		

Santa Ana Circulation Element

Level Of Service Computation Report
 2000 HCM Operations Method (Base Volume Alternative)

 Intersection #17 Harbor Blvd and I-405 NB Off-Ramp

Cycle (sec): 100 Critical Vol./Cap.(X): 0.569
 Loss Time (sec): 5 Average Delay (sec/veh): 18.0
 Optimal Cycle: 28 Level Of Service: B

Approach:	North Bound			South Bound			East Bound			West Bound		
Movement:	L	T	R	L	T	R	L	T	R	L	T	R
Control:	Protected			Protected			Split Phase			Split Phase		
Rights:	Include			Include			Include			Include		
Min. Green:	0	0	0	0	0	0	0	0	0	0	0	0
Y+R:	4.0	4.0	4.0	4.0	4.0	4.0	4.0	4.0	4.0	4.0	4.0	4.0
Lanes:	0	0	4	0	0	4	0	0	0	1	0	1

Volume Module:

Base Vol:	0	1915	0	0	1978	0	0	0	0	399	0	702
Growth Adj:	1.00	1.00	1.00	1.00	1.00	1.00	1.00	1.00	1.00	1.00	1.00	1.00
Initial Bse:	0	1915	0	0	1978	0	0	0	0	399	0	702
User Adj:	1.00	1.00	1.00	1.00	1.00	1.00	1.00	1.00	1.00	1.00	1.00	1.00
PHF Adj:	1.00	1.00	1.00	1.00	1.00	1.00	1.00	1.00	1.00	1.00	1.00	1.00
PHF Volume:	0	1915	0	0	1978	0	0	0	0	399	0	702
Reduct Vol:	0	0	0	0	0	0	0	0	0	0	0	0
Reduced Vol:	0	1915	0	0	1978	0	0	0	0	399	0	702
PCE Adj:	1.00	1.00	1.00	1.00	1.00	1.00	1.00	1.00	1.00	1.00	1.00	1.00
MLF Adj:	1.00	1.00	1.00	1.00	1.00	1.00	1.00	1.00	1.00	1.00	1.00	1.00
FinalVolume:	0	1915	0	0	1978	0	0	0	0	399	0	702

Saturation Flow Module:

Sat/Lane:	1900	1900	1900	1900	1900	1900	1900	1900	1900	1900	1900	1900
Adjustment:	1.00	0.91	1.00	1.00	0.91	1.00	1.00	1.00	1.00	0.89	1.00	0.89
Lanes:	0.00	4.00	0.00	0.00	4.00	0.00	0.00	0.00	0.00	1.36	0.00	1.64
Final Sat.:	0	6916	0	0	6916	0	0	0	0	2298	0	2762

Capacity Analysis Module:

Vol/Sat:	0.00	0.28	0.00	0.00	0.29	0.00	0.00	0.00	0.00	0.17	0.00	0.25
Crit Moves:	****			****								****
Green/Cycle:	0.00	0.50	0.00	0.00	0.50	0.00	0.00	0.00	0.00	0.45	0.00	0.45
Volume/Cap:	0.00	0.55	0.00	0.00	0.57	0.00	0.00	0.00	0.00	0.39	0.00	0.57
Delay/Veh:	0.0	17.3	0.0	0.0	17.5	0.0	0.0	0.0	0.0	18.6	0.0	20.9
User DelAdj:	1.00	1.00	1.00	1.00	1.00	1.00	1.00	1.00	1.00	1.00	1.00	1.00
AdjDel/Veh:	0.0	17.3	0.0	0.0	17.5	0.0	0.0	0.0	0.0	18.6	0.0	20.9
LOS by Move:	A	B	A	A	B	A	A	A	A	B	A	C
HCM2k85thQ:	0	17	0	0	18	0	0	0	0	9	0	15

 Note: Queue reported is the number of cars per lane.

Santa Ana Circulation Element

Level Of Service Computation Report
 2000 HCM Operations Method (Base Volume Alternative)

 Intersection #18 Harbor Blvd and I-405 SB Off-Ramp

Cycle (sec): 100 Critical Vol./Cap.(X): 0.612
 Loss Time (sec): 5 Average Delay (sec/veh): 15.0
 Optimal Cycle: 31 Level Of Service: B

Approach:	North Bound			South Bound			East Bound			West Bound		
Movement:	L	T	R	L	T	R	L	T	R	L	T	R
Control:	Protected			Protected			Split Phase			Split Phase		
Rights:	Ignore			Include			Include			Include		
Min. Green:	0	0	0	0	0	0	0	0	0	0	0	0
Y+R:	4.0	4.0	4.0	4.0	4.0	4.0	4.0	4.0	4.0	4.0	4.0	4.0
Lanes:	0	0	3	0	0	4	1	0	1	0	0	0

Volume Module:

Base Vol:	0	1963	0	0	1253	0	475	0	529	0	0	0
Growth Adj:	1.00	1.00	1.00	1.00	1.00	1.00	1.00	1.00	1.00	1.00	1.00	1.00
Initial Bse:	0	1963	0	0	1253	0	475	0	529	0	0	0
User Adj:	1.00	1.00	0.00	1.00	1.00	1.00	1.00	1.00	1.00	1.00	1.00	1.00
PHF Adj:	1.00	1.00	0.00	1.00	1.00	1.00	1.00	1.00	1.00	1.00	1.00	1.00
PHF Volume:	0	1963	0	0	1253	0	475	0	529	0	0	0
Reduct Vol:	0	0	0	0	0	0	0	0	0	0	0	0
Reduced Vol:	0	1963	0	0	1253	0	475	0	529	0	0	0
PCE Adj:	1.00	1.00	0.00	1.00	1.00	1.00	1.00	1.00	1.00	1.00	1.00	1.00
MLF Adj:	1.00	1.00	0.00	1.00	1.00	1.00	1.00	1.00	1.00	1.00	1.00	1.00
FinalVolume:	0	1963	0	0	1253	0	475	0	529	0	0	0

Saturation Flow Module:

Sat/Lane:	1900	1900	1900	1900	1900	1900	1900	1900	1900	1900	1900	1900
Adjustment:	1.00	0.91	1.00	1.00	0.91	1.00	0.90	1.00	0.90	1.00	1.00	1.00
Lanes:	0.00	3.00	1.00	0.00	4.00	0.00	1.47	0.00	1.53	0.00	0.00	0.00
Final Sat.:	0	5187	1900	0	6916	0	2519	0	2610	0	0	0

Capacity Analysis Module:

Vol/Sat:	0.00	0.38	0.00	0.00	0.18	0.00	0.19	0.00	0.20	0.00	0.00	0.00
Crit Moves:	****			****			****			****		
Green/Cycle:	0.00	0.62	0.00	0.00	0.62	0.00	0.33	0.00	0.33	0.00	0.00	0.00
Volume/Cap:	0.00	0.61	0.00	0.00	0.29	0.00	0.57	0.00	0.61	0.00	0.00	0.00
Delay/Veh:	0.0	12.0	0.0	0.0	8.9	0.0	28.0	0.0	28.7	0.0	0.0	0.0
User DelAdj:	1.00	1.00	1.00	1.00	1.00	1.00	1.00	1.00	1.00	1.00	1.00	1.00
AdjDel/Veh:	0.0	12.0	0.0	0.0	8.9	0.0	28.0	0.0	28.7	0.0	0.0	0.0
LOS by Move:	A	B	A	A	A	A	C	A	C	A	A	A
HCM2k85thQ:	0	21	0	0	8	0	13	0	15	0	0	0

 Note: Queue reported is the number of cars per lane.

Santa Ana Circulation Element

Level Of Service Computation Report

ICU 1(Loss as Cycle Length %) Method (Base Volume Alternative)

Intersection #19 Fairview St and Civic Center Dr

Cycle (sec): 100 Critical Vol./Cap.(X): 0.741
 Loss Time (sec): 5 Average Delay (sec/veh): xxxxxx
 Optimal Cycle: 42 Level Of Service: C

Approach:	North Bound			South Bound			East Bound			West Bound		
Movement:	L	T	R	L	T	R	L	T	R	L	T	R
Control:	Protected			Protected			Split Phase			Split Phase		
Rights:	WideBypass			Include			Include			Include		
Min. Green:	0	0	0	0	0	0	0	0	0	0	0	0
Y+R:	4.0	4.0	4.0	4.0	4.0	4.0	4.0	4.0	4.0	4.0	4.0	4.0
Lanes:	1	0	2	1	0	2	1	0	1	0	1	0

Volume Module:

Base Vol:	7	1569	508	332	1915	8	7	25	25	100	3	52
Growth Adj:	1.00	1.00	1.00	1.00	1.00	1.00	1.00	1.00	1.00	1.00	1.00	1.00
Initial Bse:	7	1569	508	332	1915	8	7	25	25	100	3	52
User Adj:	1.00	1.00	1.00	1.00	1.00	1.00	1.00	1.00	1.00	1.00	1.00	1.00
PHF Adj:	1.00	1.00	1.00	1.00	1.00	1.00	1.00	1.00	1.00	1.00	1.00	1.00
PHF Volume:	7	1569	508	332	1915	8	7	25	25	100	3	52
Reduct Vol:	0	0	0	0	0	0	0	0	0	0	0	0
Reduced Vol:	7	1569	508	332	1915	8	7	25	25	100	3	52
PCE Adj:	1.00	1.00	1.00	1.00	1.00	1.00	1.00	1.00	1.00	1.00	1.00	1.00
MLF Adj:	1.00	1.00	1.00	1.00	1.00	1.00	1.00	1.00	1.00	1.00	1.00	1.00
FinalVolume:	7	1569	508	332	1915	8	7	25	25	100	3	52

Saturation Flow Module:

Sat/Lane:	1600	1600	1600	1600	1600	1600	1600	1600	1600	1600	1600	1600
Adjustment:	1.00	1.06	1.00	1.00	1.04	1.00	1.00	1.00	1.00	1.00	1.00	1.00
Lanes:	1.00	2.27	0.73	1.00	2.99	0.01	0.24	0.88	0.88	1.94	0.06	1.00
Final Sat.:	1600	3826	1174	1600	4980	20	393	1404	1404	3107	93	1600

Capacity Analysis Module:

Vol/Sat:	0.00	0.41	0.43	0.21	0.38	0.40	0.02	0.02	0.02	0.03	0.03	0.03
Crit Moves:			****	****			****			****		

Santa Ana Circulation Element

Level Of Service Computation Report

ICU 1(Loss as Cycle Length %) Method (Base Volume Alternative)

Intersection #20 Fairview St and 1st St

Cycle (sec): 100 Critical Vol./Cap.(X): 0.859
 Loss Time (sec): 5 Average Delay (sec/veh): xxxxxx
 Optimal Cycle: 68 Level Of Service: D

Approach:	North Bound			South Bound			East Bound			West Bound		
Movement:	L	T	R	L	T	R	L	T	R	L	T	R
Control:	Protected			Protected			Protected			Protected		
Rights:	Include			Include			Include			Include		
Min. Green:	0	0	0	0	0	0	0	0	0	0	0	0
Y+R:	4.0	4.0	4.0	4.0	4.0	4.0	4.0	4.0	4.0	4.0	4.0	4.0
Lanes:	1	0	3	0	1	0	1	0	2	1	0	2

Volume Module:	North Bound			South Bound			East Bound			West Bound		
Base Vol:	200	1538	289	245	1426	164	200	1153	179	120	539	181
Growth Adj:	1.00	1.00	1.00	1.00	1.00	1.00	1.00	1.00	1.00	1.00	1.00	1.00
Initial Bse:	200	1538	289	245	1426	164	200	1153	179	120	539	181
User Adj:	1.00	1.00	1.00	1.00	1.00	1.00	1.00	1.00	1.00	1.00	1.00	1.00
PHF Adj:	1.00	1.00	1.00	1.00	1.00	1.00	1.00	1.00	1.00	1.00	1.00	1.00
PHF Volume:	200	1538	289	245	1426	164	200	1153	179	120	539	181
Reduct Vol:	0	0	0	0	0	0	0	0	0	0	0	0
Reduced Vol:	200	1538	289	245	1426	164	200	1153	179	120	539	181
PCE Adj:	1.00	1.00	1.00	1.00	1.00	1.00	1.00	1.00	1.00	1.00	1.00	1.00
MLF Adj:	1.00	1.00	1.00	1.00	1.00	1.00	1.00	1.00	1.00	1.00	1.00	1.00
FinalVolume:	200	1538	289	245	1426	164	200	1153	179	120	539	181

Saturation Flow Module:	North Bound			South Bound			East Bound			West Bound		
Sat/Lane:	1600	1600	1600	1600	1600	1600	1600	1600	1600	1600	1600	1600
Adjustment:	1.00	1.06	1.00	1.00	1.05	1.00	1.00	1.05	1.00	1.00	1.06	1.00
Lanes:	1.00	3.00	1.00	1.00	2.69	0.31	1.00	2.60	0.40	1.00	2.25	0.75
Final Sat.:	1600	5100	1600	1600	4505	495	1600	4355	645	1600	3793	1207

Capacity Analysis Module:	North Bound			South Bound			East Bound			West Bound		
Vol/Sat:	0.13	0.30	0.18	0.15	0.32	0.33	0.13	0.26	0.28	0.08	0.14	0.15
Crit Moves:	****				****			****	****			

Santa Ana Circulation Element

Level Of Service Computation Report

ICU 1(Loss as Cycle Length %) Method (Base Volume Alternative)

Intersection #21 Fairview St and McFadden Ave

Cycle (sec): 100 Critical Vol./Cap.(X): 0.799
 Loss Time (sec): 5 Average Delay (sec/veh): xxxxxx
 Optimal Cycle: 52 Level Of Service: C

Approach:	North Bound			South Bound			East Bound			West Bound		
Movement:	L	T	R	L	T	R	L	T	R	L	T	R
Control:	Protected			Protected			Protected			Protected		
Rights:	Include			Include			Include			Include		
Min. Green:	0	0	0	0	0	0	0	0	0	0	0	0
Y+R:	4.0	4.0	4.0	4.0	4.0	4.0	4.0	4.0	4.0	4.0	4.0	4.0
Lanes:	1	0	3	0	1	1	0	1	1	0	1	1

Volume Module:

Base Vol:	141	1510	202	154	1878	136	221	522	120	147	380	30
Growth Adj:	1.00	1.00	1.00	1.00	1.00	1.00	1.00	1.00	1.00	1.00	1.00	1.00
Initial Bse:	141	1510	202	154	1878	136	221	522	120	147	380	30
User Adj:	1.00	1.00	1.00	1.00	1.00	1.00	1.00	1.00	1.00	1.00	1.00	1.00
PHF Adj:	1.00	1.00	1.00	1.00	1.00	1.00	1.00	1.00	1.00	1.00	1.00	1.00
PHF Volume:	141	1510	202	154	1878	136	221	522	120	147	380	30
Reduct Vol:	0	0	0	0	0	0	0	0	0	0	0	0
Reduced Vol:	141	1510	202	154	1878	136	221	522	120	147	380	30
PCE Adj:	1.00	1.00	1.00	1.00	1.00	1.00	1.00	1.00	1.00	1.00	1.00	1.00
MLF Adj:	1.00	1.00	1.00	1.00	1.00	1.00	1.00	1.00	1.00	1.00	1.00	1.00
FinalVolume:	141	1510	202	154	1878	136	221	522	120	147	380	30

Saturation Flow Module:

Sat/Lane:	1600	1600	1600	1600	1600	1600	1600	1600	1600	1600	1600	1600
Adjustment:	1.00	1.06	1.00	1.00	1.06	1.00	1.00	1.04	1.00	1.00	1.03	1.00
Lanes:	1.00	3.00	1.00	1.00	3.00	1.00	1.00	1.63	0.37	1.00	1.85	0.15
Final Sat.:	1600	5100	1600	1600	5100	1600	1600	2702	598	1600	3066	234

Capacity Analysis Module:

Vol/Sat:	0.09	0.30	0.13	0.10	0.37	0.09	0.14	0.19	0.20	0.09	0.12	0.13
Crit Moves:	****			****			****		****	****		

Santa Ana Circulation Element

Level Of Service Computation Report

ICU 1(Loss as Cycle Length %) Method (Base Volume Alternative)

Intersection #22 Fairview St and Edinger Ave

Cycle (sec): 100 Critical Vol./Cap.(X): 0.861
Loss Time (sec): 5 Average Delay (sec/veh): xxxxxx
Optimal Cycle: 69 Level Of Service: D

Table with 4 columns: North Bound, South Bound, East Bound, West Bound. Rows include Movement, Control, Rights, Min. Green, Y+R, and Lanes.

Volume Module: Table with 12 columns representing different volume categories and their values.

Saturation Flow Module: Table with 12 columns representing saturation flow values.

Capacity Analysis Module: Table with 12 columns representing capacity analysis values.

Santa Ana Circulation Element

Level Of Service Computation Report

ICU 1(Loss as Cycle Length %) Method (Base Volume Alternative)

Intersection #23 Fairview St and Warner Ave

Cycle (sec): 100 Critical Vol./Cap.(X): 0.816
 Loss Time (sec): 5 Average Delay (sec/veh): xxxxxx
 Optimal Cycle: 55 Level Of Service: D

Approach:	North Bound			South Bound			East Bound			West Bound		
Movement:	L	T	R	L	T	R	L	T	R	L	T	R
Control:	Protected			Protected			Protected			Protected		
Rights:	Include			Include			Include			Include		
Min. Green:	0	0	0	0	0	0	0	0	0	0	0	0
Y+R:	4.0	4.0	4.0	4.0	4.0	4.0	4.0	4.0	4.0	4.0	4.0	4.0
Lanes:	2	0	2	1	0	0	2	0	2	1	0	0

Volume Module:

Base Vol:	222	981	129	194	1543	113	68	991	295	267	807	261
Growth Adj:	1.00	1.00	1.00	1.00	1.00	1.00	1.00	1.00	1.00	1.00	1.00	1.00
Initial Bse:	222	981	129	194	1543	113	68	991	295	267	807	261
User Adj:	1.00	1.00	1.00	1.00	1.00	1.00	1.00	1.00	1.00	1.00	1.00	1.00
PHF Adj:	1.00	1.00	1.00	1.00	1.00	1.00	1.00	1.00	1.00	1.00	1.00	1.00
PHF Volume:	222	981	129	194	1543	113	68	991	295	267	807	261
Reduct Vol:	0	0	0	0	0	0	0	0	0	0	0	0
Reduced Vol:	222	981	129	194	1543	113	68	991	295	267	807	261
PCE Adj:	1.00	1.00	1.00	1.00	1.00	1.00	1.00	1.00	1.00	1.00	1.00	1.00
MLF Adj:	1.00	1.00	1.00	1.00	1.00	1.00	1.00	1.00	1.00	1.00	1.00	1.00
FinalVolume:	222	981	129	194	1543	113	68	991	295	267	807	261

Saturation Flow Module:

Sat/Lane:	1600	1600	1600	1600	1600	1600	1600	1600	1600	1600	1600	1600
Adjustment:	1.00	1.05	1.00	1.00	1.04	1.00	1.00	1.05	1.00	1.00	1.06	1.00
Lanes:	2.00	2.65	0.35	2.00	2.80	0.20	2.00	2.31	0.69	2.00	2.27	0.73
Final Sat.:	3200	4442	558	3200	4672	328	3200	3899	1101	3200	3827	1173

Capacity Analysis Module:

Vol/Sat:	0.07	0.22	0.23	0.06	0.33	0.35	0.02	0.25	0.27	0.08	0.21	0.22
Crit Moves:	****					****			****	****		

Santa Ana Circulation Element

Level Of Service Computation Report

ICU 1(Loss as Cycle Length %) Method (Base Volume Alternative)

Intersection #24 Fairview St and MacArthur Blvd

Cycle (sec): 100 Critical Vol./Cap.(X): 0.684
Loss Time (sec): 5 Average Delay (sec/veh): xxxxxx
Optimal Cycle: 36 Level Of Service: B

Table with 4 columns: North Bound, South Bound, East Bound, West Bound. Rows include Movement (L-T-R), Control (Protected), Rights (Include), Min. Green, Y+R, and Lanes.

Volume Module: Table with 12 columns for volume and adjustment factors. Rows include Base Vol, Growth Adj, Initial Bse, User Adj, PHF Adj, PHF Volume, Reduct Vol, Reduced Vol, PCE Adj, MLF Adj, and Final Volume.

Saturation Flow Module: Table with 12 columns for saturation flow. Rows include Sat/Lane, Adjustment, Lanes, and Final Sat.

Capacity Analysis Module: Table with 12 columns for capacity analysis. Rows include Vol/Sat and Crit Moves.

Santa Ana Circulation Element

Level Of Service Computation Report

ICU 1(Loss as Cycle Length %) Method (Base Volume Alternative)

Intersection #25 Fairview Rd and Sunflower Ave

Cycle (sec): 100 Critical Vol./Cap.(X): 0.697
 Loss Time (sec): 5 Average Delay (sec/veh): xxxxxx
 Optimal Cycle: 37 Level Of Service: B

Approach:	North Bound			South Bound			East Bound			West Bound		
Movement:	L	T	R	L	T	R	L	T	R	L	T	R
Control:	Protected			Protected			Protected			Protected		
Rights:	Include			Include			Include			Include		
Min. Green:	0	0	0	0	0	0	0	0	0	0	0	0
Y+R:	4.0	4.0	4.0	4.0	4.0	4.0	4.0	4.0	4.0	4.0	4.0	4.0
Lanes:	2	0	3	0	1		2	0	2	1	0	

Volume Module:

Base Vol:	185	1071	163	191	1627	104	49	322	65	357	299	154
Growth Adj:	1.00	1.00	1.00	1.00	1.00	1.00	1.00	1.00	1.00	1.00	1.00	1.00
Initial Bse:	185	1071	163	191	1627	104	49	322	65	357	299	154
User Adj:	1.00	1.00	1.00	1.00	1.00	1.00	1.00	1.00	1.00	1.00	1.00	1.00
PHF Adj:	1.00	1.00	1.00	1.00	1.00	1.00	1.00	1.00	1.00	1.00	1.00	1.00
PHF Volume:	185	1071	163	191	1627	104	49	322	65	357	299	154
Reduct Vol:	0	0	0	0	0	0	0	0	0	0	0	0
Reduced Vol:	185	1071	163	191	1627	104	49	322	65	357	299	154
PCE Adj:	1.00	1.00	1.00	1.00	1.00	1.00	1.00	1.00	1.00	1.00	1.00	1.00
MLF Adj:	1.00	1.00	1.00	1.00	1.00	1.00	1.00	1.00	1.00	1.00	1.00	1.00
FinalVolume:	185	1071	163	191	1627	104	49	322	65	357	299	154

Saturation Flow Module:

Sat/Lane:	1600	1600	1600	1600	1600	1600	1600	1600	1600	1600	1600	1600
Adjustment:	1.00	1.06	1.00	1.00	1.04	1.00	1.00	1.04	1.00	1.00	1.06	1.00
Lanes:	2.00	3.00	1.00	2.00	2.82	0.18	2.00	1.66	0.34	2.00	2.00	1.00
Final Sat.:	3200	5100	1600	3200	4712	288	3200	2763	537	3200	3400	1600

Capacity Analysis Module:

Vol/Sat:	0.06	0.21	0.10	0.06	0.35	0.36	0.02	0.12	0.12	0.11	0.09	0.10
Crit Moves:	****					****		****		****		

Santa Ana Circulation Element

Level Of Service Computation Report

ICU 1(Loss as Cycle Length %) Method (Base Volume Alternative)

Intersection #26 Greenville St and Edinger Ave

Cycle (sec): 100 Critical Vol./Cap.(X): 0.774
 Loss Time (sec): 5 Average Delay (sec/veh): xxxxxx
 Optimal Cycle: 47 Level Of Service: C

Approach:	North Bound			South Bound			East Bound			West Bound		
Movement:	L	T	R	L	T	R	L	T	R	L	T	R
Control:	Split Phase			Split Phase			Protected			Protected		
Rights:	Include			Include			Include			Include		
Min. Green:	0	0	0	0	0	0	0	0	0	0	0	0
Y+R:	4.0	4.0	4.0	4.0	4.0	4.0	4.0	4.0	4.0	4.0	4.0	4.0
Lanes:	1	0	0	0	0	0	0	0	2	1	0	3

Volume Module:

Base Vol:	186	0	251	0	0	0	0	1821	444	153	813	0
Growth Adj:	1.00	1.00	1.00	1.00	1.00	1.00	1.00	1.00	1.00	1.00	1.00	1.00
Initial Bse:	186	0	251	0	0	0	0	1821	444	153	813	0
User Adj:	1.00	1.00	1.00	1.00	1.00	1.00	1.00	1.00	1.00	1.00	1.00	1.00
PHF Adj:	1.00	1.00	1.00	1.00	1.00	1.00	1.00	1.00	1.00	1.00	1.00	1.00
PHF Volume:	186	0	251	0	0	0	0	1821	444	153	813	0
Reduct Vol:	0	0	0	0	0	0	0	0	0	0	0	0
Reduced Vol:	186	0	251	0	0	0	0	1821	444	153	813	0
PCE Adj:	1.00	1.00	1.00	1.00	1.00	1.00	1.00	1.00	1.00	1.00	1.00	1.00
MLF Adj:	1.00	1.00	1.00	1.00	1.00	1.00	1.00	1.00	1.00	1.00	1.00	1.00
FinalVolume:	186	0	251	0	0	0	0	1821	444	153	813	0

Saturation Flow Module:

Sat/Lane:	1600	1600	1600	1600	1600	1600	1600	1600	1600	1600	1600	1600
Adjustment:	1.00	1.06	1.00	1.00	1.06	1.00	1.00	1.05	1.00	1.00	1.06	1.00
Lanes:	1.00	0.00	1.00	0.00	0.00	0.00	0.00	2.41	0.59	1.00	3.00	0.00
Final Sat.:	1600	0	1600	0	0	0	0	4059	941	1600	5100	0

Capacity Analysis Module:

Vol/Sat:	0.12	0.00	0.16	0.00	0.00	0.00	0.00	0.45	0.47	0.10	0.16	0.00
Crit Moves:	****			****			****			****		

Santa Ana Circulation Element

Level Of Service Computation Report

ICU 1(Loss as Cycle Length %) Method (Base Volume Alternative)

Intersection #27 Greenville St and Segerstrom Ave

Cycle (sec): 100 Critical Vol./Cap.(X): 0.843
Loss Time (sec): 5 Average Delay (sec/veh): xxxxxx
Optimal Cycle: 63 Level Of Service: D

Table with 4 columns: North Bound, South Bound, East Bound, West Bound. Rows include Movement (L-T-R), Control (Permitted), Rights (Include), Min. Green, Y+R, and Lanes.

Volume Module: Table with 12 columns representing different traffic volumes and adjustment factors like Base Vol, Growth Adj, Initial Bse, etc.

Saturation Flow Module: Table with 12 columns showing saturation flow values and adjustment factors like Sat/Lane, Adjustment, Lanes, Final Sat.

Capacity Analysis Module: Table with 12 columns showing capacity analysis values like Vol/Sat, Crit Moves.

Santa Ana Circulation Element

Level Of Service Computation Report

ICU 1(Loss as Cycle Length %) Method (Base Volume Alternative)

Intersection #28 Raitt St and McFadden Ave

Cycle (sec): 100 Critical Vol./Cap.(X): 0.778
 Loss Time (sec): 5 Average Delay (sec/veh): xxxxxx
 Optimal Cycle: 48 Level Of Service: C

Approach:	North Bound			South Bound			East Bound			West Bound		
Movement:	L	T	R	L	T	R	L	T	R	L	T	R
Control:	Protected			Protected			Protected			Protected		
Rights:	Include			Include			Include			Include		
Min. Green:	0	0	0	0	0	0	0	0	0	0	0	0
Y+R:	4.0	4.0	4.0	4.0	4.0	4.0	4.0	4.0	4.0	4.0	4.0	4.0
Lanes:	1	0	1	1	0	1	1	0	1	1	0	1

Volume Module:

Base Vol:	67	618	98	123	938	128	122	743	95	146	461	82
Growth Adj:	1.00	1.00	1.00	1.00	1.00	1.00	1.00	1.00	1.00	1.00	1.00	1.00
Initial Bse:	67	618	98	123	938	128	122	743	95	146	461	82
User Adj:	1.00	1.00	1.00	1.00	1.00	1.00	1.00	1.00	1.00	1.00	1.00	1.00
PHF Adj:	1.00	1.00	1.00	1.00	1.00	1.00	1.00	1.00	1.00	1.00	1.00	1.00
PHF Volume:	67	618	98	123	938	128	122	743	95	146	461	82
Reduct Vol:	0	0	0	0	0	0	0	0	0	0	0	0
Reduced Vol:	67	618	98	123	938	128	122	743	95	146	461	82
PCE Adj:	1.00	1.00	1.00	1.00	1.00	1.00	1.00	1.00	1.00	1.00	1.00	1.00
MLF Adj:	1.00	1.00	1.00	1.00	1.00	1.00	1.00	1.00	1.00	1.00	1.00	1.00
FinalVolume:	67	618	98	123	938	128	122	743	95	146	461	82

Saturation Flow Module:

Sat/Lane:	1600	1600	1600	1600	1600	1600	1600	1600	1600	1600	1600	1600
Adjustment:	1.00	1.04	1.00	1.00	1.04	1.00	1.00	1.04	1.00	1.00	1.04	1.00
Lanes:	1.00	1.73	0.27	1.00	1.76	0.24	1.00	1.77	0.23	1.00	1.70	0.30
Final Sat.:	1600	2862	438	1600	2916	384	1600	2937	363	1600	2817	483

Capacity Analysis Module:

Vol/Sat:	0.04	0.22	0.22	0.08	0.32	0.33	0.08	0.25	0.26	0.09	0.16	0.17
Crit Moves:	****					****			****	****		

Santa Ana Circulation Element

Level Of Service Computation Report

ICU 1(Loss as Cycle Length %) Method (Base Volume Alternative)

Intersection #29 Raitt St and Edinger Ave

Cycle (sec): 100 Critical Vol./Cap.(X): 0.990
Loss Time (sec): 5 Average Delay (sec/veh): xxxxxx
Optimal Cycle: 180 Level Of Service: E

Table with 4 columns: North Bound, South Bound, East Bound, West Bound. Rows include Movement (L-T-R), Control (Protected), Rights (Include), Min. Green, Y+R, and Lanes.

Volume Module: Table with 12 columns representing traffic volumes and 10 rows for various adjustment factors like Growth Adj, Initial Bse, User Adj, PHF Adj, PHF Volume, Reduct Vol, Reduced Vol, PCE Adj, MLF Adj, and Final Volume.

Saturation Flow Module: Table with 12 columns for saturation flow and 4 rows for Sat/Lane, Adjustment, Lanes, and Final Sat.

Capacity Analysis Module: Table with 12 columns for capacity analysis and 3 rows for Vol/Sat, Crit Moves, and other metrics.

Santa Ana Circulation Element

Level Of Service Computation Report

ICU 1(Loss as Cycle Length %) Method (Base Volume Alternative)

Intersection #30 Bear St and MacArthur Blvd

Cycle (sec): 100 Critical Vol./Cap.(X): 0.707
Loss Time (sec): 5 Average Delay (sec/veh): xxxxxx
Optimal Cycle: 38 Level Of Service: C

Table with 4 columns: North Bound, South Bound, East Bound, West Bound. Rows include Movement, Control, Rights, Min. Green, Y+R, and Lanes.

Volume Module: Table with 12 columns representing different volume categories and their values.

Saturation Flow Module: Table with 12 columns representing saturation flow values and adjustment factors.

Capacity Analysis Module: Table with 12 columns representing capacity analysis metrics.

Santa Ana Circulation Element

Level Of Service Computation Report

ICU 1(Loss as Cycle Length %) Method (Base Volume Alternative)

Intersection #31 Bristol St and 17th St

Cycle (sec): 100 Critical Vol./Cap.(X): 0.869
 Loss Time (sec): 5 Average Delay (sec/veh): xxxxxx
 Optimal Cycle: 72 Level Of Service: D

Approach:	North Bound			South Bound			East Bound			West Bound		
Movement:	L	T	R	L	T	R	L	T	R	L	T	R
Control:	Protected			Protected			Protected			Protected		
Rights:	Include			Include			Include			Ovl		
Min. Green:	0	0	0	0	0	0	0	0	0	0	0	0
Y+R:	4.0	4.0	4.0	4.0	4.0	4.0	4.0	4.0	4.0	4.0	4.0	4.0
Lanes:	2	0	3	0	1		2	0	3	0	1	

Volume Module:

Base Vol:	251	1292	218	487	2001	263	324	963	156	368	845	280
Growth Adj:	1.00	1.00	1.00	1.00	1.00	1.00	1.00	1.00	1.00	1.00	1.00	1.00
Initial Bse:	251	1292	218	487	2001	263	324	963	156	368	845	280
User Adj:	1.00	1.00	1.00	1.00	1.00	1.00	1.00	1.00	1.00	1.00	1.00	1.00
PHF Adj:	1.00	1.00	1.00	1.00	1.00	1.00	1.00	1.00	1.00	1.00	1.00	1.00
PHF Volume:	251	1292	218	487	2001	263	324	963	156	368	845	280
Reduct Vol:	0	0	0	0	0	0	0	0	0	0	0	0
Reduced Vol:	251	1292	218	487	2001	263	324	963	156	368	845	280
PCE Adj:	1.00	1.00	1.00	1.00	1.00	1.00	1.00	1.00	1.00	1.00	1.00	1.00
MLF Adj:	1.00	1.00	1.00	1.00	1.00	1.00	1.00	1.00	1.00	1.00	1.00	1.00
FinalVolume:	251	1292	218	487	2001	263	324	963	156	368	845	280
OvlAdjVol:	36											

Saturation Flow Module:

Sat/Lane:	1600	1600	1600	1600	1600	1600	1600	1600	1600	1600	1600	1600
Adjustment:	1.00	1.06	1.00	1.00	1.06	1.00	1.00	1.05	1.00	1.00	1.06	1.00
Lanes:	2.00	3.00	1.00	2.00	3.00	1.00	2.00	2.58	0.42	2.00	3.00	1.00
Final Sat.:	3200	5100	1600	3200	5100	1600	3200	4331	669	3200	5100	1600

Capacity Analysis Module:

Vol/Sat:	0.08	0.25	0.14	0.15	0.39	0.16	0.10	0.22	0.23	0.12	0.17	0.17
OvlAdjV/S:	0.02											
Crit Moves:	****			****			****			****		

Santa Ana Circulation Element

Level Of Service Computation Report

ICU 1(Loss as Cycle Length %) Method (Base Volume Alternative)

Intersection #32 Bristol St and Civic Center Dr

Cycle (sec): 100 Critical Vol./Cap.(X): 0.942
 Loss Time (sec): 5 Average Delay (sec/veh): xxxxxx
 Optimal Cycle: 120 Level Of Service: E

Approach:	North Bound			South Bound			East Bound			West Bound		
Movement:	L	T	R	L	T	R	L	T	R	L	T	R
Control:	Protected			Protected			Prot+Permit			Prot+Permit		
Rights:	Include			Include			Include			Include		
Min. Green:	0	0	0	0	0	0	0	0	0	0	0	0
Y+R:	4.0	4.0	4.0	4.0	4.0	4.0	4.0	4.0	4.0	4.0	4.0	4.0
Lanes:	1	0	2	1	0	2	1	0	1	1	0	1

Volume Module:

Base Vol:	133	1178	104	403	1628	101	165	836	103	127	421	87
Growth Adj:	1.00	1.00	1.00	1.00	1.00	1.00	1.00	1.00	1.00	1.00	1.00	1.00
Initial Bse:	133	1178	104	403	1628	101	165	836	103	127	421	87
User Adj:	1.00	1.00	1.00	1.00	1.00	1.00	1.00	1.00	1.00	1.00	1.00	1.00
PHF Adj:	1.00	1.00	1.00	1.00	1.00	1.00	1.00	1.00	1.00	1.00	1.00	1.00
PHF Volume:	133	1178	104	403	1628	101	165	836	103	127	421	87
Reduct Vol:	0	0	0	0	0	0	0	0	0	0	0	0
Reduced Vol:	133	1178	104	403	1628	101	165	836	103	127	421	87
PCE Adj:	1.00	1.00	1.00	1.00	1.00	1.00	1.00	1.00	1.00	1.00	1.00	1.00
MLF Adj:	1.00	1.00	1.00	1.00	1.00	1.00	1.00	1.00	1.00	1.00	1.00	1.00
FinalVolume:	133	1178	104	403	1628	101	165	836	103	127	421	87

Saturation Flow Module:

Sat/Lane:	1600	1600	1600	1600	1600	1600	1600	1600	1600	1600	1600	1600
Adjustment:	1.00	1.05	1.00	1.00	1.04	1.00	1.00	1.04	1.00	1.00	1.04	1.00
Lanes:	1.00	2.76	0.24	1.00	2.82	0.18	1.00	1.78	0.22	1.00	1.66	0.34
Final Sat.:	1600	4611	389	1600	4720	280	1600	2949	351	1600	2752	548

Capacity Analysis Module:

Vol/Sat:	0.08	0.26	0.27	0.25	0.34	0.36	0.10	0.28	0.29	0.08	0.15	0.16
Crit Moves:			****	****					****	****		

Santa Ana Circulation Element

Level Of Service Computation Report

ICU 1(Loss as Cycle Length %) Method (Base Volume Alternative)

Intersection #33 Bristol St and Santa Ana Blvd

Cycle (sec): 100 Critical Vol./Cap.(X): 0.806
 Loss Time (sec): 5 Average Delay (sec/veh): xxxxxx
 Optimal Cycle: 53 Level Of Service: D

Approach:	North Bound			South Bound			East Bound			West Bound		
Movement:	L	T	R	L	T	R	L	T	R	L	T	R
Control:	Protected			Protected			Prot+Permit			Prot+Permit		
Rights:	Include			Include			Include			Include		
Min. Green:	0	0	0	0	0	0	0	0	0	0	0	0
Y+R:	4.0	4.0	4.0	4.0	4.0	4.0	4.0	4.0	4.0	4.0	4.0	4.0
Lanes:	1	0	2	1	0	2	1	0	2	1	0	2

Volume Module:

Base Vol:	69	1502	209	153	1684	46	171	831	72	185	462	79
Growth Adj:	1.00	1.00	1.00	1.00	1.00	1.00	1.00	1.00	1.00	1.00	1.00	1.00
Initial Bse:	69	1502	209	153	1684	46	171	831	72	185	462	79
User Adj:	1.00	1.00	1.00	1.00	1.00	1.00	1.00	1.00	1.00	1.00	1.00	1.00
PHF Adj:	1.00	1.00	1.00	1.00	1.00	1.00	1.00	1.00	1.00	1.00	1.00	1.00
PHF Volume:	69	1502	209	153	1684	46	171	831	72	185	462	79
Reduct Vol:	0	0	0	0	0	0	0	0	0	0	0	0
Reduced Vol:	69	1502	209	153	1684	46	171	831	72	185	462	79
PCE Adj:	1.00	1.00	1.00	1.00	1.00	1.00	1.00	1.00	1.00	1.00	1.00	1.00
MLF Adj:	1.00	1.00	1.00	1.00	1.00	1.00	1.00	1.00	1.00	1.00	1.00	1.00
FinalVolume:	69	1502	209	153	1684	46	171	831	72	185	462	79

Saturation Flow Module:

Sat/Lane:	1600	1600	1600	1600	1600	1600	1600	1600	1600	1600	1600	1600
Adjustment:	1.00	1.05	1.00	1.00	1.04	1.00	1.00	1.05	1.00	1.00	1.05	1.00
Lanes:	1.00	2.63	0.37	1.00	2.92	0.08	1.00	2.76	0.24	1.00	2.56	0.44
Final Sat.:	1600	4414	586	1600	4872	128	1600	4617	383	1600	4299	701

Capacity Analysis Module:

Vol/Sat:	0.04	0.34	0.36	0.10	0.35	0.36	0.11	0.18	0.19	0.12	0.11	0.11
Crit Moves:			****	****					****	****		

Santa Ana Circulation Element

Level Of Service Computation Report

ICU 1(Loss as Cycle Length %) Method (Base Volume Alternative)

Intersection #34 Bristol St and 1st St

Cycle (sec): 100 Critical Vol./Cap.(X): 0.767
Loss Time (sec): 5 Average Delay (sec/veh): xxxxxx
Optimal Cycle: 46 Level Of Service: C

Table with 4 columns: North Bound, South Bound, East Bound, West Bound. Rows include Movement (L-T-R), Control (Protected), Rights (Include), Min. Green, Y+R, and Lanes.

Volume Module: Table with 12 columns representing different volume categories and their values.

Saturation Flow Module: Table with 12 columns representing saturation flow values for various lanes.

Capacity Analysis Module: Table with 12 columns representing capacity analysis values.

Santa Ana Circulation Element

Level Of Service Computation Report

ICU 1(Loss as Cycle Length %) Method (Base Volume Alternative)

Intersection #35 Bristol St and McFadden Ave

Cycle (sec): 100 Critical Vol./Cap.(X): 0.956
Loss Time (sec): 5 Average Delay (sec/veh): xxxxxx
Optimal Cycle: 139 Level Of Service: E

Table with 4 columns: North Bound, South Bound, East Bound, West Bound. Rows include Movement (L-T-R), Control, Rights, Min. Green, Y+R, and Lanes.

Volume Module: Table with 12 columns representing different traffic volumes and adjustment factors like Growth Adj, Initial Bse, User Adj, PHF Adj, etc.

Saturation Flow Module: Table with 12 columns showing saturation flow rates and adjustment factors for different lanes.

Capacity Analysis Module: Table with 12 columns showing Vol/Sat and Crit Moves for each lane.

Santa Ana Circulation Element

Level Of Service Computation Report

ICU 1(Loss as Cycle Length %) Method (Base Volume Alternative)

Intersection #36 Bristol St and Warner Ave

Cycle (sec): 100 Critical Vol./Cap.(X): 0.915
Loss Time (sec): 5 Average Delay (sec/veh): xxxxxx
Optimal Cycle: 96 Level Of Service: E

Table with 4 columns: North Bound, South Bound, East Bound, West Bound. Rows include Movement, Control, Rights, Min. Green, Y+R, and Lanes.

Volume Module: Table with 12 columns representing different volume categories and their values.

Saturation Flow Module: Table with 12 columns representing saturation flow values for various lanes.

Capacity Analysis Module: Table with 12 columns representing capacity analysis metrics.

Santa Ana Circulation Element

Level Of Service Computation Report

ICU 1(Loss as Cycle Length %) Method (Base Volume Alternative)

Intersection #37 Bristol St and Segerstrom Ave

Cycle (sec): 100 Critical Vol./Cap.(X): 0.811
Loss Time (sec): 5 Average Delay (sec/veh): xxxxxx
Optimal Cycle: 54 Level Of Service: D

Table with 4 columns: North Bound, South Bound, East Bound, West Bound. Rows include Movement (L-T-R), Control, Rights, Min. Green, Y+R, and Lanes.

Volume Module: Table with 12 columns representing different traffic volumes and adjustment factors like Growth Adj, Initial Bse, User Adj, PHF Adj, etc.

Saturation Flow Module: Table with 12 columns showing saturation flow rates and adjustment factors for each lane.

Capacity Analysis Module: Table with 12 columns showing Vol/Sat and Crit Moves for each lane.

Santa Ana Circulation Element

Level Of Service Computation Report

ICU 1(Loss as Cycle Length %) Method (Base Volume Alternative)

Intersection #38 Bristol St and Alton Ave

Cycle (sec): 100 Critical Vol./Cap.(X): 0.545
Loss Time (sec): 5 Average Delay (sec/veh): xxxxxx
Optimal Cycle: 26 Level Of Service: A

Table with 4 columns: North Bound, South Bound, East Bound, West Bound. Rows include Movement, Control, Rights, Min. Green, Y+R, and Lanes.

Volume Module: Table with 12 columns representing different traffic flows. Rows include Base Vol, Growth Adj, Initial Bse, User Adj, PHF Adj, PHF Volume, Reduct Vol, Reduced Vol, PCE Adj, MLF Adj, and Final Volume.

Saturation Flow Module: Table with 12 columns. Rows include Sat/Lane, Adjustment, Lanes, and Final Sat.

Capacity Analysis Module: Table with 12 columns. Rows include Vol/Sat and Crit Moves.

Santa Ana Circulation Element

Level Of Service Computation Report

ICU 1(Loss as Cycle Length %) Method (Base Volume Alternative)

Intersection #39 Bristol St and MacArthur Blvd

Cycle (sec): 100 Critical Vol./Cap.(X): 0.697
 Loss Time (sec): 5 Average Delay (sec/veh): xxxxxx
 Optimal Cycle: 37 Level Of Service: B

Approach:	North Bound			South Bound			East Bound			West Bound		
Movement:	L	T	R	L	T	R	L	T	R	L	T	R
Control:	Protected			Protected			Protected			Protected		
Rights:	Include			Include			Include			Include		
Min. Green:	0	0	0	0	0	0	0	0	0	0	0	0
Y+R:	4.0	4.0	4.0	4.0	4.0	4.0	4.0	4.0	4.0	4.0	4.0	4.0
Lanes:	2	0	3	0	1		2	0	2	1	0	

Volume Module:

Base Vol:	102	531	133	329	1434	150	166	1203	244	159	758	110
Growth Adj:	1.00	1.00	1.00	1.00	1.00	1.00	1.00	1.00	1.00	1.00	1.00	1.00
Initial Bse:	102	531	133	329	1434	150	166	1203	244	159	758	110
User Adj:	1.00	1.00	1.00	1.00	1.00	1.00	1.00	1.00	1.00	1.00	1.00	1.00
PHF Adj:	1.00	1.00	1.00	1.00	1.00	1.00	1.00	1.00	1.00	1.00	1.00	1.00
PHF Volume:	102	531	133	329	1434	150	166	1203	244	159	758	110
Reduct Vol:	0	0	0	0	0	0	0	0	0	0	0	0
Reduced Vol:	102	531	133	329	1434	150	166	1203	244	159	758	110
PCE Adj:	1.00	1.00	1.00	1.00	1.00	1.00	1.00	1.00	1.00	1.00	1.00	1.00
MLF Adj:	1.00	1.00	1.00	1.00	1.00	1.00	1.00	1.00	1.00	1.00	1.00	1.00
Final Volume:	102	531	133	329	1434	150	166	1203	244	159	758	110

Saturation Flow Module:

Sat/Lane:	1600	1600	1600	1600	1600	1600	1600	1600	1600	1600	1600	1600
Adjustment:	1.00	1.06	1.00	1.00	1.05	1.00	1.00	1.06	1.00	1.00	1.06	1.00
Lanes:	2.00	3.00	1.00	2.00	2.72	0.28	2.00	3.00	1.00	2.00	3.00	1.00
Final Sat.:	3200	5100	1600	3200	4545	455	3200	5100	1600	3200	5100	1600

Capacity Analysis Module:

Vol/Sat:	0.03	0.10	0.08	0.10	0.32	0.33	0.05	0.24	0.15	0.05	0.15	0.07
Crit Moves:	****					****	****			****		

Santa Ana Circulation Element

Level Of Service Computation Report

ICU 1(Loss as Cycle Length %) Method (Base Volume Alternative)

Intersection #40 Bristol St and Sunflower Ave

Cycle (sec): 100 Critical Vol./Cap.(X): 0.649
Loss Time (sec): 5 Average Delay (sec/veh): xxxxxx
Optimal Cycle: 32 Level Of Service: B

Table with 4 columns: North Bound, South Bound, East Bound, West Bound. Rows include Movement (L-T-R), Control (Protected), Rights (Include), Min. Green, Y+R, and Lanes.

Volume Module: Table with 12 columns representing different volume categories and their values.

Saturation Flow Module: Table with 12 columns representing saturation flow values for various lanes.

Capacity Analysis Module: Table with 12 columns representing capacity analysis values.

Santa Ana Circulation Element

Level Of Service Computation Report
 2000 HCM Operations Method (Base Volume Alternative)

 Intersection #41 Bristol St and I-405 NB Ramps

Cycle (sec): 100 Critical Vol./Cap.(X): 0.557
 Loss Time (sec): 5 Average Delay (sec/veh): 20.8
 Optimal Cycle: 28 Level Of Service: C

Approach:	North Bound			South Bound			East Bound			West Bound		
Movement:	L	T	R	L	T	R	L	T	R	L	T	R
Control:	Protected			Protected			Split Phase			Split Phase		
Rights:	Include			Include			Include			Ovl		
Min. Green:	0	0	0	0	0	0	0	0	0	0	0	0
Y+R:	4.0	4.0	4.0	4.0	4.0	4.0	4.0	4.0	4.0	4.0	4.0	4.0
Lanes:	0	0	4	0	0	4	0	0	0	1	1	0

Volume Module:	North Bound			South Bound			East Bound			West Bound		
Base Vol:	0	1638	210	0	1918	8	0	0	36	145	87	796
Growth Adj:	1.00	1.00	1.00	1.00	1.00	1.00	1.00	1.00	1.00	1.00	1.00	1.00
Initial Bse:	0	1638	210	0	1918	8	0	0	36	145	87	796
User Adj:	1.00	1.00	1.00	1.00	1.00	1.00	1.00	1.00	1.00	1.00	1.00	1.00
PHF Adj:	1.00	1.00	1.00	1.00	1.00	1.00	1.00	1.00	1.00	1.00	1.00	1.00
PHF Volume:	0	1638	210	0	1918	8	0	0	36	145	87	796
Reduct Vol:	0	0	0	0	0	0	0	0	0	0	0	0
Reduced Vol:	0	1638	210	0	1918	8	0	0	36	145	87	796
PCE Adj:	1.00	1.00	1.00	1.00	1.00	1.00	1.00	1.00	1.00	1.00	1.00	1.00
MLF Adj:	1.00	1.00	1.00	1.00	1.00	1.00	1.00	1.00	1.00	1.00	1.00	1.00
FinalVolume:	0	1638	210	0	1918	8	0	0	36	145	87	796

Saturation Flow Module:	North Bound			South Bound			East Bound			West Bound		
Sat/Lane:	1900	1900	1900	1900	1900	1900	1900	1900	1900	1900	1900	1900
Adjustment:	1.00	0.91	0.85	1.00	0.91	0.91	1.00	1.00	0.75	0.92	0.92	0.75
Lanes:	0.00	4.00	1.00	0.00	4.98	0.02	0.00	0.00	2.00	1.88	1.12	2.00
Final Sat.:	0	6916	1615	0	8600	36	0	0	2842	3283	1970	2842

Capacity Analysis Module:	North Bound			South Bound			East Bound			West Bound		
Vol/Sat:	0.00	0.24	0.13	0.00	0.22	0.22	0.00	0.00	0.01	0.04	0.04	0.28
Crit Moves:	****			****			****			****		
Green/Cycle:	0.00	0.42	0.42	0.00	0.42	0.42	0.00	0.00	0.02	0.50	0.50	0.50
Volume/Cap:	0.00	0.56	0.31	0.00	0.52	0.52	0.00	0.00	0.56	0.09	0.09	0.56
Delay/Veh:	0.0	21.9	19.3	0.0	21.4	21.4	0.0	0.0	58.8	13.0	13.0	17.7
User DelAdj:	1.00	1.00	1.00	1.00	1.00	1.00	1.00	1.00	1.00	1.00	1.00	1.00
AdjDel/Veh:	0.0	21.9	19.3	0.0	21.4	21.4	0.0	0.0	58.8	13.0	13.0	17.7
LOS by Move:	A	C	B	A	C	C	A	A	E	B	B	B
HCM2k85thQ:	0	16	7	0	15	15	0	0	2	2	2	15

 Note: Queue reported is the number of cars per lane.

Santa Ana Circulation Element

Level Of Service Computation Report
 2000 HCM Operations Method (Base Volume Alternative)

 Intersection #42 Bristol St and I-405 SB Ramps

Cycle (sec): 100 Critical Vol./Cap.(X): 0.696
 Loss Time (sec): 5 Average Delay (sec/veh): 23.9
 Optimal Cycle: 38 Level Of Service: C

Approach:	North Bound			South Bound			East Bound			West Bound		
Movement:	L	T	R	L	T	R	L	T	R	L	T	R
Control:	Protected			Protected			Split Phase			Split Phase		
Rights:	Include			Ignore			Include			Include		
Min. Green:	0	0	0	0	0	0	0	0	0	0	0	0
Y+R:	4.0	4.0	4.0	4.0	4.0	4.0	4.0	4.0	4.0	4.0	4.0	4.0
Lanes:	1	0	4	0	0	2	1	1	3	0	0	0

Volume Module:

Base Vol:	125	1225	0	0	1030	886	696	0	636	0	0	0
Growth Adj:	1.00	1.00	1.00	1.00	1.00	1.00	1.00	1.00	1.00	1.00	1.00	1.00
Initial Bse:	125	1225	0	0	1030	886	696	0	636	0	0	0
User Adj:	1.00	1.00	1.00	1.00	1.00	0.00	1.00	1.00	1.00	1.00	1.00	1.00
PHF Adj:	1.00	1.00	1.00	1.00	1.00	0.00	1.00	1.00	1.00	1.00	1.00	1.00
PHF Volume:	125	1225	0	0	1030	0	696	0	636	0	0	0
Reduct Vol:	0	0	0	0	0	0	0	0	0	0	0	0
Reduced Vol:	125	1225	0	0	1030	0	696	0	636	0	0	0
PCE Adj:	1.00	1.00	1.00	1.00	1.00	0.00	1.00	1.00	1.00	1.00	1.00	1.00
MLF Adj:	1.00	1.00	1.00	1.00	1.00	0.00	1.00	1.00	1.00	1.00	1.00	1.00
FinalVolume:	125	1225	0	0	1030	0	696	0	636	0	0	0

Saturation Flow Module:

Sat/Lane:	1900	1900	1900	1900	1900	1900	1900	1900	1900	1900	1900	1900
Adjustment:	0.95	0.91	1.00	1.00	0.91	0.91	0.92	1.00	0.85	1.00	1.00	1.00
Lanes:	1.00	4.00	0.00	0.00	3.00	1.00	3.00	0.00	1.00	0.00	0.00	0.00
Final Sat.:	1805	6916	0	0	5187	1729	5253	0	1615	0	0	0

Capacity Analysis Module:

Vol/Sat:	0.07	0.18	0.00	0.00	0.20	0.00	0.13	0.00	0.39	0.00	0.00	0.00
Crit Moves:	****			****					****			
Green/Cycle:	0.10	0.38	0.00	0.00	0.29	0.00	0.57	0.00	0.57	0.00	0.00	0.00
Volume/Cap:	0.70	0.46	0.00	0.00	0.70	0.00	0.23	0.00	0.70	0.00	0.00	0.00
Delay/Veh:	54.9	23.1	0.0	0.0	33.4	0.0	10.9	0.0	18.0	0.0	0.0	0.0
User DelAdj:	1.00	1.00	1.00	1.00	1.00	1.00	1.00	1.00	1.00	1.00	1.00	1.00
AdjDel/Veh:	54.9	23.1	0.0	0.0	33.4	0.0	10.9	0.0	18.0	0.0	0.0	0.0
LOS by Move:	D	C	A	A	C	A	B	A	B	A	A	A
HCM2k85thQ:	8	12	0	0	17	0	6	0	22	0	0	0

 Note: Queue reported is the number of cars per lane.

Santa Ana Circulation Element

Level Of Service Computation Report

ICU 1(Loss as Cycle Length %) Method (Base Volume Alternative)

Intersection #43 Flower St and Santa Ana Blvd

Cycle (sec): 100 Critical Vol./Cap.(X): 0.806
 Loss Time (sec): 5 Average Delay (sec/veh): xxxxxx
 Optimal Cycle: 53 Level Of Service: D

Approach:	North Bound			South Bound			East Bound			West Bound		
Movement:	L	T	R	L	T	R	L	T	R	L	T	R
Control:	Prot+Permit			Prot+Permit			Prot+Permit			Prot+Permit		
Rights:	Include			Include			Include			Include		
Min. Green:	0	0	0	0	0	0	0	0	0	0	0	0
Y+R:	4.0	4.0	4.0	4.0	4.0	4.0	4.0	4.0	4.0	4.0	4.0	4.0
Lanes:	1	0	2	0	1	1	1	0	3	0	1	1

Volume Module:

Base Vol:	100	936	136	214	723	97	211	1315	150	143	458	191
Growth Adj:	1.00	1.00	1.00	1.00	1.00	1.00	1.00	1.00	1.00	1.00	1.00	1.00
Initial Bse:	100	936	136	214	723	97	211	1315	150	143	458	191
User Adj:	1.00	1.00	1.00	1.00	1.00	1.00	1.00	1.00	1.00	1.00	1.00	1.00
PHF Adj:	1.00	1.00	1.00	1.00	1.00	1.00	1.00	1.00	1.00	1.00	1.00	1.00
PHF Volume:	100	936	136	214	723	97	211	1315	150	143	458	191
Reduct Vol:	0	0	0	0	0	0	0	0	0	0	0	0
Reduced Vol:	100	936	136	214	723	97	211	1315	150	143	458	191
PCE Adj:	1.00	1.00	1.00	1.00	1.00	1.00	1.00	1.00	1.00	1.00	1.00	1.00
MLF Adj:	1.00	1.00	1.00	1.00	1.00	1.00	1.00	1.00	1.00	1.00	1.00	1.00
FinalVolume:	100	936	136	214	723	97	211	1315	150	143	458	191

Saturation Flow Module:

Sat/Lane:	1600	1600	1600	1600	1600	1600	1600	1600	1600	1600	1600	1600
Adjustment:	1.00	1.06	1.00	1.00	1.06	1.00	1.00	1.06	1.00	1.00	1.06	1.00
Lanes:	1.00	2.00	1.00	1.00	2.00	1.00	1.00	3.00	1.00	1.00	2.12	0.88
Final Sat.:	1600	3400	1600	1600	3400	1600	1600	5100	1600	1600	3587	1413

Capacity Analysis Module:

Vol/Sat:	0.06	0.28	0.09	0.13	0.21	0.06	0.13	0.26	0.09	0.09	0.13	0.14
Crit Moves:	****			****			****			****		

Santa Ana Circulation Element

Level Of Service Computation Report

ICU 1(Loss as Cycle Length %) Method (Base Volume Alternative)

Intersection #44 Flower St and 1st St

Cycle (sec): 100 Critical Vol./Cap.(X): 0.926
 Loss Time (sec): 5 Average Delay (sec/veh): xxxxxx
 Optimal Cycle: 105 Level Of Service: E

Approach:	North Bound			South Bound			East Bound			West Bound		
Movement:	L	T	R	L	T	R	L	T	R	L	T	R
Control:	Protected			Protected			Protected			Protected		
Rights:	Include			Include			Include			Include		
Min. Green:	0	0	0	0	0	0	0	0	0	0	0	0
Y+R:	4.0	4.0	4.0	4.0	4.0	4.0	4.0	4.0	4.0	4.0	4.0	4.0
Lanes:	1	0	2	0	1	1	0	1	0	1	0	2

Volume Module:

Base Vol:	139	602	159	334	1058	111	148	1355	54	209	861	123
Growth Adj:	1.00	1.00	1.00	1.00	1.00	1.00	1.00	1.00	1.00	1.00	1.00	1.00
Initial Bse:	139	602	159	334	1058	111	148	1355	54	209	861	123
User Adj:	1.00	1.00	1.00	1.00	1.00	1.00	1.00	1.00	1.00	1.00	1.00	1.00
PHF Adj:	1.00	1.00	1.00	1.00	1.00	1.00	1.00	1.00	1.00	1.00	1.00	1.00
PHF Volume:	139	602	159	334	1058	111	148	1355	54	209	861	123
Reduct Vol:	0	0	0	0	0	0	0	0	0	0	0	0
Reduced Vol:	139	602	159	334	1058	111	148	1355	54	209	861	123
PCE Adj:	1.00	1.00	1.00	1.00	1.00	1.00	1.00	1.00	1.00	1.00	1.00	1.00
MLF Adj:	1.00	1.00	1.00	1.00	1.00	1.00	1.00	1.00	1.00	1.00	1.00	1.00
FinalVolume:	139	602	159	334	1058	111	148	1355	54	209	861	123

Saturation Flow Module:

Sat/Lane:	1600	1600	1600	1600	1600	1600	1600	1600	1600	1600	1600	1600
Adjustment:	1.00	1.06	1.00	1.00	1.03	1.00	1.00	1.04	1.00	1.00	1.05	1.00
Lanes:	1.00	2.00	1.00	1.00	1.81	0.19	1.00	2.89	0.11	1.00	2.62	0.38
Final Sat.:	1600	3400	1600	1600	2996	304	1600	4816	184	1600	4400	600

Capacity Analysis Module:

Vol/Sat:	0.09	0.18	0.10	0.21	0.35	0.37	0.09	0.28	0.29	0.13	0.20	0.21
Crit Moves:	****					****			****	****		

Santa Ana Circulation Element

Level Of Service Computation Report

ICU 1(Loss as Cycle Length %) Method (Base Volume Alternative)

Intersection #45 Flower St and McFadden Ave

Cycle (sec): 100 Critical Vol./Cap.(X): 0.900
Loss Time (sec): 5 Average Delay (sec/veh): xxxxxx
Optimal Cycle: 87 Level Of Service: E

Table with 4 columns: North Bound, South Bound, East Bound, West Bound. Rows include Movement, Control, Rights, Min. Green, Y+R, and Lanes.

Volume Module: Table with 12 columns representing different volume categories and their values.

Saturation Flow Module: Table with 12 columns representing saturation flow values.

Capacity Analysis Module: Table with 12 columns representing capacity analysis values.

Santa Ana Circulation Element

Level Of Service Computation Report

ICU 1(Loss as Cycle Length %) Method (Base Volume Alternative)

Intersection #46 Flower St and Segerstrom Ave

Cycle (sec): 100 Critical Vol./Cap.(X): 0.784
 Loss Time (sec): 5 Average Delay (sec/veh): xxxxxx
 Optimal Cycle: 49 Level Of Service: C

Approach:	North Bound			South Bound			East Bound			West Bound		
Movement:	L	T	R	L	T	R	L	T	R	L	T	R
Control:	Permitted			Permitted			Protected			Protected		
Rights:	Include			Include			Include			Include		
Min. Green:	0	0	0	0	0	0	0	0	0	0	0	0
Y+R:	4.0	4.0	4.0	4.0	4.0	4.0	4.0	4.0	4.0	4.0	4.0	4.0
Lanes:	1	0	1	1	0	1	2	1	0	1	0	2

Volume Module:

Base Vol:	86	451	100	98	544	120	223	1531	427	104	764	84
Growth Adj:	1.00	1.00	1.00	1.00	1.00	1.00	1.00	1.00	1.00	1.00	1.00	1.00
Initial Bse:	86	451	100	98	544	120	223	1531	427	104	764	84
User Adj:	1.00	1.00	1.00	1.00	1.00	1.00	1.00	1.00	1.00	1.00	1.00	1.00
PHF Adj:	1.00	1.00	1.00	1.00	1.00	1.00	1.00	1.00	1.00	1.00	1.00	1.00
PHF Volume:	86	451	100	98	544	120	223	1531	427	104	764	84
Reduct Vol:	0	0	0	0	0	0	0	0	0	0	0	0
Reduced Vol:	86	451	100	98	544	120	223	1531	427	104	764	84
PCE Adj:	1.00	1.00	1.00	1.00	1.00	1.00	1.00	1.00	1.00	1.00	1.00	1.00
MLF Adj:	1.00	1.00	1.00	1.00	1.00	1.00	1.00	1.00	1.00	1.00	1.00	1.00
FinalVolume:	86	451	100	98	544	120	223	1531	427	104	764	84

Saturation Flow Module:

Sat/Lane:	1600	1600	1600	1600	1600	1600	1600	1600	1600	1600	1600	1600
Adjustment:	1.00	1.04	1.00	1.00	1.04	1.00	1.00	1.05	1.00	1.00	1.05	1.00
Lanes:	1.00	1.64	0.36	1.00	1.64	0.36	1.00	2.35	0.65	1.00	2.70	0.30
Final Sat.:	1600	2719	581	1600	2722	578	1600	3953	1047	1600	4525	475

Capacity Analysis Module:

Vol/Sat:	0.05	0.17	0.17	0.06	0.20	0.21	0.14	0.39	0.41	0.07	0.17	0.18
Crit Moves:	****					****			****	****		

Santa Ana Circulation Element

Level Of Service Computation Report

ICU 1(Loss as Cycle Length %) Method (Base Volume Alternative)

Intersection #47 Flower St and MacArthur Blvd

Cycle (sec): 100 Critical Vol./Cap.(X): 0.675
Loss Time (sec): 5 Average Delay (sec/veh): xxxxxx
Optimal Cycle: 35 Level Of Service: B

Table with 4 columns: North Bound, South Bound, East Bound, West Bound. Rows include Movement (L-T-R), Control, Rights, Min. Green, Y+R, and Lanes.

Volume Module table with 12 columns representing different traffic volumes and adjustment factors like Growth Adj, Initial Bse, User Adj, PHF Adj, etc.

Saturation Flow Module table with 12 columns for Sat/Lane, Adjustment, Lanes, and Final Sat.

Capacity Analysis Module table with 12 columns for Vol/Sat and Crit Moves.

Santa Ana Circulation Element

Level Of Service Computation Report

ICU 1(Loss as Cycle Length %) Method (Base Volume Alternative)

Intersection #48 Main St and La Veta Ave

Cycle (sec): 100 Critical Vol./Cap.(X): 0.586
 Loss Time (sec): 5 Average Delay (sec/veh): xxxxxx
 Optimal Cycle: 28 Level Of Service: A

Approach:	North Bound			South Bound			East Bound			West Bound		
Movement:	L	T	R	L	T	R	L	T	R	L	T	R
Control:	Protected			Protected			Protected			Protected		
Rights:	Ovl			Include			Include			Ovl		
Min. Green:	0	0	0	0	0	0	0	0	0	0	0	0
Y+R:	4.0	4.0	4.0	4.0	4.0	4.0	4.0	4.0	4.0	4.0	4.0	4.0
Lanes:	2	0	3	0	1	0	2	0	2	1	0	1

Volume Module:

Base Vol:	105	724	375	198	1034	173	361	510	222	316	276	230
Growth Adj:	1.00	1.00	1.00	1.00	1.00	1.00	1.00	1.00	1.00	1.00	1.00	1.00
Initial Bse:	105	724	375	198	1034	173	361	510	222	316	276	230
User Adj:	1.00	1.00	1.00	1.00	1.00	1.00	1.00	1.00	1.00	1.00	1.00	1.00
PHF Adj:	1.00	1.00	1.00	1.00	1.00	1.00	1.00	1.00	1.00	1.00	1.00	1.00
PHF Volume:	105	724	375	198	1034	173	361	510	222	316	276	230
Reduct Vol:	0	0	0	0	0	0	0	0	0	0	0	0
Reduced Vol:	105	724	375	198	1034	173	361	510	222	316	276	230
PCE Adj:	1.00	1.00	1.00	1.00	1.00	1.00	1.00	1.00	1.00	1.00	1.00	1.00
MLF Adj:	1.00	1.00	1.00	1.00	1.00	1.00	1.00	1.00	1.00	1.00	1.00	1.00
FinalVolume:	105	724	375	198	1034	173	361	510	222	316	276	230
OvlAdjVol:	217									131		

Saturation Flow Module:

Sat/Lane:	1600	1600	1600	1600	1600	1600	1600	1600	1600	1600	1600	1600
Adjustment:	1.00	1.06	1.00	1.00	1.05	1.00	1.00	1.06	1.00	1.00	1.06	1.00
Lanes:	2.00	3.00	1.00	2.00	2.57	0.43	2.00	2.09	0.91	2.00	2.00	1.00
Final Sat.:	3200	5100	1600	3200	4312	688	3200	3544	1456	3200	3400	1600

Capacity Analysis Module:

Vol/Sat:	0.03	0.14	0.23	0.06	0.24	0.25	0.11	0.14	0.15	0.10	0.08	0.14
OvlAdjV/S:	0.14									0.08		
Crit Moves:	****			****			****			****		

Santa Ana Circulation Element

Level Of Service Computation Report

ICU 1(Loss as Cycle Length %) Method (Base Volume Alternative)

Intersection #49 Main St and Mainplace Dr / Memory Ln

Cycle (sec): 100 Critical Vol./Cap.(X): 0.512
 Loss Time (sec): 5 Average Delay (sec/veh): xxxxxx
 Optimal Cycle: 24 Level Of Service: A

Approach:	North Bound			South Bound			East Bound			West Bound		
Movement:	L	T	R	L	T	R	L	T	R	L	T	R
Control:	Protected			Protected			Protected			Protected		
Rights:	Include			Include			Include			Include		
Min. Green:	0	0	0	0	0	0	0	0	0	0	0	0
Y+R:	4.0	4.0	4.0	4.0	4.0	4.0	4.0	4.0	4.0	4.0	4.0	4.0
Lanes:	2	0	2	1	0	0	2	0	2	1	0	1

Volume Module:

Base Vol:	34	920	301	36	1386	290	185	291	20	132	151	10
Growth Adj:	1.00	1.00	1.00	1.00	1.00	1.00	1.00	1.00	1.00	1.00	1.00	1.00
Initial Bse:	34	920	301	36	1386	290	185	291	20	132	151	10
User Adj:	1.00	1.00	1.00	1.00	1.00	1.00	1.00	1.00	1.00	1.00	1.00	1.00
PHF Adj:	1.00	1.00	1.00	1.00	1.00	1.00	1.00	1.00	1.00	1.00	1.00	1.00
PHF Volume:	34	920	301	36	1386	290	185	291	20	132	151	10
Reduct Vol:	0	0	0	0	0	0	0	0	0	0	0	0
Reduced Vol:	34	920	301	36	1386	290	185	291	20	132	151	10
PCE Adj:	1.00	1.00	1.00	1.00	1.00	1.00	1.00	1.00	1.00	1.00	1.00	1.00
MLF Adj:	1.00	1.00	1.00	1.00	1.00	1.00	1.00	1.00	1.00	1.00	1.00	1.00
FinalVolume:	34	920	301	36	1386	290	185	291	20	132	151	10

Saturation Flow Module:

Sat/Lane:	1600	1600	1600	1600	1600	1600	1600	1600	1600	1600	1600	1600
Adjustment:	1.00	1.06	1.00	1.00	1.05	1.00	1.00	1.04	1.00	1.00	1.06	1.00
Lanes:	2.00	2.26	0.74	2.00	2.48	0.52	2.00	2.81	0.19	2.00	2.00	1.00
Final Sat.:	3200	3817	1183	3200	4169	831	3200	4691	309	3200	3400	1600

Capacity Analysis Module:

Vol/Sat:	0.01	0.24	0.25	0.01	0.33	0.35	0.06	0.06	0.06	0.04	0.04	0.01
Crit Moves:	****					****	****				****	

Santa Ana Circulation Element

Level Of Service Computation Report

ICU 1(Loss as Cycle Length %) Method (Base Volume Alternative)

Intersection #50 Main St and 17th St

Cycle (sec): 100 Critical Vol./Cap.(X): 0.884
 Loss Time (sec): 5 Average Delay (sec/veh): xxxxxx
 Optimal Cycle: 78 Level Of Service: D

Approach:	North Bound			South Bound			East Bound			West Bound		
Movement:	L	T	R	L	T	R	L	T	R	L	T	R
Control:	Protected			Protected			Protected			Protected		
Rights:	Include			Include			Include			Include		
Min. Green:	0	0	0	0	0	0	0	0	0	0	0	0
Y+R:	4.0	4.0	4.0	4.0	4.0	4.0	4.0	4.0	4.0	4.0	4.0	4.0
Lanes:	2	0	2	0	2	1	2	0	2	1	0	2

Volume Module:

Base Vol:	133	788	169	237	1322	85	127	1336	67	356	1425	21
Growth Adj:	1.00	1.00	1.00	1.00	1.00	1.00	1.00	1.00	1.00	1.00	1.00	1.00
Initial Bse:	133	788	169	237	1322	85	127	1336	67	356	1425	21
User Adj:	1.00	1.00	1.00	1.00	1.00	1.00	1.00	1.00	1.00	1.00	1.00	1.00
PHF Adj:	1.00	1.00	1.00	1.00	1.00	1.00	1.00	1.00	1.00	1.00	1.00	1.00
PHF Volume:	133	788	169	237	1322	85	127	1336	67	356	1425	21
Reduct Vol:	0	0	0	0	0	0	0	0	0	0	0	0
Reduced Vol:	133	788	169	237	1322	85	127	1336	67	356	1425	21
PCE Adj:	1.00	1.00	1.00	1.00	1.00	1.00	1.00	1.00	1.00	1.00	1.00	1.00
MLF Adj:	1.00	1.00	1.00	1.00	1.00	1.00	1.00	1.00	1.00	1.00	1.00	1.00
FinalVolume:	133	788	169	237	1322	85	127	1336	67	356	1425	21

Saturation Flow Module:

Sat/Lane:	1600	1600	1600	1600	1600	1600	1600	1600	1600	1600	1600	1600
Adjustment:	1.00	1.06	1.00	1.00	1.06	1.00	1.00	1.04	1.00	1.00	1.04	1.00
Lanes:	2.00	2.00	1.00	2.00	2.00	1.00	2.00	2.86	0.14	2.00	2.96	0.04
Final Sat.:	3200	3400	1600	3200	3400	1600	3200	4771	229	3200	4930	70

Capacity Analysis Module:

Vol/Sat:	0.04	0.23	0.11	0.07	0.39	0.05	0.04	0.28	0.29	0.11	0.29	0.30
Crit Moves:	****			****			****		****	****		

Santa Ana Circulation Element

Level Of Service Computation Report

ICU 1(Loss as Cycle Length %) Method (Base Volume Alternative)

Intersection #51 Main St and Civic Center Dr

Cycle (sec): 100 Critical Vol./Cap.(X): 0.783
 Loss Time (sec): 5 Average Delay (sec/veh): xxxxxx
 Optimal Cycle: 49 Level Of Service: C

Approach:	North Bound			South Bound			East Bound			West Bound		
Movement:	L	T	R	L	T	R	L	T	R	L	T	R
Control:	Permitted			Permitted			Permitted			Permitted		
Rights:	Include			Include			Include			Include		
Min. Green:	0	0	0	0	0	0	0	0	0	0	0	0
Y+R:	4.0	4.0	4.0	4.0	4.0	4.0	4.0	4.0	4.0	4.0	4.0	4.0
Lanes:	1	0	1	1	0	1	1	0	1	1	0	1

Volume Module:

Base Vol:	142	925	81	55	970	148	120	727	132	43	566	34
Growth Adj:	1.00	1.00	1.00	1.00	1.00	1.00	1.00	1.00	1.00	1.00	1.00	1.00
Initial Bse:	142	925	81	55	970	148	120	727	132	43	566	34
User Adj:	1.00	1.00	1.00	1.00	1.00	1.00	1.00	1.00	1.00	1.00	1.00	1.00
PHF Adj:	1.00	1.00	1.00	1.00	1.00	1.00	1.00	1.00	1.00	1.00	1.00	1.00
PHF Volume:	142	925	81	55	970	148	120	727	132	43	566	34
Reduct Vol:	0	0	0	0	0	0	0	0	0	0	0	0
Reduced Vol:	142	925	81	55	970	148	120	727	132	43	566	34
PCE Adj:	1.00	1.00	1.00	1.00	1.00	1.00	1.00	1.00	1.00	1.00	1.00	1.00
MLF Adj:	1.00	1.00	1.00	1.00	1.00	1.00	1.00	1.00	1.00	1.00	1.00	1.00
FinalVolume:	142	925	81	55	970	148	120	727	132	43	566	34

Saturation Flow Module:

Sat/Lane:	1600	1600	1600	1600	1600	1600	1600	1600	1600	1600	1600	1600
Adjustment:	1.00	1.03	1.00	1.00	1.04	1.00	1.00	1.04	1.00	1.00	1.03	1.00
Lanes:	1.00	1.84	0.16	1.00	1.74	0.26	1.00	1.69	0.31	1.00	1.89	0.11
Final Sat.:	1600	3042	258	1600	2876	424	1600	2808	492	1600	3119	181

Capacity Analysis Module:

Vol/Sat:	0.09	0.30	0.31	0.03	0.34	0.35	0.08	0.26	0.27	0.03	0.18	0.19
Crit Moves:	****					****			****	****		

Santa Ana Circulation Element

Level Of Service Computation Report

ICU 1(Loss as Cycle Length %) Method (Base Volume Alternative)

Intersection #52 Main St and Santa Ana Blvd

Cycle (sec): 100 Critical Vol./Cap.(X): 0.926
 Loss Time (sec): 5 Average Delay (sec/veh): xxxxxx
 Optimal Cycle: 105 Level Of Service: E

Approach:	North Bound			South Bound			East Bound			West Bound		
Movement:	L	T	R	L	T	R	L	T	R	L	T	R
Control:	Permitted			Permitted			Permitted			Permitted		
Rights:	Include			Include			Include			Include		
Min. Green:	0	0	0	0	0	0	0	0	0	0	0	0
Y+R:	4.0	4.0	4.0	4.0	4.0	4.0	4.0	4.0	4.0	4.0	4.0	4.0
Lanes:	1	0	2	0	0	1	0	0	0	0	1	0

Volume Module:

Base Vol:	66	1050	0	0	1135	100	0	0	0	90	1250	96
Growth Adj:	1.00	1.00	1.00	1.00	1.00	1.00	1.00	1.00	1.00	1.00	1.00	1.00
Initial Bse:	66	1050	0	0	1135	100	0	0	0	90	1250	96
User Adj:	1.00	1.00	1.00	1.00	1.00	1.00	1.00	1.00	1.00	1.00	1.00	1.00
PHF Adj:	1.00	1.00	1.00	1.00	1.00	1.00	1.00	1.00	1.00	1.00	1.00	1.00
PHF Volume:	66	1050	0	0	1135	100	0	0	0	90	1250	96
Reduct Vol:	0	0	0	0	0	0	0	0	0	0	0	0
Reduced Vol:	66	1050	0	0	1135	100	0	0	0	90	1250	96
PCE Adj:	1.00	1.00	1.00	1.00	1.00	1.00	1.00	1.00	1.00	1.00	1.00	1.00
MLF Adj:	1.00	1.00	1.00	1.00	1.00	1.00	1.00	1.00	1.00	1.00	1.00	1.00
FinalVolume:	66	1050	0	0	1135	100	0	0	0	90	1250	96

Saturation Flow Module:

Sat/Lane:	1600	1600	1600	1600	1600	1600	1600	1600	1600	1600	1600	1600
Adjustment:	1.00	1.06	1.00	1.00	1.03	1.00	1.00	1.06	1.00	1.00	1.00	1.00
Lanes:	1.00	2.00	0.00	0.00	1.84	0.16	0.00	0.00	0.00	0.13	1.74	0.13
Final Sat.:	1600	3400	0	0	3041	259	0	0	0	201	2786	214

Capacity Analysis Module:

Vol/Sat:	0.04	0.31	0.00	0.00	0.37	0.39	0.00	0.00	0.00	0.06	0.45	0.45
Crit Moves:	****					****					****	

Santa Ana Circulation Element

Level Of Service Computation Report

ICU 1(Loss as Cycle Length %) Method (Base Volume Alternative)

Intersection #53 Main St and 4th St

Cycle (sec): 100 Critical Vol./Cap.(X): 0.410
Loss Time (sec): 5 Average Delay (sec/veh): xxxxxx
Optimal Cycle: 20 Level Of Service: A

Table with 4 columns: North Bound, South Bound, East Bound, West Bound. Rows include Movement (L-T-R), Control (Permitted), Rights (Include), Min. Green, Y+R, and Lanes.

Volume Module: Table with 12 columns representing different volume categories and their values across the four directions.

Saturation Flow Module: Table with 12 columns representing saturation flow values and adjustment factors.

Capacity Analysis Module: Table with 12 columns representing capacity analysis metrics like Vol/Sat and Crit Moves.

Santa Ana Circulation Element

Level Of Service Computation Report

ICU 1(Loss as Cycle Length %) Method (Base Volume Alternative)

Intersection #54 Main St and 1st St

Cycle (sec): 100 Critical Vol./Cap.(X): 0.681
 Loss Time (sec): 5 Average Delay (sec/veh): xxxxxx
 Optimal Cycle: 35 Level Of Service: B

Approach:	North Bound			South Bound			East Bound			West Bound		
Movement:	L	T	R	L	T	R	L	T	R	L	T	R
Control:	Protected			Protected			Protected			Protected		
Rights:	Include			Include			Include			Include		
Min. Green:	0	0	0	0	0	0	0	0	0	0	0	0
Y+R:	4.0	4.0	4.0	4.0	4.0	4.0	4.0	4.0	4.0	4.0	4.0	4.0
Lanes:	1	0	1	1	0	1	1	0	1	1	0	1

Volume Module:

Base Vol:	103	532	54	77	772	57	106	1241	131	86	1072	60
Growth Adj:	1.00	1.00	1.00	1.00	1.00	1.00	1.00	1.00	1.00	1.00	1.00	1.00
Initial Bse:	103	532	54	77	772	57	106	1241	131	86	1072	60
User Adj:	1.00	1.00	1.00	1.00	1.00	1.00	1.00	1.00	1.00	1.00	1.00	1.00
PHF Adj:	1.00	1.00	1.00	1.00	1.00	1.00	1.00	1.00	1.00	1.00	1.00	1.00
PHF Volume:	103	532	54	77	772	57	106	1241	131	86	1072	60
Reduct Vol:	0	0	0	0	0	0	0	0	0	0	0	0
Reduced Vol:	103	532	54	77	772	57	106	1241	131	86	1072	60
PCE Adj:	1.00	1.00	1.00	1.00	1.00	1.00	1.00	1.00	1.00	1.00	1.00	1.00
MLF Adj:	1.00	1.00	1.00	1.00	1.00	1.00	1.00	1.00	1.00	1.00	1.00	1.00
FinalVolume:	103	532	54	77	772	57	106	1241	131	86	1072	60

Saturation Flow Module:

Sat/Lane:	1600	1600	1600	1600	1600	1600	1600	1600	1600	1600	1600	1600
Adjustment:	1.00	1.03	1.00	1.00	1.06	1.00	1.00	1.05	1.00	1.00	1.04	1.00
Lanes:	1.00	1.82	0.18	1.00	2.00	1.00	1.00	2.71	0.29	1.00	2.84	0.16
Final Sat.:	1600	3005	295	1600	3400	1600	1600	4542	458	1600	4746	254

Capacity Analysis Module:

Vol/Sat:	0.06	0.18	0.18	0.05	0.23	0.04	0.07	0.27	0.29	0.05	0.23	0.24
Crit Moves:	****			****			****		****	****		

Santa Ana Circulation Element

Level Of Service Computation Report

ICU 1(Loss as Cycle Length %) Method (Base Volume Alternative)

Intersection #55 Main St and McFadden Ave

Cycle (sec): 100 Critical Vol./Cap.(X): 0.894
 Loss Time (sec): 5 Average Delay (sec/veh): xxxxxx
 Optimal Cycle: 84 Level Of Service: D

Approach:	North Bound			South Bound			East Bound			West Bound		
Movement:	L	T	R	L	T	R	L	T	R	L	T	R
Control:	Prot+Permit			Prot+Permit			Protected			Protected		
Rights:	Include			Include			Include			Include		
Min. Green:	0	0	0	0	0	0	0	0	0	0	0	0
Y+R:	4.0	4.0	4.0	4.0	4.0	4.0	4.0	4.0	4.0	4.0	4.0	4.0
Lanes:	1	0	1	1	0	1	1	0	1	1	0	1

Volume Module:

Base Vol:	93	874	44	162	1259	25	86	815	89	164	438	126
Growth Adj:	1.00	1.00	1.00	1.00	1.00	1.00	1.00	1.00	1.00	1.00	1.00	1.00
Initial Bse:	93	874	44	162	1259	25	86	815	89	164	438	126
User Adj:	1.00	1.00	1.00	1.00	1.00	1.00	1.00	1.00	1.00	1.00	1.00	1.00
PHF Adj:	1.00	1.00	1.00	1.00	1.00	1.00	1.00	1.00	1.00	1.00	1.00	1.00
PHF Volume:	93	874	44	162	1259	25	86	815	89	164	438	126
Reduct Vol:	0	0	0	0	0	0	0	0	0	0	0	0
Reduced Vol:	93	874	44	162	1259	25	86	815	89	164	438	126
PCE Adj:	1.00	1.00	1.00	1.00	1.00	1.00	1.00	1.00	1.00	1.00	1.00	1.00
MLF Adj:	1.00	1.00	1.00	1.00	1.00	1.00	1.00	1.00	1.00	1.00	1.00	1.00
FinalVolume:	93	874	44	162	1259	25	86	815	89	164	438	126

Saturation Flow Module:

Sat/Lane:	1600	1600	1600	1600	1600	1600	1600	1600	1600	1600	1600	1600
Adjustment:	1.00	1.03	1.00	1.00	1.03	1.00	1.00	1.03	1.00	1.00	1.04	1.00
Lanes:	1.00	1.90	0.10	1.00	1.96	0.04	1.00	1.80	0.20	1.00	1.55	0.45
Final Sat.:	1600	3147	153	1600	3238	62	1600	2985	315	1600	2585	715

Capacity Analysis Module:

Vol/Sat:	0.06	0.28	0.29	0.10	0.39	0.40	0.05	0.27	0.28	0.10	0.17	0.18
Crit Moves:	****					****			****	****		

Santa Ana Circulation Element

Level Of Service Computation Report

ICU 1(Loss as Cycle Length %) Method (Base Volume Alternative)

Intersection #56 Main St and Edinger Ave

Cycle (sec): 100 Critical Vol./Cap.(X): 0.795
 Loss Time (sec): 5 Average Delay (sec/veh): xxxxxx
 Optimal Cycle: 51 Level Of Service: C

Approach:	North Bound			South Bound			East Bound			West Bound		
Movement:	L	T	R	L	T	R	L	T	R	L	T	R
Control:	Protected			Protected			Protected			Protected		
Rights:	Include			Include			Include			Include		
Min. Green:	0	0	0	0	0	0	0	0	0	0	0	0
Y+R:	4.0	4.0	4.0	4.0	4.0	4.0	4.0	4.0	4.0	4.0	4.0	4.0
Lanes:	1	0	1	1	0	1	1	0	2	1	0	2

Volume Module:

Base Vol:	99	561	61	211	975	51	96	1248	168	108	630	77
Growth Adj:	1.00	1.00	1.00	1.00	1.00	1.00	1.00	1.00	1.00	1.00	1.00	1.00
Initial Bse:	99	561	61	211	975	51	96	1248	168	108	630	77
User Adj:	1.00	1.00	1.00	1.00	1.00	1.00	1.00	1.00	1.00	1.00	1.00	1.00
PHF Adj:	1.00	1.00	1.00	1.00	1.00	1.00	1.00	1.00	1.00	1.00	1.00	1.00
PHF Volume:	99	561	61	211	975	51	96	1248	168	108	630	77
Reduct Vol:	0	0	0	0	0	0	0	0	0	0	0	0
Reduced Vol:	99	561	61	211	975	51	96	1248	168	108	630	77
PCE Adj:	1.00	1.00	1.00	1.00	1.00	1.00	1.00	1.00	1.00	1.00	1.00	1.00
MLF Adj:	1.00	1.00	1.00	1.00	1.00	1.00	1.00	1.00	1.00	1.00	1.00	1.00
FinalVolume:	99	561	61	211	975	51	96	1248	168	108	630	77

Saturation Flow Module:

Sat/Lane:	1600	1600	1600	1600	1600	1600	1600	1600	1600	1600	1600	1600
Adjustment:	1.00	1.03	1.00	1.00	1.03	1.00	1.00	1.05	1.00	1.00	1.05	1.00
Lanes:	1.00	1.80	0.20	1.00	1.90	0.10	1.00	2.64	0.36	1.00	2.67	0.33
Final Sat.:	1600	2986	314	1600	3141	159	1600	4431	569	1600	4477	523

Capacity Analysis Module:

Vol/Sat:	0.06	0.19	0.19	0.13	0.31	0.32	0.06	0.28	0.29	0.07	0.14	0.15
Crit Moves:	****					****			****	****		

Santa Ana Circulation Element

Level Of Service Computation Report

ICU 1(Loss as Cycle Length %) Method (Base Volume Alternative)

Intersection #57 Main St and MacArthur Blvd

Cycle (sec): 100 Critical Vol./Cap.(X): 0.680
 Loss Time (sec): 5 Average Delay (sec/veh): xxxxxx
 Optimal Cycle: 35 Level Of Service: B

Approach:	North Bound			South Bound			East Bound			West Bound		
Movement:	L	T	R	L	T	R	L	T	R	L	T	R
Control:	Protected			Protected			Protected			Protected		
Rights:	Include			Include			Include			Include		
Min. Green:	0	0	0	0	0	0	0	0	0	0	0	0
Y+R:	4.0	4.0	4.0	4.0	4.0	4.0	4.0	4.0	4.0	4.0	4.0	4.0
Lanes:	2	0	3	0	1		2	0	3	0	1	

Volume Module:

Base Vol:	51	295	250	539	709	160	230	1336	242	138	411	206
Growth Adj:	1.00	1.00	1.00	1.00	1.00	1.00	1.00	1.00	1.00	1.00	1.00	1.00
Initial Bse:	51	295	250	539	709	160	230	1336	242	138	411	206
User Adj:	1.00	1.00	1.00	1.00	1.00	1.00	1.00	1.00	1.00	1.00	1.00	1.00
PHF Adj:	1.00	1.00	1.00	1.00	1.00	1.00	1.00	1.00	1.00	1.00	1.00	1.00
PHF Volume:	51	295	250	539	709	160	230	1336	242	138	411	206
Reduct Vol:	0	0	0	0	0	0	0	0	0	0	0	0
Reduced Vol:	51	295	250	539	709	160	230	1336	242	138	411	206
PCE Adj:	1.00	1.00	1.00	1.00	1.00	1.00	1.00	1.00	1.00	1.00	1.00	1.00
MLF Adj:	1.00	1.00	1.00	1.00	1.00	1.00	1.00	1.00	1.00	1.00	1.00	1.00
FinalVolume:	51	295	250	539	709	160	230	1336	242	138	411	206

Saturation Flow Module:

Sat/Lane:	1600	1600	1600	1600	1600	1600	1600	1600	1600	1600	1600	1600
Adjustment:	1.00	1.06	1.00	1.00	1.06	1.00	1.00	1.06	1.00	1.00	1.06	1.00
Lanes:	2.00	3.00	1.00	2.00	3.00	1.00	2.00	3.00	1.00	2.00	3.00	1.00
Final Sat.:	3200	5100	1600	3200	5100	1600	3200	5100	1600	3200	5100	1600

Capacity Analysis Module:

Vol/Sat:	0.02	0.06	0.16	0.17	0.14	0.10	0.07	0.26	0.15	0.04	0.08	0.13
Crit Moves:			****	****			****			****		

Santa Ana Circulation Element

Level Of Service Computation Report
 2000 HCM Operations Method (Base Volume Alternative)

 Intersection #58 Penn Wy and 17th St

Cycle (sec): 100 Critical Vol./Cap.(X): 0.660
 Loss Time (sec): 5 Average Delay (sec/veh): 12.2
 Optimal Cycle: 35 Level Of Service: B

Approach:	North Bound			South Bound			East Bound			West Bound		
Movement:	L	T	R	L	T	R	L	T	R	L	T	R
Control:	Split Phase			Split Phase			Protected			Protected		
Rights:	Include			Include			Include			Include		
Min. Green:	0	0	0	0	0	0	0	0	0	0	0	0
Y+R:	4.0	4.0	4.0	4.0	4.0	4.0	4.0	4.0	4.0	4.0	4.0	4.0
Lanes:	2	0	0	0	0	0	2	1	0	1	0	0

Volume Module:

Base Vol:	52	0	260	0	0	0	0	1341	684	214	1722	0
Growth Adj:	1.00	1.00	1.00	1.00	1.00	1.00	1.00	1.00	1.00	1.00	1.00	1.00
Initial Bse:	52	0	260	0	0	0	0	1341	684	214	1722	0
User Adj:	1.00	1.00	1.00	1.00	1.00	1.00	1.00	1.00	1.00	1.00	1.00	1.00
PHF Adj:	1.00	1.00	1.00	1.00	1.00	1.00	1.00	1.00	1.00	1.00	1.00	1.00
PHF Volume:	52	0	260	0	0	0	0	1341	684	214	1722	0
Reduct Vol:	0	0	0	0	0	0	0	0	0	0	0	0
Reduced Vol:	52	0	260	0	0	0	0	1341	684	214	1722	0
PCE Adj:	1.00	1.00	1.00	1.00	1.00	1.00	1.00	1.00	1.00	1.00	1.00	1.00
MLF Adj:	1.00	1.00	1.00	1.00	1.00	1.00	1.00	1.00	1.00	1.00	1.00	1.00
FinalVolume:	52	0	260	0	0	0	0	1341	684	214	1722	0

Saturation Flow Module:

Sat/Lane:	1900	1900	1900	1900	1900	1900	1900	1900	1900	1900	1900	1900
Adjustment:	0.92	1.00	0.75	1.00	1.00	1.00	1.00	0.86	0.86	0.95	0.91	1.00
Lanes:	2.00	0.00	2.00	0.00	0.00	0.00	0.00	2.00	1.00	1.00	3.00	0.00
Final Sat.:	3502	0	2842	0	0	0	0	3282	1641	1805	5187	0

Capacity Analysis Module:

Vol/Sat:	0.01	0.00	0.09	0.00	0.00	0.00	0.00	0.41	0.42	0.12	0.33	0.00
Crit Moves:	****						****			****		
Green/Cycle:	0.14	0.00	0.14	0.00	0.00	0.00	0.00	0.63	0.63	0.18	0.81	0.00
Volume/Cap:	0.11	0.00	0.66	0.00	0.00	0.00	0.00	0.65	0.66	0.66	0.41	0.00
Delay/Veh:	37.8	0.0	44.9	0.0	0.0	0.0	0.0	11.9	12.2	43.1	2.7	0.0
User DelAdj:	1.00	1.00	1.00	1.00	1.00	1.00	1.00	1.00	1.00	1.00	1.00	1.00
AdjDel/Veh:	37.8	0.0	44.9	0.0	0.0	0.0	0.0	11.9	12.2	43.1	2.7	0.0
LOS by Move:	D	A	D	A	A	A	A	B	B	D	A	A
HCM2k85thQ:	1	0	9	0	0	0	0	22	22	11	9	0

 Note: Queue reported is the number of cars per lane.

Santa Ana Circulation Element

Level Of Service Computation Report

2000 HCM Operations Method (Base Volume Alternative)

 Intersection #59 I-5 NB Off Ramps/17th Street

Cycle (sec): 100 Critical Vol./Cap.(X): 0.710
 Loss Time (sec): 5 Average Delay (sec/veh): 30.0
 Optimal Cycle: 40 Level Of Service: C

Street Name:	I-5 NB Off Ramps						17th Street													
Approach:	North Bound			South Bound			East Bound			West Bound										
Movement:	L	T	R	L	T	R	L	T	R	L	T	R								
Control:	Split Phase			Split Phase			Protected			Permitted										
Rights:	Include			Include			Ignore			Include										
Min. Green:	0	0	0	0	0	0	0	0	0	0	0	0								
Y+R:	4.0	4.0	4.0	4.0	4.0	4.0	4.0	4.0	4.0	4.0	4.0	4.0								
Lanes:	1	1	0	0	1	1	0	0	0	1	1	0	3	0	1	0	0	2	1	0

Volume Module:

Base Vol:	720	33	21	54	0	279	89	932	337	0	1245	20
Growth Adj:	1.00	1.00	1.00	1.00	1.00	1.00	1.00	1.00	1.00	1.00	1.00	1.00
Initial Bse:	720	33	21	54	0	279	89	932	337	0	1245	20
User Adj:	1.00	1.00	1.00	1.00	1.00	1.00	1.00	1.00	0.00	1.00	1.00	1.00
PHF Adj:	1.00	1.00	1.00	1.00	1.00	1.00	1.00	1.00	0.00	1.00	1.00	1.00
PHF Volume:	720	33	21	54	0	279	89	932	0	0	1245	20
Reduct Vol:	0	0	0	0	0	0	0	0	0	0	0	0
Reduced Vol:	720	33	21	54	0	279	89	932	0	0	1245	20
PCE Adj:	1.00	1.00	1.00	1.00	1.00	1.00	1.00	1.00	0.00	1.00	1.00	1.00
MLF Adj:	1.00	1.00	1.00	1.00	1.00	1.00	1.00	1.00	0.00	1.00	1.00	1.00
Final Volume:	720	33	21	54	0	279	89	932	0	0	1245	20

Saturation Flow Module:

Sat/Lane:	1900	1900	1900	1900	1900	1900	1900	1900	1900	1900	1900	1900
Adjustment:	0.95	0.95	0.85	0.95	1.00	0.85	0.95	0.91	1.00	1.00	0.91	0.91
Lanes:	1.91	0.09	1.00	1.00	0.00	1.00	1.00	3.00	1.00	0.00	2.95	0.05
Final Sat.:	3466	159	1615	1805	0	1615	1805	5187	1900	0	5095	82

Capacity Analysis Module:

Vol/Sat:	0.21	0.21	0.01	0.03	0.00	0.17	0.05	0.18	0.00	0.00	0.24	0.24
Crit Moves:	****					****	****				****	
Green/Cycle:	0.29	0.29	0.29	0.24	0.00	0.24	0.07	0.41	0.00	0.00	0.34	0.34
Volume/Cap:	0.71	0.71	0.04	0.12	0.00	0.71	0.71	0.43	0.00	0.00	0.71	0.71
Delay/Veh:	33.8	33.8	25.4	29.6	0.0	40.5	62.7	21.1	0.0	0.0	29.8	29.8
User DelAdj:	1.00	1.00	1.00	1.00	1.00	1.00	1.00	1.00	1.00	1.00	1.00	1.00
AdjDel/Veh:	33.8	33.8	25.4	29.6	0.0	40.5	62.7	21.1	0.0	0.0	29.8	29.8
LOS by Move:	C	C	C	C	A	D	E	C	A	A	C	C
HCM2k85thQ:	17	17	1	2	0	14	7	12	0	0	20	20

 Note: Queue reported is the number of cars per lane.

Santa Ana Circulation Element

Level Of Service Computation Report
 2000 HCM Operations Method (Base Volume Alternative)

 Intersection #60 Penn Wy and I-5 SB Ramps

Cycle (sec): 100 Critical Vol./Cap.(X): 0.550
 Loss Time (sec): 5 Average Delay (sec/veh): 21.2
 Optimal Cycle: 27 Level Of Service: C

Approach:	North Bound			South Bound			East Bound			West Bound		
Movement:	L	T	R	L	T	R	L	T	R	L	T	R
Control:	Protected			Protected			Split Phase			Split Phase		
Rights:	Include			Include			Include			Ovl		
Min. Green:	0	0	0	0	0	0	0	0	0	0	0	0
Y+R:	4.0	4.0	4.0	4.0	4.0	4.0	4.0	4.0	4.0	4.0	4.0	4.0
Lanes:	0	0	2	0	1		2	0	2	0	0	

Volume Module:

Base Vol:	0	260	230	951	196	0	0	0	0	196	0	110
Growth Adj:	1.00	1.00	1.00	1.00	1.00	1.00	1.00	1.00	1.00	1.00	1.00	1.00
Initial Bse:	0	260	230	951	196	0	0	0	0	196	0	110
User Adj:	1.00	1.00	1.00	1.00	1.00	1.00	1.00	1.00	1.00	1.00	1.00	1.00
PHF Adj:	1.00	1.00	1.00	1.00	1.00	1.00	1.00	1.00	1.00	1.00	1.00	1.00
PHF Volume:	0	260	230	951	196	0	0	0	0	196	0	110
Reduct Vol:	0	0	0	0	0	0	0	0	0	0	0	0
Reduced Vol:	0	260	230	951	196	0	0	0	0	196	0	110
PCE Adj:	1.00	1.00	1.00	1.00	1.00	1.00	1.00	1.00	1.00	1.00	1.00	1.00
MLF Adj:	1.00	1.00	1.00	1.00	1.00	1.00	1.00	1.00	1.00	1.00	1.00	1.00
Final Volume:	0	260	230	951	196	0	0	0	0	196	0	110

Saturation Flow Module:

Sat/Lane:	1900	1900	1900	1900	1900	1900	1900	1900	1900	1900	1900	1900
Adjustment:	1.00	0.95	0.85	0.92	0.95	1.00	1.00	1.00	1.00	0.95	1.00	0.75
Lanes:	0.00	2.00	1.00	2.00	2.00	0.00	0.00	0.00	0.00	1.00	0.00	2.00
Final Sat.:	0	3610	1615	3502	3610	0	0	0	0	1805	0	2842

Capacity Analysis Module:

Vol/Sat:	0.00	0.07	0.14	0.27	0.05	0.00	0.00	0.00	0.00	0.11	0.00	0.04
Crit Moves:	****			****						****		
Green/Cycle:	0.00	0.26	0.26	0.49	0.75	0.00	0.00	0.00	0.00	0.20	0.00	0.69
Volume/Cap:	0.00	0.28	0.55	0.55	0.07	0.00	0.00	0.00	0.00	0.55	0.00	0.06
Delay/Veh:	0.0	29.8	33.6	18.0	3.2	0.0	0.0	0.0	0.0	38.0	0.0	5.0
User DelAdj:	1.00	1.00	1.00	1.00	1.00	1.00	1.00	1.00	1.00	1.00	1.00	1.00
AdjDel/Veh:	0.0	29.8	33.6	18.0	3.2	0.0	0.0	0.0	0.0	38.0	0.0	5.0
LOS by Move:	A	C	C	B	A	A	A	A	A	D	A	A
HCM2k85thQ:	0	5	10	16	1	0	0	0	0	9	0	1

 Note: Queue reported is the number of cars per lane.

Santa Ana Circulation Element

Level Of Service Computation Report
 2000 HCM 4-Way Stop Method (Base Volume Alternative)

 Intersection #61 Santiago St and Civic Center Dr

Cycle (sec): 100 Critical Vol./Cap.(X): 1.769
 Loss Time (sec): 5 Average Delay (sec/veh): 159.2
 Optimal Cycle: 0 Level Of Service: F

Approach:	North Bound			South Bound			East Bound			West Bound		
Movement:	L	T	R	L	T	R	L	T	R	L	T	R
Control:	Stop Sign			Stop Sign			Stop Sign			Stop Sign		
Rights:	Include			Include			Include			Include		
Min. Green:	0	0	0	0	0	0	0	0	0	0	0	0
Lanes:	1	0	0	1	0	0	0	1	0	0	0	1

Volume Module:

Base Vol:	487	338	47	10	590	144	182	69	369	108	99	20
Growth Adj:	1.00	1.00	1.00	1.00	1.00	1.00	1.00	1.00	1.00	1.00	1.00	1.00
Initial Bse:	487	338	47	10	590	144	182	69	369	108	99	20
User Adj:	1.00	1.00	1.00	1.00	1.00	1.00	1.00	1.00	1.00	1.00	1.00	1.00
PHF Adj:	1.00	1.00	1.00	1.00	1.00	1.00	1.00	1.00	1.00	1.00	1.00	1.00
PHF Volume:	487	338	47	10	590	144	182	69	369	108	99	20
Reduct Vol:	0	0	0	0	0	0	0	0	0	0	0	0
Reduced Vol:	487	338	47	10	590	144	182	69	369	108	99	20
PCE Adj:	1.00	1.00	1.00	1.00	1.00	1.00	1.00	1.00	1.00	1.00	1.00	1.00
MLF Adj:	1.00	1.00	1.00	1.00	1.00	1.00	1.00	1.00	1.00	1.00	1.00	1.00
FinalVolume:	487	338	47	10	590	144	182	69	369	108	99	20

Saturation Flow Module:

Adjustment:	1.00	1.00	1.00	1.00	1.00	1.00	1.00	1.00	1.00	1.00	1.00	1.00
Lanes:	1.00	0.88	0.12	1.00	0.80	0.20	0.73	0.27	1.00	0.47	0.44	0.09
Final Sat.:	402	377	52	381	333	81	289	110	453	177	162	33

Capacity Analysis Module:

Vol/Sat:	1.21	0.90	0.90	0.03	1.77	1.77	0.63	0.63	0.82	0.61	0.61	0.61
Crit Moves:	****			****			****			****		
Delay/Veh:	144.0	50.3	50.3	12.3	377	376.5	25.7	25.7	36.9	26.3	26.3	26.3
Delay Adj:	1.00	1.00	1.00	1.00	1.00	1.00	1.00	1.00	1.00	1.00	1.00	1.00
AdjDel/Veh:	144.0	50.3	50.3	12.3	377	376.5	25.7	25.7	36.9	26.3	26.3	26.3
LOS by Move:	F	F	F	B	F	F	D	D	E	D	D	D
ApproachDel:	102.6			371.6			32.3			26.3		
Delay Adj:	1.00			1.00			1.00			1.00		
ApprAdjDel:	102.6			371.6			32.3			26.3		
LOS by Appr:	F			F			D			D		
AllWayAvgQ:	14.8	4.7	4.7	0.0	42.1	42.1	1.5	1.5	3.3	1.4	1.4	1.4

 Note: Queue reported is the number of cars per lane.

Santa Ana Circulation Element

Level Of Service Computation Report

ICU 1(Loss as Cycle Length %) Method (Base Volume Alternative)

Intersection #62 Santiago St and Santa Ana Blvd

Cycle (sec): 100 Critical Vol./Cap.(X): 1.037
 Loss Time (sec): 5 Average Delay (sec/veh): xxxxxx
 Optimal Cycle: 180 Level Of Service: F

Approach:	North Bound			South Bound			East Bound			West Bound		
Movement:	L	T	R	L	T	R	L	T	R	L	T	R
Control:	Permitted			Permitted			Protected			Protected		
Rights:	Include			Include			Include			Include		
Min. Green:	0	0	0	0	0	0	0	0	0	0	0	0
Y+R:	4.0	4.0	4.0	4.0	4.0	4.0	4.0	4.0	4.0	4.0	4.0	4.0
Lanes:	1	0	1	1	0	1	1	0	1	1	0	2

Volume Module:

Base Vol:	188	611	303	409	972	253	118	732	99	297	699	258
Growth Adj:	1.00	1.00	1.00	1.00	1.00	1.00	1.00	1.00	1.00	1.00	1.00	1.00
Initial Bse:	188	611	303	409	972	253	118	732	99	297	699	258
User Adj:	1.00	1.00	1.00	1.00	1.00	1.00	1.00	1.00	1.00	1.00	1.00	1.00
PHF Adj:	1.00	1.00	1.00	1.00	1.00	1.00	1.00	1.00	1.00	1.00	1.00	1.00
PHF Volume:	188	611	303	409	972	253	118	732	99	297	699	258
Reduct Vol:	0	0	0	0	0	0	0	0	0	0	0	0
Reduced Vol:	188	611	303	409	972	253	118	732	99	297	699	258
PCE Adj:	1.00	1.00	1.00	1.00	1.00	1.00	1.00	1.00	1.00	1.00	1.00	1.00
MLF Adj:	1.00	1.00	1.00	1.00	1.00	1.00	1.00	1.00	1.00	1.00	1.00	1.00
FinalVolume:	188	611	303	409	972	253	118	732	99	297	699	258

Saturation Flow Module:

Sat/Lane:	1600	1600	1600	1600	1600	1600	1600	1600	1600	1600	1600	1600
Adjustment:	1.00	1.05	1.00	1.00	1.04	1.00	1.00	1.04	1.00	1.00	1.06	1.00
Lanes:	1.00	1.34	0.66	1.00	1.59	0.41	1.00	1.76	0.24	1.00	2.00	1.00
Final Sat.:	1600	2239	1061	1600	2639	661	1600	2919	381	1600	3400	1600

Capacity Analysis Module:

Vol/Sat:	0.12	0.27	0.29	0.26	0.37	0.38	0.07	0.25	0.26	0.19	0.21	0.16
Crit Moves:			****	****					****	****		

Santa Ana Circulation Element

Level Of Service Computation Report

ICU 1(Loss as Cycle Length %) Method (Base Volume Alternative)

Intersection #63 Standard Ave and 4th St

Cycle (sec): 100 Critical Vol./Cap.(X): 0.939
 Loss Time (sec): 5 Average Delay (sec/veh): xxxxxx
 Optimal Cycle: 117 Level Of Service: E

Approach:	North Bound			South Bound			East Bound			West Bound		
Movement:	L	T	R	L	T	R	L	T	R	L	T	R
Control:	Protected			Protected			Protected			Protected		
Rights:	Include			Include			Include			Include		
Min. Green:	0	0	0	0	0	0	0	0	0	0	0	0
Y+R:	4.0	4.0	4.0	4.0	4.0	4.0	4.0	4.0	4.0	4.0	4.0	4.0
Lanes:	1	0	2	0	1	1	0	1	1	0	1	1

Volume Module:

Base Vol:	191	473	248	431	604	332	298	624	219	250	550	340
Growth Adj:	1.00	1.00	1.00	1.00	1.00	1.00	1.00	1.00	1.00	1.00	1.00	1.00
Initial Bse:	191	473	248	431	604	332	298	624	219	250	550	340
User Adj:	1.00	1.00	1.00	1.00	1.00	1.00	1.00	1.00	1.00	1.00	1.00	1.00
PHF Adj:	1.00	1.00	1.00	1.00	1.00	1.00	1.00	1.00	1.00	1.00	1.00	1.00
PHF Volume:	191	473	248	431	604	332	298	624	219	250	550	340
Reduct Vol:	0	0	0	0	0	0	0	0	0	0	0	0
Reduced Vol:	191	473	248	431	604	332	298	624	219	250	550	340
PCE Adj:	1.00	1.00	1.00	1.00	1.00	1.00	1.00	1.00	1.00	1.00	1.00	1.00
MLF Adj:	1.00	1.00	1.00	1.00	1.00	1.00	1.00	1.00	1.00	1.00	1.00	1.00
Final Volume:	191	473	248	431	604	332	298	624	219	250	550	340

Saturation Flow Module:

Sat/Lane:	1600	1600	1600	1600	1600	1600	1600	1600	1600	1600	1600	1600
Adjustment:	1.00	1.06	1.00	1.00	1.06	1.00	1.00	1.04	1.00	1.00	1.05	1.00
Lanes:	1.00	2.00	1.00	1.00	2.00	1.00	1.00	1.48	0.52	1.00	1.24	0.76
Final Sat.:	1600	3400	1600	1600	3400	1600	1600	2469	831	1600	2078	1222

Capacity Analysis Module:

Vol/Sat:	0.12	0.14	0.16	0.27	0.18	0.21	0.19	0.25	0.26	0.16	0.26	0.28
Crit Moves:			****	****			****					****

Santa Ana Circulation Element

Level Of Service Computation Report

ICU 1(Loss as Cycle Length %) Method (Base Volume Alternative)

Intersection #64 Standard Ave and 1st St

Cycle (sec): 100 Critical Vol./Cap.(X): 0.976
 Loss Time (sec): 5 Average Delay (sec/veh): xxxxxx
 Optimal Cycle: 176 Level Of Service: E

Approach:	North Bound			South Bound			East Bound			West Bound		
Movement:	L	T	R	L	T	R	L	T	R	L	T	R
Control:	Permitted			Permitted			Protected			Protected		
Rights:	Include			Include			Include			Include		
Min. Green:	0	0	0	0	0	0	0	0	0	0	0	0
Y+R:	4.0	4.0	4.0	4.0	4.0	4.0	4.0	4.0	4.0	4.0	4.0	4.0
Lanes:	1	0	1	1	0	1	1	0	2	1	0	2

Volume Module:

Base Vol:	45	631	312	123	901	41	161	1959	121	194	1282	120
Growth Adj:	1.00	1.00	1.00	1.00	1.00	1.00	1.00	1.00	1.00	1.00	1.00	1.00
Initial Bse:	45	631	312	123	901	41	161	1959	121	194	1282	120
User Adj:	1.00	1.00	1.00	1.00	1.00	1.00	1.00	1.00	1.00	1.00	1.00	1.00
PHF Adj:	1.00	1.00	1.00	1.00	1.00	1.00	1.00	1.00	1.00	1.00	1.00	1.00
PHF Volume:	45	631	312	123	901	41	161	1959	121	194	1282	120
Reduct Vol:	0	0	0	0	0	0	0	0	0	0	0	0
Reduced Vol:	45	631	312	123	901	41	161	1959	121	194	1282	120
PCE Adj:	1.00	1.00	1.00	1.00	1.00	1.00	1.00	1.00	1.00	1.00	1.00	1.00
MLF Adj:	1.00	1.00	1.00	1.00	1.00	1.00	1.00	1.00	1.00	1.00	1.00	1.00
FinalVolume:	45	631	312	123	901	41	161	1959	121	194	1282	120

Saturation Flow Module:

Sat/Lane:	1600	1600	1600	1600	1600	1600	1600	1600	1600	1600	1600	1600
Adjustment:	1.00	1.05	1.00	1.00	1.03	1.00	1.00	1.04	1.00	1.00	1.05	1.00
Lanes:	1.00	1.34	0.66	1.00	1.91	0.09	1.00	2.83	0.17	1.00	2.74	0.26
Final Sat.:	1600	2241	1059	1600	3161	139	1600	4721	279	1600	4589	411

Capacity Analysis Module:

Vol/Sat:	0.03	0.28	0.29	0.08	0.29	0.29	0.10	0.41	0.43	0.12	0.28	0.29
Crit Moves:			****	****					****	****		

Santa Ana Circulation Element

Level Of Service Computation Report

ICU 1(Loss as Cycle Length %) Method (Base Volume Alternative)

Intersection #65 Standard Ave and Mcfadden Ave

Cycle (sec): 100 Critical Vol./Cap.(X): 0.854
Loss Time (sec): 5 Average Delay (sec/veh): xxxxxx
Optimal Cycle: 66 Level Of Service: D

Table with 4 columns: North Bound, South Bound, East Bound, West Bound. Rows include Movement (L-T-R), Control (Protected), Rights (Include), Min. Green, Y+R, and Lanes.

Volume Module: Table with 12 columns representing different traffic volumes and adjustment factors like Growth Adj, Initial Bse, User Adj, PHF Adj, PHF Volume, Reduct Vol, Reduced Vol, PCE Adj, MLF Adj, and Final Volume.

Saturation Flow Module: Table with 12 columns showing saturation flow rates and adjustment factors for each lane.

Capacity Analysis Module: Table with 12 columns showing volume-to-saturation ratios and critical moves.

Santa Ana Circulation Element

Level Of Service Computation Report

ICU 1(Loss as Cycle Length %) Method (Base Volume Alternative)

Intersection #66 Halladay St and Warner Ave

Cycle (sec): 100 Critical Vol./Cap.(X): 0.775
 Loss Time (sec): 5 Average Delay (sec/veh): xxxxxx
 Optimal Cycle: 47 Level Of Service: C

Approach:	North Bound			South Bound			East Bound			West Bound		
Movement:	L	T	R	L	T	R	L	T	R	L	T	R
Control:	Permitted			Permitted			Permitted			Permitted		
Rights:	Include			Include			Include			Include		
Min. Green:	0	0	0	0	0	0	0	0	0	0	0	0
Y+R:	4.0	4.0	4.0	4.0	4.0	4.0	4.0	4.0	4.0	4.0	4.0	4.0
Lanes:	1	0	0	0	0	0	0	0	2	1	0	0

Volume Module:

Base Vol:	95	0	220	0	0	0	0	1833	207	260	986	0
Growth Adj:	1.00	1.00	1.00	1.00	1.00	1.00	1.00	1.00	1.00	1.00	1.00	1.00
Initial Bse:	95	0	220	0	0	0	0	1833	207	260	986	0
User Adj:	1.00	1.00	1.00	1.00	1.00	1.00	1.00	1.00	1.00	1.00	1.00	1.00
PHF Adj:	1.00	1.00	1.00	1.00	1.00	1.00	1.00	1.00	1.00	1.00	1.00	1.00
PHF Volume:	95	0	220	0	0	0	0	1833	207	260	986	0
Reduct Vol:	0	0	0	0	0	0	0	0	0	0	0	0
Reduced Vol:	95	0	220	0	0	0	0	1833	207	260	986	0
PCE Adj:	1.00	1.00	1.00	1.00	1.00	1.00	1.00	1.00	1.00	1.00	1.00	1.00
MLF Adj:	1.00	1.00	1.00	1.00	1.00	1.00	1.00	1.00	1.00	1.00	1.00	1.00
FinalVolume:	95	0	220	0	0	0	0	1833	207	260	986	0

Saturation Flow Module:

Sat/Lane:	1600	1600	1600	1600	1600	1600	1600	1600	1600	1600	1600	1600
Adjustment:	1.00	1.06	1.00	1.00	1.06	1.00	1.00	1.05	1.00	1.00	1.05	1.00
Lanes:	1.00	0.00	1.00	0.00	0.00	0.00	0.00	2.70	0.30	0.63	2.37	0.00
Final Sat.:	1600	0	1600	0	0	0	0	4513	487	1002	3998	0

Capacity Analysis Module:

Vol/Sat:	0.06	0.00	0.14	0.00	0.00	0.00	0.00	0.41	0.43	0.16	0.25	0.00
Crit Moves:	****			****			****			****		

Santa Ana Circulation Element

Level Of Service Computation Report

ICU 1(Loss as Cycle Length %) Method (Base Volume Alternative)

Intersection #67 Halladay St and Dyer Rd

Cycle (sec): 100 Critical Vol./Cap.(X): 0.774
Loss Time (sec): 5 Average Delay (sec/veh): xxxxxx
Optimal Cycle: 47 Level Of Service: C

Table with 4 columns: North Bound, South Bound, East Bound, West Bound. Rows include Movement (L-T-R), Control (Split Phase, Protected), Rights (Include), Min. Green, Y+R, and Lanes.

Volume Module: Table with 12 columns representing different traffic volumes and 10 rows of adjustment factors like Growth Adj, PHF Adj, PCE Adj, etc.

Saturation Flow Module: Table with 12 columns representing saturation flow rates and 4 rows of adjustment factors like Sat/Lane, Adjustment, Lanes, Final Sat.

Capacity Analysis Module: Table with 12 columns representing capacity analysis metrics and 3 rows: Vol/Sat, Crit Moves, and asterisks.

Santa Ana Circulation Element

Level Of Service Computation Report
 2000 HCM Operations Method (Base Volume Alternative)

 Intersection #68 SR-55 SB Ramps and MacArthur Blvd

Cycle (sec): 100 Critical Vol./Cap.(X): 0.608
 Loss Time (sec): 5 Average Delay (sec/veh): 19.9
 Optimal Cycle: 31 Level Of Service: B

Approach:	North Bound			South Bound			East Bound			West Bound		
Movement:	L	T	R	L	T	R	L	T	R	L	T	R
Control:	Split Phase			Split Phase			Protected			Protected		
Rights:	Include			Include			Ignore			Ignore		
Min. Green:	0	0	0	0	0	0	0	0	0	0	0	0
Y+R:	4.0	4.0	4.0	4.0	4.0	4.0	4.0	4.0	4.0	4.0	4.0	4.0
Lanes:	0	0	0	2	0	0	0	0	2	1	1	0

Volume Module:

Base Vol:	0	0	0	998	0	903	0	1349	961	0	1187	135
Growth Adj:	1.00	1.00	1.00	1.00	1.00	1.00	1.00	1.00	1.00	1.00	1.00	1.00
Initial Bse:	0	0	0	998	0	903	0	1349	961	0	1187	135
User Adj:	1.00	1.00	1.00	1.00	1.00	1.00	1.00	1.00	0.00	1.00	1.00	0.00
PHF Adj:	1.00	1.00	1.00	1.00	1.00	1.00	1.00	1.00	0.00	1.00	1.00	0.00
PHF Volume:	0	0	0	998	0	903	0	1349	0	0	1187	0
Reduct Vol:	0	0	0	0	0	0	0	0	0	0	0	0
Reduced Vol:	0	0	0	998	0	903	0	1349	0	0	1187	0
PCE Adj:	1.00	1.00	1.00	1.00	1.00	1.00	1.00	1.00	0.00	1.00	1.00	0.00
MLF Adj:	1.00	1.00	1.00	1.00	1.00	1.00	1.00	1.00	0.00	1.00	1.00	0.00
FinalVolume:	0	0	0	998	0	903	0	1349	0	0	1187	0

Saturation Flow Module:

Sat/Lane:	1900	1900	1900	1900	1900	1900	1900	1900	1900	1900	1900	1900
Adjustment:	1.00	1.00	1.00	0.92	1.00	0.75	1.00	0.91	0.91	1.00	0.91	1.00
Lanes:	0.00	0.00	0.00	2.00	0.00	2.00	0.00	3.00	1.00	0.00	3.00	1.00
Final Sat.:	0	0	0	3502	0	2842	0	5187	1729	0	5187	1900

Capacity Analysis Module:

Vol/Sat:	0.00	0.00	0.00	0.29	0.00	0.32	0.00	0.26	0.00	0.00	0.23	0.00
Crit Moves:						****		****		****		
Green/Cycle:	0.00	0.00	0.00	0.52	0.00	0.52	0.00	0.43	0.00	0.00	0.43	0.00
Volume/Cap:	0.00	0.00	0.00	0.55	0.00	0.61	0.00	0.61	0.00	0.00	0.54	0.00
Delay/Veh:	0.0	0.0	0.0	16.3	0.0	17.5	0.0	22.6	0.0	0.0	21.5	0.0
User DelAdj:	1.00	1.00	1.00	1.00	1.00	1.00	1.00	1.00	1.00	1.00	1.00	1.00
AdjDel/Veh:	0.0	0.0	0.0	16.3	0.0	17.5	0.0	22.6	0.0	0.0	21.5	0.0
LOS by Move:	A	A	A	B	A	B	A	C	A	A	C	A
HCM2k85thQ:	0	0	0	16	0	17	0	18	0	0	15	0

 Note: Queue reported is the number of cars per lane.

Santa Ana Circulation Element

Level Of Service Computation Report
 2000 HCM Operations Method (Base Volume Alternative)

 Intersection #69 SR-55 NB Ramps and MacArthur Blvd

Cycle (sec): 100 Critical Vol./Cap.(X): 0.712
 Loss Time (sec): 5 Average Delay (sec/veh): 19.3
 Optimal Cycle: 40 Level Of Service: B

Approach:	North Bound			South Bound			East Bound			West Bound		
Movement:	L	T	R	L	T	R	L	T	R	L	T	R
Control:	Split Phase			Split Phase			Protected			Protected		
Rights:	Ignore			Include			Ignore			Ignore		
Min. Green:	0	0	0	0	0	0	0	0	0	0	0	0
Y+R:	4.0	4.0	4.0	4.0	4.0	4.0	4.0	4.0	4.0	4.0	4.0	4.0
Lanes:	2	0	0	0	0	0	0	0	2	0	0	3

Volume Module:

Base Vol:	946	0	1017	0	0	0	0	1468	726	0	517	244
Growth Adj:	1.00	1.00	1.00	1.00	1.00	1.00	1.00	1.00	1.00	1.00	1.00	1.00
Initial Bse:	946	0	1017	0	0	0	0	1468	726	0	517	244
User Adj:	1.00	1.00	0.00	1.00	1.00	1.00	1.00	1.00	0.00	1.00	1.00	0.00
PHF Adj:	1.00	1.00	0.00	1.00	1.00	1.00	1.00	1.00	0.00	1.00	1.00	0.00
PHF Volume:	946	0	0	0	0	0	0	1468	0	0	517	0
Reduct Vol:	0	0	0	0	0	0	0	0	0	0	0	0
Reduced Vol:	946	0	0	0	0	0	0	1468	0	0	517	0
PCE Adj:	1.00	1.00	0.00	1.00	1.00	1.00	1.00	1.00	0.00	1.00	1.00	0.00
MLF Adj:	1.00	1.00	0.00	1.00	1.00	1.00	1.00	1.00	0.00	1.00	1.00	0.00
FinalVolume:	946	0	0	0	0	0	0	1468	0	0	517	0

Saturation Flow Module:

Sat/Lane:	1900	1900	1900	1900	1900	1900	1900	1900	1900	1900	1900	1900
Adjustment:	0.92	1.00	1.00	1.00	1.00	1.00	1.00	0.95	0.88	1.00	0.91	1.00
Lanes:	2.00	0.00	1.00	0.00	0.00	0.00	0.00	2.00	2.00	0.00	3.00	1.00
Final Sat.:	3502	0	1900	0	0	0	0	3610	3344	0	5187	1900

Capacity Analysis Module:

Vol/Sat:	0.27	0.00	0.00	0.00	0.00	0.00	0.00	0.41	0.00	0.00	0.10	0.00
Crit Moves:	****							****		****		
Green/Cycle:	0.38	0.00	0.00	0.00	0.00	0.00	0.00	0.57	0.00	0.00	0.57	0.00
Volume/Cap:	0.71	0.00	0.00	0.00	0.00	0.00	0.00	0.71	0.00	0.00	0.17	0.00
Delay/Veh:	28.2	0.0	0.0	0.0	0.0	0.0	0.0	16.7	0.0	0.0	10.3	0.0
User DelAdj:	1.00	1.00	1.00	1.00	1.00	1.00	1.00	1.00	1.00	1.00	1.00	1.00
AdjDel/Veh:	28.2	0.0	0.0	0.0	0.0	0.0	0.0	16.7	0.0	0.0	10.3	0.0
LOS by Move:	C	A	A	A	A	A	A	B	A	A	B	A
HCM2k85thQ:	21	0	0	0	0	0	0	26	0	0	4	0

 Note: Queue reported is the number of cars per lane.

Santa Ana Circulation Element

Level Of Service Computation Report
 2000 HCM Operations Method (Base Volume Alternative)

 Intersection #70 SR-55 SB Ramps and Dyer Rd

Cycle (sec): 100 Critical Vol./Cap.(X): 0.617
 Loss Time (sec): 5 Average Delay (sec/veh): 25.7
 Optimal Cycle: 31 Level Of Service: C

Approach:	North Bound			South Bound			East Bound			West Bound		
Movement:	L	T	R	L	T	R	L	T	R	L	T	R
Control:	Split Phase			Split Phase			Protected			Protected		
Rights:	Ovl			Include			Include			Include		
Min. Green:	0	0	0	0	0	0	0	0	0	0	0	0
Y+R:	4.0	4.0	4.0	4.0	4.0	4.0	4.0	4.0	4.0	4.0	4.0	4.0
Lanes:	1	1	0	0	1	1	0	3	0	2	0	3

Volume Module:

Base Vol:	286	34	654	50	242	60	37	1422	303	348	552	92
Growth Adj:	1.00	1.00	1.00	1.00	1.00	1.00	1.00	1.00	1.00	1.00	1.00	1.00
Initial Bse:	286	34	654	50	242	60	37	1422	303	348	552	92
User Adj:	1.00	1.00	1.00	1.00	1.00	1.00	1.00	1.00	1.00	1.00	1.00	1.00
PHF Adj:	1.00	1.00	1.00	1.00	1.00	1.00	1.00	1.00	1.00	1.00	1.00	1.00
PHF Volume:	286	34	654	50	242	60	37	1422	303	348	552	92
Reduct Vol:	0	0	0	0	0	0	0	0	0	0	0	0
Reduced Vol:	286	34	654	50	242	60	37	1422	303	348	552	92
PCE Adj:	1.00	1.00	1.00	1.00	1.00	1.00	1.00	1.00	1.00	1.00	1.00	1.00
MLF Adj:	1.00	1.00	1.00	1.00	1.00	1.00	1.00	1.00	1.00	1.00	1.00	1.00
FinalVolume:	286	34	654	50	242	60	37	1422	303	348	552	92

Saturation Flow Module:

Sat/Lane:	1900	1900	1900	1900	1900	1900	1900	1900	1900	1900	1900	1900
Adjustment:	0.96	0.96	0.75	0.94	0.94	0.85	0.95	0.91	0.85	0.92	0.91	0.85
Lanes:	1.79	0.21	2.00	0.34	1.66	1.00	1.00	3.00	1.00	2.00	3.00	1.00
Final Sat.:	3250	386	2842	613	2968	1615	1805	5187	1615	3502	5187	1615

Capacity Analysis Module:

Vol/Sat:	0.09	0.09	0.23	0.08	0.08	0.04	0.02	0.27	0.19	0.10	0.11	0.06
Crit Moves:	****			****			****			****		
Green/Cycle:	0.21	0.21	0.37	0.13	0.13	0.13	0.10	0.44	0.44	0.16	0.51	0.51
Volume/Cap:	0.42	0.42	0.62	0.62	0.62	0.28	0.21	0.62	0.42	0.62	0.21	0.11
Delay/Veh:	34.4	34.4	26.6	43.4	43.4	39.8	42.1	21.8	19.4	41.1	13.6	12.9
User DelAdj:	1.00	1.00	1.00	1.00	1.00	1.00	1.00	1.00	1.00	1.00	1.00	1.00
AdjDel/Veh:	34.4	34.4	26.6	43.4	43.4	39.8	42.1	21.8	19.4	41.1	13.6	12.9
LOS by Move:	C	C	C	D	D	D	D	C	B	D	B	B
HCM2k85thQ:	7	7	15	8	8	3	2	19	10	9	5	2

 Note: Queue reported is the number of cars per lane.

Santa Ana Circulation Element

Level Of Service Computation Report

ICU 1(Loss as Cycle Length %) Method (Base Volume Alternative)

Intersection #71 Glassell St and La Veta Ave

Cycle (sec): 100 Critical Vol./Cap.(X): 0.800
 Loss Time (sec): 5 Average Delay (sec/veh): xxxxxx
 Optimal Cycle: 52 Level Of Service: D

Approach:	North Bound			South Bound			East Bound			West Bound		
Movement:	L	T	R	L	T	R	L	T	R	L	T	R
Control:	Protected			Protected			Protected			Protected		
Rights:	Ovl			Include			Ovl			Include		
Min. Green:	0	0	0	0	0	0	0	0	0	0	0	0
Y+R:	4.0	4.0	4.0	4.0	4.0	4.0	4.0	4.0	4.0	4.0	4.0	4.0
Lanes:	2	0	1	0	1	0	1	0	1	0	1	0

Volume Module:	North Bound			South Bound			East Bound			West Bound		
Base Vol:	263	412	125	14	295	65	57	293	563	367	387	9
Growth Adj:	1.00	1.00	1.00	1.00	1.00	1.00	1.00	1.00	1.00	1.00	1.00	1.00
Initial Bse:	263	412	125	14	295	65	57	293	563	367	387	9
User Adj:	1.00	1.00	1.00	1.00	1.00	1.00	1.00	1.00	1.00	1.00	1.00	1.00
PHF Adj:	1.00	1.00	1.00	1.00	1.00	1.00	1.00	1.00	1.00	1.00	1.00	1.00
PHF Volume:	263	412	125	14	295	65	57	293	563	367	387	9
Reduct Vol:	0	0	0	0	0	0	0	0	0	0	0	0
Reduced Vol:	263	412	125	14	295	65	57	293	563	367	387	9
PCE Adj:	1.00	1.00	1.00	1.00	1.00	1.00	1.00	1.00	1.00	1.00	1.00	1.00
MLF Adj:	1.00	1.00	1.00	1.00	1.00	1.00	1.00	1.00	1.00	1.00	1.00	1.00
FinalVolume:	263	412	125	14	295	65	57	293	563	367	387	9
OvlAdjVol:	0						431					

Saturation Flow Module:	North Bound			South Bound			East Bound			West Bound		
Sat/Lane:	1600	1600	1600	1600	1600	1600	1600	1600	1600	1600	1600	1600
Adjustment:	1.00	1.06	1.00	1.00	1.04	1.00	1.00	1.06	1.00	1.00	1.03	1.00
Lanes:	2.00	1.00	1.00	1.00	1.64	0.36	1.00	1.00	1.00	1.00	1.95	0.05
Final Sat.:	3200	1700	1600	1600	2722	578	1600	1700	1600	1600	3227	73

Capacity Analysis Module:	North Bound			South Bound			East Bound			West Bound		
Vol/Sat:	0.08	0.24	0.08	0.01	0.11	0.11	0.04	0.17	0.35	0.23	0.12	0.12
OvlAdjV/S:	0.00						0.27					
Crit Moves:	****			****			****			****		

Santa Ana Circulation Element

Level Of Service Computation Report
2000 HCM Operations Method (Base Volume Alternative)

Intersection #72 Glassell St and SR-22 WB Ramps

Cycle (sec): 100 Critical Vol./Cap.(X): 0.871
Loss Time (sec): 5 Average Delay (sec/veh): 32.6
Optimal Cycle: 75 Level Of Service: C

Table with 4 columns: North Bound, South Bound, East Bound, West Bound. Rows include Movement, Control, Rights, Min. Green, Y+R, and Lanes.

Volume Module: Table with 12 columns representing different volume and adjustment factors for each bound.

Saturation Flow Module: Table with 12 columns representing saturation flow and adjustment factors.

Capacity Analysis Module: Table with 12 columns representing capacity analysis metrics like Vol/Sat, Crit Moves, Green/Cycle, etc.

Note: Queue reported is the number of cars per lane.

Santa Ana Circulation Element

Level of Service Computation Report
 2000 HCM Operations Method (Base Volume Alternative)

 Intersection #73 Grand Ave / Glassell St and SR-22 EB Ramps

Cycle (sec): 100 Critical Vol./Cap.(X): 0.860
 Loss Time (sec): 5 Average Delay (sec/veh): 30.6
 Optimal Cycle: 71 Level of Service: C

Approach: Movement:	North Bound			South Bound			East Bound			West Bound		
	L	T	R	L	T	R	L	T	R	L	T	R
Control:	Permitted			Protected			Split Phase			Split Phase		
Rights:	Include			Include			Include			Include		
Min. Green:	0	0	0	0	0	0	0	0	0	0	0	0
Y+R:	4.0	4.0	4.0	4.0	4.0	4.0	4.0	4.0	4.0	4.0	4.0	4.0
Lanes:	0	0	2	0	1	0	1	0	1	0	0	0

Volume Module:

Base Vol:	0	918	245	373	977	0	270	0	1058	0	0	0
Growth Adj:	1.00	1.00	1.00	1.00	1.00	1.00	1.00	1.00	1.00	1.00	1.00	1.00
Initial Bse:	0	918	245	373	977	0	270	0	1058	0	0	0
User Adj:	1.00	1.00	1.00	1.00	1.00	1.00	1.00	1.00	1.00	1.00	1.00	1.00
PHF Adj:	1.00	1.00	1.00	1.00	1.00	1.00	1.00	1.00	1.00	1.00	1.00	1.00
PHF Volume:	0	918	245	373	977	0	270	0	1058	0	0	0
Reduct Vol:	0	0	0	0	0	0	0	0	0	0	0	0
Reduced Vol:	0	918	245	373	977	0	270	0	1058	0	0	0
PCE Adj:	1.00	1.00	1.00	1.00	1.00	1.00	1.00	1.00	1.00	1.00	1.00	1.00
MLF Adj:	1.00	1.00	1.00	1.00	1.00	1.00	1.00	1.00	1.00	1.00	1.00	1.00
Final Volume:	0	918	245	373	977	0	270	0	1058	0	0	0

Saturation Flow Module:

Sat/Lane:	1900	1900	1900	1900	1900	1900	1900	1900	1900	1900	1900	1900
Adjustment:	1.00	0.95	0.85	0.95	0.95	1.00	0.87	1.00	0.87	1.00	1.00	1.00
Lanes:	0.00	2.00	1.00	1.00	2.00	0.00	1.20	0.00	1.80	0.00	0.00	0.00
Final Sat.:	0	3610	1615	1805	3610	0	1992	0	2974	0	0	0

Capacity Analysis Module:

Vol/Sat:	0.00	0.25	0.15	0.21	0.27	0.00	0.14	0.00	0.36	0.00	0.00	0.00
Crit Moves:	****			****			****					
Green/Cycle:	0.00	0.30	0.30	0.24	0.54	0.00	0.41	0.00	0.41	0.00	0.00	0.00
Volume/Cap:	0.00	0.86	0.51	0.86	0.50	0.00	0.33	0.00	0.86	0.00	0.00	0.00
Delay/Veh:	0.0	40.4	30.2	52.1	15.0	0.0	19.9	0.0	31.8	0.0	0.0	0.0
User DelAdj:	1.00	1.00	1.00	1.00	1.00	1.00	1.00	1.00	1.00	1.00	1.00	1.00
AdjDel/Veh:	0.0	40.4	30.2	52.1	15.0	0.0	19.9	0.0	31.8	0.0	0.0	0.0
LOS by Move:	A	D	C	D	B	A	B	A	C	A	A	A
HCM2k85thQ:	0	25	10	21	15	0	7	0	28	0	0	0

Note: Queue reported is the number of cars per lane.

Santa Ana Circulation Element

Level Of Service Computation Report

ICU 1(Loss as Cycle Length %) Method (Base Volume Alternative)

Intersection #74 Grand Ave and Fairhaven Ave

Cycle (sec): 100 Critical Vol./Cap.(X): 0.611
 Loss Time (sec): 5 Average Delay (sec/veh): xxxxxx
 Optimal Cycle: 30 Level Of Service: B

Approach:	North Bound			South Bound			East Bound			West Bound		
Movement:	L	T	R	L	T	R	L	T	R	L	T	R
Control:	Protected			Protected			Permitted			Permitted		
Rights:	Include			Include			Include			Include		
Min. Green:	0	0	0	0	0	0	0	0	0	0	0	0
Y+R:	4.0	4.0	4.0	4.0	4.0	4.0	4.0	4.0	4.0	4.0	4.0	4.0
Lanes:	1	0	2	1	0	2	1	0	1	1	0	1

Volume Module:

Base Vol:	21	840	121	207	1718	38	99	60	59	213	24	192
Growth Adj:	1.00	1.00	1.00	1.00	1.00	1.00	1.00	1.00	1.00	1.00	1.00	1.00
Initial Bse:	21	840	121	207	1718	38	99	60	59	213	24	192
User Adj:	1.00	1.00	1.00	1.00	1.00	1.00	1.00	1.00	1.00	1.00	1.00	1.00
PHF Adj:	1.00	1.00	1.00	1.00	1.00	1.00	1.00	1.00	1.00	1.00	1.00	1.00
PHF Volume:	21	840	121	207	1718	38	99	60	59	213	24	192
Reduct Vol:	0	0	0	0	0	0	0	0	0	0	0	0
Reduced Vol:	21	840	121	207	1718	38	99	60	59	213	24	192
PCE Adj:	1.00	1.00	1.00	1.00	1.00	1.00	1.00	1.00	1.00	1.00	1.00	1.00
MLF Adj:	1.00	1.00	1.00	1.00	1.00	1.00	1.00	1.00	1.00	1.00	1.00	1.00
Final Volume:	21	840	121	207	1718	38	99	60	59	213	24	192

Saturation Flow Module:

Sat/Lane:	1600	1600	1600	1600	1600	1600	1600	1600	1600	1600	1600	1600
Adjustment:	1.00	1.05	1.00	1.00	1.04	1.00	1.00	1.06	1.00	1.00	1.06	1.00
Lanes:	1.00	2.62	0.38	1.00	2.94	0.06	1.00	1.01	0.99	1.00	1.00	1.00
Final Sat.:	1600	4396	604	1600	4896	104	1600	1713	1587	1600	1700	1600

Capacity Analysis Module:

Vol/Sat:	0.01	0.19	0.20	0.13	0.35	0.37	0.06	0.04	0.04	0.13	0.01	0.12
Crit Moves:	****					****	****					****

Santa Ana Circulation Element

Level Of Service Computation Report

ICU 1(Loss as Cycle Length %) Method (Base Volume Alternative)

Intersection #75 Grand Ave and Santa Clara Ave

Cycle (sec): 100 Critical Vol./Cap.(X): 0.843
 Loss Time (sec): 5 Average Delay (sec/veh): xxxxxx
 Optimal Cycle: 63 Level Of Service: D

Approach:	North Bound			South Bound			East Bound			West Bound		
Movement:	L	T	R	L	T	R	L	T	R	L	T	R
Control:	Protected			Protected			Permitted			Permitted		
Rights:	Include			WideBypass			Include			Include		
Min. Green:	0	0	0	0	0	0	0	0	0	0	0	0
Y+R:	4.0	4.0	4.0	4.0	4.0	4.0	4.0	4.0	4.0	4.0	4.0	4.0
Lanes:	1	0	2	1	0	2	1	0	0	1	0	1

Volume Module:

Base Vol:	75	528	136	345	1687	380	143	233	48	200	385	352
Growth Adj:	1.00	1.00	1.00	1.00	1.00	1.00	1.00	1.00	1.00	1.00	1.00	1.00
Initial Bse:	75	528	136	345	1687	380	143	233	48	200	385	352
User Adj:	1.00	1.00	1.00	1.00	1.00	1.00	1.00	1.00	1.00	1.00	1.00	1.00
PHF Adj:	1.00	1.00	1.00	1.00	1.00	1.00	1.00	1.00	1.00	1.00	1.00	1.00
PHF Volume:	75	528	136	345	1687	380	143	233	48	200	385	352
Reduct Vol:	0	0	0	0	0	0	0	0	0	0	0	0
Reduced Vol:	75	528	136	345	1687	380	143	233	48	200	385	352
PCE Adj:	1.00	1.00	1.00	1.00	1.00	1.00	1.00	1.00	1.00	1.00	1.00	1.00
MLF Adj:	1.00	1.00	1.00	1.00	1.00	1.00	1.00	1.00	1.00	1.00	1.00	1.00
FinalVolume:	75	528	136	345	1687	380	143	233	48	200	385	352

Saturation Flow Module:

Sat/Lane:	1600	1600	1600	1600	1600	1600	1600	1600	1600	1600	1600	1600
Adjustment:	1.00	1.05	1.00	1.00	1.05	1.00	1.00	1.00	1.00	1.00	1.06	1.00
Lanes:	1.00	2.39	0.61	1.00	2.45	0.55	1.00	0.83	0.17	1.00	1.00	1.00
Final Sat.:	1600	4017	983	1600	4118	882	1600	1327	273	1600	1700	1600

Capacity Analysis Module:

Vol/Sat:	0.05	0.13	0.14	0.22	0.41	0.43	0.09	0.18	0.18	0.13	0.23	0.22
Crit Moves:	****					****	****				****	

Santa Ana Circulation Element

Level Of Service Computation Report

ICU 1(Loss as Cycle Length %) Method (Base Volume Alternative)

Intersection #76 Grand Ave and 17th St

Cycle (sec): 100 Critical Vol./Cap.(X): 0.794
 Loss Time (sec): 5 Average Delay (sec/veh): xxxxxx
 Optimal Cycle: 51 Level Of Service: C

Approach:	North Bound			South Bound			East Bound			West Bound		
Movement:	L	T	R	L	T	R	L	T	R	L	T	R
Control:	Protected			Protected			Protected			Protected		
Rights:	Include			Include			Include			Include		
Min. Green:	0	0	0	0	0	0	0	0	0	0	0	0
Y+R:	4.0	4.0	4.0	4.0	4.0	4.0	4.0	4.0	4.0	4.0	4.0	4.0
Lanes:	1	0	2	1	0	2	2	0	2	1	0	2

Volume Module:

Base Vol:	186	543	373	340	1426	280	198	739	94	342	894	98
Growth Adj:	1.00	1.00	1.00	1.00	1.00	1.00	1.00	1.00	1.00	1.00	1.00	1.00
Initial Bse:	186	543	373	340	1426	280	198	739	94	342	894	98
User Adj:	1.00	1.00	1.00	1.00	1.00	1.00	1.00	1.00	1.00	1.00	1.00	1.00
PHF Adj:	1.00	1.00	1.00	1.00	1.00	1.00	1.00	1.00	1.00	1.00	1.00	1.00
PHF Volume:	186	543	373	340	1426	280	198	739	94	342	894	98
Reduct Vol:	0	0	0	0	0	0	0	0	0	0	0	0
Reduced Vol:	186	543	373	340	1426	280	198	739	94	342	894	98
PCE Adj:	1.00	1.00	1.00	1.00	1.00	1.00	1.00	1.00	1.00	1.00	1.00	1.00
MLF Adj:	1.00	1.00	1.00	1.00	1.00	1.00	1.00	1.00	1.00	1.00	1.00	1.00
Final Volume:	186	543	373	340	1426	280	198	739	94	342	894	98

Saturation Flow Module:

Sat/Lane:	1600	1600	1600	1600	1600	1600	1600	1600	1600	1600	1600	1600
Adjustment:	1.00	1.06	1.00	1.00	1.05	1.00	1.00	1.05	1.00	1.00	1.05	1.00
Lanes:	1.00	2.00	1.00	1.00	2.51	0.49	2.00	2.66	0.34	2.00	2.70	0.30
Final Sat.:	1600	3400	1600	1600	4212	788	3200	4458	542	3200	4526	474

Capacity Analysis Module:

Vol/Sat:	0.12	0.16	0.23	0.21	0.34	0.36	0.06	0.17	0.17	0.11	0.20	0.21
Crit Moves:	****					****	****			****		

Santa Ana Circulation Element

Level Of Service Computation Report
 2000 HCM Operations Method (Base Volume Alternative)

 Intersection #77 Grand Ave and I-5 NB Ramps

Cycle (sec): 100 Critical Vol./Cap.(X): 0.740
 Loss Time (sec): 5 Average Delay (sec/veh): 13.2
 Optimal Cycle: 44 Level Of Service: B

Approach:	North Bound			South Bound			East Bound			West Bound		
Movement:	L	T	R	L	T	R	L	T	R	L	T	R
Control:	Protected			Protected			Split Phase			Split Phase		
Rights:	Ignore			Include			Include			Include		
Min. Green:	0	0	0	0	0	0	0	0	0	0	0	0
Y+R:	4.0	4.0	4.0	4.0	4.0	4.0	4.0	4.0	4.0	4.0	4.0	4.0
Lanes:	0	0	2	0	1	1	0	0	3	0	0	0

Volume Module:

Base Vol:	0	1056	610	90	2893	0	0	0	0	507	0	140
Growth Adj:	1.00	1.00	1.00	1.00	1.00	1.00	1.00	1.00	1.00	1.00	1.00	1.00
Initial Bse:	0	1056	610	90	2893	0	0	0	0	507	0	140
User Adj:	1.00	1.00	0.00	1.00	1.00	1.00	1.00	1.00	1.00	1.00	1.00	1.00
PHF Adj:	1.00	1.00	0.00	1.00	1.00	1.00	1.00	1.00	1.00	1.00	1.00	1.00
PHF Volume:	0	1056	0	90	2893	0	0	0	0	507	0	140
Reduct Vol:	0	0	0	0	0	0	0	0	0	0	0	0
Reduced Vol:	0	1056	0	90	2893	0	0	0	0	507	0	140
PCE Adj:	1.00	1.00	0.00	1.00	1.00	1.00	1.00	1.00	1.00	1.00	1.00	1.00
MLF Adj:	1.00	1.00	0.00	1.00	1.00	1.00	1.00	1.00	1.00	1.00	1.00	1.00
FinalVolume:	0	1056	0	90	2893	0	0	0	0	507	0	140

Saturation Flow Module:

Sat/Lane:	1900	1900	1900	1900	1900	1900	1900	1900	1900	1900	1900	1900
Adjustment:	1.00	0.95	1.00	0.95	0.91	1.00	1.00	1.00	1.00	0.92	1.00	0.85
Lanes:	0.00	2.00	1.00	1.00	3.00	0.00	0.00	0.00	0.00	2.00	0.00	1.00
Final Sat.:	0	3610	1900	1805	5187	0	0	0	0	3502	0	1615

Capacity Analysis Module:

Vol/Sat:	0.00	0.29	0.00	0.05	0.56	0.00	0.00	0.00	0.00	0.14	0.00	0.09
Crit Moves:	****			****						****		
Green/Cycle:	0.00	0.64	0.00	0.11	0.75	0.00	0.00	0.00	0.00	0.20	0.00	0.20
Volume/Cap:	0.00	0.45	0.00	0.45	0.74	0.00	0.00	0.00	0.00	0.74	0.00	0.44
Delay/Veh:	0.0	9.1	0.0	43.3	7.6	0.0	0.0	0.0	0.0	42.1	0.0	36.4
User DelAdj:	1.00	1.00	1.00	1.00	1.00	1.00	1.00	1.00	1.00	1.00	1.00	1.00
AdjDel/Veh:	0.0	9.1	0.0	43.3	7.6	0.0	0.0	0.0	0.0	42.1	0.0	36.4
LOS by Move:	A	A	A	D	A	A	A	A	A	D	A	D
HCM2k85thQ:	0	13	0	5	28	0	0	0	0	14	0	7

 Note: Queue reported is the number of cars per lane.

Santa Ana Circulation Element

Level Of Service Computation Report
 2000 HCM Operations Method (Base Volume Alternative)

 Intersection #78 Grand Ave and Santa Ana Blvd

Cycle (sec): 100 Critical Vol./Cap.(X): 0.832
 Loss Time (sec): 5 Average Delay (sec/veh): 26.0
 Optimal Cycle: 62 Level Of Service: C

Approach:	North Bound			South Bound			East Bound			West Bound		
Movement:	L	T	R	L	T	R	L	T	R	L	T	R
Control:	Protected			Protected			Split Phase			Split Phase		
Rights:	Include			Ovl			Include			Include		
Min. Green:	0	0	0	0	0	0	0	0	0	0	0	0
Y+R:	4.0	4.0	4.0	4.0	4.0	4.0	4.0	4.0	4.0	4.0	4.0	4.0
Lanes:	1	0	2	1	0	2	2	0	1	0	1	0

Volume Module:

Base Vol:	49	694	35	202	1670	1473	268	221	436	6	475	43
Growth Adj:	1.00	1.00	1.00	1.00	1.00	1.00	1.00	1.00	1.00	1.00	1.00	1.00
Initial Bse:	49	694	35	202	1670	1473	268	221	436	6	475	43
User Adj:	1.00	1.00	1.00	1.00	1.00	1.00	1.00	1.00	1.00	1.00	1.00	1.00
PHF Adj:	1.00	1.00	1.00	1.00	1.00	1.00	1.00	1.00	1.00	1.00	1.00	1.00
PHF Volume:	49	694	35	202	1670	1473	268	221	436	6	475	43
Reduct Vol:	0	0	0	0	0	0	0	0	0	0	0	0
Reduced Vol:	49	694	35	202	1670	1473	268	221	436	6	475	43
PCE Adj:	1.00	1.00	1.00	1.00	1.00	1.00	1.00	1.00	1.00	1.00	1.00	1.00
MLF Adj:	1.00	1.00	1.00	1.00	1.00	1.00	1.00	1.00	1.00	1.00	1.00	1.00
FinalVolume:	49	694	35	202	1670	1473	268	221	436	6	475	43

Saturation Flow Module:

Sat/Lane:	1900	1900	1900	1900	1900	1900	1900	1900	1900	1900	1900	1900
Adjustment:	0.95	0.90	0.90	0.95	0.95	0.75	0.92	1.00	0.75	0.94	0.94	0.94
Lanes:	1.00	2.86	0.14	1.00	2.00	2.00	2.00	1.00	2.00	0.02	1.82	0.16
Final Sat.:	1805	4903	247	1805	3610	2842	3502	1900	2842	41	3230	292

Capacity Analysis Module:

Vol/Sat:	0.03	0.14	0.14	0.11	0.46	0.52	0.08	0.12	0.15	0.15	0.15	0.15
Crit Moves:	****			****					****	****		
Green/Cycle:	0.03	0.33	0.33	0.26	0.56	0.74	0.18	0.18	0.18	0.18	0.18	0.18
Volume/Cap:	0.83	0.43	0.43	0.43	0.83	0.70	0.42	0.63	0.83	0.83	0.83	0.83
Delay/Veh:	109.2	26.4	26.4	31.5	21.4	8.1	36.5	41.3	50.1	48.9	48.9	48.9
User DelAdj:	1.00	1.00	1.00	1.00	1.00	1.00	1.00	1.00	1.00	1.00	1.00	1.00
AdjDel/Veh:	109.2	26.4	26.4	31.5	21.4	8.1	36.5	41.3	50.1	48.9	48.9	48.9
LOS by Move:	F	C	C	C	C	A	D	D	D	D	D	D
HCM2k85thQ:	5	10	10	8	35	22	6	11	15	16	16	16

Note: Queue reported is the number of cars per lane.

Santa Ana Circulation Element

Level Of Service Computation Report

ICU 1(Loss as Cycle Length %) Method (Base Volume Alternative)

Intersection #79 Grand Ave and 1st St

Cycle (sec): 100 Critical Vol./Cap.(X): 0.742
 Loss Time (sec): 5 Average Delay (sec/veh): xxxxxx
 Optimal Cycle: 42 Level Of Service: C

Approach:	North Bound			South Bound			East Bound			West Bound		
Movement:	L	T	R	L	T	R	L	T	R	L	T	R
Control:	Protected			Protected			Protected			Protected		
Rights:	Include			Include			Include			Include		
Min. Green:	0	0	0	0	0	0	0	0	0	0	0	0
Y+R:	4.0	4.0	4.0	4.0	4.0	4.0	4.0	4.0	4.0	4.0	4.0	4.0
Lanes:	2	0	2	1	0	0	2	0	2	1	0	0

Volume Module:

Base Vol:	208	732	34	99	1432	174	436	1041	295	216	759	87
Growth Adj:	1.00	1.00	1.00	1.00	1.00	1.00	1.00	1.00	1.00	1.00	1.00	1.00
Initial Bse:	208	732	34	99	1432	174	436	1041	295	216	759	87
User Adj:	1.00	1.00	1.00	1.00	1.00	1.00	1.00	1.00	1.00	1.00	1.00	1.00
PHF Adj:	1.00	1.00	1.00	1.00	1.00	1.00	1.00	1.00	1.00	1.00	1.00	1.00
PHF Volume:	208	732	34	99	1432	174	436	1041	295	216	759	87
Reduct Vol:	0	0	0	0	0	0	0	0	0	0	0	0
Reduced Vol:	208	732	34	99	1432	174	436	1041	295	216	759	87
PCE Adj:	1.00	1.00	1.00	1.00	1.00	1.00	1.00	1.00	1.00	1.00	1.00	1.00
MLF Adj:	1.00	1.00	1.00	1.00	1.00	1.00	1.00	1.00	1.00	1.00	1.00	1.00
FinalVolume:	208	732	34	99	1432	174	436	1041	295	216	759	87

Saturation Flow Module:

Sat/Lane:	1600	1600	1600	1600	1600	1600	1600	1600	1600	1600	1600	1600
Adjustment:	1.00	1.04	1.00	1.00	1.06	1.00	1.00	1.05	1.00	1.00	1.05	1.00
Lanes:	2.00	2.87	0.13	2.00	3.00	1.00	2.00	2.34	0.66	2.00	2.69	0.31
Final Sat.:	3200	4787	213	3200	5100	1600	3200	3940	1060	3200	4506	494

Capacity Analysis Module:

Vol/Sat:	0.07	0.15	0.16	0.03	0.28	0.11	0.14	0.26	0.28	0.07	0.17	0.18
Crit Moves:	****			****			****		****	****		

Santa Ana Circulation Element

Level Of Service Computation Report

ICU 1(Loss as Cycle Length %) Method (Base Volume Alternative)

Intersection #80 Grand Ave and Chestnut Ave

Cycle (sec): 100 Critical Vol./Cap.(X): 0.704
 Loss Time (sec): 5 Average Delay (sec/veh): xxxxxx
 Optimal Cycle: 38 Level Of Service: C

Approach:	North Bound			South Bound			East Bound			West Bound		
Movement:	L	T	R	L	T	R	L	T	R	L	T	R
Control:	Protected			Protected			Permitted			Permitted		
Rights:	Include			Include			Include			Include		
Min. Green:	0	0	0	0	0	0	0	0	0	0	0	0
Y+R:	4.0	4.0	4.0	4.0	4.0	4.0	4.0	4.0	4.0	4.0	4.0	4.0
Lanes:	1	0	2	1	0	2	1	0	1	1	0	1

Volume Module:

Base Vol:	53	737	163	161	1937	53	34	239	63	130	384	239
Growth Adj:	1.00	1.00	1.00	1.00	1.00	1.00	1.00	1.00	1.00	1.00	1.00	1.00
Initial Bse:	53	737	163	161	1937	53	34	239	63	130	384	239
User Adj:	1.00	1.00	1.00	1.00	1.00	1.00	1.00	1.00	1.00	1.00	1.00	1.00
PHF Adj:	1.00	1.00	1.00	1.00	1.00	1.00	1.00	1.00	1.00	1.00	1.00	1.00
PHF Volume:	53	737	163	161	1937	53	34	239	63	130	384	239
Reduct Vol:	0	0	0	0	0	0	0	0	0	0	0	0
Reduced Vol:	53	737	163	161	1937	53	34	239	63	130	384	239
PCE Adj:	1.00	1.00	1.00	1.00	1.00	1.00	1.00	1.00	1.00	1.00	1.00	1.00
MLF Adj:	1.00	1.00	1.00	1.00	1.00	1.00	1.00	1.00	1.00	1.00	1.00	1.00
FinalVolume:	53	737	163	161	1937	53	34	239	63	130	384	239

Saturation Flow Module:

Sat/Lane:	1600	1600	1600	1600	1600	1600	1600	1600	1600	1600	1600	1600
Adjustment:	1.00	1.05	1.00	1.00	1.04	1.00	1.00	1.04	1.00	1.00	1.05	1.00
Lanes:	1.00	2.46	0.54	1.00	2.92	0.08	1.00	1.58	0.42	1.00	1.23	0.77
Final Sat.:	1600	4131	869	1600	4872	128	1600	2632	668	1600	2072	1228

Capacity Analysis Module:

Vol/Sat:	0.03	0.18	0.19	0.10	0.40	0.41	0.02	0.09	0.09	0.08	0.19	0.19
Crit Moves:	****					****	****				****	

Santa Ana Circulation Element

Level Of Service Computation Report

ICU 1(Loss as Cycle Length %) Method (Base Volume Alternative)

Intersection #81 Grand Ave and McFadden Ave

Cycle (sec): 100 Critical Vol./Cap.(X): 0.892
 Loss Time (sec): 5 Average Delay (sec/veh): xxxxxx
 Optimal Cycle: 82 Level Of Service: D

Approach:	North Bound			South Bound			East Bound			West Bound		
Movement:	L	T	R	L	T	R	L	T	R	L	T	R
Control:	Protected			Protected			Protected			Protected		
Rights:	Include			Include			Include			Include		
Min. Green:	0	0	0	0	0	0	0	0	0	0	0	0
Y+R:	4.0	4.0	4.0	4.0	4.0	4.0	4.0	4.0	4.0	4.0	4.0	4.0
Lanes:	1	0	2	1	0	2	1	0	1	1	0	1

Volume Module:

Base Vol:	181	764	114	249	1672	163	205	663	201	123	440	111
Growth Adj:	1.00	1.00	1.00	1.00	1.00	1.00	1.00	1.00	1.00	1.00	1.00	1.00
Initial Bse:	181	764	114	249	1672	163	205	663	201	123	440	111
User Adj:	1.00	1.00	1.00	1.00	1.00	1.00	1.00	1.00	1.00	1.00	1.00	1.00
PHF Adj:	1.00	1.00	1.00	1.00	1.00	1.00	1.00	1.00	1.00	1.00	1.00	1.00
PHF Volume:	181	764	114	249	1672	163	205	663	201	123	440	111
Reduct Vol:	0	0	0	0	0	0	0	0	0	0	0	0
Reduced Vol:	181	764	114	249	1672	163	205	663	201	123	440	111
PCE Adj:	1.00	1.00	1.00	1.00	1.00	1.00	1.00	1.00	1.00	1.00	1.00	1.00
MLF Adj:	1.00	1.00	1.00	1.00	1.00	1.00	1.00	1.00	1.00	1.00	1.00	1.00
FinalVolume:	181	764	114	249	1672	163	205	663	201	123	440	111

Saturation Flow Module:

Sat/Lane:	1600	1600	1600	1600	1600	1600	1600	1600	1600	1600	1600	1600
Adjustment:	1.00	1.05	1.00	1.00	1.05	1.00	1.00	1.04	1.00	1.00	1.04	1.00
Lanes:	1.00	2.61	0.39	1.00	2.73	0.27	1.00	1.53	0.47	1.00	1.60	0.40
Final Sat.:	1600	4377	623	1600	4574	426	1600	2556	744	1600	2655	645

Capacity Analysis Module:

Vol/Sat:	0.11	0.17	0.18	0.16	0.37	0.38	0.13	0.26	0.27	0.08	0.17	0.17
Crit Moves:	****				****			****		****		

Santa Ana Circulation Element

Level Of Service Computation Report

ICU 1(Loss as Cycle Length %) Method (Base Volume Alternative)

Intersection #82 Grand Ave and Edinger Ave

Cycle (sec): 100 Critical Vol./Cap.(X): 0.838
 Loss Time (sec): 5 Average Delay (sec/veh): xxxxxx
 Optimal Cycle: 61 Level Of Service: D

Approach:	North Bound			South Bound			East Bound			West Bound		
Movement:	L	T	R	L	T	R	L	T	R	L	T	R
Control:	Protected			Protected			Protected			Protected		
Rights:	Include			Include			Include			Include		
Min. Green:	0	0	0	0	0	0	0	0	0	0	0	0
Y+R:	4.0	4.0	4.0	4.0	4.0	4.0	4.0	4.0	4.0	4.0	4.0	4.0
Lanes:	1	0	2	1	0	2	1	0	2	1	0	2

Volume Module:

Base Vol:	47	472	92	243	1244	243	347	1447	139	189	724	158
Growth Adj:	1.00	1.00	1.00	1.00	1.00	1.00	1.00	1.00	1.00	1.00	1.00	1.00
Initial Bse:	47	472	92	243	1244	243	347	1447	139	189	724	158
User Adj:	1.00	1.00	1.00	1.00	1.00	1.00	1.00	1.00	1.00	1.00	1.00	1.00
PHF Adj:	1.00	1.00	1.00	1.00	1.00	1.00	1.00	1.00	1.00	1.00	1.00	1.00
PHF Volume:	47	472	92	243	1244	243	347	1447	139	189	724	158
Reduct Vol:	0	0	0	0	0	0	0	0	0	0	0	0
Reduced Vol:	47	472	92	243	1244	243	347	1447	139	189	724	158
PCE Adj:	1.00	1.00	1.00	1.00	1.00	1.00	1.00	1.00	1.00	1.00	1.00	1.00
MLF Adj:	1.00	1.00	1.00	1.00	1.00	1.00	1.00	1.00	1.00	1.00	1.00	1.00
FinalVolume:	47	472	92	243	1244	243	347	1447	139	189	724	158

Saturation Flow Module:

Sat/Lane:	1600	1600	1600	1600	1600	1600	1600	1600	1600	1600	1600	1600
Adjustment:	1.00	1.05	1.00	1.00	1.05	1.00	1.00	1.05	1.00	1.00	1.05	1.00
Lanes:	1.00	2.51	0.49	1.00	2.51	0.49	1.00	2.74	0.26	1.00	2.46	0.54
Final Sat.:	1600	4217	783	1600	4216	784	1600	4579	421	1600	4140	860

Capacity Analysis Module:

Vol/Sat:	0.03	0.11	0.12	0.15	0.30	0.31	0.22	0.32	0.33	0.12	0.17	0.18
Crit Moves:	****					****			****	****		

Santa Ana Circulation Element

Level Of Service Computation Report

ICU 1(Loss as Cycle Length %) Method (Base Volume Alternative)

Intersection #83 Grand Ave and Warner Ave

Cycle (sec): 100 Critical Vol./Cap.(X): 0.613
 Loss Time (sec): 5 Average Delay (sec/veh): xxxxxx
 Optimal Cycle: 30 Level Of Service: B

Approach:	North Bound			South Bound			East Bound			West Bound		
Movement:	L	T	R	L	T	R	L	T	R	L	T	R
Control:	Protected			Protected			Protected			Protected		
Rights:	Include			Include			Include			Include		
Min. Green:	0	0	0	0	0	0	0	0	0	0	0	0
Y+R:	4.0	4.0	4.0	4.0	4.0	4.0	4.0	4.0	4.0	4.0	4.0	4.0
Lanes:	1	0	2	1	0	2	1	0	3	2	0	2

Volume Module:	North Bound			South Bound			East Bound			West Bound		
Base Vol:	142	429	184	183	528	178	333	1188	467	92	406	137
Growth Adj:	1.00	1.00	1.00	1.00	1.00	1.00	1.00	1.00	1.00	1.00	1.00	1.00
Initial Bse:	142	429	184	183	528	178	333	1188	467	92	406	137
User Adj:	1.00	1.00	1.00	1.00	1.00	1.00	1.00	1.00	1.00	1.00	1.00	1.00
PHF Adj:	1.00	1.00	1.00	1.00	1.00	1.00	1.00	1.00	1.00	1.00	1.00	1.00
PHF Volume:	142	429	184	183	528	178	333	1188	467	92	406	137
Reduct Vol:	0	0	0	0	0	0	0	0	0	0	0	0
Reduced Vol:	142	429	184	183	528	178	333	1188	467	92	406	137
PCE Adj:	1.00	1.00	1.00	1.00	1.00	1.00	1.00	1.00	1.00	1.00	1.00	1.00
MLF Adj:	1.00	1.00	1.00	1.00	1.00	1.00	1.00	1.00	1.00	1.00	1.00	1.00
Final Volume:	142	429	184	183	528	178	333	1188	467	92	406	137

Saturation Flow Module:	North Bound			South Bound			East Bound			West Bound		
Sat/Lane:	1600	1600	1600	1600	1600	1600	1600	1600	1600	1600	1600	1600
Adjustment:	1.00	1.06	1.00	1.00	1.06	1.00	1.00	1.06	1.00	1.00	1.06	1.00
Lanes:	1.00	2.10	0.90	1.00	2.24	0.76	2.00	3.00	1.00	2.00	2.24	0.76
Final Sat.:	1600	3559	1441	1600	3790	1210	3200	5100	1600	3200	3789	1211

Capacity Analysis Module:	North Bound			South Bound			East Bound			West Bound		
Vol/Sat:	0.09	0.12	0.13	0.11	0.14	0.15	0.10	0.23	0.29	0.03	0.11	0.11
Crit Moves:	****			****			****			****		

Santa Ana Circulation Element

Level Of Service Computation Report

2000 HCM Operations Method (Base Volume Alternative)

 Intersection #84 SR-55 NB Ramps and Dyer Rd

Cycle (sec): 100 Critical Vol./Cap.(X): 0.569
 Loss Time (sec): 5 Average Delay (sec/veh): 17.1
 Optimal Cycle: 28 Level Of Service: B

Approach:	North Bound			South Bound			East Bound			West Bound		
Movement:	L	T	R	L	T	R	L	T	R	L	T	R
Control:	Split Phase			Split Phase			Protected			Protected		
Rights:	Include			Include			Ignore			Ignore		
Min. Green:	0	0	0	0	0	0	0	0	0	0	0	0
Y+R:	4.0	4.0	4.0	4.0	4.0	4.0	4.0	4.0	4.0	4.0	4.0	4.0
Lanes:	1	0	1	0	0	0	0	0	3	0	2	1

Volume Module:	North Bound			South Bound			East Bound			West Bound		
Base Vol:	610	0	499	0	0	0	0	1618	647	0	599	361
Growth Adj:	1.00	1.00	1.00	1.00	1.00	1.00	1.00	1.00	1.00	1.00	1.00	1.00
Initial Bse:	610	0	499	0	0	0	0	1618	647	0	599	361
User Adj:	1.00	1.00	1.00	1.00	1.00	1.00	1.00	1.00	0.00	1.00	1.00	0.00
PHF Adj:	1.00	1.00	1.00	1.00	1.00	1.00	1.00	1.00	0.00	1.00	1.00	0.00
PHF Volume:	610	0	499	0	0	0	0	1618	0	0	599	0
Reduct Vol:	0	0	0	0	0	0	0	0	0	0	0	0
Reduced Vol:	610	0	499	0	0	0	0	1618	0	0	599	0
PCE Adj:	1.00	1.00	1.00	1.00	1.00	1.00	1.00	1.00	0.00	1.00	1.00	0.00
MLF Adj:	1.00	1.00	1.00	1.00	1.00	1.00	1.00	1.00	0.00	1.00	1.00	0.00
Final Volume:	610	0	499	0	0	0	0	1618	0	0	599	0

Saturation Flow Module:	North Bound			South Bound			East Bound			West Bound		
Sat/Lane:	1900	1900	1900	1900	1900	1900	1900	1900	1900	1900	1900	1900
Adjustment:	0.91	1.00	0.91	1.00	1.00	1.00	1.00	0.91	1.00	1.00	0.91	0.91
Lanes:	1.55	0.00	1.45	0.00	0.00	0.00	0.00	3.00	1.00	0.00	3.00	0.00
Final Sat.:	2674	0	2501	0	0	0	0	5187	1900	0	5187	0

Capacity Analysis Module:	North Bound			South Bound			East Bound			West Bound		
Vol/Sat:	0.23	0.00	0.20	0.00	0.00	0.00	0.00	0.31	0.00	0.00	0.12	0.00
Crit Moves:	****			****			****			****		
Green/Cycle:	0.40	0.00	0.40	0.00	0.00	0.00	0.00	0.55	0.00	0.00	0.55	0.00
Volume/Cap:	0.57	0.00	0.50	0.00	0.00	0.00	0.00	0.57	0.00	0.00	0.21	0.00
Delay/Veh:	23.6	0.0	22.6	0.0	0.0	0.0	0.0	15.1	0.0	0.0	11.6	0.0
User DelAdj:	1.00	1.00	1.00	1.00	1.00	1.00	1.00	1.00	1.00	1.00	1.00	1.00
AdjDel/Veh:	23.6	0.0	22.6	0.0	0.0	0.0	0.0	15.1	0.0	0.0	11.6	0.0
LOS by Move:	C	A	C	A	A	A	A	B	A	A	B	A
HCM2k85thQ:	15	0	12	0	0	0	0	18	0	0	5	0

 Note: Queue reported is the number of cars per lane.

Santa Ana Circulation Element

Level Of Service Computation Report
 2000 HCM 4-Way Stop Method (Base Volume Alternative)

 Intersection #85 Cambridge St and La Veta Ave

Cycle (sec): 100 Critical Vol./Cap.(X): 0.971
 Loss Time (sec): 5 Average Delay (sec/veh): 31.6
 Optimal Cycle: 0 Level Of Service: D

Approach:	North Bound			South Bound			East Bound			West Bound		
Movement:	L	T	R	L	T	R	L	T	R	L	T	R
Control:	Stop Sign			Stop Sign			Stop Sign			Stop Sign		
Rights:	Include			Include			Include			Include		
Min. Green:	0	0	0	0	0	0	0	0	0	0	0	0
Lanes:	1	0	1	0	0	1	1	0	0	0	0	0

Volume Module:

Base Vol:	185	235	0	0	480	245	273	0	436	0	0	0
Growth Adj:	1.00	1.00	1.00	1.00	1.00	1.00	1.00	1.00	1.00	1.00	1.00	1.00
Initial Bse:	185	235	0	0	480	245	273	0	436	0	0	0
User Adj:	1.00	1.00	1.00	1.00	1.00	1.00	1.00	1.00	1.00	1.00	1.00	1.00
PHF Adj:	1.00	1.00	1.00	1.00	1.00	1.00	1.00	1.00	1.00	1.00	1.00	1.00
PHF Volume:	185	235	0	0	480	245	273	0	436	0	0	0
Reduct Vol:	0	0	0	0	0	0	0	0	0	0	0	0
Reduced Vol:	185	235	0	0	480	245	273	0	436	0	0	0
PCE Adj:	1.00	1.00	1.00	1.00	1.00	1.00	1.00	1.00	1.00	1.00	1.00	1.00
MLF Adj:	1.00	1.00	1.00	1.00	1.00	1.00	1.00	1.00	1.00	1.00	1.00	1.00
FinalVolume:	185	235	0	0	480	245	273	0	436	0	0	0

Saturation Flow Module:

Adjustment:	1.00	1.00	1.00	1.00	1.00	1.00	1.00	1.00	1.00	1.00	1.00	1.00
Lanes:	1.00	1.00	0.00	0.00	1.00	1.00	1.00	0.00	1.00	0.00	0.00	0.00
Final Sat.:	434	463	0	0	494	537	458	0	539	0	0	0

Capacity Analysis Module:

Vol/Sat:	0.43	0.51	xxxx	xxxx	0.97	0.46	0.60	xxxx	0.81	xxxx	xxxx	xxxx
Crit Moves:	****			****			****			****		
Delay/Veh:	16.6	17.7	0.0	0.0	59.7	14.5	21.1	0.0	30.8	0.0	0.0	0.0
Delay Adj:	1.00	1.00	1.00	1.00	1.00	1.00	1.00	1.00	1.00	1.00	1.00	1.00
AdjDel/Veh:	16.6	17.7	0.0	0.0	59.7	14.5	21.1	0.0	30.8	0.0	0.0	0.0
LOS by Move:	C	C	*	*	F	B	C	*	D	*	*	*
ApproachDel:	17.2			44.4			27.1			xxxxxxx		
Delay Adj:	1.00			1.00			1.00			xxxxxxx		
ApprAdjDel:	17.2			44.4			27.1			xxxxxxx		
LOS by Appr:	C			E			D			*		
AllWayAvgQ:	0.7	0.9	0.0	0.0	6.8	0.8	1.4	0.0	3.2	0.0	0.0	0.0

 Note: Queue reported is the number of cars per lane.

Santa Ana Circulation Element

Level Of Service Computation Report

ICU 1(Loss as Cycle Length %) Method (Base Volume Alternative)

 Intersection #86 Cambridge St and Fairhaven Ave

Cycle (sec): 100 Critical Vol./Cap.(X): 0.563
 Loss Time (sec): 5 Average Delay (sec/veh): xxxxxx
 Optimal Cycle: 27 Level Of Service: A

Approach:	North Bound			South Bound			East Bound			West Bound		
Movement:	L	T	R	L	T	R	L	T	R	L	T	R
Control:	Permitted			Permitted			Permitted			Permitted		
Rights:	Include			Include			Include			Include		
Min. Green:	0	0	0	0	0	0	0	0	0	0	0	0
Y+R:	4.0	4.0	4.0	4.0	4.0	4.0	4.0	4.0	4.0	4.0	4.0	4.0
Lanes:	0	0	0	1	0	0	1	0	2	0	0	1

Volume Module:	North Bound			South Bound			East Bound			West Bound		
Base Vol:	0	0	0	567	0	183	80	216	0	0	195	152
Growth Adj:	1.00	1.00	1.00	1.00	1.00	1.00	1.00	1.00	1.00	1.00	1.00	1.00
Initial Bse:	0	0	0	567	0	183	80	216	0	0	195	152
User Adj:	1.00	1.00	1.00	1.00	1.00	1.00	1.00	1.00	1.00	1.00	1.00	1.00
PHF Adj:	1.00	1.00	1.00	1.00	1.00	1.00	1.00	1.00	1.00	1.00	1.00	1.00
PHF Volume:	0	0	0	567	0	183	80	216	0	0	195	152
Reduct Vol:	0	0	0	0	0	0	0	0	0	0	0	0
Reduced Vol:	0	0	0	567	0	183	80	216	0	0	195	152
PCE Adj:	1.00	1.00	1.00	1.00	1.00	1.00	1.00	1.00	1.00	1.00	1.00	1.00
MLF Adj:	1.00	1.00	1.00	1.00	1.00	1.00	1.00	1.00	1.00	1.00	1.00	1.00
FinalVolume:	0	0	0	567	0	183	80	216	0	0	195	152

Saturation Flow Module:	North Bound			South Bound			East Bound			West Bound		
Sat/Lane:	1600	1600	1600	1600	1600	1600	1600	1600	1600	1600	1600	1600
Adjustment:	1.00	1.06	1.00	1.00	1.06	1.00	1.00	1.06	1.00	1.00	1.06	1.00
Lanes:	0.00	0.00	0.00	1.00	0.00	1.00	1.00	2.00	0.00	0.00	1.12	0.88
Final Sat.:	0	0	0	1600	0	1600	1600	3400	0	0	1898	1402

Capacity Analysis Module:	North Bound			South Bound			East Bound			West Bound		
Vol/Sat:	0.00	0.00	0.00	0.35	0.00	0.11	0.05	0.06	0.00	0.00	0.10	0.11
Crit Moves:				****			****					****

Santa Ana Circulation Element

Level of Service Computation Report
 2000 HCM Operations Method (Base Volume Alternative)

 Intersection #87 Mabury St and 1st Street

Cycle (sec): 100 Critical Vol./Cap.(X): 0.714
 Loss Time (sec): 5 Average Delay (sec/veh): 27.4
 Optimal Cycle: 40 Level of Service: C

Street Name:	Mabury						1st Street					
Approach:	North Bound			South Bound			East Bound			West Bound		
Movement:	L	T	R	L	T	R	L	T	R	L	T	R
Control:	Split Phase			Split Phase			Protected			Protected		
Rights:	Include			Include			Include			Include		
Min. Green:	0	0	0	0	0	0	0	0	0	0	0	0
Y+R:	4.0	4.0	4.0	4.0	4.0	4.0	4.0	4.0	4.0	4.0	4.0	4.0
Lanes:	1	0	0	0	1	0	0	0	2	1	0	2

Volume Module:	Mabury NB			Mabury SB			1st St EB			1st St WB		
Base Vol:	6	0	157	248	147	554	0	1230	13	38	579	0
Growth Adj:	1.00	1.00	1.00	1.00	1.00	1.00	1.00	1.00	1.00	1.00	1.00	1.00
Initial Bse:	6	0	157	248	147	554	0	1230	13	38	579	0
User Adj:	1.00	1.00	1.00	1.00	1.00	1.00	1.00	1.00	1.00	1.00	1.00	1.00
PHF Adj:	1.00	1.00	1.00	1.00	1.00	1.00	1.00	1.00	1.00	1.00	1.00	1.00
PHF Volume:	6	0	157	248	147	554	0	1230	13	38	579	0
Reduct Vol:	0	0	0	0	0	0	0	0	0	0	0	0
Reduced Vol:	6	0	157	248	147	554	0	1230	13	38	579	0
PCE Adj:	1.00	1.00	1.00	1.00	1.00	1.00	1.00	1.00	1.00	1.00	1.00	1.00
MLF Adj:	1.00	1.00	1.00	1.00	1.00	1.00	1.00	1.00	1.00	1.00	1.00	1.00
Final Volume:	6	0	157	248	147	554	0	1230	13	38	579	0

Saturation Flow Module:	Mabury NB			Mabury SB			1st St EB			1st St WB		
Sat/Lane:	1900	1900	1900	1900	1900	1900	1900	1900	1900	1900	1900	1900
Adjustment:	0.95	1.00	0.85	0.90	0.90	0.90	1.00	0.91	0.91	0.95	0.91	0.91
Lanes:	1.00	0.00	1.00	1.23	0.27	1.50	0.00	2.97	0.03	1.00	3.00	0.00
Final Sat.:	1805	0	1615	2097	459	2575	0	5128	54	1805	5187	0

Capacity Analysis Module:	Mabury NB			Mabury SB			1st St EB			1st St WB		
Vol/Sat:	0.00	0.00	0.10	0.12	0.32	0.22	0.00	0.24	0.24	0.02	0.11	0.00
Crit Moves:			****		****			****		****		
Green/Cycle:	0.14	0.00	0.14	0.45	0.45	0.45	0.00	0.34	0.34	0.03	0.37	0.00
Volume/Cap:	0.02	0.00	0.71	0.26	0.71	0.48	0.00	0.71	0.71	0.71	0.31	0.00
Delay/Veh:	37.5	0.0	51.9	17.3	24.2	19.6	0.0	30.4	30.4	84.9	22.8	0.0
User DelAdj:	1.00	1.00	1.00	1.00	1.00	1.00	1.00	1.00	1.00	1.00	1.00	1.00
AdjDel/Veh:	37.5	0.0	51.9	17.3	24.2	19.6	0.0	30.4	30.4	84.9	22.8	0.0
LOS by Move:	D	A	D	B	C	B	A	C	C	F	C	A
HCM2k85thQ:	0	0	10	6	22	12	0	20	20	4	7	0

Note: Queue reported is the number of cars per lane.

Santa Ana Circulation Element

Level of Service Computation Report

ICU 1(Loss as Cycle Length %) Method (Base Volume Alternative)

 Intersection #88 Tustin St and La Veta Ave

Cycle (sec): 100 Critical Vol./Cap.(X): 0.446
 Loss Time (sec): 5 Average Delay (sec/veh): xxxxxx
 Optimal Cycle: 22 Level Of Service: A

Approach:	North Bound			South Bound			East Bound			West Bound		
Movement:	L	T	R	L	T	R	L	T	R	L	T	R
Control:	Protected			Protected			Split Phase			Split Phase		
Rights:	Include			Include			Include			Ovl		
Min. Green:	0	0	0	0	0	0	0	0	0	0	0	0
Y+R:	4.0	4.0	4.0	4.0	4.0	4.0	4.0	4.0	4.0	4.0	4.0	4.0
Lanes:	1	0	2	1	0	2	1	0	1	1	0	0

Volume Module:

Base Vol:	7	301	87	67	1307	4	9	11	35	307	1	47
Growth Adj:	1.00	1.00	1.00	1.00	1.00	1.00	1.00	1.00	1.00	1.00	1.00	1.00
Initial Bse:	7	301	87	67	1307	4	9	11	35	307	1	47
User Adj:	1.00	1.00	1.00	1.00	1.00	1.00	1.00	1.00	1.00	1.00	1.00	1.00
PHF Adj:	1.00	1.00	1.00	1.00	1.00	1.00	1.00	1.00	1.00	1.00	1.00	1.00
PHF Volume:	7	301	87	67	1307	4	9	11	35	307	1	47
Reduct Vol:	0	0	0	0	0	0	0	0	0	0	0	0
Reduced Vol:	7	301	87	67	1307	4	9	11	35	307	1	47
PCE Adj:	1.00	1.00	1.00	1.00	1.00	1.00	1.00	1.00	1.00	1.00	1.00	1.00
MLF Adj:	1.00	1.00	1.00	1.00	1.00	1.00	1.00	1.00	1.00	1.00	1.00	1.00
FinalVolume:	7	301	87	67	1307	4	9	11	35	307	1	47
OvlAdjVol:												0

Saturation Flow Module:

Sat/Lane:	1600	1600	1600	1600	1600	1600	1600	1600	1600	1600	1600	1600
Adjustment:	1.00	1.05	1.00	1.00	1.04	1.00	1.00	1.06	1.00	1.00	1.00	1.00
Lanes:	1.00	2.33	0.67	1.00	2.99	0.01	1.00	1.00	1.00	1.99	0.01	1.00
Final Sat.:	1600	3924	1076	1600	4985	15	1600	1700	1600	3190	10	1600

Capacity Analysis Module:

Vol/Sat:	0.00	0.08	0.08	0.04	0.26	0.27	0.01	0.01	0.02	0.10	0.10	0.03
OvlAdjV/S:												0.00
Crit Moves:	****				****			****			****	

Santa Ana Circulation Element

Level Of Service Computation Report

2000 HCM Operations Method (Base Volume Alternative)

Intersection #89 Tustin St and SR-22 WB On-Ramp

Cycle (sec): 100 Critical Vol./Cap.(X): 0.635
 Loss Time (sec): 5 Average Delay (sec/veh): 12.2
 Optimal Cycle: 33 Level Of Service: B

Approach:	North Bound			South Bound			East Bound			West Bound		
Movement:	L	T	R	L	T	R	L	T	R	L	T	R
Control:	Protected			Permitted			Protected			Protected		
Rights:	Include			Include			Include			Include		
Min. Green:	0	0	0	0	0	0	0	0	0	0	0	0
Y+R:	4.0	4.0	4.0	4.0	4.0	4.0	4.0	4.0	4.0	4.0	4.0	4.0
Lanes:	2	0	2	0	0	2	1	0	0	0	0	0

Volume Module:

Base Vol:	614	571	0	0	1171	699	0	0	0	0	0	0
Growth Adj:	1.00	1.00	1.00	1.00	1.00	1.00	1.00	1.00	1.00	1.00	1.00	1.00
Initial Bse:	614	571	0	0	1171	699	0	0	0	0	0	0
User Adj:	1.00	1.00	1.00	1.00	1.00	1.00	1.00	1.00	1.00	1.00	1.00	1.00
PHF Adj:	1.00	1.00	1.00	1.00	1.00	1.00	1.00	1.00	1.00	1.00	1.00	1.00
PHF Volume:	614	571	0	0	1171	699	0	0	0	0	0	0
Reduct Vol:	0	0	0	0	0	0	0	0	0	0	0	0
Reduced Vol:	614	571	0	0	1171	699	0	0	0	0	0	0
PCE Adj:	1.00	1.00	1.00	1.00	1.00	1.00	1.00	1.00	1.00	1.00	1.00	1.00
MLF Adj:	1.00	1.00	1.00	1.00	1.00	1.00	1.00	1.00	1.00	1.00	1.00	1.00
Final Volume:	614	571	0	0	1171	699	0	0	0	0	0	0

Saturation Flow Module:

Sat/Lane:	1900	1900	1900	1900	1900	1900	1900	1900	1900	1900	1900	1900
Adjustment:	0.92	0.95	1.00	1.00	0.86	0.86	1.00	1.00	1.00	1.00	1.00	1.00
Lanes:	2.00	2.00	0.00	0.00	2.00	1.00	0.00	0.00	0.00	0.00	0.00	0.00
Final Sat.:	3502	3610	0	0	3264	1632	0	0	0	0	0	0

Capacity Analysis Module:

Vol/Sat:	0.18	0.16	0.00	0.00	0.36	0.43	0.00	0.00	0.00	0.00	0.00	0.00
Crit Moves:	****			****								
Green/Cycle:	0.28	0.95	0.00	0.00	0.67	0.67	0.00	0.00	0.00	0.00	0.00	0.00
Volume/Cap:	0.64	0.17	0.00	0.00	0.53	0.64	0.00	0.00	0.00	0.00	0.00	0.00
Delay/Veh:	33.2	0.2	0.0	0.0	8.4	9.8	0.0	0.0	0.0	0.0	0.0	0.0
User DelAdj:	1.00	1.00	1.00	1.00	1.00	1.00	1.00	1.00	1.00	1.00	1.00	1.00
AdjDel/Veh:	33.2	0.2	0.0	0.0	8.4	9.8	0.0	0.0	0.0	0.0	0.0	0.0
LOS by Move:	C	A	A	A	A	A	A	A	A	A	A	A
HCM2k85thQ:	14	1	0	0	15	21	0	0	0	0	0	0

 Note: Queue reported is the number of cars per lane.

Santa Ana Circulation Element

Level Of Service Computation Report

2000 HCM Operations Method (Base Volume Alternative)

 Intersection #90 Tustin St and SR-22 EB Off-Ramp / Seba Ave

Cycle (sec): 100 Critical Vol./Cap.(X): 0.723
 Loss Time (sec): 5 Average Delay (sec/veh): 25.0
 Optimal Cycle: 42 Level Of Service: C

Approach:	North Bound			South Bound			East Bound			West Bound		
Movement:	L	T	R	L	T	R	L	T	R	L	T	R
Control:	Permitted			Permitted			Split Phase			Split Phase		
Rights:	Include			Include			Include			Include		
Min. Green:	0	0	0	0	0	0	0	0	0	0	0	0
Y+R:	4.0	4.0	4.0	4.0	4.0	4.0	4.0	4.0	4.0	4.0	4.0	4.0
Lanes:	0	0	2	1	0	3	0	1	0	1	0	0

Volume Module:

Base Vol:	0	953	5	17	1049	0	275	27	1182	6	0	43
Growth Adj:	1.00	1.00	1.00	1.00	1.00	1.00	1.00	1.00	1.00	1.00	1.00	1.00
Initial Bse:	0	953	5	17	1049	0	275	27	1182	6	0	43
User Adj:	1.00	1.00	1.00	1.00	1.00	1.00	1.00	1.00	1.00	1.00	1.00	1.00
PHF Adj:	1.00	1.00	1.00	1.00	1.00	1.00	1.00	1.00	1.00	1.00	1.00	1.00
PHF Volume:	0	953	5	17	1049	0	275	27	1182	6	0	43
Reduct Vol:	0	0	0	0	0	0	0	0	0	0	0	0
Reduced Vol:	0	953	5	17	1049	0	275	27	1182	6	0	43
PCE Adj:	1.00	1.00	1.00	1.00	1.00	1.00	1.00	1.00	1.00	1.00	1.00	1.00
MLF Adj:	1.00	1.00	1.00	1.00	1.00	1.00	1.00	1.00	1.00	1.00	1.00	1.00
FinalVolume:	0	953	5	17	1049	0	275	27	1182	6	0	43

Saturation Flow Module:

Sat/Lane:	1900	1900	1900	1900	1900	1900	1900	1900	1900	1900	1900	1900
Adjustment:	1.00	0.91	0.91	0.14	0.91	1.00	0.87	0.87	0.87	0.88	1.00	0.88
Lanes:	0.00	2.98	0.02	1.00	3.00	0.00	1.18	0.04	1.78	0.12	0.00	0.88
Final Sat.:	0	5155	27	272	5187	0	1961	59	2956	204	0	1460

Capacity Analysis Module:

Vol/Sat:	0.00	0.18	0.18	0.06	0.20	0.00	0.14	0.46	0.40	0.03	0.00	0.03
Crit Moves:				****			****			****		
Green/Cycle:	0.00	0.28	0.28	0.28	0.28	0.00	0.63	0.63	0.63	0.04	0.00	0.04
Volume/Cap:	0.00	0.66	0.66	0.22	0.72	0.00	0.22	0.72	0.63	0.72	0.00	0.72
Delay/Veh:	0.0	33.0	33.0	29.2	34.4	0.0	8.0	13.9	12.0	79.1	0.0	79.1
User DelAdj:	1.00	1.00	1.00	1.00	1.00	1.00	1.00	1.00	1.00	1.00	1.00	1.00
AdjDel/Veh:	0.0	33.0	33.0	29.2	34.4	0.0	8.0	13.9	12.0	79.1	0.0	79.1
LOS by Move:	A	C	C	C	C	A	A	B	B	E	A	E
HCM2k85thQ:	0	16	16	1	18	0	5	25	19	5	0	5

Note: Queue reported is the number of cars per lane.

Santa Ana Circulation Element

Level Of Service Computation Report

ICU 1(Loss as Cycle Length %) Method (Base Volume Alternative)

Intersection #91 Tustin Ave and Fairhaven Ave

Cycle (sec): 100 Critical Vol./Cap.(X): 1.195
 Loss Time (sec): 5 Average Delay (sec/veh): xxxxxx
 Optimal Cycle: 180 Level Of Service: F

Approach:	North Bound			South Bound			East Bound			West Bound		
Movement:	L	T	R	L	T	R	L	T	R	L	T	R
Control:	Protected			Protected			Protected			Protected		
Rights:	Include			Include			Include			Ovl		
Min. Green:	0	0	0	0	0	0	0	0	0	0	0	0
Y+R:	4.0	4.0	4.0	4.0	4.0	4.0	4.0	4.0	4.0	4.0	4.0	4.0
Lanes:	2	0	2	1	0	0	2	0	2	1	0	1

Volume Module:

Base Vol:	101	586	103	280	2411	48	84	317	546	416	460	601
Growth Adj:	1.00	1.00	1.00	1.00	1.00	1.00	1.00	1.00	1.00	1.00	1.00	1.00
Initial Bse:	101	586	103	280	2411	48	84	317	546	416	460	601
User Adj:	1.00	1.00	1.00	1.00	1.00	1.00	1.00	1.00	1.00	1.00	1.00	1.00
PHF Adj:	1.00	1.00	1.00	1.00	1.00	1.00	1.00	1.00	1.00	1.00	1.00	1.00
PHF Volume:	101	586	103	280	2411	48	84	317	546	416	460	601
Reduct Vol:	0	0	0	0	0	0	0	0	0	0	0	0
Reduced Vol:	101	586	103	280	2411	48	84	317	546	416	460	601
PCE Adj:	1.00	1.00	1.00	1.00	1.00	1.00	1.00	1.00	1.00	1.00	1.00	1.00
MLF Adj:	1.00	1.00	1.00	1.00	1.00	1.00	1.00	1.00	1.00	1.00	1.00	1.00
FinalVolume:	101	586	103	280	2411	48	84	317	546	416	460	601
OvlAdjVol:	461											

Saturation Flow Module:

Sat/Lane:	1600	1600	1600	1600	1600	1600	1600	1600	1600	1600	1600	1600
Adjustment:	1.00	1.05	1.00	1.00	1.04	1.00	1.00	1.06	1.00	1.00	1.06	1.00
Lanes:	2.00	2.55	0.45	2.00	2.94	0.06	1.00	1.00	1.00	1.00	1.00	1.00
Final Sat.:	3200	4282	718	3200	4906	94	1600	1700	1600	1600	1700	1600

Capacity Analysis Module:

Vol/Sat:	0.03	0.14	0.14	0.09	0.49	0.51	0.05	0.19	0.34	0.26	0.27	0.38
OvlAdjV/S:	0.29											
Crit Moves:	****			****			****			****		

Santa Ana Circulation Element

Level Of Service Computation Report

ICU 1(Loss as Cycle Length %) Method (Base Volume Alternative)

Intersection #92 Tustin Ave and Santa Clara Ave

Cycle (sec): 100 Critical Vol./Cap.(X): 1.037
 Loss Time (sec): 5 Average Delay (sec/veh): xxxxxx
 Optimal Cycle: 180 Level Of Service: F

Approach:	North Bound			South Bound			East Bound			West Bound		
Movement:	L	T	R	L	T	R	L	T	R	L	T	R
Control:	Protected			Protected			Permitted			Permitted		
Rights:	Include			Include			Include			Include		
Min. Green:	0	0	0	0	0	0	0	0	0	0	0	0
Y+R:	4.0	4.0	4.0	4.0	4.0	4.0	4.0	4.0	4.0	4.0	4.0	4.0
Lanes:	1	0	2	1	0	2	1	0	1	1	0	1

Volume Module:

Base Vol:	83	453	84	151	3094	98	124	314	229	160	332	166
Growth Adj:	1.00	1.00	1.00	1.00	1.00	1.00	1.00	1.00	1.00	1.00	1.00	1.00
Initial Bse:	83	453	84	151	3094	98	124	314	229	160	332	166
User Adj:	1.00	1.00	1.00	1.00	1.00	1.00	1.00	1.00	1.00	1.00	1.00	1.00
PHF Adj:	1.00	1.00	1.00	1.00	1.00	1.00	1.00	1.00	1.00	1.00	1.00	1.00
PHF Volume:	83	453	84	151	3094	98	124	314	229	160	332	166
Reduct Vol:	0	0	0	0	0	0	0	0	0	0	0	0
Reduced Vol:	83	453	84	151	3094	98	124	314	229	160	332	166
PCE Adj:	1.00	1.00	1.00	1.00	1.00	1.00	1.00	1.00	1.00	1.00	1.00	1.00
MLF Adj:	1.00	1.00	1.00	1.00	1.00	1.00	1.00	1.00	1.00	1.00	1.00	1.00
FinalVolume:	83	453	84	151	3094	98	124	314	229	160	332	166

Saturation Flow Module:

Sat/Lane:	1600	1600	1600	1600	1600	1600	1600	1600	1600	1600	1600	1600
Adjustment:	1.00	1.05	1.00	1.00	1.04	1.00	1.00	1.05	1.00	1.00	1.05	1.00
Lanes:	1.00	2.53	0.47	2.00	2.91	0.09	1.00	1.16	0.84	1.00	1.33	0.67
Final Sat.:	1600	4249	751	3200	4853	147	1600	1950	1350	1600	2233	1067

Capacity Analysis Module:

Vol/Sat:	0.05	0.11	0.11	0.05	0.64	0.67	0.08	0.16	0.17	0.10	0.15	0.16
Crit Moves:	****					****			****	****		

Santa Ana Circulation Element

Level Of Service Computation Report

ICU 1(Loss as Cycle Length %) Method (Base Volume Alternative)

 Intersection #93 Tustin Ave and 17th St

Cycle (sec): 100 Critical Vol./Cap.(X): 0.911
 Loss Time (sec): 5 Average Delay (sec/veh): xxxxxx
 Optimal Cycle: 93 Level Of Service: E

Approach:	North Bound			South Bound			East Bound			West Bound		
Movement:	L	T	R	L	T	R	L	T	R	L	T	R
Control:	Protected			Protected			Protected			Protected		
Rights:	Ovl			Include			Include			Ovl		
Min. Green:	0	0	0	0	0	0	0	0	0	0	0	0
Y+R:	4.0	4.0	4.0	4.0	4.0	4.0	4.0	4.0	4.0	4.0	4.0	4.0
Lanes:	2	0	2	0	2	1	0	2	3	0	1	2

Volume Module:

Base Vol:	127	226	269	716	2067	23	230	908	155	664	1047	256
Growth Adj:	1.00	1.00	1.00	1.00	1.00	1.00	1.00	1.00	1.00	1.00	1.00	1.00
Initial Bse:	127	226	269	716	2067	23	230	908	155	664	1047	256
User Adj:	1.00	1.00	1.00	1.00	1.00	1.00	1.00	1.00	1.00	1.00	1.00	1.00
PHF Adj:	1.00	1.00	1.00	1.00	1.00	1.00	1.00	1.00	1.00	1.00	1.00	1.00
PHF Volume:	127	226	269	716	2067	23	230	908	155	664	1047	256
Reduct Vol:	0	0	0	0	0	0	0	0	0	0	0	0
Reduced Vol:	127	226	269	716	2067	23	230	908	155	664	1047	256
PCE Adj:	1.00	1.00	1.00	1.00	1.00	1.00	1.00	1.00	1.00	1.00	1.00	1.00
MLF Adj:	1.00	1.00	1.00	1.00	1.00	1.00	1.00	1.00	1.00	1.00	1.00	1.00
FinalVolume:	127	226	269	716	2067	23	230	908	155	664	1047	256
OvlAdjVol:	0									0		

Saturation Flow Module:

Sat/Lane:	1600	1600	1600	1600	1600	1600	1600	1600	1600	1600	1600	1600
Adjustment:	1.00	1.06	1.00	1.00	1.04	1.00	1.00	1.06	1.00	1.00	1.06	1.00
Lanes:	2.00	2.00	1.00	2.00	2.97	0.03	2.00	3.00	1.00	2.00	3.00	1.00
Final Sat.:	3200	3400	1600	3200	4947	53	3200	5100	1600	3200	5100	1600

Capacity Analysis Module:

Vol/Sat:	0.04	0.07	0.17	0.22	0.42	0.44	0.07	0.18	0.10	0.21	0.21	0.16
OvlAdjV/S:	0.00									0.00		
Crit Moves:	****			****			****			****		

Santa Ana Circulation Element

Level Of Service Computation Report

ICU 1(Loss as Cycle Length %) Method (Base Volume Alternative)

Intersection #94 Tustin Ave and 4th St

Cycle (sec): 100 Critical Vol./Cap.(X): 0.830
 Loss Time (sec): 5 Average Delay (sec/veh): xxxxxx
 Optimal Cycle: 59 Level Of Service: D

Approach:	North Bound			South Bound			East Bound			West Bound		
Movement:	L	T	R	L	T	R	L	T	R	L	T	R
Control:	Protected			Protected			Protected			Protected		
Rights:	Include			Include			Include			Include		
Min. Green:	0	0	0	0	0	0	0	0	0	0	0	0
Y+R:	4.0	4.0	4.0	4.0	4.0	4.0	4.0	4.0	4.0	4.0	4.0	4.0
Lanes:	1	0	2	1	0	2	1	0	2	1	0	2

Volume Module:

Base Vol:	80	408	365	601	765	237	126	748	31	125	704	457
Growth Adj:	1.00	1.00	1.00	1.00	1.00	1.00	1.00	1.00	1.00	1.00	1.00	1.00
Initial Bse:	80	408	365	601	765	237	126	748	31	125	704	457
User Adj:	1.00	1.00	1.00	1.00	1.00	1.00	1.00	1.00	1.00	1.00	1.00	1.00
PHF Adj:	1.00	1.00	1.00	1.00	1.00	1.00	1.00	1.00	1.00	1.00	1.00	1.00
PHF Volume:	80	408	365	601	765	237	126	748	31	125	704	457
Reduct Vol:	0	0	0	0	0	0	0	0	0	0	0	0
Reduced Vol:	80	408	365	601	765	237	126	748	31	125	704	457
PCE Adj:	1.00	1.00	1.00	1.00	1.00	1.00	1.00	1.00	1.00	1.00	1.00	1.00
MLF Adj:	1.00	1.00	1.00	1.00	1.00	1.00	1.00	1.00	1.00	1.00	1.00	1.00
FinalVolume:	80	408	365	601	765	237	126	748	31	125	704	457

Saturation Flow Module:

Sat/Lane:	1600	1600	1600	1600	1600	1600	1600	1600	1600	1600	1600	1600
Adjustment:	1.00	1.06	1.00	1.00	1.06	1.00	1.00	1.06	1.00	1.00	1.06	1.00
Lanes:	1.00	2.00	1.00	2.00	2.00	1.00	1.00	3.00	1.00	1.00	2.00	1.00
Final Sat.:	1600	3400	1600	3200	3400	1600	1600	5100	1600	1600	3400	1600

Capacity Analysis Module:

Vol/Sat:	0.05	0.12	0.23	0.19	0.23	0.15	0.08	0.15	0.02	0.08	0.21	0.29
Crit Moves:		****	****		****		****			****		

Santa Ana Circulation Element

Level Of Service Computation Report

2000 HCM Operations Method (Base Volume Alternative)

Intersection #95 SR-55 SB Ramps / Auto Mall Dr and Edinger Ave

Cycle (sec): 100 Critical Vol./Cap.(X): 0.672

Loss Time (sec): 5 Average Delay (sec/veh): 25.2

Optimal Cycle: 36 Level Of Service: C

Approach:	North Bound			South Bound			East Bound			West Bound										
Movement:	L	T	R	L	T	R	L	T	R	L	T	R								
Control:	Split Phase			Split Phase			Protected			Protected										
Rights:	Include			Include			Ignore			Include										
Min. Green:	0	0	0	0	0	0	0	0	0	0	0	0								
Y+R:	4.0	4.0	4.0	4.0	4.0	4.0	4.0	4.0	4.0	4.0	4.0	4.0								
Lanes:	1	1	0	0	2	1	0	1	0	1	1	0	3	0	1	2	0	2	1	0

Volume Module:

Base Vol:	456	68	540	50	30	8	36	1426	527	510	1202	157
Growth Adj:	1.00	1.00	1.00	1.00	1.00	1.00	1.00	1.00	1.00	1.00	1.00	1.00
Initial Bse:	456	68	540	50	30	8	36	1426	527	510	1202	157
User Adj:	1.00	1.00	1.00	1.00	1.00	1.00	1.00	1.00	0.00	1.00	1.00	1.00
PHF Adj:	1.00	1.00	1.00	1.00	1.00	1.00	1.00	1.00	0.00	1.00	1.00	1.00
PHF Volume:	456	68	540	50	30	8	36	1426	0	510	1202	157
Reduct Vol:	0	0	0	0	0	0	0	0	0	0	0	0
Reduced Vol:	456	68	540	50	30	8	36	1426	0	510	1202	157
PCE Adj:	1.00	1.00	1.00	1.00	1.00	1.00	1.00	1.00	0.00	1.00	1.00	1.00
MLF Adj:	1.00	1.00	1.00	1.00	1.00	1.00	1.00	1.00	0.00	1.00	1.00	1.00
FinalVolume:	456	68	540	50	30	8	36	1426	0	510	1202	157

Saturation Flow Module:

Sat/Lane:	1900	1900	1900	1900	1900	1900	1900	1900	1900	1900	1900	1900
Adjustment:	0.96	0.96	0.75	0.95	1.00	0.85	0.95	0.91	1.00	0.92	0.89	0.89
Lanes:	1.74	0.26	2.00	1.00	1.00	1.00	1.00	3.00	1.00	2.00	2.65	0.35
Final Sat.:	3168	472	2842	1805	1900	1615	1805	5187	1900	3502	4510	589

Capacity Analysis Module:

Vol/Sat:	0.14	0.14	0.19	0.03	0.02	0.00	0.02	0.27	0.00	0.15	0.27	0.27
Crit Moves:			****	****				****		****		
Green/Cycle:	0.28	0.28	0.28	0.04	0.04	0.04	0.04	0.41	0.00	0.22	0.58	0.58
Volume/Cap:	0.51	0.51	0.67	0.67	0.38	0.12	0.46	0.67	0.00	0.67	0.46	0.46
Delay/Veh:	30.5	30.5	34.0	68.7	49.8	47.0	50.8	24.9	0.0	38.3	12.0	12.0
User DelAdj:	1.00	1.00	1.00	1.00	1.00	1.00	1.00	1.00	1.00	1.00	1.00	1.00
AdjDel/Veh:	30.5	30.5	34.0	68.7	49.8	47.0	50.8	24.9	0.0	38.3	12.0	12.0
LOS by Move:	C	C	C	E	D	D	D	C	A	D	B	B
HCM2k85thQ:	11	11	14	4	2	1	3	20	0	13	13	13

Note: Queue reported is the number of cars per lane.

Santa Ana Circulation Element

Level Of Service Computation Report

2000 HCM Operations Method (Base Volume Alternative)

 Intersection #96 SR-55 NB Ramps / Del Amo Ave and Newport Avenue

Cycle (sec): 100 Critical Vol./Cap.(X): 0.673
 Loss Time (sec): 5 Average Delay (sec/veh): 25.4
 Optimal Cycle: 36 Level Of Service: C

Approach:	North Bound			South Bound			East Bound			West Bound		
Movement:	L	T	R	L	T	R	L	T	R	L	T	R
Control:	Protected			Protected			Protected			Protected		
Rights:	Include			Ovl			Include			Include		
Min. Green:	0	0	0	0	0	0	0	0	0	0	0	0
Y+R:	4.0	4.0	4.0	4.0	4.0	4.0	4.0	4.0	4.0	4.0	4.0	4.0
Lanes:	2	0	2	1	0	3	0	1	1	0	1	1

Volume Module:	North Bound			South Bound			East Bound			West Bound		
Base Vol:	392	104	66	21	512	750	269	163	155	8	223	4
Growth Adj:	1.00	1.00	1.00	1.00	1.00	1.00	1.00	1.00	1.00	1.00	1.00	1.00
Initial Bse:	392	104	66	21	512	750	269	163	155	8	223	4
User Adj:	1.00	1.00	1.00	1.00	1.00	1.00	1.00	1.00	1.00	1.00	1.00	1.00
PHF Adj:	1.00	1.00	1.00	1.00	1.00	1.00	1.00	1.00	1.00	1.00	1.00	1.00
PHF Volume:	392	104	66	21	512	750	269	163	155	8	223	4
Reduct Vol:	0	0	0	0	0	0	0	0	0	0	0	0
Reduced Vol:	392	104	66	21	512	750	269	163	155	8	223	4
PCE Adj:	1.00	1.00	1.00	1.00	1.00	1.00	1.00	1.00	1.00	1.00	1.00	1.00
MLF Adj:	1.00	1.00	1.00	1.00	1.00	1.00	1.00	1.00	1.00	1.00	1.00	1.00
FinalVolume:	392	104	66	21	512	750	269	163	155	8	223	4

Saturation Flow Module:	North Bound			South Bound			East Bound			West Bound		
Sat/Lane:	1900	1900	1900	1900	1900	1900	1900	1900	1900	1900	1900	1900
Adjustment:	0.92	0.86	0.86	0.95	0.91	0.85	0.92	0.88	0.88	0.95	0.95	0.95
Lanes:	2.00	2.00	1.00	1.00	3.00	1.00	2.00	1.03	0.97	1.00	1.96	0.04
Final Sat.:	3502	3257	1629	1805	5187	1615	3502	1715	1631	1805	3536	63

Capacity Analysis Module:	North Bound			South Bound			East Bound			West Bound		
Vol/Sat:	0.11	0.03	0.04	0.01	0.10	0.46	0.08	0.10	0.10	0.00	0.06	0.06
Crit Moves:	****			****			****			****		
Green/Cycle:	0.17	0.58	0.58	0.17	0.58	0.69	0.11	0.20	0.20	0.01	0.09	0.09
Volume/Cap:	0.67	0.06	0.07	0.07	0.17	0.67	0.67	0.48	0.48	0.48	0.67	0.67
Delay/Veh:	42.2	9.3	9.4	35.3	10.0	10.6	47.0	36.0	36.0	69.3	49.1	49.1
User DelAdj:	1.00	1.00	1.00	1.00	1.00	1.00	1.00	1.00	1.00	1.00	1.00	1.00
AdjDel/Veh:	42.2	9.3	9.4	35.3	10.0	10.6	47.0	36.0	36.0	69.3	49.1	49.1
LOS by Move:	D	A	A	D	B	B	D	D	D	E	D	D
HCM2k85thQ:	11	1	2	1	4	21	8	8	8	1	8	8

Note: Queue reported is the number of cars per lane.

Santa Ana Circulation Element

Level Of Service Computation Report

ICU 1(Loss as Cycle Length %) Method (Base Volume Alternative)

 Intersection #97 Red Hill Ave and Edinger Ave

Cycle (sec): 100 Critical Vol./Cap.(X): 0.610
 Loss Time (sec): 5 Average Delay (sec/veh): xxxxxx
 Optimal Cycle: 30 Level Of Service: B

Approach:	North Bound			South Bound			East Bound			West Bound		
Movement:	L	T	R	L	T	R	L	T	R	L	T	R
Control:	Protected			Protected			Protected			Protected		
Rights:	Include			Ovl			Ovl			Include		
Min. Green:	0	0	0	0	0	0	0	0	0	0	0	0
Y+R:	4.0	4.0	4.0	4.0	4.0	4.0	4.0	4.0	4.0	4.0	4.0	4.0
Lanes:	2	0	3	0	1		2	0	3	0	1	

Volume Module:

Base Vol:	101	374	106	195	828	388	397	1276	271	255	1234	173	
Growth Adj:	1.00	1.00	1.00	1.00	1.00	1.00	1.00	1.00	1.00	1.00	1.00	1.00	
Initial Bse:	101	374	106	195	828	388	397	1276	271	255	1234	173	
User Adj:	1.00	1.00	1.00	1.00	1.00	1.00	1.00	1.00	1.00	1.00	1.00	1.00	
PHF Adj:	1.00	1.00	1.00	1.00	1.00	1.00	1.00	1.00	1.00	1.00	1.00	1.00	
PHF Volume:	101	374	106	195	828	388	397	1276	271	255	1234	173	
Reduct Vol:	0	0	0	0	0	0	0	0	0	0	0	0	
Reduced Vol:	101	374	106	195	828	388	397	1276	271	255	1234	173	
PCE Adj:	1.00	1.00	1.00	1.00	1.00	1.00	1.00	1.00	1.00	1.00	1.00	1.00	
MLF Adj:	1.00	1.00	1.00	1.00	1.00	1.00	1.00	1.00	1.00	1.00	1.00	1.00	
FinalVolume:	101	374	106	195	828	388	397	1276	271	255	1234	173	
OvlAdjVol:							189				221		

Saturation Flow Module:

Sat/Lane:	1600	1600	1600	1600	1600	1600	1600	1600	1600	1600	1600	1600
Adjustment:	1.00	1.06	1.00	1.00	1.06	1.00	1.00	1.06	1.00	1.00	1.06	1.00
Lanes:	2.00	3.00	1.00	2.00	3.00	1.00	2.00	3.00	1.00	2.00	3.00	1.00
Final Sat.:	3200	5100	1600	3200	5100	1600	3200	5100	1600	3200	5100	1600

Capacity Analysis Module:

Vol/Sat:	0.03	0.07	0.07	0.06	0.16	0.24	0.12	0.25	0.17	0.08	0.24	0.11	
OvlAdjV/S:							0.12				0.14		
Crit Moves:	****			****			****			****			

Santa Ana Circulation Element

Level Of Service Computation Report

ICU 1(Loss as Cycle Length %) Method (Base Volume Alternative)

Intersection #98 Red Hill Ave and Warner Ave

Cycle (sec): 100 Critical Vol./Cap.(X): 0.560
 Loss Time (sec): 5 Average Delay (sec/veh): xxxxxxx
 Optimal Cycle: 27 Level Of Service: A

Approach:	North Bound			South Bound			East Bound			West Bound		
Movement:	L	T	R	L	T	R	L	T	R	L	T	R
Control:	Protected			Protected			Protected			Protected		
Rights:	Include			Include			Include			Ovl		
Min. Green:	0	0	0	0	0	0	0	0	0	0	0	0
Y+R:	4.0	4.0	4.0	4.0	4.0	4.0	4.0	4.0	4.0	4.0	4.0	4.0
Lanes:	2	0	3	1	0	0	2	0	2	1	0	3

Volume Module:

Base Vol:	68	414	56	20	935	188	273	464	342	120	427	76
Growth Adj:	1.00	1.00	1.00	1.00	1.00	1.00	1.00	1.00	1.00	1.00	1.00	1.00
Initial Bse:	68	414	56	20	935	188	273	464	342	120	427	76
User Adj:	1.00	1.00	1.00	1.00	1.00	1.00	1.00	1.00	1.00	1.00	1.00	1.00
PHF Adj:	1.00	1.00	1.00	1.00	1.00	1.00	1.00	1.00	1.00	1.00	1.00	1.00
PHF Volume:	68	414	56	20	935	188	273	464	342	120	427	76
Reduct Vol:	0	0	0	0	0	0	0	0	0	0	0	0
Reduced Vol:	68	414	56	20	935	188	273	464	342	120	427	76
PCE Adj:	1.00	1.00	1.00	1.00	1.00	1.00	1.00	1.00	1.00	1.00	1.00	1.00
MLF Adj:	1.00	1.00	1.00	1.00	1.00	1.00	1.00	1.00	1.00	1.00	1.00	1.00
FinalVolume:	68	414	56	20	935	188	273	464	342	120	427	76
OvlAdjVol:												66

Saturation Flow Module:

Sat/Lane:	1600	1600	1600	1600	1600	1600	1600	1600	1600	1600	1600	1600
Adjustment:	1.00	1.05	1.00	1.00	1.05	1.00	1.00	1.06	1.00	1.00	1.06	1.00
Lanes:	2.00	3.52	0.48	2.00	2.50	0.50	1.00	2.00	1.00	2.00	3.00	1.00
Final Sat.:	3200	5937	763	3200	4196	804	1600	3400	1600	3200	5100	1600

Capacity Analysis Module:

Vol/Sat:	0.02	0.07	0.07	0.01	0.22	0.23	0.17	0.14	0.21	0.04	0.08	0.05
OvlAdjV/S:												0.04
Crit Moves:	****			****			****			****		

 Santa Ana Circulation Element

Level Of Service Computation Report

ICU 1(Loss as Cycle Length %) Method (Base Volume Alternative)

Intersection #99 Red Hill Ave and Dyer Rd / barranca Pkwy

Cycle (sec): 100 Critical Vol./Cap.(X): 0.548
 Loss Time (sec): 5 Average Delay (sec/veh): xxxxxxx
 Optimal Cycle: 26 Level Of Service: A

Approach:	North Bound			South Bound			East Bound			West Bound		
Movement:	L	T	R	L	T	R	L	T	R	L	T	R
Control:	Protected			Protected			Protected			Protected		
Rights:	Include			Include			Include			Include		
Min. Green:	0	0	0	0	0	0	0	0	0	0	0	0
Y+R:	4.0	4.0	4.0	4.0	4.0	4.0	4.0	4.0	4.0	4.0	4.0	4.0
Lanes:	2	0	4	0	1		2	0	4	0	1	

Volume Module:

Base Vol:	152	379	125	163	719	94	124	748	296	511	571	111
Growth Adj:	1.00	1.00	1.00	1.00	1.00	1.00	1.00	1.00	1.00	1.00	1.00	1.00
Initial Bse:	152	379	125	163	719	94	124	748	296	511	571	111
User Adj:	1.00	1.00	1.00	1.00	1.00	1.00	1.00	1.00	1.00	1.00	1.00	1.00
PHF Adj:	1.00	1.00	1.00	1.00	1.00	1.00	1.00	1.00	1.00	1.00	1.00	1.00
PHF Volume:	152	379	125	163	719	94	124	748	296	511	571	111
Reduct Vol:	0	0	0	0	0	0	0	0	0	0	0	0
Reduced Vol:	152	379	125	163	719	94	124	748	296	511	571	111
PCE Adj:	1.00	1.00	1.00	1.00	1.00	1.00	1.00	1.00	1.00	1.00	1.00	1.00
MLF Adj:	1.00	1.00	1.00	1.00	1.00	1.00	1.00	1.00	1.00	1.00	1.00	1.00
FinalVolume:	152	379	125	163	719	94	124	748	296	511	571	111

Saturation Flow Module:

Sat/Lane:	1600	1600	1600	1600	1600	1600	1600	1600	1600	1600	1600	1600
Adjustment:	1.00	1.06	1.00	1.00	1.06	1.00	1.00	1.06	1.00	1.00	1.06	1.00
Lanes:	2.00	4.00	1.00	2.00	4.00	1.00	2.00	3.00	1.00	2.00	4.00	1.00
Final Sat.:	3200	6800	1600	3200	6800	1600	3200	5100	1600	3200	6800	1600

Capacity Analysis Module:

Vol/Sat:	0.05	0.06	0.08	0.05	0.11	0.06	0.04	0.15	0.19	0.16	0.08	0.07
Crit Moves:	****			****					****	****		

Santa Ana Circulation Element

Level Of Service Computation Report

ICU 1(Loss as Cycle Length %) Method (Base Volume Alternative)

Intersection #100 Red Hill Ave and Alton Pkwy

Cycle (sec): 100 Critical Vol./Cap.(X): 0.855
 Loss Time (sec): 5 Average Delay (sec/veh): xxxxxx
 Optimal Cycle: 67 Level Of Service: D

Approach:	North Bound			South Bound			East Bound			West Bound		
Movement:	L	T	R	L	T	R	L	T	R	L	T	R
Control:	Protected			Protected			Protected			Protected		
Rights:	Include			Include			Include			Include		
Min. Green:	0	0	0	0	0	0	0	0	0	0	0	0
Y+R:	4.0	4.0	4.0	4.0	4.0	4.0	4.0	4.0	4.0	4.0	4.0	4.0
Lanes:	1	0	3	0	1	1	1	0	2	0	1	0

Volume Module:

Base Vol:	225	663	415	212	962	154	158	490	490	342	290	163
Growth Adj:	1.00	1.00	1.00	1.00	1.00	1.00	1.00	1.00	1.00	1.00	1.00	1.00
Initial Bse:	225	663	415	212	962	154	158	490	490	342	290	163
User Adj:	1.00	1.00	1.00	1.00	1.00	1.00	1.00	1.00	1.00	1.00	1.00	1.00
PHF Adj:	1.00	1.00	1.00	1.00	1.00	1.00	1.00	1.00	1.00	1.00	1.00	1.00
PHF Volume:	225	663	415	212	962	154	158	490	490	342	290	163
Reduct Vol:	0	0	0	0	0	0	0	0	0	0	0	0
Reduced Vol:	225	663	415	212	962	154	158	490	490	342	290	163
PCE Adj:	1.00	1.00	1.00	1.00	1.00	1.00	1.00	1.00	1.00	1.00	1.00	1.00
MLF Adj:	1.00	1.00	1.00	1.00	1.00	1.00	1.00	1.00	1.00	1.00	1.00	1.00
FinalVolume:	225	663	415	212	962	154	158	490	490	342	290	163

Saturation Flow Module:

Sat/Lane:	1600	1600	1600	1600	1600	1600	1600	1600	1600	1600	1600	1600
Adjustment:	1.00	1.06	1.00	1.00	1.06	1.00	1.00	1.06	1.00	1.00	1.06	1.00
Lanes:	1.00	3.00	1.00	1.00	3.00	1.00	1.00	2.00	1.00	2.00	1.00	1.00
Final Sat.:	1600	5100	1600	1600	5100	1600	1600	3400	1600	3200	1700	1600

Capacity Analysis Module:

Vol/Sat:	0.14	0.13	0.26	0.13	0.19	0.10	0.10	0.14	0.31	0.11	0.17	0.10
Crit Moves:	****			****			****			****		

Santa Ana Circulation Element

Level Of Service Computation Report

ICU 1(Loss as Cycle Length %) Method (Base Volume Alternative)

 Intersection #101 Red Hill Ave and MacArthur Blvd

Cycle (sec): 100 Critical Vol./Cap.(X): 0.686
 Loss Time (sec): 5 Average Delay (sec/veh): xxxxxx
 Optimal Cycle: 36 Level Of Service: B

Approach:	North Bound			South Bound			East Bound			West Bound		
Movement:	L	T	R	L	T	R	L	T	R	L	T	R
Control:	Protected			Protected			Protected			Protected		
Rights:	Include			Ignore			Include			Ignore		
Min. Green:	0	0	0	0	0	0	0	0	0	0	0	0
Y+R:	4.0	4.0	4.0	4.0	4.0	4.0	4.0	4.0	4.0	4.0	4.0	4.0
Lanes:	2	0	2	1	0	0	2	0	3	0	1	0

Volume Module:

Base Vol:	83	742	13	186	481	441	1153	596	98	32	308	789
Growth Adj:	1.00	1.00	1.00	1.00	1.00	1.00	1.00	1.00	1.00	1.00	1.00	1.00
Initial Bse:	83	742	13	186	481	441	1153	596	98	32	308	789
User Adj:	1.00	1.00	1.00	1.00	1.00	0.00	1.00	1.00	1.00	1.00	1.00	0.00
PHF Adj:	1.00	1.00	1.00	1.00	1.00	0.00	1.00	1.00	1.00	1.00	1.00	0.00
PHF Volume:	83	742	13	186	481	0	1153	596	98	32	308	0
Reduct Vol:	0	0	0	0	0	0	0	0	0	0	0	0
Reduced Vol:	83	742	13	186	481	0	1153	596	98	32	308	0
PCE Adj:	1.00	1.00	1.00	1.00	1.00	0.00	1.00	1.00	1.00	1.00	1.00	0.00
MLF Adj:	1.00	1.00	1.00	1.00	1.00	0.00	1.00	1.00	1.00	1.00	1.00	0.00
FinalVolume:	83	742	13	186	481	0	1153	596	98	32	308	0

Saturation Flow Module:

Sat/Lane:	1600	1600	1600	1600	1600	1600	1600	1600	1600	1600	1600	1600
Adjustment:	1.00	1.04	1.00	1.00	1.06	1.00	1.00	1.06	1.00	1.00	1.06	1.00
Lanes:	2.00	2.95	0.05	2.00	3.00	1.00	2.00	3.00	1.00	1.00	3.00	1.00
Final Sat.:	3200	4917	83	3200	5100	1600	3200	5100	1600	1600	5100	1600

Capacity Analysis Module:

Vol/Sat:	0.03	0.15	0.16	0.06	0.09	0.00	0.36	0.12	0.06	0.02	0.06	0.00
Crit Moves:			****	****			****				****	

Santa Ana Circulation Element

Level Of Service Computation Report

ICU 1(Loss as Cycle Length %) Method (Base Volume Alternative)

Intersection #102 Red Hill Ave and Main St

Cycle (sec): 100 Critical Vol./Cap.(X): 0.722
 Loss Time (sec): 5 Average Delay (sec/veh): xxxxxx
 Optimal Cycle: 40 Level Of Service: C

Approach:	North Bound			South Bound			East Bound			West Bound		
Movement:	L	T	R	L	T	R	L	T	R	L	T	R
Control:	Protected			Protected			Protected			Protected		
Rights:	Include			Include			Include			Include		
Min. Green:	0	0	0	0	0	0	0	0	0	0	0	0
Y+R:	4.0	4.0	4.0	4.0	4.0	4.0	4.0	4.0	4.0	4.0	4.0	4.0
Lanes:	2	0	2	0	2	0	1	2	0	2	1	0

Volume Module:

Base Vol:	201	691	449	56	261	90	139	1309	254	154	309	73
Growth Adj:	1.00	1.00	1.00	1.00	1.00	1.00	1.00	1.00	1.00	1.00	1.00	1.00
Initial Bse:	201	691	449	56	261	90	139	1309	254	154	309	73
User Adj:	1.00	1.00	1.00	1.00	1.00	1.00	1.00	1.00	1.00	1.00	1.00	1.00
PHF Adj:	1.00	1.00	1.00	1.00	1.00	1.00	1.00	1.00	1.00	1.00	1.00	1.00
PHF Volume:	201	691	449	56	261	90	139	1309	254	154	309	73
Reduct Vol:	0	0	0	0	0	0	0	0	0	0	0	0
Reduced Vol:	201	691	449	56	261	90	139	1309	254	154	309	73
PCE Adj:	1.00	1.00	1.00	1.00	1.00	1.00	1.00	1.00	1.00	1.00	1.00	1.00
MLF Adj:	1.00	1.00	1.00	1.00	1.00	1.00	1.00	1.00	1.00	1.00	1.00	1.00
Final Volume:	201	691	449	56	261	90	139	1309	254	154	309	73

Saturation Flow Module:

Sat/Lane:	1600	1600	1600	1600	1600	1600	1600	1600	1600	1600	1600	1600
Adjustment:	1.00	1.06	1.00	1.00	1.06	1.00	1.00	1.05	1.00	1.00	1.05	1.00
Lanes:	2.00	2.00	1.00	2.00	2.00	1.00	2.00	2.51	0.49	2.00	2.43	0.57
Final Sat.:	3200	3400	1600	3200	3400	1600	3200	4220	780	3200	4083	917

Capacity Analysis Module:

Vol/Sat:	0.06	0.20	0.28	0.02	0.08	0.06	0.04	0.31	0.33	0.05	0.08	0.08
Crit Moves:			****	****					****	****		

Santa Ana Circulation Element

Level Of Service Computation Report

2000 HCM Operations Method (Base Volume Alternative)

 Intersection #103 I-5 SB Ramps and Santa Ana Blvd

Cycle (sec): 100 Critical Vol./Cap.(X): 0.559
 Loss Time (sec): 5 Average Delay (sec/veh): 17.4
 Optimal Cycle: 28 Level Of Service: B

Approach:	North Bound			South Bound			East Bound			West Bound		
Movement:	L	T	R	L	T	R	L	T	R	L	T	R
Control:	Split Phase			Split Phase			Protected			Protected		
Rights:	Include			Ovl			Include			Include		
Min. Green:	0	0	0	0	0	0	0	0	0	0	0	0
Y+R:	4.0	4.0	4.0	4.0	4.0	4.0	4.0	4.0	4.0	4.0	4.0	4.0
Lanes:	0	0	0	2	0	0	2	0	3	0	0	2

Volume Module:	North Bound			South Bound			East Bound			West Bound		
Base Vol:	0	0	0	382	0	38	332	569	0	0	1267	370
Growth Adj:	1.00	1.00	1.00	1.00	1.00	1.00	1.00	1.00	1.00	1.00	1.00	1.00
Initial Bse:	0	0	0	382	0	38	332	569	0	0	1267	370
User Adj:	1.00	1.00	1.00	1.00	1.00	1.00	1.00	1.00	1.00	1.00	1.00	1.00
PHF Adj:	1.00	1.00	1.00	1.00	1.00	1.00	1.00	1.00	1.00	1.00	1.00	1.00
PHF Volume:	0	0	0	382	0	38	332	569	0	0	1267	370
Reduct Vol:	0	0	0	0	0	0	0	0	0	0	0	0
Reduced Vol:	0	0	0	382	0	38	332	569	0	0	1267	370
PCE Adj:	1.00	1.00	1.00	1.00	1.00	1.00	1.00	1.00	1.00	1.00	1.00	1.00
MLF Adj:	1.00	1.00	1.00	1.00	1.00	1.00	1.00	1.00	1.00	1.00	1.00	1.00
Final Volume:	0	0	0	382	0	38	332	569	0	0	1267	370

Saturation Flow Module:	North Bound			South Bound			East Bound			West Bound		
Sat/Lane:	1900	1900	1900	1900	1900	1900	1900	1900	1900	1900	1900	1900
Adjustment:	1.00	1.00	1.00	0.92	1.00	0.85	0.92	0.91	1.00	1.00	0.88	0.88
Lanes:	0.00	0.00	0.00	2.00	0.00	1.00	2.00	3.00	0.00	0.00	2.32	0.68
Final Sat.:	0	0	0	3502	0	1615	3502	5187	0	0	3878	1133

Capacity Analysis Module:	North Bound			South Bound			East Bound			West Bound		
Vol/Sat:	0.00	0.00	0.00	0.11	0.00	0.02	0.09	0.11	0.00	0.00	0.33	0.33
Crit Moves:				****			****			****		
Green/Cycle:	0.00	0.00	0.00	0.20	0.00	0.37	0.17	0.75	0.00	0.00	0.58	0.58
Volume/Cap:	0.00	0.00	0.00	0.56	0.00	0.06	0.56	0.15	0.00	0.00	0.56	0.56
Delay/Veh:	0.0	0.0	0.0	37.4	0.0	20.7	39.3	3.4	0.0	0.0	13.0	13.0
User DelAdj:	1.00	1.00	1.00	1.00	1.00	1.00	1.00	1.00	1.00	1.00	1.00	1.00

AdjDel/Veh:	0.0	0.0	0.0	37.4	0.0	20.7	39.3	3.4	0.0	0.0	13.0	13.0
LOS by Move:	A	A	A	D	A	C	D	A	A	A	B	B
HCM2k85thQ:	0	0	0	9	0	1	9	3	0	0	17	17

Note: Queue reported is the number of cars per lane.

Santa Ana Circulation Element

Level Of Service Computation Report

ICU 1(Loss as Cycle Length %) Method (Base Volume Alternative)

 Intersection #104 Tustin Ranch Rd and Warner Ave

Cycle (sec): 100 Critical Vol./Cap.(X): 0.520
 Loss Time (sec): 5 Average Delay (sec/veh): xxxxxx
 Optimal Cycle: 25 Level Of Service: A

Approach:	North Bound			South Bound			East Bound			West Bound		
Movement:	L	T	R	L	T	R	L	T	R	L	T	R
Control:	Split Phase			Split Phase			Protected			Protected		
Rights:	Include			Include			Include			Ovl		
Min. Green:	0	0	0	0	0	0	0	0	0	0	0	0
Y+R:	4.0	4.0	4.0	4.0	4.0	4.0	4.0	4.0	4.0	4.0	4.0	4.0
Lanes:	0	0	0	2	0	0	2	0	3	0	0	3

Volume Module:	North Bound			South Bound			East Bound			West Bound		
Base Vol:	0	0	0	141	0	18	27	357	0	0	2130	490
Growth Adj:	1.00	1.00	1.00	1.00	1.00	1.00	1.00	1.00	1.00	1.00	1.00	1.00
Initial Bse:	0	0	0	141	0	18	27	357	0	0	2130	490
User Adj:	1.00	1.00	1.00	1.00	1.00	1.00	1.00	1.00	1.00	1.00	1.00	1.00
PHF Adj:	1.00	1.00	1.00	1.00	1.00	1.00	1.00	1.00	1.00	1.00	1.00	1.00
PHF Volume:	0	0	0	141	0	18	27	357	0	0	2130	490
Reduct Vol:	0	0	0	0	0	0	0	0	0	0	0	0
Reduced Vol:	0	0	0	141	0	18	27	357	0	0	2130	490
PCE Adj:	1.00	1.00	1.00	1.00	1.00	1.00	1.00	1.00	1.00	1.00	1.00	1.00
MLF Adj:	1.00	1.00	1.00	1.00	1.00	1.00	1.00	1.00	1.00	1.00	1.00	1.00
FinalVolume:	0	0	0	141	0	18	27	357	0	0	2130	490
OvlAdjVol:												420

Saturation Flow Module:	North Bound			South Bound			East Bound			West Bound		
Sat/Lane:	1600	1600	1600	1600	1600	1600	1600	1600	1600	1600	1600	1600
Adjustment:	1.00	1.06	1.00	1.00	1.06	1.00	1.00	1.06	1.00	1.00	1.06	1.00
Lanes:	0.00	0.00	0.00	2.00	0.00	1.00	2.00	3.00	0.00	0.00	3.00	1.00
Final Sat.:	0	0	0	3200	0	1600	3200	5100	0	0	5100	1600

Capacity Analysis Module:	North Bound			South Bound			East Bound			West Bound		
Vol/Sat:	0.00	0.00	0.00	0.04	0.00	0.01	0.01	0.07	0.00	0.00	0.42	0.31
OvlAdjV/S:												0.26
Crit Moves:				****				****				****

Santa Ana Circulation Element

Level Of Service Computation Report

ICU 1(Loss as Cycle Length %) Method (Base Volume Alternative)

Intersection #105 Von Karman Ave and Barranca Pkwy

Cycle (sec): 100 Critical Vol./Cap.(X): 0.929
 Loss Time (sec): 5 Average Delay (sec/veh): xxxxxxx
 Optimal Cycle: 108 Level Of Service: E

Approach:	North Bound			South Bound			East Bound			West Bound		
Movement:	L	T	R	L	T	R	L	T	R	L	T	R
Control:	Protected			Protected			Protected			Protected		
Rights:	Include			Ovl			Include			Include		
Min. Green:	0	0	0	0	0	0	0	0	0	0	0	0
Y+R:	4.0	4.0	4.0	4.0	4.0	4.0	4.0	4.0	4.0	4.0	4.0	4.0
Lanes:	2	0	1	1	0	2	2	0	3	0	1	2

Volume Module:

Base Vol:	401	533	319	104	1021	446	219	823	275	902	1482	46
Growth Adj:	1.00	1.00	1.00	1.00	1.00	1.00	1.00	1.00	1.00	1.00	1.00	1.00
Initial Bse:	401	533	319	104	1021	446	219	823	275	902	1482	46
User Adj:	1.00	1.00	1.00	1.00	1.00	1.00	1.00	1.00	1.00	1.00	1.00	1.00
PHF Adj:	1.00	1.00	1.00	1.00	1.00	1.00	1.00	1.00	1.00	1.00	1.00	1.00
PHF Volume:	401	533	319	104	1021	446	219	823	275	902	1482	46
Reduct Vol:	0	0	0	0	0	0	0	0	0	0	0	0
Reduced Vol:	401	533	319	104	1021	446	219	823	275	902	1482	46
PCE Adj:	1.00	1.00	1.00	1.00	1.00	1.00	1.00	1.00	1.00	1.00	1.00	1.00
MLF Adj:	1.00	1.00	1.00	1.00	1.00	1.00	1.00	1.00	1.00	1.00	1.00	1.00
FinalVolume:	401	533	319	104	1021	446	219	823	275	902	1482	46
OvlAdjVol:							227					

Saturation Flow Module:

Sat/Lane:	1600	1600	1600	1600	1600	1600	1600	1600	1600	1600	1600	1600
Adjustment:	1.00	1.05	1.00	1.00	1.06	1.00	1.00	1.06	1.00	1.00	1.06	1.00
Lanes:	2.00	1.25	0.75	2.00	2.00	2.00	2.00	3.00	1.00	2.00	4.00	1.00
Final Sat.:	3200	2102	1198	3200	3400	3200	3200	5100	1600	3200	6800	1600

Capacity Analysis Module:

Vol/Sat:	0.13	0.25	0.27	0.03	0.30	0.14	0.07	0.16	0.17	0.28	0.22	0.03
OvlAdjV/S:							0.07					
Crit Moves:	****			****			****			****		

Santa Ana Circulation Element

Level Of Service Computation Report

ICU 1(Loss as Cycle Length %) Method (Base Volume Alternative)

Intersection #106 Red Hill Avenue and El Camino Real

Cycle (sec): 100 Critical Vol./Cap.(X): 0.650
 Loss Time (sec): 5 Average Delay (sec/veh): xxxxxx
 Optimal Cycle: 33 Level Of Service: B

Street Name:	Red Hill Avenue						El Camino Real					
	North Bound			South Bound			East Bound			West Bound		
Approach:	North Bound			South Bound			East Bound			West Bound		
Movement:	L	T	R	L	T	R	L	T	R	L	T	R
Control:	Protected			Protected			Protected			Protected		
Rights:	Include			Include			Include			Include		
Min. Green:	0	0	0	0	0	0	0	0	0	0	0	0
Y+R:	4.0	4.0	4.0	4.0	4.0	4.0	4.0	4.0	4.0	4.0	4.0	4.0
Lanes:	2	0	3	0	1	1	0	2	1	0	1	0

Volume Module:												
Base Vol:	230	589	190	19	1372	84	48	108	114	246	202	15
Growth Adj:	1.00	1.00	1.00	1.00	1.00	1.00	1.00	1.00	1.00	1.00	1.00	1.00
Initial Bse:	230	589	190	19	1372	84	48	108	114	246	202	15
User Adj:	1.00	1.00	1.00	1.00	1.00	1.00	1.00	1.00	1.00	1.00	1.00	1.00
PHF Adj:	1.00	1.00	1.00	1.00	1.00	1.00	1.00	1.00	1.00	1.00	1.00	1.00
PHF Volume:	230	589	190	19	1372	84	48	108	114	246	202	15
Reduct Vol:	0	0	0	0	0	0	0	0	0	0	0	0
Reduced Vol:	230	589	190	19	1372	84	48	108	114	246	202	15
PCE Adj:	1.00	1.00	1.00	1.00	1.00	1.00	1.00	1.00	1.00	1.00	1.00	1.00
MLF Adj:	1.00	1.00	1.00	1.00	1.00	1.00	1.00	1.00	1.00	1.00	1.00	1.00
FinalVolume:	230	589	190	19	1372	84	48	108	114	246	202	15

Saturation Flow Module:												
Sat/Lane:	1600	1600	1600	1600	1600	1600	1600	1600	1600	1600	1600	1600
Adjustment:	1.00	1.06	1.00	1.00	1.04	1.00	1.00	1.06	1.00	1.00	1.00	1.00
Lanes:	2.00	3.00	1.00	1.00	2.83	0.17	1.00	1.00	1.00	1.00	0.93	0.07
Final Sat.:	3200	5100	1600	1600	4723	277	1600	1700	1600	1600	1489	111

Capacity Analysis Module:												
Vol/Sat:	0.07	0.12	0.12	0.01	0.29	0.30	0.03	0.06	0.07	0.15	0.14	0.14
Crit Moves:	****					****			****	****		

Santa Ana Circulation Element

Level Of Service Computation Report

2000 HCM Operations Method (Base Volume Alternative)

 Intersection #107 Red Hill Avenue and I-5 NB Ramps

Cycle (sec): 100 Critical Vol./Cap.(X): 0.627
 Loss Time (sec): 5 Average Delay (sec/veh): 20.8
 Optimal Cycle: 32 Level Of Service: C

Street Name:	Red Hill Avenue						I-5 NB Ramps					
Approach:	North Bound			South Bound			East Bound			West Bound		
Movement:	L	T	R	L	T	R	L	T	R	L	T	R
Control:	Protected			Protected			Permitted			Permitted		
Rights:	Include			Include			Include			Include		
Min. Green:	0	0	0	0	0	0	0	0	0	0	0	0
Y+R:	4.0	4.0	4.0	4.0	4.0	4.0	4.0	4.0	4.0	4.0	4.0	4.0
Lanes:	1	0	3	0	0	3	0	0	0	2	0	0

Volume Module:												
Base Vol:	254	843	0	0	1171	440	0	0	0	258	0	295
Growth Adj:	1.00	1.00	1.00	1.00	1.00	1.00	1.00	1.00	1.00	1.00	1.00	1.00
Initial Bse:	254	843	0	0	1171	440	0	0	0	258	0	295
User Adj:	1.00	1.00	1.00	1.00	1.00	1.00	1.00	1.00	1.00	1.00	1.00	1.00
PHF Adj:	1.00	1.00	1.00	1.00	1.00	1.00	1.00	1.00	1.00	1.00	1.00	1.00
PHF Volume:	254	843	0	0	1171	440	0	0	0	258	0	295
Reduct Vol:	0	0	0	0	0	0	0	0	0	0	0	0
Reduced Vol:	254	843	0	0	1171	440	0	0	0	258	0	295
PCE Adj:	1.00	1.00	1.00	1.00	1.00	1.00	1.00	1.00	1.00	1.00	1.00	1.00
MLF Adj:	1.00	1.00	1.00	1.00	1.00	1.00	1.00	1.00	1.00	1.00	1.00	1.00
Final Volume:	254	843	0	0	1171	440	0	0	0	258	0	295

Saturation Flow Module:												
Sat/Lane:	1900	1900	1900	1900	1900	1900	1900	1900	1900	1900	1900	1900
Adjustment:	0.95	0.91	1.00	1.00	0.91	0.85	1.00	1.00	1.00	0.60	1.00	0.85
Lanes:	1.00	3.00	0.00	0.00	3.00	1.00	0.00	0.00	0.00	2.00	0.00	1.00
Final Sat.:	1805	5187	0	0	5187	1615	0	0	0	2267	0	1615

Capacity Analysis Module:												
Vol/Sat:	0.14	0.16	0.00	0.00	0.23	0.27	0.00	0.00	0.00	0.11	0.00	0.18
Crit Moves:	****					****						****
Green/Cycle:	0.22	0.66	0.00	0.00	0.43	0.43	0.00	0.00	0.00	0.29	0.00	0.29
Volume/Cap:	0.63	0.25	0.00	0.00	0.52	0.63	0.00	0.00	0.00	0.39	0.00	0.63
Delay/Veh:	38.1	7.0	0.0	0.0	20.9	23.8	0.0	0.0	0.0	28.7	0.0	33.4
User DelAdj:	1.00	1.00	1.00	1.00	1.00	1.00	1.00	1.00	1.00	1.00	1.00	1.00

AdjDel/Veh:	38.1	7.0	0.0	0.0	20.9	23.8	0.0	0.0	0.0	28.7	0.0	33.4
LOS by Move:	D	A	A	A	C	C	A	A	A	C	A	C
HCM2k85thQ:	12	6	0	0	15	17	0	0	0	6	0	13

Note: Queue reported is the number of cars per lane.

Santa Ana Circulation Element

Level of Service Computation Report
 2000 HCM Operations Method (Base Volume Alternative)

 Intersection #108 Red Hill Avenue and I-5 SB Ramps

Cycle (sec): 100 Critical Vol./Cap.(X): 0.799
 Loss Time (sec): 5 Average Delay (sec/veh): 23.7
 Optimal Cycle: 54 Level Of Service: C

Street Name:	Red Hill Avenue						I-5 SB Ramps					
	North Bound			South Bound			East Bound			West Bound		
Approach:	North Bound			South Bound			East Bound			West Bound		
Movement:	L	T	R	L	T	R	L	T	R	L	T	R
Control:	Protected			Protected			Permitted			Permitted		
Rights:	Include			Include			Include			Include		
Min. Green:	0	0	0	0	0	0	0	0	0	0	0	0
Y+R:	4.0	4.0	4.0	4.0	4.0	4.0	4.0	4.0	4.0	4.0	4.0	4.0
Lanes:	0	0	4	0	1	0	1	0	0	0	1	0

Volume Module:

Base Vol:	0	1191	527	371	1064	0	200	5	367	0	0	0
Growth Adj:	1.00	1.00	1.00	1.00	1.00	1.00	1.00	1.00	1.00	1.00	1.00	1.00
Initial Bse:	0	1191	527	371	1064	0	200	5	367	0	0	0
User Adj:	1.00	1.00	1.00	1.00	1.00	1.00	1.00	1.00	1.00	1.00	1.00	1.00
PHF Adj:	1.00	1.00	1.00	1.00	1.00	1.00	1.00	1.00	1.00	1.00	1.00	1.00
PHF Volume:	0	1191	527	371	1064	0	200	5	367	0	0	0
Reduct Vol:	0	0	0	0	0	0	0	0	0	0	0	0
Reduced Vol:	0	1191	527	371	1064	0	200	5	367	0	0	0
PCE Adj:	1.00	1.00	1.00	1.00	1.00	1.00	1.00	1.00	1.00	1.00	1.00	1.00
MLF Adj:	1.00	1.00	1.00	1.00	1.00	1.00	1.00	1.00	1.00	1.00	1.00	1.00
FinalVolume:	0	1191	527	371	1064	0	200	5	367	0	0	0

Saturation Flow Module:

Sat/Lane:	1900	1900	1900	1900	1900	1900	1900	1900	1900	1900	1900	1900
Adjustment:	1.00	0.91	0.85	0.95	0.91	1.00	0.95	0.95	0.85	1.00	1.00	1.00
Lanes:	0.00	4.00	1.00	1.00	3.00	0.00	0.98	0.02	1.00	0.00	0.00	0.00
Final Sat.:	0	6916	1615	1805	5187	0	1757	44	1615	0	0	0

Capacity Analysis Module:

Vol/Sat:	0.00	0.17	0.33	0.21	0.21	0.00	0.11	0.11	0.23	0.00	0.00	0.00
Crit Moves:	****			****			****			****		
Green/Cycle:	0.00	0.41	0.41	0.26	0.67	0.00	0.28	0.28	0.28	0.00	0.00	0.00
Volume/Cap:	0.00	0.42	0.80	0.80	0.31	0.00	0.40	0.40	0.80	0.00	0.00	0.00
Delay/Veh:	0.0	21.2	32.8	44.2	7.1	0.0	29.4	29.4	42.7	0.0	0.0	0.0
User DelAdj:	1.00	1.00	1.00	1.00	1.00	1.00	1.00	1.00	1.00	1.00	1.00	1.00
AdjDel/Veh:	0.0	21.2	32.8	44.2	7.1	0.0	29.4	29.4	42.7	0.0	0.0	0.0
LOS by Move:	A	C	C	D	A	A	C	C	D	A	A	A
HCM2k85thQ:	0	11	24	19	8	0	8	8	19	0	0	0

Note: Queue reported is the number of cars per lane.

Santa Ana Circulation Element

Level of Service Computation Report

ICU 1(Loss as Cycle Length %) Method (Base Volume Alternative)

Intersection #109 Red Hill Avenue and Nisson Road

Cycle (sec): 100 Critical Vol./Cap.(X): 0.651
 Loss Time (sec): 5 Average Delay (sec/veh): xxxxxxx
 Optimal Cycle: 33 Level Of Service: B

Street Name:	Red Hill Avenue						Nisson Road					
	North Bound			South Bound			East Bound			West Bound		
Approach:	North Bound			South Bound			East Bound			West Bound		
Movement:	L	T	R	L	T	R	L	T	R	L	T	R
Control:	Protected			Protected			Split Phase			Split Phase		
Rights:	Include			Include			Include			Include		
Min. Green:	0	0	0	0	0	0	0	0	0	0	0	0
Y+R:	4.0	4.0	4.0	4.0	4.0	4.0	4.0	4.0	4.0	4.0	4.0	4.0
Lanes:	1	0	3	1	0	2	1	0	0	1	0	1

Volume Module:

Base Vol:	16	1244	23	162	1222	128	242	59	48	49	26	215
Growth Adj:	1.00	1.00	1.00	1.00	1.00	1.00	1.00	1.00	1.00	1.00	1.00	1.00
Initial Bse:	16	1244	23	162	1222	128	242	59	48	49	26	215
User Adj:	1.00	1.00	1.00	1.00	1.00	1.00	1.00	1.00	1.00	1.00	1.00	1.00
PHF Adj:	1.00	1.00	1.00	1.00	1.00	1.00	1.00	1.00	1.00	1.00	1.00	1.00
PHF Volume:	16	1244	23	162	1222	128	242	59	48	49	26	215
Reduct Vol:	0	0	0	0	0	0	0	0	0	0	0	0
Reduced Vol:	16	1244	23	162	1222	128	242	59	48	49	26	215
PCE Adj:	1.00	1.00	1.00	1.00	1.00	1.00	1.00	1.00	1.00	1.00	1.00	1.00
MLF Adj:	1.00	1.00	1.00	1.00	1.00	1.00	1.00	1.00	1.00	1.00	1.00	1.00
FinalVolume:	16	1244	23	162	1222	128	242	59	48	49	26	215

Saturation Flow Module:

Sat/Lane:	1600	1600	1600	1600	1600	1600	1600	1600	1600	1600	1600	1600
Adjustment:	1.00	1.05	1.00	1.00	1.05	1.00	1.00	1.00	1.00	1.00	1.00	1.00
Lanes:	1.00	3.93	0.07	1.00	2.72	0.28	1.00	0.55	0.45	1.00	0.11	0.89
Final Sat.:	1600	6584	116	1600	4545	455	1600	882	718	1600	173	1427

Capacity Analysis Module:

Vol/Sat:	0.01	0.19	0.20	0.10	0.27	0.28	0.15	0.07	0.07	0.03	0.15	0.15
Crit Moves:			****	****			****				****	

Santa Ana Circulation Element

Level Of Service Computation Report

ICU 1(Loss as Cycle Length %) Method (Base Volume Alternative)

Intersection #110 Red Hill Avenue and Walnut Avenue

Cycle (sec): 100 Critical Vol./Cap.(X): 0.636
 Loss Time (sec): 5 Average Delay (sec/veh): xxxxxx
 Optimal Cycle: 31 Level Of Service: B

Street Name:	Red Hill Avenue						Walnut Avenue					
Approach:	North Bound			South Bound			East Bound			West Bound		
Movement:	L	T	R	L	T	R	L	T	R	L	T	R
Control:	Protected			Protected			Protected			Protected		
Rights:	Include			Include			Include			Include		
Min. Green:	0	0	0	0	0	0	0	0	0	0	0	0
Y+R:	4.0	4.0	4.0	4.0	4.0	4.0	4.0	4.0	4.0	4.0	4.0	4.0
Lanes:	1	0	2	1	0	2	1	0	1	1	0	1

Volume Module:

Base Vol:	129	502	95	113	1135	127	104	258	254	263	348	166
Growth Adj:	1.00	1.00	1.00	1.00	1.00	1.00	1.00	1.00	1.00	1.00	1.00	1.00
Initial Bse:	129	502	95	113	1135	127	104	258	254	263	348	166
User Adj:	1.00	1.00	1.00	1.00	1.00	1.00	1.00	1.00	1.00	1.00	1.00	1.00
PHF Adj:	1.00	1.00	1.00	1.00	1.00	1.00	1.00	1.00	1.00	1.00	1.00	1.00
PHF Volume:	129	502	95	113	1135	127	104	258	254	263	348	166
Reduct Vol:	0	0	0	0	0	0	0	0	0	0	0	0
Reduced Vol:	129	502	95	113	1135	127	104	258	254	263	348	166
PCE Adj:	1.00	1.00	1.00	1.00	1.00	1.00	1.00	1.00	1.00	1.00	1.00	1.00
MLF Adj:	1.00	1.00	1.00	1.00	1.00	1.00	1.00	1.00	1.00	1.00	1.00	1.00
FinalVolume:	129	502	95	113	1135	127	104	258	254	263	348	166

Saturation Flow Module:

Sat/Lane:	1600	1600	1600	1600	1600	1600	1600	1600	1600	1600	1600	1600
Adjustment:	1.00	1.05	1.00	1.00	1.05	1.00	1.00	1.06	1.00	1.00	1.05	1.00
Lanes:	1.00	2.52	0.48	1.00	2.70	0.30	1.00	1.01	0.99	2.00	1.35	0.65
Final Sat.:	1600	4236	764	1600	4517	483	1600	1713	1588	3200	2267	1033

Capacity Analysis Module:

Vol/Sat:	0.08	0.12	0.12	0.07	0.25	0.26	0.07	0.15	0.16	0.08	0.15	0.16
Crit Moves:	****					****			****	****		

Santa Ana Circulation Element

Level Of Service Computation Report

ICU 1(Loss as Cycle Length %) Method (Base Volume Alternative)

Intersection #111 Red Hill Avenue and Valencia Avenue

Cycle (sec): 100 Critical Vol./Cap.(X): 0.652
 Loss Time (sec): 5 Average Delay (sec/veh): xxxxxx
 Optimal Cycle: 33 Level Of Service: B

Street Name:	Red Hill Avenue						Valencia Avenue					
Approach:	North Bound			South Bound			East Bound			West Bound		
Movement:	L	T	R	L	T	R	L	T	R	L	T	R
Control:	Protected			Protected			Protected			Protected		
Rights:	Ovl			Include			Include			Ovl		
Min. Green:	0	0	0	0	0	0	0	0	0	0	0	0
Y+R:	4.0	4.0	4.0	4.0	4.0	4.0	4.0	4.0	4.0	4.0	4.0	4.0
Lanes:	1	0	3	1	0	2	1	0	1	2	0	1

Volume Module:

Base Vol:	98	412	133	126	1082	72	49	343	133	315	433	153
Growth Adj:	1.00	1.00	1.00	1.00	1.00	1.00	1.00	1.00	1.00	1.00	1.00	1.00
Initial Bse:	98	412	133	126	1082	72	49	343	133	315	433	153
User Adj:	1.00	1.00	1.00	1.00	1.00	1.00	1.00	1.00	1.00	1.00	1.00	1.00
PHF Adj:	1.00	1.00	1.00	1.00	1.00	1.00	1.00	1.00	1.00	1.00	1.00	1.00
PHF Volume:	98	412	133	126	1082	72	49	343	133	315	433	153
Reduct Vol:	0	0	0	0	0	0	0	0	0	0	0	0
Reduced Vol:	98	412	133	126	1082	72	49	343	133	315	433	153
PCE Adj:	1.00	1.00	1.00	1.00	1.00	1.00	1.00	1.00	1.00	1.00	1.00	1.00
MLF Adj:	1.00	1.00	1.00	1.00	1.00	1.00	1.00	1.00	1.00	1.00	1.00	1.00
FinalVolume:	98	412	133	126	1082	72	49	343	133	315	433	153
OvlAdjVol:	0									27		

Saturation Flow Module:

Sat/Lane:	1600	1600	1600	1600	1600	1600	1600	1600	1600	1600	1600	1600
Adjustment:	1.00	1.06	1.00	1.00	1.04	1.00	1.00	1.06	1.00	1.00	1.06	1.00
Lanes:	1.00	3.02	0.98	1.00	2.81	0.19	1.00	1.00	1.00	2.00	1.00	1.00
Final Sat.:	1600	5138	1562	1600	4701	299	1600	1700	1600	3200	1700	1600

Capacity Analysis Module:

Vol/Sat:	0.06	0.08	0.09	0.08	0.23	0.24	0.03	0.20	0.08	0.10	0.25	0.10
OvlAdjV/S:	0.00									0.02		
Crit Moves:	****				****			****			****	

Santa Ana Circulation Element

Level Of Service Computation Report

ICU 1(Loss as Cycle Length %) Method (Base Volume Alternative)

Intersection #112 Tustin Ranch Road and Warner Avenue North

Cycle (sec): 100 Critical Vol./Cap.(X): 0.449
 Loss Time (sec): 5 Average Delay (sec/veh): xxxxxx
 Optimal Cycle: 22 Level Of Service: A

Street Name:	Tustin Ranch Road					Warner Avenue North						
Approach:	North Bound			South Bound			East Bound			West Bound		
Movement:	L	T	R	L	T	R	L	T	R	L	T	R
Control:	Protected			Protected			Split Phase			Split Phase		
Rights:	Ovl			Include			Include			Ovl		
Min. Green:	0	0	0	0	0	0	0	0	0	0	0	0
Y+R:	4.0	4.0	4.0	4.0	4.0	4.0	4.0	4.0	4.0	4.0	4.0	4.0
Lanes:	0	0	3	0	1		2	0	3	0	0	

Volume Module:	Tustin Ranch Road			Warner Avenue North		
Base Vol:	0	321	311	403	1140	0
Growth Adj:	1.00	1.00	1.00	1.00	1.00	1.00
Initial Bse:	0	321	311	403	1140	0
User Adj:	1.00	1.00	1.00	1.00	1.00	1.00
PHF Adj:	1.00	1.00	1.00	1.00	1.00	1.00
PHF Volume:	0	321	311	403	1140	0
Reduct Vol:	0	0	0	0	0	0
Reduced Vol:	0	321	311	403	1140	0
PCE Adj:	1.00	1.00	1.00	1.00	1.00	1.00
MLF Adj:	1.00	1.00	1.00	1.00	1.00	1.00
FinalVolume:	0	321	311	403	1140	0
OvlAdjVol:			30			0

Saturation Flow Module:	Tustin Ranch Road			Warner Avenue North		
Sat/Lane:	1600	1600	1600	1600	1600	1600
Adjustment:	1.00	1.06	1.00	1.00	1.06	1.00
Lanes:	0.00	3.00	1.00	2.00	3.00	0.00
Final Sat.:	0	5100	1600	3200	5100	0

Capacity Analysis Module:	Tustin Ranch Road			Warner Avenue North		
Vol/Sat:	0.00	0.06	0.19	0.13	0.22	0.00
OvlAdjV/S:			0.02			
Crit Moves:	****			****		****

Santa Ana Circulation Element

Level Of Service Computation Report

ICU 1(Loss as Cycle Length %) Method (Base Volume Alternative)

Intersection #113 Tustin Ranch Road and Walnut Avenue

Cycle (sec): 100 Critical Vol./Cap.(X): 1.273

Loss Time (sec): 5 Average Delay (sec/veh): xxxxxx

Optimal Cycle: 180 Level Of Service: F

Street Name:	Tustin Ranch Road						Walnut Avenue					
Approach:	North Bound			South Bound			East Bound			West Bound		
Movement:	L	T	R	L	T	R	L	T	R	L	T	R
Control:	Protected			Protected			Protected			Protected		
Rights:	Ovl			Ovl			Include			Ovl		
Min. Green:	0	0	0	0	0	0	0	0	0	0	0	0
Y+R:	4.0	4.0	4.0	4.0	4.0	4.0	4.0	4.0	4.0	4.0	4.0	4.0
Lanes:	2	0	3	0	1		2	0	3	0	1	

Volume Module:

Base Vol:	92	567	283	1076	3008	401	834	1089	658	187	276	233
Growth Adj:	1.00	1.00	1.00	1.00	1.00	1.00	1.00	1.00	1.00	1.00	1.00	1.00
Initial Bse:	92	567	283	1076	3008	401	834	1089	658	187	276	233
User Adj:	1.00	1.00	1.00	1.00	1.00	1.00	1.00	1.00	1.00	1.00	1.00	1.00
PHF Adj:	1.00	1.00	1.00	1.00	1.00	1.00	1.00	1.00	1.00	1.00	1.00	1.00
PHF Volume:	92	567	283	1076	3008	401	834	1089	658	187	276	233
Reduct Vol:	0	0	0	0	0	0	0	0	0	0	0	0
Reduced Vol:	92	567	283	1076	3008	401	834	1089	658	187	276	233
PCE Adj:	1.00	1.00	1.00	1.00	1.00	1.00	1.00	1.00	1.00	1.00	1.00	1.00
MLF Adj:	1.00	1.00	1.00	1.00	1.00	1.00	1.00	1.00	1.00	1.00	1.00	1.00
FinalVolume:	92	567	283	1076	3008	401	834	1089	658	187	276	233
OvlAdjVol:	190			0						0		

Saturation Flow Module:

Sat/Lane:	1600	1600	1600	1600	1600	1600	1600	1600	1600	1600	1600	1600
Adjustment:	1.00	1.06	1.00	1.00	1.06	1.00	1.00	1.05	1.00	1.00	1.06	1.00
Lanes:	2.00	3.00	1.00	2.00	3.00	1.00	2.00	1.25	0.75	2.00	2.00	1.00
Final Sat.:	3200	5100	1600	3200	5100	1600	3200	2095	1205	3200	3400	1600

Capacity Analysis Module:

Vol/Sat:	0.03	0.11	0.18	0.34	0.59	0.25	0.26	0.52	0.55	0.06	0.08	0.15
OvlAdjV/S:	0.12			0.00						0.00		
Crit Moves:	****			****			****			****		

Santa Ana Circulation Element

Level Of Service Computation Report

2000 HCM Operations Method (Base Volume Alternative)

Intersection #114 SR-55 SB Ramps and Irvine Boulevard

Cycle (sec): 100 Critical Vol./Cap.(X): 1.099
 Loss Time (sec): 5 Average Delay (sec/veh): 41.0
 Optimal Cycle: 180 Level Of Service: D

Street Name:	SR-55 SB Ramps						Irvine Boulevard					
	North Bound			South Bound			East Bound			West Bound		
Approach:	North Bound			South Bound			East Bound			West Bound		
Movement:	L	T	R	L	T	R	L	T	R	L	T	R
Control:	Protected			Permitted			Protected			Protected		
Rights:	Include			Include			Include			Include		
Min. Green:	0	0	0	0	0	0	0	0	0	0	0	0
Y+R:	4.0	4.0	4.0	4.0	4.0	4.0	4.0	4.0	4.0	4.0	4.0	4.0
Lanes:	0	0	0	1	0	1	0	0	2	1	0	3

Volume Module:												
Base Vol:	0	0	0	65	0	71	0	647	1161	496	1240	0
Growth Adj:	1.00	1.00	1.00	1.00	1.00	1.00	1.00	1.00	1.00	1.00	1.00	1.00
Initial Bse:	0	0	0	65	0	71	0	647	1161	496	1240	0
User Adj:	1.00	1.00	1.00	1.00	1.00	1.00	1.00	1.00	1.00	1.00	1.00	1.00
PHF Adj:	1.00	1.00	1.00	1.00	1.00	1.00	1.00	1.00	1.00	1.00	1.00	1.00
PHF Volume:	0	0	0	65	0	71	0	647	1161	496	1240	0
Reduct Vol:	0	0	0	0	0	0	0	0	0	0	0	0
Reduced Vol:	0	0	0	65	0	71	0	647	1161	496	1240	0
PCE Adj:	1.00	1.00	1.00	1.00	1.00	1.00	1.00	1.00	1.00	1.00	1.00	1.00
MLF Adj:	1.00	1.00	1.00	1.00	1.00	1.00	1.00	1.00	1.00	1.00	1.00	1.00
FinalVolume:	0	0	0	65	0	71	0	647	1161	496	1240	0

Saturation Flow Module:												
Sat/Lane:	1900	1900	1900	1900	1900	1900	1900	1900	1900	1900	1900	1900
Adjustment:	1.00	1.00	1.00	0.88	1.00	0.77	1.00	0.82	0.82	0.95	0.91	1.00
Lanes:	0.00	0.00	0.00	1.44	0.00	1.56	0.00	2.00	1.00	1.00	3.00	0.00
Final Sat.:	0	0	0	2417	0	2277	0	3126	1563	1805	5187	0

Capacity Analysis Module:												
Vol/Sat:	0.00	0.00	0.00	0.03	0.00	0.03	0.00	0.21	0.74	0.27	0.24	0.00
Crit Moves:				****					****	****		
Green/Cycle:	0.00	0.00	0.00	0.02	0.00	0.05	0.00	0.68	0.68	0.25	0.93	0.00
Volume/Cap:	0.00	0.00	0.00	0.90	0.00	0.65	0.00	0.31	1.10	1.10	0.26	0.00
Delay/Veh:	0.0	0.0	0.0	94.5	0.0	54.0	0.0	6.6	70.6	109.4	0.4	0.0
User DelAdj:	1.00	1.00	1.00	1.00	1.00	1.00	1.00	1.00	1.00	1.00	1.00	1.00
AdjDel/Veh:	0.0	0.0	0.0	94.5	0.0	54.0	0.0	6.6	70.6	109.4	0.4	0.0
LOS by Move:	A	A	A	F	A	D	A	A	E	F	A	A

HCM2k85thQ: 0 0 0 5 0 4 0 7 77 36 2 0

Note: Queue reported is the number of cars per lane.

Santa Ana Circulation Element

Level of Service Computation Report

2000 HCM Operations Method (Base Volume Alternative)

 Intersection #115 SR-55 NB Ramps and Irvine Boulevard

Cycle (sec): 100 Critical Vol./Cap.(X): 0.906
 Loss Time (sec): 5 Average Delay (sec/veh): 23.5
 Optimal Cycle: 93 Level Of Service: C

Street Name:	SR-55 NB Ramps						Irvine Boulevard					
	North Bound			South Bound			East Bound			West Bound		
Approach:	North Bound			South Bound			East Bound			West Bound		
Movement:	L	T	R	L	T	R	L	T	R	L	T	R
Control:	Permitted			Protected			Protected			Protected		
Rights:	Include			Include			Include			Include		
Min. Green:	0	0	0	0	0	0	0	0	0	0	0	0
Y+R:	4.0	4.0	4.0	4.0	4.0	4.0	4.0	4.0	4.0	4.0	4.0	4.0
Lanes:	1	0	1	0	0	0	1	0	3	0	0	2

Volume Module:

Base Vol:	440	0	423	0	0	0	222	526	0	0	1241	863
Growth Adj:	1.00	1.00	1.00	1.00	1.00	1.00	1.00	1.00	1.00	1.00	1.00	1.00
Initial Bse:	440	0	423	0	0	0	222	526	0	0	1241	863
User Adj:	1.00	1.00	1.00	1.00	1.00	1.00	1.00	1.00	1.00	1.00	1.00	1.00
PHF Adj:	1.00	1.00	1.00	1.00	1.00	1.00	1.00	1.00	1.00	1.00	1.00	1.00
PHF Volume:	440	0	423	0	0	0	222	526	0	0	1241	863
Reduct Vol:	0	0	0	0	0	0	0	0	0	0	0	0
Reduced Vol:	440	0	423	0	0	0	222	526	0	0	1241	863
PCE Adj:	1.00	1.00	1.00	1.00	1.00	1.00	1.00	1.00	1.00	1.00	1.00	1.00
MLF Adj:	1.00	1.00	1.00	1.00	1.00	1.00	1.00	1.00	1.00	1.00	1.00	1.00
FinalVolume:	440	0	423	0	0	0	222	526	0	0	1241	863

Saturation Flow Module:

Sat/Lane:	1900	1900	1900	1900	1900	1900	1900	1900	1900	1900	1900	1900
Adjustment:	0.75	1.00	0.74	1.00	1.00	1.00	0.95	0.91	1.00	1.00	0.85	0.85
Lanes:	1.51	0.00	1.49	0.00	0.00	0.00	1.00	3.00	0.00	0.00	2.00	1.00
Final Sat.:	2135	0	2097	0	0	0	1805	5187	0	0	3247	1624

Capacity Analysis Module:

Vol/Sat:	0.21	0.00	0.20	0.00	0.00	0.00	0.12	0.10	0.00	0.00	0.38	0.53
Crit Moves:	****						****			****		
Green/Cycle:	0.23	0.00	0.45	0.00	0.00	0.00	0.14	0.72	0.00	0.00	0.59	0.59
Volume/Cap:	0.91	0.00	0.44	0.00	0.00	0.00	0.91	0.14	0.00	0.00	0.65	0.91
Delay/Veh:	49.8	0.0	18.8	0.0	0.0	0.0	76.1	4.3	0.0	0.0	14.3	23.8
User DelAdj:	1.00	1.00	1.00	1.00	1.00	1.00	1.00	1.00	1.00	1.00	1.00	1.00
AdjDel/Veh:	49.8	0.0	18.8	0.0	0.0	0.0	76.1	4.3	0.0	0.0	14.3	23.8
LOS by Move:	D	A	B	A	A	A	E	A	A	A	B	C
HCM2k85thQ:	18	0	10	0	0	0	15	3	0	0	21	42

Note: Queue reported is the number of cars per lane.

APPENDIX D.4
ANALYSIS WORKSHEETS –
2045 NP (PM Peak Hour)

Santa Ana Circulation Element

Scenario Report

Scenario: 2045 NP PM Peak Hour

Command: Default Command

Volume: 2045 NP PM

Geometry: MPAH

Impact Fee: Default Impact Fee

Trip Generation: Default Trip Generation

Trip Distribution: Default Trip Distribution

Paths: Default Path

Routes: Default Route

Configuration: Default Configuration

 Santa Ana Circulation Element

 Impact Analysis Report
 Level Of Service

Intersection	Base		Future		Change in
	Del/	V/	Del/	V/	
	LOS	Veh C	LOS	Veh C	
# 1 Euclid St and 1st St	D	xxxxxx 0.857	D	xxxxxx 0.857	+ 0.000 V/C
# 2 Euclid St and McFadden Ave	D	xxxxxx 0.896	D	xxxxxx 0.896	+ 0.000 V/C
# 3 Euclid St and Edinger Ave	D	xxxxxx 0.888	D	xxxxxx 0.888	+ 0.000 V/C
# 4 Newhope St and Hazard Ave	C	xxxxxx 0.721	C	xxxxxx 0.721	+ 0.000 V/C
# 5 Newhope St and McFadden Ave	C	xxxxxx 0.777	C	xxxxxx 0.777	+ 0.000 V/C
# 6 Harbor Blvd and SR-22 WB Off-R	C	24.2 0.802	C	24.2 0.802	+ 0.000 D/V
# 7 Trask Avenue and SR-22 EB On-R	B	13.6 0.533	B	13.6 0.533	+ 0.000 D/V
# 8 Harbor Blvd and Westminster Av	D	xxxxxx 0.882	D	xxxxxx 0.882	+ 0.000 V/C
# 9 Harbor Blvd and 1st St	C	xxxxxx 0.778	C	xxxxxx 0.778	+ 0.000 V/C
# 10 Harbor Blvd and McFadden Ave	D	xxxxxx 0.812	D	xxxxxx 0.812	+ 0.000 V/C
# 11 Harbor Blvd and Edinger Ave	C	xxxxxx 0.725	C	xxxxxx 0.725	+ 0.000 V/C
# 12 Harbor Blvd and Warner Ave	F	xxxxxx 1.536	F	xxxxxx 1.536	+ 0.000 V/C
# 13 Harbor Blvd and Segerstrom Ave	E	xxxxxx 0.921	E	xxxxxx 0.921	+ 0.000 V/C
# 14 MacArthur Blvd and Hyland Ave	E	xxxxxx 0.917	E	xxxxxx 0.917	+ 0.000 V/C
# 15 MacArthur Blvd and Harbor Blvd	C	xxxxxx 0.783	C	xxxxxx 0.783	+ 0.000 V/C
# 16 Harbor Blvd and Sunflower Ave	C	xxxxxx 0.717	C	xxxxxx 0.717	+ 0.000 V/C
# 17 Harbor Blvd and I-405 NB Off-R	B	18.3 0.699	B	18.3 0.699	+ 0.000 D/V
# 18 Harbor Blvd and I-405 SB Off-R	B	17.9 0.667	B	17.9 0.667	+ 0.000 D/V
# 19 Fairview St and Civic Center D	C	xxxxxx 0.757	C	xxxxxx 0.757	+ 0.000 V/C
# 20 Fairview St and 1st St	D	xxxxxx 0.898	D	xxxxxx 0.898	+ 0.000 V/C
# 21 Fairview St and McFadden Ave	C	xxxxxx 0.776	C	xxxxxx 0.776	+ 0.000 V/C
# 22 Fairview St and Edinger Ave	E	xxxxxx 0.916	E	xxxxxx 0.916	+ 0.000 V/C
# 23 Fairview St and Warner Ave	C	xxxxxx 0.796	C	xxxxxx 0.796	+ 0.000 V/C
# 24 Fairview St and MacArthur Blvd	C	xxxxxx 0.768	C	xxxxxx 0.768	+ 0.000 V/C

 Santa Ana Circulation Element

Intersection	Base		Future		Change in
	Del/ LOS	V/ Veh	Del/ LOS	V/ Veh	
# 25 Fairview Rd and Sunflower Ave	C	xxxxxx 0.715	C	xxxxxx 0.715	+ 0.000 V/C
# 26 Greenville St and Edinger Ave	A	xxxxxx 0.595	A	xxxxxx 0.595	+ 0.000 V/C
# 27 Greenville St and Segerstrom A	C	xxxxxx 0.777	C	xxxxxx 0.777	+ 0.000 V/C
# 28 Raitt St and McFadden Ave	C	xxxxxx 0.758	C	xxxxxx 0.758	+ 0.000 V/C
# 29 Raitt St and Edinger Ave	E	xxxxxx 0.986	E	xxxxxx 0.986	+ 0.000 V/C
# 30 Bear St and MacArthur Blvd	D	xxxxxx 0.851	D	xxxxxx 0.851	+ 0.000 V/C
# 31 Bristol St and 17th St	D	xxxxxx 0.823	D	xxxxxx 0.823	+ 0.000 V/C
# 32 Bristol St and Civic Center Dr	E	xxxxxx 0.911	E	xxxxxx 0.911	+ 0.000 V/C
# 33 Bristol St and Santa Ana Blvd	D	xxxxxx 0.853	D	xxxxxx 0.853	+ 0.000 V/C
# 34 Bristol St and 1st St	D	xxxxxx 0.826	D	xxxxxx 0.826	+ 0.000 V/C
# 35 Bristol St and McFadden Ave	F	xxxxxx 1.028	F	xxxxxx 1.028	+ 0.000 V/C
# 36 Bristol St and Warner Ave	D	xxxxxx 0.847	D	xxxxxx 0.847	+ 0.000 V/C
# 37 Bristol St and Segerstrom Ave	D	xxxxxx 0.870	D	xxxxxx 0.870	+ 0.000 V/C
# 38 Bristol St and Alton Ave	B	xxxxxx 0.633	B	xxxxxx 0.633	+ 0.000 V/C
# 39 Bristol St and MacArthur Blvd	C	xxxxxx 0.765	C	xxxxxx 0.765	+ 0.000 V/C
# 40 Bristol St and Sunflower Ave	B	xxxxxx 0.692	B	xxxxxx 0.692	+ 0.000 V/C
# 41 Bristol St and I-405 NB Ramps	C	28.5 0.825	C	28.5 0.825	+ 0.000 D/V
# 42 Bristol St and I-405 SB Ramps	B	18.3 0.617	B	18.3 0.617	+ 0.000 D/V
# 43 Flower St and Santa Ana Blvd	D	xxxxxx 0.857	D	xxxxxx 0.857	+ 0.000 V/C
# 44 Flower St and 1st St	D	xxxxxx 0.877	D	xxxxxx 0.877	+ 0.000 V/C
# 45 Flower St and McFadden Ave	F	xxxxxx 1.037	F	xxxxxx 1.037	+ 0.000 V/C
# 46 Flower St and Segerstrom Ave	D	xxxxxx 0.866	D	xxxxxx 0.866	+ 0.000 V/C
# 47 Flower St and MacArthur Blvd	E	xxxxxx 0.900	E	xxxxxx 0.900	+ 0.000 V/C
# 48 Main St and La Veta Ave	B	xxxxxx 0.696	B	xxxxxx 0.696	+ 0.000 V/C
# 49 Main St and Mainplace Dr / Mem	A	xxxxxx 0.556	A	xxxxxx 0.556	+ 0.000 V/C
# 50 Main St and 17th St	C	xxxxxx 0.760	C	xxxxxx 0.760	+ 0.000 V/C

Traffix 8.0.0715 (c) 2008 Dowling Assoc. Licensed to IBI GROUP, IRVINE, CA

 Santa Ana Circulation Element

Intersection	Base		Future		Change in	
	Del/ LOS	V/ Veh C	Del/ LOS	V/ Veh C		
# 51 Main St and Civic Center Dr	E xxxxxx	0.965	E xxxxxx	0.965	+ 0.000	V/C
# 52 Main St and Santa Ana Blvd	C xxxxxx	0.792	C xxxxxx	0.792	+ 0.000	V/C
# 53 Main St and 4th St	A xxxxxx	0.447	A xxxxxx	0.447	+ 0.000	V/C
# 54 Main St and 1st St	C xxxxxx	0.744	C xxxxxx	0.744	+ 0.000	V/C
# 55 Main St and McFadden Ave	E xxxxxx	0.925	E xxxxxx	0.925	+ 0.000	V/C
# 56 Main St and Edinger Ave	D xxxxxx	0.867	D xxxxxx	0.867	+ 0.000	V/C
# 57 Main St and MacArthur Blvd	C xxxxxx	0.749	C xxxxxx	0.749	+ 0.000	V/C
# 58 Penn Wy and 17th St	C 25.5	0.872	C 25.5	0.872	+ 0.000	D/V
# 59 I-5 NB Off Ramps/17th Street	B 19.0	0.587	B 19.0	0.587	+ 0.000	D/V
# 60 Penn Wy and I-5 SB Ramps	C 23.0	0.573	C 23.0	0.573	+ 0.000	D/V
# 61 Santiago St and Civic Center D	F 110.0	1.369	F 110.0	1.369	+ 0.000	V/C
# 62 Santiago St and Santa Ana Blvd	F xxxxxx	1.017	F xxxxxx	1.017	+ 0.000	V/C
# 63 Standard Ave and 4th St	D xxxxxx	0.893	D xxxxxx	0.893	+ 0.000	V/C
# 64 Standard Ave and 1st St	E xxxxxx	0.968	E xxxxxx	0.968	+ 0.000	V/C
# 65 Standard Ave and Mcfadden Ave	D xxxxxx	0.828	D xxxxxx	0.828	+ 0.000	V/C
# 66 Halladay St and Warner Ave	E xxxxxx	0.975	E xxxxxx	0.975	+ 0.000	V/C
# 67 Halladay St and Dyer Rd	F xxxxxx	1.057	F xxxxxx	1.057	+ 0.000	V/C
# 68 SR-55 SB Ramps and MacArthur B	B 17.8	0.567	B 17.8	0.567	+ 0.000	D/V
# 69 SR-55 NB Ramps and MacArthur B	B 14.6	0.484	B 14.6	0.484	+ 0.000	D/V
# 70 SR-55 SB Ramps and Dyer Rd	C 26.5	0.663	C 26.5	0.663	+ 0.000	D/V
# 71 Glassell St and La Veta Ave	C xxxxxx	0.744	C xxxxxx	0.744	+ 0.000	V/C
# 72 Glassell St and SR-22 WB Ramps	C 30.5	0.910	C 30.5	0.910	+ 0.000	D/V
# 73 Grand Ave / Glassell St and SR	C 31.6	0.931	C 31.6	0.931	+ 0.000	D/V
# 74 Grand Ave and Fairhaven Ave	C xxxxxx	0.717	C xxxxxx	0.717	+ 0.000	V/C
# 75 Grand Ave and Santa Clara Ave	D xxxxxx	0.808	D xxxxxx	0.808	+ 0.000	V/C

 Santa Ana Circulation Element

Intersection	Base		Future		Change in	
	Del/ LOS	V/ Veh C	Del/ LOS	V/ Veh C		
# 76 Grand Ave and 17th St	D	xxxxxx 0.856	D	xxxxxx 0.856	+	0.000 V/C
# 77 Grand Ave and I-5 NB Ramps	B	10.1 0.696	B	10.1 0.696	+	0.000 D/V
# 78 Grand Ave and Santa Ana Blvd	C	25.3 0.721	C	25.3 0.721	+	0.000 D/V
# 79 Grand Ave and 1st St	C	xxxxxx 0.731	C	xxxxxx 0.731	+	0.000 V/C
# 80 Grand Ave and Chestnut Ave	B	xxxxxx 0.688	B	xxxxxx 0.688	+	0.000 V/C
# 81 Grand Ave and McFadden Ave	D	xxxxxx 0.821	D	xxxxxx 0.821	+	0.000 V/C
# 82 Grand Ave and Edinger Ave	F	xxxxxx 1.004	F	xxxxxx 1.004	+	0.000 V/C
# 83 Grand Ave and Warner Ave	D	xxxxxx 0.827	D	xxxxxx 0.827	+	0.000 V/C
# 84 SR-55 NB Ramps and Dyer Rd	A	5.7 0.362	A	5.7 0.362	+	0.000 D/V
# 85 Cambridge St and La Veta Ave	C	19.7 0.779	C	19.7 0.779	+	0.000 V/C
# 86 Cambridge St and Fairhaven Ave	A	xxxxxx 0.454	A	xxxxxx 0.454	+	0.000 V/C
# 87 Mabury St and 1st Street	C	27.1 0.674	C	27.1 0.674	+	0.000 D/V
# 88 Tustin St and La Veta Ave	A	xxxxxx 0.381	A	xxxxxx 0.381	+	0.000 V/C
# 89 Tustin St and SR-22 WB On-Ramp	B	11.1 0.391	B	11.1 0.391	+	0.000 D/V
# 90 Tustin St and SR-22 EB Off-Ram	C	23.1 0.679	C	23.1 0.679	+	0.000 D/V
# 91 Tustin Ave and Fairhaven Ave	B	xxxxxx 0.685	B	xxxxxx 0.685	+	0.000 V/C
# 92 Tustin Ave and Santa Clara Ave	C	xxxxxx 0.709	C	xxxxxx 0.709	+	0.000 V/C
# 93 Tustin Ave and 17th St	C	xxxxxx 0.797	C	xxxxxx 0.797	+	0.000 V/C
# 94 Tustin Ave and 4th St	C	xxxxxx 0.708	C	xxxxxx 0.708	+	0.000 V/C
# 95 SR-55 SB Ramps / Auto Mall Dr	C	25.5 0.702	C	25.5 0.702	+	0.000 D/V
# 96 SR-55 NB Ramps / Del Amo Ave a	D	39.1 0.895	D	39.1 0.895	+	0.000 D/V
# 97 Red Hill Ave and Edinger Ave	D	xxxxxx 0.853	D	xxxxxx 0.853	+	0.000 V/C
# 98 Red Hill Ave and Warner Ave	D	xxxxxx 0.875	D	xxxxxx 0.875	+	0.000 V/C
# 99 Red Hill Ave and Dyer Rd / bar	A	xxxxxx 0.537	A	xxxxxx 0.537	+	0.000 V/C
#100 Red Hill Ave and Alton Pkwy	F	xxxxxx 1.184	F	xxxxxx 1.184	+	0.000 V/C
#101 Red Hill Ave and MacArthur Blv	C	xxxxxx 0.702	C	xxxxxx 0.702	+	0.000 V/C

Traffix 8.0.0715 (c) 2008 Dowling Assoc. Licensed to IBI GROUP, IRVINE, CA

 Santa Ana Circulation Element

Intersection	Base		Future		Change in
	Del/ LOS	V/ Veh C	Del/ LOS	V/ Veh C	
#102 Red Hill Ave and Main St	D	xxxxx 0.813	D	xxxxx 0.813	+ 0.000 V/C
#103 I-5 SB Ramps and Santa Ana Blv	B	18.4 0.487	B	18.4 0.487	+ 0.000 D/V
#104 Tustin Ranch Rd and Warner Ave	B	xxxxx 0.645	B	xxxxx 0.645	+ 0.000 V/C
#105 Von Karman Ave and Barranca Pk	F	xxxxx 1.228	F	xxxxx 1.228	+ 0.000 V/C
#106 Red Hill Avenue and El Camino	C	xxxxx 0.779	C	xxxxx 0.779	+ 0.000 V/C
#107 Red Hill Avenue and I-5 NB Ram	C	23.7 0.634	C	23.7 0.634	+ 0.000 D/V
#108 Red Hill Avenue and I-5 SB Ram	C	22.2 0.695	C	22.2 0.695	+ 0.000 D/V
#109 Red Hill Avenue and Nisson Roa	B	xxxxx 0.693	B	xxxxx 0.693	+ 0.000 V/C
#110 Red Hill Avenue and Walnut Ave	C	xxxxx 0.739	C	xxxxx 0.739	+ 0.000 V/C
#111 Red Hill Avenue and Valencia A	C	xxxxx 0.738	C	xxxxx 0.738	+ 0.000 V/C
#112 Tustin Ranch Road and Warner A	D	xxxxx 0.885	D	xxxxx 0.885	+ 0.000 V/C
#113 Tustin Ranch Road and Walnut A	F	xxxxx 1.715	F	xxxxx 1.715	+ 0.000 V/C
#114 SR-55 SB Ramps and Irvine Boul	C	25.6 0.915	C	25.6 0.915	+ 0.000 D/V
#115 SR-55 NB Ramps and Irvine Boul	C	22.9 0.932	C	22.9 0.932	+ 0.000 D/V

Santa Ana Circulation Element

Level Of Service Computation Report

ICU 1(Loss as Cycle Length %) Method (Base Volume Alternative)

Intersection #1 Euclid St and 1st St

Cycle (sec): 100 Critical Vol./Cap.(X): 0.857
 Loss Time (sec): 5 Average Delay (sec/veh): xxxxxx
 Optimal Cycle: 67 Level Of Service: D

Approach:	North Bound			South Bound			East Bound			West Bound		
Movement:	L	T	R	L	T	R	L	T	R	L	T	R
Control:	Protected			Protected			Protected			Protected		
Rights:	Include			Include			WideBypass			WideBypass		
Min. Green:	0	0	0	0	0	0	0	0	0	0	0	0
Y+R:	4.0	4.0	4.0	4.0	4.0	4.0	4.0	4.0	4.0	4.0	4.0	4.0
Lanes:	1	0	2	1	0	2	1	0	2	1	0	2

Volume Module:

Base Vol:	169	1569	126	152	866	164	212	678	106	209	877	209
Growth Adj:	1.00	1.00	1.00	1.00	1.00	1.00	1.00	1.00	1.00	1.00	1.00	1.00
Initial Bse:	169	1569	126	152	866	164	212	678	106	209	877	209
User Adj:	1.00	1.00	1.00	1.00	1.00	1.00	1.00	1.00	1.00	1.00	1.00	1.00
PHF Adj:	1.00	1.00	1.00	1.00	1.00	1.00	1.00	1.00	1.00	1.00	1.00	1.00
PHF Volume:	169	1569	126	152	866	164	212	678	106	209	877	209
Reduct Vol:	0	0	0	0	0	0	0	0	0	0	0	0
Reduced Vol:	169	1569	126	152	866	164	212	678	106	209	877	209
PCE Adj:	1.00	1.00	1.00	1.00	1.00	1.00	1.00	1.00	1.00	1.00	1.00	1.00
MLF Adj:	1.00	1.00	1.00	1.00	1.00	1.00	1.00	1.00	1.00	1.00	1.00	1.00
FinalVolume:	169	1569	126	152	866	164	212	678	106	209	877	209

Saturation Flow Module:

Sat/Lane:	1600	1600	1600	1600	1600	1600	1600	1600	1600	1600	1600	1600
Adjustment:	1.00	1.05	1.00	1.00	1.05	1.00	1.00	1.05	1.00	1.00	1.05	1.00
Lanes:	1.00	2.78	0.22	1.00	2.52	0.48	1.00	2.59	0.41	1.00	2.42	0.58
Final Sat.:	1600	4643	357	1600	4236	764	1600	4351	649	1600	4076	924

Capacity Analysis Module:

Vol/Sat:	0.11	0.34	0.35	0.10	0.20	0.21	0.13	0.16	0.16	0.13	0.22	0.23
Crit Moves:			****	****			****			****		

Santa Ana Circulation Element

Level Of Service Computation Report

ICU 1(Loss as Cycle Length %) Method (Base Volume Alternative)

Intersection #2 Euclid St and McFadden Ave

Cycle (sec): 100 Critical Vol./Cap.(X): 0.896
 Loss Time (sec): 5 Average Delay (sec/veh): xxxxxx
 Optimal Cycle: 84 Level Of Service: D

Approach:	North Bound			South Bound			East Bound			West Bound		
Movement:	L	T	R	L	T	R	L	T	R	L	T	R
Control:	Protected			Protected			Prot+Permit			Prot+Permit		
Rights:	WideBypass			Include			Include			Include		
Min. Green:	0	0	0	0	0	0	0	0	0	0	0	0
Y+R:	4.0	4.0	4.0	4.0	4.0	4.0	4.0	4.0	4.0	4.0	4.0	4.0
Lanes:	1	0	2	1	0	2	1	0	1	1	0	1

Volume Module:

Base Vol:	242	1973	127	96	1179	143	207	475	210	114	479	221
Growth Adj:	1.00	1.00	1.00	1.00	1.00	1.00	1.00	1.00	1.00	1.00	1.00	1.00
Initial Bse:	242	1973	127	96	1179	143	207	475	210	114	479	221
User Adj:	1.00	1.00	1.00	1.00	1.00	1.00	1.00	1.00	1.00	1.00	1.00	1.00
PHF Adj:	1.00	1.00	1.00	1.00	1.00	1.00	1.00	1.00	1.00	1.00	1.00	1.00
PHF Volume:	242	1973	127	96	1179	143	207	475	210	114	479	221
Reduct Vol:	0	0	0	0	0	0	0	0	0	0	0	0
Reduced Vol:	242	1973	127	96	1179	143	207	475	210	114	479	221
PCE Adj:	1.00	1.00	1.00	1.00	1.00	1.00	1.00	1.00	1.00	1.00	1.00	1.00
MLF Adj:	1.00	1.00	1.00	1.00	1.00	1.00	1.00	1.00	1.00	1.00	1.00	1.00
FinalVolume:	242	1973	127	96	1179	143	207	475	210	114	479	221

Saturation Flow Module:

Sat/Lane:	1600	1600	1600	1600	1600	1600	1600	1600	1600	1600	1600	1600
Adjustment:	1.00	1.04	1.00	1.00	1.05	1.00	1.00	1.05	1.00	1.00	1.05	1.00
Lanes:	1.00	2.82	0.18	1.00	2.68	0.32	1.00	1.39	0.61	1.00	1.37	0.63
Final Sat.:	1600	4710	290	1600	4481	519	1600	2319	981	1600	2290	1010

Capacity Analysis Module:

Vol/Sat:	0.15	0.42	0.44	0.06	0.26	0.28	0.13	0.20	0.21	0.07	0.21	0.22
Crit Moves:			****	****			****			****		

Santa Ana Circulation Element

Level Of Service Computation Report

ICU 1(Loss as Cycle Length %) Method (Base Volume Alternative)

Intersection #3 Euclid St and Edinger Ave

Cycle (sec): 100 Critical Vol./Cap.(X): 0.888
 Loss Time (sec): 5 Average Delay (sec/veh): xxxxxx
 Optimal Cycle: 80 Level Of Service: D

Approach:	North Bound			South Bound			East Bound			West Bound		
Movement:	L	T	R	L	T	R	L	T	R	L	T	R
Control:	Protected			Protected			Protected			Protected		
Rights:	Include			Include			Include			Include		
Min. Green:	0	0	0	0	0	0	0	0	0	0	0	0
Y+R:	4.0	4.0	4.0	4.0	4.0	4.0	4.0	4.0	4.0	4.0	4.0	4.0
Lanes:	2	0	2	1	0	0	2	0	2	0	1	0

Volume Module:

Base Vol:	539	1610	115	136	897	228	141	544	163	128	1181	191
Growth Adj:	1.00	1.00	1.00	1.00	1.00	1.00	1.00	1.00	1.00	1.00	1.00	1.00
Initial Bse:	539	1610	115	136	897	228	141	544	163	128	1181	191
User Adj:	1.00	1.00	1.00	1.00	1.00	1.00	1.00	1.00	1.00	1.00	1.00	1.00
PHF Adj:	1.00	1.00	1.00	1.00	1.00	1.00	1.00	1.00	1.00	1.00	1.00	1.00
PHF Volume:	539	1610	115	136	897	228	141	544	163	128	1181	191
Reduct Vol:	0	0	0	0	0	0	0	0	0	0	0	0
Reduced Vol:	539	1610	115	136	897	228	141	544	163	128	1181	191
PCE Adj:	1.00	1.00	1.00	1.00	1.00	1.00	1.00	1.00	1.00	1.00	1.00	1.00
MLF Adj:	1.00	1.00	1.00	1.00	1.00	1.00	1.00	1.00	1.00	1.00	1.00	1.00
FinalVolume:	539	1610	115	136	897	228	141	544	163	128	1181	191

Saturation Flow Module:

Sat/Lane:	1600	1600	1600	1600	1600	1600	1600	1600	1600	1600	1600	1600
Adjustment:	1.00	1.04	1.00	1.00	1.05	1.00	1.00	1.06	1.00	1.00	1.06	1.00
Lanes:	2.00	2.80	0.20	2.00	2.39	0.61	1.00	2.00	1.00	1.00	2.00	1.00
Final Sat.:	3200	4680	320	3200	4027	973	1600	3400	1600	1600	3400	1600

Capacity Analysis Module:

Vol/Sat:	0.17	0.34	0.36	0.04	0.22	0.23	0.09	0.16	0.10	0.08	0.35	0.12
Crit Moves:	****					****	****				****	

Santa Ana Circulation Element

Level Of Service Computation Report

ICU 1(Loss as Cycle Length %) Method (Base Volume Alternative)

Intersection #4 Newhope St and Hazard Ave

Cycle (sec): 100 Critical Vol./Cap.(X): 0.721
Loss Time (sec): 5 Average Delay (sec/veh): xxxxxx
Optimal Cycle: 40 Level Of Service: C

Table with 4 columns: North Bound, South Bound, East Bound, West Bound. Rows include Movement, Control, Rights, Min. Green, Y+R, and Lanes.

Volume Module: Table with 12 columns representing different traffic flows. Rows include Base Vol, Growth Adj, Initial Bse, User Adj, PHF Adj, PHF Volume, Reduct Vol, Reduced Vol, PCE Adj, MLF Adj, and Final Volume.

Saturation Flow Module: Table with 12 columns. Rows include Sat/Lane, Adjustment, Lanes, and Final Sat.

Capacity Analysis Module: Table with 12 columns. Rows include Vol/Sat and Crit Moves.

Santa Ana Circulation Element

Level Of Service Computation Report

ICU 1(Loss as Cycle Length %) Method (Base Volume Alternative)

Intersection #5 Newhope St and McFadden Ave

Cycle (sec): 100 Critical Vol./Cap.(X): 0.777
Loss Time (sec): 5 Average Delay (sec/veh): xxxxxx
Optimal Cycle: 48 Level Of Service: C

Table with 4 columns: North Bound, South Bound, East Bound, West Bound. Rows include Movement, Control, Rights, Min. Green, Y+R, and Lanes.

Volume Module table with 12 columns representing different volume categories and 11 rows of adjustment factors.

Saturation Flow Module table with 12 columns and 5 rows of saturation flow data.

Capacity Analysis Module table with 12 columns and 3 rows of capacity analysis data.

Santa Ana Circulation Element

Level Of Service Computation Report
 2000 HCM Operations Method (Base Volume Alternative)

 Intersection #6 Harbor Blvd and SR-22 WB Off-Ramp / Banner Dr

Cycle (sec): 100 Critical Vol./Cap.(X): 0.802
 Loss Time (sec): 5 Average Delay (sec/veh): 24.2
 Optimal Cycle: 55 Level Of Service: C

Approach:	North Bound			South Bound			East Bound			West Bound		
Movement:	L	T	R	L	T	R	L	T	R	L	T	R
Control:	Protected			Protected			Split Phase			Split Phase		
Rights:	Include			Include			Include			Include		
Min. Green:	0	0	0	0	0	0	0	0	0	0	0	0
Y+R:	4.0	4.0	4.0	4.0	4.0	4.0	4.0	4.0	4.0	4.0	4.0	4.0
Lanes:	1	0	3	0	0	2	1	0	0	1	1	0

Volume Module:	North Bound			South Bound			East Bound			West Bound		
Base Vol:	109	2457	0	0	1801	58	102	0	86	576	78	165
Growth Adj:	1.00	1.00	1.00	1.00	1.00	1.00	1.00	1.00	1.00	1.00	1.00	1.00
Initial Bse:	109	2457	0	0	1801	58	102	0	86	576	78	165
User Adj:	1.00	1.00	1.00	1.00	1.00	1.00	1.00	1.00	1.00	1.00	1.00	1.00
PHF Adj:	1.00	1.00	1.00	1.00	1.00	1.00	1.00	1.00	1.00	1.00	1.00	1.00
PHF Volume:	109	2457	0	0	1801	58	102	0	86	576	78	165
Reduct Vol:	0	0	0	0	0	0	0	0	0	0	0	0
Reduced Vol:	109	2457	0	0	1801	58	102	0	86	576	78	165
PCE Adj:	1.00	1.00	1.00	1.00	1.00	1.00	1.00	1.00	1.00	1.00	1.00	1.00
MLF Adj:	1.00	1.00	1.00	1.00	1.00	1.00	1.00	1.00	1.00	1.00	1.00	1.00
FinalVolume:	109	2457	0	0	1801	58	102	0	86	576	78	165

Saturation Flow Module:	North Bound			South Bound			East Bound			West Bound		
Sat/Lane:	1900	1900	1900	1900	1900	1900	1900	1900	1900	1900	1900	1900
Adjustment:	0.95	0.91	1.00	1.00	0.91	0.91	0.91	1.00	0.91	0.96	0.96	0.85
Lanes:	1.00	3.00	0.00	0.00	2.91	0.09	0.54	0.00	0.46	1.76	0.24	1.00
Final Sat.:	1805	5187	0	0	5000	161	942	0	794	3206	434	1615

Capacity Analysis Module:	North Bound			South Bound			East Bound			West Bound		
Vol/Sat:	0.06	0.47	0.00	0.00	0.36	0.36	0.11	0.00	0.11	0.18	0.18	0.10
Crit Moves:	****			****			****			****		
Green/Cycle:	0.08	0.59	0.00	0.00	0.51	0.51	0.14	0.00	0.14	0.22	0.22	0.22
Volume/Cap:	0.71	0.80	0.00	0.00	0.71	0.71	0.80	0.00	0.80	0.80	0.80	0.46
Delay/Veh:	59.1	17.5	0.0	0.0	20.0	20.0	59.6	0.0	59.6	42.4	42.4	34.4
User DelAdj:	1.00	1.00	1.00	1.00	1.00	1.00	1.00	1.00	1.00	1.00	1.00	1.00
AdjDel/Veh:	59.1	17.5	0.0	0.0	20.0	20.0	59.6	0.0	59.6	42.4	42.4	34.4
LOS by Move:	E	B	A	A	C	C	E	A	E	D	D	C
HCM2k85thQ:	7	33	0	0	25	25	12	0	12	18	18	7

 Note: Queue reported is the number of cars per lane.

Santa Ana Circulation Element

Level Of Service Computation Report
 2000 HCM Operations Method (Base Volume Alternative)

 Intersection #7 Trask Avenue and SR-22 EB On-Ramp

Cycle (sec): 100 Critical Vol./Cap.(X): 0.533
 Loss Time (sec): 5 Average Delay (sec/veh): 13.6
 Optimal Cycle: 26 Level Of Service: B

Approach:	North Bound			South Bound			East Bound			West Bound		
Movement:	L	T	R	L	T	R	L	T	R	L	T	R
Control:	Protected			Protected			Protected			Protected		
Rights:	Include			Include			Include			Include		
Min. Green:	0	0	0	0	0	0	0	0	0	0	0	0
Y+R:	4.0	4.0	4.0	4.0	4.0	4.0	4.0	4.0	4.0	4.0	4.0	4.0
Lanes:	0	0	0	0	0	0	2	0	1	0	0	1

Volume Module:	North Bound			South Bound			East Bound			West Bound		
Base Vol:	0	0	0	0	0	0	927	695	0	0	786	74
Growth Adj:	1.00	1.00	1.00	1.00	1.00	1.00	1.00	1.00	1.00	1.00	1.00	1.00
Initial Bse:	0	0	0	0	0	0	927	695	0	0	786	74
User Adj:	1.00	1.00	1.00	1.00	1.00	1.00	1.00	1.00	1.00	1.00	1.00	1.00
PHF Adj:	1.00	1.00	1.00	1.00	1.00	1.00	1.00	1.00	1.00	1.00	1.00	1.00
PHF Volume:	0	0	0	0	0	0	927	695	0	0	786	74
Reduct Vol:	0	0	0	0	0	0	0	0	0	0	0	0
Reduced Vol:	0	0	0	0	0	0	927	695	0	0	786	74
PCE Adj:	1.00	1.00	1.00	1.00	1.00	1.00	1.00	1.00	1.00	1.00	1.00	1.00
MLF Adj:	1.00	1.00	1.00	1.00	1.00	1.00	1.00	1.00	1.00	1.00	1.00	1.00
FinalVolume:	0	0	0	0	0	0	927	695	0	0	786	74

Saturation Flow Module:	North Bound			South Bound			East Bound			West Bound		
Sat/Lane:	1900	1900	1900	1900	1900	1900	1900	1900	1900	1900	1900	1900
Adjustment:	1.00	1.00	1.00	1.00	1.00	1.00	0.92	1.00	1.00	1.00	0.94	0.94
Lanes:	0.00	0.00	0.00	0.00	0.00	0.00	2.00	1.00	0.00	0.00	1.83	0.17
Final Sat.:	0	0	0	0	0	0	3502	1900	0	0	3256	307

Capacity Analysis Module:	North Bound			South Bound			East Bound			West Bound		
Vol/Sat:	0.00	0.00	0.00	0.00	0.00	0.00	0.26	0.37	0.00	0.00	0.24	0.24
Crit Moves:							****				****	
Green/Cycle:	0.00	0.00	0.00	0.00	0.00	0.00	0.50	0.95	0.00	0.00	0.45	0.45
Volume/Cap:	0.00	0.00	0.00	0.00	0.00	0.00	0.53	0.39	0.00	0.00	0.53	0.53
Delay/Veh:	0.0	0.0	0.0	0.0	0.0	0.0	17.5	0.3	0.0	0.0	20.1	20.1
User DelAdj:	1.00	1.00	1.00	1.00	1.00	1.00	1.00	1.00	1.00	1.00	1.00	1.00
AdjDel/Veh:	0.0	0.0	0.0	0.0	0.0	0.0	17.5	0.3	0.0	0.0	20.1	20.1
LOS by Move:	A	A	A	A	A	A	B	A	A	A	C	C
HCM2k85thQ:	0	0	0	0	0	0	15	3	0	0	15	15

 Note: Queue reported is the number of cars per lane.

Santa Ana Circulation Element

Level Of Service Computation Report

ICU 1(Loss as Cycle Length %) Method (Base Volume Alternative)

Intersection #8 Harbor Blvd and Westminster Ave

Cycle (sec): 100 Critical Vol./Cap.(X): 0.882
 Loss Time (sec): 0 Average Delay (sec/veh): xxxxxx
 Optimal Cycle: 180 Level Of Service: D

Approach:	North Bound			South Bound			East Bound			West Bound		
Movement:	L	T	R	L	T	R	L	T	R	L	T	R
Control:	Protected			Protected			Protected			Protected		
Rights:	WideBypass			Include			Include			Include		
Min. Green:	0	0	0	0	0	0	0	0	0	0	0	0
Y+R:	4.0	4.0	4.0	4.0	4.0	4.0	4.0	4.0	4.0	4.0	4.0	4.0
Lanes:	1	0	3	0	1	1	0	2	1	0	1	0

Volume Module:

Base Vol:	237	1178	279	254	1752	202	215	768	37	357	1238	281
Growth Adj:	1.00	1.00	1.00	1.00	1.00	1.00	1.00	1.00	1.00	1.00	1.00	1.00
Initial Bse:	237	1178	279	254	1752	202	215	768	37	357	1238	281
User Adj:	1.00	1.00	1.00	1.00	1.00	1.00	1.00	1.00	1.00	1.00	1.00	1.00
PHF Adj:	1.00	1.00	1.00	1.00	1.00	1.00	1.00	1.00	1.00	1.00	1.00	1.00
PHF Volume:	237	1178	279	254	1752	202	215	768	37	357	1238	281
Reduct Vol:	0	0	0	0	0	0	0	0	0	0	0	0
Reduced Vol:	237	1178	279	254	1752	202	215	768	37	357	1238	281
PCE Adj:	1.00	1.00	1.00	1.00	1.00	1.00	1.00	1.00	1.00	1.00	1.00	1.00
MLF Adj:	1.00	1.00	1.00	1.00	1.00	1.00	1.00	1.00	1.00	1.00	1.00	1.00
FinalVolume:	237	1178	279	254	1752	202	215	768	37	357	1238	281

Saturation Flow Module:

Sat/Lane:	1600	1600	1600	1600	1600	1600	1600	1600	1600	1600	1600	1600
Adjustment:	1.00	1.06	1.00	1.00	1.06	1.00	1.00	1.04	1.00	1.00	1.06	1.00
Lanes:	1.00	3.00	1.00	1.00	3.00	1.00	1.00	2.86	0.14	1.00	3.00	1.00
Final Sat.:	1600	5100	1600	1600	5100	1600	1600	4779	221	1600	5100	1600

Capacity Analysis Module:

Vol/Sat:	0.15	0.23	0.17	0.16	0.34	0.13	0.13	0.16	0.17	0.22	0.24	0.18
Crit Moves:	****			****					****	****		

Santa Ana Circulation Element

Level Of Service Computation Report

ICU 1(Loss as Cycle Length %) Method (Base Volume Alternative)

Intersection #9 Harbor Blvd and 1st St

Cycle (sec): 100 Critical Vol./Cap.(X): 0.778
Loss Time (sec): 5 Average Delay (sec/veh): xxxxxx
Optimal Cycle: 48 Level Of Service: C

Table with 4 columns: North Bound, South Bound, East Bound, West Bound. Rows include Movement (L-T-R), Control (Protected), Rights (Include), Min. Green, Y+R, and Lanes.

Volume Module: Table with 12 columns representing volume and adjustment factors for each bound and lane.

Saturation Flow Module: Table with 12 columns representing saturation flow and adjustment factors.

Capacity Analysis Module: Table with 12 columns representing volume/saturation and critical moves.

Santa Ana Circulation Element

Level Of Service Computation Report

ICU 1(Loss as Cycle Length %) Method (Base Volume Alternative)

Intersection #10 Harbor Blvd and McFadden Ave

Cycle (sec): 100 Critical Vol./Cap.(X): 0.812
 Loss Time (sec): 5 Average Delay (sec/veh): xxxxxx
 Optimal Cycle: 55 Level Of Service: D

Approach:	North Bound			South Bound			East Bound			West Bound		
Movement:	L	T	R	L	T	R	L	T	R	L	T	R
Control:	Protected			Protected			Protected			Protected		
Rights:	Include			Include			Include			Include		
Min. Green:	0	0	0	0	0	0	0	0	0	0	0	0
Y+R:	4.0	4.0	4.0	4.0	4.0	4.0	4.0	4.0	4.0	4.0	4.0	4.0
Lanes:	2	0	3	0	1	1	0	1	1	0	1	1

Volume Module:

Base Vol:	169	1737	127	256	1094	99	241	585	73	198	474	137
Growth Adj:	1.00	1.00	1.00	1.00	1.00	1.00	1.00	1.00	1.00	1.00	1.00	1.00
Initial Bse:	169	1737	127	256	1094	99	241	585	73	198	474	137
User Adj:	1.00	1.00	1.00	1.00	1.00	1.00	1.00	1.00	1.00	1.00	1.00	1.00
PHF Adj:	1.00	1.00	1.00	1.00	1.00	1.00	1.00	1.00	1.00	1.00	1.00	1.00
PHF Volume:	169	1737	127	256	1094	99	241	585	73	198	474	137
Reduct Vol:	0	0	0	0	0	0	0	0	0	0	0	0
Reduced Vol:	169	1737	127	256	1094	99	241	585	73	198	474	137
PCE Adj:	1.00	1.00	1.00	1.00	1.00	1.00	1.00	1.00	1.00	1.00	1.00	1.00
MLF Adj:	1.00	1.00	1.00	1.00	1.00	1.00	1.00	1.00	1.00	1.00	1.00	1.00
FinalVolume:	169	1737	127	256	1094	99	241	585	73	198	474	137

Saturation Flow Module:

Sat/Lane:	1600	1600	1600	1600	1600	1600	1600	1600	1600	1600	1600	1600
Adjustment:	1.00	1.06	1.00	1.00	1.05	1.00	1.00	1.04	1.00	1.00	1.04	1.00
Lanes:	2.00	3.00	1.00	2.00	2.75	0.25	1.00	1.78	0.22	1.00	1.55	0.45
Final Sat.:	3200	5100	1600	3200	4602	398	1600	2945	355	1600	2582	718

Capacity Analysis Module:

Vol/Sat:	0.05	0.34	0.08	0.08	0.24	0.25	0.15	0.20	0.21	0.12	0.18	0.19
Crit Moves:	****			****			****			****		

Santa Ana Circulation Element

Level Of Service Computation Report

ICU 1(Loss as Cycle Length %) Method (Base Volume Alternative)

Intersection #11 Harbor Blvd and Edinger Ave

Cycle (sec): 100 Critical Vol./Cap.(X): 0.725
Loss Time (sec): 5 Average Delay (sec/veh): xxxxxx
Optimal Cycle: 40 Level Of Service: C

Table with 4 columns: North Bound, South Bound, East Bound, West Bound. Rows include Movement (L-T-R), Control (Protected), Rights (Include), Min. Green, Y+R, and Lanes.

Volume Module table with 12 columns representing different traffic flows and 10 rows of adjustment factors like Growth Adj, User Adj, PHF Adj, etc.

Saturation Flow Module table with 12 columns and 4 rows showing Sat/Lane, Adjustment, Lanes, and Final Sat.

Capacity Analysis Module table with 12 columns and 2 rows showing Vol/Sat and Crit Moves.

Santa Ana Circulation Element

Level Of Service Computation Report

ICU 1(Loss as Cycle Length %) Method (Base Volume Alternative)

Intersection #12 Harbor Blvd and Warner Ave

Cycle (sec): 100 Critical Vol./Cap.(X): 1.536
 Loss Time (sec): 5 Average Delay (sec/veh): xxxxxx
 Optimal Cycle: 180 Level Of Service: F

Approach:	North Bound			South Bound			East Bound			West Bound		
Movement:	L	T	R	L	T	R	L	T	R	L	T	R
Control:	Protected			Protected			Protected			Protected		
Rights:	Include			Include			Include			Include		
Min. Green:	0	0	0	0	0	0	0	0	0	0	0	0
Y+R:	4.0	4.0	4.0	4.0	4.0	4.0	4.0	4.0	4.0	4.0	4.0	4.0
Lanes:	2	0	2	1	0	0	2	0	3	0	1	0

Volume Module:

Base Vol:	762	3656	275	262	1457	174	217	1539	352	249	2589	827
Growth Adj:	1.00	1.00	1.00	1.00	1.00	1.00	1.00	1.00	1.00	1.00	1.00	1.00
Initial Bse:	762	3656	275	262	1457	174	217	1539	352	249	2589	827
User Adj:	1.00	1.00	1.00	1.00	1.00	1.00	1.00	1.00	1.00	1.00	1.00	1.00
PHF Adj:	1.00	1.00	1.00	1.00	1.00	1.00	1.00	1.00	1.00	1.00	1.00	1.00
PHF Volume:	762	3656	275	262	1457	174	217	1539	352	249	2589	827
Reduct Vol:	0	0	0	0	0	0	0	0	0	0	0	0
Reduced Vol:	762	3656	275	262	1457	174	217	1539	352	249	2589	827
PCE Adj:	1.00	1.00	1.00	1.00	1.00	1.00	1.00	1.00	1.00	1.00	1.00	1.00
MLF Adj:	1.00	1.00	1.00	1.00	1.00	1.00	1.00	1.00	1.00	1.00	1.00	1.00
FinalVolume:	762	3656	275	262	1457	174	217	1539	352	249	2589	827

Saturation Flow Module:

Sat/Lane:	1600	1600	1600	1600	1600	1600	1600	1600	1600	1600	1600	1600
Adjustment:	1.00	1.04	1.00	1.00	1.06	1.00	1.00	1.06	1.00	1.00	1.06	1.00
Lanes:	2.00	2.79	0.21	2.00	3.00	1.00	2.00	3.00	1.00	2.00	3.00	1.00
Final Sat.:	3200	4664	336	3200	5100	1600	3200	5100	1600	3200	5100	1600

Capacity Analysis Module:

Vol/Sat:	0.24	0.78	0.82	0.08	0.29	0.11	0.07	0.30	0.22	0.08	0.51	0.52
Crit Moves:			****	****			****			****		

Santa Ana Circulation Element

Level Of Service Computation Report

ICU 1(Loss as Cycle Length %) Method (Base Volume Alternative)

Intersection #13 Harbor Blvd and Segerstrom Ave

Cycle (sec): 100 Critical Vol./Cap.(X): 0.921
Loss Time (sec): 5 Average Delay (sec/veh): xxxxxx
Optimal Cycle: 100 Level Of Service: E

Table with 4 columns: North Bound, South Bound, East Bound, West Bound. Rows include Movement (L-T-R), Control, Rights, Min. Green, Y+R, and Lanes.

Volume Module: Table with 12 columns representing volume and adjustment factors for each bound.

Saturation Flow Module: Table with 12 columns representing saturation flow and adjustment factors.

Capacity Analysis Module: Table with 12 columns representing capacity and critical moves.

Santa Ana Circulation Element

Level Of Service Computation Report

ICU 1(Loss as Cycle Length %) Method (Base Volume Alternative)

Intersection #14 MacArthur Blvd and Hyland Ave

Cycle (sec): 100 Critical Vol./Cap.(X): 0.917
 Loss Time (sec): 5 Average Delay (sec/veh): xxxxxx
 Optimal Cycle: 98 Level Of Service: E

Approach:	North Bound			South Bound			East Bound			West Bound		
Movement:	L	T	R	L	T	R	L	T	R	L	T	R
Control:	Protected			Protected			Prot+Permit			Prot+Permit		
Rights:	Include			Include			Include			Include		
Min. Green:	0	0	0	0	0	0	0	0	0	0	0	0
Y+R:	4.0	4.0	4.0	4.0	4.0	4.0	4.0	4.0	4.0	4.0	4.0	4.0
Lanes:	2	0	0	1	0	1	3	0	1	1	0	3

Volume Module:

Base Vol:	1201	7	70	12	4	14	36	891	160	25	2350	12
Growth Adj:	1.00	1.00	1.00	1.00	1.00	1.00	1.00	1.00	1.00	1.00	1.00	1.00
Initial Bse:	1201	7	70	12	4	14	36	891	160	25	2350	12
User Adj:	1.00	1.00	1.00	1.00	1.00	1.00	1.00	1.00	1.00	1.00	1.00	1.00
PHF Adj:	1.00	1.00	1.00	1.00	1.00	1.00	1.00	1.00	1.00	1.00	1.00	1.00
PHF Volume:	1201	7	70	12	4	14	36	891	160	25	2350	12
Reduct Vol:	0	0	0	0	0	0	0	0	0	0	0	0
Reduced Vol:	1201	7	70	12	4	14	36	891	160	25	2350	12
PCE Adj:	1.00	1.00	1.00	1.00	1.00	1.00	1.00	1.00	1.00	1.00	1.00	1.00
MLF Adj:	1.00	1.00	1.00	1.00	1.00	1.00	1.00	1.00	1.00	1.00	1.00	1.00
FinalVolume:	1201	7	70	12	4	14	36	891	160	25	2350	12

Saturation Flow Module:

Sat/Lane:	1600	1600	1600	1600	1600	1600	1600	1600	1600	1600	1600	1600
Adjustment:	1.00	1.00	1.00	1.00	1.06	1.00	1.00	1.06	1.00	1.00	1.06	1.00
Lanes:	2.00	0.09	0.91	1.00	1.00	1.00	1.00	3.00	1.00	1.00	3.00	1.00
Final Sat.:	3200	145	1455	1600	1700	1600	1600	5100	1600	1600	5100	1600

Capacity Analysis Module:

Vol/Sat:	0.38	0.05	0.05	0.01	0.00	0.01	0.02	0.17	0.10	0.02	0.46	0.01
Crit Moves:	****					****	****				****	

Santa Ana Circulation Element

Level Of Service Computation Report

ICU 1(Loss as Cycle Length %) Method (Base Volume Alternative)

Intersection #15 MacArthur Blvd and Harbor Blvd

Cycle (sec): 100 Critical Vol./Cap.(X): 0.783
Loss Time (sec): 5 Average Delay (sec/veh): xxxxxx
Optimal Cycle: 49 Level Of Service: C

Table with 4 columns: North Bound, South Bound, East Bound, West Bound. Rows include Movement (L-T-R), Control, Rights, Min. Green, Y+R, and Lanes.

Volume Module: Table with 12 columns representing volume and adjustment factors for each bound and lane.

Saturation Flow Module: Table with 12 columns representing saturation flow and adjustment factors.

Capacity Analysis Module: Table with 12 columns representing volume/saturation and critical moves.

Santa Ana Circulation Element

Level Of Service Computation Report

ICU 1(Loss as Cycle Length %) Method (Base Volume Alternative)

Intersection #16 Harbor Blvd and Sunflower Ave

Cycle (sec): 100 Critical Vol./Cap.(X): 0.717
 Loss Time (sec): 5 Average Delay (sec/veh): xxxxxx
 Optimal Cycle: 39 Level Of Service: C

Approach:	North Bound			South Bound			East Bound			West Bound		
Movement:	L	T	R	L	T	R	L	T	R	L	T	R
Control:	Protected			Protected			Protected			Protected		
Rights:	Include			Include			Include			Include		
Min. Green:	0	0	0	0	0	0	0	0	0	0	0	0
Y+R:	4.0	4.0	4.0	4.0	4.0	4.0	4.0	4.0	4.0	4.0	4.0	4.0
Lanes:	2	0	3	0	1		2	0	3	0	1	

Volume Module:

Base Vol:	154	1532	228	114	1417	43	81	220	229	301	632	236
Growth Adj:	1.00	1.00	1.00	1.00	1.00	1.00	1.00	1.00	1.00	1.00	1.00	1.00
Initial Bse:	154	1532	228	114	1417	43	81	220	229	301	632	236
User Adj:	1.00	1.00	1.00	1.00	1.00	1.00	1.00	1.00	1.00	1.00	1.00	1.00
PHF Adj:	1.00	1.00	1.00	1.00	1.00	1.00	1.00	1.00	1.00	1.00	1.00	1.00
PHF Volume:	154	1532	228	114	1417	43	81	220	229	301	632	236
Reduct Vol:	0	0	0	0	0	0	0	0	0	0	0	0
Reduced Vol:	154	1532	228	114	1417	43	81	220	229	301	632	236
PCE Adj:	1.00	1.00	1.00	1.00	1.00	1.00	1.00	1.00	1.00	1.00	1.00	1.00
MLF Adj:	1.00	1.00	1.00	1.00	1.00	1.00	1.00	1.00	1.00	1.00	1.00	1.00
FinalVolume:	154	1532	228	114	1417	43	81	220	229	301	632	236

Saturation Flow Module:

Sat/Lane:	1600	1600	1600	1600	1600	1600	1600	1600	1600	1600	1600	1600
Adjustment:	1.00	1.06	1.00	1.00	1.06	1.00	1.00	1.06	1.00	1.00	1.04	1.00
Lanes:	2.00	3.00	1.00	2.00	3.00	1.00	1.00	1.00	1.00	1.00	1.39	0.61
Final Sat.:	3200	5100	1600	3200	5100	1600	1600	1700	1600	1600	2322	974

Capacity Analysis Module:

Vol/Sat:	0.05	0.30	0.14	0.04	0.28	0.03	0.05	0.13	0.14	0.19	0.27	0.24
Crit Moves:	****			****			****			****		

Santa Ana Circulation Element

Level Of Service Computation Report
 2000 HCM Operations Method (Base Volume Alternative)

 Intersection #17 Harbor Blvd and I-405 NB Off-Ramp

Cycle (sec): 100 Critical Vol./Cap.(X): 0.699
 Loss Time (sec): 5 Average Delay (sec/veh): 18.3
 Optimal Cycle: 39 Level Of Service: B

Approach:	North Bound			South Bound			East Bound			West Bound		
Movement:	L	T	R	L	T	R	L	T	R	L	T	R
Control:	Protected			Protected			Split Phase			Split Phase		
Rights:	Include			Include			Include			Include		
Min. Green:	0	0	0	0	0	0	0	0	0	0	0	0
Y+R:	4.0	4.0	4.0	4.0	4.0	4.0	4.0	4.0	4.0	4.0	4.0	4.0
Lanes:	0	0	4	0	0	4	0	0	0	1	0	1

Volume Module:

Base Vol:	0	1529	0	0	2570	0	0	0	0	496	0	801
Growth Adj:	1.00	1.00	1.00	1.00	1.00	1.00	1.00	1.00	1.00	1.00	1.00	1.00
Initial Bse:	0	1529	0	0	2570	0	0	0	0	496	0	801
User Adj:	1.00	1.00	1.00	1.00	1.00	1.00	1.00	1.00	1.00	1.00	1.00	1.00
PHF Adj:	1.00	1.00	1.00	1.00	1.00	1.00	1.00	1.00	1.00	1.00	1.00	1.00
PHF Volume:	0	1529	0	0	2570	0	0	0	0	496	0	801
Reduct Vol:	0	0	0	0	0	0	0	0	0	0	0	0
Reduced Vol:	0	1529	0	0	2570	0	0	0	0	496	0	801
PCE Adj:	1.00	1.00	1.00	1.00	1.00	1.00	1.00	1.00	1.00	1.00	1.00	1.00
MLF Adj:	1.00	1.00	1.00	1.00	1.00	1.00	1.00	1.00	1.00	1.00	1.00	1.00
FinalVolume:	0	1529	0	0	2570	0	0	0	0	496	0	801

Saturation Flow Module:

Sat/Lane:	1900	1900	1900	1900	1900	1900	1900	1900	1900	1900	1900	1900
Adjustment:	1.00	0.91	1.00	1.00	0.91	1.00	1.00	1.00	1.00	0.89	1.00	0.89
Lanes:	0.00	4.00	0.00	0.00	4.00	0.00	0.00	0.00	0.00	1.38	0.00	1.62
Final Sat.:	0	6916	0	0	6916	0	0	0	0	2337	0	2735

Capacity Analysis Module:

Vol/Sat:	0.00	0.22	0.00	0.00	0.37	0.00	0.00	0.00	0.00	0.21	0.00	0.29
Crit Moves:	****			****								****
Green/Cycle:	0.00	0.53	0.00	0.00	0.53	0.00	0.00	0.00	0.00	0.42	0.00	0.42
Volume/Cap:	0.00	0.42	0.00	0.00	0.70	0.00	0.00	0.00	0.00	0.51	0.00	0.70
Delay/Veh:	0.0	14.2	0.0	0.0	18.1	0.0	0.0	0.0	0.0	21.6	0.0	25.1
User DelAdj:	1.00	1.00	1.00	1.00	1.00	1.00	1.00	1.00	1.00	1.00	1.00	1.00
AdjDel/Veh:	0.0	14.2	0.0	0.0	18.1	0.0	0.0	0.0	0.0	21.6	0.0	25.1
LOS by Move:	A	B	A	A	B	A	A	A	A	C	A	C
HCM2k85thQ:	0	12	0	0	25	0	0	0	0	13	0	20

 Note: Queue reported is the number of cars per lane.

Santa Ana Circulation Element

Level Of Service Computation Report
 2000 HCM Operations Method (Base Volume Alternative)

 Intersection #18 Harbor Blvd and I-405 SB Off-Ramp

Cycle (sec): 100 Critical Vol./Cap.(X): 0.667
 Loss Time (sec): 5 Average Delay (sec/veh): 17.9
 Optimal Cycle: 35 Level Of Service: B

Approach:	North Bound			South Bound			East Bound			West Bound		
Movement:	L	T	R	L	T	R	L	T	R	L	T	R
Control:	Protected			Protected			Split Phase			Split Phase		
Rights:	Ignore			Include			Include			Include		
Min. Green:	0	0	0	0	0	0	0	0	0	0	0	0
Y+R:	4.0	4.0	4.0	4.0	4.0	4.0	4.0	4.0	4.0	4.0	4.0	4.0
Lanes:	0	0	3	0	0	4	1	0	1	0	0	0

Volume Module:

Base Vol:	0	1881	0	0	2281	0	177	0	815	0	0	0
Growth Adj:	1.00	1.00	1.00	1.00	1.00	1.00	1.00	1.00	1.00	1.00	1.00	1.00
Initial Bse:	0	1881	0	0	2281	0	177	0	815	0	0	0
User Adj:	1.00	1.00	0.00	1.00	1.00	1.00	1.00	1.00	1.00	1.00	1.00	1.00
PHF Adj:	1.00	1.00	0.00	1.00	1.00	1.00	1.00	1.00	1.00	1.00	1.00	1.00
PHF Volume:	0	1881	0	0	2281	0	177	0	815	0	0	0
Reduct Vol:	0	0	0	0	0	0	0	0	0	0	0	0
Reduced Vol:	0	1881	0	0	2281	0	177	0	815	0	0	0
PCE Adj:	1.00	1.00	0.00	1.00	1.00	1.00	1.00	1.00	1.00	1.00	1.00	1.00
MLF Adj:	1.00	1.00	0.00	1.00	1.00	1.00	1.00	1.00	1.00	1.00	1.00	1.00
FinalVolume:	0	1881	0	0	2281	0	177	0	815	0	0	0

Saturation Flow Module:

Sat/Lane:	1900	1900	1900	1900	1900	1900	1900	1900	1900	1900	1900	1900
Adjustment:	1.00	0.91	1.00	1.00	0.91	1.00	0.87	1.00	0.87	1.00	1.00	1.00
Lanes:	0.00	3.00	1.00	0.00	4.00	0.00	1.18	0.00	1.82	0.00	0.00	0.00
Final Sat.:	0	5187	1900	0	6916	0	1946	0	3008	0	0	0

Capacity Analysis Module:

Vol/Sat:	0.00	0.36	0.00	0.00	0.33	0.00	0.09	0.00	0.27	0.00	0.00	0.00
Crit Moves:	****			****			****			****		
Green/Cycle:	0.00	0.54	0.00	0.00	0.54	0.00	0.41	0.00	0.41	0.00	0.00	0.00
Volume/Cap:	0.00	0.67	0.00	0.00	0.61	0.00	0.22	0.00	0.67	0.00	0.00	0.00
Delay/Veh:	0.0	17.0	0.0	0.0	15.8	0.0	19.4	0.0	25.3	0.0	0.0	0.0
User DelAdj:	1.00	1.00	1.00	1.00	1.00	1.00	1.00	1.00	1.00	1.00	1.00	1.00
AdjDel/Veh:	0.0	17.0	0.0	0.0	15.8	0.0	19.4	0.0	25.3	0.0	0.0	0.0
LOS by Move:	A	B	A	A	B	A	B	A	C	A	A	A
HCM2k85thQ:	0	23	0	0	20	0	5	0	18	0	0	0

 Note: Queue reported is the number of cars per lane.

Santa Ana Circulation Element

Level Of Service Computation Report

ICU 1(Loss as Cycle Length %) Method (Base Volume Alternative)

Intersection #19 Fairview St and Civic Center Dr

Cycle (sec): 100 Critical Vol./Cap.(X): 0.757
 Loss Time (sec): 5 Average Delay (sec/veh): xxxxxx
 Optimal Cycle: 44 Level Of Service: C

Approach:	North Bound			South Bound			East Bound			West Bound		
Movement:	L	T	R	L	T	R	L	T	R	L	T	R
Control:	Protected			Protected			Split Phase			Split Phase		
Rights:	WideBypass			Include			Include			Include		
Min. Green:	0	0	0	0	0	0	0	0	0	0	0	0
Y+R:	4.0	4.0	4.0	4.0	4.0	4.0	4.0	4.0	4.0	4.0	4.0	4.0
Lanes:	1	0	2	1	0	2	1	0	1	0	1	0

Volume Module:

Base Vol:	6	1690	475	192	1784	0	2	6	4	424	0	157
Growth Adj:	1.00	1.00	1.00	1.00	1.00	1.00	1.00	1.00	1.00	1.00	1.00	1.00
Initial Bse:	6	1690	475	192	1784	0	2	6	4	424	0	157
User Adj:	1.00	1.00	1.00	1.00	1.00	1.00	1.00	1.00	1.00	1.00	1.00	1.00
PHF Adj:	1.00	1.00	1.00	1.00	1.00	1.00	1.00	1.00	1.00	1.00	1.00	1.00
PHF Volume:	6	1690	475	192	1784	0	2	6	4	424	0	157
Reduct Vol:	0	0	0	0	0	0	0	0	0	0	0	0
Reduced Vol:	6	1690	475	192	1784	0	2	6	4	424	0	157
PCE Adj:	1.00	1.00	1.00	1.00	1.00	1.00	1.00	1.00	1.00	1.00	1.00	1.00
MLF Adj:	1.00	1.00	1.00	1.00	1.00	1.00	1.00	1.00	1.00	1.00	1.00	1.00
FinalVolume:	6	1690	475	192	1784	0	2	6	4	424	0	157

Saturation Flow Module:

Sat/Lane:	1600	1600	1600	1600	1600	1600	1600	1600	1600	1600	1600	1600
Adjustment:	1.00	1.05	1.00	1.00	1.04	1.00	1.00	1.00	1.00	1.00	1.06	1.00
Lanes:	1.00	2.34	0.66	1.00	3.00	0.00	0.33	1.00	0.67	2.00	0.00	1.00
Final Sat.:	1600	3947	1053	1600	5000	0	533	1600	1067	3200	0	1600

Capacity Analysis Module:

Vol/Sat:	0.00	0.43	0.45	0.12	0.36	0.00	0.00	0.00	0.00	0.13	0.00	0.10
Crit Moves:			****	****			****			****		

Santa Ana Circulation Element

Level Of Service Computation Report

ICU 1(Loss as Cycle Length %) Method (Base Volume Alternative)

Intersection #20 Fairview St and 1st St

Cycle (sec): 100 Critical Vol./Cap.(X): 0.898
Loss Time (sec): 5 Average Delay (sec/veh): xxxxxx
Optimal Cycle: 85 Level Of Service: D

Table with 4 columns: North Bound, South Bound, East Bound, West Bound. Rows include Movement (L-T-R), Control (Protected), Rights (Include), Min. Green, Y+R, and Lanes.

Volume Module: Table with 12 columns representing different traffic volumes and adjustment factors like Base Vol, Growth Adj, Initial Bse, etc.

Saturation Flow Module: Table with 12 columns showing saturation flow rates and adjustment factors for different lanes.

Capacity Analysis Module: Table with 12 columns showing volume/saturation ratios and critical moves.

Santa Ana Circulation Element

Level Of Service Computation Report

ICU 1(Loss as Cycle Length %) Method (Base Volume Alternative)

Intersection #21 Fairview St and McFadden Ave

Cycle (sec): 100 Critical Vol./Cap.(X): 0.776
 Loss Time (sec): 5 Average Delay (sec/veh): xxxxxx
 Optimal Cycle: 47 Level Of Service: C

Approach:	North Bound			South Bound			East Bound			West Bound		
Movement:	L	T	R	L	T	R	L	T	R	L	T	R
Control:	Protected			Protected			Protected			Protected		
Rights:	Include			Include			Include			Include		
Min. Green:	0	0	0	0	0	0	0	0	0	0	0	0
Y+R:	4.0	4.0	4.0	4.0	4.0	4.0	4.0	4.0	4.0	4.0	4.0	4.0
Lanes:	1	0	3	0	1	1	1	0	1	1	1	0

Volume Module:

Base Vol:	164	1507	131	191	1553	242	158	427	106	158	545	134
Growth Adj:	1.00	1.00	1.00	1.00	1.00	1.00	1.00	1.00	1.00	1.00	1.00	1.00
Initial Bse:	164	1507	131	191	1553	242	158	427	106	158	545	134
User Adj:	1.00	1.00	1.00	1.00	1.00	1.00	1.00	1.00	1.00	1.00	1.00	1.00
PHF Adj:	1.00	1.00	1.00	1.00	1.00	1.00	1.00	1.00	1.00	1.00	1.00	1.00
PHF Volume:	164	1507	131	191	1553	242	158	427	106	158	545	134
Reduct Vol:	0	0	0	0	0	0	0	0	0	0	0	0
Reduced Vol:	164	1507	131	191	1553	242	158	427	106	158	545	134
PCE Adj:	1.00	1.00	1.00	1.00	1.00	1.00	1.00	1.00	1.00	1.00	1.00	1.00
MLF Adj:	1.00	1.00	1.00	1.00	1.00	1.00	1.00	1.00	1.00	1.00	1.00	1.00
FinalVolume:	164	1507	131	191	1553	242	158	427	106	158	545	134

Saturation Flow Module:

Sat/Lane:	1600	1600	1600	1600	1600	1600	1600	1600	1600	1600	1600	1600
Adjustment:	1.00	1.06	1.00	1.00	1.06	1.00	1.00	1.04	1.00	1.00	1.04	1.00
Lanes:	1.00	3.00	1.00	1.00	3.00	1.00	1.00	1.60	0.40	1.00	1.61	0.39
Final Sat.:	1600	5100	1600	1600	5100	1600	1600	2664	636	1600	2668	632

Capacity Analysis Module:

Vol/Sat:	0.10	0.30	0.08	0.12	0.30	0.15	0.10	0.16	0.17	0.10	0.20	0.21
Crit Moves:	****			****			****			****		

Santa Ana Circulation Element

Level Of Service Computation Report

ICU 1(Loss as Cycle Length %) Method (Base Volume Alternative)

Intersection #22 Fairview St and Edinger Ave

Cycle (sec): 100 Critical Vol./Cap.(X): 0.916
 Loss Time (sec): 5 Average Delay (sec/veh): xxxxxx
 Optimal Cycle: 97 Level Of Service: E

Approach:	North Bound			South Bound			East Bound			West Bound		
Movement:	L	T	R	L	T	R	L	T	R	L	T	R
Control:	Protected			Protected			Protected			Protected		
Rights:	Include			Include			Include			Include		
Min. Green:	0	0	0	0	0	0	0	0	0	0	0	0
Y+R:	4.0	4.0	4.0	4.0	4.0	4.0	4.0	4.0	4.0	4.0	4.0	4.0
Lanes:	2	0	2	1	0	0	2	0	2	1	0	0

Volume Module:

Base Vol:	184	1759	108	204	635	156	205	628	168	650	1375	302
Growth Adj:	1.00	1.00	1.00	1.00	1.00	1.00	1.00	1.00	1.00	1.00	1.00	1.00
Initial Bse:	184	1759	108	204	635	156	205	628	168	650	1375	302
User Adj:	1.00	1.00	1.00	1.00	1.00	1.00	1.00	1.00	1.00	1.00	1.00	1.00
PHF Adj:	1.00	1.00	1.00	1.00	1.00	1.00	1.00	1.00	1.00	1.00	1.00	1.00
PHF Volume:	184	1759	108	204	635	156	205	628	168	650	1375	302
Reduct Vol:	0	0	0	0	0	0	0	0	0	0	0	0
Reduced Vol:	184	1759	108	204	635	156	205	628	168	650	1375	302
PCE Adj:	1.00	1.00	1.00	1.00	1.00	1.00	1.00	1.00	1.00	1.00	1.00	1.00
MLF Adj:	1.00	1.00	1.00	1.00	1.00	1.00	1.00	1.00	1.00	1.00	1.00	1.00
FinalVolume:	184	1759	108	204	635	156	205	628	168	650	1375	302

Saturation Flow Module:

Sat/Lane:	1600	1600	1600	1600	1600	1600	1600	1600	1600	1600	1600	1600
Adjustment:	1.00	1.04	1.00	1.00	1.05	1.00	1.00	1.05	1.00	1.00	1.05	1.00
Lanes:	2.00	2.83	0.17	2.00	2.41	0.59	2.00	2.37	0.63	2.00	2.46	0.54
Final Sat.:	3200	4722	278	3200	4053	947	3200	3987	1013	3200	4136	864

Capacity Analysis Module:

Vol/Sat:	0.06	0.37	0.39	0.06	0.16	0.16	0.06	0.16	0.17	0.20	0.33	0.35
Crit Moves:			****	****			****					****

Santa Ana Circulation Element

Level Of Service Computation Report

ICU 1(Loss as Cycle Length %) Method (Base Volume Alternative)

Intersection #23 Fairview St and Warner Ave

Cycle (sec): 100 Critical Vol./Cap.(X): 0.796
Loss Time (sec): 5 Average Delay (sec/veh): xxxxxx
Optimal Cycle: 51 Level Of Service: C

Table with 4 columns: North Bound, South Bound, East Bound, West Bound. Rows include Movement (L-T-R), Control, Rights, Min. Green, Y+R, and Lanes.

Volume Module table with 12 columns representing different traffic movements and 11 rows of adjustment factors like Base Vol, Growth Adj, etc.

Saturation Flow Module table with 12 columns and 4 rows showing Sat/Lane, Adjustment, Lanes, and Final Sat.

Capacity Analysis Module table with 12 columns and 2 rows showing Vol/Sat and Crit Moves.

Santa Ana Circulation Element

Level Of Service Computation Report

ICU 1(Loss as Cycle Length %) Method (Base Volume Alternative)

Intersection #24 Fairview St and MacArthur Blvd

Cycle (sec): 100 Critical Vol./Cap.(X): 0.768
 Loss Time (sec): 5 Average Delay (sec/veh): xxxxxx
 Optimal Cycle: 46 Level Of Service: C

Approach:	North Bound			South Bound			East Bound			West Bound		
Movement:	L	T	R	L	T	R	L	T	R	L	T	R
Control:	Protected			Protected			Protected			Protected		
Rights:	Include			Include			Include			Include		
Min. Green:	0	0	0	0	0	0	0	0	0	0	0	0
Y+R:	4.0	4.0	4.0	4.0	4.0	4.0	4.0	4.0	4.0	4.0	4.0	4.0
Lanes:	2	0	2	1	0	0	2	0	3	0	1	0

Volume Module:

Base Vol:	225	1550	84	171	955	88	240	627	211	167	1272	223
Growth Adj:	1.00	1.00	1.00	1.00	1.00	1.00	1.00	1.00	1.00	1.00	1.00	1.00
Initial Bse:	225	1550	84	171	955	88	240	627	211	167	1272	223
User Adj:	1.00	1.00	1.00	1.00	1.00	1.00	1.00	1.00	1.00	1.00	1.00	1.00
PHF Adj:	1.00	1.00	1.00	1.00	1.00	1.00	1.00	1.00	1.00	1.00	1.00	1.00
PHF Volume:	225	1550	84	171	955	88	240	627	211	167	1272	223
Reduct Vol:	0	0	0	0	0	0	0	0	0	0	0	0
Reduced Vol:	225	1550	84	171	955	88	240	627	211	167	1272	223
PCE Adj:	1.00	1.00	1.00	1.00	1.00	1.00	1.00	1.00	1.00	1.00	1.00	1.00
MLF Adj:	1.00	1.00	1.00	1.00	1.00	1.00	1.00	1.00	1.00	1.00	1.00	1.00
FinalVolume:	225	1550	84	171	955	88	240	627	211	167	1272	223

Saturation Flow Module:

Sat/Lane:	1600	1600	1600	1600	1600	1600	1600	1600	1600	1600	1600	1600
Adjustment:	1.00	1.04	1.00	1.00	1.06	1.00	1.00	1.06	1.00	1.00	1.06	1.00
Lanes:	2.00	2.85	0.15	2.00	3.00	1.00	2.00	3.00	1.00	2.00	3.00	1.00
Final Sat.:	3200	4753	247	3200	5100	1600	3200	5100	1600	3200	5100	1600

Capacity Analysis Module:

Vol/Sat:	0.07	0.33	0.34	0.05	0.19	0.06	0.08	0.12	0.13	0.05	0.25	0.14
Crit Moves:			****	****			****			****		

Santa Ana Circulation Element

Level Of Service Computation Report

ICU 1(Loss as Cycle Length %) Method (Base Volume Alternative)

Intersection #25 Fairview Rd and Sunflower Ave

Cycle (sec): 100 Critical Vol./Cap.(X): 0.715
Loss Time (sec): 5 Average Delay (sec/veh): xxxxxx
Optimal Cycle: 39 Level Of Service: C

Table with 4 columns: North Bound, South Bound, East Bound, West Bound. Rows include Movement (L-T-R), Control (Protected), Rights (Include), Min. Green, Y+R, and Lanes.

Volume Module: Table with 12 columns representing different traffic volumes and adjustment factors like Growth Adj, Initial Bse, User Adj, PHF Adj, PHF Volume, Reduct Vol, Reduced Vol, PCE Adj, MLF Adj, and Final Volume.

Saturation Flow Module: Table with 12 columns showing saturation flow rates and adjustment factors like Sat/Lane, Adjustment, Lanes, and Final Sat.

Capacity Analysis Module: Table with 12 columns showing capacity analysis metrics like Vol/Sat and Crit Moves.

Santa Ana Circulation Element

Level Of Service Computation Report

ICU 1(Loss as Cycle Length %) Method (Base Volume Alternative)

Intersection #26 Greenville St and Edinger Ave

Cycle (sec): 100 Critical Vol./Cap.(X): 0.595
 Loss Time (sec): 5 Average Delay (sec/veh): xxxxxx
 Optimal Cycle: 29 Level Of Service: A

Approach:	North Bound			South Bound			East Bound			West Bound		
Movement:	L	T	R	L	T	R	L	T	R	L	T	R
Control:	Split Phase			Split Phase			Protected			Protected		
Rights:	Include			Include			Include			Include		
Min. Green:	0	0	0	0	0	0	0	0	0	0	0	0
Y+R:	4.0	4.0	4.0	4.0	4.0	4.0	4.0	4.0	4.0	4.0	4.0	4.0
Lanes:	1	0	0	0	0	0	0	0	2	1	0	3

Volume Module:

Base Vol:	293	0	195	0	0	0	0	1061	216	153	1811	0
Growth Adj:	1.00	1.00	1.00	1.00	1.00	1.00	1.00	1.00	1.00	1.00	1.00	1.00
Initial Bse:	293	0	195	0	0	0	0	1061	216	153	1811	0
User Adj:	1.00	1.00	1.00	1.00	1.00	1.00	1.00	1.00	1.00	1.00	1.00	1.00
PHF Adj:	1.00	1.00	1.00	1.00	1.00	1.00	1.00	1.00	1.00	1.00	1.00	1.00
PHF Volume:	293	0	195	0	0	0	0	1061	216	153	1811	0
Reduct Vol:	0	0	0	0	0	0	0	0	0	0	0	0
Reduced Vol:	293	0	195	0	0	0	0	1061	216	153	1811	0
PCE Adj:	1.00	1.00	1.00	1.00	1.00	1.00	1.00	1.00	1.00	1.00	1.00	1.00
MLF Adj:	1.00	1.00	1.00	1.00	1.00	1.00	1.00	1.00	1.00	1.00	1.00	1.00
FinalVolume:	293	0	195	0	0	0	0	1061	216	153	1811	0

Saturation Flow Module:

Sat/Lane:	1600	1600	1600	1600	1600	1600	1600	1600	1600	1600	1600	1600
Adjustment:	1.00	1.06	1.00	1.00	1.06	1.00	1.00	1.05	1.00	1.00	1.06	1.00
Lanes:	1.00	0.00	1.00	0.00	0.00	0.00	0.00	2.49	0.51	1.00	3.00	0.00
Final Sat.:	1600	0	1600	0	0	0	0	4188	812	1600	5100	0

Capacity Analysis Module:

Vol/Sat:	0.18	0.00	0.12	0.00	0.00	0.00	0.00	0.25	0.27	0.10	0.36	0.00
Crit Moves:	****								****	****		

Santa Ana Circulation Element

Level Of Service Computation Report

ICU 1(Loss as Cycle Length %) Method (Base Volume Alternative)

Intersection #27 Greenville St and Segerstrom Ave

Cycle (sec): 100 Critical Vol./Cap.(X): 0.777
Loss Time (sec): 5 Average Delay (sec/veh): xxxxxx
Optimal Cycle: 48 Level Of Service: C

Table with 4 columns: North Bound, South Bound, East Bound, West Bound. Rows include Movement (L-T-R), Control (Permitted), Rights (Include), Min. Green, Y+R, and Lanes.

Volume Module: Table with 12 columns representing different volume categories and their values.

Saturation Flow Module: Table with 12 columns representing saturation flow values and adjustment factors.

Capacity Analysis Module: Table with 12 columns representing capacity analysis metrics.

Santa Ana Circulation Element

Level Of Service Computation Report

ICU 1(Loss as Cycle Length %) Method (Base Volume Alternative)

Intersection #28 Raitt St and McFadden Ave

Cycle (sec): 100 Critical Vol./Cap.(X): 0.758
 Loss Time (sec): 5 Average Delay (sec/veh): xxxxxx
 Optimal Cycle: 45 Level Of Service: C

Approach:	North Bound			South Bound			East Bound			West Bound		
Movement:	L	T	R	L	T	R	L	T	R	L	T	R
Control:	Protected			Protected			Protected			Protected		
Rights:	Include			Include			Include			Include		
Min. Green:	0	0	0	0	0	0	0	0	0	0	0	0
Y+R:	4.0	4.0	4.0	4.0	4.0	4.0	4.0	4.0	4.0	4.0	4.0	4.0
Lanes:	1	0	1	1	0	1	1	0	1	1	0	1

Volume Module:

Base Vol:	61	872	136	51	533	86	108	640	56	98	827	114
Growth Adj:	1.00	1.00	1.00	1.00	1.00	1.00	1.00	1.00	1.00	1.00	1.00	1.00
Initial Bse:	61	872	136	51	533	86	108	640	56	98	827	114
User Adj:	1.00	1.00	1.00	1.00	1.00	1.00	1.00	1.00	1.00	1.00	1.00	1.00
PHF Adj:	1.00	1.00	1.00	1.00	1.00	1.00	1.00	1.00	1.00	1.00	1.00	1.00
PHF Volume:	61	872	136	51	533	86	108	640	56	98	827	114
Reduct Vol:	0	0	0	0	0	0	0	0	0	0	0	0
Reduced Vol:	61	872	136	51	533	86	108	640	56	98	827	114
PCE Adj:	1.00	1.00	1.00	1.00	1.00	1.00	1.00	1.00	1.00	1.00	1.00	1.00
MLF Adj:	1.00	1.00	1.00	1.00	1.00	1.00	1.00	1.00	1.00	1.00	1.00	1.00
FinalVolume:	61	872	136	51	533	86	108	640	56	98	827	114

Saturation Flow Module:

Sat/Lane:	1600	1600	1600	1600	1600	1600	1600	1600	1600	1600	1600	1600
Adjustment:	1.00	1.04	1.00	1.00	1.04	1.00	1.00	1.03	1.00	1.00	1.04	1.00
Lanes:	1.00	1.73	0.27	1.00	1.72	0.28	1.00	1.84	0.16	1.00	1.76	0.24
Final Sat.:	1600	2868	432	1600	2855	445	1600	3043	257	1600	2912	388

Capacity Analysis Module:

Vol/Sat:	0.04	0.30	0.32	0.03	0.19	0.19	0.07	0.21	0.22	0.06	0.28	0.29
Crit Moves:			****	****			****			****		

Santa Ana Circulation Element

Level Of Service Computation Report

ICU 1(Loss as Cycle Length %) Method (Base Volume Alternative)

Intersection #29 Raitt St and Edinger Ave

Cycle (sec): 100 Critical Vol./Cap.(X): 0.986
 Loss Time (sec): 5 Average Delay (sec/veh): xxxxxx
 Optimal Cycle: 180 Level Of Service: E

Approach:	North Bound			South Bound			East Bound			West Bound		
Movement:	L	T	R	L	T	R	L	T	R	L	T	R
Control:	Protected			Protected			Protected			Protected		
Rights:	Include			Include			Include			Include		
Min. Green:	0	0	0	0	0	0	0	0	0	0	0	0
Y+R:	4.0	4.0	4.0	4.0	4.0	4.0	4.0	4.0	4.0	4.0	4.0	4.0
Lanes:	1	0	1	1	0	1	2	1	0	1	0	2

Volume Module:

Base Vol:	171	736	206	114	396	99	125	862	123	192	2171	194
Growth Adj:	1.00	1.00	1.00	1.00	1.00	1.00	1.00	1.00	1.00	1.00	1.00	1.00
Initial Bse:	171	736	206	114	396	99	125	862	123	192	2171	194
User Adj:	1.00	1.00	1.00	1.00	1.00	1.00	1.00	1.00	1.00	1.00	1.00	1.00
PHF Adj:	1.00	1.00	1.00	1.00	1.00	1.00	1.00	1.00	1.00	1.00	1.00	1.00
PHF Volume:	171	736	206	114	396	99	125	862	123	192	2171	194
Reduct Vol:	0	0	0	0	0	0	0	0	0	0	0	0
Reduced Vol:	171	736	206	114	396	99	125	862	123	192	2171	194
PCE Adj:	1.00	1.00	1.00	1.00	1.00	1.00	1.00	1.00	1.00	1.00	1.00	1.00
MLF Adj:	1.00	1.00	1.00	1.00	1.00	1.00	1.00	1.00	1.00	1.00	1.00	1.00
FinalVolume:	171	736	206	114	396	99	125	862	123	192	2171	194

Saturation Flow Module:

Sat/Lane:	1600	1600	1600	1600	1600	1600	1600	1600	1600	1600	1600	1600
Adjustment:	1.00	1.04	1.00	1.00	1.04	1.00	1.00	1.05	1.00	1.00	1.05	1.00
Lanes:	1.00	1.56	0.44	1.00	1.60	0.40	1.00	2.63	0.37	1.00	2.75	0.25
Final Sat.:	1600	2600	700	1600	2660	640	1600	4401	599	1600	4606	394

Capacity Analysis Module:

Vol/Sat:	0.11	0.28	0.29	0.07	0.15	0.15	0.08	0.20	0.21	0.12	0.47	0.49
Crit Moves:			****	****			****					****

Santa Ana Circulation Element

Level Of Service Computation Report

ICU 1(Loss as Cycle Length %) Method (Base Volume Alternative)

Intersection #30 Bear St and MacArthur Blvd

Cycle (sec): 100 Critical Vol./Cap.(X): 0.851
 Loss Time (sec): 5 Average Delay (sec/veh): xxxxxx
 Optimal Cycle: 65 Level Of Service: D

Approach:	North Bound			South Bound			East Bound			West Bound		
Movement:	L	T	R	L	T	R	L	T	R	L	T	R
Control:	Protected			Protected			Protected			Protected		
Rights:	Include			Include			Include			Include		
Min. Green:	0	0	0	0	0	0	0	0	0	0	0	0
Y+R:	4.0	4.0	4.0	4.0	4.0	4.0	4.0	4.0	4.0	4.0	4.0	4.0
Lanes:	1	0	2	0	1	0	1	0	2	1	0	2

Volume Module:

Base Vol:	273	1314	343	115	278	84	80	753	78	67	1211	193
Growth Adj:	1.00	1.00	1.00	1.00	1.00	1.00	1.00	1.00	1.00	1.00	1.00	1.00
Initial Bse:	273	1314	343	115	278	84	80	753	78	67	1211	193
User Adj:	1.00	1.00	1.00	1.00	1.00	1.00	1.00	1.00	1.00	1.00	1.00	1.00
PHF Adj:	1.00	1.00	1.00	1.00	1.00	1.00	1.00	1.00	1.00	1.00	1.00	1.00
PHF Volume:	273	1314	343	115	278	84	80	753	78	67	1211	193
Reduct Vol:	0	0	0	0	0	0	0	0	0	0	0	0
Reduced Vol:	273	1314	343	115	278	84	80	753	78	67	1211	193
PCE Adj:	1.00	1.00	1.00	1.00	1.00	1.00	1.00	1.00	1.00	1.00	1.00	1.00
MLF Adj:	1.00	1.00	1.00	1.00	1.00	1.00	1.00	1.00	1.00	1.00	1.00	1.00
FinalVolume:	273	1314	343	115	278	84	80	753	78	67	1211	193

Saturation Flow Module:

Sat/Lane:	1600	1600	1600	1600	1600	1600	1600	1600	1600	1600	1600	1600
Adjustment:	1.00	1.06	1.00	1.00	1.06	1.00	1.00	1.05	1.00	1.00	1.05	1.00
Lanes:	1.00	2.00	1.00	1.00	2.00	1.00	1.00	2.72	0.28	1.00	2.59	0.41
Final Sat.:	1600	3400	1600	1600	3400	1600	1600	4549	451	1600	4340	660

Capacity Analysis Module:

Vol/Sat:	0.17	0.39	0.21	0.07	0.08	0.05	0.05	0.17	0.17	0.04	0.28	0.29
Crit Moves:	****			****			****			****		

Santa Ana Circulation Element

Level Of Service Computation Report

ICU 1(Loss as Cycle Length %) Method (Base Volume Alternative)

Intersection #31 Bristol St and 17th St

Cycle (sec): 100 Critical Vol./Cap.(X): 0.823
 Loss Time (sec): 5 Average Delay (sec/veh): xxxxxx
 Optimal Cycle: 57 Level Of Service: D

Approach:	North Bound			South Bound			East Bound			West Bound		
Movement:	L	T	R	L	T	R	L	T	R	L	T	R
Control:	Protected			Protected			Protected			Protected		
Rights:	Include			Include			Include			Ovl		
Min. Green:	0	0	0	0	0	0	0	0	0	0	0	0
Y+R:	4.0	4.0	4.0	4.0	4.0	4.0	4.0	4.0	4.0	4.0	4.0	4.0
Lanes:	2	0	3	0	1		2	0	3	0	1	

Volume Module:

Base Vol:	375	1823	303	337	1794	305	238	530	96	311	1170	396
Growth Adj:	1.00	1.00	1.00	1.00	1.00	1.00	1.00	1.00	1.00	1.00	1.00	1.00
Initial Bse:	375	1823	303	337	1794	305	238	530	96	311	1170	396
User Adj:	1.00	1.00	1.00	1.00	1.00	1.00	1.00	1.00	1.00	1.00	1.00	1.00
PHF Adj:	1.00	1.00	1.00	1.00	1.00	1.00	1.00	1.00	1.00	1.00	1.00	1.00
PHF Volume:	375	1823	303	337	1794	305	238	530	96	311	1170	396
Reduct Vol:	0	0	0	0	0	0	0	0	0	0	0	0
Reduced Vol:	375	1823	303	337	1794	305	238	530	96	311	1170	396
PCE Adj:	1.00	1.00	1.00	1.00	1.00	1.00	1.00	1.00	1.00	1.00	1.00	1.00
MLF Adj:	1.00	1.00	1.00	1.00	1.00	1.00	1.00	1.00	1.00	1.00	1.00	1.00
FinalVolume:	375	1823	303	337	1794	305	238	530	96	311	1170	396
OvlAdjVol:												228

Saturation Flow Module:

Sat/Lane:	1600	1600	1600	1600	1600	1600	1600	1600	1600	1600	1600	1600
Adjustment:	1.00	1.06	1.00	1.00	1.06	1.00	1.00	1.05	1.00	1.00	1.06	1.00
Lanes:	2.00	3.00	1.00	2.00	3.00	1.00	2.00	2.54	0.46	2.00	3.00	1.00
Final Sat.:	3200	5100	1600	3200	5100	1600	3200	4264	736	3200	5100	1600

Capacity Analysis Module:

Vol/Sat:	0.12	0.36	0.19	0.11	0.35	0.19	0.07	0.12	0.13	0.10	0.23	0.25
OvlAdjV/S:												0.14
Crit Moves:	****			****			****			****		

Santa Ana Circulation Element

Level Of Service Computation Report

ICU 1(Loss as Cycle Length %) Method (Base Volume Alternative)

Intersection #32 Bristol St and Civic Center Dr

Cycle (sec): 100 Critical Vol./Cap.(X): 0.911
 Loss Time (sec): 5 Average Delay (sec/veh): xxxxxx
 Optimal Cycle: 93 Level Of Service: E

Approach:	North Bound			South Bound			East Bound			West Bound		
Movement:	L	T	R	L	T	R	L	T	R	L	T	R
Control:	Protected			Protected			Prot+Permit			Prot+Permit		
Rights:	Include			Include			Include			Include		
Min. Green:	0	0	0	0	0	0	0	0	0	0	0	0
Y+R:	4.0	4.0	4.0	4.0	4.0	4.0	4.0	4.0	4.0	4.0	4.0	4.0
Lanes:	1	0	2	1	0	2	1	0	1	1	0	1

Volume Module:

Base Vol:	222	1550	81	159	1458	149	195	549	65	184	789	89
Growth Adj:	1.00	1.00	1.00	1.00	1.00	1.00	1.00	1.00	1.00	1.00	1.00	1.00
Initial Bse:	222	1550	81	159	1458	149	195	549	65	184	789	89
User Adj:	1.00	1.00	1.00	1.00	1.00	1.00	1.00	1.00	1.00	1.00	1.00	1.00
PHF Adj:	1.00	1.00	1.00	1.00	1.00	1.00	1.00	1.00	1.00	1.00	1.00	1.00
PHF Volume:	222	1550	81	159	1458	149	195	549	65	184	789	89
Reduct Vol:	0	0	0	0	0	0	0	0	0	0	0	0
Reduced Vol:	222	1550	81	159	1458	149	195	549	65	184	789	89
PCE Adj:	1.00	1.00	1.00	1.00	1.00	1.00	1.00	1.00	1.00	1.00	1.00	1.00
MLF Adj:	1.00	1.00	1.00	1.00	1.00	1.00	1.00	1.00	1.00	1.00	1.00	1.00
Final Volume:	222	1550	81	159	1458	149	195	549	65	184	789	89

Saturation Flow Module:

Sat/Lane:	1600	1600	1600	1600	1600	1600	1600	1600	1600	1600	1600	1600
Adjustment:	1.00	1.04	1.00	1.00	1.05	1.00	1.00	1.03	1.00	1.00	1.03	1.00
Lanes:	1.00	2.85	0.15	1.00	2.72	0.28	1.00	1.79	0.21	1.00	1.80	0.20
Final Sat.:	1600	4762	238	1600	4555	445	1600	2961	339	1600	2976	324

Capacity Analysis Module:

Vol/Sat:	0.14	0.33	0.34	0.10	0.32	0.33	0.12	0.19	0.19	0.12	0.27	0.27
Crit Moves:	****					****	****				****	

Santa Ana Circulation Element

Level Of Service Computation Report

ICU 1(Loss as Cycle Length %) Method (Base Volume Alternative)

Intersection #33 Bristol St and Santa Ana Blvd

Cycle (sec): 100 Critical Vol./Cap.(X): 0.853
Loss Time (sec): 5 Average Delay (sec/veh): xxxxxx
Optimal Cycle: 66 Level Of Service: D

Table with 4 columns: North Bound, South Bound, East Bound, West Bound. Rows include Movement (L-T-R), Control, Rights, Min. Green, Y+R, and Lanes.

Volume Module: Table with 12 columns representing different volume categories and their values.

Saturation Flow Module: Table with 12 columns representing saturation flow values for various lanes.

Capacity Analysis Module: Table with 12 columns representing capacity analysis values.

Santa Ana Circulation Element

Level Of Service Computation Report

ICU 1(Loss as Cycle Length %) Method (Base Volume Alternative)

Intersection #34 Bristol St and 1st St

Cycle (sec): 100 Critical Vol./Cap.(X): 0.826
 Loss Time (sec): 5 Average Delay (sec/veh): xxxxxx
 Optimal Cycle: 58 Level Of Service: D

Approach:	North Bound			South Bound			East Bound			West Bound		
Movement:	L	T	R	L	T	R	L	T	R	L	T	R
Control:	Protected			Protected			Protected			Protected		
Rights:	Include			Include			Include			Include		
Min. Green:	0	0	0	0	0	0	0	0	0	0	0	0
Y+R:	4.0	4.0	4.0	4.0	4.0	4.0	4.0	4.0	4.0	4.0	4.0	4.0
Lanes:	2	0	3	0	1		2	0	3	0	1	
	1						1	0	2	1	0	

Volume Module:

Base Vol:	392	1693	250	223	1209	273	160	900	115	196	1204	114
Growth Adj:	1.00	1.00	1.00	1.00	1.00	1.00	1.00	1.00	1.00	1.00	1.00	1.00
Initial Bse:	392	1693	250	223	1209	273	160	900	115	196	1204	114
User Adj:	1.00	1.00	1.00	1.00	1.00	1.00	1.00	1.00	1.00	1.00	1.00	1.00
PHF Adj:	1.00	1.00	1.00	1.00	1.00	1.00	1.00	1.00	1.00	1.00	1.00	1.00
PHF Volume:	392	1693	250	223	1209	273	160	900	115	196	1204	114
Reduct Vol:	0	0	0	0	0	0	0	0	0	0	0	0
Reduced Vol:	392	1693	250	223	1209	273	160	900	115	196	1204	114
PCE Adj:	1.00	1.00	1.00	1.00	1.00	1.00	1.00	1.00	1.00	1.00	1.00	1.00
MLF Adj:	1.00	1.00	1.00	1.00	1.00	1.00	1.00	1.00	1.00	1.00	1.00	1.00
FinalVolume:	392	1693	250	223	1209	273	160	900	115	196	1204	114

Saturation Flow Module:

Sat/Lane:	1600	1600	1600	1600	1600	1600	1600	1600	1600	1600	1600	1600
Adjustment:	1.00	1.06	1.00	1.00	1.06	1.00	1.00	1.05	1.00	1.00	1.05	1.00
Lanes:	2.00	3.00	1.00	2.00	3.00	1.00	1.00	2.66	0.34	1.00	2.74	0.26
Final Sat.:	3200	5100	1600	3200	5100	1600	1600	4456	544	1600	4585	415

Capacity Analysis Module:

Vol/Sat:	0.12	0.33	0.16	0.07	0.24	0.17	0.10	0.20	0.21	0.12	0.26	0.27
Crit Moves:	****			****			****			****		

Santa Ana Circulation Element

Level Of Service Computation Report

ICU 1(Loss as Cycle Length %) Method (Base Volume Alternative)

Intersection #35 Bristol St and McFadden Ave

Cycle (sec): 100 Critical Vol./Cap.(X): 1.028
 Loss Time (sec): 5 Average Delay (sec/veh): xxxxxx
 Optimal Cycle: 180 Level Of Service: F

Approach:	North Bound			South Bound			East Bound			West Bound		
Movement:	L	T	R	L	T	R	L	T	R	L	T	R
Control:	Protected			Protected			Prot+Permit			Prot+Permit		
Rights:	Include			Include			Include			Include		
Min. Green:	0	0	0	0	0	0	0	0	0	0	0	0
Y+R:	4.0	4.0	4.0	4.0	4.0	4.0	4.0	4.0	4.0	4.0	4.0	4.0
Lanes:	1	0	3	0	1	1	0	1	1	0	1	1

Volume Module:

Base Vol:	224	1649	90	111	1554	358	245	478	95	209	1088	127
Growth Adj:	1.00	1.00	1.00	1.00	1.00	1.00	1.00	1.00	1.00	1.00	1.00	1.00
Initial Bse:	224	1649	90	111	1554	358	245	478	95	209	1088	127
User Adj:	1.00	1.00	1.00	1.00	1.00	1.00	1.00	1.00	1.00	1.00	1.00	1.00
PHF Adj:	1.00	1.00	1.00	1.00	1.00	1.00	1.00	1.00	1.00	1.00	1.00	1.00
PHF Volume:	224	1649	90	111	1554	358	245	478	95	209	1088	127
Reduct Vol:	0	0	0	0	0	0	0	0	0	0	0	0
Reduced Vol:	224	1649	90	111	1554	358	245	478	95	209	1088	127
PCE Adj:	1.00	1.00	1.00	1.00	1.00	1.00	1.00	1.00	1.00	1.00	1.00	1.00
MLF Adj:	1.00	1.00	1.00	1.00	1.00	1.00	1.00	1.00	1.00	1.00	1.00	1.00
FinalVolume:	224	1649	90	111	1554	358	245	478	95	209	1088	127

Saturation Flow Module:

Sat/Lane:	1600	1600	1600	1600	1600	1600	1600	1600	1600	1600	1600	1600
Adjustment:	1.00	1.06	1.00	1.00	1.06	1.00	1.00	1.04	1.00	1.00	1.03	1.00
Lanes:	1.00	3.00	1.00	1.00	3.00	1.00	1.00	1.67	0.33	1.00	1.79	0.21
Final Sat.:	1600	5100	1600	1600	5100	1600	1600	2769	531	1600	2966	334

Capacity Analysis Module:

Vol/Sat:	0.14	0.32	0.06	0.07	0.30	0.22	0.15	0.17	0.18	0.13	0.37	0.38
Crit Moves:	****				****		****				****	

Santa Ana Circulation Element

Level Of Service Computation Report

ICU 1(Loss as Cycle Length %) Method (Base Volume Alternative)

Intersection #36 Bristol St and Warner Ave

Cycle (sec): 100 Critical Vol./Cap.(X): 0.847
 Loss Time (sec): 5 Average Delay (sec/veh): xxxxxx
 Optimal Cycle: 64 Level Of Service: D

Approach:	North Bound			South Bound			East Bound			West Bound		
Movement:	L	T	R	L	T	R	L	T	R	L	T	R
Control:	Protected			Protected			Protected			Protected		
Rights:	Include			Include			Include			Include		
Min. Green:	0	0	0	0	0	0	0	0	0	0	0	0
Y+R:	4.0	4.0	4.0	4.0	4.0	4.0	4.0	4.0	4.0	4.0	4.0	4.0
Lanes:	2	0	2	1	0	0	2	0	2	1	0	3

Volume Module:

Base Vol:	316	1182	216	338	1128	219	176	791	140	251	1481	434
Growth Adj:	1.00	1.00	1.00	1.00	1.00	1.00	1.00	1.00	1.00	1.00	1.00	1.00
Initial Bse:	316	1182	216	338	1128	219	176	791	140	251	1481	434
User Adj:	1.00	1.00	1.00	1.00	1.00	1.00	1.00	1.00	1.00	1.00	1.00	1.00
PHF Adj:	1.00	1.00	1.00	1.00	1.00	1.00	1.00	1.00	1.00	1.00	1.00	1.00
PHF Volume:	316	1182	216	338	1128	219	176	791	140	251	1481	434
Reduct Vol:	0	0	0	0	0	0	0	0	0	0	0	0
Reduced Vol:	316	1182	216	338	1128	219	176	791	140	251	1481	434
PCE Adj:	1.00	1.00	1.00	1.00	1.00	1.00	1.00	1.00	1.00	1.00	1.00	1.00
MLF Adj:	1.00	1.00	1.00	1.00	1.00	1.00	1.00	1.00	1.00	1.00	1.00	1.00
FinalVolume:	316	1182	216	338	1128	219	176	791	140	251	1481	434

Saturation Flow Module:

Sat/Lane:	1600	1600	1600	1600	1600	1600	1600	1600	1600	1600	1600	1600
Adjustment:	1.00	1.05	1.00	1.00	1.05	1.00	1.00	1.06	1.00	1.00	1.06	1.00
Lanes:	2.00	2.54	0.46	2.00	2.51	0.49	1.00	3.00	1.00	1.00	3.00	1.00
Final Sat.:	3200	4258	742	3200	4220	780	1600	5100	1600	1600	5100	1600

Capacity Analysis Module:

Vol/Sat:	0.10	0.28	0.29	0.11	0.27	0.28	0.11	0.16	0.09	0.16	0.29	0.27
Crit Moves:			****	****			****			****		

Santa Ana Circulation Element

Level Of Service Computation Report

ICU 1(Loss as Cycle Length %) Method (Base Volume Alternative)

Intersection #37 Bristol St and Segerstrom Ave

Cycle (sec): 100 Critical Vol./Cap.(X): 0.870
Loss Time (sec): 5 Average Delay (sec/veh): xxxxxx
Optimal Cycle: 72 Level Of Service: D

Table with 4 columns: North Bound, South Bound, East Bound, West Bound. Rows include Movement (L-T-R), Control, Rights, Min. Green, Y+R, and Lanes.

Volume Module: Table with 12 columns representing different volume categories and 12 rows of adjustment factors like Growth Adj, PHF Adj, etc.

Saturation Flow Module: Table with 12 columns and 4 rows showing saturation flow values and adjustment factors.

Capacity Analysis Module: Table with 12 columns and 3 rows showing Vol/Sat and Crit Moves values.

Santa Ana Circulation Element

Level Of Service Computation Report

ICU 1(Loss as Cycle Length %) Method (Base Volume Alternative)

Intersection #38 Bristol St and Alton Ave

Cycle (sec): 100 Critical Vol./Cap.(X): 0.633
Loss Time (sec): 5 Average Delay (sec/veh): xxxxxx
Optimal Cycle: 31 Level Of Service: B

Table with 4 columns: North Bound, South Bound, East Bound, West Bound. Rows include Movement (L-T-R), Control, Rights, Min. Green, Y+R, and Lanes.

Volume Module: Table with 12 columns representing traffic volumes and adjustment factors for each bound.

Saturation Flow Module: Table with 12 columns representing saturation flow rates and adjustment factors.

Capacity Analysis Module: Table with 12 columns representing volume-to-saturation ratios and critical moves.

Santa Ana Circulation Element

Level Of Service Computation Report

ICU 1(Loss as Cycle Length %) Method (Base Volume Alternative)

Intersection #39 Bristol St and MacArthur Blvd

Cycle (sec): 100 Critical Vol./Cap.(X): 0.765
Loss Time (sec): 5 Average Delay (sec/veh): xxxxxx
Optimal Cycle: 46 Level Of Service: C

Table with 4 columns: North Bound, South Bound, East Bound, West Bound. Rows include Movement, Control, Rights, Min. Green, Y+R, and Lanes.

Volume Module: Table with 12 columns representing different volume categories and their values.

Saturation Flow Module: Table with 12 columns representing saturation flow values for various lanes.

Capacity Analysis Module: Table with 12 columns representing capacity analysis values.

Santa Ana Circulation Element

Level Of Service Computation Report

ICU 1(Loss as Cycle Length %) Method (Base Volume Alternative)

Intersection #40 Bristol St and Sunflower Ave

Cycle (sec): 100 Critical Vol./Cap.(X): 0.692
 Loss Time (sec): 5 Average Delay (sec/veh): xxxxxx
 Optimal Cycle: 36 Level Of Service: B

Approach:	North Bound			South Bound			East Bound			West Bound												
Movement:	L	T	R	L	T	R	L	T	R	L	T	R										
Control:	Protected			Protected			Protected			Protected												
Rights:	Include			Include			Include			Include												
Min. Green:	0	0	0	0	0	0	0	0	0	0	0	0										
Y+R:	4.0	4.0	4.0	4.0	4.0	4.0	4.0	4.0	4.0	4.0	4.0	4.0										
Lanes:	2	0	2	1	1		2	0	3	0	1		2	0	2	1	1	2	0	3	0	1

Volume Module:

Base Vol:	651	1376	222	215	804	230	301	588	228	247	952	303
Growth Adj:	1.00	1.00	1.00	1.00	1.00	1.00	1.00	1.00	1.00	1.00	1.00	1.00
Initial Bse:	651	1376	222	215	804	230	301	588	228	247	952	303
User Adj:	1.00	1.00	1.00	1.00	1.00	1.00	1.00	1.00	1.00	1.00	1.00	1.00
PHF Adj:	1.00	1.00	1.00	1.00	1.00	1.00	1.00	1.00	1.00	1.00	1.00	1.00
PHF Volume:	651	1376	222	215	804	230	301	588	228	247	952	303
Reduct Vol:	0	0	0	0	0	0	0	0	0	0	0	0
Reduced Vol:	651	1376	222	215	804	230	301	588	228	247	952	303
PCE Adj:	1.00	1.00	1.00	1.00	1.00	1.00	1.00	1.00	1.00	1.00	1.00	1.00
MLF Adj:	1.00	1.00	1.00	1.00	1.00	1.00	1.00	1.00	1.00	1.00	1.00	1.00
FinalVolume:	651	1376	222	215	804	230	301	588	228	247	952	303

Saturation Flow Module:

Sat/Lane:	1600	1600	1600	1600	1600	1600	1600	1600	1600	1600	1600	1600
Adjustment:	1.00	1.06	1.00	1.00	1.06	1.00	1.00	1.04	1.00	1.00	1.06	1.00
Lanes:	2.00	3.00	1.00	2.00	3.00	1.00	2.00	2.88	1.12	2.00	3.00	1.00
Final Sat.:	3200	5100	1600	3200	5100	1600	3200	4812	1788	3200	5100	1600

Capacity Analysis Module:

Vol/Sat:	0.20	0.27	0.14	0.07	0.16	0.14	0.09	0.12	0.13	0.08	0.19	0.19
Crit Moves:	****				****		****				****	

Santa Ana Circulation Element

Level Of Service Computation Report
 2000 HCM Operations Method (Base Volume Alternative)

 Intersection #41 Bristol St and I-405 NB Ramps

Cycle (sec): 100 Critical Vol./Cap.(X): 0.825
 Loss Time (sec): 5 Average Delay (sec/veh): 28.5
 Optimal Cycle: 60 Level Of Service: C

Approach:	North Bound			South Bound			East Bound			West Bound		
Movement:	L	T	R	L	T	R	L	T	R	L	T	R
Control:	Protected			Protected			Split Phase			Split Phase		
Rights:	Include			Include			Include			Ovl		
Min. Green:	0	0	0	0	0	0	0	0	0	0	0	0
Y+R:	4.0	4.0	4.0	4.0	4.0	4.0	4.0	4.0	4.0	4.0	4.0	4.0
Lanes:	0	0	4	0	0	4	0	0	0	1	1	0

Volume Module:

Base Vol:	0	2094	183	0	2375	22	0	0	204	350	300	1162
Growth Adj:	1.00	1.00	1.00	1.00	1.00	1.00	1.00	1.00	1.00	1.00	1.00	1.00
Initial Bse:	0	2094	183	0	2375	22	0	0	204	350	300	1162
User Adj:	1.00	1.00	1.00	1.00	1.00	1.00	1.00	1.00	1.00	1.00	1.00	1.00
PHF Adj:	1.00	1.00	1.00	1.00	1.00	1.00	1.00	1.00	1.00	1.00	1.00	1.00
PHF Volume:	0	2094	183	0	2375	22	0	0	204	350	300	1162
Reduct Vol:	0	0	0	0	0	0	0	0	0	0	0	0
Reduced Vol:	0	2094	183	0	2375	22	0	0	204	350	300	1162
PCE Adj:	1.00	1.00	1.00	1.00	1.00	1.00	1.00	1.00	1.00	1.00	1.00	1.00
MLF Adj:	1.00	1.00	1.00	1.00	1.00	1.00	1.00	1.00	1.00	1.00	1.00	1.00
FinalVolume:	0	2094	183	0	2375	22	0	0	204	350	300	1162

Saturation Flow Module:

Sat/Lane:	1900	1900	1900	1900	1900	1900	1900	1900	1900	1900	1900	1900
Adjustment:	1.00	0.91	0.85	1.00	0.91	0.91	1.00	1.00	0.75	0.93	0.93	0.75
Lanes:	0.00	4.00	1.00	0.00	4.95	0.05	0.00	0.00	2.00	1.62	1.38	2.00
Final Sat.:	0	6916	1615	0	8557	79	0	0	2842	2840	2434	2842

Capacity Analysis Module:

Vol/Sat:	0.00	0.30	0.11	0.00	0.28	0.28	0.00	0.00	0.07	0.12	0.12	0.41
Crit Moves:	****			****			****			****		
Green/Cycle:	0.00	0.37	0.37	0.00	0.37	0.37	0.00	0.00	0.09	0.50	0.50	0.50
Volume/Cap:	0.00	0.82	0.31	0.00	0.76	0.76	0.00	0.00	0.82	0.25	0.25	0.82
Delay/Veh:	0.0	31.0	22.9	0.0	28.8	28.8	0.0	0.0	64.6	14.5	14.5	25.6
User DelAdj:	1.00	1.00	1.00	1.00	1.00	1.00	1.00	1.00	1.00	1.00	1.00	1.00
AdjDel/Veh:	0.0	31.0	22.9	0.0	28.8	28.8	0.0	0.0	64.6	14.5	14.5	25.6
LOS by Move:	A	C	C	A	C	C	A	A	E	B	B	C
HCM2k85thQ:	0	27	6	0	23	23	0	0	9	6	6	28

 Note: Queue reported is the number of cars per lane.

Santa Ana Circulation Element

Level Of Service Computation Report
 2000 HCM Operations Method (Base Volume Alternative)

 Intersection #42 Bristol St and I-405 SB Ramps

Cycle (sec): 100 Critical Vol./Cap.(X): 0.617
 Loss Time (sec): 5 Average Delay (sec/veh): 18.3
 Optimal Cycle: 31 Level Of Service: B

Approach:	North Bound			South Bound			East Bound			West Bound		
Movement:	L	T	R	L	T	R	L	T	R	L	T	R
Control:	Protected			Protected			Split Phase			Split Phase		
Rights:	Include			Ignore			Include			Include		
Min. Green:	0	0	0	0	0	0	0	0	0	0	0	0
Y+R:	4.0	4.0	4.0	4.0	4.0	4.0	4.0	4.0	4.0	4.0	4.0	4.0
Lanes:	1	0	4	0	0	2	1	1	3	0	0	0

Volume Module:

Base Vol:	128	1570	0	0	1611	942	740	0	331	0	0	0
Growth Adj:	1.00	1.00	1.00	1.00	1.00	1.00	1.00	1.00	1.00	1.00	1.00	1.00
Initial Bse:	128	1570	0	0	1611	942	740	0	331	0	0	0
User Adj:	1.00	1.00	1.00	1.00	1.00	0.00	1.00	1.00	1.00	1.00	1.00	1.00
PHF Adj:	1.00	1.00	1.00	1.00	1.00	0.00	1.00	1.00	1.00	1.00	1.00	1.00
PHF Volume:	128	1570	0	0	1611	0	740	0	331	0	0	0
Reduct Vol:	0	0	0	0	0	0	0	0	0	0	0	0
Reduced Vol:	128	1570	0	0	1611	0	740	0	331	0	0	0
PCE Adj:	1.00	1.00	1.00	1.00	1.00	0.00	1.00	1.00	1.00	1.00	1.00	1.00
MLF Adj:	1.00	1.00	1.00	1.00	1.00	0.00	1.00	1.00	1.00	1.00	1.00	1.00
FinalVolume:	128	1570	0	0	1611	0	740	0	331	0	0	0

Saturation Flow Module:

Sat/Lane:	1900	1900	1900	1900	1900	1900	1900	1900	1900	1900	1900	1900
Adjustment:	0.95	0.91	1.00	1.00	0.91	0.91	0.92	1.00	0.85	1.00	1.00	1.00
Lanes:	1.00	4.00	0.00	0.00	3.00	1.00	3.00	0.00	1.00	0.00	0.00	0.00
Final Sat.:	1805	6916	0	0	5187	1729	5253	0	1615	0	0	0

Capacity Analysis Module:

Vol/Sat:	0.07	0.23	0.00	0.00	0.31	0.00	0.14	0.00	0.20	0.00	0.00	0.00
Crit Moves:	****			****					****			
Green/Cycle:	0.11	0.62	0.00	0.00	0.50	0.00	0.33	0.00	0.33	0.00	0.00	0.00
Volume/Cap:	0.62	0.37	0.00	0.00	0.62	0.00	0.42	0.00	0.62	0.00	0.00	0.00
Delay/Veh:	47.7	9.5	0.0	0.0	18.4	0.0	26.1	0.0	30.2	0.0	0.0	0.0
User DelAdj:	1.00	1.00	1.00	1.00	1.00	1.00	1.00	1.00	1.00	1.00	1.00	1.00
AdjDel/Veh:	47.7	9.5	0.0	0.0	18.4	0.0	26.1	0.0	30.2	0.0	0.0	0.0
LOS by Move:	D	A	A	A	B	A	C	A	C	A	A	A
HCM2k85thQ:	7	10	0	0	20	0	10	0	14	0	0	0

 Note: Queue reported is the number of cars per lane.

Santa Ana Circulation Element

Level Of Service Computation Report

ICU 1(Loss as Cycle Length %) Method (Base Volume Alternative)

Intersection #43 Flower St and Santa Ana Blvd

Cycle (sec): 100 Critical Vol./Cap.(X): 0.857
 Loss Time (sec): 5 Average Delay (sec/veh): xxxxxx
 Optimal Cycle: 68 Level Of Service: D

Approach:	North Bound			South Bound			East Bound			West Bound		
Movement:	L	T	R	L	T	R	L	T	R	L	T	R
Control:	Prot+Permit			Prot+Permit			Prot+Permit			Prot+Permit		
Rights:	Include			Include			Include			Include		
Min. Green:	0	0	0	0	0	0	0	0	0	0	0	0
Y+R:	4.0	4.0	4.0	4.0	4.0	4.0	4.0	4.0	4.0	4.0	4.0	4.0
Lanes:	1	0	2	0	1	1	1	0	3	0	1	1

Volume Module:

Base Vol:	198	1206	99	87	442	40	357	1029	168	186	649	192
Growth Adj:	1.00	1.00	1.00	1.00	1.00	1.00	1.00	1.00	1.00	1.00	1.00	1.00
Initial Bse:	198	1206	99	87	442	40	357	1029	168	186	649	192
User Adj:	1.00	1.00	1.00	1.00	1.00	1.00	1.00	1.00	1.00	1.00	1.00	1.00
PHF Adj:	1.00	1.00	1.00	1.00	1.00	1.00	1.00	1.00	1.00	1.00	1.00	1.00
PHF Volume:	198	1206	99	87	442	40	357	1029	168	186	649	192
Reduct Vol:	0	0	0	0	0	0	0	0	0	0	0	0
Reduced Vol:	198	1206	99	87	442	40	357	1029	168	186	649	192
PCE Adj:	1.00	1.00	1.00	1.00	1.00	1.00	1.00	1.00	1.00	1.00	1.00	1.00
MLF Adj:	1.00	1.00	1.00	1.00	1.00	1.00	1.00	1.00	1.00	1.00	1.00	1.00
Final Volume:	198	1206	99	87	442	40	357	1029	168	186	649	192

Saturation Flow Module:

Sat/Lane:	1600	1600	1600	1600	1600	1600	1600	1600	1600	1600	1600	1600
Adjustment:	1.00	1.06	1.00	1.00	1.06	1.00	1.00	1.06	1.00	1.00	1.05	1.00
Lanes:	1.00	2.00	1.00	1.00	2.00	1.00	1.00	3.00	1.00	1.00	2.32	0.68
Final Sat.:	1600	3400	1600	1600	3400	1600	1600	5100	1600	1600	3904	1096

Capacity Analysis Module:

Vol/Sat:	0.12	0.35	0.06	0.05	0.13	0.03	0.22	0.20	0.11	0.12	0.17	0.18
Crit Moves:	****			****			****			****		

Santa Ana Circulation Element

Level Of Service Computation Report

ICU 1(Loss as Cycle Length %) Method (Base Volume Alternative)

Intersection #44 Flower St and 1st St

Cycle (sec): 100 Critical Vol./Cap.(X): 0.877
 Loss Time (sec): 5 Average Delay (sec/veh): xxxxxx
 Optimal Cycle: 75 Level Of Service: D

Approach:	North Bound			South Bound			East Bound			West Bound		
Movement:	L	T	R	L	T	R	L	T	R	L	T	R
Control:	Protected			Protected			Protected			Protected		
Rights:	Include			Include			Include			Include		
Min. Green:	0	0	0	0	0	0	0	0	0	0	0	0
Y+R:	4.0	4.0	4.0	4.0	4.0	4.0	4.0	4.0	4.0	4.0	4.0	4.0
Lanes:	1	0	2	0	1	1	0	1	0	1	0	2

Volume Module:

Base Vol:	224	1063	253	200	549	159	102	895	74	210	1415	147
Growth Adj:	1.00	1.00	1.00	1.00	1.00	1.00	1.00	1.00	1.00	1.00	1.00	1.00
Initial Bse:	224	1063	253	200	549	159	102	895	74	210	1415	147
User Adj:	1.00	1.00	1.00	1.00	1.00	1.00	1.00	1.00	1.00	1.00	1.00	1.00
PHF Adj:	1.00	1.00	1.00	1.00	1.00	1.00	1.00	1.00	1.00	1.00	1.00	1.00
PHF Volume:	224	1063	253	200	549	159	102	895	74	210	1415	147
Reduct Vol:	0	0	0	0	0	0	0	0	0	0	0	0
Reduced Vol:	224	1063	253	200	549	159	102	895	74	210	1415	147
PCE Adj:	1.00	1.00	1.00	1.00	1.00	1.00	1.00	1.00	1.00	1.00	1.00	1.00
MLF Adj:	1.00	1.00	1.00	1.00	1.00	1.00	1.00	1.00	1.00	1.00	1.00	1.00
FinalVolume:	224	1063	253	200	549	159	102	895	74	210	1415	147

Saturation Flow Module:

Sat/Lane:	1600	1600	1600	1600	1600	1600	1600	1600	1600	1600	1600	1600
Adjustment:	1.00	1.06	1.00	1.00	1.04	1.00	1.00	1.05	1.00	1.00	1.05	1.00
Lanes:	1.00	2.00	1.00	1.00	1.55	0.45	1.00	2.77	0.23	1.00	2.72	0.28
Final Sat.:	1600	3400	1600	1600	2581	719	1600	4633	367	1600	4548	452

Capacity Analysis Module:

Vol/Sat:	0.14	0.31	0.16	0.13	0.21	0.22	0.06	0.19	0.20	0.13	0.31	0.33
Crit Moves:	****			****			****			****		

Santa Ana Circulation Element

Level Of Service Computation Report

ICU 1(Loss as Cycle Length %) Method (Base Volume Alternative)

Intersection #45 Flower St and McFadden Ave

Cycle (sec): 100 Critical Vol./Cap.(X): 1.037
Loss Time (sec): 5 Average Delay (sec/veh): xxxxxx
Optimal Cycle: 180 Level Of Service: F

Table with 4 columns: North Bound, South Bound, East Bound, West Bound. Rows include Movement (L-T-R), Control (Permitted), Rights (Include), Min. Green, Y+R, and Lanes.

Volume Module: Table with 12 columns representing different volume categories and their values.

Saturation Flow Module: Table with 12 columns representing saturation flow values for various lanes.

Capacity Analysis Module: Table with 12 columns representing capacity analysis values.

Santa Ana Circulation Element

Level Of Service Computation Report

ICU 1(Loss as Cycle Length %) Method (Base Volume Alternative)

Intersection #46 Flower St and Segerstrom Ave

Cycle (sec): 100 Critical Vol./Cap.(X): 0.866
Loss Time (sec): 5 Average Delay (sec/veh): xxxxxx
Optimal Cycle: 71 Level Of Service: D

Table with 4 columns: North Bound, South Bound, East Bound, West Bound. Rows include Movement (L-T-R), Control (Permitted/Protected), Rights (Include), Min. Green, Y+R, and Lanes.

Volume Module table with 12 columns representing different traffic movements and 10 rows of adjustment factors like Base Vol, Growth Adj, PHF Adj, etc.

Saturation Flow Module table with 12 columns and 4 rows showing Sat/Lane, Adjustment, Lanes, and Final Sat.

Capacity Analysis Module table with 12 columns and 3 rows showing Vol/Sat, Crit Moves, and asterisks for critical moves.

Santa Ana Circulation Element

Level Of Service Computation Report

ICU 1(Loss as Cycle Length %) Method (Base Volume Alternative)

Intersection #47 Flower St and MacArthur Blvd

Cycle (sec): 100 Critical Vol./Cap.(X): 0.900
Loss Time (sec): 5 Average Delay (sec/veh): xxxxxx
Optimal Cycle: 87 Level Of Service: E

Table with 4 columns: North Bound, South Bound, East Bound, West Bound. Rows include Movement, Control, Rights, Min. Green, Y+R, and Lanes.

Volume Module: Table with 12 columns representing different volume categories and their values.

Saturation Flow Module: Table with 12 columns representing saturation flow values for various lanes.

Capacity Analysis Module: Table with 12 columns representing capacity analysis values.

Santa Ana Circulation Element

Level Of Service Computation Report

ICU 1(Loss as Cycle Length %) Method (Base Volume Alternative)

Intersection #48 Main St and La Veta Ave

Cycle (sec): 100 Critical Vol./Cap.(X): 0.696
 Loss Time (sec): 5 Average Delay (sec/veh): xxxxxx
 Optimal Cycle: 37 Level Of Service: B

Approach:	North Bound			South Bound			East Bound			West Bound								
Movement:	L	T	R	L	T	R	L	T	R	L	T	R						
Control:	Protected			Protected			Protected			Protected								
Rights:	Ovl			Include			Include			Ovl								
Min. Green:	0	0	0	0	0	0	0	0	0	0	0	0						
Y+R:	4.0	4.0	4.0	4.0	4.0	4.0	4.0	4.0	4.0	4.0	4.0	4.0						
Lanes:	2	0	3	0	1		2	0	2	1	0		2	0	2	0	1	

Volume Module:

Base Vol:	347	1059	496	164	1031	266	327	466	209	282	563	226
Growth Adj:	1.00	1.00	1.00	1.00	1.00	1.00	1.00	1.00	1.00	1.00	1.00	1.00
Initial Bse:	347	1059	496	164	1031	266	327	466	209	282	563	226
User Adj:	1.00	1.00	1.00	1.00	1.00	1.00	1.00	1.00	1.00	1.00	1.00	1.00
PHF Adj:	1.00	1.00	1.00	1.00	1.00	1.00	1.00	1.00	1.00	1.00	1.00	1.00
PHF Volume:	347	1059	496	164	1031	266	327	466	209	282	563	226
Reduct Vol:	0	0	0	0	0	0	0	0	0	0	0	0
Reduced Vol:	347	1059	496	164	1031	266	327	466	209	282	563	226
PCE Adj:	1.00	1.00	1.00	1.00	1.00	1.00	1.00	1.00	1.00	1.00	1.00	1.00
MLF Adj:	1.00	1.00	1.00	1.00	1.00	1.00	1.00	1.00	1.00	1.00	1.00	1.00
FinalVolume:	347	1059	496	164	1031	266	327	466	209	282	563	226
OvlAdjVol:	355									144		

Saturation Flow Module:

Sat/Lane:	1600	1600	1600	1600	1600	1600	1600	1600	1600	1600	1600	1600
Adjustment:	1.00	1.06	1.00	1.00	1.05	1.00	1.00	1.06	1.00	1.00	1.06	1.00
Lanes:	2.00	3.00	1.00	2.00	2.38	0.62	2.00	2.07	0.93	2.00	2.00	1.00
Final Sat.:	3200	5100	1600	3200	4016	984	3200	3514	1486	3200	3400	1600

Capacity Analysis Module:

Vol/Sat:	0.11	0.21	0.31	0.05	0.26	0.27	0.10	0.13	0.14	0.09	0.17	0.14
OvlAdjV/S:	0.22									0.09		
Crit Moves:	****			****			****			****		

Santa Ana Circulation Element

Level Of Service Computation Report

ICU 1(Loss as Cycle Length %) Method (Base Volume Alternative)

Intersection #49 Main St and Mainplace Dr / Memory Ln

Cycle (sec): 100 Critical Vol./Cap.(X): 0.556
 Loss Time (sec): 5 Average Delay (sec/veh): xxxxxx
 Optimal Cycle: 26 Level Of Service: A

Approach:	North Bound			South Bound			East Bound			West Bound		
Movement:	L	T	R	L	T	R	L	T	R	L	T	R
Control:	Protected			Protected			Protected			Protected		
Rights:	Include			Include			Include			Include		
Min. Green:	0	0	0	0	0	0	0	0	0	0	0	0
Y+R:	4.0	4.0	4.0	4.0	4.0	4.0	4.0	4.0	4.0	4.0	4.0	4.0
Lanes:	2	0	2	1	0	0	2	0	2	1	0	1

Volume Module:

Base Vol:	113	1186	225	52	1083	143	391	433	116	278	227	110
Growth Adj:	1.00	1.00	1.00	1.00	1.00	1.00	1.00	1.00	1.00	1.00	1.00	1.00
Initial Bse:	113	1186	225	52	1083	143	391	433	116	278	227	110
User Adj:	1.00	1.00	1.00	1.00	1.00	1.00	1.00	1.00	1.00	1.00	1.00	1.00
PHF Adj:	1.00	1.00	1.00	1.00	1.00	1.00	1.00	1.00	1.00	1.00	1.00	1.00
PHF Volume:	113	1186	225	52	1083	143	391	433	116	278	227	110
Reduct Vol:	0	0	0	0	0	0	0	0	0	0	0	0
Reduced Vol:	113	1186	225	52	1083	143	391	433	116	278	227	110
PCE Adj:	1.00	1.00	1.00	1.00	1.00	1.00	1.00	1.00	1.00	1.00	1.00	1.00
MLF Adj:	1.00	1.00	1.00	1.00	1.00	1.00	1.00	1.00	1.00	1.00	1.00	1.00
FinalVolume:	113	1186	225	52	1083	143	391	433	116	278	227	110

Saturation Flow Module:

Sat/Lane:	1600	1600	1600	1600	1600	1600	1600	1600	1600	1600	1600	1600
Adjustment:	1.00	1.05	1.00	1.00	1.05	1.00	1.00	1.05	1.00	1.00	1.06	1.00
Lanes:	2.00	2.52	0.48	2.00	2.65	0.35	2.00	2.37	0.63	2.00	2.00	1.00
Final Sat.:	3200	4235	765	3200	4440	560	3200	3986	1014	3200	3400	1600

Capacity Analysis Module:

Vol/Sat:	0.04	0.28	0.29	0.02	0.24	0.26	0.12	0.11	0.11	0.09	0.07	0.07
Crit Moves:			****	****			****			****		

Santa Ana Circulation Element

Level Of Service Computation Report

ICU 1(Loss as Cycle Length %) Method (Base Volume Alternative)

Intersection #50 Main St and 17th St

Cycle (sec): 100 Critical Vol./Cap.(X): 0.760
 Loss Time (sec): 5 Average Delay (sec/veh): xxxxxx
 Optimal Cycle: 45 Level Of Service: C

Approach:	North Bound			South Bound			East Bound			West Bound		
Movement:	L	T	R	L	T	R	L	T	R	L	T	R
Control:	Protected			Protected			Protected			Protected		
Rights:	Include			Include			Include			Include		
Min. Green:	0	0	0	0	0	0	0	0	0	0	0	0
Y+R:	4.0	4.0	4.0	4.0	4.0	4.0	4.0	4.0	4.0	4.0	4.0	4.0
Lanes:	2	0	2	0	2	1	2	0	2	1	0	2

Volume Module:

Base Vol:	197	1019	222	222	969	150	224	1256	74	199	1220	81
Growth Adj:	1.00	1.00	1.00	1.00	1.00	1.00	1.00	1.00	1.00	1.00	1.00	1.00
Initial Bse:	197	1019	222	222	969	150	224	1256	74	199	1220	81
User Adj:	1.00	1.00	1.00	1.00	1.00	1.00	1.00	1.00	1.00	1.00	1.00	1.00
PHF Adj:	1.00	1.00	1.00	1.00	1.00	1.00	1.00	1.00	1.00	1.00	1.00	1.00
PHF Volume:	197	1019	222	222	969	150	224	1256	74	199	1220	81
Reduct Vol:	0	0	0	0	0	0	0	0	0	0	0	0
Reduced Vol:	197	1019	222	222	969	150	224	1256	74	199	1220	81
PCE Adj:	1.00	1.00	1.00	1.00	1.00	1.00	1.00	1.00	1.00	1.00	1.00	1.00
MLF Adj:	1.00	1.00	1.00	1.00	1.00	1.00	1.00	1.00	1.00	1.00	1.00	1.00
FinalVolume:	197	1019	222	222	969	150	224	1256	74	199	1220	81

Saturation Flow Module:

Sat/Lane:	1600	1600	1600	1600	1600	1600	1600	1600	1600	1600	1600	1600
Adjustment:	1.00	1.06	1.00	1.00	1.06	1.00	1.00	1.04	1.00	1.00	1.04	1.00
Lanes:	2.00	2.00	1.00	2.00	2.00	1.00	2.00	2.83	0.17	2.00	2.81	0.19
Final Sat.:	3200	3400	1600	3200	3400	1600	3200	4733	267	3200	4701	299

Capacity Analysis Module:

Vol/Sat:	0.06	0.30	0.14	0.07	0.28	0.09	0.07	0.27	0.28	0.06	0.26	0.27
Crit Moves:	****			****			****			****		

Santa Ana Circulation Element

Level Of Service Computation Report

ICU 1(Loss as Cycle Length %) Method (Base Volume Alternative)

Intersection #51 Main St and Civic Center Dr

Cycle (sec): 100 Critical Vol./Cap.(X): 0.965
 Loss Time (sec): 5 Average Delay (sec/veh): xxxxxx
 Optimal Cycle: 152 Level Of Service: E

Approach:	North Bound			South Bound			East Bound			West Bound		
Movement:	L	T	R	L	T	R	L	T	R	L	T	R
Control:	Permitted			Permitted			Permitted			Permitted		
Rights:	Include			Include			Include			Include		
Min. Green:	0	0	0	0	0	0	0	0	0	0	0	0
Y+R:	4.0	4.0	4.0	4.0	4.0	4.0	4.0	4.0	4.0	4.0	4.0	4.0
Lanes:	1	0	1	1	0	1	1	0	1	1	0	1

Volume Module:

Base Vol:	92	1169	98	52	853	54	239	1322	158	38	384	39
Growth Adj:	1.00	1.00	1.00	1.00	1.00	1.00	1.00	1.00	1.00	1.00	1.00	1.00
Initial Bse:	92	1169	98	52	853	54	239	1322	158	38	384	39
User Adj:	1.00	1.00	1.00	1.00	1.00	1.00	1.00	1.00	1.00	1.00	1.00	1.00
PHF Adj:	1.00	1.00	1.00	1.00	1.00	1.00	1.00	1.00	1.00	1.00	1.00	1.00
PHF Volume:	92	1169	98	52	853	54	239	1322	158	38	384	39
Reduct Vol:	0	0	0	0	0	0	0	0	0	0	0	0
Reduced Vol:	92	1169	98	52	853	54	239	1322	158	38	384	39
PCE Adj:	1.00	1.00	1.00	1.00	1.00	1.00	1.00	1.00	1.00	1.00	1.00	1.00
MLF Adj:	1.00	1.00	1.00	1.00	1.00	1.00	1.00	1.00	1.00	1.00	1.00	1.00
FinalVolume:	92	1169	98	52	853	54	239	1322	158	38	384	39

Saturation Flow Module:

Sat/Lane:	1600	1600	1600	1600	1600	1600	1600	1600	1600	1600	1600	1600
Adjustment:	1.00	1.03	1.00	1.00	1.03	1.00	1.00	1.03	1.00	1.00	1.03	1.00
Lanes:	1.00	1.85	0.15	1.00	1.88	0.12	1.00	1.79	0.21	1.00	1.82	0.18
Final Sat.:	1600	3052	248	1600	3109	191	1600	2958	342	1600	3005	295

Capacity Analysis Module:

Vol/Sat:	0.06	0.38	0.40	0.03	0.27	0.28	0.15	0.45	0.46	0.02	0.13	0.13
Crit Moves:			****	****					****	****		

Santa Ana Circulation Element

Level Of Service Computation Report

ICU 1(Loss as Cycle Length %) Method (Base Volume Alternative)

Intersection #52 Main St and Santa Ana Blvd

Cycle (sec): 100 Critical Vol./Cap.(X): 0.792
 Loss Time (sec): 5 Average Delay (sec/veh): xxxxxx
 Optimal Cycle: 50 Level Of Service: C

Approach:	North Bound			South Bound			East Bound			West Bound		
Movement:	L	T	R	L	T	R	L	T	R	L	T	R
Control:	Permitted			Permitted			Permitted			Permitted		
Rights:	Include			Include			Include			Include		
Min. Green:	0	0	0	0	0	0	0	0	0	0	0	0
Y+R:	4.0	4.0	4.0	4.0	4.0	4.0	4.0	4.0	4.0	4.0	4.0	4.0
Lanes:	1	0	2	0	0	1	0	0	0	0	1	0

Volume Module:

Base Vol:	51	1152	0	0	1083	53	0	0	0	92	924	120
Growth Adj:	1.00	1.00	1.00	1.00	1.00	1.00	1.00	1.00	1.00	1.00	1.00	1.00
Initial Bse:	51	1152	0	0	1083	53	0	0	0	92	924	120
User Adj:	1.00	1.00	1.00	1.00	1.00	1.00	1.00	1.00	1.00	1.00	1.00	1.00
PHF Adj:	1.00	1.00	1.00	1.00	1.00	1.00	1.00	1.00	1.00	1.00	1.00	1.00
PHF Volume:	51	1152	0	0	1083	53	0	0	0	92	924	120
Reduct Vol:	0	0	0	0	0	0	0	0	0	0	0	0
Reduced Vol:	51	1152	0	0	1083	53	0	0	0	92	924	120
PCE Adj:	1.00	1.00	1.00	1.00	1.00	1.00	1.00	1.00	1.00	1.00	1.00	1.00
MLF Adj:	1.00	1.00	1.00	1.00	1.00	1.00	1.00	1.00	1.00	1.00	1.00	1.00
FinalVolume:	51	1152	0	0	1083	53	0	0	0	92	924	120

Saturation Flow Module:

Sat/Lane:	1600	1600	1600	1600	1600	1600	1600	1600	1600	1600	1600	1600
Adjustment:	1.00	1.06	1.00	1.00	1.03	1.00	1.00	1.06	1.00	1.00	1.00	1.00
Lanes:	1.00	2.00	0.00	0.00	1.91	0.09	0.00	0.00	0.00	0.16	1.63	0.21
Final Sat.:	1600	3400	0	0	3151	149	0	0	0	259	2603	338

Capacity Analysis Module:

Vol/Sat:	0.03	0.34	0.00	0.00	0.34	0.36	0.00	0.00	0.00	0.06	0.36	0.35
Crit Moves:	****					****					****	

Santa Ana Circulation Element

Level Of Service Computation Report

ICU 1(Loss as Cycle Length %) Method (Base Volume Alternative)

Intersection #53 Main St and 4th St

Cycle (sec): 100 Critical Vol./Cap.(X): 0.447
Loss Time (sec): 5 Average Delay (sec/veh): xxxxxx
Optimal Cycle: 22 Level Of Service: A

Table with 4 columns: North Bound, South Bound, East Bound, West Bound. Rows include Movement (L-T-R), Control (Permitted), Rights (Include), Min. Green, Y+R, and Lanes.

Volume Module: Table with 12 columns representing different volume categories and their values across the four directions.

Saturation Flow Module: Table with 12 columns representing saturation flow values and adjustment factors.

Capacity Analysis Module: Table with 12 columns representing capacity analysis metrics.

Santa Ana Circulation Element

Level Of Service Computation Report

ICU 1(Loss as Cycle Length %) Method (Base Volume Alternative)

Intersection #54 Main St and 1st St

Cycle (sec): 100 Critical Vol./Cap.(X): 0.744
 Loss Time (sec): 5 Average Delay (sec/veh): xxxxxx
 Optimal Cycle: 43 Level Of Service: C

Approach:	North Bound			South Bound			East Bound			West Bound		
Movement:	L	T	R	L	T	R	L	T	R	L	T	R
Control:	Protected			Protected			Protected			Protected		
Rights:	Include			Include			Include			Include		
Min. Green:	0	0	0	0	0	0	0	0	0	0	0	0
Y+R:	4.0	4.0	4.0	4.0	4.0	4.0	4.0	4.0	4.0	4.0	4.0	4.0
Lanes:	1	0	1	1	0	1	1	0	1	1	0	1

Volume Module:

Base Vol:	152	745	65	146	559	119	116	1172	87	111	1244	87
Growth Adj:	1.00	1.00	1.00	1.00	1.00	1.00	1.00	1.00	1.00	1.00	1.00	1.00
Initial Bse:	152	745	65	146	559	119	116	1172	87	111	1244	87
User Adj:	1.00	1.00	1.00	1.00	1.00	1.00	1.00	1.00	1.00	1.00	1.00	1.00
PHF Adj:	1.00	1.00	1.00	1.00	1.00	1.00	1.00	1.00	1.00	1.00	1.00	1.00
PHF Volume:	152	745	65	146	559	119	116	1172	87	111	1244	87
Reduct Vol:	0	0	0	0	0	0	0	0	0	0	0	0
Reduced Vol:	152	745	65	146	559	119	116	1172	87	111	1244	87
PCE Adj:	1.00	1.00	1.00	1.00	1.00	1.00	1.00	1.00	1.00	1.00	1.00	1.00
MLF Adj:	1.00	1.00	1.00	1.00	1.00	1.00	1.00	1.00	1.00	1.00	1.00	1.00
FinalVolume:	152	745	65	146	559	119	116	1172	87	111	1244	87

Saturation Flow Module:

Sat/Lane:	1600	1600	1600	1600	1600	1600	1600	1600	1600	1600	1600	1600
Adjustment:	1.00	1.03	1.00	1.00	1.06	1.00	1.00	1.04	1.00	1.00	1.04	1.00
Lanes:	1.00	1.84	0.16	1.00	2.00	1.00	1.00	2.79	0.21	1.00	2.80	0.20
Final Sat.:	1600	3043	257	1600	3400	1600	1600	4668	332	1600	4686	314

Capacity Analysis Module:

Vol/Sat:	0.10	0.24	0.25	0.09	0.16	0.07	0.07	0.25	0.26	0.07	0.27	0.28
Crit Moves:			****	****			****			****		

Santa Ana Circulation Element

Level Of Service Computation Report

ICU 1(Loss as Cycle Length %) Method (Base Volume Alternative)

Intersection #55 Main St and McFadden Ave

Cycle (sec): 100 Critical Vol./Cap.(X): 0.925
Loss Time (sec): 5 Average Delay (sec/veh): xxxxxx
Optimal Cycle: 104 Level Of Service: E

Table with 4 columns: North Bound, South Bound, East Bound, West Bound. Rows include Movement (L-T-R), Control, Rights, Min. Green, Y+R, and Lanes.

Volume Module: Table with 12 columns representing different volume categories and 12 rows of adjustment factors like Base Vol, Growth Adj, etc.

Saturation Flow Module: Table with 12 columns and 4 rows showing Sat/Lane, Adjustment, Lanes, and Final Sat.

Capacity Analysis Module: Table with 12 columns and 3 rows showing Vol/Sat, Crit Moves, and other capacity metrics.

Santa Ana Circulation Element

Level Of Service Computation Report

ICU 1(Loss as Cycle Length %) Method (Base Volume Alternative)

Intersection #56 Main St and Edinger Ave

Cycle (sec): 100 Critical Vol./Cap.(X): 0.867
 Loss Time (sec): 5 Average Delay (sec/veh): xxxxxx
 Optimal Cycle: 71 Level Of Service: D

Approach:	North Bound			South Bound			East Bound			West Bound		
Movement:	L	T	R	L	T	R	L	T	R	L	T	R
Control:	Protected			Protected			Protected			Protected		
Rights:	Include			Include			Include			Include		
Min. Green:	0	0	0	0	0	0	0	0	0	0	0	0
Y+R:	4.0	4.0	4.0	4.0	4.0	4.0	4.0	4.0	4.0	4.0	4.0	4.0
Lanes:	1	0	1	1	0	1	1	0	2	1	0	2

Volume Module:

Base Vol:	101	1069	49	129	646	88	118	698	78	102	1364	141
Growth Adj:	1.00	1.00	1.00	1.00	1.00	1.00	1.00	1.00	1.00	1.00	1.00	1.00
Initial Bse:	101	1069	49	129	646	88	118	698	78	102	1364	141
User Adj:	1.00	1.00	1.00	1.00	1.00	1.00	1.00	1.00	1.00	1.00	1.00	1.00
PHF Adj:	1.00	1.00	1.00	1.00	1.00	1.00	1.00	1.00	1.00	1.00	1.00	1.00
PHF Volume:	101	1069	49	129	646	88	118	698	78	102	1364	141
Reduct Vol:	0	0	0	0	0	0	0	0	0	0	0	0
Reduced Vol:	101	1069	49	129	646	88	118	698	78	102	1364	141
PCE Adj:	1.00	1.00	1.00	1.00	1.00	1.00	1.00	1.00	1.00	1.00	1.00	1.00
MLF Adj:	1.00	1.00	1.00	1.00	1.00	1.00	1.00	1.00	1.00	1.00	1.00	1.00
FinalVolume:	101	1069	49	129	646	88	118	698	78	102	1364	141

Saturation Flow Module:

Sat/Lane:	1600	1600	1600	1600	1600	1600	1600	1600	1600	1600	1600	1600
Adjustment:	1.00	1.03	1.00	1.00	1.04	1.00	1.00	1.05	1.00	1.00	1.05	1.00
Lanes:	1.00	1.91	0.09	1.00	1.76	0.24	1.00	2.70	0.30	1.00	2.72	0.28
Final Sat.:	1600	3160	140	1600	2916	384	1600	4518	482	1600	4550	450

Capacity Analysis Module:

Vol/Sat:	0.06	0.34	0.35	0.08	0.22	0.23	0.07	0.15	0.16	0.06	0.30	0.31
Crit Moves:			****	****			****			****		

Santa Ana Circulation Element

Level Of Service Computation Report

ICU 1(Loss as Cycle Length %) Method (Base Volume Alternative)

Intersection #57 Main St and MacArthur Blvd

Cycle (sec): 100 Critical Vol./Cap.(X): 0.749
 Loss Time (sec): 5 Average Delay (sec/veh): xxxxxx
 Optimal Cycle: 43 Level Of Service: C

Approach:	North Bound			South Bound			East Bound			West Bound		
Movement:	L	T	R	L	T	R	L	T	R	L	T	R
Control:	Protected			Protected			Protected			Protected		
Rights:	Include			Include			Include			Include		
Min. Green:	0	0	0	0	0	0	0	0	0	0	0	0
Y+R:	4.0	4.0	4.0	4.0	4.0	4.0	4.0	4.0	4.0	4.0	4.0	4.0
Lanes:	2	0	3	0	1		2	0	3	0	1	

Volume Module:

Base Vol:	446	1067	293	265	345	260	313	643	62	193	1529	444
Growth Adj:	1.00	1.00	1.00	1.00	1.00	1.00	1.00	1.00	1.00	1.00	1.00	1.00
Initial Bse:	446	1067	293	265	345	260	313	643	62	193	1529	444
User Adj:	1.00	1.00	1.00	1.00	1.00	1.00	1.00	1.00	1.00	1.00	1.00	1.00
PHF Adj:	1.00	1.00	1.00	1.00	1.00	1.00	1.00	1.00	1.00	1.00	1.00	1.00
PHF Volume:	446	1067	293	265	345	260	313	643	62	193	1529	444
Reduct Vol:	0	0	0	0	0	0	0	0	0	0	0	0
Reduced Vol:	446	1067	293	265	345	260	313	643	62	193	1529	444
PCE Adj:	1.00	1.00	1.00	1.00	1.00	1.00	1.00	1.00	1.00	1.00	1.00	1.00
MLF Adj:	1.00	1.00	1.00	1.00	1.00	1.00	1.00	1.00	1.00	1.00	1.00	1.00
Final Volume:	446	1067	293	265	345	260	313	643	62	193	1529	444

Saturation Flow Module:

Sat/Lane:	1600	1600	1600	1600	1600	1600	1600	1600	1600	1600	1600	1600
Adjustment:	1.00	1.06	1.00	1.00	1.06	1.00	1.00	1.06	1.00	1.00	1.06	1.00
Lanes:	2.00	3.00	1.00	2.00	3.00	1.00	2.00	3.00	1.00	2.00	3.00	1.00
Final Sat.:	3200	5100	1600	3200	5100	1600	3200	5100	1600	3200	5100	1600

Capacity Analysis Module:

Vol/Sat:	0.14	0.21	0.18	0.08	0.07	0.16	0.10	0.13	0.04	0.06	0.30	0.28
Crit Moves:	****					****	****				****	

Santa Ana Circulation Element

Level Of Service Computation Report
 2000 HCM Operations Method (Base Volume Alternative)

 Intersection #58 Penn Wy and 17th St

Cycle (sec): 100 Critical Vol./Cap.(X): 0.872
 Loss Time (sec): 5 Average Delay (sec/veh): 25.5
 Optimal Cycle: 76 Level Of Service: C

Approach:	North Bound			South Bound			East Bound			West Bound		
Movement:	L	T	R	L	T	R	L	T	R	L	T	R
Control:	Split Phase			Split Phase			Protected			Protected		
Rights:	Include			Include			Include			Include		
Min. Green:	0	0	0	0	0	0	0	0	0	0	0	0
Y+R:	4.0	4.0	4.0	4.0	4.0	4.0	4.0	4.0	4.0	4.0	4.0	4.0
Lanes:	2	0	0	0	0	0	2	1	0	1	0	0

Volume Module:

Base Vol:	1113	0	543	0	0	0	0	1672	539	123	1440	0
Growth Adj:	1.00	1.00	1.00	1.00	1.00	1.00	1.00	1.00	1.00	1.00	1.00	1.00
Initial Bse:	1113	0	543	0	0	0	0	1672	539	123	1440	0
User Adj:	1.00	1.00	1.00	1.00	1.00	1.00	1.00	1.00	1.00	1.00	1.00	1.00
PHF Adj:	1.00	1.00	1.00	1.00	1.00	1.00	1.00	1.00	1.00	1.00	1.00	1.00
PHF Volume:	1113	0	543	0	0	0	0	1672	539	123	1440	0
Reduct Vol:	0	0	0	0	0	0	0	0	0	0	0	0
Reduced Vol:	1113	0	543	0	0	0	0	1672	539	123	1440	0
PCE Adj:	1.00	1.00	1.00	1.00	1.00	1.00	1.00	1.00	1.00	1.00	1.00	1.00
MLF Adj:	1.00	1.00	1.00	1.00	1.00	1.00	1.00	1.00	1.00	1.00	1.00	1.00
FinalVolume:	1113	0	543	0	0	0	0	1672	539	123	1440	0

Saturation Flow Module:

Sat/Lane:	1900	1900	1900	1900	1900	1900	1900	1900	1900	1900	1900	1900
Adjustment:	0.92	1.00	0.75	1.00	1.00	1.00	1.00	0.88	0.88	0.95	0.91	1.00
Lanes:	2.00	0.00	2.00	0.00	0.00	0.00	0.00	2.27	0.73	1.00	3.00	0.00
Final Sat.:	3502	0	2842	0	0	0	0	3777	1218	1805	5187	0

Capacity Analysis Module:

Vol/Sat:	0.32	0.00	0.19	0.00	0.00	0.00	0.00	0.44	0.44	0.07	0.28	0.00
Crit Moves:	****							****		****		
Green/Cycle:	0.36	0.00	0.36	0.00	0.00	0.00	0.00	0.51	0.51	0.08	0.59	0.00
Volume/Cap:	0.87	0.00	0.52	0.00	0.00	0.00	0.00	0.87	0.87	0.87	0.47	0.00
Delay/Veh:	36.5	0.0	25.5	0.0	0.0	0.0	0.0	25.4	25.4	86.2	12.0	0.0
User DelAdj:	1.00	1.00	1.00	1.00	1.00	1.00	1.00	1.00	1.00	1.00	1.00	1.00
AdjDel/Veh:	36.5	0.0	25.5	0.0	0.0	0.0	0.0	25.4	25.4	86.2	12.0	0.0
LOS by Move:	D	A	C	A	A	A	A	C	C	F	B	A
HCM2k85thQ:	28	0	12	0	0	0	0	36	36	10	14	0

 Note: Queue reported is the number of cars per lane.

Santa Ana Circulation Element

Level Of Service Computation Report
 2000 HCM Operations Method (Base Volume Alternative)

 Intersection #59 I-5 NB Off Ramps/17th Street

Cycle (sec): 100 Critical Vol./Cap.(X): 0.587
 Loss Time (sec): 5 Average Delay (sec/veh): 19.0
 Optimal Cycle: 29 Level Of Service: B

Street Name:	I-5 NB Off Ramps						17th Street					
Approach:	North Bound			South Bound			East Bound			West Bound		
Movement:	L	T	R	L	T	R	L	T	R	L	T	R
Control:	Split Phase			Split Phase			Protected			Permitted		
Rights:	Include			Include			Ignore			Include		
Min. Green:	0	0	0	0	0	0	0	0	0	0	0	0
Y+R:	4.0	4.0	4.0	4.0	4.0	4.0	4.0	4.0	4.0	4.0	4.0	4.0
Lanes:	1	1	0	0	0	1	1	0	3	0	1	0

Volume Module:

Base Vol:	330	44	17	50	0	130	114	1047	688	0	1564	42
Growth Adj:	1.00	1.00	1.00	1.00	1.00	1.00	1.00	1.00	1.00	1.00	1.00	1.00
Initial Bse:	330	44	17	50	0	130	114	1047	688	0	1564	42
User Adj:	1.00	1.00	1.00	1.00	1.00	1.00	1.00	1.00	0.00	1.00	1.00	1.00
PHF Adj:	1.00	1.00	1.00	1.00	1.00	1.00	1.00	1.00	0.00	1.00	1.00	1.00
PHF Volume:	330	44	17	50	0	130	114	1047	0	0	1564	42
Reduct Vol:	0	0	0	0	0	0	0	0	0	0	0	0
Reduced Vol:	330	44	17	50	0	130	114	1047	0	0	1564	42
PCE Adj:	1.00	1.00	1.00	1.00	1.00	1.00	1.00	1.00	0.00	1.00	1.00	1.00
MLF Adj:	1.00	1.00	1.00	1.00	1.00	1.00	1.00	1.00	0.00	1.00	1.00	1.00
Final Volume:	330	44	17	50	0	130	114	1047	0	0	1564	42

Saturation Flow Module:

Sat/Lane:	1900	1900	1900	1900	1900	1900	1900	1900	1900	1900	1900	1900
Adjustment:	0.96	0.96	0.85	0.95	1.00	0.85	0.95	0.91	1.00	1.00	0.91	0.91
Lanes:	1.76	0.24	1.00	1.00	0.00	1.00	1.00	3.00	1.00	0.00	2.92	0.08
Final Sat.:	3212	428	1615	1805	0	1615	1805	5187	1900	0	5031	135

Capacity Analysis Module:

Vol/Sat:	0.10	0.10	0.01	0.03	0.00	0.08	0.06	0.20	0.00	0.00	0.31	0.31
Crit Moves:	****			****			****			****		
Green/Cycle:	0.18	0.18	0.18	0.14	0.00	0.14	0.11	0.64	0.00	0.00	0.53	0.53
Volume/Cap:	0.59	0.59	0.06	0.20	0.00	0.59	0.59	0.32	0.00	0.00	0.59	0.59
Delay/Veh:	39.3	39.3	34.5	38.7	0.0	44.5	47.1	8.3	0.0	0.0	16.4	16.4
User DelAdj:	1.00	1.00	1.00	1.00	1.00	1.00	1.00	1.00	1.00	1.00	1.00	1.00
AdjDel/Veh:	39.3	39.3	34.5	38.7	0.0	44.5	47.1	8.3	0.0	0.0	16.4	16.4
LOS by Move:	D	D	C	D	A	D	D	A	A	A	B	B
HCM2k85thQ:	9	9	1	2	0	7	7	8	0	0	19	19

 Note: Queue reported is the number of cars per lane.

Santa Ana Circulation Element

Level Of Service Computation Report
 2000 HCM Operations Method (Base Volume Alternative)

 Intersection #60 Penn Wy and I-5 SB Ramps

Cycle (sec): 100 Critical Vol./Cap.(X): 0.573
 Loss Time (sec): 5 Average Delay (sec/veh): 23.0
 Optimal Cycle: 29 Level Of Service: C

Approach:	North Bound			South Bound			East Bound			West Bound		
Movement:	L	T	R	L	T	R	L	T	R	L	T	R
Control:	Protected			Protected			Split Phase			Split Phase		
Rights:	Include			Include			Include			Ovl		
Min. Green:	0	0	0	0	0	0	0	0	0	0	0	0
Y+R:	4.0	4.0	4.0	4.0	4.0	4.0	4.0	4.0	4.0	4.0	4.0	4.0
Lanes:	0	0	2	0	1	1	2	0	0	0	0	2

Volume Module:

Base Vol:	0	631	414	592	137	0	0	0	0	214	0	183
Growth Adj:	1.00	1.00	1.00	1.00	1.00	1.00	1.00	1.00	1.00	1.00	1.00	1.00
Initial Bse:	0	631	414	592	137	0	0	0	0	214	0	183
User Adj:	1.00	1.00	1.00	1.00	1.00	1.00	1.00	1.00	1.00	1.00	1.00	1.00
PHF Adj:	1.00	1.00	1.00	1.00	1.00	1.00	1.00	1.00	1.00	1.00	1.00	1.00
PHF Volume:	0	631	414	592	137	0	0	0	0	214	0	183
Reduct Vol:	0	0	0	0	0	0	0	0	0	0	0	0
Reduced Vol:	0	631	414	592	137	0	0	0	0	214	0	183
PCE Adj:	1.00	1.00	1.00	1.00	1.00	1.00	1.00	1.00	1.00	1.00	1.00	1.00
MLF Adj:	1.00	1.00	1.00	1.00	1.00	1.00	1.00	1.00	1.00	1.00	1.00	1.00
FinalVolume:	0	631	414	592	137	0	0	0	0	214	0	183

Saturation Flow Module:

Sat/Lane:	1900	1900	1900	1900	1900	1900	1900	1900	1900	1900	1900	1900
Adjustment:	1.00	0.95	0.85	0.92	0.95	1.00	1.00	1.00	1.00	0.95	1.00	0.75
Lanes:	0.00	2.00	1.00	2.00	2.00	0.00	0.00	0.00	0.00	1.00	0.00	2.00
Final Sat.:	0	3610	1615	3502	3610	0	0	0	0	1805	0	2842

Capacity Analysis Module:

Vol/Sat:	0.00	0.17	0.26	0.17	0.04	0.00	0.00	0.00	0.00	0.12	0.00	0.06
Crit Moves:	****			****						****		
Green/Cycle:	0.00	0.45	0.45	0.30	0.74	0.00	0.00	0.00	0.00	0.21	0.00	0.50
Volume/Cap:	0.00	0.39	0.57	0.57	0.05	0.00	0.00	0.00	0.00	0.57	0.00	0.13
Delay/Veh:	0.0	18.6	21.6	30.7	3.4	0.0	0.0	0.0	0.0	37.8	0.0	13.3
User DelAdj:	1.00	1.00	1.00	1.00	1.00	1.00	1.00	1.00	1.00	1.00	1.00	1.00
AdjDel/Veh:	0.0	18.6	21.6	30.7	3.4	0.0	0.0	0.0	0.0	37.8	0.0	13.3
LOS by Move:	A	B	C	C	A	A	A	A	A	D	A	B
HCM2k85thQ:	0	10	15	13	1	0	0	0	0	10	0	3

 Note: Queue reported is the number of cars per lane.

Santa Ana Circulation Element

Level Of Service Computation Report
 2000 HCM 4-Way Stop Method (Base Volume Alternative)

 Intersection #61 Santiago St and Civic Center Dr

Cycle (sec): 100 Critical Vol./Cap.(X): 1.369
 Loss Time (sec): 5 Average Delay (sec/veh): 110.0
 Optimal Cycle: 0 Level Of Service: F

Approach:	North Bound			South Bound			East Bound			West Bound		
Movement:	L	T	R	L	T	R	L	T	R	L	T	R
Control:	Stop Sign			Stop Sign			Stop Sign			Stop Sign		
Rights:	Include			Include			Include			Include		
Min. Green:	0	0	0	0	0	0	0	0	0	0	0	0
Lanes:	1	0	0	1	0	0	0	1	0	0	0	1

Volume Module:

Base Vol:	194	598	60	32	456	117	266	76	269	14	19	18
Growth Adj:	1.00	1.00	1.00	1.00	1.00	1.00	1.00	1.00	1.00	1.00	1.00	1.00
Initial Bse:	194	598	60	32	456	117	266	76	269	14	19	18
User Adj:	1.00	1.00	1.00	1.00	1.00	1.00	1.00	1.00	1.00	1.00	1.00	1.00
PHF Adj:	1.00	1.00	1.00	1.00	1.00	1.00	1.00	1.00	1.00	1.00	1.00	1.00
PHF Volume:	194	598	60	32	456	117	266	76	269	14	19	18
Reduct Vol:	0	0	0	0	0	0	0	0	0	0	0	0
Reduced Vol:	194	598	60	32	456	117	266	76	269	14	19	18
PCE Adj:	1.00	1.00	1.00	1.00	1.00	1.00	1.00	1.00	1.00	1.00	1.00	1.00
MLF Adj:	1.00	1.00	1.00	1.00	1.00	1.00	1.00	1.00	1.00	1.00	1.00	1.00
FinalVolume:	194	598	60	32	456	117	266	76	269	14	19	18

Saturation Flow Module:

Adjustment:	1.00	1.00	1.00	1.00	1.00	1.00	1.00	1.00	1.00	1.00	1.00	1.00
Lanes:	1.00	0.91	0.09	1.00	0.80	0.20	0.78	0.22	1.00	0.27	0.38	0.35
Final Sat.:	446	437	44	428	375	96	342	98	507	104	141	134

Capacity Analysis Module:

Vol/Sat:	0.44	1.37	1.37	0.07	1.22	1.22	0.78	0.78	0.53	0.13	0.13	0.13
Crit Moves:	****			****			****			****		
Delay/Veh:	16.8	201	200.6	11.6	140	140.1	34.1	34.1	17.5	13.7	13.7	13.7
Delay Adj:	1.00	1.00	1.00	1.00	1.00	1.00	1.00	1.00	1.00	1.00	1.00	1.00
AdjDel/Veh:	16.8	201	200.6	11.6	140	140.1	34.1	34.1	17.5	13.7	13.7	13.7
LOS by Move:	C	F	F	B	F	F	D	D	C	B	B	B
ApproachDel:	158.8			133.3			26.8			13.7		
Delay Adj:	1.00			1.00			1.00			1.00		
ApprAdjDel:	158.8			133.3			26.8			13.7		
LOS by Appr:	F			F			D			B		
AllWayAvgQ:	0.7	25.4	25.4	0.1	17.0	17.0	2.8	2.8	1.1	0.1	0.1	0.1

 Note: Queue reported is the number of cars per lane.

Santa Ana Circulation Element

Level Of Service Computation Report

ICU 1(Loss as Cycle Length %) Method (Base Volume Alternative)

Intersection #62 Santiago St and Santa Ana Blvd

Cycle (sec): 100 Critical Vol./Cap.(X): 1.017
 Loss Time (sec): 5 Average Delay (sec/veh): xxxxxx
 Optimal Cycle: 180 Level Of Service: F

Approach:	North Bound			South Bound			East Bound			West Bound		
Movement:	L	T	R	L	T	R	L	T	R	L	T	R
Control:	Permitted			Permitted			Protected			Protected		
Rights:	Include			Include			Include			Include		
Min. Green:	0	0	0	0	0	0	0	0	0	0	0	0
Y+R:	4.0	4.0	4.0	4.0	4.0	4.0	4.0	4.0	4.0	4.0	4.0	4.0
Lanes:	1	0	1	1	0	1	1	0	1	1	0	2

Volume Module:

Base Vol:	135	833	236	378	639	103	164	673	87	255	546	347
Growth Adj:	1.00	1.00	1.00	1.00	1.00	1.00	1.00	1.00	1.00	1.00	1.00	1.00
Initial Bse:	135	833	236	378	639	103	164	673	87	255	546	347
User Adj:	1.00	1.00	1.00	1.00	1.00	1.00	1.00	1.00	1.00	1.00	1.00	1.00
PHF Adj:	1.00	1.00	1.00	1.00	1.00	1.00	1.00	1.00	1.00	1.00	1.00	1.00
PHF Volume:	135	833	236	378	639	103	164	673	87	255	546	347
Reduct Vol:	0	0	0	0	0	0	0	0	0	0	0	0
Reduced Vol:	135	833	236	378	639	103	164	673	87	255	546	347
PCE Adj:	1.00	1.00	1.00	1.00	1.00	1.00	1.00	1.00	1.00	1.00	1.00	1.00
MLF Adj:	1.00	1.00	1.00	1.00	1.00	1.00	1.00	1.00	1.00	1.00	1.00	1.00
FinalVolume:	135	833	236	378	639	103	164	673	87	255	546	347

Saturation Flow Module:

Sat/Lane:	1600	1600	1600	1600	1600	1600	1600	1600	1600	1600	1600	1600
Adjustment:	1.00	1.04	1.00	1.00	1.04	1.00	1.00	1.04	1.00	1.00	1.06	1.00
Lanes:	1.00	1.56	0.44	1.00	1.72	0.28	1.00	1.77	0.23	1.00	2.00	1.00
Final Sat.:	1600	2594	706	1600	2856	444	1600	2934	366	1600	3400	1600

Capacity Analysis Module:

Vol/Sat:	0.08	0.32	0.33	0.24	0.22	0.23	0.10	0.23	0.24	0.16	0.16	0.22
Crit Moves:			****	****					****	****		

Santa Ana Circulation Element

Level Of Service Computation Report

ICU 1(Loss as Cycle Length %) Method (Base Volume Alternative)

Intersection #63 Standard Ave and 4th St

Cycle (sec): 100 Critical Vol./Cap.(X): 0.893
Loss Time (sec): 5 Average Delay (sec/veh): xxxxxx
Optimal Cycle: 83 Level Of Service: D

Table with 4 columns: North Bound, South Bound, East Bound, West Bound. Rows include Movement (L-T-R), Control, Rights, Min. Green, Y+R, and Lanes.

Volume Module: Table with 12 columns representing different volume categories and 12 rows of adjustment factors like Base Vol, Growth Adj, etc.

Saturation Flow Module: Table with 12 columns and 4 rows showing Sat/Lane, Adjustment, Lanes, and Final Sat.

Capacity Analysis Module: Table with 12 columns and 2 rows showing Vol/Sat and Crit Moves.

Santa Ana Circulation Element

Level Of Service Computation Report

ICU 1(Loss as Cycle Length %) Method (Base Volume Alternative)

Intersection #64 Standard Ave and 1st St

Cycle (sec): 100 Critical Vol./Cap.(X): 0.968
 Loss Time (sec): 5 Average Delay (sec/veh): xxxxxx
 Optimal Cycle: 159 Level Of Service: E

Approach:	North Bound			South Bound			East Bound			West Bound		
Movement:	L	T	R	L	T	R	L	T	R	L	T	R
Control:	Permitted			Permitted			Protected			Protected		
Rights:	Include			Include			Include			Include		
Min. Green:	0	0	0	0	0	0	0	0	0	0	0	0
Y+R:	4.0	4.0	4.0	4.0	4.0	4.0	4.0	4.0	4.0	4.0	4.0	4.0
Lanes:	1	0	1	1	0	1	2	1	0	1	0	2

Volume Module:

Base Vol:	109	724	259	142	679	47	168	1279	65	264	1888	116
Growth Adj:	1.00	1.00	1.00	1.00	1.00	1.00	1.00	1.00	1.00	1.00	1.00	1.00
Initial Bse:	109	724	259	142	679	47	168	1279	65	264	1888	116
User Adj:	1.00	1.00	1.00	1.00	1.00	1.00	1.00	1.00	1.00	1.00	1.00	1.00
PHF Adj:	1.00	1.00	1.00	1.00	1.00	1.00	1.00	1.00	1.00	1.00	1.00	1.00
PHF Volume:	109	724	259	142	679	47	168	1279	65	264	1888	116
Reduct Vol:	0	0	0	0	0	0	0	0	0	0	0	0
Reduced Vol:	109	724	259	142	679	47	168	1279	65	264	1888	116
PCE Adj:	1.00	1.00	1.00	1.00	1.00	1.00	1.00	1.00	1.00	1.00	1.00	1.00
MLF Adj:	1.00	1.00	1.00	1.00	1.00	1.00	1.00	1.00	1.00	1.00	1.00	1.00
FinalVolume:	109	724	259	142	679	47	168	1279	65	264	1888	116

Saturation Flow Module:

Sat/Lane:	1600	1600	1600	1600	1600	1600	1600	1600	1600	1600	1600	1600
Adjustment:	1.00	1.04	1.00	1.00	1.03	1.00	1.00	1.04	1.00	1.00	1.04	1.00
Lanes:	1.00	1.47	0.53	1.00	1.87	0.13	1.00	2.85	0.15	1.00	2.83	0.17
Final Sat.:	1600	2457	843	1600	3093	207	1600	4768	232	1600	4722	278

Capacity Analysis Module:

Vol/Sat:	0.07	0.29	0.31	0.09	0.22	0.23	0.11	0.27	0.28	0.17	0.40	0.42
Crit Moves:			****	****			****			****		

Santa Ana Circulation Element

Level Of Service Computation Report

ICU 1(Loss as Cycle Length %) Method (Base Volume Alternative)

Intersection #65 Standard Ave and Mcfadden Ave

Cycle (sec): 100 Critical Vol./Cap.(X): 0.828
 Loss Time (sec): 5 Average Delay (sec/veh): xxxxxx
 Optimal Cycle: 59 Level Of Service: D

Approach:	North Bound			South Bound			East Bound			West Bound		
Movement:	L	T	R	L	T	R	L	T	R	L	T	R
Control:	Protected			Protected			Protected			Protected		
Rights:	Include			Include			Include			Include		
Min. Green:	0	0	0	0	0	0	0	0	0	0	0	0
Y+R:	4.0	4.0	4.0	4.0	4.0	4.0	4.0	4.0	4.0	4.0	4.0	4.0
Lanes:	1	0	1	1	0	1	1	0	1	1	0	1

Volume Module:

Base Vol:	194	765	94	237	520	90	95	632	108	123	749	217
Growth Adj:	1.00	1.00	1.00	1.00	1.00	1.00	1.00	1.00	1.00	1.00	1.00	1.00
Initial Bse:	194	765	94	237	520	90	95	632	108	123	749	217
User Adj:	1.00	1.00	1.00	1.00	1.00	1.00	1.00	1.00	1.00	1.00	1.00	1.00
PHF Adj:	1.00	1.00	1.00	1.00	1.00	1.00	1.00	1.00	1.00	1.00	1.00	1.00
PHF Volume:	194	765	94	237	520	90	95	632	108	123	749	217
Reduct Vol:	0	0	0	0	0	0	0	0	0	0	0	0
Reduced Vol:	194	765	94	237	520	90	95	632	108	123	749	217
PCE Adj:	1.00	1.00	1.00	1.00	1.00	1.00	1.00	1.00	1.00	1.00	1.00	1.00
MLF Adj:	1.00	1.00	1.00	1.00	1.00	1.00	1.00	1.00	1.00	1.00	1.00	1.00
FinalVolume:	194	765	94	237	520	90	95	632	108	123	749	217

Saturation Flow Module:

Sat/Lane:	1600	1600	1600	1600	1600	1600	1600	1600	1600	1600	1600	1600
Adjustment:	1.00	1.04	1.00	1.00	1.04	1.00	1.00	1.04	1.00	1.00	1.04	1.00
Lanes:	1.00	1.78	0.22	1.00	1.70	0.30	1.00	1.71	0.29	1.00	1.55	0.45
Final Sat.:	1600	2950	350	1600	2828	472	1600	2833	467	1600	2581	719

Capacity Analysis Module:

Vol/Sat:	0.12	0.26	0.27	0.15	0.18	0.19	0.06	0.22	0.23	0.08	0.29	0.30
Crit Moves:			****	****			****			****		

Santa Ana Circulation Element

Level Of Service Computation Report

ICU 1(Loss as Cycle Length %) Method (Base Volume Alternative)

Intersection #66 Halladay St and Warner Ave

Cycle (sec): 100 Critical Vol./Cap.(X): 0.975
Loss Time (sec): 5 Average Delay (sec/veh): xxxxxx
Optimal Cycle: 173 Level Of Service: E

Table with 4 columns: North Bound, South Bound, East Bound, West Bound. Rows include Movement, Control, Rights, Min. Green, Y+R, and Lanes.

Volume Module table with 12 columns representing different volume categories and their values.

Saturation Flow Module table with 12 columns representing saturation flow values.

Capacity Analysis Module table with 12 columns representing capacity analysis values.

Santa Ana Circulation Element

Level Of Service Computation Report

ICU 1(Loss as Cycle Length %) Method (Base Volume Alternative)

Intersection #67 Halladay St and Dyer Rd

Cycle (sec): 100 Critical Vol./Cap.(X): 1.057
 Loss Time (sec): 5 Average Delay (sec/veh): xxxxxx
 Optimal Cycle: 180 Level Of Service: F

Approach:	North Bound			South Bound			East Bound			West Bound		
Movement:	L	T	R	L	T	R	L	T	R	L	T	R
Control:	Split Phase			Split Phase			Protected			Protected		
Rights:	Include			Include			Include			Include		
Min. Green:	0	0	0	0	0	0	0	0	0	0	0	0
Y+R:	4.0	4.0	4.0	4.0	4.0	4.0	4.0	4.0	4.0	4.0	4.0	4.0
Lanes:	1	0	0	1	0	0	1	0	2	1	0	2

Volume Module:

Base Vol:	61	266	307	296	39	83	147	1271	9	51	1655	132
Growth Adj:	1.00	1.00	1.00	1.00	1.00	1.00	1.00	1.00	1.00	1.00	1.00	1.00
Initial Bse:	61	266	307	296	39	83	147	1271	9	51	1655	132
User Adj:	1.00	1.00	1.00	1.00	1.00	1.00	1.00	1.00	1.00	1.00	1.00	1.00
PHF Adj:	1.00	1.00	1.00	1.00	1.00	1.00	1.00	1.00	1.00	1.00	1.00	1.00
PHF Volume:	61	266	307	296	39	83	147	1271	9	51	1655	132
Reduct Vol:	0	0	0	0	0	0	0	0	0	0	0	0
Reduced Vol:	61	266	307	296	39	83	147	1271	9	51	1655	132
PCE Adj:	1.00	1.00	1.00	1.00	1.00	1.00	1.00	1.00	1.00	1.00	1.00	1.00
MLF Adj:	1.00	1.00	1.00	1.00	1.00	1.00	1.00	1.00	1.00	1.00	1.00	1.00
FinalVolume:	61	266	307	296	39	83	147	1271	9	51	1655	132

Saturation Flow Module:

Sat/Lane:	1600	1600	1600	1600	1600	1600	1600	1600	1600	1600	1600	1600
Adjustment:	1.00	1.00	1.00	1.00	1.00	1.00	1.00	1.04	1.00	1.00	1.04	1.00
Lanes:	1.00	0.46	0.54	1.00	0.32	0.68	1.00	2.98	0.02	1.00	2.78	0.22
Final Sat.:	1600	743	857	1600	511	1089	1600	4966	34	1600	4645	355

Capacity Analysis Module:

Vol/Sat:	0.04	0.36	0.36	0.19	0.08	0.08	0.09	0.26	0.27	0.03	0.36	0.37
Crit Moves:			****	****			****					****

Santa Ana Circulation Element

Level Of Service Computation Report
 2000 HCM Operations Method (Base Volume Alternative)

 Intersection #68 SR-55 SB Ramps and MacArthur Blvd

Cycle (sec): 100 Critical Vol./Cap.(X): 0.567
 Loss Time (sec): 5 Average Delay (sec/veh): 17.8
 Optimal Cycle: 28 Level Of Service: B

Approach:	North Bound			South Bound			East Bound			West Bound		
Movement:	L	T	R	L	T	R	L	T	R	L	T	R
Control:	Split Phase			Split Phase			Protected			Protected		
Rights:	Include			Include			Ignore			Ignore		
Min. Green:	0	0	0	0	0	0	0	0	0	0	0	0
Y+R:	4.0	4.0	4.0	4.0	4.0	4.0	4.0	4.0	4.0	4.0	4.0	4.0
Lanes:	0	0	0	2	0	0	0	0	2	1	1	0

Volume Module:

Base Vol:	0	0	0	299	0	724	0	1187	1058	0	1474	579
Growth Adj:	1.00	1.00	1.00	1.00	1.00	1.00	1.00	1.00	1.00	1.00	1.00	1.00
Initial Bse:	0	0	0	299	0	724	0	1187	1058	0	1474	579
User Adj:	1.00	1.00	1.00	1.00	1.00	1.00	1.00	1.00	0.00	1.00	1.00	0.00
PHF Adj:	1.00	1.00	1.00	1.00	1.00	1.00	1.00	1.00	0.00	1.00	1.00	0.00
PHF Volume:	0	0	0	299	0	724	0	1187	0	0	1474	0
Reduct Vol:	0	0	0	0	0	0	0	0	0	0	0	0
Reduced Vol:	0	0	0	299	0	724	0	1187	0	0	1474	0
PCE Adj:	1.00	1.00	1.00	1.00	1.00	1.00	1.00	1.00	0.00	1.00	1.00	0.00
MLF Adj:	1.00	1.00	1.00	1.00	1.00	1.00	1.00	1.00	0.00	1.00	1.00	0.00
FinalVolume:	0	0	0	299	0	724	0	1187	0	0	1474	0

Saturation Flow Module:

Sat/Lane:	1900	1900	1900	1900	1900	1900	1900	1900	1900	1900	1900	1900
Adjustment:	1.00	1.00	1.00	0.92	1.00	0.75	1.00	0.91	0.91	1.00	0.91	1.00
Lanes:	0.00	0.00	0.00	2.00	0.00	2.00	0.00	3.00	1.00	0.00	3.00	1.00
Final Sat.:	0	0	0	3502	0	2842	0	5187	1729	0	5187	1900

Capacity Analysis Module:

Vol/Sat:	0.00	0.00	0.00	0.09	0.00	0.25	0.00	0.23	0.00	0.00	0.28	0.00
Crit Moves:						****	****				****	
Green/Cycle:	0.00	0.00	0.00	0.45	0.00	0.45	0.00	0.50	0.00	0.00	0.50	0.00
Volume/Cap:	0.00	0.00	0.00	0.19	0.00	0.57	0.00	0.46	0.00	0.00	0.57	0.00
Delay/Veh:	0.0	0.0	0.0	16.7	0.0	21.0	0.0	16.3	0.0	0.0	17.7	0.0
User DelAdj:	1.00	1.00	1.00	1.00	1.00	1.00	1.00	1.00	1.00	1.00	1.00	1.00
AdjDel/Veh:	0.0	0.0	0.0	16.7	0.0	21.0	0.0	16.3	0.0	0.0	17.7	0.0
LOS by Move:	A	A	A	B	A	C	A	B	A	A	B	A
HCM2k85thQ:	0	0	0	4	0	15	0	13	0	0	18	0

 Note: Queue reported is the number of cars per lane.

Santa Ana Circulation Element

Level Of Service Computation Report
 2000 HCM Operations Method (Base Volume Alternative)

 Intersection #69 SR-55 NB Ramps and MacArthur Blvd

Cycle (sec): 100 Critical Vol./Cap.(X): 0.484
 Loss Time (sec): 5 Average Delay (sec/veh): 14.6
 Optimal Cycle: 24 Level Of Service: B

Approach:	North Bound			South Bound			East Bound			West Bound		
Movement:	L	T	R	L	T	R	L	T	R	L	T	R
Control:	Split Phase			Split Phase			Protected			Protected		
Rights:	Ignore			Include			Ignore			Ignore		
Min. Green:	0	0	0	0	0	0	0	0	0	0	0	0
Y+R:	4.0	4.0	4.0	4.0	4.0	4.0	4.0	4.0	4.0	4.0	4.0	4.0
Lanes:	2	0	0	0	0	0	0	0	2	0	0	3

Volume Module:

Base Vol:	620	0	412	0	0	0	0	711	731	0	1467	1056
Growth Adj:	1.00	1.00	1.00	1.00	1.00	1.00	1.00	1.00	1.00	1.00	1.00	1.00
Initial Bse:	620	0	412	0	0	0	0	711	731	0	1467	1056
User Adj:	1.00	1.00	0.00	1.00	1.00	1.00	1.00	1.00	0.00	1.00	1.00	0.00
PHF Adj:	1.00	1.00	0.00	1.00	1.00	1.00	1.00	1.00	0.00	1.00	1.00	0.00
PHF Volume:	620	0	0	0	0	0	0	711	0	0	1467	0
Reduct Vol:	0	0	0	0	0	0	0	0	0	0	0	0
Reduced Vol:	620	0	0	0	0	0	0	711	0	0	1467	0
PCE Adj:	1.00	1.00	0.00	1.00	1.00	1.00	1.00	1.00	0.00	1.00	1.00	0.00
MLF Adj:	1.00	1.00	0.00	1.00	1.00	1.00	1.00	1.00	0.00	1.00	1.00	0.00
FinalVolume:	620	0	0	0	0	0	0	711	0	0	1467	0

Saturation Flow Module:

Sat/Lane:	1900	1900	1900	1900	1900	1900	1900	1900	1900	1900	1900	1900
Adjustment:	0.92	1.00	1.00	1.00	1.00	1.00	1.00	0.95	0.88	1.00	0.91	1.00
Lanes:	2.00	0.00	1.00	0.00	0.00	0.00	0.00	2.00	2.00	0.00	3.00	1.00
Final Sat.:	3502	0	1900	0	0	0	0	3610	3344	0	5187	1900

Capacity Analysis Module:

Vol/Sat:	0.18	0.00	0.00	0.00	0.00	0.00	0.00	0.20	0.00	0.00	0.28	0.00
Crit Moves:	****						****			****		
Green/Cycle:	0.37	0.00	0.00	0.00	0.00	0.00	0.00	0.58	0.00	0.00	0.58	0.00
Volume/Cap:	0.48	0.00	0.00	0.00	0.00	0.00	0.00	0.34	0.00	0.00	0.48	0.00
Delay/Veh:	24.7	0.0	0.0	0.0	0.0	0.0	0.0	10.9	0.0	0.0	12.2	0.0
User DelAdj:	1.00	1.00	1.00	1.00	1.00	1.00	1.00	1.00	1.00	1.00	1.00	1.00
AdjDel/Veh:	24.7	0.0	0.0	0.0	0.0	0.0	0.0	10.9	0.0	0.0	12.2	0.0
LOS by Move:	C	A	A	A	A	A	A	B	A	A	B	A
HCM2k85thQ:	12	0	0	0	0	0	0	9	0	0	15	0

 Note: Queue reported is the number of cars per lane.

Santa Ana Circulation Element

Level Of Service Computation Report
 2000 HCM Operations Method (Base Volume Alternative)

 Intersection #70 SR-55 SB Ramps and Dyer Rd

Cycle (sec): 100 Critical Vol./Cap.(X): 0.663
 Loss Time (sec): 5 Average Delay (sec/veh): 26.5
 Optimal Cycle: 35 Level Of Service: C

Approach:	North Bound			South Bound			East Bound			West Bound		
Movement:	L	T	R	L	T	R	L	T	R	L	T	R
Control:	Split Phase			Split Phase			Protected			Protected		
Rights:	Ovl			Include			Include			Include		
Min. Green:	0	0	0	0	0	0	0	0	0	0	0	0
Y+R:	4.0	4.0	4.0	4.0	4.0	4.0	4.0	4.0	4.0	4.0	4.0	4.0
Lanes:	1	1	0	0	1	1	0	3	0	2	0	3

Volume Module:

Base Vol:	386	12	291	103	226	110	59	1379	187	566	1008	65
Growth Adj:	1.00	1.00	1.00	1.00	1.00	1.00	1.00	1.00	1.00	1.00	1.00	1.00
Initial Bse:	386	12	291	103	226	110	59	1379	187	566	1008	65
User Adj:	1.00	1.00	1.00	1.00	1.00	1.00	1.00	1.00	1.00	1.00	1.00	1.00
PHF Adj:	1.00	1.00	1.00	1.00	1.00	1.00	1.00	1.00	1.00	1.00	1.00	1.00
PHF Volume:	386	12	291	103	226	110	59	1379	187	566	1008	65
Reduct Vol:	0	0	0	0	0	0	0	0	0	0	0	0
Reduced Vol:	386	12	291	103	226	110	59	1379	187	566	1008	65
PCE Adj:	1.00	1.00	1.00	1.00	1.00	1.00	1.00	1.00	1.00	1.00	1.00	1.00
MLF Adj:	1.00	1.00	1.00	1.00	1.00	1.00	1.00	1.00	1.00	1.00	1.00	1.00
FinalVolume:	386	12	291	103	226	110	59	1379	187	566	1008	65

Saturation Flow Module:

Sat/Lane:	1900	1900	1900	1900	1900	1900	1900	1900	1900	1900	1900	1900
Adjustment:	0.95	0.95	0.75	0.94	0.94	0.85	0.95	0.91	0.85	0.92	0.91	0.85
Lanes:	1.94	0.06	2.00	0.63	1.37	1.00	1.00	3.00	1.00	2.00	3.00	1.00
Final Sat.:	3516	109	2842	1113	2443	1615	1805	5187	1615	3502	5187	1615

Capacity Analysis Module:

Vol/Sat:	0.11	0.11	0.10	0.09	0.09	0.07	0.03	0.27	0.12	0.16	0.19	0.04
Crit Moves:	****			****			****			****		
Green/Cycle:	0.17	0.17	0.41	0.14	0.14	0.14	0.09	0.40	0.40	0.24	0.55	0.55
Volume/Cap:	0.66	0.66	0.25	0.66	0.66	0.49	0.35	0.66	0.29	0.66	0.35	0.07
Delay/Veh:	41.9	41.9	19.5	44.1	44.1	41.4	43.8	25.2	20.5	36.1	12.5	10.5
User DelAdj:	1.00	1.00	1.00	1.00	1.00	1.00	1.00	1.00	1.00	1.00	1.00	1.00
AdjDel/Veh:	41.9	41.9	19.5	44.1	44.1	41.4	43.8	25.2	20.5	36.1	12.5	10.5
LOS by Move:	D	D	B	D	D	D	D	C	C	D	B	B
HCM2k85thQ:	11	11	5	10	10	6	3	20	6	14	10	1

 Note: Queue reported is the number of cars per lane.

Santa Ana Circulation Element

Level Of Service Computation Report

ICU 1(Loss as Cycle Length %) Method (Base Volume Alternative)

Intersection #71 Glassell St and La Veta Ave

Cycle (sec): 100 Critical Vol./Cap.(X): 0.744
 Loss Time (sec): 5 Average Delay (sec/veh): xxxxxx
 Optimal Cycle: 43 Level Of Service: C

Approach:	North Bound			South Bound			East Bound			West Bound		
Movement:	L	T	R	L	T	R	L	T	R	L	T	R
Control:	Protected			Protected			Protected			Protected		
Rights:	Ovl			Include			Ovl			Include		
Min. Green:	0	0	0	0	0	0	0	0	0	0	0	0
Y+R:	4.0	4.0	4.0	4.0	4.0	4.0	4.0	4.0	4.0	4.0	4.0	4.0
Lanes:	2	0	1	0	1	0	1	0	1	0	1	0

Volume Module:

Base Vol:	573	595	194	14	471	35	106	346	594	211	382	15
Growth Adj:	1.00	1.00	1.00	1.00	1.00	1.00	1.00	1.00	1.00	1.00	1.00	1.00
Initial Bse:	573	595	194	14	471	35	106	346	594	211	382	15
User Adj:	1.00	1.00	1.00	1.00	1.00	1.00	1.00	1.00	1.00	1.00	1.00	1.00
PHF Adj:	1.00	1.00	1.00	1.00	1.00	1.00	1.00	1.00	1.00	1.00	1.00	1.00
PHF Volume:	573	595	194	14	471	35	106	346	594	211	382	15
Reduct Vol:	0	0	0	0	0	0	0	0	0	0	0	0
Reduced Vol:	573	595	194	14	471	35	106	346	594	211	382	15
PCE Adj:	1.00	1.00	1.00	1.00	1.00	1.00	1.00	1.00	1.00	1.00	1.00	1.00
MLF Adj:	1.00	1.00	1.00	1.00	1.00	1.00	1.00	1.00	1.00	1.00	1.00	1.00
FinalVolume:	573	595	194	14	471	35	106	346	594	211	382	15
OvlAdjVol:	0									308		

Saturation Flow Module:

Sat/Lane:	1600	1600	1600	1600	1600	1600	1600	1600	1600	1600	1600	1600
Adjustment:	1.00	1.06	1.00	1.00	1.03	1.00	1.00	1.06	1.00	1.00	1.03	1.00
Lanes:	2.00	1.00	1.00	1.00	1.86	0.14	1.00	1.00	1.00	1.00	1.92	0.08
Final Sat.:	3200	1700	1600	1600	3079	221	1600	1700	1600	1600	3179	121

Capacity Analysis Module:

Vol/Sat:	0.18	0.35	0.12	0.01	0.15	0.16	0.07	0.20	0.37	0.13	0.12	0.12
OvlAdjV/S:	0.00									0.19		
Crit Moves:	****			****			****			****		

Santa Ana Circulation Element

Level Of Service Computation Report
 2000 HCM Operations Method (Base Volume Alternative)

 Intersection #72 Glassell St and SR-22 WB Ramps

Cycle (sec): 100 Critical Vol./Cap.(X): 0.910
 Loss Time (sec): 5 Average Delay (sec/veh): 30.5
 Optimal Cycle: 96 Level Of Service: C

Approach:	North Bound			South Bound			East Bound			West Bound		
Movement:	L	T	R	L	T	R	L	T	R	L	T	R
Control:	Protected			Permitted			Split Phase			Split Phase		
Rights:	Include			Include			Include			Include		
Min. Green:	0	0	0	0	0	0	0	0	0	0	0	0
Y+R:	4.0	4.0	4.0	4.0	4.0	4.0	4.0	4.0	4.0	4.0	4.0	4.0
Lanes:	1	0	2	0	0	2	0	0	0	1	0	1

Volume Module:

Base Vol:	660	1079	0	0	1007	293	0	0	0	251	9	446
Growth Adj:	1.00	1.00	1.00	1.00	1.00	1.00	1.00	1.00	1.00	1.00	1.00	1.00
Initial Bse:	660	1079	0	0	1007	293	0	0	0	251	9	446
User Adj:	1.00	1.00	1.00	1.00	1.00	1.00	1.00	1.00	1.00	1.00	1.00	1.00
PHF Adj:	1.00	1.00	1.00	1.00	1.00	1.00	1.00	1.00	1.00	1.00	1.00	1.00
PHF Volume:	660	1079	0	0	1007	293	0	0	0	251	9	446
Reduct Vol:	0	0	0	0	0	0	0	0	0	0	0	0
Reduced Vol:	660	1079	0	0	1007	293	0	0	0	251	9	446
PCE Adj:	1.00	1.00	1.00	1.00	1.00	1.00	1.00	1.00	1.00	1.00	1.00	1.00
MLF Adj:	1.00	1.00	1.00	1.00	1.00	1.00	1.00	1.00	1.00	1.00	1.00	1.00
Final Volume:	660	1079	0	0	1007	293	0	0	0	251	9	446

Saturation Flow Module:

Sat/Lane:	1900	1900	1900	1900	1900	1900	1900	1900	1900	1900	1900	1900
Adjustment:	0.95	0.95	1.00	1.00	0.95	0.85	1.00	1.00	1.00	0.86	0.86	0.86
Lanes:	1.00	2.00	0.00	0.00	2.00	1.00	0.00	0.00	0.00	1.35	0.03	1.62
Final Sat.:	1805	3610	0	0	3610	1615	0	0	0	2200	41	2644

Capacity Analysis Module:

Vol/Sat:	0.37	0.30	0.00	0.00	0.28	0.18	0.00	0.00	0.00	0.11	0.22	0.17
Crit Moves:	****				****					****		
Green/Cycle:	0.40	0.71	0.00	0.00	0.31	0.31	0.00	0.00	0.00	0.24	0.24	0.24
Volume/Cap:	0.91	0.42	0.00	0.00	0.91	0.59	0.00	0.00	0.00	0.47	0.91	0.70
Delay/Veh:	43.7	6.2	0.0	0.0	44.3	31.3	0.0	0.0	0.0	32.7	51.5	36.8
User DelAdj:	1.00	1.00	1.00	1.00	1.00	1.00	1.00	1.00	1.00	1.00	1.00	1.00
AdjDel/Veh:	43.7	6.2	0.0	0.0	44.3	31.3	0.0	0.0	0.0	32.7	51.5	36.8
LOS by Move:	D	A	A	A	D	C	A	A	A	C	D	D
HCM2k85thQ:	33	11	0	0	29	13	0	0	0	8	21	14

 Note: Queue reported is the number of cars per lane.

Santa Ana Circulation Element

Level of Service Computation Report
 2000 HCM Operations Method (Base Volume Alternative)

 Intersection #73 Grand Ave / Glassell St and SR-22 EB Ramps

Cycle (sec): 100 Critical Vol./Cap.(X): 0.931
 Loss Time (sec): 5 Average Delay (sec/veh): 31.6
 Optimal Cycle: 113 Level of Service: C

Approach:	North Bound			South Bound			East Bound			West Bound		
Movement:	L	T	R	L	T	R	L	T	R	L	T	R
Control:	Permitted			Protected			Split Phase			Split Phase		
Rights:	Include			Include			Include			Include		
Min. Green:	0	0	0	0	0	0	0	0	0	0	0	0
Y+R:	4.0	4.0	4.0	4.0	4.0	4.0	4.0	4.0	4.0	4.0	4.0	4.0
Lanes:	0	0	2	0	1	0	1	0	1	0	0	0

Volume Module:	North Bound			South Bound			East Bound			West Bound		
Base Vol:	0	1450	370	461	824	0	229	4	503	0	0	0
Growth Adj:	1.00	1.00	1.00	1.00	1.00	1.00	1.00	1.00	1.00	1.00	1.00	1.00
Initial Bse:	0	1450	370	461	824	0	229	4	503	0	0	0
User Adj:	1.00	1.00	1.00	1.00	1.00	1.00	1.00	1.00	1.00	1.00	1.00	1.00
PHF Adj:	1.00	1.00	1.00	1.00	1.00	1.00	1.00	1.00	1.00	1.00	1.00	1.00
PHF Volume:	0	1450	370	461	824	0	229	4	503	0	0	0
Reduct Vol:	0	0	0	0	0	0	0	0	0	0	0	0
Reduced Vol:	0	1450	370	461	824	0	229	4	503	0	0	0
PCE Adj:	1.00	1.00	1.00	1.00	1.00	1.00	1.00	1.00	1.00	1.00	1.00	1.00
MLF Adj:	1.00	1.00	1.00	1.00	1.00	1.00	1.00	1.00	1.00	1.00	1.00	1.00
Final Volume:	0	1450	370	461	824	0	229	4	503	0	0	0

Saturation Flow Module:	North Bound			South Bound			East Bound			West Bound		
Sat/Lane:	1900	1900	1900	1900	1900	1900	1900	1900	1900	1900	1900	1900
Adjustment:	1.00	0.95	0.85	0.95	0.95	1.00	0.86	0.86	0.86	1.00	1.00	1.00
Lanes:	0.00	2.00	1.00	1.00	2.00	0.00	1.31	0.01	1.68	0.00	0.00	0.00
Final Sat.:	0	3610	1615	1805	3610	0	2129	18	2731	0	0	0

Capacity Analysis Module:	North Bound			South Bound			East Bound			West Bound		
Vol/Sat:	0.00	0.40	0.23	0.26	0.23	0.00	0.11	0.23	0.18	0.00	0.00	0.00
Crit Moves:	****			****			****			****		
Green/Cycle:	0.00	0.43	0.43	0.27	0.71	0.00	0.24	0.24	0.24	0.00	0.00	0.00
Volume/Cap:	0.00	0.93	0.53	0.93	0.32	0.00	0.44	0.93	0.75	0.00	0.00	0.00
Delay/Veh:	0.0	37.4	21.8	59.8	5.7	0.0	32.2	54.5	38.4	0.0	0.0	0.0
User DelAdj:	1.00	1.00	1.00	1.00	1.00	1.00	1.00	1.00	1.00	1.00	1.00	1.00
AdjDel/Veh:	0.0	37.4	21.8	59.8	5.7	0.0	32.2	54.5	38.4	0.0	0.0	0.0
LOS by Move:	A	D	C	E	A	A	C	D	D	A	A	A
HCM2k85thQ:	0	38	13	27	8	0	8	23	15	0	0	0

Note: Queue reported is the number of cars per lane.

Santa Ana Circulation Element

Level Of Service Computation Report

ICU 1(Loss as Cycle Length %) Method (Base Volume Alternative)

Intersection #74 Grand Ave and Fairhaven Ave

Cycle (sec): 100 Critical Vol./Cap.(X): 0.717
 Loss Time (sec): 5 Average Delay (sec/veh): xxxxxx
 Optimal Cycle: 39 Level Of Service: C

Approach:	North Bound			South Bound			East Bound			West Bound		
Movement:	L	T	R	L	T	R	L	T	R	L	T	R
Control:	Protected			Protected			Permitted			Permitted		
Rights:	Include			Include			Include			Include		
Min. Green:	0	0	0	0	0	0	0	0	0	0	0	0
Y+R:	4.0	4.0	4.0	4.0	4.0	4.0	4.0	4.0	4.0	4.0	4.0	4.0
Lanes:	1	0	2	1	0	2	1	0	1	1	0	1

Volume Module:

Base Vol:	54	1420	284	242	974	89	79	45	33	221	42	157
Growth Adj:	1.00	1.00	1.00	1.00	1.00	1.00	1.00	1.00	1.00	1.00	1.00	1.00
Initial Bse:	54	1420	284	242	974	89	79	45	33	221	42	157
User Adj:	1.00	1.00	1.00	1.00	1.00	1.00	1.00	1.00	1.00	1.00	1.00	1.00
PHF Adj:	1.00	1.00	1.00	1.00	1.00	1.00	1.00	1.00	1.00	1.00	1.00	1.00
PHF Volume:	54	1420	284	242	974	89	79	45	33	221	42	157
Reduct Vol:	0	0	0	0	0	0	0	0	0	0	0	0
Reduced Vol:	54	1420	284	242	974	89	79	45	33	221	42	157
PCE Adj:	1.00	1.00	1.00	1.00	1.00	1.00	1.00	1.00	1.00	1.00	1.00	1.00
MLF Adj:	1.00	1.00	1.00	1.00	1.00	1.00	1.00	1.00	1.00	1.00	1.00	1.00
Final Volume:	54	1420	284	242	974	89	79	45	33	221	42	157

Saturation Flow Module:

Sat/Lane:	1600	1600	1600	1600	1600	1600	1600	1600	1600	1600	1600	1600
Adjustment:	1.00	1.05	1.00	1.00	1.05	1.00	1.00	1.05	1.00	1.00	1.06	1.00
Lanes:	1.00	2.50	0.50	1.00	2.75	0.25	1.00	1.15	0.85	1.00	1.00	1.00
Final Sat.:	1600	4200	800	1600	4598	402	1600	1946	1354	1600	1700	1600

Capacity Analysis Module:

Vol/Sat:	0.03	0.34	0.36	0.15	0.21	0.22	0.05	0.02	0.02	0.14	0.02	0.10
Crit Moves:			****	****			****			****		

Santa Ana Circulation Element

Level Of Service Computation Report

ICU 1(Loss as Cycle Length %) Method (Base Volume Alternative)

Intersection #75 Grand Ave and Santa Clara Ave

Cycle (sec): 100 Critical Vol./Cap.(X): 0.808
 Loss Time (sec): 5 Average Delay (sec/veh): xxxxxx
 Optimal Cycle: 54 Level Of Service: D

Approach:	North Bound			South Bound			East Bound			West Bound		
Movement:	L	T	R	L	T	R	L	T	R	L	T	R
Control:	Protected			Protected			Permitted			Permitted		
Rights:	Include			WideBypass			Include			Include		
Min. Green:	0	0	0	0	0	0	0	0	0	0	0	0
Y+R:	4.0	4.0	4.0	4.0	4.0	4.0	4.0	4.0	4.0	4.0	4.0	4.0
Lanes:	1	0	2	1	0	2	1	0	0	1	0	1

Volume Module:

Base Vol:	103	1386	288	240	946	240	114	139	26	157	282	300
Growth Adj:	1.00	1.00	1.00	1.00	1.00	1.00	1.00	1.00	1.00	1.00	1.00	1.00
Initial Bse:	103	1386	288	240	946	240	114	139	26	157	282	300
User Adj:	1.00	1.00	1.00	1.00	1.00	1.00	1.00	1.00	1.00	1.00	1.00	1.00
PHF Adj:	1.00	1.00	1.00	1.00	1.00	1.00	1.00	1.00	1.00	1.00	1.00	1.00
PHF Volume:	103	1386	288	240	946	240	114	139	26	157	282	300
Reduct Vol:	0	0	0	0	0	0	0	0	0	0	0	0
Reduced Vol:	103	1386	288	240	946	240	114	139	26	157	282	300
PCE Adj:	1.00	1.00	1.00	1.00	1.00	1.00	1.00	1.00	1.00	1.00	1.00	1.00
MLF Adj:	1.00	1.00	1.00	1.00	1.00	1.00	1.00	1.00	1.00	1.00	1.00	1.00
FinalVolume:	103	1386	288	240	946	240	114	139	26	157	282	300

Saturation Flow Module:

Sat/Lane:	1600	1600	1600	1600	1600	1600	1600	1600	1600	1600	1600	1600
Adjustment:	1.00	1.05	1.00	1.00	1.05	1.00	1.00	1.00	1.00	1.00	1.06	1.00
Lanes:	1.00	2.48	0.52	1.00	2.39	0.61	1.00	0.84	0.16	1.00	1.00	1.00
Final Sat.:	1600	4174	826	1600	4029	971	1600	1348	252	1600	1700	1600

Capacity Analysis Module:

Vol/Sat:	0.06	0.33	0.35	0.15	0.23	0.25	0.07	0.10	0.10	0.10	0.17	0.19
Crit Moves:			****	****			****					****

Santa Ana Circulation Element

Level Of Service Computation Report

ICU 1(Loss as Cycle Length %) Method (Base Volume Alternative)

Intersection #76 Grand Ave and 17th St

Cycle (sec): 100 Critical Vol./Cap.(X): 0.856
 Loss Time (sec): 5 Average Delay (sec/veh): xxxxxx
 Optimal Cycle: 67 Level Of Service: D

Approach:	North Bound			South Bound			East Bound			West Bound		
Movement:	L	T	R	L	T	R	L	T	R	L	T	R
Control:	Protected			Protected			Protected			Protected		
Rights:	Include			Include			Include			Include		
Min. Green:	0	0	0	0	0	0	0	0	0	0	0	0
Y+R:	4.0	4.0	4.0	4.0	4.0	4.0	4.0	4.0	4.0	4.0	4.0	4.0
Lanes:	1	0	2	1	0	2	2	0	2	1	0	2

-----|-----|-----|-----|

Volume Module:

Base Vol:	288	1026	259	294	634	140	321	823	138	279	1031	187
Growth Adj:	1.00	1.00	1.00	1.00	1.00	1.00	1.00	1.00	1.00	1.00	1.00	1.00
Initial Bse:	288	1026	259	294	634	140	321	823	138	279	1031	187
User Adj:	1.00	1.00	1.00	1.00	1.00	1.00	1.00	1.00	1.00	1.00	1.00	1.00
PHF Adj:	1.00	1.00	1.00	1.00	1.00	1.00	1.00	1.00	1.00	1.00	1.00	1.00
PHF Volume:	288	1026	259	294	634	140	321	823	138	279	1031	187
Reduct Vol:	0	0	0	0	0	0	0	0	0	0	0	0
Reduced Vol:	288	1026	259	294	634	140	321	823	138	279	1031	187
PCE Adj:	1.00	1.00	1.00	1.00	1.00	1.00	1.00	1.00	1.00	1.00	1.00	1.00
MLF Adj:	1.00	1.00	1.00	1.00	1.00	1.00	1.00	1.00	1.00	1.00	1.00	1.00
Final Volume:	288	1026	259	294	634	140	321	823	138	279	1031	187

-----|-----|-----|-----|

Saturation Flow Module:

Sat/Lane:	1600	1600	1600	1600	1600	1600	1600	1600	1600	1600	1600	1600
Adjustment:	1.00	1.05	1.00	1.00	1.05	1.00	1.00	1.05	1.00	1.00	1.05	1.00
Lanes:	1.00	2.40	0.60	1.00	2.46	0.54	2.00	2.57	0.43	2.00	2.54	0.46
Final Sat.:	1600	4033	967	1600	4132	868	3200	4311	689	3200	4263	737

-----|-----|-----|-----|

Capacity Analysis Module:

Vol/Sat:	0.18	0.25	0.27	0.18	0.15	0.16	0.10	0.19	0.20	0.09	0.24	0.25
Crit Moves:			****	****			****					****

Santa Ana Circulation Element

Level Of Service Computation Report
 2000 HCM Operations Method (Base Volume Alternative)

 Intersection #77 Grand Ave and I-5 NB Ramps

Cycle (sec): 100 Critical Vol./Cap.(X): 0.696
 Loss Time (sec): 5 Average Delay (sec/veh): 10.1
 Optimal Cycle: 38 Level Of Service: B

Approach: North Bound South Bound East Bound West Bound
 Movement: L - T - R L - T - R L - T - R L - T - R

Control:	Protected			Protected			Split Phase			Split Phase					
Rights:	Ignore			Include			Include			Include					
Min. Green:	0	0	0	0	0	0	0	0	0	0	0	0			
Y+R:	4.0	4.0	4.0	4.0	4.0	4.0	4.0	4.0	4.0	4.0	4.0	4.0			
Lanes:	0	0	2	0	1	1	0	3	0	0	0	0	0	0	1

Volume Module:

Base Vol:	0	1855	1432	62	1501	0	0	0	0	151	0	182
Growth Adj:	1.00	1.00	1.00	1.00	1.00	1.00	1.00	1.00	1.00	1.00	1.00	1.00
Initial Bse:	0	1855	1432	62	1501	0	0	0	0	151	0	182
User Adj:	1.00	1.00	0.00	1.00	1.00	1.00	1.00	1.00	1.00	1.00	1.00	1.00
PHF Adj:	1.00	1.00	0.00	1.00	1.00	1.00	1.00	1.00	1.00	1.00	1.00	1.00
PHF Volume:	0	1855	0	62	1501	0	0	0	0	151	0	182
Reduct Vol:	0	0	0	0	0	0	0	0	0	0	0	0
Reduced Vol:	0	1855	0	62	1501	0	0	0	0	151	0	182
PCE Adj:	1.00	1.00	0.00	1.00	1.00	1.00	1.00	1.00	1.00	1.00	1.00	1.00
MLF Adj:	1.00	1.00	0.00	1.00	1.00	1.00	1.00	1.00	1.00	1.00	1.00	1.00
FinalVolume:	0	1855	0	62	1501	0	0	0	0	151	0	182

Saturation Flow Module:

Sat/Lane:	1900	1900	1900	1900	1900	1900	1900	1900	1900	1900	1900	1900
Adjustment:	1.00	0.95	1.00	0.95	0.91	1.00	1.00	1.00	1.00	0.92	1.00	0.85
Lanes:	0.00	2.00	1.00	1.00	3.00	0.00	0.00	0.00	0.00	2.00	0.00	1.00
Final Sat.:	0	3610	1900	1805	5187	0	0	0	0	3502	0	1615

Capacity Analysis Module:

Vol/Sat:	0.00	0.51	0.00	0.03	0.29	0.00	0.00	0.00	0.00	0.04	0.00	0.11
Crit Moves:	****			****						****		
Green/Cycle:	0.00	0.74	0.00	0.05	0.79	0.00	0.00	0.00	0.00	0.16	0.00	0.16
Volume/Cap:	0.00	0.70	0.00	0.70	0.37	0.00	0.00	0.00	0.00	0.27	0.00	0.70
Delay/Veh:	0.0	7.8	0.0	68.1	3.2	0.0	0.0	0.0	0.0	36.9	0.0	47.5
User DelAdj:	1.00	1.00	1.00	1.00	1.00	1.00	1.00	1.00	1.00	1.00	1.00	1.00
AdjDel/Veh:	0.0	7.8	0.0	68.1	3.2	0.0	0.0	0.0	0.0	36.9	0.0	47.5
LOS by Move:	A	A	A	E	A	A	A	A	A	D	A	D
HCM2k85thQ:	0	25	0	5	8	0	0	0	0	4	0	10

Note: Queue reported is the number of cars per lane.

Santa Ana Circulation Element

Level Of Service Computation Report
 2000 HCM Operations Method (Base Volume Alternative)

 Intersection #78 Grand Ave and Santa Ana Blvd

Cycle (sec): 100 Critical Vol./Cap.(X): 0.721
 Loss Time (sec): 5 Average Delay (sec/veh): 25.3
 Optimal Cycle: 41 Level Of Service: C

Approach:	North Bound			South Bound			East Bound			West Bound		
Movement:	L	T	R	L	T	R	L	T	R	L	T	R
Control:	Protected			Protected			Split Phase			Split Phase		
Rights:	Include			Ovl			Include			Include		
Min. Green:	0	0	0	0	0	0	0	0	0	0	0	0
Y+R:	4.0	4.0	4.0	4.0	4.0	4.0	4.0	4.0	4.0	4.0	4.0	4.0
Lanes:	1	0	2	1	0	2	2	0	1	0	1	0

Volume Module:

Base Vol:	185	2091	34	38	839	595	377	230	363	34	228	165
Growth Adj:	1.00	1.00	1.00	1.00	1.00	1.00	1.00	1.00	1.00	1.00	1.00	1.00
Initial Bse:	185	2091	34	38	839	595	377	230	363	34	228	165
User Adj:	1.00	1.00	1.00	1.00	1.00	1.00	1.00	1.00	1.00	1.00	1.00	1.00
PHF Adj:	1.00	1.00	1.00	1.00	1.00	1.00	1.00	1.00	1.00	1.00	1.00	1.00
PHF Volume:	185	2091	34	38	839	595	377	230	363	34	228	165
Reduct Vol:	0	0	0	0	0	0	0	0	0	0	0	0
Reduced Vol:	185	2091	34	38	839	595	377	230	363	34	228	165
PCE Adj:	1.00	1.00	1.00	1.00	1.00	1.00	1.00	1.00	1.00	1.00	1.00	1.00
MLF Adj:	1.00	1.00	1.00	1.00	1.00	1.00	1.00	1.00	1.00	1.00	1.00	1.00
Final Volume:	185	2091	34	38	839	595	377	230	363	34	228	165

Saturation Flow Module:

Sat/Lane:	1900	1900	1900	1900	1900	1900	1900	1900	1900	1900	1900	1900
Adjustment:	0.95	0.91	0.91	0.95	0.95	0.75	0.92	1.00	0.75	0.89	0.89	0.89
Lanes:	1.00	2.95	0.05	1.00	2.00	2.00	2.00	1.00	2.00	0.16	1.07	0.77
Final Sat.:	1805	5094	83	1805	3610	2842	3502	1900	2842	270	1809	1309

Capacity Analysis Module:

Vol/Sat:	0.10	0.41	0.41	0.02	0.23	0.21	0.11	0.12	0.13	0.13	0.13	0.13
Crit Moves:	****			****			****			****		
Green/Cycle:	0.18	0.57	0.57	0.03	0.42	0.59	0.18	0.18	0.18	0.17	0.17	0.17
Volume/Cap:	0.56	0.72	0.72	0.72	0.56	0.35	0.61	0.68	0.72	0.72	0.72	0.72
Delay/Veh:	39.3	16.6	16.6	86.7	22.8	10.6	39.7	44.2	43.9	43.3	43.3	43.3
User DelAdj:	1.00	1.00	1.00	1.00	1.00	1.00	1.00	1.00	1.00	1.00	1.00	1.00
AdjDel/Veh:	39.3	16.6	16.6	86.7	22.8	10.6	39.7	44.2	43.9	43.3	43.3	43.3
LOS by Move:	D	B	B	F	C	B	D	D	D	D	D	D
HCM2k85thQ:	9	27	27	4	16	8	10	12	12	12	12	12

Note: Queue reported is the number of cars per lane.

Santa Ana Circulation Element

Level Of Service Computation Report

ICU 1(Loss as Cycle Length %) Method (Base Volume Alternative)

Intersection #79 Grand Ave and 1st St

Cycle (sec): 100 Critical Vol./Cap.(X): 0.731
 Loss Time (sec): 5 Average Delay (sec/veh): xxxxxx
 Optimal Cycle: 41 Level Of Service: C

Approach:	North Bound			South Bound			East Bound			West Bound		
Movement:	L	T	R	L	T	R	L	T	R	L	T	R
Control:	Protected			Protected			Protected			Protected		
Rights:	Include			Include			Include			Include		
Min. Green:	0	0	0	0	0	0	0	0	0	0	0	0
Y+R:	4.0	4.0	4.0	4.0	4.0	4.0	4.0	4.0	4.0	4.0	4.0	4.0
Lanes:	2	0	2	1	0	0	2	0	2	1	0	0

Volume Module:

Base Vol:	188	1435	43	113	667	266	326	1080	107	154	958	176
Growth Adj:	1.00	1.00	1.00	1.00	1.00	1.00	1.00	1.00	1.00	1.00	1.00	1.00
Initial Bse:	188	1435	43	113	667	266	326	1080	107	154	958	176
User Adj:	1.00	1.00	1.00	1.00	1.00	1.00	1.00	1.00	1.00	1.00	1.00	1.00
PHF Adj:	1.00	1.00	1.00	1.00	1.00	1.00	1.00	1.00	1.00	1.00	1.00	1.00
PHF Volume:	188	1435	43	113	667	266	326	1080	107	154	958	176
Reduct Vol:	0	0	0	0	0	0	0	0	0	0	0	0
Reduced Vol:	188	1435	43	113	667	266	326	1080	107	154	958	176
PCE Adj:	1.00	1.00	1.00	1.00	1.00	1.00	1.00	1.00	1.00	1.00	1.00	1.00
MLF Adj:	1.00	1.00	1.00	1.00	1.00	1.00	1.00	1.00	1.00	1.00	1.00	1.00
FinalVolume:	188	1435	43	113	667	266	326	1080	107	154	958	176

Saturation Flow Module:

Sat/Lane:	1600	1600	1600	1600	1600	1600	1600	1600	1600	1600	1600	1600
Adjustment:	1.00	1.04	1.00	1.00	1.06	1.00	1.00	1.05	1.00	1.00	1.05	1.00
Lanes:	2.00	2.91	0.09	2.00	3.00	1.00	2.00	2.73	0.27	2.00	2.53	0.47
Final Sat.:	3200	4860	140	3200	5100	1600	3200	4567	433	3200	4255	745

Capacity Analysis Module:

Vol/Sat:	0.06	0.30	0.31	0.04	0.13	0.17	0.10	0.24	0.25	0.05	0.23	0.24
Crit Moves:		****	****		****	****		****	****		****	****

Santa Ana Circulation Element

Level Of Service Computation Report

ICU 1(Loss as Cycle Length %) Method (Base Volume Alternative)

Intersection #80 Grand Ave and Chestnut Ave

Cycle (sec): 100 Critical Vol./Cap.(X): 0.688
 Loss Time (sec): 5 Average Delay (sec/veh): xxxxxx
 Optimal Cycle: 36 Level Of Service: B

Approach:	North Bound			South Bound			East Bound			West Bound		
Movement:	L	T	R	L	T	R	L	T	R	L	T	R
Control:	Protected			Protected			Permitted			Permitted		
Rights:	Include			Include			Include			Include		
Min. Green:	0	0	0	0	0	0	0	0	0	0	0	0
Y+R:	4.0	4.0	4.0	4.0	4.0	4.0	4.0	4.0	4.0	4.0	4.0	4.0
Lanes:	1	0	2	1	0	2	1	0	1	1	0	1

Volume Module:

Base Vol:	152	1142	198	161	716	121	70	214	47	139	433	252
Growth Adj:	1.00	1.00	1.00	1.00	1.00	1.00	1.00	1.00	1.00	1.00	1.00	1.00
Initial Bse:	152	1142	198	161	716	121	70	214	47	139	433	252
User Adj:	1.00	1.00	1.00	1.00	1.00	1.00	1.00	1.00	1.00	1.00	1.00	1.00
PHF Adj:	1.00	1.00	1.00	1.00	1.00	1.00	1.00	1.00	1.00	1.00	1.00	1.00
PHF Volume:	152	1142	198	161	716	121	70	214	47	139	433	252
Reduct Vol:	0	0	0	0	0	0	0	0	0	0	0	0
Reduced Vol:	152	1142	198	161	716	121	70	214	47	139	433	252
PCE Adj:	1.00	1.00	1.00	1.00	1.00	1.00	1.00	1.00	1.00	1.00	1.00	1.00
MLF Adj:	1.00	1.00	1.00	1.00	1.00	1.00	1.00	1.00	1.00	1.00	1.00	1.00
FinalVolume:	152	1142	198	161	716	121	70	214	47	139	433	252

Saturation Flow Module:

Sat/Lane:	1600	1600	1600	1600	1600	1600	1600	1600	1600	1600	1600	1600
Adjustment:	1.00	1.05	1.00	1.00	1.05	1.00	1.00	1.04	1.00	1.00	1.05	1.00
Lanes:	1.00	2.56	0.44	1.00	2.57	0.43	1.00	1.64	0.36	1.00	1.26	0.74
Final Sat.:	1600	4291	709	1600	4306	694	1600	2724	576	1600	2123	1177

Capacity Analysis Module:

Vol/Sat:	0.10	0.27	0.28	0.10	0.17	0.17	0.04	0.08	0.08	0.09	0.20	0.21
Crit Moves:		****	****		****	****		****	****		****	****

Santa Ana Circulation Element

Level of Service Computation Report

ICU 1(Loss as Cycle Length %) Method (Base Volume Alternative)

Intersection #81 Grand Ave and McFadden Ave

Cycle (sec): 100 Critical Vol./Cap.(X): 0.821
 Loss Time (sec): 5 Average Delay (sec/veh): xxxxxx
 Optimal Cycle: 57 Level Of Service: D

Approach:	North Bound			South Bound			East Bound			West Bound		
Movement:	L	T	R	L	T	R	L	T	R	L	T	R
Control:	Protected			Protected			Protected			Protected		
Rights:	Include			Include			Include			Include		
Min. Green:	0	0	0	0	0	0	0	0	0	0	0	0
Y+R:	4.0	4.0	4.0	4.0	4.0	4.0	4.0	4.0	4.0	4.0	4.0	4.0
Lanes:	1	0	2	1	0	2	1	0	1	1	0	1

Volume Module:

Base Vol:	222	1264	218	153	696	187	122	454	79	96	762	168
Growth Adj:	1.00	1.00	1.00	1.00	1.00	1.00	1.00	1.00	1.00	1.00	1.00	1.00
Initial Bse:	222	1264	218	153	696	187	122	454	79	96	762	168
User Adj:	1.00	1.00	1.00	1.00	1.00	1.00	1.00	1.00	1.00	1.00	1.00	1.00
PHF Adj:	1.00	1.00	1.00	1.00	1.00	1.00	1.00	1.00	1.00	1.00	1.00	1.00
PHF Volume:	222	1264	218	153	696	187	122	454	79	96	762	168
Reduct Vol:	0	0	0	0	0	0	0	0	0	0	0	0
Reduced Vol:	222	1264	218	153	696	187	122	454	79	96	762	168
PCE Adj:	1.00	1.00	1.00	1.00	1.00	1.00	1.00	1.00	1.00	1.00	1.00	1.00
MLF Adj:	1.00	1.00	1.00	1.00	1.00	1.00	1.00	1.00	1.00	1.00	1.00	1.00
FinalVolume:	222	1264	218	153	696	187	122	454	79	96	762	168

Saturation Flow Module:

Sat/Lane:	1600	1600	1600	1600	1600	1600	1600	1600	1600	1600	1600	1600
Adjustment:	1.00	1.05	1.00	1.00	1.05	1.00	1.00	1.04	1.00	1.00	1.04	1.00
Lanes:	1.00	2.56	0.44	1.00	2.36	0.64	1.00	1.70	0.30	1.00	1.64	0.36
Final Sat.:	1600	4294	706	1600	3983	1017	1600	2826	474	1600	2722	578

Capacity Analysis Module:

Vol/Sat:	0.14	0.29	0.31	0.10	0.17	0.18	0.08	0.16	0.17	0.06	0.28	0.29
Crit Moves:			****	****			****			****		

Santa Ana Circulation Element

Level Of Service Computation Report

ICU 1(Loss as Cycle Length %) Method (Base Volume Alternative)

Intersection #82 Grand Ave and Edinger Ave

Cycle (sec): 100 Critical Vol./Cap.(X): 1.004
 Loss Time (sec): 5 Average Delay (sec/veh): xxxxxx
 Optimal Cycle: 180 Level Of Service: F

Approach:	North Bound			South Bound			East Bound			West Bound		
Movement:	L	T	R	L	T	R	L	T	R	L	T	R
Control:	Protected			Protected			Protected			Protected		
Rights:	Include			Include			Include			Include		
Min. Green:	0	0	0	0	0	0	0	0	0	0	0	0
Y+R:	4.0	4.0	4.0	4.0	4.0	4.0	4.0	4.0	4.0	4.0	4.0	4.0
Lanes:	1	0	2	1	0	2	1	0	2	1	0	2

Volume Module:

Base Vol:	244	1411	122	203	501	281	182	787	63	93	1673	217
Growth Adj:	1.00	1.00	1.00	1.00	1.00	1.00	1.00	1.00	1.00	1.00	1.00	1.00
Initial Bse:	244	1411	122	203	501	281	182	787	63	93	1673	217
User Adj:	1.00	1.00	1.00	1.00	1.00	1.00	1.00	1.00	1.00	1.00	1.00	1.00
PHF Adj:	1.00	1.00	1.00	1.00	1.00	1.00	1.00	1.00	1.00	1.00	1.00	1.00
PHF Volume:	244	1411	122	203	501	281	182	787	63	93	1673	217
Reduct Vol:	0	0	0	0	0	0	0	0	0	0	0	0
Reduced Vol:	244	1411	122	203	501	281	182	787	63	93	1673	217
PCE Adj:	1.00	1.00	1.00	1.00	1.00	1.00	1.00	1.00	1.00	1.00	1.00	1.00
MLF Adj:	1.00	1.00	1.00	1.00	1.00	1.00	1.00	1.00	1.00	1.00	1.00	1.00
FinalVolume:	244	1411	122	203	501	281	182	787	63	93	1673	217

Saturation Flow Module:

Sat/Lane:	1600	1600	1600	1600	1600	1600	1600	1600	1600	1600	1600	1600
Adjustment:	1.00	1.05	1.00	1.00	1.06	1.00	1.00	1.05	1.00	1.00	1.05	1.00
Lanes:	1.00	2.76	0.24	1.00	2.00	1.00	1.00	2.78	0.22	1.00	2.66	0.34
Final Sat.:	1600	4618	382	1600	3400	1600	1600	4644	356	1600	4449	551

Capacity Analysis Module:

Vol/Sat:	0.15	0.31	0.32	0.13	0.15	0.18	0.11	0.17	0.18	0.06	0.38	0.39
Crit Moves:			****	****			****					****

Santa Ana Circulation Element

Level Of Service Computation Report

ICU 1(Loss as Cycle Length %) Method (Base Volume Alternative)

Intersection #83 Grand Ave and Warner Ave

Cycle (sec): 100 Critical Vol./Cap.(X): 0.827
 Loss Time (sec): 5 Average Delay (sec/veh): xxxxxx
 Optimal Cycle: 58 Level Of Service: D

Approach:	North Bound			South Bound			East Bound			West Bound		
Movement:	L	T	R	L	T	R	L	T	R	L	T	R
Control:	Protected			Protected			Protected			Protected		
Rights:	Include			Include			Include			Include		
Min. Green:	0	0	0	0	0	0	0	0	0	0	0	0
Y+R:	4.0	4.0	4.0	4.0	4.0	4.0	4.0	4.0	4.0	4.0	4.0	4.0
Lanes:	1	0	2	1	0	2	2	0	3	2	0	2

Volume Module:	North Bound			South Bound			East Bound			West Bound		
Base Vol:	183	660	146	140	452	208	306	587	127	241	1539	504
Growth Adj:	1.00	1.00	1.00	1.00	1.00	1.00	1.00	1.00	1.00	1.00	1.00	1.00
Initial Bse:	183	660	146	140	452	208	306	587	127	241	1539	504
User Adj:	1.00	1.00	1.00	1.00	1.00	1.00	1.00	1.00	1.00	1.00	1.00	1.00
PHF Adj:	1.00	1.00	1.00	1.00	1.00	1.00	1.00	1.00	1.00	1.00	1.00	1.00
PHF Volume:	183	660	146	140	452	208	306	587	127	241	1539	504
Reduct Vol:	0	0	0	0	0	0	0	0	0	0	0	0
Reduced Vol:	183	660	146	140	452	208	306	587	127	241	1539	504
PCE Adj:	1.00	1.00	1.00	1.00	1.00	1.00	1.00	1.00	1.00	1.00	1.00	1.00
MLF Adj:	1.00	1.00	1.00	1.00	1.00	1.00	1.00	1.00	1.00	1.00	1.00	1.00
Final Volume:	183	660	146	140	452	208	306	587	127	241	1539	504

Saturation Flow Module:	North Bound			South Bound			East Bound			West Bound		
Sat/Lane:	1600	1600	1600	1600	1600	1600	1600	1600	1600	1600	1600	1600
Adjustment:	1.00	1.05	1.00	1.00	1.06	1.00	1.00	1.06	1.00	1.00	1.06	1.00
Lanes:	1.00	2.46	0.54	1.00	2.05	0.95	2.00	3.00	1.00	2.00	2.26	0.74
Final Sat.:	1600	4131	869	1600	3487	1513	3200	5100	1600	3200	3816	1184

Capacity Analysis Module:	North Bound			South Bound			East Bound			West Bound		
Vol/Sat:	0.11	0.16	0.17	0.09	0.13	0.14	0.10	0.12	0.08	0.08	0.40	0.43
Crit Moves:	****			****			****			****		

Santa Ana Circulation Element

Level Of Service Computation Report

2000 HCM Operations Method (Base Volume Alternative)

 Intersection #84 SR-55 NB Ramps and Dyer Rd

Cycle (sec): 100 Critical Vol./Cap.(X): 0.362
 Loss Time (sec): 5 Average Delay (sec/veh): 5.7
 Optimal Cycle: 20 Level Of Service: A

Approach:	North Bound			South Bound			East Bound			West Bound		
Movement:	L	T	R	L	T	R	L	T	R	L	T	R
Control:	Split Phase			Split Phase			Protected			Protected		
Rights:	Include			Include			Ignore			Ignore		
Min. Green:	0	0	0	0	0	0	0	0	0	0	0	0
Y+R:	4.0	4.0	4.0	4.0	4.0	4.0	4.0	4.0	4.0	4.0	4.0	4.0
Lanes:	1	0	1	0	0	0	0	0	3	0	2	1

Volume Module:	North Bound			South Bound			East Bound			West Bound		
Base Vol:	181	0	49	0	0	0	0	1183	602	0	1488	929
Growth Adj:	1.00	1.00	1.00	1.00	1.00	1.00	1.00	1.00	1.00	1.00	1.00	1.00
Initial Bse:	181	0	49	0	0	0	0	1183	602	0	1488	929
User Adj:	1.00	1.00	1.00	1.00	1.00	1.00	1.00	1.00	0.00	1.00	1.00	0.00
PHF Adj:	1.00	1.00	1.00	1.00	1.00	1.00	1.00	1.00	0.00	1.00	1.00	0.00
PHF Volume:	181	0	49	0	0	0	0	1183	0	0	1488	0
Reduct Vol:	0	0	0	0	0	0	0	0	0	0	0	0
Reduced Vol:	181	0	49	0	0	0	0	1183	0	0	1488	0
PCE Adj:	1.00	1.00	1.00	1.00	1.00	1.00	1.00	1.00	0.00	1.00	1.00	0.00
MLF Adj:	1.00	1.00	1.00	1.00	1.00	1.00	1.00	1.00	0.00	1.00	1.00	0.00
Final Volume:	181	0	49	0	0	0	0	1183	0	0	1488	0

Saturation Flow Module:	North Bound			South Bound			East Bound			West Bound		
Sat/Lane:	1900	1900	1900	1900	1900	1900	1900	1900	1900	1900	1900	1900
Adjustment:	0.93	1.00	0.93	1.00	1.00	1.00	1.00	0.91	1.00	1.00	0.91	0.91
Lanes:	1.79	0.00	1.21	0.00	0.00	0.00	0.00	3.00	1.00	0.00	3.00	0.00
Final Sat.:	3162	0	2146	0	0	0	0	5187	1900	0	5187	0

Capacity Analysis Module:	North Bound			South Bound			East Bound			West Bound		
Vol/Sat:	0.06	0.00	0.02	0.00	0.00	0.00	0.00	0.23	0.00	0.00	0.29	0.00
Crit Moves:	****			****			****			****		
Green/Cycle:	0.16	0.00	0.16	0.00	0.00	0.00	0.00	0.79	0.00	0.00	0.79	0.00
Volume/Cap:	0.36	0.00	0.14	0.00	0.00	0.00	0.00	0.29	0.00	0.00	0.36	0.00
Delay/Veh:	38.0	0.0	36.3	0.0	0.0	0.0	0.0	2.8	0.0	0.0	3.1	0.0
User DelAdj:	1.00	1.00	1.00	1.00	1.00	1.00	1.00	1.00	1.00	1.00	1.00	1.00
AdjDel/Veh:	38.0	0.0	36.3	0.0	0.0	0.0	0.0	2.8	0.0	0.0	3.1	0.0
LOS by Move:	D	A	D	A	A	A	A	A	A	A	A	A
HCM2k85thQ:	5	0	2	0	0	0	0	6	0	0	8	0

Note: Queue reported is the number of cars per lane.

Santa Ana Circulation Element

Level Of Service Computation Report

2000 HCM 4-Way Stop Method (Base Volume Alternative)

 Intersection #85 Cambridge St and La Veta Ave

Cycle (sec): 100 Critical Vol./Cap.(X): 0.779
 Loss Time (sec): 5 Average Delay (sec/veh): 19.7
 Optimal Cycle: 0 Level Of Service: C

Approach:	North Bound			South Bound			East Bound			West Bound		
Movement:	L	T	R	L	T	R	L	T	R	L	T	R
Control:	Stop Sign			Stop Sign			Stop Sign			Stop Sign		
Rights:	Include			Include			Include			Include		
Min. Green:	0	0	0	0	0	0	0	0	0	0	0	0
Lanes:	1	0	1	0	0	1	1	0	0	0	0	0

Volume Module:	North Bound			South Bound			East Bound			West Bound		
Base Vol:	235	327	0	0	206	191	375	0	247	0	0	0
Growth Adj:	1.00	1.00	1.00	1.00	1.00	1.00	1.00	1.00	1.00	1.00	1.00	1.00
Initial Bse:	235	327	0	0	206	191	375	0	247	0	0	0
User Adj:	1.00	1.00	1.00	1.00	1.00	1.00	1.00	1.00	1.00	1.00	1.00	1.00
PHF Adj:	1.00	1.00	1.00	1.00	1.00	1.00	1.00	1.00	1.00	1.00	1.00	1.00
PHF Volume:	235	327	0	0	206	191	375	0	247	0	0	0
Reduct Vol:	0	0	0	0	0	0	0	0	0	0	0	0
Reduced Vol:	235	327	0	0	206	191	375	0	247	0	0	0
PCE Adj:	1.00	1.00	1.00	1.00	1.00	1.00	1.00	1.00	1.00	1.00	1.00	1.00
MLF Adj:	1.00	1.00	1.00	1.00	1.00	1.00	1.00	1.00	1.00	1.00	1.00	1.00
FinalVolume:	235	327	0	0	206	191	375	0	247	0	0	0

Saturation Flow Module:	North Bound			South Bound			East Bound			West Bound		
Adjustment:	1.00	1.00	1.00	1.00	1.00	1.00	1.00	1.00	1.00	1.00	1.00	1.00
Lanes:	1.00	1.00	0.00	0.00	1.00	1.00	1.00	0.00	1.00	0.00	0.00	0.00
Final Sat.:	474	510	0	0	485	534	482	0	567	0	0	0

Capacity Analysis Module:	North Bound			South Bound			East Bound			West Bound		
Vol/Sat:	0.50	0.64	xxxx	xxxx	0.42	0.36	0.78	xxxx	0.44	xxxx	xxxx	xxxx
Crit Moves:	****			****			****			****		
Delay/Veh:	17.0	20.9	0.0	0.0	14.9	12.6	30.8	0.0	13.4	0.0	0.0	0.0
Delay Adj:	1.00	1.00	1.00	1.00	1.00	1.00	1.00	1.00	1.00	1.00	1.00	1.00
AdjDel/Veh:	17.0	20.9	0.0	0.0	14.9	12.6	30.8	0.0	13.4	0.0	0.0	0.0
LOS by Move:	C	C	*	*	B	B	D	*	B	*	*	*
ApproachDel:	19.3			13.8			23.9			xxxxxxx		
Delay Adj:	1.00			1.00			1.00			xxxxxxx		
ApprAdjDel:	19.3			13.8			23.9			xxxxxxx		
LOS by Appr:	C			B			C			*		
AllWayAvgQ:	0.9	1.6	0.0	0.0	0.7	0.5	2.8	0.0	0.7	0.0	0.0	0.0

 Note: Queue reported is the number of cars per lane.

Santa Ana Circulation Element

Level Of Service Computation Report

ICU 1(Loss as Cycle Length %) Method (Base Volume Alternative)

 Intersection #86 Cambridge St and Fairhaven Ave

Cycle (sec): 100 Critical Vol./Cap.(X): 0.454
 Loss Time (sec): 5 Average Delay (sec/veh): xxxxxx
 Optimal Cycle: 22 Level Of Service: A

Approach:	North Bound			South Bound			East Bound			West Bound		
Movement:	L	T	R	L	T	R	L	T	R	L	T	R
Control:	Permitted			Permitted			Permitted			Permitted		
Rights:	Include			Include			Include			Include		
Min. Green:	0	0	0	0	0	0	0	0	0	0	0	0
Y+R:	4.0	4.0	4.0	4.0	4.0	4.0	4.0	4.0	4.0	4.0	4.0	4.0
Lanes:	0	0	0	1	0	0	1	0	2	0	0	1

Volume Module:	North Bound			South Bound			East Bound			West Bound		
Base Vol:	0	0	0	219	0	76	132	230	0	0	237	295
Growth Adj:	1.00	1.00	1.00	1.00	1.00	1.00	1.00	1.00	1.00	1.00	1.00	1.00
Initial Bse:	0	0	0	219	0	76	132	230	0	0	237	295
User Adj:	1.00	1.00	1.00	1.00	1.00	1.00	1.00	1.00	1.00	1.00	1.00	1.00
PHF Adj:	1.00	1.00	1.00	1.00	1.00	1.00	1.00	1.00	1.00	1.00	1.00	1.00
PHF Volume:	0	0	0	219	0	76	132	230	0	0	237	295
Reduct Vol:	0	0	0	0	0	0	0	0	0	0	0	0
Reduced Vol:	0	0	0	219	0	76	132	230	0	0	237	295
PCE Adj:	1.00	1.00	1.00	1.00	1.00	1.00	1.00	1.00	1.00	1.00	1.00	1.00
MLF Adj:	1.00	1.00	1.00	1.00	1.00	1.00	1.00	1.00	1.00	1.00	1.00	1.00
FinalVolume:	0	0	0	219	0	76	132	230	0	0	237	295

Saturation Flow Module:	North Bound			South Bound			East Bound			West Bound		
Sat/Lane:	1600	1600	1600	1600	1600	1600	1600	1600	1600	1600	1600	1600
Adjustment:	1.00	1.06	1.00	1.00	1.06	1.00	1.00	1.06	1.00	1.00	1.06	1.00
Lanes:	0.00	0.00	0.00	1.00	0.00	1.00	1.00	2.00	0.00	0.00	1.00	1.00
Final Sat.:	0	0	0	1600	0	1600	1600	3400	0	0	1700	1600

Capacity Analysis Module:	North Bound			South Bound			East Bound			West Bound		
Vol/Sat:	0.00	0.00	0.00	0.14	0.00	0.05	0.08	0.07	0.00	0.00	0.14	0.18
Crit Moves:				****			****					****

Santa Ana Circulation Element

Level of Service Computation Report
 2000 HCM Operations Method (Base Volume Alternative)

 Intersection #87 Mabury St and 1st Street

Cycle (sec): 100 Critical Vol./Cap.(X): 0.674
 Loss Time (sec): 5 Average Delay (sec/veh): 27.1
 Optimal Cycle: 36 Level of Service: C

Street Name:	Mabury						1st Street					
Approach:	North Bound			South Bound			East Bound			West Bound		
Movement:	L	T	R	L	T	R	L	T	R	L	T	R
Control:	Split Phase			Split Phase			Protected			Protected		
Rights:	Include			Include			Include			Include		
Min. Green:	0	0	0	0	0	0	0	0	0	0	0	0
Y+R:	4.0	4.0	4.0	4.0	4.0	4.0	4.0	4.0	4.0	4.0	4.0	4.0
Lanes:	1	0	0	0	1	0	0	0	2	1	0	2

Volume Module:	Mabury NB			Mabury SB			1st St EB			1st St WB		
Base Vol:	23	0	233	195	83	367	0	1334	21	40	549	0
Growth Adj:	1.00	1.00	1.00	1.00	1.00	1.00	1.00	1.00	1.00	1.00	1.00	1.00
Initial Bse:	23	0	233	195	83	367	0	1334	21	40	549	0
User Adj:	1.00	1.00	1.00	1.00	1.00	1.00	1.00	1.00	1.00	1.00	1.00	1.00
PHF Adj:	1.00	1.00	1.00	1.00	1.00	1.00	1.00	1.00	1.00	1.00	1.00	1.00
PHF Volume:	23	0	233	195	83	367	0	1334	21	40	549	0
Reduct Vol:	0	0	0	0	0	0	0	0	0	0	0	0
Reduced Vol:	23	0	233	195	83	367	0	1334	21	40	549	0
PCE Adj:	1.00	1.00	1.00	1.00	1.00	1.00	1.00	1.00	1.00	1.00	1.00	1.00
MLF Adj:	1.00	1.00	1.00	1.00	1.00	1.00	1.00	1.00	1.00	1.00	1.00	1.00
FinalVolume:	23	0	233	195	83	367	0	1334	21	40	549	0

Saturation Flow Module:	Mabury NB			Mabury SB			1st St EB			1st St WB		
Sat/Lane:	1900	1900	1900	1900	1900	1900	1900	1900	1900	1900	1900	1900
Adjustment:	0.95	1.00	0.85	0.90	0.90	0.90	1.00	0.91	0.91	0.95	0.91	0.91
Lanes:	1.00	0.00	1.00	1.27	0.23	1.50	0.00	2.95	0.05	1.00	3.00	0.00
Final Sat.:	1805	0	1615	2171	390	2576	0	5096	80	1805	5187	0

Capacity Analysis Module:	Mabury NB			Mabury SB			1st St EB			1st St WB		
Vol/Sat:	0.01	0.00	0.14	0.09	0.21	0.14	0.00	0.26	0.26	0.02	0.11	0.00
Crit Moves:			****			****			****			****
Green/Cycle:	0.21	0.00	0.21	0.32	0.32	0.32	0.00	0.39	0.39	0.03	0.42	0.00
Volume/Cap:	0.06	0.00	0.67	0.28	0.67	0.45	0.00	0.67	0.67	0.67	0.25	0.00
Delay/Veh:	31.4	0.0	41.3	25.8	31.7	27.6	0.0	26.3	26.3	74.4	18.8	0.0
User DelAdj:	1.00	1.00	1.00	1.00	1.00	1.00	1.00	1.00	1.00	1.00	1.00	1.00
AdjDel/Veh:	31.4	0.0	41.3	25.8	31.7	27.6	0.0	26.3	26.3	74.4	18.8	0.0
LOS by Move:	C	A	D	C	C	C	A	C	C	E	B	A
HCM2k85thQ:	1	0	12	6	16	10	0	20	20	4	6	0

Note: Queue reported is the number of cars per lane.

Santa Ana Circulation Element

Level Of Service Computation Report

ICU 1(Loss as Cycle Length %) Method (Base Volume Alternative)

 Intersection #88 Tustin St and La Veta Ave

Cycle (sec): 100 Critical Vol./Cap.(X): 0.381
 Loss Time (sec): 5 Average Delay (sec/veh): xxxxxx
 Optimal Cycle: 19 Level Of Service: A

Approach:	North Bound			South Bound			East Bound			West Bound		
Movement:	L	T	R	L	T	R	L	T	R	L	T	R
Control:	Protected			Protected			Split Phase			Split Phase		
Rights:	Include			Include			Include			Ovl		
Min. Green:	0	0	0	0	0	0	0	0	0	0	0	0
Y+R:	4.0	4.0	4.0	4.0	4.0	4.0	4.0	4.0	4.0	4.0	4.0	4.0
Lanes:	1	0	2	1	0	2	1	0	1	1	0	0

Volume Module:

Base Vol:	38	863	205	79	701	13	13	5	20	146	4	90
Growth Adj:	1.00	1.00	1.00	1.00	1.00	1.00	1.00	1.00	1.00	1.00	1.00	1.00
Initial Bse:	38	863	205	79	701	13	13	5	20	146	4	90
User Adj:	1.00	1.00	1.00	1.00	1.00	1.00	1.00	1.00	1.00	1.00	1.00	1.00
PHF Adj:	1.00	1.00	1.00	1.00	1.00	1.00	1.00	1.00	1.00	1.00	1.00	1.00
PHF Volume:	38	863	205	79	701	13	13	5	20	146	4	90
Reduct Vol:	0	0	0	0	0	0	0	0	0	0	0	0
Reduced Vol:	38	863	205	79	701	13	13	5	20	146	4	90
PCE Adj:	1.00	1.00	1.00	1.00	1.00	1.00	1.00	1.00	1.00	1.00	1.00	1.00
MLF Adj:	1.00	1.00	1.00	1.00	1.00	1.00	1.00	1.00	1.00	1.00	1.00	1.00
FinalVolume:	38	863	205	79	701	13	13	5	20	146	4	90
OvlAdjVol:	11											

Saturation Flow Module:

Sat/Lane:	1600	1600	1600	1600	1600	1600	1600	1600	1600	1600	1600	1600
Adjustment:	1.00	1.05	1.00	1.00	1.04	1.00	1.00	1.06	1.00	1.00	1.00	1.00
Lanes:	1.00	2.42	0.58	1.00	2.95	0.05	1.00	1.00	1.00	1.95	0.05	1.00
Final Sat.:	1600	4079	921	1600	4913	87	1600	1700	1600	3115	85	1600

Capacity Analysis Module:

Vol/Sat:	0.02	0.21	0.22	0.05	0.14	0.15	0.01	0.00	0.01	0.05	0.05	0.06
OvlAdjV/S:	0.01											
Crit Moves:	****			****			****			****		

Santa Ana Circulation Element

Level Of Service Computation Report

2000 HCM Operations Method (Base Volume Alternative)

Intersection #89 Tustin St and SR-22 WB On-Ramp

Cycle (sec): 100 Critical Vol./Cap.(X): 0.391
 Loss Time (sec): 5 Average Delay (sec/veh): 11.1
 Optimal Cycle: 29 Level Of Service: B

Approach:	North Bound			South Bound			East Bound			West Bound		
Movement:	L	T	R	L	T	R	L	T	R	L	T	R
Control:	Protected			Permitted			Protected			Protected		
Rights:	Include			Include			Include			Include		
Min. Green:	0	0	0	0	0	0	0	0	0	0	0	0
Y+R:	4.0	4.0	4.0	4.0	4.0	4.0	4.0	4.0	4.0	4.0	4.0	4.0
Lanes:	2	0	2	0	0	2	1	0	0	0	0	0

Volume Module:

Base Vol:	466	1340	0	0	573	294	0	0	0	0	0	0
Growth Adj:	1.00	1.00	1.00	1.00	1.00	1.00	1.00	1.00	1.00	1.00	1.00	1.00
Initial Bse:	466	1340	0	0	573	294	0	0	0	0	0	0
User Adj:	1.00	1.00	1.00	1.00	1.00	1.00	1.00	1.00	1.00	1.00	1.00	1.00
PHF Adj:	1.00	1.00	1.00	1.00	1.00	1.00	1.00	1.00	1.00	1.00	1.00	1.00
PHF Volume:	466	1340	0	0	573	294	0	0	0	0	0	0
Reduct Vol:	0	0	0	0	0	0	0	0	0	0	0	0
Reduced Vol:	466	1340	0	0	573	294	0	0	0	0	0	0
PCE Adj:	1.00	1.00	1.00	1.00	1.00	1.00	1.00	1.00	1.00	1.00	1.00	1.00
MLF Adj:	1.00	1.00	1.00	1.00	1.00	1.00	1.00	1.00	1.00	1.00	1.00	1.00
Final Volume:	466	1340	0	0	573	294	0	0	0	0	0	0

Saturation Flow Module:

Sat/Lane:	1900	1900	1900	1900	1900	1900	1900	1900	1900	1900	1900	1900
Adjustment:	0.92	0.95	1.00	1.00	0.86	0.86	1.00	1.00	1.00	1.00	1.00	1.00
Lanes:	2.00	2.00	0.00	0.00	2.00	1.00	0.00	0.00	0.00	0.00	0.00	0.00
Final Sat.:	3502	3610	0	0	3282	1641	0	0	0	0	0	0

Capacity Analysis Module:

Vol/Sat:	0.13	0.37	0.00	0.00	0.17	0.18	0.00	0.00	0.00	0.00	0.00	0.00
Crit Moves:	****											
Green/Cycle:	0.65	0.95	0.00	0.00	0.30	0.30	0.00	0.00	0.00	0.00	0.00	0.00
Volume/Cap:	0.21	0.39	0.00	0.00	0.57	0.59	0.00	0.00	0.00	0.00	0.00	0.00
Delay/Veh:	7.3	0.3	0.0	0.0	29.9	30.2	0.0	0.0	0.0	0.0	0.0	0.0
User DelAdj:	1.00	1.00	1.00	1.00	1.00	1.00	1.00	1.00	1.00	1.00	1.00	1.00
AdjDel/Veh:	7.3	0.3	0.0	0.0	29.9	30.2	0.0	0.0	0.0	0.0	0.0	0.0
LOS by Move:	A	A	A	A	C	C	A	A	A	A	A	A
HCM2k85thQ:	5	3	0	0	13	14	0	0	0	0	0	0

Note: Queue reported is the number of cars per lane.

Santa Ana Circulation Element

Level Of Service Computation Report

2000 HCM Operations Method (Base Volume Alternative)

 Intersection #90 Tustin St and SR-22 EB Off-Ramp / Seba Ave

Cycle (sec): 100 Critical Vol./Cap.(X): 0.679
 Loss Time (sec): 5 Average Delay (sec/veh): 23.1
 Optimal Cycle: 37 Level Of Service: C

Approach:	North Bound			South Bound			East Bound			West Bound		
Movement:	L	T	R	L	T	R	L	T	R	L	T	R
Control:	Permitted			Permitted			Split Phase			Split Phase		
Rights:	Include			Include			Include			Include		
Min. Green:	0	0	0	0	0	0	0	0	0	0	0	0
Y+R:	4.0	4.0	4.0	4.0	4.0	4.0	4.0	4.0	4.0	4.0	4.0	4.0
Lanes:	0	0	2	1	0	3	0	1	0	1	0	0

Volume Module:	North Bound			South Bound			East Bound			West Bound		
Base Vol:	0	1416	4	40	550	0	440	39	558	28	0	67
Growth Adj:	1.00	1.00	1.00	1.00	1.00	1.00	1.00	1.00	1.00	1.00	1.00	1.00
Initial Bse:	0	1416	4	40	550	0	440	39	558	28	0	67
User Adj:	1.00	1.00	1.00	1.00	1.00	1.00	1.00	1.00	1.00	1.00	1.00	1.00
PHF Adj:	1.00	1.00	1.00	1.00	1.00	1.00	1.00	1.00	1.00	1.00	1.00	1.00
PHF Volume:	0	1416	4	40	550	0	440	39	558	28	0	67
Reduct Vol:	0	0	0	0	0	0	0	0	0	0	0	0
Reduced Vol:	0	1416	4	40	550	0	440	39	558	28	0	67
PCE Adj:	1.00	1.00	1.00	1.00	1.00	1.00	1.00	1.00	1.00	1.00	1.00	1.00
MLF Adj:	1.00	1.00	1.00	1.00	1.00	1.00	1.00	1.00	1.00	1.00	1.00	1.00
Final Volume:	0	1416	4	40	550	0	440	39	558	28	0	67

Saturation Flow Module:	North Bound			South Bound			East Bound			West Bound		
Sat/Lane:	1900	1900	1900	1900	1900	1900	1900	1900	1900	1900	1900	1900
Adjustment:	1.00	0.91	0.91	0.10	0.91	1.00	0.90	0.90	0.90	0.89	1.00	0.89
Lanes:	0.00	2.99	0.01	1.00	3.00	0.00	1.41	0.07	1.52	0.29	0.00	0.71
Final Sat.:	0	5172	15	188	5187	0	2408	124	2596	499	0	1195

Capacity Analysis Module:	North Bound			South Bound			East Bound			West Bound		
Vol/Sat:	0.00	0.27	0.27	0.21	0.11	0.00	0.18	0.31	0.21	0.06	0.00	0.06
Crit Moves:	****						****			****		
Green/Cycle:	0.00	0.40	0.40	0.40	0.40	0.00	0.46	0.46	0.46	0.08	0.00	0.08
Volume/Cap:	0.00	0.68	0.68	0.53	0.26	0.00	0.39	0.68	0.46	0.68	0.00	0.68
Delay/Veh:	0.0	25.4	25.4	29.3	20.0	0.0	17.7	22.2	18.5	57.2	0.0	57.2
User DelAdj:	1.00	1.00	1.00	1.00	1.00	1.00	1.00	1.00	1.00	1.00	1.00	1.00
AdjDel/Veh:	0.0	25.4	25.4	29.3	20.0	0.0	17.7	22.2	18.5	57.2	0.0	57.2
LOS by Move:	A	C	C	C	B	A	B	C	B	E	A	E
HCM2k85thQ:	0	21	21	3	6	0	10	20	12	7	0	7

 Note: Queue reported is the number of cars per lane.

Santa Ana Circulation Element

Level Of Service Computation Report

ICU 1(Loss as Cycle Length %) Method (Base Volume Alternative)

Intersection #91 Tustin Ave and Fairhaven Ave

Cycle (sec): 100 Critical Vol./Cap.(X): 0.685
 Loss Time (sec): 5 Average Delay (sec/veh): xxxxxx
 Optimal Cycle: 36 Level Of Service: B

Approach:	North Bound			South Bound			East Bound			West Bound		
Movement:	L	T	R	L	T	R	L	T	R	L	T	R
Control:	Protected			Protected			Protected			Protected		
Rights:	Include			Include			Include			Ovl		
Min. Green:	0	0	0	0	0	0	0	0	0	0	0	0
Y+R:	4.0	4.0	4.0	4.0	4.0	4.0	4.0	4.0	4.0	4.0	4.0	4.0
Lanes:	2	0	2	1	0	0	2	0	2	1	0	1

Volume Module:

Base Vol:	280	1492	132	356	940	108	89	200	163	100	220	208
Growth Adj:	1.00	1.00	1.00	1.00	1.00	1.00	1.00	1.00	1.00	1.00	1.00	1.00
Initial Bse:	280	1492	132	356	940	108	89	200	163	100	220	208
User Adj:	1.00	1.00	1.00	1.00	1.00	1.00	1.00	1.00	1.00	1.00	1.00	1.00
PHF Adj:	1.00	1.00	1.00	1.00	1.00	1.00	1.00	1.00	1.00	1.00	1.00	1.00
PHF Volume:	280	1492	132	356	940	108	89	200	163	100	220	208
Reduct Vol:	0	0	0	0	0	0	0	0	0	0	0	0
Reduced Vol:	280	1492	132	356	940	108	89	200	163	100	220	208
PCE Adj:	1.00	1.00	1.00	1.00	1.00	1.00	1.00	1.00	1.00	1.00	1.00	1.00
MLF Adj:	1.00	1.00	1.00	1.00	1.00	1.00	1.00	1.00	1.00	1.00	1.00	1.00
FinalVolume:	280	1492	132	356	940	108	89	200	163	100	220	208
OvlAdjVol:	30											

Saturation Flow Module:

Sat/Lane:	1600	1600	1600	1600	1600	1600	1600	1600	1600	1600	1600	1600
Adjustment:	1.00	1.05	1.00	1.00	1.05	1.00	1.00	1.06	1.00	1.00	1.06	1.00
Lanes:	2.00	2.76	0.24	2.00	2.69	0.31	1.00	1.10	0.90	1.00	1.00	1.00
Final Sat.:	3200	4610	390	3200	4505	495	1600	1863	1437	1600	1700	1600

Capacity Analysis Module:

Vol/Sat:	0.09	0.32	0.34	0.11	0.21	0.22	0.06	0.11	0.11	0.06	0.13	0.13
OvlAdjV/S:	0.02											
Crit Moves:	****			****			****			****		

Santa Ana Circulation Element

Level Of Service Computation Report

ICU 1(Loss as Cycle Length %) Method (Base Volume Alternative)

Intersection #92 Tustin Ave and Santa Clara Ave

Cycle (sec): 100 Critical Vol./Cap.(X): 0.709
 Loss Time (sec): 5 Average Delay (sec/veh): xxxxxx
 Optimal Cycle: 38 Level Of Service: C

Approach:	North Bound			South Bound			East Bound			West Bound		
Movement:	L	T	R	L	T	R	L	T	R	L	T	R
Control:	Protected			Protected			Permitted			Permitted		
Rights:	Include			Include			Include			Include		
Min. Green:	0	0	0	0	0	0	0	0	0	0	0	0
Y+R:	4.0	4.0	4.0	4.0	4.0	4.0	4.0	4.0	4.0	4.0	4.0	4.0
Lanes:	1	0	2	1	0	2	1	0	1	1	0	1

Volume Module:

Base Vol:	191	923	142	199	1574	109	68	213	125	133	166	157
Growth Adj:	1.00	1.00	1.00	1.00	1.00	1.00	1.00	1.00	1.00	1.00	1.00	1.00
Initial Bse:	191	923	142	199	1574	109	68	213	125	133	166	157
User Adj:	1.00	1.00	1.00	1.00	1.00	1.00	1.00	1.00	1.00	1.00	1.00	1.00
PHF Adj:	1.00	1.00	1.00	1.00	1.00	1.00	1.00	1.00	1.00	1.00	1.00	1.00
PHF Volume:	191	923	142	199	1574	109	68	213	125	133	166	157
Reduct Vol:	0	0	0	0	0	0	0	0	0	0	0	0
Reduced Vol:	191	923	142	199	1574	109	68	213	125	133	166	157
PCE Adj:	1.00	1.00	1.00	1.00	1.00	1.00	1.00	1.00	1.00	1.00	1.00	1.00
MLF Adj:	1.00	1.00	1.00	1.00	1.00	1.00	1.00	1.00	1.00	1.00	1.00	1.00
FinalVolume:	191	923	142	199	1574	109	68	213	125	133	166	157

Saturation Flow Module:

Sat/Lane:	1600	1600	1600	1600	1600	1600	1600	1600	1600	1600	1600	1600
Adjustment:	1.00	1.05	1.00	1.00	1.04	1.00	1.00	1.05	1.00	1.00	1.06	1.00
Lanes:	1.00	2.60	0.40	2.00	2.81	0.19	1.00	1.26	0.74	1.00	1.03	0.97
Final Sat.:	1600	4360	640	3200	4689	311	1600	2117	1183	1600	1745	1555

Capacity Analysis Module:

Vol/Sat:	0.12	0.21	0.22	0.06	0.34	0.35	0.04	0.10	0.11	0.08	0.10	0.10
Crit Moves:	****					****			****	****		

Santa Ana Circulation Element

Level Of Service Computation Report

ICU 1(Loss as Cycle Length %) Method (Base Volume Alternative)

 Intersection #93 Tustin Ave and 17th St

Cycle (sec): 100 Critical Vol./Cap.(X): 0.797
 Loss Time (sec): 5 Average Delay (sec/veh): xxxxxx
 Optimal Cycle: 51 Level Of Service: C

Approach:	North Bound			South Bound			East Bound			West Bound		
Movement:	L	T	R	L	T	R	L	T	R	L	T	R
Control:	Protected			Protected			Protected			Protected		
Rights:	Ovl			Include			Include			Ovl		
Min. Green:	0	0	0	0	0	0	0	0	0	0	0	0
Y+R:	4.0	4.0	4.0	4.0	4.0	4.0	4.0	4.0	4.0	4.0	4.0	4.0
Lanes:	2	0	2	0	2	1	0	2	3	0	1	2

Volume Module:

Base Vol:	253	1083	557	377	404	40	493	968	131	243	798	444
Growth Adj:	1.00	1.00	1.00	1.00	1.00	1.00	1.00	1.00	1.00	1.00	1.00	1.00
Initial Bse:	253	1083	557	377	404	40	493	968	131	243	798	444
User Adj:	1.00	1.00	1.00	1.00	1.00	1.00	1.00	1.00	1.00	1.00	1.00	1.00
PHF Adj:	1.00	1.00	1.00	1.00	1.00	1.00	1.00	1.00	1.00	1.00	1.00	1.00
PHF Volume:	253	1083	557	377	404	40	493	968	131	243	798	444
Reduct Vol:	0	0	0	0	0	0	0	0	0	0	0	0
Reduced Vol:	253	1083	557	377	404	40	493	968	131	243	798	444
PCE Adj:	1.00	1.00	1.00	1.00	1.00	1.00	1.00	1.00	1.00	1.00	1.00	1.00
MLF Adj:	1.00	1.00	1.00	1.00	1.00	1.00	1.00	1.00	1.00	1.00	1.00	1.00
FinalVolume:	253	1083	557	377	404	40	493	968	131	243	798	444
OvlAdjVol:	436									256		

Saturation Flow Module:

Sat/Lane:	1600	1600	1600	1600	1600	1600	1600	1600	1600	1600	1600	1600
Adjustment:	1.00	1.06	1.00	1.00	1.05	1.00	1.00	1.06	1.00	1.00	1.06	1.00
Lanes:	2.00	2.00	1.00	2.00	2.73	0.27	2.00	3.00	1.00	2.00	3.00	1.00
Final Sat.:	3200	3400	1600	3200	4568	432	3200	5100	1600	3200	5100	1600

Capacity Analysis Module:

Vol/Sat:	0.08	0.32	0.35	0.12	0.09	0.09	0.15	0.19	0.08	0.08	0.16	0.28
OvlAdjV/S:	0.27									0.16		
Crit Moves:	***			***			***			***		

Santa Ana Circulation Element

Level Of Service Computation Report

ICU 1(Loss as Cycle Length %) Method (Base Volume Alternative)

Intersection #94 Tustin Ave and 4th St

Cycle (sec): 100 Critical Vol./Cap.(X): 0.708
 Loss Time (sec): 5 Average Delay (sec/veh): xxxxxx
 Optimal Cycle: 38 Level Of Service: C

Approach:	North Bound			South Bound			East Bound			West Bound		
Movement:	L	T	R	L	T	R	L	T	R	L	T	R
Control:	Protected			Protected			Protected			Protected		
Rights:	Include			Include			Include			Include		
Min. Green:	0	0	0	0	0	0	0	0	0	0	0	0
Y+R:	4.0	4.0	4.0	4.0	4.0	4.0	4.0	4.0	4.0	4.0	4.0	4.0
Lanes:	1	0	2	1	0	2	1	0	2	1	0	2

Volume Module:	North Bound			South Bound			East Bound			West Bound		
Base Vol:	28	299	97	459	339	124	208	743	38	118	798	491
Growth Adj:	1.00	1.00	1.00	1.00	1.00	1.00	1.00	1.00	1.00	1.00	1.00	1.00
Initial Bse:	28	299	97	459	339	124	208	743	38	118	798	491
User Adj:	1.00	1.00	1.00	1.00	1.00	1.00	1.00	1.00	1.00	1.00	1.00	1.00
PHF Adj:	1.00	1.00	1.00	1.00	1.00	1.00	1.00	1.00	1.00	1.00	1.00	1.00
PHF Volume:	28	299	97	459	339	124	208	743	38	118	798	491
Reduct Vol:	0	0	0	0	0	0	0	0	0	0	0	0
Reduced Vol:	28	299	97	459	339	124	208	743	38	118	798	491
PCE Adj:	1.00	1.00	1.00	1.00	1.00	1.00	1.00	1.00	1.00	1.00	1.00	1.00
MLF Adj:	1.00	1.00	1.00	1.00	1.00	1.00	1.00	1.00	1.00	1.00	1.00	1.00
FinalVolume:	28	299	97	459	339	124	208	743	38	118	798	491

Saturation Flow Module:	North Bound			South Bound			East Bound			West Bound		
Sat/Lane:	1600	1600	1600	1600	1600	1600	1600	1600	1600	1600	1600	1600
Adjustment:	1.00	1.06	1.00	1.00	1.06	1.00	1.00	1.06	1.00	1.00	1.06	1.00
Lanes:	1.00	2.27	0.73	2.00	2.00	1.00	1.00	3.00	1.00	1.00	2.00	1.00
Final Sat.:	1600	3824	1176	3200	3400	1600	1600	5100	1600	1600	3400	1600

Capacity Analysis Module:	North Bound			South Bound			East Bound			West Bound		
Vol/Sat:	0.02	0.08	0.08	0.14	0.10	0.08	0.13	0.15	0.02	0.07	0.23	0.31
Crit Moves:	****			****			****			****		

Santa Ana Circulation Element

Level Of Service Computation Report

2000 HCM Operations Method (Base Volume Alternative)

Intersection #95 SR-55 SB Ramps / Auto Mall Dr and Edinger Ave

Cycle (sec): 100 Critical Vol./Cap.(X): 0.702
 Loss Time (sec): 5 Average Delay (sec/veh): 25.5
 Optimal Cycle: 39 Level Of Service: C

Approach:	North Bound			South Bound			East Bound			West Bound		
Movement:	L	T	R	L	T	R	L	T	R	L	T	R
Control:	Split Phase			Split Phase			Protected			Protected		
Rights:	Include			Include			Ignore			Include		
Min. Green:	0	0	0	0	0	0	0	0	0	0	0	0
Y+R:	4.0	4.0	4.0	4.0	4.0	4.0	4.0	4.0	4.0	4.0	4.0	4.0
Lanes:	1	1	0	0	0	2	1	0	1	0	1	0

Volume Module:

Base Vol:	401	32	423	110	50	37	47	1677	472	468	1220	146
Growth Adj:	1.00	1.00	1.00	1.00	1.00	1.00	1.00	1.00	1.00	1.00	1.00	1.00
Initial Bse:	401	32	423	110	50	37	47	1677	472	468	1220	146
User Adj:	1.00	1.00	1.00	1.00	1.00	1.00	1.00	1.00	0.00	1.00	1.00	1.00
PHF Adj:	1.00	1.00	1.00	1.00	1.00	1.00	1.00	1.00	0.00	1.00	1.00	1.00
PHF Volume:	401	32	423	110	50	37	47	1677	0	468	1220	146
Reduct Vol:	0	0	0	0	0	0	0	0	0	0	0	0
Reduced Vol:	401	32	423	110	50	37	47	1677	0	468	1220	146
PCE Adj:	1.00	1.00	1.00	1.00	1.00	1.00	1.00	1.00	0.00	1.00	1.00	1.00
MLF Adj:	1.00	1.00	1.00	1.00	1.00	1.00	1.00	1.00	0.00	1.00	1.00	1.00
FinalVolume:	401	32	423	110	50	37	47	1677	0	468	1220	146

Saturation Flow Module:

Sat/Lane:	1900	1900	1900	1900	1900	1900	1900	1900	1900	1900	1900	1900
Adjustment:	0.96	0.96	0.75	0.95	1.00	0.85	0.95	0.91	1.00	0.92	0.90	0.90
Lanes:	1.85	0.15	2.00	1.00	1.00	1.00	1.00	3.00	1.00	2.00	2.68	0.32
Final Sat.:	3364	268	2842	1805	1900	1615	1805	5187	1900	3502	4558	546

Capacity Analysis Module:

Vol/Sat:	0.12	0.12	0.15	0.06	0.03	0.02	0.03	0.32	0.00	0.13	0.27	0.27
Crit Moves:			****	****				****		****		
Green/Cycle:	0.21	0.21	0.21	0.09	0.09	0.09	0.06	0.46	0.00	0.19	0.59	0.59
Volume/Cap:	0.56	0.56	0.70	0.70	0.30	0.26	0.45	0.70	0.00	0.70	0.45	0.45
Delay/Veh:	36.2	36.2	40.2	57.7	43.9	43.7	48.7	22.4	0.0	41.2	11.4	11.4
User DelAdj:	1.00	1.00	1.00	1.00	1.00	1.00	1.00	1.00	1.00	1.00	1.00	1.00
AdjDel/Veh:	36.2	36.2	40.2	57.7	43.9	43.7	48.7	22.4	0.0	41.2	11.4	11.4
LOS by Move:	D	D	D	E	D	D	D	C	A	D	B	B
HCM2k85thQ:	10	10	13	7	3	2	3	23	0	13	13	13

Note: Queue reported is the number of cars per lane.

Santa Ana Circulation Element

Level Of Service Computation Report

2000 HCM Operations Method (Base Volume Alternative)

 Intersection #96 SR-55 NB Ramps / Del Amo Ave and Newport Avenue

Cycle (sec): 100 Critical Vol./Cap.(X): 0.895
 Loss Time (sec): 5 Average Delay (sec/veh): 39.1
 Optimal Cycle: 87 Level Of Service: D

Approach:	North Bound			South Bound			East Bound			West Bound		
Movement:	L	T	R	L	T	R	L	T	R	L	T	R
Control:	Protected			Protected			Protected			Protected		
Rights:	Include			Ovl			Include			Include		
Min. Green:	0	0	0	0	0	0	0	0	0	0	0	0
Y+R:	4.0	4.0	4.0	4.0	4.0	4.0	4.0	4.0	4.0	4.0	4.0	4.0
Lanes:	2	0	2	1	0	3	0	1	1	0	1	1

Volume Module:	North Bound			South Bound			East Bound			West Bound		
Base Vol:	879	262	51	17	209	803	156	54	32	23	348	16
Growth Adj:	1.00	1.00	1.00	1.00	1.00	1.00	1.00	1.00	1.00	1.00	1.00	1.00
Initial Bse:	879	262	51	17	209	803	156	54	32	23	348	16
User Adj:	1.00	1.00	1.00	1.00	1.00	1.00	1.00	1.00	1.00	1.00	1.00	1.00
PHF Adj:	1.00	1.00	1.00	1.00	1.00	1.00	1.00	1.00	1.00	1.00	1.00	1.00
PHF Volume:	879	262	51	17	209	803	156	54	32	23	348	16
Reduct Vol:	0	0	0	0	0	0	0	0	0	0	0	0
Reduced Vol:	879	262	51	17	209	803	156	54	32	23	348	16
PCE Adj:	1.00	1.00	1.00	1.00	1.00	1.00	1.00	1.00	1.00	1.00	1.00	1.00
MLF Adj:	1.00	1.00	1.00	1.00	1.00	1.00	1.00	1.00	1.00	1.00	1.00	1.00
FinalVolume:	879	262	51	17	209	803	156	54	32	23	348	16

Saturation Flow Module:	North Bound			South Bound			East Bound			West Bound		
Sat/Lane:	1900	1900	1900	1900	1900	1900	1900	1900	1900	1900	1900	1900
Adjustment:	0.92	0.89	0.89	0.95	0.91	0.85	0.92	0.90	0.90	0.95	0.94	0.94
Lanes:	2.00	2.51	0.49	1.00	3.00	1.00	2.00	1.26	0.74	1.00	1.91	0.09
Final Sat.:	3502	4238	825	1805	5187	1615	3502	2140	1268	1805	3427	158

Capacity Analysis Module:	North Bound			South Bound			East Bound			West Bound		
Vol/Sat:	0.25	0.06	0.06	0.01	0.04	0.50	0.04	0.03	0.03	0.01	0.10	0.10
Crit Moves:	****					****	****				****	
Green/Cycle:	0.28	0.68	0.68	0.10	0.51	0.56	0.05	0.11	0.11	0.05	0.11	0.11
Volume/Cap:	0.89	0.09	0.09	0.09	0.08	0.89	0.89	0.23	0.23	0.23	0.89	0.89
Delay/Veh:	45.1	5.4	5.4	40.7	12.7	31.0	86.9	41.1	41.1	46.5	65.2	65.2
User DelAdj:	1.00	1.00	1.00	1.00	1.00	1.00	1.00	1.00	1.00	1.00	1.00	1.00
AdjDel/Veh:	45.1	5.4	5.4	40.7	12.7	31.0	86.9	41.1	41.1	46.5	65.2	65.2
LOS by Move:	D	A	A	D	B	C	F	D	D	D	E	E
HCM2k85thQ:	25	2	2	1	2	36	8	2	2	1	14	14

Note: Queue reported is the number of cars per lane.

Santa Ana Circulation Element

Level Of Service Computation Report

ICU 1(Loss as Cycle Length %) Method (Base Volume Alternative)

 Intersection #97 Red Hill Ave and Edinger Ave

Cycle (sec): 100 Critical Vol./Cap.(X): 0.853
 Loss Time (sec): 5 Average Delay (sec/veh): xxxxxx
 Optimal Cycle: 66 Level Of Service: D

Approach:	North Bound			South Bound			East Bound			West Bound		
Movement:	L	T	R	L	T	R	L	T	R	L	T	R
Control:	Protected			Protected			Protected			Protected		
Rights:	Include			Ovl			Ovl			Include		
Min. Green:	0	0	0	0	0	0	0	0	0	0	0	0
Y+R:	4.0	4.0	4.0	4.0	4.0	4.0	4.0	4.0	4.0	4.0	4.0	4.0
Lanes:	2	0	3	0	1		2	0	3	0	1	

Volume Module:

Base Vol:	204	1469	233	105	209	169	410	1051	128	90	1161	567	
Growth Adj:	1.00	1.00	1.00	1.00	1.00	1.00	1.00	1.00	1.00	1.00	1.00	1.00	
Initial Bse:	204	1469	233	105	209	169	410	1051	128	90	1161	567	
User Adj:	1.00	1.00	1.00	1.00	1.00	1.00	1.00	1.00	1.00	1.00	1.00	1.00	
PHF Adj:	1.00	1.00	1.00	1.00	1.00	1.00	1.00	1.00	1.00	1.00	1.00	1.00	
PHF Volume:	204	1469	233	105	209	169	410	1051	128	90	1161	567	
Reduct Vol:	0	0	0	0	0	0	0	0	0	0	0	0	
Reduced Vol:	204	1469	233	105	209	169	410	1051	128	90	1161	567	
PCE Adj:	1.00	1.00	1.00	1.00	1.00	1.00	1.00	1.00	1.00	1.00	1.00	1.00	
MLF Adj:	1.00	1.00	1.00	1.00	1.00	1.00	1.00	1.00	1.00	1.00	1.00	1.00	
FinalVolume:	204	1469	233	105	209	169	410	1051	128	90	1161	567	
OvlAdjVol:							0				26		

Saturation Flow Module:

Sat/Lane:	1600	1600	1600	1600	1600	1600	1600	1600	1600	1600	1600	1600
Adjustment:	1.00	1.06	1.00	1.00	1.06	1.00	1.00	1.06	1.00	1.00	1.06	1.00
Lanes:	2.00	3.00	1.00	2.00	3.00	1.00	2.00	3.00	1.00	2.00	3.00	1.00
Final Sat.:	3200	5100	1600	3200	5100	1600	3200	5100	1600	3200	5100	1600

Capacity Analysis Module:

Vol/Sat:	0.06	0.29	0.15	0.03	0.04	0.11	0.13	0.21	0.08	0.03	0.23	0.35	
OvlAdjV/S:							0.00				0.02		
Crit Moves:	****			****			****			****			

Santa Ana Circulation Element

Level Of Service Computation Report

ICU 1(Loss as Cycle Length %) Method (Base Volume Alternative)

Intersection #98 Red Hill Ave and Warner Ave

Cycle (sec): 100 Critical Vol./Cap.(X): 0.875
 Loss Time (sec): 5 Average Delay (sec/veh): xxxxxxx
 Optimal Cycle: 74 Level Of Service: D

Approach:	North Bound			South Bound			East Bound			West Bound		
Movement:	L	T	R	L	T	R	L	T	R	L	T	R
Control:	Protected			Protected			Protected			Protected		
Rights:	Include			Include			Include			Ovl		
Min. Green:	0	0	0	0	0	0	0	0	0	0	0	0
Y+R:	4.0	4.0	4.0	4.0	4.0	4.0	4.0	4.0	4.0	4.0	4.0	4.0
Lanes:	2	0	3	1	0	0	2	0	2	1	0	3

Volume Module:

Base Vol:	374	1281	147	79	304	385	246	668	104	76	1598	210
Growth Adj:	1.00	1.00	1.00	1.00	1.00	1.00	1.00	1.00	1.00	1.00	1.00	1.00
Initial Bse:	374	1281	147	79	304	385	246	668	104	76	1598	210
User Adj:	1.00	1.00	1.00	1.00	1.00	1.00	1.00	1.00	1.00	1.00	1.00	1.00
PHF Adj:	1.00	1.00	1.00	1.00	1.00	1.00	1.00	1.00	1.00	1.00	1.00	1.00
PHF Volume:	374	1281	147	79	304	385	246	668	104	76	1598	210
Reduct Vol:	0	0	0	0	0	0	0	0	0	0	0	0
Reduced Vol:	374	1281	147	79	304	385	246	668	104	76	1598	210
PCE Adj:	1.00	1.00	1.00	1.00	1.00	1.00	1.00	1.00	1.00	1.00	1.00	1.00
MLF Adj:	1.00	1.00	1.00	1.00	1.00	1.00	1.00	1.00	1.00	1.00	1.00	1.00
FinalVolume:	374	1281	147	79	304	385	246	668	104	76	1598	210
OvlAdjVol:												171

Saturation Flow Module:

Sat/Lane:	1600	1600	1600	1600	1600	1600	1600	1600	1600	1600	1600	1600
Adjustment:	1.00	1.05	1.00	1.00	1.06	1.00	1.00	1.05	1.00	1.00	1.06	1.00
Lanes:	2.00	3.59	0.41	2.00	2.00	1.00	1.00	2.60	0.40	2.00	3.00	1.00
Final Sat.:	3200	6041	659	3200	3400	1600	1600	4353	647	3200	5100	1600

Capacity Analysis Module:

Vol/Sat:	0.12	0.21	0.22	0.02	0.09	0.24	0.15	0.15	0.16	0.02	0.31	0.13
OvlAdjV/S:												0.11
Crit Moves:	****			****			****			****		

Santa Ana Circulation Element

Level Of Service Computation Report

ICU 1(Loss as Cycle Length %) Method (Base Volume Alternative)

Intersection #99 Red Hill Ave and Dyer Rd / barranca Pkwy

Cycle (sec): 100 Critical Vol./Cap.(X): 0.537
 Loss Time (sec): 5 Average Delay (sec/veh): xxxxxxx
 Optimal Cycle: 25 Level Of Service: A

Approach:	North Bound			South Bound			East Bound			West Bound		
Movement:	L	T	R	L	T	R	L	T	R	L	T	R
Control:	Protected			Protected			Protected			Protected		
Rights:	Include			Include			Include			Include		
Min. Green:	0	0	0	0	0	0	0	0	0	0	0	0
Y+R:	4.0	4.0	4.0	4.0	4.0	4.0	4.0	4.0	4.0	4.0	4.0	4.0
Lanes:	2	0	4	0	1		2	0	4	0	1	

Volume Module:

Base Vol:	338	1270	327	241	408	192	172	637	84	110	839	245
Growth Adj:	1.00	1.00	1.00	1.00	1.00	1.00	1.00	1.00	1.00	1.00	1.00	1.00
Initial Bse:	338	1270	327	241	408	192	172	637	84	110	839	245
User Adj:	1.00	1.00	1.00	1.00	1.00	1.00	1.00	1.00	1.00	1.00	1.00	1.00
PHF Adj:	1.00	1.00	1.00	1.00	1.00	1.00	1.00	1.00	1.00	1.00	1.00	1.00
PHF Volume:	338	1270	327	241	408	192	172	637	84	110	839	245
Reduct Vol:	0	0	0	0	0	0	0	0	0	0	0	0
Reduced Vol:	338	1270	327	241	408	192	172	637	84	110	839	245
PCE Adj:	1.00	1.00	1.00	1.00	1.00	1.00	1.00	1.00	1.00	1.00	1.00	1.00
MLF Adj:	1.00	1.00	1.00	1.00	1.00	1.00	1.00	1.00	1.00	1.00	1.00	1.00
FinalVolume:	338	1270	327	241	408	192	172	637	84	110	839	245

Saturation Flow Module:

Sat/Lane:	1600	1600	1600	1600	1600	1600	1600	1600	1600	1600	1600	1600
Adjustment:	1.00	1.06	1.00	1.00	1.06	1.00	1.00	1.05	1.00	1.00	1.06	1.00
Lanes:	2.00	4.00	1.00	2.00	4.00	1.00	2.00	3.53	0.47	2.00	4.00	1.00
Final Sat.:	3200	6800	1600	3200	6800	1600	3200	5954	746	3200	6800	1600

Capacity Analysis Module:

Vol/Sat:	0.11	0.19	0.20	0.08	0.06	0.12	0.05	0.11	0.11	0.03	0.12	0.15
Crit Moves:	****			****			****			****		

Santa Ana Circulation Element

Level Of Service Computation Report

ICU 1(Loss as Cycle Length %) Method (Base Volume Alternative)

Intersection #100 Red Hill Ave and Alton Pkwy

Cycle (sec): 100 Critical Vol./Cap.(X): 1.184
 Loss Time (sec): 5 Average Delay (sec/veh): xxxxxx
 Optimal Cycle: 180 Level Of Service: F

Approach:	North Bound			South Bound			East Bound			West Bound		
Movement:	L	T	R	L	T	R	L	T	R	L	T	R
Control:	Protected			Protected			Protected			Protected		
Rights:	Include			Include			Include			Include		
Min. Green:	0	0	0	0	0	0	0	0	0	0	0	0
Y+R:	4.0	4.0	4.0	4.0	4.0	4.0	4.0	4.0	4.0	4.0	4.0	4.0
Lanes:	1	0	3	0	1	1	1	0	2	0	1	0

Volume Module:	North Bound			South Bound			East Bound			West Bound		
Base Vol:	26	1458	211	122	519	4	434	1065	545	1299	222	801
Growth Adj:	1.00	1.00	1.00	1.00	1.00	1.00	1.00	1.00	1.00	1.00	1.00	1.00
Initial Bse:	26	1458	211	122	519	4	434	1065	545	1299	222	801
User Adj:	1.00	1.00	1.00	1.00	1.00	1.00	1.00	1.00	1.00	1.00	1.00	1.00
PHF Adj:	1.00	1.00	1.00	1.00	1.00	1.00	1.00	1.00	1.00	1.00	1.00	1.00
PHF Volume:	26	1458	211	122	519	4	434	1065	545	1299	222	801
Reduct Vol:	0	0	0	0	0	0	0	0	0	0	0	0
Reduced Vol:	26	1458	211	122	519	4	434	1065	545	1299	222	801
PCE Adj:	1.00	1.00	1.00	1.00	1.00	1.00	1.00	1.00	1.00	1.00	1.00	1.00
MLF Adj:	1.00	1.00	1.00	1.00	1.00	1.00	1.00	1.00	1.00	1.00	1.00	1.00
FinalVolume:	26	1458	211	122	519	4	434	1065	545	1299	222	801

Saturation Flow Module:	North Bound			South Bound			East Bound			West Bound		
Sat/Lane:	1600	1600	1600	1600	1600	1600	1600	1600	1600	1600	1600	1600
Adjustment:	1.00	1.06	1.00	1.00	1.06	1.00	1.00	1.06	1.00	1.00	1.06	1.00
Lanes:	1.00	3.00	1.00	1.00	3.00	1.00	1.00	2.00	1.00	2.00	1.00	1.00
Final Sat.:	1600	5100	1600	1600	5100	1600	1600	3400	1600	3200	1700	1600

Capacity Analysis Module:	North Bound			South Bound			East Bound			West Bound		
Vol/Sat:	0.02	0.29	0.13	0.08	0.10	0.00	0.27	0.31	0.34	0.41	0.13	0.50
Crit Moves:	****			****			****			****		

Santa Ana Circulation Element

Level Of Service Computation Report

ICU 1(Loss as Cycle Length %) Method (Base Volume Alternative)

 Intersection #101 Red Hill Ave and MacArthur Blvd

Cycle (sec): 100 Critical Vol./Cap.(X): 0.702
 Loss Time (sec): 5 Average Delay (sec/veh): xxxxxx
 Optimal Cycle: 37 Level Of Service: C

Approach:	North Bound			South Bound			East Bound			West Bound		
Movement:	L	T	R	L	T	R	L	T	R	L	T	R
Control:	Protected			Protected			Protected			Protected		
Rights:	Include			Ignore			Include			Ignore		
Min. Green:	0	0	0	0	0	0	0	0	0	0	0	0
Y+R:	4.0	4.0	4.0	4.0	4.0	4.0	4.0	4.0	4.0	4.0	4.0	4.0
Lanes:	2	0	2	1	0	0	2	0	3	0	1	0

Volume Module:

Base Vol:	175	1133	14	315	654	1148	499	230	35	39	810	568
Growth Adj:	1.00	1.00	1.00	1.00	1.00	1.00	1.00	1.00	1.00	1.00	1.00	1.00
Initial Bse:	175	1133	14	315	654	1148	499	230	35	39	810	568
User Adj:	1.00	1.00	1.00	1.00	1.00	0.00	1.00	1.00	1.00	1.00	1.00	0.00
PHF Adj:	1.00	1.00	1.00	1.00	1.00	0.00	1.00	1.00	1.00	1.00	1.00	0.00
PHF Volume:	175	1133	14	315	654	0	499	230	35	39	810	0
Reduct Vol:	0	0	0	0	0	0	0	0	0	0	0	0
Reduced Vol:	175	1133	14	315	654	0	499	230	35	39	810	0
PCE Adj:	1.00	1.00	1.00	1.00	1.00	0.00	1.00	1.00	1.00	1.00	1.00	0.00
MLF Adj:	1.00	1.00	1.00	1.00	1.00	0.00	1.00	1.00	1.00	1.00	1.00	0.00
Final Volume:	175	1133	14	315	654	0	499	230	35	39	810	0

Saturation Flow Module:

Sat/Lane:	1600	1600	1600	1600	1600	1600	1600	1600	1600	1600	1600	1600
Adjustment:	1.00	1.04	1.00	1.00	1.06	1.00	1.00	1.06	1.00	1.00	1.06	1.00
Lanes:	2.00	2.96	0.04	2.00	3.00	1.00	2.00	3.00	1.00	1.00	3.00	1.00
Final Sat.:	3200	4941	59	3200	5100	1600	3200	5100	1600	1600	5100	1600

Capacity Analysis Module:

Vol/Sat:	0.05	0.23	0.24	0.10	0.13	0.00	0.16	0.05	0.02	0.02	0.16	0.00
Crit Moves:			****	****			****				****	

Santa Ana Circulation Element

Level Of Service Computation Report

ICU 1(Loss as Cycle Length %) Method (Base Volume Alternative)

Intersection #102 Red Hill Ave and Main St

Cycle (sec): 100 Critical Vol./Cap.(X): 0.813
 Loss Time (sec): 5 Average Delay (sec/veh): xxxxxx
 Optimal Cycle: 55 Level Of Service: D

Approach:	North Bound			South Bound			East Bound			West Bound		
Movement:	L	T	R	L	T	R	L	T	R	L	T	R
Control:	Protected			Protected			Protected			Protected		
Rights:	Include			Include			Include			Include		
Min. Green:	0	0	0	0	0	0	0	0	0	0	0	0
Y+R:	4.0	4.0	4.0	4.0	4.0	4.0	4.0	4.0	4.0	4.0	4.0	4.0
Lanes:	2	0	2	0	2	0	1	2	0	2	1	0

Volume Module:

Base Vol:	436	941	254	88	640	348	200	714	193	277	1575	88
Growth Adj:	1.00	1.00	1.00	1.00	1.00	1.00	1.00	1.00	1.00	1.00	1.00	1.00
Initial Bse:	436	941	254	88	640	348	200	714	193	277	1575	88
User Adj:	1.00	1.00	1.00	1.00	1.00	1.00	1.00	1.00	1.00	1.00	1.00	1.00
PHF Adj:	1.00	1.00	1.00	1.00	1.00	1.00	1.00	1.00	1.00	1.00	1.00	1.00
PHF Volume:	436	941	254	88	640	348	200	714	193	277	1575	88
Reduct Vol:	0	0	0	0	0	0	0	0	0	0	0	0
Reduced Vol:	436	941	254	88	640	348	200	714	193	277	1575	88
PCE Adj:	1.00	1.00	1.00	1.00	1.00	1.00	1.00	1.00	1.00	1.00	1.00	1.00
MLF Adj:	1.00	1.00	1.00	1.00	1.00	1.00	1.00	1.00	1.00	1.00	1.00	1.00
FinalVolume:	436	941	254	88	640	348	200	714	193	277	1575	88

Saturation Flow Module:

Sat/Lane:	1600	1600	1600	1600	1600	1600	1600	1600	1600	1600	1600	1600
Adjustment:	1.00	1.06	1.00	1.00	1.06	1.00	1.00	1.05	1.00	1.00	1.04	1.00
Lanes:	2.00	2.00	1.00	2.00	2.00	1.00	2.00	2.36	0.64	2.00	2.84	0.16
Final Sat.:	3200	3400	1600	3200	3400	1600	3200	3979	1021	3200	4746	254

Capacity Analysis Module:

Vol/Sat:	0.14	0.28	0.16	0.03	0.19	0.22	0.06	0.18	0.19	0.09	0.33	0.35
Crit Moves:	****					****	****					****

Santa Ana Circulation Element

Level of Service Computation Report

2000 HCM Operations Method (Base Volume Alternative)

 Intersection #103 I-5 SB Ramps and Santa Ana Blvd

Cycle (sec): 100 Critical Vol./Cap.(X): 0.487
 Loss Time (sec): 5 Average Delay (sec/veh): 18.4
 Optimal Cycle: 24 Level Of Service: B

Approach:	North Bound			South Bound			East Bound			West Bound		
Movement:	L	T	R	L	T	R	L	T	R	L	T	R
Control:	Split Phase			Split Phase			Protected			Protected		
Rights:	Include			Ovl			Include			Include		
Min. Green:	0	0	0	0	0	0	0	0	0	0	0	0
Y+R:	4.0	4.0	4.0	4.0	4.0	4.0	4.0	4.0	4.0	4.0	4.0	4.0
Lanes:	0	0	0	2	0	0	2	0	3	0	0	2

Volume Module:

Base Vol:	0	0	0	304	0	67	765	865	0	0	621	170
Growth Adj:	1.00	1.00	1.00	1.00	1.00	1.00	1.00	1.00	1.00	1.00	1.00	1.00
Initial Bse:	0	0	0	304	0	67	765	865	0	0	621	170
User Adj:	1.00	1.00	1.00	1.00	1.00	1.00	1.00	1.00	1.00	1.00	1.00	1.00
PHF Adj:	1.00	1.00	1.00	1.00	1.00	1.00	1.00	1.00	1.00	1.00	1.00	1.00
PHF Volume:	0	0	0	304	0	67	765	865	0	0	621	170
Reduct Vol:	0	0	0	0	0	0	0	0	0	0	0	0
Reduced Vol:	0	0	0	304	0	67	765	865	0	0	621	170
PCE Adj:	1.00	1.00	1.00	1.00	1.00	1.00	1.00	1.00	1.00	1.00	1.00	1.00
MLF Adj:	1.00	1.00	1.00	1.00	1.00	1.00	1.00	1.00	1.00	1.00	1.00	1.00
Final Volume:	0	0	0	304	0	67	765	865	0	0	621	170

Saturation Flow Module:

Sat/Lane:	1900	1900	1900	1900	1900	1900	1900	1900	1900	1900	1900	1900
Adjustment:	1.00	1.00	1.00	0.92	1.00	0.85	0.92	0.91	1.00	1.00	0.88	0.88
Lanes:	0.00	0.00	0.00	2.00	0.00	1.00	2.00	3.00	0.00	0.00	2.36	0.64
Final Sat.:	0	0	0	3502	0	1615	3502	5187	0	0	3942	1079

Capacity Analysis Module:

Vol/Sat:	0.00	0.00	0.00	0.09	0.00	0.04	0.22	0.17	0.00	0.00	0.16	0.16
Crit Moves:				****			****			****		
Green/Cycle:	0.00	0.00	0.00	0.18	0.00	0.63	0.45	0.77	0.00	0.00	0.32	0.32
Volume/Cap:	0.00	0.00	0.00	0.49	0.00	0.07	0.49	0.22	0.00	0.00	0.49	0.49
Delay/Veh:	0.0	0.0	0.0	37.6	0.0	7.3	19.7	3.2	0.0	0.0	27.4	27.4
User DelAdj:	1.00	1.00	1.00	1.00	1.00	1.00	1.00	1.00	1.00	1.00	1.00	1.00

AdjDel/Veh:	0.0	0.0	0.0	37.6	0.0	7.3	19.7	3.2	0.0	0.0	27.4	27.4
LOS by Move:	A	A	A	D	A	A	B	A	A	A	C	C
HCM2k85thQ:	0	0	0	8	0	1	13	4	0	0	11	11

Note: Queue reported is the number of cars per lane.

Santa Ana Circulation Element

Level Of Service Computation Report

ICU 1(Loss as Cycle Length %) Method (Base Volume Alternative)

 Intersection #104 Tustin Ranch Rd and Warner Ave

Cycle (sec): 100 Critical Vol./Cap.(X): 0.645
 Loss Time (sec): 5 Average Delay (sec/veh): xxxxxx
 Optimal Cycle: 32 Level Of Service: B

Approach:	North Bound			South Bound			East Bound			West Bound		
Movement:	L	T	R	L	T	R	L	T	R	L	T	R
Control:	Split Phase			Split Phase			Protected			Protected		
Rights:	Include			Include			Include			Ovl		
Min. Green:	0	0	0	0	0	0	0	0	0	0	0	0
Y+R:	4.0	4.0	4.0	4.0	4.0	4.0	4.0	4.0	4.0	4.0	4.0	4.0
Lanes:	0	0	0	2	0	0	2	0	3	0	0	3

Volume Module:

Base Vol:	0	0	0	553	0	38	65	2154	0	0	856	369
Growth Adj:	1.00	1.00	1.00	1.00	1.00	1.00	1.00	1.00	1.00	1.00	1.00	1.00
Initial Bse:	0	0	0	553	0	38	65	2154	0	0	856	369
User Adj:	1.00	1.00	1.00	1.00	1.00	1.00	1.00	1.00	1.00	1.00	1.00	1.00
PHF Adj:	1.00	1.00	1.00	1.00	1.00	1.00	1.00	1.00	1.00	1.00	1.00	1.00
PHF Volume:	0	0	0	553	0	38	65	2154	0	0	856	369
Reduct Vol:	0	0	0	0	0	0	0	0	0	0	0	0
Reduced Vol:	0	0	0	553	0	38	65	2154	0	0	856	369
PCE Adj:	1.00	1.00	1.00	1.00	1.00	1.00	1.00	1.00	1.00	1.00	1.00	1.00
MLF Adj:	1.00	1.00	1.00	1.00	1.00	1.00	1.00	1.00	1.00	1.00	1.00	1.00
FinalVolume:	0	0	0	553	0	38	65	2154	0	0	856	369
OvlAdjVol:												92

Saturation Flow Module:

Sat/Lane:	1600	1600	1600	1600	1600	1600	1600	1600	1600	1600	1600	1600
Adjustment:	1.00	1.06	1.00	1.00	1.06	1.00	1.00	1.06	1.00	1.00	1.06	1.00
Lanes:	0.00	0.00	0.00	2.00	0.00	1.00	2.00	3.00	0.00	0.00	3.00	1.00
Final Sat.:	0	0	0	3200	0	1600	3200	5100	0	0	5100	1600

Capacity Analysis Module:

Vol/Sat:	0.00	0.00	0.00	0.17	0.00	0.02	0.02	0.42	0.00	0.00	0.17	0.23
OvlAdjV/S:												0.06
Crit Moves:				****				****				****

Santa Ana Circulation Element

Level Of Service Computation Report

ICU 1(Loss as Cycle Length %) Method (Base Volume Alternative)

Intersection #105 Von Karman Ave and Barranca Pkwy

Cycle (sec): 100 Critical Vol./Cap.(X): 1.228
 Loss Time (sec): 5 Average Delay (sec/veh): xxxxxxx
 Optimal Cycle: 180 Level Of Service: F

Approach:	North Bound			South Bound			East Bound			West Bound							
Movement:	L	T	R	L	T	R	L	T	R	L	T	R					
Control:	Protected			Protected			Protected			Protected							
Rights:	Include			Ovl			Include			Include							
Min. Green:	0	0	0	0	0	0	0	0	0	0	0	0					
Y+R:	4.0	4.0	4.0	4.0	4.0	4.0	4.0	4.0	4.0	4.0	4.0	4.0					
Lanes:	2	0	1	1	0	0	2	0	2	0	2	1	2	0	4	0	1

Volume Module:

Base Vol:	346	1992	434	80	407	280	765	1397	195	232	734	250
Growth Adj:	1.00	1.00	1.00	1.00	1.00	1.00	1.00	1.00	1.00	1.00	1.00	1.00
Initial Bse:	346	1992	434	80	407	280	765	1397	195	232	734	250
User Adj:	1.00	1.00	1.00	1.00	1.00	1.00	1.00	1.00	1.00	1.00	1.00	1.00
PHF Adj:	1.00	1.00	1.00	1.00	1.00	1.00	1.00	1.00	1.00	1.00	1.00	1.00
PHF Volume:	346	1992	434	80	407	280	765	1397	195	232	734	250
Reduct Vol:	0	0	0	0	0	0	0	0	0	0	0	0
Reduced Vol:	346	1992	434	80	407	280	765	1397	195	232	734	250
PCE Adj:	1.00	1.00	1.00	1.00	1.00	1.00	1.00	1.00	1.00	1.00	1.00	1.00
MLF Adj:	1.00	1.00	1.00	1.00	1.00	1.00	1.00	1.00	1.00	1.00	1.00	1.00
FinalVolume:	346	1992	434	80	407	280	765	1397	195	232	734	250
OvlAdjVol:	0											

Saturation Flow Module:

Sat/Lane:	1600	1600	1600	1600	1600	1600	1600	1600	1600	1600	1600	1600
Adjustment:	1.00	1.04	1.00	1.00	1.06	1.00	1.00	1.06	1.00	1.00	1.06	1.00
Lanes:	2.00	1.64	0.36	2.00	2.00	2.00	2.00	3.00	1.00	2.00	4.00	1.00
Final Sat.:	3200	2728	572	3200	3400	3200	3200	5100	1600	3200	6800	1600

Capacity Analysis Module:

Vol/Sat:	0.11	0.73	0.76	0.03	0.12	0.09	0.24	0.27	0.12	0.07	0.11	0.16
OvlAdjV/S:							0.00					
Crit Moves:	****			****			****			****		

Santa Ana Circulation Element

Level Of Service Computation Report

ICU 1(Loss as Cycle Length %) Method (Base Volume Alternative)

Intersection #106 Red Hill Avenue and El Camino Real

Cycle (sec): 100 Critical Vol./Cap.(X): 0.779
 Loss Time (sec): 5 Average Delay (sec/veh): xxxxxx
 Optimal Cycle: 48 Level Of Service: C

Street Name:	Red Hill Avenue					El Camino Real						
	North Bound			South Bound		East Bound			West Bound			
Approach:	L	T	R	L	T	R	L	T	R	L	T	R
Control:	Protected			Protected			Protected			Protected		
Rights:	Include			Include			Include			Include		
Min. Green:	0	0	0	0	0	0	0	0	0	0	0	0
Y+R:	4.0	4.0	4.0	4.0	4.0	4.0	4.0	4.0	4.0	4.0	4.0	4.0
Lanes:	2	0	3	0	1	1	0	2	1	0	1	0

Volume Module:												
Base Vol:	421	1334	246	20	728	96	70	153	201	332	548	63
Growth Adj:	1.00	1.00	1.00	1.00	1.00	1.00	1.00	1.00	1.00	1.00	1.00	1.00
Initial Bse:	421	1334	246	20	728	96	70	153	201	332	548	63
User Adj:	1.00	1.00	1.00	1.00	1.00	1.00	1.00	1.00	1.00	1.00	1.00	1.00
PHF Adj:	1.00	1.00	1.00	1.00	1.00	1.00	1.00	1.00	1.00	1.00	1.00	1.00
PHF Volume:	421	1334	246	20	728	96	70	153	201	332	548	63
Reduct Vol:	0	0	0	0	0	0	0	0	0	0	0	0
Reduced Vol:	421	1334	246	20	728	96	70	153	201	332	548	63
PCE Adj:	1.00	1.00	1.00	1.00	1.00	1.00	1.00	1.00	1.00	1.00	1.00	1.00
MLF Adj:	1.00	1.00	1.00	1.00	1.00	1.00	1.00	1.00	1.00	1.00	1.00	1.00
FinalVolume:	421	1334	246	20	728	96	70	153	201	332	548	63

Saturation Flow Module:												
Sat/Lane:	1600	1600	1600	1600	1600	1600	1600	1600	1600	1600	1600	1600
Adjustment:	1.00	1.06	1.00	1.00	1.05	1.00	1.00	1.06	1.00	1.00	1.00	1.00
Lanes:	2.00	3.00	1.00	1.00	2.65	0.35	1.00	1.00	1.00	1.00	0.90	0.10
Final Sat.:	3200	5100	1600	1600	4441	559	1600	1700	1600	1600	1435	165

Capacity Analysis Module:												
Vol/Sat:	0.13	0.26	0.15	0.01	0.16	0.17	0.04	0.09	0.13	0.21	0.38	0.38
Crit Moves:	****					****	****				****	

Santa Ana Circulation Element

Level Of Service Computation Report
 2000 HCM Operations Method (Base Volume Alternative)

 Intersection #107 Red Hill Avenue and I-5 NB Ramps

Cycle (sec): 100 Critical Vol./Cap.(X): 0.634
 Loss Time (sec): 5 Average Delay (sec/veh): 23.7
 Optimal Cycle: 33 Level Of Service: C

Street Name:	Red Hill Avenue						I-5 NB Ramps					
Approach:	North Bound			South Bound			East Bound			West Bound		
Movement:	L	T	R	L	T	R	L	T	R	L	T	R
Control:	Protected			Protected			Permitted			Permitted		
Rights:	Include			Include			Include			Include		
Min. Green:	0	0	0	0	0	0	0	0	0	0	0	0
Y+R:	4.0	4.0	4.0	4.0	4.0	4.0	4.0	4.0	4.0	4.0	4.0	4.0
Lanes:	1	0	3	0	0	3	0	0	0	1	1	0

Volume Module:												
Base Vol:	277	1585	0	0	921	186	0	0	0	264	99	428
Growth Adj:	1.00	1.00	1.00	1.00	1.00	1.00	1.00	1.00	1.00	1.00	1.00	1.00
Initial Bse:	277	1585	0	0	921	186	0	0	0	264	99	428
User Adj:	1.00	1.00	1.00	1.00	1.00	1.00	1.00	1.00	1.00	1.00	1.00	1.00
PHF Adj:	1.00	1.00	1.00	1.00	1.00	1.00	1.00	1.00	1.00	1.00	1.00	1.00
PHF Volume:	277	1585	0	0	921	186	0	0	0	264	99	428
Reduct Vol:	0	0	0	0	0	0	0	0	0	0	0	0
Reduced Vol:	277	1585	0	0	921	186	0	0	0	264	99	428
PCE Adj:	1.00	1.00	1.00	1.00	1.00	1.00	1.00	1.00	1.00	1.00	1.00	1.00
MLF Adj:	1.00	1.00	1.00	1.00	1.00	1.00	1.00	1.00	1.00	1.00	1.00	1.00
FinalVolume:	277	1585	0	0	921	186	0	0	0	264	99	428

Saturation Flow Module:												
Sat/Lane:	1900	1900	1900	1900	1900	1900	1900	1900	1900	1900	1900	1900
Adjustment:	0.95	0.91	1.00	1.00	0.91	0.85	1.00	1.00	1.00	0.83	0.83	0.83
Lanes:	1.00	3.00	0.00	0.00	3.00	1.00	0.00	0.00	0.00	1.45	0.55	1.00
Final Sat.:	1805	5187	0	0	5187	1615	0	0	0	2292	860	1576

Capacity Analysis Module:												
Vol/Sat:	0.15	0.31	0.00	0.00	0.18	0.12	0.00	0.00	0.00	0.12	0.12	0.27
Crit Moves:	****			****								****
Green/Cycle:	0.24	0.52	0.00	0.00	0.28	0.28	0.00	0.00	0.00	0.43	0.43	0.43
Volume/Cap:	0.63	0.59	0.00	0.00	0.63	0.41	0.00	0.00	0.00	0.27	0.27	0.63
Delay/Veh:	37.0	16.8	0.0	0.0	32.5	29.9	0.0	0.0	0.0	18.5	18.5	23.5
User DelAdj:	1.00	1.00	1.00	1.00	1.00	1.00	1.00	1.00	1.00	1.00	1.00	1.00

AdjDel/Veh:	37.0	16.8	0.0	0.0	32.5	29.9	0.0	0.0	0.0	18.5	18.5	23.5
LOS by Move:	D	B	A	A	C	C	A	A	A	B	B	C
HCM2k85thQ:	13	19	0	0	15	8	0	0	0	6	6	17

Note: Queue reported is the number of cars per lane.

Santa Ana Circulation Element

Level of Service Computation Report
 2000 HCM Operations Method (Base Volume Alternative)

 Intersection #108 Red Hill Avenue and I-5 SB Ramps

Cycle (sec): 100 Critical Vol./Cap.(X): 0.695
 Loss Time (sec): 5 Average Delay (sec/veh): 22.2
 Optimal Cycle: 38 Level Of Service: C

Street Name:	Red Hill Avenue						I-5 SB Ramps					
	North Bound			South Bound			East Bound			West Bound		
Approach:	North Bound			South Bound			East Bound			West Bound		
Movement:	L	T	R	L	T	R	L	T	R	L	T	R
Control:	Protected			Protected			Permitted			Permitted		
Rights:	Include			Include			Include			Include		
Min. Green:	0	0	0	0	0	0	0	0	0	0	0	0
Y+R:	4.0	4.0	4.0	4.0	4.0	4.0	4.0	4.0	4.0	4.0	4.0	4.0
Lanes:	0	0	4	0	1	0	1	0	0	0	1	0

Volume Module:												
Base Vol:	0	1551	492	334	802	0	296	3	265	0	0	0
Growth Adj:	1.00	1.00	1.00	1.00	1.00	1.00	1.00	1.00	1.00	1.00	1.00	1.00
Initial Bse:	0	1551	492	334	802	0	296	3	265	0	0	0
User Adj:	1.00	1.00	1.00	1.00	1.00	1.00	1.00	1.00	1.00	1.00	1.00	1.00
PHF Adj:	1.00	1.00	1.00	1.00	1.00	1.00	1.00	1.00	1.00	1.00	1.00	1.00
PHF Volume:	0	1551	492	334	802	0	296	3	265	0	0	0
Reduct Vol:	0	0	0	0	0	0	0	0	0	0	0	0
Reduced Vol:	0	1551	492	334	802	0	296	3	265	0	0	0
PCE Adj:	1.00	1.00	1.00	1.00	1.00	1.00	1.00	1.00	1.00	1.00	1.00	1.00
MLF Adj:	1.00	1.00	1.00	1.00	1.00	1.00	1.00	1.00	1.00	1.00	1.00	1.00
FinalVolume:	0	1551	492	334	802	0	296	3	265	0	0	0

Saturation Flow Module:												
Sat/Lane:	1900	1900	1900	1900	1900	1900	1900	1900	1900	1900	1900	1900
Adjustment:	1.00	0.91	0.85	0.95	0.91	1.00	0.92	0.92	0.85	1.00	1.00	1.00
Lanes:	0.00	4.00	1.00	1.00	3.00	0.00	0.99	0.01	1.00	0.00	0.00	0.00
Final Sat.:	0	6916	1615	1805	5187	0	1732	18	1615	0	0	0

Capacity Analysis Module:												
Vol/Sat:	0.00	0.22	0.30	0.19	0.15	0.00	0.17	0.17	0.16	0.00	0.00	0.00
Crit Moves:	****			****			****			****		
Green/Cycle:	0.00	0.44	0.44	0.27	0.70	0.00	0.25	0.25	0.25	0.00	0.00	0.00
Volume/Cap:	0.00	0.51	0.70	0.70	0.22	0.00	0.70	0.70	0.67	0.00	0.00	0.00
Delay/Veh:	0.0	20.5	25.7	37.5	5.2	0.0	39.2	39.2	38.4	0.0	0.0	0.0
User DelAdj:	1.00	1.00	1.00	1.00	1.00	1.00	1.00	1.00	1.00	1.00	1.00	1.00
AdjDel/Veh:	0.0	20.5	25.7	37.5	5.2	0.0	39.2	39.2	38.4	0.0	0.0	0.0
LOS by Move:	A	C	C	D	A	A	D	D	D	A	A	A
HCM2k85thQ:	0	15	20	16	5	0	15	15	13	0	0	0

 Note: Queue reported is the number of cars per lane.

Santa Ana Circulation Element

Level of Service Computation Report

ICU 1(Loss as Cycle Length %) Method (Base Volume Alternative)

Intersection #109 Red Hill Avenue and Nisson Road

Cycle (sec): 100 Critical Vol./Cap.(X): 0.693
 Loss Time (sec): 5 Average Delay (sec/veh): xxxxxx
 Optimal Cycle: 36 Level Of Service: B

Street Name:	Red Hill Avenue						Nisson Road					
	North Bound			South Bound			East Bound			West Bound		
Approach:	North Bound			South Bound			East Bound			West Bound		
Movement:	L	T	R	L	T	R	L	T	R	L	T	R
Control:	Protected			Protected			Split Phase			Split Phase		
Rights:	Include			Include			Include			Include		
Min. Green:	0	0	0	0	0	0	0	0	0	0	0	0
Y+R:	4.0	4.0	4.0	4.0	4.0	4.0	4.0	4.0	4.0	4.0	4.0	4.0
Lanes:	1	0	3	1	0	2	1	0	0	1	0	1

Volume Module:

Base Vol:	31	1614	33	146	750	75	247	90	40	48	83	141
Growth Adj:	1.00	1.00	1.00	1.00	1.00	1.00	1.00	1.00	1.00	1.00	1.00	1.00
Initial Bse:	31	1614	33	146	750	75	247	90	40	48	83	141
User Adj:	1.00	1.00	1.00	1.00	1.00	1.00	1.00	1.00	1.00	1.00	1.00	1.00
PHF Adj:	1.00	1.00	1.00	1.00	1.00	1.00	1.00	1.00	1.00	1.00	1.00	1.00
PHF Volume:	31	1614	33	146	750	75	247	90	40	48	83	141
Reduct Vol:	0	0	0	0	0	0	0	0	0	0	0	0
Reduced Vol:	31	1614	33	146	750	75	247	90	40	48	83	141
PCE Adj:	1.00	1.00	1.00	1.00	1.00	1.00	1.00	1.00	1.00	1.00	1.00	1.00
MLF Adj:	1.00	1.00	1.00	1.00	1.00	1.00	1.00	1.00	1.00	1.00	1.00	1.00
FinalVolume:	31	1614	33	146	750	75	247	90	40	48	83	141

Saturation Flow Module:

Sat/Lane:	1600	1600	1600	1600	1600	1600	1600	1600	1600	1600	1600	1600
Adjustment:	1.00	1.05	1.00	1.00	1.05	1.00	1.00	1.00	1.00	1.00	1.00	1.00
Lanes:	1.00	3.92	0.08	1.00	2.73	0.27	1.00	0.69	0.31	1.00	0.37	0.63
Final Sat.:	1600	6572	128	1600	4564	436	1600	1108	492	1600	593	1007

Capacity Analysis Module:

Vol/Sat:	0.02	0.25	0.26	0.09	0.16	0.17	0.15	0.08	0.08	0.03	0.14	0.14
Crit Moves:			****	****			****			****		

Santa Ana Circulation Element

Level Of Service Computation Report

ICU 1(Loss as Cycle Length %) Method (Base Volume Alternative)

Intersection #110 Red Hill Avenue and Walnut Avenue

Cycle (sec): 100 Critical Vol./Cap.(X): 0.739
 Loss Time (sec): 5 Average Delay (sec/veh): xxxxxx
 Optimal Cycle: 42 Level Of Service: C

Street Name:	Red Hill Avenue						Walnut Avenue					
Approach:	North Bound			South Bound			East Bound			West Bound		
Movement:	L	T	R	L	T	R	L	T	R	L	T	R
Control:	Protected			Protected			Protected			Protected		
Rights:	Include			Include			Include			Include		
Min. Green:	0	0	0	0	0	0	0	0	0	0	0	0
Y+R:	4.0	4.0	4.0	4.0	4.0	4.0	4.0	4.0	4.0	4.0	4.0	4.0
Lanes:	1	0	2	1	0	2	1	0	1	1	0	1

Volume Module:

Base Vol:	273	1325	95	128	396	165	88	211	87	196	654	171
Growth Adj:	1.00	1.00	1.00	1.00	1.00	1.00	1.00	1.00	1.00	1.00	1.00	1.00
Initial Bse:	273	1325	95	128	396	165	88	211	87	196	654	171
User Adj:	1.00	1.00	1.00	1.00	1.00	1.00	1.00	1.00	1.00	1.00	1.00	1.00
PHF Adj:	1.00	1.00	1.00	1.00	1.00	1.00	1.00	1.00	1.00	1.00	1.00	1.00
PHF Volume:	273	1325	95	128	396	165	88	211	87	196	654	171
Reduct Vol:	0	0	0	0	0	0	0	0	0	0	0	0
Reduced Vol:	273	1325	95	128	396	165	88	211	87	196	654	171
PCE Adj:	1.00	1.00	1.00	1.00	1.00	1.00	1.00	1.00	1.00	1.00	1.00	1.00
MLF Adj:	1.00	1.00	1.00	1.00	1.00	1.00	1.00	1.00	1.00	1.00	1.00	1.00
FinalVolume:	273	1325	95	128	396	165	88	211	87	196	654	171

Saturation Flow Module:

Sat/Lane:	1600	1600	1600	1600	1600	1600	1600	1600	1600	1600	1600	1600
Adjustment:	1.00	1.04	1.00	1.00	1.06	1.00	1.00	1.04	1.00	1.00	1.04	1.00
Lanes:	1.00	2.80	0.20	1.00	2.12	0.88	1.00	1.42	0.58	2.00	1.59	0.41
Final Sat.:	1600	4679	321	1600	3588	1412	1600	2366	934	3200	2637	663

Capacity Analysis Module:

Vol/Sat:	0.17	0.28	0.30	0.08	0.11	0.12	0.06	0.09	0.09	0.06	0.25	0.26
Crit Moves:			****	****			****					****

Santa Ana Circulation Element

Level Of Service Computation Report

ICU 1(Loss as Cycle Length %) Method (Base Volume Alternative)

Intersection #111 Red Hill Avenue and Valencia Avenue

Cycle (sec): 100 Critical Vol./Cap.(X): 0.738
 Loss Time (sec): 5 Average Delay (sec/veh): xxxxxx
 Optimal Cycle: 42 Level Of Service: C

Street Name:	Red Hill Avenue						Valencia Avenue					
Approach:	North Bound			South Bound			East Bound			West Bound		
Movement:	L	T	R	L	T	R	L	T	R	L	T	R
Control:	Protected			Protected			Protected			Protected		
Rights:	Ovl			Include			Include			Ovl		
Min. Green:	0	0	0	0	0	0	0	0	0	0	0	0
Y+R:	4.0	4.0	4.0	4.0	4.0	4.0	4.0	4.0	4.0	4.0	4.0	4.0
Lanes:	1	0	3	1	0	2	1	0	1	2	0	1

Volume Module:

Base Vol:	241	1791	295	109	438	49	100	270	119	291	422	279
Growth Adj:	1.00	1.00	1.00	1.00	1.00	1.00	1.00	1.00	1.00	1.00	1.00	1.00
Initial Bse:	241	1791	295	109	438	49	100	270	119	291	422	279
User Adj:	1.00	1.00	1.00	1.00	1.00	1.00	1.00	1.00	1.00	1.00	1.00	1.00
PHF Adj:	1.00	1.00	1.00	1.00	1.00	1.00	1.00	1.00	1.00	1.00	1.00	1.00
PHF Volume:	241	1791	295	109	438	49	100	270	119	291	422	279
Reduct Vol:	0	0	0	0	0	0	0	0	0	0	0	0
Reduced Vol:	241	1791	295	109	438	49	100	270	119	291	422	279
PCE Adj:	1.00	1.00	1.00	1.00	1.00	1.00	1.00	1.00	1.00	1.00	1.00	1.00
MLF Adj:	1.00	1.00	1.00	1.00	1.00	1.00	1.00	1.00	1.00	1.00	1.00	1.00
FinalVolume:	241	1791	295	109	438	49	100	270	119	291	422	279
OvlAdjVol:			213									170

Saturation Flow Module:

Sat/Lane:	1600	1600	1600	1600	1600	1600	1600	1600	1600	1600	1600	1600
Adjustment:	1.00	1.05	1.00	1.00	1.05	1.00	1.00	1.06	1.00	1.00	1.06	1.00
Lanes:	1.00	3.43	0.57	1.00	2.70	0.30	1.00	1.00	1.00	2.00	1.00	1.00
Final Sat.:	1600	5795	905	1600	4517	483	1600	1700	1600	3200	1700	1600

Capacity Analysis Module:

Vol/Sat:	0.15	0.31	0.33	0.07	0.10	0.10	0.06	0.16	0.07	0.09	0.25	0.17
OvlAdjV/S:			0.23									0.11
Crit Moves:	****			****			****			****		

Santa Ana Circulation Element

Level of Service Computation Report

ICU 1(Loss as Cycle Length %) Method (Base Volume Alternative)

Intersection #112 Tustin Ranch Road and Warner Avenue North

Cycle (sec): 100 Critical Vol./Cap.(X): 0.885
 Loss Time (sec): 5 Average Delay (sec/veh): xxxxxx
 Optimal Cycle: 79 Level Of Service: D

Street Name:	Tustin Ranch Road						Warner Avenue North					
Approach:	North Bound			South Bound			East Bound			West Bound		
Movement:	L	T	R	L	T	R	L	T	R	L	T	R
Control:	Protected			Protected			Split Phase			Split Phase		
Rights:	Ovl			Include			Include			Ovl		
Min. Green:	0	0	0	0	0	0	0	0	0	0	0	0
Y+R:	4.0	4.0	4.0	4.0	4.0	4.0	4.0	4.0	4.0	4.0	4.0	4.0
Lanes:	0	0	3	0	1		2	0	3	0	0	2

Volume Module:	Tustin Ranch Road			Tustin Ranch Road			Warner Avenue North			Warner Avenue North		
Base Vol:	0	1916	1128	415	610	0	0	0	0	682	0	616
Growth Adj:	1.00	1.00	1.00	1.00	1.00	1.00	1.00	1.00	1.00	1.00	1.00	1.00
Initial Bse:	0	1916	1128	415	610	0	0	0	0	682	0	616
User Adj:	1.00	1.00	1.00	1.00	1.00	1.00	1.00	1.00	1.00	1.00	1.00	1.00
PHF Adj:	1.00	1.00	1.00	1.00	1.00	1.00	1.00	1.00	1.00	1.00	1.00	1.00
PHF Volume:	0	1916	1128	415	610	0	0	0	0	682	0	616
Reduct Vol:	0	0	0	0	0	0	0	0	0	0	0	0
Reduced Vol:	0	1916	1128	415	610	0	0	0	0	682	0	616
PCE Adj:	1.00	1.00	1.00	1.00	1.00	1.00	1.00	1.00	1.00	1.00	1.00	1.00
MLF Adj:	1.00	1.00	1.00	1.00	1.00	1.00	1.00	1.00	1.00	1.00	1.00	1.00
FinalVolume:	0	1916	1128	415	610	0	0	0	0	682	0	616
OvlAdjVol:	901									201		

Saturation Flow Module:	Tustin Ranch Road			Tustin Ranch Road			Warner Avenue North			Warner Avenue North		
Sat/Lane:	1600	1600	1600	1600	1600	1600	1600	1600	1600	1600	1600	1600
Adjustment:	1.00	1.06	1.00	1.00	1.06	1.00	1.00	1.06	1.00	1.00	1.06	1.00
Lanes:	0.00	3.00	1.00	2.00	3.00	0.00	0.00	0.00	0.00	3.00	0.00	2.00
Final Sat.:	0	5100	1600	3200	5100	0	0	0	0	4800	0	3200

Capacity Analysis Module:	Tustin Ranch Road			Tustin Ranch Road			Warner Avenue North			Warner Avenue North		
Vol/Sat:	0.00	0.38	0.71	0.13	0.12	0.00	0.00	0.00	0.00	0.14	0.00	0.19
OvlAdjV/S:	0.56									0.06		
Crit Moves:	****			****						****		

Santa Ana Circulation Element

Level Of Service Computation Report

ICU 1(Loss as Cycle Length %) Method (Base Volume Alternative)

Intersection #113 Tustin Ranch Road and Walnut Avenue

Cycle (sec): 100 Critical Vol./Cap.(X): 1.715

Loss Time (sec): 5 Average Delay (sec/veh): xxxxxx

Optimal Cycle: 180 Level Of Service: F

Street Name:	Tustin Ranch Road						Walnut Avenue					
Approach:	North Bound			South Bound			East Bound			West Bound		
Movement:	L	T	R	L	T	R	L	T	R	L	T	R
Control:	Protected			Protected			Protected			Protected		
Rights:	Ovl			Ovl			Include			Ovl		
Min. Green:	0	0	0	0	0	0	0	0	0	0	0	0
Y+R:	4.0	4.0	4.0	4.0	4.0	4.0	4.0	4.0	4.0	4.0	4.0	4.0
Lanes:	2	0	3	0	1		2	0	3	0	1	

Volume Module:	Tustin Ranch Road			Tustin Ranch Road			Walnut Avenue			Walnut Avenue		
Base Vol:	842	3666	385	550	1460	947	329	402	230	297	1703	1349
Growth Adj:	1.00	1.00	1.00	1.00	1.00	1.00	1.00	1.00	1.00	1.00	1.00	1.00
Initial Bse:	842	3666	385	550	1460	947	329	402	230	297	1703	1349
User Adj:	1.00	1.00	1.00	1.00	1.00	1.00	1.00	1.00	1.00	1.00	1.00	1.00
PHF Adj:	1.00	1.00	1.00	1.00	1.00	1.00	1.00	1.00	1.00	1.00	1.00	1.00
PHF Volume:	842	3666	385	550	1460	947	329	402	230	297	1703	1349
Reduct Vol:	0	0	0	0	0	0	0	0	0	0	0	0
Reduced Vol:	842	3666	385	550	1460	947	329	402	230	297	1703	1349
PCE Adj:	1.00	1.00	1.00	1.00	1.00	1.00	1.00	1.00	1.00	1.00	1.00	1.00
MLF Adj:	1.00	1.00	1.00	1.00	1.00	1.00	1.00	1.00	1.00	1.00	1.00	1.00
FinalVolume:	842	3666	385	550	1460	947	329	402	230	297	1703	1349
OvlAdjVol:	237			783						1074		

Saturation Flow Module:	Tustin Ranch Road			Tustin Ranch Road			Walnut Avenue			Walnut Avenue		
Sat/Lane:	1600	1600	1600	1600	1600	1600	1600	1600	1600	1600	1600	1600
Adjustment:	1.00	1.06	1.00	1.00	1.06	1.00	1.00	1.05	1.00	1.00	1.06	1.00
Lanes:	2.00	3.00	1.00	2.00	3.00	1.00	2.00	1.27	0.73	2.00	2.00	1.00
Final Sat.:	3200	5100	1600	3200	5100	1600	3200	2135	1165	3200	3400	1600

Capacity Analysis Module:	Tustin Ranch Road			Tustin Ranch Road			Walnut Avenue			Walnut Avenue		
Vol/Sat:	0.26	0.72	0.24	0.17	0.29	0.59	0.10	0.19	0.20	0.09	0.50	0.84
OvlAdjV/S:	0.15			0.49						0.67		
Crit Moves:	****			****			****			****		

Santa Ana Circulation Element

Level Of Service Computation Report

2000 HCM Operations Method (Base Volume Alternative)

 Intersection #114 SR-55 SB Ramps and Irvine Boulevard

Cycle (sec): 100 Critical Vol./Cap.(X): 0.915
 Loss Time (sec): 5 Average Delay (sec/veh): 25.6
 Optimal Cycle: 100 Level Of Service: C

Street Name:	SR-55 SB Ramps						Irvine Boulevard					
	North Bound			South Bound			East Bound			West Bound		
Approach:												
Movement:	L	T	R	L	T	R	L	T	R	L	T	R
Control:	Protected			Permitted			Protected			Protected		
Rights:	Include			Include			Include			Include		
Min. Green:	0	0	0	0	0	0	0	0	0	0	0	0
Y+R:	4.0	4.0	4.0	4.0	4.0	4.0	4.0	4.0	4.0	4.0	4.0	4.0
Lanes:	0	0	0	1	0	1	0	0	2	1	0	3

Volume Module:	SR-55 SB Ramps			SR-55 SB Ramps			Irvine Boulevard			Irvine Boulevard		
Base Vol:	0	0	0	467	0	279	0	987	665	461	1324	0
Growth Adj:	1.00	1.00	1.00	1.00	1.00	1.00	1.00	1.00	1.00	1.00	1.00	1.00
Initial Bse:	0	0	0	467	0	279	0	987	665	461	1324	0
User Adj:	1.00	1.00	1.00	1.00	1.00	1.00	1.00	1.00	1.00	1.00	1.00	1.00
PHF Adj:	1.00	1.00	1.00	1.00	1.00	1.00	1.00	1.00	1.00	1.00	1.00	1.00
PHF Volume:	0	0	0	467	0	279	0	987	665	461	1324	0
Reduct Vol:	0	0	0	0	0	0	0	0	0	0	0	0
Reduced Vol:	0	0	0	467	0	279	0	987	665	461	1324	0
PCE Adj:	1.00	1.00	1.00	1.00	1.00	1.00	1.00	1.00	1.00	1.00	1.00	1.00
MLF Adj:	1.00	1.00	1.00	1.00	1.00	1.00	1.00	1.00	1.00	1.00	1.00	1.00
Final Volume:	0	0	0	467	0	279	0	987	665	461	1324	0

Saturation Flow Module:	SR-55 SB Ramps			SR-55 SB Ramps			Irvine Boulevard			Irvine Boulevard		
Sat/Lane:	1900	1900	1900	1900	1900	1900	1900	1900	1900	1900	1900	1900
Adjustment:	1.00	1.00	1.00	0.74	1.00	0.73	1.00	0.86	0.86	0.95	0.91	1.00
Lanes:	0.00	0.00	0.00	1.62	0.00	1.38	0.00	2.00	1.00	1.00	3.00	0.00
Final Sat.:	0	0	0	2278	0	1915	0	3251	1625	1805	5187	0

Capacity Analysis Module:	SR-55 SB Ramps			SR-55 SB Ramps			Irvine Boulevard			Irvine Boulevard			
Vol/Sat:	0.00	0.00	0.00	0.20	0.00	0.15	0.00	0.30	0.41	0.26	0.26	0.00	
Crit Moves:				****				****			****		
Green/Cycle:	0.00	0.00	0.00	0.22	0.00	0.45	0.00	0.45	0.45	0.28	0.73	0.00	
Volume/Cap:	0.00	0.00	0.00	0.92	0.00	0.33	0.00	0.68	0.92	0.92	0.35	0.00	
Delay/Veh:	0.0	0.0	0.0	52.8	0.0	17.9	0.0	22.7	33.6	56.2	5.1	0.0	
User DelAdj:	1.00	1.00	1.00	1.00	1.00	1.00	1.00	1.00	1.00	1.00	1.00	1.00	
AdjDel/Veh:	0.0	0.0	0.0	52.8	0.0	17.9	0.0	22.7	33.6	56.2	5.1	0.0	
LOS by Move:	A	A	A	D	A	B	A	C	C	E	A	A	

```
HCM2k85thQ:    0    0    0   19    0    6    0   21   36   26    9    0
*****
Note: Queue reported is the number of cars per lane.
*****
```

Santa Ana Circulation Element

Level of Service Computation Report
 2000 HCM Operations Method (Base Volume Alternative)

 Intersection #115 SR-55 NB Ramps and Irvine Boulevard

Cycle (sec): 100 Critical Vol./Cap.(X): 0.932
 Loss Time (sec): 5 Average Delay (sec/veh): 22.9
 Optimal Cycle: 113 Level Of Service: C

Street Name:	SR-55 NB Ramps						Irvine Boulevard					
	North Bound			South Bound			East Bound			West Bound		
Approach:	North Bound			South Bound			East Bound			West Bound		
Movement:	L	T	R	L	T	R	L	T	R	L	T	R
Control:	Permitted			Protected			Protected			Protected		
Rights:	Include			Include			Include			Include		
Min. Green:	0	0	0	0	0	0	0	0	0	0	0	0
Y+R:	4.0	4.0	4.0	4.0	4.0	4.0	4.0	4.0	4.0	4.0	4.0	4.0
Lanes:	1	0	1	0	0	0	1	0	3	0	0	2

Volume Module:

Base Vol:	367	18	333	0	0	0	254	1163	0	0	1336	845
Growth Adj:	1.00	1.00	1.00	1.00	1.00	1.00	1.00	1.00	1.00	1.00	1.00	1.00
Initial Bse:	367	18	333	0	0	0	254	1163	0	0	1336	845
User Adj:	1.00	1.00	1.00	1.00	1.00	1.00	1.00	1.00	1.00	1.00	1.00	1.00
PHF Adj:	1.00	1.00	1.00	1.00	1.00	1.00	1.00	1.00	1.00	1.00	1.00	1.00
PHF Volume:	367	18	333	0	0	0	254	1163	0	0	1336	845
Reduct Vol:	0	0	0	0	0	0	0	0	0	0	0	0
Reduced Vol:	367	18	333	0	0	0	254	1163	0	0	1336	845
PCE Adj:	1.00	1.00	1.00	1.00	1.00	1.00	1.00	1.00	1.00	1.00	1.00	1.00
MLF Adj:	1.00	1.00	1.00	1.00	1.00	1.00	1.00	1.00	1.00	1.00	1.00	1.00
Final Volume:	367	18	333	0	0	0	254	1163	0	0	1336	845

Saturation Flow Module:

Sat/Lane:	1900	1900	1900	1900	1900	1900	1900	1900	1900	1900	1900	1900
Adjustment:	0.86	0.86	0.86	1.00	1.00	1.00	0.95	0.91	1.00	1.00	0.86	0.86
Lanes:	1.50	0.05	1.45	0.00	0.00	0.00	1.00	3.00	0.00	0.00	2.00	1.00
Final Sat.:	2444	80	2369	0	0	0	1805	5187	0	0	3257	1629

Capacity Analysis Module:

Vol/Sat:	0.15	0.23	0.14	0.00	0.00	0.00	0.14	0.22	0.00	0.00	0.41	0.52
Crit Moves:	****						****			****		
Green/Cycle:	0.24	0.24	0.24	0.00	0.00	0.00	0.15	0.71	0.00	0.00	0.56	0.56
Volume/Cap:	0.62	0.93	0.58	0.00	0.00	0.00	0.93	0.32	0.00	0.00	0.74	0.93
Delay/Veh:	34.8	55.0	34.1	0.0	0.0	0.0	78.6	5.6	0.0	0.0	17.6	27.9
User DelAdj:	1.00	1.00	1.00	1.00	1.00	1.00	1.00	1.00	1.00	1.00	1.00	1.00
AdjDel/Veh:	34.8	55.0	34.1	0.0	0.0	0.0	78.6	5.6	0.0	0.0	17.6	27.9
LOS by Move:	C	D	C	A	A	A	E	A	A	A	B	C
HCM2k85thQ:	12	23	11	0	0	0	17	8	0	0	26	44

Note: Queue reported is the number of cars per lane.

APPENDIX D.5
ANALYSIS WORKSHEETS –
2045 WP (AM Peak Hour)

Santa Ana Circulation Element

Scenario Report

Scenario: 2045 WP AM Peak Hour
Command: Default Command
Volume: 2045 AM
Geometry: SACE
Impact Fee: Default Impact Fee
Trip Generation: Default Trip Generation
Trip Distribution: Default Trip Distribution
Paths: Default Path
Routes: Default Route
Configuration: Default Configuration

 Santa Ana Circulation Element

 Impact Analysis Report
 Level Of Service

Intersection	Base		Future		Change in
	Del/	V/	Del/	V/	
	LOS	Veh C	LOS	Veh C	
# 1 Euclid St and 1st St	C	xxxxxx 0.789	C	xxxxxx 0.789	+ 0.000 V/C
# 2 Euclid St and McFadden Ave	E	xxxxxx 0.906	E	xxxxxx 0.906	+ 0.000 V/C
# 3 Euclid St and Edinger Ave	F	xxxxxx 1.008	F	xxxxxx 1.008	+ 0.000 V/C
# 4 Newhope St and Hazard Ave	A	xxxxxx 0.600	A	xxxxxx 0.600	+ 0.000 V/C
# 5 Newhope St and McFadden Ave	C	xxxxxx 0.728	C	xxxxxx 0.728	+ 0.000 V/C
# 6 Harbor Blvd and SR-22 WB Off-R	C	28.5 0.715	C	28.5 0.715	+ 0.000 D/V
# 7 Trask Avenue and SR-22 EB On-R	B	11.0 0.389	B	11.0 0.389	+ 0.000 D/V
# 8 Harbor Blvd and Westminster Av	E	xxxxxx 0.936	E	xxxxxx 0.936	+ 0.000 V/C
# 9 Harbor Blvd and 1st St	C	xxxxxx 0.749	C	xxxxxx 0.749	+ 0.000 V/C
# 10 Harbor Blvd and McFadden Ave	C	xxxxxx 0.729	C	xxxxxx 0.729	+ 0.000 V/C
# 11 Harbor Blvd and Edinger Ave	D	xxxxxx 0.857	D	xxxxxx 0.857	+ 0.000 V/C
# 12 Harbor Blvd and Warner Ave	C	xxxxxx 0.800	C	xxxxxx 0.800	+ 0.000 V/C
# 13 Harbor Blvd and Segerstrom Ave	F	xxxxxx 1.007	F	xxxxxx 1.007	+ 0.000 V/C
# 14 MacArthur Blvd and Hyland Ave	B	xxxxxx 0.615	B	xxxxxx 0.615	+ 0.000 V/C
# 15 MacArthur Blvd and Harbor Blvd	C	xxxxxx 0.747	C	xxxxxx 0.747	+ 0.000 V/C
# 16 Harbor Blvd and Sunflower Ave	C	xxxxxx 0.705	C	xxxxxx 0.705	+ 0.000 V/C
# 17 Harbor Blvd and I-405 NB Off-R	B	17.9 0.573	B	17.9 0.573	+ 0.000 D/V
# 18 Harbor Blvd and I-405 SB Off-R	B	15.0 0.618	B	15.0 0.618	+ 0.000 D/V
# 19 Fairview St and Civic Center D	B	xxxxxx 0.676	B	xxxxxx 0.676	+ 0.000 V/C
# 20 Fairview St and 1st St	D	xxxxxx 0.887	D	xxxxxx 0.887	+ 0.000 V/C
# 21 Fairview St and McFadden Ave	D	xxxxxx 0.800	D	xxxxxx 0.800	+ 0.000 V/C
# 22 Fairview St and Edinger Ave	D	xxxxxx 0.882	D	xxxxxx 0.882	+ 0.000 V/C
# 23 Fairview St and Warner Ave	D	xxxxxx 0.847	D	xxxxxx 0.847	+ 0.000 V/C
# 24 Fairview St and MacArthur Blvd	B	xxxxxx 0.690	B	xxxxxx 0.690	+ 0.000 V/C

 Santa Ana Circulation Element

Intersection	Base		Future		Change in
	Del/ LOS	V/ Veh	Del/ LOS	V/ Veh	
# 25 Fairview Rd and Sunflower Ave	B	xxxxxx 0.687	B	xxxxxx 0.687	+ 0.000 V/C
# 26 Greenville St and Edinger Ave	C	xxxxxx 0.742	C	xxxxxx 0.742	+ 0.000 V/C
# 27 Greenville St and Segerstrom A	D	xxxxxx 0.878	D	xxxxxx 0.878	+ 0.000 V/C
# 28 Raitt St and McFadden Ave	C	xxxxxx 0.704	C	xxxxxx 0.704	+ 0.000 V/C
# 29 Raitt St and Edinger Ave	E	xxxxxx 0.926	E	xxxxxx 0.926	+ 0.000 V/C
# 30 Bear St and MacArthur Blvd	C	xxxxxx 0.756	C	xxxxxx 0.756	+ 0.000 V/C
# 31 Bristol St and 17th St	D	xxxxxx 0.853	D	xxxxxx 0.853	+ 0.000 V/C
# 32 Bristol St and Civic Center Dr	E	xxxxxx 0.931	E	xxxxxx 0.931	+ 0.000 V/C
# 33 Bristol St and Santa Ana Blvd	C	xxxxxx 0.721	C	xxxxxx 0.721	+ 0.000 V/C
# 34 Bristol St and 1st St	E	xxxxxx 0.902	E	xxxxxx 0.902	+ 0.000 V/C
# 35 Bristol St and McFadden Ave	E	xxxxxx 0.947	E	xxxxxx 0.947	+ 0.000 V/C
# 36 Bristol St and Warner Ave	E	xxxxxx 0.956	E	xxxxxx 0.956	+ 0.000 V/C
# 37 Bristol St and Segerstrom Ave	D	xxxxxx 0.854	D	xxxxxx 0.854	+ 0.000 V/C
# 38 Bristol St and Alton Ave	A	xxxxxx 0.553	A	xxxxxx 0.553	+ 0.000 V/C
# 39 Bristol St and MacArthur Blvd	C	xxxxxx 0.759	C	xxxxxx 0.759	+ 0.000 V/C
# 40 Bristol St and Sunflower Ave	B	xxxxxx 0.682	B	xxxxxx 0.682	+ 0.000 V/C
# 41 Bristol St and I-405 NB Ramps	C	20.9 0.568	C	20.9 0.568	+ 0.000 D/V
# 42 Bristol St and I-405 SB Ramps	C	23.6 0.697	C	23.6 0.697	+ 0.000 D/V
# 43 Flower St and Santa Ana Blvd	A	xxxxxx 0.586	A	xxxxxx 0.586	+ 0.000 V/C
# 44 Flower St and 1st St	E	xxxxxx 0.926	E	xxxxxx 0.926	+ 0.000 V/C
# 45 Flower St and McFadden Ave	D	xxxxxx 0.807	D	xxxxxx 0.807	+ 0.000 V/C
# 46 Flower St and Segerstrom Ave	D	xxxxxx 0.818	D	xxxxxx 0.818	+ 0.000 V/C
# 47 Flower St and MacArthur Blvd	C	xxxxxx 0.710	C	xxxxxx 0.710	+ 0.000 V/C
# 48 Main St and La Veta Ave	A	xxxxxx 0.536	A	xxxxxx 0.536	+ 0.000 V/C
# 49 Main St and Mainplace Dr / Mem	A	xxxxxx 0.456	A	xxxxxx 0.456	+ 0.000 V/C
# 50 Main St and 17th St	D	xxxxxx 0.845	D	xxxxxx 0.845	+ 0.000 V/C

Traffix 8.0.0715 (c) 2008 Dowling Assoc. Licensed to IBI GROUP, IRVINE, CA

 Santa Ana Circulation Element

Intersection	Base		Future		Change in
	Del/ LOS	V/ Veh C	Del/ LOS	V/ Veh C	
# 51 Main St and Civic Center Dr	D xxxxxx	0.848	D xxxxxx	0.848	+ 0.000 V/C
# 52 Main St and Santa Ana Blvd	C xxxxxx	0.791	C xxxxxx	0.791	+ 0.000 V/C
# 53 Main St and 4th St	A xxxxxx	0.441	A xxxxxx	0.441	+ 0.000 V/C
# 54 Main St and 1st St	C xxxxxx	0.754	C xxxxxx	0.754	+ 0.000 V/C
# 55 Main St and McFadden Ave	E xxxxxx	0.916	E xxxxxx	0.916	+ 0.000 V/C
# 56 Main St and Edinger Ave	D xxxxxx	0.876	D xxxxxx	0.876	+ 0.000 V/C
# 57 Main St and MacArthur Blvd	C xxxxxx	0.721	C xxxxxx	0.721	+ 0.000 V/C
# 58 Penn Wy and 17th St	B 12.1	0.648	B 12.1	0.648	+ 0.000 D/V
# 59 I-5 NB Off Ramps/17th Street	C 31.4	0.792	C 31.4	0.792	+ 0.000 D/V
# 60 Penn Wy and I-5 SB Ramps	B 19.5	0.462	B 19.5	0.462	+ 0.000 D/V
# 61 Santiago St and Civic Center D	F 62.6	1.147	F 62.6	1.147	+ 0.000 V/C
# 62 Santiago St and Santa Ana Blvd	F xxxxxx	1.444	F xxxxxx	1.444	+ 0.000 V/C
# 63 Standard Ave and 4th St	F xxxxxx	1.340	F xxxxxx	1.340	+ 0.000 V/C
# 64 Standard Ave and 1st St	F xxxxxx	1.515	F xxxxxx	1.515	+ 0.000 V/C
# 65 Standard Ave and Mcfadden Ave	D xxxxxx	0.843	D xxxxxx	0.843	+ 0.000 V/C
# 66 Halladay St and Warner Ave	B xxxxxx	0.692	B xxxxxx	0.692	+ 0.000 V/C
# 67 Halladay St and Dyer Rd	B xxxxxx	0.668	B xxxxxx	0.668	+ 0.000 V/C
# 68 SR-55 SB Ramps and MacArthur B	C 20.2	0.623	C 20.2	0.623	+ 0.000 D/V
# 69 SR-55 NB Ramps and MacArthur B	B 19.5	0.728	B 19.5	0.728	+ 0.000 D/V
# 70 SR-55 SB Ramps and Dyer Rd	C 25.9	0.610	C 25.9	0.610	+ 0.000 D/V
# 71 Glassell St and La Veta Ave	D xxxxxx	0.826	D xxxxxx	0.826	+ 0.000 V/C
# 72 Glassell St and SR-22 WB Ramps	C 30.1	0.841	C 30.1	0.841	+ 0.000 D/V
# 73 Grand Ave / Glassell St and SR	C 29.6	0.842	C 29.6	0.842	+ 0.000 D/V
# 74 Grand Ave and Fairhaven Ave	A xxxxxx	0.569	A xxxxxx	0.569	+ 0.000 V/C
# 75 Grand Ave and Santa Clara Ave	C xxxxxx	0.798	C xxxxxx	0.798	+ 0.000 V/C

 Santa Ana Circulation Element

Intersection	Base		Future		Change in	
	Del/ LOS	V/ Veh C	Del/ LOS	V/ Veh C		
# 76 Grand Ave and 17th St	D	xxxxxx 0.856	D	xxxxxx 0.856	+ 0.000	V/C
# 77 Grand Ave and I-5 NB Ramps	B	15.3 0.845	B	15.3 0.845	+ 0.000	D/V
# 78 Grand Ave and Santa Ana Blvd	C	26.3 0.881	C	26.3 0.881	+ 0.000	D/V
# 79 Grand Ave and 1st St	D	xxxxxx 0.827	D	xxxxxx 0.827	+ 0.000	V/C
# 80 Grand Ave and Chestnut Ave	E	xxxxxx 0.935	E	xxxxxx 0.935	+ 0.000	V/C
# 81 Grand Ave and McFadden Ave	F	xxxxxx 1.011	F	xxxxxx 1.011	+ 0.000	V/C
# 82 Grand Ave and Edinger Ave	D	xxxxxx 0.897	D	xxxxxx 0.897	+ 0.000	V/C
# 83 Grand Ave and Warner Ave	B	xxxxxx 0.664	B	xxxxxx 0.664	+ 0.000	V/C
# 84 SR-55 NB Ramps and Dyer Rd	B	17.3 0.565	B	17.3 0.565	+ 0.000	D/V
# 85 Cambridge St and La Veta Ave	C	23.4 0.900	C	23.4 0.900	+ 0.000	V/C
# 86 Cambridge St and Fairhaven Ave	B	xxxxxx 0.624	B	xxxxxx 0.624	+ 0.000	V/C
# 87 Mabury St and 1st Street	C	27.4 0.755	C	27.4 0.755	+ 0.000	D/V
# 88 Tustin St and La Veta Ave	A	xxxxxx 0.362	A	xxxxxx 0.362	+ 0.000	V/C
# 89 Tustin St and SR-22 WB On-Ramp	B	13.2 0.575	B	13.2 0.575	+ 0.000	D/V
# 90 Tustin St and SR-22 EB Off-Ram	C	23.8 0.718	C	23.8 0.718	+ 0.000	D/V
# 91 Tustin Ave and Fairhaven Ave	F	xxxxxx 1.242	F	xxxxxx 1.242	+ 0.000	V/C
# 92 Tustin Ave and Santa Clara Ave	F	xxxxxx 1.097	F	xxxxxx 1.097	+ 0.000	V/C
# 93 Tustin Ave and 17th St	D	xxxxxx 0.805	D	xxxxxx 0.805	+ 0.000	V/C
# 94 Tustin Ave and 4th St	C	xxxxxx 0.791	C	xxxxxx 0.791	+ 0.000	V/C
# 95 SR-55 SB Ramps / Auto Mall Dr	C	25.1 0.653	C	25.1 0.653	+ 0.000	D/V
# 96 SR-55 NB Ramps / Del Amo Ave a	C	25.6 0.665	C	25.6 0.665	+ 0.000	D/V
# 97 Red Hill Ave and Edinger Ave	B	xxxxxx 0.619	B	xxxxxx 0.619	+ 0.000	V/C
# 98 Red Hill Ave and Warner Ave	A	xxxxxx 0.580	A	xxxxxx 0.580	+ 0.000	V/C
# 99 Red Hill Ave and Dyer Rd / bar	A	xxxxxx 0.577	A	xxxxxx 0.577	+ 0.000	V/C
#100 Red Hill Ave and Alton Pkwy	E	xxxxxx 0.930	E	xxxxxx 0.930	+ 0.000	V/C
#101 Red Hill Ave and MacArthur Blv	C	xxxxxx 0.709	C	xxxxxx 0.709	+ 0.000	V/C

Traffix 8.0.0715 (c) 2008 Dowling Assoc. Licensed to IBI GROUP, IRVINE, CA

 Santa Ana Circulation Element

Intersection	Base		Future		Change in
	Del/ LOS	V/ Veh C	Del/ LOS	V/ Veh C	
#102 Red Hill Ave and Main St	C	xxxxxx 0.733	C	xxxxxx 0.733	+ 0.000 V/C
#103 I-5 SB Ramps and Santa Ana Blv	B	17.8 0.480	B	17.8 0.480	+ 0.000 D/V
#104 Tustin Ranch Rd and Warner Ave	A	xxxxxx 0.530	A	xxxxxx 0.530	+ 0.000 V/C
#105 Von Karman Ave and Barranca Pk	E	xxxxxx 0.930	E	xxxxxx 0.930	+ 0.000 V/C
#106 Red Hill Avenue and El Camino	B	xxxxxx 0.640	B	xxxxxx 0.640	+ 0.000 V/C
#107 Red Hill Avenue and I-5 NB Ram	C	20.1 0.631	C	20.1 0.631	+ 0.000 D/V
#108 Red Hill Avenue and I-5 SB Ram	C	24.7 0.824	C	24.7 0.824	+ 0.000 D/V
#109 Red Hill Avenue and Nisson Roa	B	xxxxxx 0.655	B	xxxxxx 0.655	+ 0.000 V/C
#110 Red Hill Avenue and Walnut Ave	B	xxxxxx 0.643	B	xxxxxx 0.643	+ 0.000 V/C
#111 Red Hill Avenue and Valencia A	B	xxxxxx 0.677	B	xxxxxx 0.677	+ 0.000 V/C
#112 Tustin Ranch Road and Warner A	A	xxxxxx 0.459	A	xxxxxx 0.459	+ 0.000 V/C
#113 Tustin Ranch Road and Walnut A	F	xxxxxx 1.313	F	xxxxxx 1.313	+ 0.000 V/C
#114 SR-55 SB Ramps and Irvine Boul	E	55.4 1.176	E	55.4 1.176	+ 0.000 D/V
#115 SR-55 NB Ramps and Irvine Boul	C	20.3 0.824	C	20.3 0.824	+ 0.000 D/V

Santa Ana Circulation Element

Level Of Service Computation Report

ICU 1(Loss as Cycle Length %) Method (Base Volume Alternative)

Intersection #1 Euclid St and 1st St

Cycle (sec): 100 Critical Vol./Cap.(X): 0.789
Loss Time (sec): 5 Average Delay (sec/veh): xxxxxx
Optimal Cycle: 50 Level Of Service: C

Table with 4 columns: North Bound, South Bound, East Bound, West Bound. Rows include Movement, Control, Rights, Min. Green, Y+R, and Lanes.

Volume Module: Table with 12 columns representing different volume categories and their values.

Saturation Flow Module: Table with 12 columns representing saturation flow values for various lanes.

Capacity Analysis Module: Table with 12 columns representing capacity analysis values.

Santa Ana Circulation Element

Level Of Service Computation Report

ICU 1(Loss as Cycle Length %) Method (Base Volume Alternative)

Intersection #2 Euclid St and McFadden Ave

Cycle (sec): 100 Critical Vol./Cap.(X): 0.906
 Loss Time (sec): 5 Average Delay (sec/veh): xxxxxx
 Optimal Cycle: 90 Level Of Service: E

Approach:	North Bound			South Bound			East Bound			West Bound		
Movement:	L	T	R	L	T	R	L	T	R	L	T	R
Control:	Protected			Protected			Prot+Permit			Prot+Permit		
Rights:	WideBypass			Include			Include			Include		
Min. Green:	0	0	0	0	0	0	0	0	0	0	0	0
Y+R:	4.0	4.0	4.0	4.0	4.0	4.0	4.0	4.0	4.0	4.0	4.0	4.0
Lanes:	1	0	2	1	0	2	1	0	1	1	0	1

Volume Module:

Base Vol:	156	1185	141	146	2031	168	227	463	287	106	234	89
Growth Adj:	1.00	1.00	1.00	1.00	1.00	1.00	1.00	1.00	1.00	1.00	1.00	1.00
Initial Bse:	156	1185	141	146	2031	168	227	463	287	106	234	89
User Adj:	1.00	1.00	1.00	1.00	1.00	1.00	1.00	1.00	1.00	1.00	1.00	1.00
PHF Adj:	1.00	1.00	1.00	1.00	1.00	1.00	1.00	1.00	1.00	1.00	1.00	1.00
PHF Volume:	156	1185	141	146	2031	168	227	463	287	106	234	89
Reduct Vol:	0	0	0	0	0	0	0	0	0	0	0	0
Reduced Vol:	156	1185	141	146	2031	168	227	463	287	106	234	89
PCE Adj:	1.00	1.00	1.00	1.00	1.00	1.00	1.00	1.00	1.00	1.00	1.00	1.00
MLF Adj:	1.00	1.00	1.00	1.00	1.00	1.00	1.00	1.00	1.00	1.00	1.00	1.00
FinalVolume:	156	1185	141	146	2031	168	227	463	287	106	234	89

Saturation Flow Module:

Sat/Lane:	1600	1600	1600	1600	1600	1600	1600	1600	1600	1600	1600	1600
Adjustment:	1.00	1.05	1.00	1.00	1.05	1.00	1.00	1.05	1.00	1.00	1.04	1.00
Lanes:	1.00	2.68	0.32	1.00	2.77	0.23	1.00	1.23	0.77	1.00	1.45	0.55
Final Sat.:	1600	4490	510	1600	4633	367	1600	2075	1225	1600	2418	882

Capacity Analysis Module:

Vol/Sat:	0.10	0.26	0.28	0.09	0.44	0.46	0.14	0.22	0.23	0.07	0.10	0.10
Crit Moves:	****					****			****	****		

Santa Ana Circulation Element

Level Of Service Computation Report

ICU 1(Loss as Cycle Length %) Method (Base Volume Alternative)

Intersection #3 Euclid St and Edinger Ave

Cycle (sec): 100 Critical Vol./Cap.(X): 1.008
 Loss Time (sec): 5 Average Delay (sec/veh): xxxxxx
 Optimal Cycle: 180 Level Of Service: F

Approach:	North Bound			South Bound			East Bound			West Bound		
Movement:	L	T	R	L	T	R	L	T	R	L	T	R
Control:	Protected			Protected			Protected			Protected		
Rights:	Include			Include			Include			Include		
Min. Green:	0	0	0	0	0	0	0	0	0	0	0	0
Y+R:	4.0	4.0	4.0	4.0	4.0	4.0	4.0	4.0	4.0	4.0	4.0	4.0
Lanes:	2	0	2	1	0	0	2	0	2	1	0	1

Volume Module:

Base Vol:	127	801	68	180	2613	240	136	595	364	133	812	148
Growth Adj:	1.00	1.00	1.00	1.00	1.00	1.00	1.00	1.00	1.00	1.00	1.00	1.00
Initial Bse:	127	801	68	180	2613	240	136	595	364	133	812	148
User Adj:	1.00	1.00	1.00	1.00	1.00	1.00	1.00	1.00	1.00	1.00	1.00	1.00
PHF Adj:	1.00	1.00	1.00	1.00	1.00	1.00	1.00	1.00	1.00	1.00	1.00	1.00
PHF Volume:	127	801	68	180	2613	240	136	595	364	133	812	148
Reduct Vol:	0	0	0	0	0	0	0	0	0	0	0	0
Reduced Vol:	127	801	68	180	2613	240	136	595	364	133	812	148
PCE Adj:	1.00	1.00	1.00	1.00	1.00	1.00	1.00	1.00	1.00	1.00	1.00	1.00
MLF Adj:	1.00	1.00	1.00	1.00	1.00	1.00	1.00	1.00	1.00	1.00	1.00	1.00
FinalVolume:	127	801	68	180	2613	240	136	595	364	133	812	148

Saturation Flow Module:

Sat/Lane:	1600	1600	1600	1600	1600	1600	1600	1600	1600	1600	1600	1600
Adjustment:	1.00	1.05	1.00	1.00	1.05	1.00	1.00	1.06	1.00	1.00	1.06	1.00
Lanes:	2.00	2.77	0.23	2.00	2.75	0.25	1.00	2.00	1.00	1.00	2.00	1.00
Final Sat.:	3200	4624	376	3200	4596	404	1600	3400	1600	1600	3400	1600

Capacity Analysis Module:

Vol/Sat:	0.04	0.17	0.18	0.06	0.57	0.59	0.09	0.17	0.23	0.08	0.24	0.09
Crit Moves:	****					****	****				****	

Santa Ana Circulation Element

Level Of Service Computation Report

ICU 1(Loss as Cycle Length %) Method (Base Volume Alternative)

Intersection #4 Newhope St and Hazard Ave

Cycle (sec): 100 Critical Vol./Cap.(X): 0.600
 Loss Time (sec): 5 Average Delay (sec/veh): xxxxxx
 Optimal Cycle: 29 Level Of Service: A

Approach:	North Bound			South Bound			East Bound			West Bound		
Movement:	L	T	R	L	T	R	L	T	R	L	T	R
Control:	Prot+Permit			Prot+Permit			Permitted			Permitted		
Rights:	Include			Include			Include			Include		
Min. Green:	0	0	0	0	0	0	0	0	0	0	0	0
Y+R:	4.0	4.0	4.0	4.0	4.0	4.0	4.0	4.0	4.0	4.0	4.0	4.0
Lanes:	1	0	1	1	0	1	0	0	1	1	0	0

Volume Module:

Base Vol:	94	708	101	86	1262	116	17	44	33	17	57	23
Growth Adj:	1.00	1.00	1.00	1.00	1.00	1.00	1.00	1.00	1.00	1.00	1.00	1.00
Initial Bse:	94	708	101	86	1262	116	17	44	33	17	57	23
User Adj:	1.00	1.00	1.00	1.00	1.00	1.00	1.00	1.00	1.00	1.00	1.00	1.00
PHF Adj:	1.00	1.00	1.00	1.00	1.00	1.00	1.00	1.00	1.00	1.00	1.00	1.00
PHF Volume:	94	708	101	86	1262	116	17	44	33	17	57	23
Reduct Vol:	0	0	0	0	0	0	0	0	0	0	0	0
Reduced Vol:	94	708	101	86	1262	116	17	44	33	17	57	23
PCE Adj:	1.00	1.00	1.00	1.00	1.00	1.00	1.00	1.00	1.00	1.00	1.00	1.00
MLF Adj:	1.00	1.00	1.00	1.00	1.00	1.00	1.00	1.00	1.00	1.00	1.00	1.00
FinalVolume:	94	708	101	86	1262	116	17	44	33	17	57	23

Saturation Flow Module:

Sat/Lane:	1600	1600	1600	1600	1600	1600	1600	1600	1600	1600	1600	1600
Adjustment:	1.00	1.04	1.00	1.00	1.03	1.00	1.00	1.00	1.00	1.00	1.00	1.00
Lanes:	1.00	1.75	0.25	1.00	1.83	0.17	1.00	0.57	0.43	1.00	0.71	0.29
Final Sat.:	1600	2900	400	1600	3031	269	1600	914	686	1600	1140	460

Capacity Analysis Module:

Vol/Sat:	0.06	0.24	0.25	0.05	0.42	0.43	0.01	0.05	0.05	0.01	0.05	0.05
Crit Moves:	****					****	****				****	

Santa Ana Circulation Element

Level Of Service Computation Report

ICU 1(Loss as Cycle Length %) Method (Base Volume Alternative)

Intersection #5 Newhope St and McFadden Ave

Cycle (sec): 100 Critical Vol./Cap.(X): 0.728
 Loss Time (sec): 5 Average Delay (sec/veh): xxxxxx
 Optimal Cycle: 40 Level Of Service: C

Approach:	North Bound			South Bound			East Bound			West Bound		
Movement:	L	T	R	L	T	R	L	T	R	L	T	R
Control:	Protected			Protected			Prot+Permit			Prot+Permit		
Rights:	Include			Include			Include			Include		
Min. Green:	0	0	0	0	0	0	0	0	0	0	0	0
Y+R:	4.0	4.0	4.0	4.0	4.0	4.0	4.0	4.0	4.0	4.0	4.0	4.0
Lanes:	1	0	1	1	0	1	1	0	1	1	0	1

Volume Module:

Base Vol:	77	342	120	116	1153	107	106	386	125	122	311	69
Growth Adj:	1.00	1.00	1.00	1.00	1.00	1.00	1.00	1.00	1.00	1.00	1.00	1.00
Initial Bse:	77	342	120	116	1153	107	106	386	125	122	311	69
User Adj:	1.00	1.00	1.00	1.00	1.00	1.00	1.00	1.00	1.00	1.00	1.00	1.00
PHF Adj:	1.00	1.00	1.00	1.00	1.00	1.00	1.00	1.00	1.00	1.00	1.00	1.00
PHF Volume:	77	342	120	116	1153	107	106	386	125	122	311	69
Reduct Vol:	0	0	0	0	0	0	0	0	0	0	0	0
Reduced Vol:	77	342	120	116	1153	107	106	386	125	122	311	69
PCE Adj:	1.00	1.00	1.00	1.00	1.00	1.00	1.00	1.00	1.00	1.00	1.00	1.00
MLF Adj:	1.00	1.00	1.00	1.00	1.00	1.00	1.00	1.00	1.00	1.00	1.00	1.00
FinalVolume:	77	342	120	116	1153	107	106	386	125	122	311	69

Saturation Flow Module:

Sat/Lane:	1600	1600	1600	1600	1600	1600	1600	1600	1600	1600	1600	1600
Adjustment:	1.00	1.04	1.00	1.00	1.03	1.00	1.00	1.04	1.00	1.00	1.04	1.00
Lanes:	1.00	1.48	0.52	1.00	1.83	0.17	1.00	1.51	0.49	1.00	1.64	0.36
Final Sat.:	1600	2469	831	1600	3028	272	1600	2517	783	1600	2719	581

Capacity Analysis Module:

Vol/Sat:	0.05	0.14	0.14	0.07	0.38	0.39	0.07	0.15	0.16	0.08	0.11	0.12
Crit Moves:	****					****			****	****		

Santa Ana Circulation Element

Level Of Service Computation Report
 2000 HCM Operations Method (Base Volume Alternative)

 Intersection #6 Harbor Blvd and SR-22 WB Off-Ramp / Banner Dr

Cycle (sec): 100 Critical Vol./Cap.(X): 0.715
 Loss Time (sec): 5 Average Delay (sec/veh): 28.5
 Optimal Cycle: 40 Level Of Service: C

Approach:	North Bound			South Bound			East Bound			West Bound		
Movement:	L	T	R	L	T	R	L	T	R	L	T	R
Control:	Protected			Protected			Split Phase			Split Phase		
Rights:	Include			Include			Include			Include		
Min. Green:	0	0	0	0	0	0	0	0	0	0	0	0
Y+R:	4.0	4.0	4.0	4.0	4.0	4.0	4.0	4.0	4.0	4.0	4.0	4.0
Lanes:	1	0	3	0	0	2	1	0	0	1	1	0

Volume Module:

Base Vol:	83	1508	0	0	1354	18	81	0	133	836	44	117
Growth Adj:	1.00	1.00	1.00	1.00	1.00	1.00	1.00	1.00	1.00	1.00	1.00	1.00
Initial Bse:	83	1508	0	0	1354	18	81	0	133	836	44	117
User Adj:	1.00	1.00	1.00	1.00	1.00	1.00	1.00	1.00	1.00	1.00	1.00	1.00
PHF Adj:	1.00	1.00	1.00	1.00	1.00	1.00	1.00	1.00	1.00	1.00	1.00	1.00
PHF Volume:	83	1508	0	0	1354	18	81	0	133	836	44	117
Reduct Vol:	0	0	0	0	0	0	0	0	0	0	0	0
Reduced Vol:	83	1508	0	0	1354	18	81	0	133	836	44	117
PCE Adj:	1.00	1.00	1.00	1.00	1.00	1.00	1.00	1.00	1.00	1.00	1.00	1.00
MLF Adj:	1.00	1.00	1.00	1.00	1.00	1.00	1.00	1.00	1.00	1.00	1.00	1.00
FinalVolume:	83	1508	0	0	1354	18	81	0	133	836	44	117

Saturation Flow Module:

Sat/Lane:	1900	1900	1900	1900	1900	1900	1900	1900	1900	1900	1900	1900
Adjustment:	0.95	0.91	1.00	1.00	0.91	0.91	0.90	1.00	0.90	0.96	0.96	0.85
Lanes:	1.00	3.00	0.00	0.00	2.96	0.04	0.38	0.00	0.62	1.90	0.10	1.00
Final Sat.:	1805	5187	0	0	5109	68	646	0	1061	3448	181	1615

Capacity Analysis Module:

Vol/Sat:	0.05	0.29	0.00	0.00	0.27	0.27	0.13	0.00	0.13	0.24	0.24	0.07
Crit Moves:	****			****			****			****		
Green/Cycle:	0.06	0.44	0.00	0.00	0.37	0.37	0.18	0.00	0.18	0.34	0.34	0.34
Volume/Cap:	0.71	0.67	0.00	0.00	0.71	0.71	0.71	0.00	0.71	0.71	0.71	0.21
Delay/Veh:	64.8	23.3	0.0	0.0	28.2	28.2	46.8	0.0	46.8	30.8	30.8	23.7
User DelAdj:	1.00	1.00	1.00	1.00	1.00	1.00	1.00	1.00	1.00	1.00	1.00	1.00
AdjDel/Veh:	64.8	23.3	0.0	0.0	28.2	28.2	46.8	0.0	46.8	30.8	30.8	23.7
LOS by Move:	E	C	A	A	C	C	D	A	D	C	C	C
HCM2k85thQ:	6	21	0	0	21	21	12	0	12	19	19	4

 Note: Queue reported is the number of cars per lane.

Santa Ana Circulation Element

Level Of Service Computation Report
 2000 HCM Operations Method (Base Volume Alternative)

 Intersection #7 Trask Avenue and SR-22 EB On-Ramp

Cycle (sec): 100 Critical Vol./Cap.(X): 0.389
 Loss Time (sec): 5 Average Delay (sec/veh): 11.0
 Optimal Cycle: 21 Level Of Service: B

Approach:	North Bound			South Bound			East Bound			West Bound		
Movement:	L	T	R	L	T	R	L	T	R	L	T	R
Control:	Protected			Protected			Protected			Protected		
Rights:	Include			Include			Include			Include		
Min. Green:	0	0	0	0	0	0	0	0	0	0	0	0
Y+R:	4.0	4.0	4.0	4.0	4.0	4.0	4.0	4.0	4.0	4.0	4.0	4.0
Lanes:	0	0	0	0	0	0	2	0	1	0	0	1

Volume Module:	North Bound			South Bound			East Bound			West Bound		
Base Vol:	0	0	0	0	0	0	558	699	0	0	624	117
Growth Adj:	1.00	1.00	1.00	1.00	1.00	1.00	1.00	1.00	1.00	1.00	1.00	1.00
Initial Bse:	0	0	0	0	0	0	558	699	0	0	624	117
User Adj:	1.00	1.00	1.00	1.00	1.00	1.00	1.00	1.00	1.00	1.00	1.00	1.00
PHF Adj:	1.00	1.00	1.00	1.00	1.00	1.00	1.00	1.00	1.00	1.00	1.00	1.00
PHF Volume:	0	0	0	0	0	0	558	699	0	0	624	117
Reduct Vol:	0	0	0	0	0	0	0	0	0	0	0	0
Reduced Vol:	0	0	0	0	0	0	558	699	0	0	624	117
PCE Adj:	1.00	1.00	1.00	1.00	1.00	1.00	1.00	1.00	1.00	1.00	1.00	1.00
MLF Adj:	1.00	1.00	1.00	1.00	1.00	1.00	1.00	1.00	1.00	1.00	1.00	1.00
FinalVolume:	0	0	0	0	0	0	558	699	0	0	624	117

Saturation Flow Module:	North Bound			South Bound			East Bound			West Bound		
Sat/Lane:	1900	1900	1900	1900	1900	1900	1900	1900	1900	1900	1900	1900
Adjustment:	1.00	1.00	1.00	1.00	1.00	1.00	0.92	1.00	1.00	1.00	0.93	0.93
Lanes:	0.00	0.00	0.00	0.00	0.00	0.00	2.00	1.00	0.00	0.00	1.68	0.32
Final Sat.:	0	0	0	0	0	0	3502	1900	0	0	2967	556

Capacity Analysis Module:	North Bound			South Bound			East Bound			West Bound		
Vol/Sat:	0.00	0.00	0.00	0.00	0.00	0.00	0.16	0.37	0.00	0.00	0.21	0.21
Crit Moves:							****				****	
Green/Cycle:	0.00	0.00	0.00	0.00	0.00	0.00	0.41	0.95	0.00	0.00	0.54	0.54
Volume/Cap:	0.00	0.00	0.00	0.00	0.00	0.00	0.39	0.39	0.00	0.00	0.39	0.39
Delay/Veh:	0.0	0.0	0.0	0.0	0.0	0.0	20.9	0.3	0.0	0.0	13.5	13.5
User DelAdj:	1.00	1.00	1.00	1.00	1.00	1.00	1.00	1.00	1.00	1.00	1.00	1.00
AdjDel/Veh:	0.0	0.0	0.0	0.0	0.0	0.0	20.9	0.3	0.0	0.0	13.5	13.5
LOS by Move:	A	A	A	A	A	A	C	A	A	A	B	B
HCM2k85thQ:	0	0	0	0	0	0	10	3	0	0	11	11

 Note: Queue reported is the number of cars per lane.

Santa Ana Circulation Element

Level Of Service Computation Report

ICU 1(Loss as Cycle Length %) Method (Base Volume Alternative)

Intersection #8 Harbor Blvd and Westminster Ave

Cycle (sec): 100 Critical Vol./Cap.(X): 0.936
 Loss Time (sec): 0 Average Delay (sec/veh): xxxxxx
 Optimal Cycle: 180 Level Of Service: E

Approach:	North Bound			South Bound			East Bound			West Bound		
Movement:	L	T	R	L	T	R	L	T	R	L	T	R
Control:	Protected			Protected			Protected			Protected		
Rights:	WideBypass			Include			Include			Include		
Min. Green:	0	0	0	0	0	0	0	0	0	0	0	0
Y+R:	4.0	4.0	4.0	4.0	4.0	4.0	4.0	4.0	4.0	4.0	4.0	4.0
Lanes:	1	0	3	0	1	1	0	2	1	0	1	0

Volume Module:

Base Vol:	159	1045	224	251	1970	113	173	910	32	406	1100	299
Growth Adj:	1.00	1.00	1.00	1.00	1.00	1.00	1.00	1.00	1.00	1.00	1.00	1.00
Initial Bse:	159	1045	224	251	1970	113	173	910	32	406	1100	299
User Adj:	1.00	1.00	1.00	1.00	1.00	1.00	1.00	1.00	1.00	1.00	1.00	1.00
PHF Adj:	1.00	1.00	1.00	1.00	1.00	1.00	1.00	1.00	1.00	1.00	1.00	1.00
PHF Volume:	159	1045	224	251	1970	113	173	910	32	406	1100	299
Reduct Vol:	0	0	0	0	0	0	0	0	0	0	0	0
Reduced Vol:	159	1045	224	251	1970	113	173	910	32	406	1100	299
PCE Adj:	1.00	1.00	1.00	1.00	1.00	1.00	1.00	1.00	1.00	1.00	1.00	1.00
MLF Adj:	1.00	1.00	1.00	1.00	1.00	1.00	1.00	1.00	1.00	1.00	1.00	1.00
FinalVolume:	159	1045	224	251	1970	113	173	910	32	406	1100	299

Saturation Flow Module:

Sat/Lane:	1600	1600	1600	1600	1600	1600	1600	1600	1600	1600	1600	1600
Adjustment:	1.00	1.06	1.00	1.00	1.06	1.00	1.00	1.04	1.00	1.00	1.06	1.00
Lanes:	1.00	3.00	1.00	1.00	3.00	1.00	1.00	2.90	0.10	1.00	3.00	1.00
Final Sat.:	1600	5100	1600	1600	5100	1600	1600	4837	163	1600	5100	1600

Capacity Analysis Module:

Vol/Sat:	0.10	0.20	0.14	0.16	0.39	0.07	0.11	0.19	0.20	0.25	0.22	0.19
Crit Moves:	****			****					****	****		

Santa Ana Circulation Element

Level Of Service Computation Report

ICU 1(Loss as Cycle Length %) Method (Base Volume Alternative)

Intersection #9 Harbor Blvd and 1st St

Cycle (sec): 100 Critical Vol./Cap.(X): 0.749
Loss Time (sec): 5 Average Delay (sec/veh): xxxxxx
Optimal Cycle: 43 Level Of Service: C

Table with 4 columns: North Bound, South Bound, East Bound, West Bound. Rows include Movement (L-T-R), Control (Protected), Rights (Include), Min. Green, Y+R, and Lanes.

Volume Module: Table with 12 columns representing different volume components and their values.

Saturation Flow Module: Table with 12 columns representing saturation flow values and adjustment factors.

Capacity Analysis Module: Table with 12 columns representing capacity analysis metrics.

Santa Ana Circulation Element

Level Of Service Computation Report

ICU 1(Loss as Cycle Length %) Method (Base Volume Alternative)

Intersection #10 Harbor Blvd and McFadden Ave

Cycle (sec): 100 Critical Vol./Cap.(X): 0.729
 Loss Time (sec): 5 Average Delay (sec/veh): xxxxxx
 Optimal Cycle: 40 Level Of Service: C

Approach:	North Bound			South Bound			East Bound			West Bound		
Movement:	L	T	R	L	T	R	L	T	R	L	T	R
Control:	Protected			Protected			Protected			Protected		
Rights:	Include			Include			Include			Include		
Min. Green:	0	0	0	0	0	0	0	0	0	0	0	0
Y+R:	4.0	4.0	4.0	4.0	4.0	4.0	4.0	4.0	4.0	4.0	4.0	4.0
Lanes:	2	0	3	0	1	0	2	0	2	1	0	1

Volume Module:

Base Vol:	101	1026	98	179	1891	63	136	353	106	85	193	55
Growth Adj:	1.00	1.00	1.00	1.00	1.00	1.00	1.00	1.00	1.00	1.00	1.00	1.00
Initial Bse:	101	1026	98	179	1891	63	136	353	106	85	193	55
User Adj:	1.00	1.00	1.00	1.00	1.00	1.00	1.00	1.00	1.00	1.00	1.00	1.00
PHF Adj:	1.00	1.00	1.00	1.00	1.00	1.00	1.00	1.00	1.00	1.00	1.00	1.00
PHF Volume:	101	1026	98	179	1891	63	136	353	106	85	193	55
Reduct Vol:	0	0	0	0	0	0	0	0	0	0	0	0
Reduced Vol:	101	1026	98	179	1891	63	136	353	106	85	193	55
PCE Adj:	1.00	1.00	1.00	1.00	1.00	1.00	1.00	1.00	1.00	1.00	1.00	1.00
MLF Adj:	1.00	1.00	1.00	1.00	1.00	1.00	1.00	1.00	1.00	1.00	1.00	1.00
FinalVolume:	101	1026	98	179	1891	63	136	353	106	85	193	55

Saturation Flow Module:

Sat/Lane:	1600	1600	1600	1600	1600	1600	1600	1600	1600	1600	1600	1600
Adjustment:	1.00	1.06	1.00	1.00	1.04	1.00	1.00	1.04	1.00	1.00	1.00	1.00
Lanes:	2.00	3.00	1.00	2.00	2.90	0.10	1.00	1.54	0.46	1.00	0.78	0.22
Final Sat.:	3200	5100	1600	3200	4845	155	1600	2561	739	1600	1245	355

Capacity Analysis Module:

Vol/Sat:	0.03	0.20	0.06	0.06	0.39	0.41	0.09	0.14	0.14	0.05	0.16	0.15
Crit Moves:	****					****	****				****	

Santa Ana Circulation Element

Level Of Service Computation Report

ICU 1(Loss as Cycle Length %) Method (Base Volume Alternative)

Intersection #11 Harbor Blvd and Edinger Ave

Cycle (sec): 100 Critical Vol./Cap.(X): 0.857
Loss Time (sec): 5 Average Delay (sec/veh): xxxxxx
Optimal Cycle: 67 Level Of Service: D

Table with 4 columns: North Bound, South Bound, East Bound, West Bound. Rows include Movement (L-T-R), Control (Protected), Rights (Include), Min. Green, Y+R, and Lanes.

Volume Module: Table with 12 columns representing volume and adjustment factors for each bound and lane.

Saturation Flow Module: Table with 12 columns representing saturation flow and adjustment factors.

Capacity Analysis Module: Table with 12 columns representing volume/saturation and critical moves.

Santa Ana Circulation Element

Level Of Service Computation Report

ICU 1(Loss as Cycle Length %) Method (Base Volume Alternative)

Intersection #12 Harbor Blvd and Warner Ave

Cycle (sec): 100 Critical Vol./Cap.(X): 0.800
 Loss Time (sec): 5 Average Delay (sec/veh): xxxxxx
 Optimal Cycle: 52 Level Of Service: C

Approach:	North Bound			South Bound			East Bound			West Bound		
Movement:	L	T	R	L	T	R	L	T	R	L	T	R
Control:	Protected			Protected			Protected			Protected		
Rights:	Include			Include			Include			Include		
Min. Green:	0	0	0	0	0	0	0	0	0	0	0	0
Y+R:	4.0	4.0	4.0	4.0	4.0	4.0	4.0	4.0	4.0	4.0	4.0	4.0
Lanes:	2	0	2	1	0	0	2	0	3	0	1	0

Volume Module:

Base Vol:	106	647	164	451	2034	122	100	1422	374	125	654	111
Growth Adj:	1.00	1.00	1.00	1.00	1.00	1.00	1.00	1.00	1.00	1.00	1.00	1.00
Initial Bse:	106	647	164	451	2034	122	100	1422	374	125	654	111
User Adj:	1.00	1.00	1.00	1.00	1.00	1.00	1.00	1.00	1.00	1.00	1.00	1.00
PHF Adj:	1.00	1.00	1.00	1.00	1.00	1.00	1.00	1.00	1.00	1.00	1.00	1.00
PHF Volume:	106	647	164	451	2034	122	100	1422	374	125	654	111
Reduct Vol:	0	0	0	0	0	0	0	0	0	0	0	0
Reduced Vol:	106	647	164	451	2034	122	100	1422	374	125	654	111
PCE Adj:	1.00	1.00	1.00	1.00	1.00	1.00	1.00	1.00	1.00	1.00	1.00	1.00
MLF Adj:	1.00	1.00	1.00	1.00	1.00	1.00	1.00	1.00	1.00	1.00	1.00	1.00
FinalVolume:	106	647	164	451	2034	122	100	1422	374	125	654	111

Saturation Flow Module:

Sat/Lane:	1600	1600	1600	1600	1600	1600	1600	1600	1600	1600	1600	1600
Adjustment:	1.00	1.05	1.00	1.00	1.06	1.00	1.00	1.06	1.00	1.00	1.06	1.00
Lanes:	2.00	2.39	0.61	2.00	3.00	1.00	2.00	3.00	1.00	2.00	3.00	1.00
Final Sat.:	3200	4029	971	3200	5100	1600	3200	5100	1600	3200	5100	1600

Capacity Analysis Module:

Vol/Sat:	0.03	0.16	0.17	0.14	0.40	0.08	0.03	0.28	0.23	0.04	0.13	0.07
Crit Moves:	****			****			****			****		

Santa Ana Circulation Element

Level Of Service Computation Report

ICU 1(Loss as Cycle Length %) Method (Base Volume Alternative)

Intersection #13 Harbor Blvd and Segerstrom Ave

Cycle (sec): 100 Critical Vol./Cap.(X): 1.007
 Loss Time (sec): 5 Average Delay (sec/veh): xxxxxx
 Optimal Cycle: 180 Level Of Service: F

Approach:	North Bound			South Bound			East Bound			West Bound		
Movement:	L	T	R	L	T	R	L	T	R	L	T	R
Control:	Protected			Protected			Prot+Permit			Prot+Permit		
Rights:	Include			Include			Include			Include		
Min. Green:	0	0	0	0	0	0	0	0	0	0	0	0
Y+R:	4.0	4.0	4.0	4.0	4.0	4.0	4.0	4.0	4.0	4.0	4.0	4.0
Lanes:	2	0	2	1	0	2	1	0	1	1	0	2

Volume Module:

Base Vol:	107	759	48	173	2324	87	90	753	303	146	453	103
Growth Adj:	1.00	1.00	1.00	1.00	1.00	1.00	1.00	1.00	1.00	1.00	1.00	1.00
Initial Bse:	107	759	48	173	2324	87	90	753	303	146	453	103
User Adj:	1.00	1.00	1.00	1.00	1.00	1.00	1.00	1.00	1.00	1.00	1.00	1.00
PHF Adj:	1.00	1.00	1.00	1.00	1.00	1.00	1.00	1.00	1.00	1.00	1.00	1.00
PHF Volume:	107	759	48	173	2324	87	90	753	303	146	453	103
Reduct Vol:	0	0	0	0	0	0	0	0	0	0	0	0
Reduced Vol:	107	759	48	173	2324	87	90	753	303	146	453	103
PCE Adj:	1.00	1.00	1.00	1.00	1.00	1.00	1.00	1.00	1.00	1.00	1.00	1.00
MLF Adj:	1.00	1.00	1.00	1.00	1.00	1.00	1.00	1.00	1.00	1.00	1.00	1.00
Final Volume:	107	759	48	173	2324	87	90	753	303	146	453	103

Saturation Flow Module:

Sat/Lane:	1600	1600	1600	1600	1600	1600	1600	1600	1600	1600	1600	1600
Adjustment:	1.00	1.04	1.00	1.00	1.04	1.00	1.00	1.04	1.00	1.00	1.06	1.00
Lanes:	2.00	2.82	0.18	1.00	2.89	0.11	1.00	1.43	0.57	1.00	2.00	1.00
Final Sat.:	3200	4714	286	1600	4827	173	1600	2382	918	1600	3400	1600

Capacity Analysis Module:

Vol/Sat:	0.03	0.16	0.17	0.11	0.48	0.50	0.06	0.32	0.33	0.09	0.13	0.06
Crit Moves:	****					****			****	****		

Santa Ana Circulation Element

Level Of Service Computation Report

ICU 1(Loss as Cycle Length %) Method (Base Volume Alternative)

Intersection #14 MacArthur Blvd and Hyland Ave

Cycle (sec): 100 Critical Vol./Cap.(X): 0.615
 Loss Time (sec): 5 Average Delay (sec/veh): xxxxxx
 Optimal Cycle: 30 Level Of Service: B

Approach:	North Bound			South Bound			East Bound			West Bound		
Movement:	L	T	R	L	T	R	L	T	R	L	T	R
Control:	Protected			Protected			Prot+Permit			Prot+Permit		
Rights:	Include			Include			Include			Include		
Min. Green:	0	0	0	0	0	0	0	0	0	0	0	0
Y+R:	4.0	4.0	4.0	4.0	4.0	4.0	4.0	4.0	4.0	4.0	4.0	4.0
Lanes:	2	0	0	1	0	1	3	0	1	1	0	3

Volume Module:

Base Vol:	86	4	24	8	2	19	7	1915	760	82	626	26
Growth Adj:	1.00	1.00	1.00	1.00	1.00	1.00	1.00	1.00	1.00	1.00	1.00	1.00
Initial Bse:	86	4	24	8	2	19	7	1915	760	82	626	26
User Adj:	1.00	1.00	1.00	1.00	1.00	1.00	1.00	1.00	1.00	1.00	1.00	1.00
PHF Adj:	1.00	1.00	1.00	1.00	1.00	1.00	1.00	1.00	1.00	1.00	1.00	1.00
PHF Volume:	86	4	24	8	2	19	7	1915	760	82	626	26
Reduct Vol:	0	0	0	0	0	0	0	0	0	0	0	0
Reduced Vol:	86	4	24	8	2	19	7	1915	760	82	626	26
PCE Adj:	1.00	1.00	1.00	1.00	1.00	1.00	1.00	1.00	1.00	1.00	1.00	1.00
MLF Adj:	1.00	1.00	1.00	1.00	1.00	1.00	1.00	1.00	1.00	1.00	1.00	1.00
FinalVolume:	86	4	24	8	2	19	7	1915	760	82	626	26

Saturation Flow Module:

Sat/Lane:	1600	1600	1600	1600	1600	1600	1600	1600	1600	1600	1600	1600
Adjustment:	1.00	1.00	1.00	1.00	1.06	1.00	1.00	1.06	1.00	1.00	1.06	1.00
Lanes:	2.00	0.14	0.86	1.00	1.00	1.00	1.00	3.00	1.00	1.00	3.00	1.00
Final Sat.:	3200	229	1371	1600	1700	1600	1600	5100	1600	1600	5100	1600

Capacity Analysis Module:

Vol/Sat:	0.03	0.02	0.02	0.01	0.00	0.01	0.00	0.38	0.48	0.05	0.12	0.02
Crit Moves:	****					****			****	****		

Santa Ana Circulation Element

Level Of Service Computation Report

ICU 1(Loss as Cycle Length %) Method (Base Volume Alternative)

Intersection #15 MacArthur Blvd and Harbor Blvd

Cycle (sec): 100 Critical Vol./Cap.(X): 0.747
Loss Time (sec): 5 Average Delay (sec/veh): xxxxxx
Optimal Cycle: 43 Level Of Service: C

Table with 4 columns: North Bound, South Bound, East Bound, West Bound. Rows include Movement (L-T-R), Control (Protected), Rights (Include), Min. Green, Y+R, and Lanes.

Volume Module: Table with 12 columns representing different traffic volumes and adjustment factors like Growth Adj, Initial Bse, User Adj, PHF Adj, PHF Volume, Reduct Vol, Reduced Vol, PCE Adj, MLF Adj, and Final Volume.

Saturation Flow Module: Table with 12 columns showing saturation flow values and adjustment factors like Sat/Lane, Adjustment, Lanes, and Final Sat.

Capacity Analysis Module: Table with 12 columns showing Vol/Sat and Crit Moves values.

Santa Ana Circulation Element

Level Of Service Computation Report

ICU 1(Loss as Cycle Length %) Method (Base Volume Alternative)

Intersection #16 Harbor Blvd and Sunflower Ave

Cycle (sec): 100 Critical Vol./Cap.(X): 0.705
 Loss Time (sec): 5 Average Delay (sec/veh): xxxxxx
 Optimal Cycle: 38 Level Of Service: C

Approach:	North Bound			South Bound			East Bound			West Bound		
Movement:	L	T	R	L	T	R	L	T	R	L	T	R
Control:	Protected			Protected			Protected			Protected		
Rights:	Include			Include			Include			Include		
Min. Green:	0	0	0	0	0	0	0	0	0	0	0	0
Y+R:	4.0	4.0	4.0	4.0	4.0	4.0	4.0	4.0	4.0	4.0	4.0	4.0
Lanes:	2	0	3	0	1		2	0	3	0	1	

Volume Module:

Base Vol:	221	1128	209	242	2284	56	9	109	42	149	190	107
Growth Adj:	1.00	1.00	1.00	1.00	1.00	1.00	1.00	1.00	1.00	1.00	1.00	1.00
Initial Bse:	221	1128	209	242	2284	56	9	109	42	149	190	107
User Adj:	1.00	1.00	1.00	1.00	1.00	1.00	1.00	1.00	1.00	1.00	1.00	1.00
PHF Adj:	1.00	1.00	1.00	1.00	1.00	1.00	1.00	1.00	1.00	1.00	1.00	1.00
PHF Volume:	221	1128	209	242	2284	56	9	109	42	149	190	107
Reduct Vol:	0	0	0	0	0	0	0	0	0	0	0	0
Reduced Vol:	221	1128	209	242	2284	56	9	109	42	149	190	107
PCE Adj:	1.00	1.00	1.00	1.00	1.00	1.00	1.00	1.00	1.00	1.00	1.00	1.00
MLF Adj:	1.00	1.00	1.00	1.00	1.00	1.00	1.00	1.00	1.00	1.00	1.00	1.00
FinalVolume:	221	1128	209	242	2284	56	9	109	42	149	190	107

Saturation Flow Module:

Sat/Lane:	1600	1600	1600	1600	1600	1600	1600	1600	1600	1600	1600	1600
Adjustment:	1.00	1.06	1.00	1.00	1.06	1.00	1.00	1.04	1.00	1.00	1.00	1.00
Lanes:	2.00	3.00	1.00	2.00	3.00	1.00	1.00	1.44	0.56	1.00	1.28	0.72
Final Sat.:	3200	5100	1600	3200	5100	1600	1600	2410	890	1604	2045	1151

Capacity Analysis Module:

Vol/Sat:	0.07	0.22	0.13	0.08	0.45	0.04	0.01	0.05	0.05	0.09	0.09	0.09
Crit Moves:	****			****			****			****		

Santa Ana Circulation Element

Level Of Service Computation Report
 2000 HCM Operations Method (Base Volume Alternative)

 Intersection #17 Harbor Blvd and I-405 NB Off-Ramp

Cycle (sec): 100 Critical Vol./Cap.(X): 0.573
 Loss Time (sec): 5 Average Delay (sec/veh): 17.9
 Optimal Cycle: 29 Level Of Service: B

Approach:	North Bound			South Bound			East Bound			West Bound		
Movement:	L	T	R	L	T	R	L	T	R	L	T	R
Control:	Protected			Protected			Split Phase			Split Phase		
Rights:	Include			Include			Include			Include		
Min. Green:	0	0	0	0	0	0	0	0	0	0	0	0
Y+R:	4.0	4.0	4.0	4.0	4.0	4.0	4.0	4.0	4.0	4.0	4.0	4.0
Lanes:	0	0	4	0	0	4	0	0	0	1	0	1

Volume Module:

Base Vol:	0	1915	0	0	2007	0	0	0	0	399	0	702
Growth Adj:	1.00	1.00	1.00	1.00	1.00	1.00	1.00	1.00	1.00	1.00	1.00	1.00
Initial Bse:	0	1915	0	0	2007	0	0	0	0	399	0	702
User Adj:	1.00	1.00	1.00	1.00	1.00	1.00	1.00	1.00	1.00	1.00	1.00	1.00
PHF Adj:	1.00	1.00	1.00	1.00	1.00	1.00	1.00	1.00	1.00	1.00	1.00	1.00
PHF Volume:	0	1915	0	0	2007	0	0	0	0	399	0	702
Reduct Vol:	0	0	0	0	0	0	0	0	0	0	0	0
Reduced Vol:	0	1915	0	0	2007	0	0	0	0	399	0	702
PCE Adj:	1.00	1.00	1.00	1.00	1.00	1.00	1.00	1.00	1.00	1.00	1.00	1.00
MLF Adj:	1.00	1.00	1.00	1.00	1.00	1.00	1.00	1.00	1.00	1.00	1.00	1.00
FinalVolume:	0	1915	0	0	2007	0	0	0	0	399	0	702

Saturation Flow Module:

Sat/Lane:	1900	1900	1900	1900	1900	1900	1900	1900	1900	1900	1900	1900
Adjustment:	1.00	0.91	1.00	1.00	0.91	1.00	1.00	1.00	1.00	0.89	1.00	0.89
Lanes:	0.00	4.00	0.00	0.00	4.00	0.00	0.00	0.00	0.00	1.36	0.00	1.64
Final Sat.:	0	6916	0	0	6916	0	0	0	0	2298	0	2762

Capacity Analysis Module:

Vol/Sat:	0.00	0.28	0.00	0.00	0.29	0.00	0.00	0.00	0.00	0.17	0.00	0.25
Crit Moves:	****			****								****
Green/Cycle:	0.00	0.51	0.00	0.00	0.51	0.00	0.00	0.00	0.00	0.44	0.00	0.44
Volume/Cap:	0.00	0.55	0.00	0.00	0.57	0.00	0.00	0.00	0.00	0.39	0.00	0.57
Delay/Veh:	0.0	17.0	0.0	0.0	17.4	0.0	0.0	0.0	0.0	18.8	0.0	21.2
User DelAdj:	1.00	1.00	1.00	1.00	1.00	1.00	1.00	1.00	1.00	1.00	1.00	1.00
AdjDel/Veh:	0.0	17.0	0.0	0.0	17.4	0.0	0.0	0.0	0.0	18.8	0.0	21.2
LOS by Move:	A	B	A	A	B	A	A	A	A	B	A	C
HCM2k85thQ:	0	17	0	0	18	0	0	0	0	9	0	15

 Note: Queue reported is the number of cars per lane.

Santa Ana Circulation Element

Level Of Service Computation Report
 2000 HCM Operations Method (Base Volume Alternative)

 Intersection #18 Harbor Blvd and I-405 SB Off-Ramp

Cycle (sec): 100 Critical Vol./Cap.(X): 0.618
 Loss Time (sec): 5 Average Delay (sec/veh): 15.0
 Optimal Cycle: 31 Level Of Service: B

Approach:	North Bound			South Bound			East Bound			West Bound		
Movement:	L	T	R	L	T	R	L	T	R	L	T	R
Control:	Protected			Protected			Split Phase			Split Phase		
Rights:	Ignore			Include			Include			Include		
Min. Green:	0	0	0	0	0	0	0	0	0	0	0	0
Y+R:	4.0	4.0	4.0	4.0	4.0	4.0	4.0	4.0	4.0	4.0	4.0	4.0
Lanes:	0	0	3	0	0	4	1	0	1	0	0	0

Volume Module:

Base Vol:	0	1993	0	0	1278	0	475	0	529	0	0	0
Growth Adj:	1.00	1.00	1.00	1.00	1.00	1.00	1.00	1.00	1.00	1.00	1.00	1.00
Initial Bse:	0	1993	0	0	1278	0	475	0	529	0	0	0
User Adj:	1.00	1.00	0.00	1.00	1.00	1.00	1.00	1.00	1.00	1.00	1.00	1.00
PHF Adj:	1.00	1.00	0.00	1.00	1.00	1.00	1.00	1.00	1.00	1.00	1.00	1.00
PHF Volume:	0	1993	0	0	1278	0	475	0	529	0	0	0
Reduct Vol:	0	0	0	0	0	0	0	0	0	0	0	0
Reduced Vol:	0	1993	0	0	1278	0	475	0	529	0	0	0
PCE Adj:	1.00	1.00	0.00	1.00	1.00	1.00	1.00	1.00	1.00	1.00	1.00	1.00
MLF Adj:	1.00	1.00	0.00	1.00	1.00	1.00	1.00	1.00	1.00	1.00	1.00	1.00
FinalVolume:	0	1993	0	0	1278	0	475	0	529	0	0	0

Saturation Flow Module:

Sat/Lane:	1900	1900	1900	1900	1900	1900	1900	1900	1900	1900	1900	1900
Adjustment:	1.00	0.91	1.00	1.00	0.91	1.00	0.90	1.00	0.90	1.00	1.00	1.00
Lanes:	0.00	3.00	1.00	0.00	4.00	0.00	1.47	0.00	1.53	0.00	0.00	0.00
Final Sat.:	0	5187	1900	0	6916	0	2519	0	2610	0	0	0

Capacity Analysis Module:

Vol/Sat:	0.00	0.38	0.00	0.00	0.18	0.00	0.19	0.00	0.20	0.00	0.00	0.00
Crit Moves:	****			****			****			****		
Green/Cycle:	0.00	0.62	0.00	0.00	0.62	0.00	0.33	0.00	0.33	0.00	0.00	0.00
Volume/Cap:	0.00	0.62	0.00	0.00	0.30	0.00	0.57	0.00	0.62	0.00	0.00	0.00
Delay/Veh:	0.0	12.0	0.0	0.0	8.8	0.0	28.3	0.0	29.0	0.0	0.0	0.0
User DelAdj:	1.00	1.00	1.00	1.00	1.00	1.00	1.00	1.00	1.00	1.00	1.00	1.00
AdjDel/Veh:	0.0	12.0	0.0	0.0	8.8	0.0	28.3	0.0	29.0	0.0	0.0	0.0
LOS by Move:	A	B	A	A	A	A	C	A	C	A	A	A
HCM2k85thQ:	0	21	0	0	8	0	13	0	15	0	0	0

 Note: Queue reported is the number of cars per lane.

Santa Ana Circulation Element

Level Of Service Computation Report

ICU 1(Loss as Cycle Length %) Method (Base Volume Alternative)

Intersection #19 Fairview St and Civic Center Dr

Cycle (sec): 100 Critical Vol./Cap.(X): 0.676
 Loss Time (sec): 5 Average Delay (sec/veh): xxxxxx
 Optimal Cycle: 35 Level Of Service: B

Approach:	North Bound			South Bound			East Bound			West Bound		
Movement:	L	T	R	L	T	R	L	T	R	L	T	R
Control:	Protected			Protected			Split Phase			Split Phase		
Rights:	WideBypass			Include			Include			Include		
Min. Green:	0	0	0	0	0	0	0	0	0	0	0	0
Y+R:	4.0	4.0	4.0	4.0	4.0	4.0	4.0	4.0	4.0	4.0	4.0	4.0
Lanes:	1	0	2	1	0	2	1	0	1	0	1	0

Volume Module:

Base Vol:	7	1435	465	314	1812	8	7	25	25	50	2	26
Growth Adj:	1.00	1.00	1.00	1.00	1.00	1.00	1.00	1.00	1.00	1.00	1.00	1.00
Initial Bse:	7	1435	465	314	1812	8	7	25	25	50	2	26
User Adj:	1.00	1.00	1.00	1.00	1.00	1.00	1.00	1.00	1.00	1.00	1.00	1.00
PHF Adj:	1.00	1.00	1.00	1.00	1.00	1.00	1.00	1.00	1.00	1.00	1.00	1.00
PHF Volume:	7	1435	465	314	1812	8	7	25	25	50	2	26
Reduct Vol:	0	0	0	0	0	0	0	0	0	0	0	0
Reduced Vol:	7	1435	465	314	1812	8	7	25	25	50	2	26
PCE Adj:	1.00	1.00	1.00	1.00	1.00	1.00	1.00	1.00	1.00	1.00	1.00	1.00
MLF Adj:	1.00	1.00	1.00	1.00	1.00	1.00	1.00	1.00	1.00	1.00	1.00	1.00
FinalVolume:	7	1435	465	314	1812	8	7	25	25	50	2	26

Saturation Flow Module:

Sat/Lane:	1600	1600	1600	1600	1600	1600	1600	1600	1600	1600	1600	1600
Adjustment:	1.00	1.06	1.00	1.00	1.04	1.00	1.00	1.00	1.00	1.00	1.00	1.00
Lanes:	1.00	2.27	0.73	1.00	2.99	0.01	0.24	0.88	0.88	1.92	0.08	1.00
Final Sat.:	1600	3825	1175	1600	4979	21	393	1404	1404	3077	123	1600

Capacity Analysis Module:

Vol/Sat:	0.00	0.38	0.40	0.20	0.36	0.38	0.02	0.02	0.02	0.02	0.02	0.02
Crit Moves:			****	****			****			****		

Santa Ana Circulation Element

Level Of Service Computation Report

ICU 1(Loss as Cycle Length %) Method (Base Volume Alternative)

Intersection #20 Fairview St and 1st St

Cycle (sec): 100 Critical Vol./Cap.(X): 0.887
Loss Time (sec): 5 Average Delay (sec/veh): xxxxxx
Optimal Cycle: 80 Level Of Service: D

Table with 4 columns: North Bound, South Bound, East Bound, West Bound. Rows include Movement (L-T-R), Control (Protected), Rights (Include), Min. Green, Y+R, and Lanes.

Volume Module: Table with 12 columns representing different volume categories and their values.

Saturation Flow Module: Table with 12 columns representing saturation flow values for various lanes.

Capacity Analysis Module: Table with 12 columns representing capacity analysis values.

Santa Ana Circulation Element

Level Of Service Computation Report

ICU 1(Loss as Cycle Length %) Method (Base Volume Alternative)

Intersection #21 Fairview St and McFadden Ave

Cycle (sec): 100 Critical Vol./Cap.(X): 0.800
Loss Time (sec): 5 Average Delay (sec/veh): xxxxxx
Optimal Cycle: 52 Level Of Service: D

Table with 4 columns: North Bound, South Bound, East Bound, West Bound. Rows include Movement (L-T-R), Control (Protected), Rights (Include), Min. Green, Y+R, and Lanes.

Volume Module: Table with 12 columns representing different volume categories and their values across the four directions.

Saturation Flow Module: Table with 12 columns representing saturation flow values for different lane configurations.

Capacity Analysis Module: Table with 12 columns representing capacity analysis values such as Vol/Sat and Crit Moves.

Santa Ana Circulation Element

Level Of Service Computation Report

ICU 1(Loss as Cycle Length %) Method (Base Volume Alternative)

Intersection #22 Fairview St and Edinger Ave

Cycle (sec): 100 Critical Vol./Cap.(X): 0.882
 Loss Time (sec): 5 Average Delay (sec/veh): xxxxxx
 Optimal Cycle: 77 Level Of Service: D

Approach:	North Bound			South Bound			East Bound			West Bound		
Movement:	L	T	R	L	T	R	L	T	R	L	T	R
Control:	Protected			Protected			Protected			Protected		
Rights:	Include			Include			Include			Include		
Min. Green:	0	0	0	0	0	0	0	0	0	0	0	0
Y+R:	4.0	4.0	4.0	4.0	4.0	4.0	4.0	4.0	4.0	4.0	4.0	4.0
Lanes:	2	0	2	1	0	0	2	0	2	1	0	0

Volume Module:

Base Vol:	212	935	131	225	1576	133	361	1002	268	463	608	121
Growth Adj:	1.00	1.00	1.00	1.00	1.00	1.00	1.00	1.00	1.00	1.00	1.00	1.00
Initial Bse:	212	935	131	225	1576	133	361	1002	268	463	608	121
User Adj:	1.00	1.00	1.00	1.00	1.00	1.00	1.00	1.00	1.00	1.00	1.00	1.00
PHF Adj:	1.00	1.00	1.00	1.00	1.00	1.00	1.00	1.00	1.00	1.00	1.00	1.00
PHF Volume:	212	935	131	225	1576	133	361	1002	268	463	608	121
Reduct Vol:	0	0	0	0	0	0	0	0	0	0	0	0
Reduced Vol:	212	935	131	225	1576	133	361	1002	268	463	608	121
PCE Adj:	1.00	1.00	1.00	1.00	1.00	1.00	1.00	1.00	1.00	1.00	1.00	1.00
MLF Adj:	1.00	1.00	1.00	1.00	1.00	1.00	1.00	1.00	1.00	1.00	1.00	1.00
FinalVolume:	212	935	131	225	1576	133	361	1002	268	463	608	121

Saturation Flow Module:

Sat/Lane:	1600	1600	1600	1600	1600	1600	1600	1600	1600	1600	1600	1600
Adjustment:	1.00	1.05	1.00	1.00	1.05	1.00	1.00	1.05	1.00	1.00	1.05	1.00
Lanes:	2.00	2.63	0.37	2.00	2.77	0.23	2.00	2.37	0.63	2.00	2.50	0.50
Final Sat.:	3200	4410	590	3200	4626	374	3200	3987	1013	3200	4203	797

Capacity Analysis Module:

Vol/Sat:	0.07	0.21	0.22	0.07	0.34	0.36	0.11	0.25	0.26	0.14	0.14	0.15
Crit Moves:	****					****			****	****		

Santa Ana Circulation Element

Level Of Service Computation Report

ICU 1(Loss as Cycle Length %) Method (Base Volume Alternative)

Intersection #23 Fairview St and Warner Ave

Cycle (sec): 100 Critical Vol./Cap.(X): 0.847
 Loss Time (sec): 5 Average Delay (sec/veh): xxxxxx
 Optimal Cycle: 64 Level Of Service: D

Approach:	North Bound			South Bound			East Bound			West Bound		
Movement:	L	T	R	L	T	R	L	T	R	L	T	R
Control:	Protected			Protected			Protected			Protected		
Rights:	Include			Include			Include			Include		
Min. Green:	0	0	0	0	0	0	0	0	0	0	0	0
Y+R:	4.0	4.0	4.0	4.0	4.0	4.0	4.0	4.0	4.0	4.0	4.0	4.0
Lanes:	2	0	2	1	0	0	2	0	2	1	0	0

Volume Module:

Base Vol:	235	1039	136	205	1628	119	69	1010	301	277	836	271
Growth Adj:	1.00	1.00	1.00	1.00	1.00	1.00	1.00	1.00	1.00	1.00	1.00	1.00
Initial Bse:	235	1039	136	205	1628	119	69	1010	301	277	836	271
User Adj:	1.00	1.00	1.00	1.00	1.00	1.00	1.00	1.00	1.00	1.00	1.00	1.00
PHF Adj:	1.00	1.00	1.00	1.00	1.00	1.00	1.00	1.00	1.00	1.00	1.00	1.00
PHF Volume:	235	1039	136	205	1628	119	69	1010	301	277	836	271
Reduct Vol:	0	0	0	0	0	0	0	0	0	0	0	0
Reduced Vol:	235	1039	136	205	1628	119	69	1010	301	277	836	271
PCE Adj:	1.00	1.00	1.00	1.00	1.00	1.00	1.00	1.00	1.00	1.00	1.00	1.00
MLF Adj:	1.00	1.00	1.00	1.00	1.00	1.00	1.00	1.00	1.00	1.00	1.00	1.00
FinalVolume:	235	1039	136	205	1628	119	69	1010	301	277	836	271

Saturation Flow Module:

Sat/Lane:	1600	1600	1600	1600	1600	1600	1600	1600	1600	1600	1600	1600
Adjustment:	1.00	1.05	1.00	1.00	1.04	1.00	1.00	1.05	1.00	1.00	1.06	1.00
Lanes:	2.00	2.65	0.35	2.00	2.80	0.20	2.00	2.31	0.69	2.00	2.27	0.73
Final Sat.:	3200	4444	556	3200	4673	327	3200	3898	1102	3200	3825	1175

Capacity Analysis Module:

Vol/Sat:	0.07	0.23	0.24	0.06	0.35	0.36	0.02	0.26	0.27	0.09	0.22	0.23
Crit Moves:	****					****			****	****		

Santa Ana Circulation Element

Level Of Service Computation Report

ICU 1(Loss as Cycle Length %) Method (Base Volume Alternative)

Intersection #24 Fairview St and MacArthur Blvd

Cycle (sec): 100 Critical Vol./Cap.(X): 0.690
 Loss Time (sec): 5 Average Delay (sec/veh): xxxxxx
 Optimal Cycle: 36 Level Of Service: B

Approach:	North Bound			South Bound			East Bound			West Bound		
Movement:	L	T	R	L	T	R	L	T	R	L	T	R
Control:	Protected			Protected			Protected			Protected		
Rights:	Include			Include			Include			Include		
Min. Green:	0	0	0	0	0	0	0	0	0	0	0	0
Y+R:	4.0	4.0	4.0	4.0	4.0	4.0	4.0	4.0	4.0	4.0	4.0	4.0
Lanes:	2	0	2	1	0	0	2	0	3	0	1	0

Volume Module:

Base Vol:	280	870	100	269	1357	152	121	984	145	298	627	178
Growth Adj:	1.00	1.00	1.00	1.00	1.00	1.00	1.00	1.00	1.00	1.00	1.00	1.00
Initial Bse:	280	870	100	269	1357	152	121	984	145	298	627	178
User Adj:	1.00	1.00	1.00	1.00	1.00	1.00	1.00	1.00	1.00	1.00	1.00	1.00
PHF Adj:	1.00	1.00	1.00	1.00	1.00	1.00	1.00	1.00	1.00	1.00	1.00	1.00
PHF Volume:	280	870	100	269	1357	152	121	984	145	298	627	178
Reduct Vol:	0	0	0	0	0	0	0	0	0	0	0	0
Reduced Vol:	280	870	100	269	1357	152	121	984	145	298	627	178
PCE Adj:	1.00	1.00	1.00	1.00	1.00	1.00	1.00	1.00	1.00	1.00	1.00	1.00
MLF Adj:	1.00	1.00	1.00	1.00	1.00	1.00	1.00	1.00	1.00	1.00	1.00	1.00
FinalVolume:	280	870	100	269	1357	152	121	984	145	298	627	178

Saturation Flow Module:

Sat/Lane:	1600	1600	1600	1600	1600	1600	1600	1600	1600	1600	1600	1600
Adjustment:	1.00	1.05	1.00	1.00	1.06	1.00	1.00	1.06	1.00	1.00	1.06	1.00
Lanes:	2.00	2.69	0.31	2.00	3.00	1.00	2.00	3.00	1.00	2.00	3.00	1.00
Final Sat.:	3200	4505	495	3200	5100	1600	3200	5100	1600	3200	5100	1600

Capacity Analysis Module:

Vol/Sat:	0.09	0.19	0.20	0.08	0.27	0.10	0.04	0.19	0.09	0.09	0.12	0.11
Crit Moves:	****			****			****			****		

Santa Ana Circulation Element

Level Of Service Computation Report

ICU 1(Loss as Cycle Length %) Method (Base Volume Alternative)

Intersection #25 Fairview Rd and Sunflower Ave

Cycle (sec): 100 Critical Vol./Cap.(X): 0.687
Loss Time (sec): 5 Average Delay (sec/veh): xxxxxx
Optimal Cycle: 36 Level Of Service: B

Table with 4 columns: North Bound, South Bound, East Bound, West Bound. Rows include Movement, Control, Rights, Min. Green, Y+R, and Lanes.

Volume Module: Table with 12 columns representing different volume categories and their values.

Saturation Flow Module: Table with 12 columns representing saturation flow values for various lanes.

Capacity Analysis Module: Table with 12 columns representing capacity analysis values.

Santa Ana Circulation Element

Level Of Service Computation Report

ICU 1(Loss as Cycle Length %) Method (Base Volume Alternative)

Intersection #26 Greenville St and Edinger Ave

Cycle (sec): 100 Critical Vol./Cap.(X): 0.742
 Loss Time (sec): 5 Average Delay (sec/veh): xxxxxx
 Optimal Cycle: 42 Level Of Service: C

Approach:	North Bound			South Bound			East Bound			West Bound		
Movement:	L	T	R	L	T	R	L	T	R	L	T	R
Control:	Split Phase			Split Phase			Protected			Protected		
Rights:	Include			Include			Include			Include		
Min. Green:	0	0	0	0	0	0	0	0	0	0	0	0
Y+R:	4.0	4.0	4.0	4.0	4.0	4.0	4.0	4.0	4.0	4.0	4.0	4.0
Lanes:	1	0	0	0	0	0	0	0	2	1	0	3

Volume Module:

Base Vol:	140	0	188	0	0	0	0	1788	436	178	949	0
Growth Adj:	1.00	1.00	1.00	1.00	1.00	1.00	1.00	1.00	1.00	1.00	1.00	1.00
Initial Bse:	140	0	188	0	0	0	0	1788	436	178	949	0
User Adj:	1.00	1.00	1.00	1.00	1.00	1.00	1.00	1.00	1.00	1.00	1.00	1.00
PHF Adj:	1.00	1.00	1.00	1.00	1.00	1.00	1.00	1.00	1.00	1.00	1.00	1.00
PHF Volume:	140	0	188	0	0	0	0	1788	436	178	949	0
Reduct Vol:	0	0	0	0	0	0	0	0	0	0	0	0
Reduced Vol:	140	0	188	0	0	0	0	1788	436	178	949	0
PCE Adj:	1.00	1.00	1.00	1.00	1.00	1.00	1.00	1.00	1.00	1.00	1.00	1.00
MLF Adj:	1.00	1.00	1.00	1.00	1.00	1.00	1.00	1.00	1.00	1.00	1.00	1.00
FinalVolume:	140	0	188	0	0	0	0	1788	436	178	949	0

Saturation Flow Module:

Sat/Lane:	1600	1600	1600	1600	1600	1600	1600	1600	1600	1600	1600	1600
Adjustment:	1.00	1.06	1.00	1.00	1.06	1.00	1.00	1.05	1.00	1.00	1.06	1.00
Lanes:	1.00	0.00	1.00	0.00	0.00	0.00	0.00	2.41	0.59	1.00	3.00	0.00
Final Sat.:	1600	0	1600	0	0	0	0	4059	941	1600	5100	0

Capacity Analysis Module:

Vol/Sat:	0.09	0.00	0.12	0.00	0.00	0.00	0.00	0.44	0.46	0.11	0.19	0.00
Crit Moves:	****			****			****			****		

Santa Ana Circulation Element

Level Of Service Computation Report

ICU 1(Loss as Cycle Length %) Method (Base Volume Alternative)

Intersection #27 Greenville St and Segerstrom Ave

Cycle (sec): 100 Critical Vol./Cap.(X): 0.878
Loss Time (sec): 5 Average Delay (sec/veh): xxxxxx
Optimal Cycle: 76 Level Of Service: D

Table with 4 columns: North Bound, South Bound, East Bound, West Bound. Rows include Movement (L-T-R), Control (Permitted), Rights (Include), Min. Green, Y+R, and Lanes.

Volume Module: Table with 12 columns representing different volume components and their values.

Saturation Flow Module: Table with 12 columns representing saturation flow values and adjustment factors.

Capacity Analysis Module: Table with 12 columns representing capacity analysis values.

Santa Ana Circulation Element

Level Of Service Computation Report

ICU 1(Loss as Cycle Length %) Method (Base Volume Alternative)

Intersection #28 Raitt St and McFadden Ave

Cycle (sec): 100 Critical Vol./Cap.(X): 0.704
 Loss Time (sec): 5 Average Delay (sec/veh): xxxxxx
 Optimal Cycle: 38 Level Of Service: C

Approach:	North Bound			South Bound			East Bound			West Bound		
Movement:	L	T	R	L	T	R	L	T	R	L	T	R
Control:	Protected			Protected			Protected			Protected		
Rights:	Include			Include			Include			Include		
Min. Green:	0	0	0	0	0	0	0	0	0	0	0	0
Y+R:	4.0	4.0	4.0	4.0	4.0	4.0	4.0	4.0	4.0	4.0	4.0	4.0
Lanes:	1	0	0	1	0	0	1	0	0	1	0	0

Volume Module:

Base Vol:	34	309	49	69	528	72	52	313	40	60	190	34
Growth Adj:	1.00	1.00	1.00	1.00	1.00	1.00	1.00	1.00	1.00	1.00	1.00	1.00
Initial Bse:	34	309	49	69	528	72	52	313	40	60	190	34
User Adj:	1.00	1.00	1.00	1.00	1.00	1.00	1.00	1.00	1.00	1.00	1.00	1.00
PHF Adj:	1.00	1.00	1.00	1.00	1.00	1.00	1.00	1.00	1.00	1.00	1.00	1.00
PHF Volume:	34	309	49	69	528	72	52	313	40	60	190	34
Reduct Vol:	0	0	0	0	0	0	0	0	0	0	0	0
Reduced Vol:	34	309	49	69	528	72	52	313	40	60	190	34
PCE Adj:	1.00	1.00	1.00	1.00	1.00	1.00	1.00	1.00	1.00	1.00	1.00	1.00
MLF Adj:	1.00	1.00	1.00	1.00	1.00	1.00	1.00	1.00	1.00	1.00	1.00	1.00
FinalVolume:	34	309	49	69	528	72	52	313	40	60	190	34

Saturation Flow Module:

Sat/Lane:	1600	1600	1600	1600	1600	1600	1600	1600	1600	1600	1600	1600
Adjustment:	1.00	1.00	1.00	1.00	1.00	1.00	1.00	1.00	1.00	1.00	1.00	1.00
Lanes:	1.00	0.86	0.14	1.00	0.88	0.12	1.00	0.89	0.11	1.00	0.85	0.15
Final Sat.:	1600	1381	219	1600	1408	192	1600	1419	181	1600	1357	243

Capacity Analysis Module:

Vol/Sat:	0.02	0.22	0.22	0.04	0.38	0.38	0.03	0.22	0.22	0.04	0.14	0.14
Crit Moves:	****			****			****			****		

Santa Ana Circulation Element

Level Of Service Computation Report

ICU 1(Loss as Cycle Length %) Method (Base Volume Alternative)

Intersection #29 Raitt St and Edinger Ave

Cycle (sec): 100 Critical Vol./Cap.(X): 0.926
 Loss Time (sec): 5 Average Delay (sec/veh): xxxxxx
 Optimal Cycle: 105 Level Of Service: E

Approach:	North Bound			South Bound			East Bound			West Bound		
Movement:	L	T	R	L	T	R	L	T	R	L	T	R
Control:	Protected			Protected			Protected			Protected		
Rights:	Include			Include			Include			Include		
Min. Green:	0	0	0	0	0	0	0	0	0	0	0	0
Y+R:	4.0	4.0	4.0	4.0	4.0	4.0	4.0	4.0	4.0	4.0	4.0	4.0
Lanes:	1	0	0	1	0	0	1	0	2	1	0	2

Volume Module:

Base Vol:	85	228	82	80	376	45	330	2016	290	127	992	59
Growth Adj:	1.00	1.00	1.00	1.00	1.00	1.00	1.00	1.00	1.00	1.00	1.00	1.00
Initial Bse:	85	228	82	80	376	45	330	2016	290	127	992	59
User Adj:	1.00	1.00	1.00	1.00	1.00	1.00	1.00	1.00	1.00	1.00	1.00	1.00
PHF Adj:	1.00	1.00	1.00	1.00	1.00	1.00	1.00	1.00	1.00	1.00	1.00	1.00
PHF Volume:	85	228	82	80	376	45	330	2016	290	127	992	59
Reduct Vol:	0	0	0	0	0	0	0	0	0	0	0	0
Reduced Vol:	85	228	82	80	376	45	330	2016	290	127	992	59
PCE Adj:	1.00	1.00	1.00	1.00	1.00	1.00	1.00	1.00	1.00	1.00	1.00	1.00
MLF Adj:	1.00	1.00	1.00	1.00	1.00	1.00	1.00	1.00	1.00	1.00	1.00	1.00
FinalVolume:	85	228	82	80	376	45	330	2016	290	127	992	59

Saturation Flow Module:

Sat/Lane:	1600	1600	1600	1600	1600	1600	1600	1600	1600	1600	1600	1600
Adjustment:	1.00	1.00	1.00	1.00	1.00	1.00	1.00	1.05	1.00	1.00	1.04	1.00
Lanes:	1.00	0.74	0.26	1.00	0.89	0.11	1.00	2.62	0.38	1.00	2.83	0.17
Final Sat.:	1600	1177	423	1600	1429	171	1600	4396	604	1600	4731	269

Capacity Analysis Module:

Vol/Sat:	0.05	0.19	0.19	0.05	0.26	0.26	0.21	0.46	0.48	0.08	0.21	0.22
Crit Moves:	****			****			****		****	****		

Santa Ana Circulation Element

Level Of Service Computation Report

ICU 1(Loss as Cycle Length %) Method (Base Volume Alternative)

Intersection #30 Bear St and MacArthur Blvd

Cycle (sec): 100 Critical Vol./Cap.(X): 0.756
 Loss Time (sec): 5 Average Delay (sec/veh): xxxxxx
 Optimal Cycle: 44 Level Of Service: C

Approach:	North Bound			South Bound			East Bound			West Bound		
Movement:	L	T	R	L	T	R	L	T	R	L	T	R
Control:	Protected			Protected			Protected			Protected		
Rights:	Include			Include			Include			Include		
Min. Green:	0	0	0	0	0	0	0	0	0	0	0	0
Y+R:	4.0	4.0	4.0	4.0	4.0	4.0	4.0	4.0	4.0	4.0	4.0	4.0
Lanes:	1	0	2	0	1	1	0	2	1	0	1	0

Volume Module:

Base Vol:	61	210	89	192	728	289	99	1690	116	103	1735	147
Growth Adj:	1.00	1.00	1.00	1.00	1.00	1.00	1.00	1.00	1.00	1.00	1.00	1.00
Initial Bse:	61	210	89	192	728	289	99	1690	116	103	1735	147
User Adj:	1.00	1.00	1.00	1.00	1.00	1.00	1.00	1.00	1.00	1.00	1.00	1.00
PHF Adj:	1.00	1.00	1.00	1.00	1.00	1.00	1.00	1.00	1.00	1.00	1.00	1.00
PHF Volume:	61	210	89	192	728	289	99	1690	116	103	1735	147
Reduct Vol:	0	0	0	0	0	0	0	0	0	0	0	0
Reduced Vol:	61	210	89	192	728	289	99	1690	116	103	1735	147
PCE Adj:	1.00	1.00	1.00	1.00	1.00	1.00	1.00	1.00	1.00	1.00	1.00	1.00
MLF Adj:	1.00	1.00	1.00	1.00	1.00	1.00	1.00	1.00	1.00	1.00	1.00	1.00
FinalVolume:	61	210	89	192	728	289	99	1690	116	103	1735	147

Saturation Flow Module:

Sat/Lane:	1600	1600	1600	1600	1600	1600	1600	1600	1600	1600	1600	1600
Adjustment:	1.00	1.06	1.00	1.00	1.06	1.00	1.00	1.04	1.00	1.00	1.05	1.00
Lanes:	1.00	2.00	1.00	1.00	2.00	1.00	1.00	2.81	0.19	1.00	2.77	0.23
Final Sat.:	1600	3400	1600	1600	3400	1600	1600	4692	308	1600	4625	375

Capacity Analysis Module:

Vol/Sat:	0.04	0.06	0.06	0.12	0.21	0.18	0.06	0.36	0.38	0.06	0.38	0.39
Crit Moves:	****			****			****			****		

Santa Ana Circulation Element

Level Of Service Computation Report

ICU 1(Loss as Cycle Length %) Method (Base Volume Alternative)

Intersection #31 Bristol St and 17th St

Cycle (sec): 100 Critical Vol./Cap.(X): 0.853
 Loss Time (sec): 5 Average Delay (sec/veh): xxxxxx
 Optimal Cycle: 66 Level Of Service: D

Approach:	North Bound			South Bound			East Bound			West Bound		
Movement:	L	T	R	L	T	R	L	T	R	L	T	R
Control:	Protected			Protected			Protected			Protected		
Rights:	Include			Include			Include			Ovl		
Min. Green:	0	0	0	0	0	0	0	0	0	0	0	0
Y+R:	4.0	4.0	4.0	4.0	4.0	4.0	4.0	4.0	4.0	4.0	4.0	4.0
Lanes:	2	0	3	0	1		2	0	3	0	1	

Volume Module:

Base Vol:	241	1241	210	449	1845	243	341	1015	164	386	886	293
Growth Adj:	1.00	1.00	1.00	1.00	1.00	1.00	1.00	1.00	1.00	1.00	1.00	1.00
Initial Bse:	241	1241	210	449	1845	243	341	1015	164	386	886	293
User Adj:	1.00	1.00	1.00	1.00	1.00	1.00	1.00	1.00	1.00	1.00	1.00	1.00
PHF Adj:	1.00	1.00	1.00	1.00	1.00	1.00	1.00	1.00	1.00	1.00	1.00	1.00
PHF Volume:	241	1241	210	449	1845	243	341	1015	164	386	886	293
Reduct Vol:	0	0	0	0	0	0	0	0	0	0	0	0
Reduced Vol:	241	1241	210	449	1845	243	341	1015	164	386	886	293
PCE Adj:	1.00	1.00	1.00	1.00	1.00	1.00	1.00	1.00	1.00	1.00	1.00	1.00
MLF Adj:	1.00	1.00	1.00	1.00	1.00	1.00	1.00	1.00	1.00	1.00	1.00	1.00
FinalVolume:	241	1241	210	449	1845	243	341	1015	164	386	886	293
OvlAdjVol:	69											

Saturation Flow Module:

Sat/Lane:	1600	1600	1600	1600	1600	1600	1600	1600	1600	1600	1600	1600
Adjustment:	1.00	1.06	1.00	1.00	1.06	1.00	1.00	1.05	1.00	1.00	1.06	1.00
Lanes:	2.00	3.00	1.00	2.00	3.00	1.00	2.00	2.58	0.42	2.00	3.00	1.00
Final Sat.:	3200	5100	1600	3200	5100	1600	3200	4332	668	3200	5100	1600

Capacity Analysis Module:

Vol/Sat:	0.08	0.24	0.13	0.14	0.36	0.15	0.11	0.23	0.25	0.12	0.17	0.18
OvlAdjV/S:	0.04											
Crit Moves:	****			****			****			****		

Santa Ana Circulation Element

Level Of Service Computation Report

ICU 1(Loss as Cycle Length %) Method (Base Volume Alternative)

Intersection #32 Bristol St and Civic Center Dr

Cycle (sec): 100 Critical Vol./Cap.(X): 0.931
Loss Time (sec): 5 Average Delay (sec/veh): xxxxxx
Optimal Cycle: 109 Level Of Service: E

Table with 4 columns: North Bound, South Bound, East Bound, West Bound. Rows include Movement, Control, Rights, Min. Green, Y+R, and Lanes.

Volume Module table with 12 columns representing different traffic volumes and 10 rows of adjustment factors.

Saturation Flow Module table with 12 columns representing saturation flow rates and 4 rows of adjustment factors.

Capacity Analysis Module table with 12 columns representing capacity and 2 rows of critical moves.

Santa Ana Circulation Element

Level Of Service Computation Report

ICU 1(Loss as Cycle Length %) Method (Base Volume Alternative)

Intersection #33 Bristol St and Santa Ana Blvd

Cycle (sec): 100 Critical Vol./Cap.(X): 0.721
Loss Time (sec): 5 Average Delay (sec/veh): xxxxxx
Optimal Cycle: 40 Level Of Service: C

Table with 4 columns: North Bound, South Bound, East Bound, West Bound. Rows include Movement (L-T-R), Control, Rights, Min. Green, Y+R, and Lanes.

Volume Module: Table with 12 columns representing traffic volumes and adjustment factors for various conditions like Base Vol, Growth Adj, etc.

Saturation Flow Module: Table with 12 columns showing saturation flow rates and adjustment factors for different lane configurations.

Capacity Analysis Module: Table with 12 columns showing volume-to-saturation ratios and critical movement values.

Santa Ana Circulation Element

Level Of Service Computation Report

ICU 1(Loss as Cycle Length %) Method (Base Volume Alternative)

Intersection #34 Bristol St and 1st St

Cycle (sec): 100 Critical Vol./Cap.(X): 0.902
 Loss Time (sec): 5 Average Delay (sec/veh): xxxxxx
 Optimal Cycle: 88 Level Of Service: E

Approach:	North Bound			South Bound			East Bound			West Bound		
Movement:	L	T	R	L	T	R	L	T	R	L	T	R
Control:	Protected			Protected			Protected			Protected		
Rights:	Include			Include			Include			Include		
Min. Green:	0	0	0	0	0	0	0	0	0	0	0	0
Y+R:	4.0	4.0	4.0	4.0	4.0	4.0	4.0	4.0	4.0	4.0	4.0	4.0
Lanes:	2	0	3	0	1	1	2	0	3	0	1	1

Volume Module:

Base Vol:	208	1451	184	315	1298	183	206	1268	128	126	949	139
Growth Adj:	1.00	1.00	1.00	1.00	1.00	1.00	1.00	1.00	1.00	1.00	1.00	1.00
Initial Bse:	208	1451	184	315	1298	183	206	1268	128	126	949	139
User Adj:	1.00	1.00	1.00	1.00	1.00	1.00	1.00	1.00	1.00	1.00	1.00	1.00
PHF Adj:	1.00	1.00	1.00	1.00	1.00	1.00	1.00	1.00	1.00	1.00	1.00	1.00
PHF Volume:	208	1451	184	315	1298	183	206	1268	128	126	949	139
Reduct Vol:	0	0	0	0	0	0	0	0	0	0	0	0
Reduced Vol:	208	1451	184	315	1298	183	206	1268	128	126	949	139
PCE Adj:	1.00	1.00	1.00	1.00	1.00	1.00	1.00	1.00	1.00	1.00	1.00	1.00
MLF Adj:	1.00	1.00	1.00	1.00	1.00	1.00	1.00	1.00	1.00	1.00	1.00	1.00
FinalVolume:	208	1451	184	315	1298	183	206	1268	128	126	949	139

Saturation Flow Module:

Sat/Lane:	1600	1600	1600	1600	1600	1600	1600	1600	1600	1600	1600	1600
Adjustment:	1.00	1.06	1.00	1.00	1.06	1.00	1.00	1.05	1.00	1.00	1.04	1.00
Lanes:	2.00	3.00	1.00	2.00	3.00	1.00	1.00	2.72	0.28	1.00	1.74	0.26
Final Sat.:	3200	5100	1600	3200	5100	1600	1600	4560	440	1600	2891	409

Capacity Analysis Module:

Vol/Sat:	0.07	0.28	0.12	0.10	0.25	0.11	0.13	0.28	0.29	0.08	0.33	0.34
Crit Moves:	****			****			****			****		

Santa Ana Circulation Element

Level Of Service Computation Report

ICU 1(Loss as Cycle Length %) Method (Base Volume Alternative)

Intersection #35 Bristol St and McFadden Ave

Cycle (sec): 100 Critical Vol./Cap.(X): 0.947
 Loss Time (sec): 5 Average Delay (sec/veh): xxxxxx
 Optimal Cycle: 126 Level Of Service: E

Approach:	North Bound			South Bound			East Bound			West Bound		
Movement:	L	T	R	L	T	R	L	T	R	L	T	R
Control:	Protected			Protected			Prot+Permit			Prot+Permit		
Rights:	Include			Include			Include			Include		
Min. Green:	0	0	0	0	0	0	0	0	0	0	0	0
Y+R:	4.0	4.0	4.0	4.0	4.0	4.0	4.0	4.0	4.0	4.0	4.0	4.0
Lanes:	1	0	3	0	1	0	1	0	0	1	0	0

Volume Module:

Base Vol:	130	1159	58	228	2223	229	155	266	131	145	405	47
Growth Adj:	1.00	1.00	1.00	1.00	1.00	1.00	1.00	1.00	1.00	1.00	1.00	1.00
Initial Bse:	130	1159	58	228	2223	229	155	266	131	145	405	47
User Adj:	1.00	1.00	1.00	1.00	1.00	1.00	1.00	1.00	1.00	1.00	1.00	1.00
PHF Adj:	1.00	1.00	1.00	1.00	1.00	1.00	1.00	1.00	1.00	1.00	1.00	1.00
PHF Volume:	130	1159	58	228	2223	229	155	266	131	145	405	47
Reduct Vol:	0	0	0	0	0	0	0	0	0	0	0	0
Reduced Vol:	130	1159	58	228	2223	229	155	266	131	145	405	47
PCE Adj:	1.00	1.00	1.00	1.00	1.00	1.00	1.00	1.00	1.00	1.00	1.00	1.00
MLF Adj:	1.00	1.00	1.00	1.00	1.00	1.00	1.00	1.00	1.00	1.00	1.00	1.00
FinalVolume:	130	1159	58	228	2223	229	155	266	131	145	405	47

Saturation Flow Module:

Sat/Lane:	1600	1600	1600	1600	1600	1600	1600	1600	1600	1600	1600	1600
Adjustment:	1.00	1.06	1.00	1.00	1.06	1.00	1.00	1.00	1.00	1.00	1.00	1.00
Lanes:	1.00	3.00	1.00	1.00	3.00	1.00	1.00	0.67	0.33	1.00	0.90	0.10
Final Sat.:	1600	5100	1600	1600	5100	1600	1600	1072	528	1600	1434	166

Capacity Analysis Module:

Vol/Sat:	0.08	0.23	0.04	0.14	0.44	0.14	0.10	0.25	0.25	0.09	0.28	0.28
Crit Moves:	****			****			****			****		

Santa Ana Circulation Element

Level Of Service Computation Report

ICU 1(Loss as Cycle Length %) Method (Base Volume Alternative)

Intersection #36 Bristol St and Warner Ave

Cycle (sec): 100 Critical Vol./Cap.(X): 0.956
 Loss Time (sec): 5 Average Delay (sec/veh): xxxxxx
 Optimal Cycle: 139 Level Of Service: E

Approach:	North Bound			South Bound			East Bound			West Bound		
Movement:	L	T	R	L	T	R	L	T	R	L	T	R
Control:	Protected			Protected			Protected			Protected		
Rights:	Include			Include			Include			Include		
Min. Green:	0	0	0	0	0	0	0	0	0	0	0	0
Y+R:	4.0	4.0	4.0	4.0	4.0	4.0	4.0	4.0	4.0	4.0	4.0	4.0
Lanes:	2	0	2	1	0	0	2	0	2	1	0	3

Volume Module:

Base Vol:	221	993	183	643	2178	247	172	958	238	231	1058	180
Growth Adj:	1.00	1.00	1.00	1.00	1.00	1.00	1.00	1.00	1.00	1.00	1.00	1.00
Initial Bse:	221	993	183	643	2178	247	172	958	238	231	1058	180
User Adj:	1.00	1.00	1.00	1.00	1.00	1.00	1.00	1.00	1.00	1.00	1.00	1.00
PHF Adj:	1.00	1.00	1.00	1.00	1.00	1.00	1.00	1.00	1.00	1.00	1.00	1.00
PHF Volume:	221	993	183	643	2178	247	172	958	238	231	1058	180
Reduct Vol:	0	0	0	0	0	0	0	0	0	0	0	0
Reduced Vol:	221	993	183	643	2178	247	172	958	238	231	1058	180
PCE Adj:	1.00	1.00	1.00	1.00	1.00	1.00	1.00	1.00	1.00	1.00	1.00	1.00
MLF Adj:	1.00	1.00	1.00	1.00	1.00	1.00	1.00	1.00	1.00	1.00	1.00	1.00
FinalVolume:	221	993	183	643	2178	247	172	958	238	231	1058	180

Saturation Flow Module:

Sat/Lane:	1600	1600	1600	1600	1600	1600	1600	1600	1600	1600	1600	1600
Adjustment:	1.00	1.05	1.00	1.00	1.05	1.00	1.00	1.06	1.00	1.00	1.06	1.00
Lanes:	2.00	2.53	0.47	2.00	2.69	0.31	1.00	3.00	1.00	1.00	3.00	1.00
Final Sat.:	3200	4253	747	3200	4511	489	1600	5100	1600	1600	5100	1600

Capacity Analysis Module:

Vol/Sat:	0.07	0.23	0.24	0.20	0.48	0.51	0.11	0.19	0.15	0.14	0.21	0.11
Crit Moves:	****					****		****		****		

Santa Ana Circulation Element

Level Of Service Computation Report

ICU 1(Loss as Cycle Length %) Method (Base Volume Alternative)

Intersection #37 Bristol St and Segerstrom Ave

Cycle (sec): 100 Critical Vol./Cap.(X): 0.854
 Loss Time (sec): 5 Average Delay (sec/veh): xxxxxx
 Optimal Cycle: 66 Level Of Service: D

Approach:	North Bound			South Bound			East Bound			West Bound		
Movement:	L	T	R	L	T	R	L	T	R	L	T	R
Control:	Protected			Protected			Protected			Protected		
Rights:	WideBypass			Include			Include			Include		
Min. Green:	0	0	0	0	0	0	0	0	0	0	0	0
Y+R:	4.0	4.0	4.0	4.0	4.0	4.0	4.0	4.0	4.0	4.0	4.0	4.0
Lanes:	1	0	2	1	0	2	1	0	2	1	0	2

Volume Module:

Base Vol:	70	778	146	283	1011	119	306	1480	136	157	712	91
Growth Adj:	1.00	1.00	1.00	1.00	1.00	1.00	1.00	1.00	1.00	1.00	1.00	1.00
Initial Bse:	70	778	146	283	1011	119	306	1480	136	157	712	91
User Adj:	1.00	1.00	1.00	1.00	1.00	1.00	1.00	1.00	1.00	1.00	1.00	1.00
PHF Adj:	1.00	1.00	1.00	1.00	1.00	1.00	1.00	1.00	1.00	1.00	1.00	1.00
PHF Volume:	70	778	146	283	1011	119	306	1480	136	157	712	91
Reduct Vol:	0	0	0	0	0	0	0	0	0	0	0	0
Reduced Vol:	70	778	146	283	1011	119	306	1480	136	157	712	91
PCE Adj:	1.00	1.00	1.00	1.00	1.00	1.00	1.00	1.00	1.00	1.00	1.00	1.00
MLF Adj:	1.00	1.00	1.00	1.00	1.00	1.00	1.00	1.00	1.00	1.00	1.00	1.00
FinalVolume:	70	778	146	283	1011	119	306	1480	136	157	712	91

Saturation Flow Module:

Sat/Lane:	1600	1600	1600	1600	1600	1600	1600	1600	1600	1600	1600	1600
Adjustment:	1.00	1.05	1.00	1.00	1.05	1.00	1.00	1.05	1.00	1.00	1.05	1.00
Lanes:	1.00	2.53	0.47	1.00	2.68	0.32	1.00	2.75	0.25	1.00	2.66	0.34
Final Sat.:	1600	4242	758	1600	4495	505	1600	4596	404	1600	4456	544

Capacity Analysis Module:

Vol/Sat:	0.04	0.18	0.19	0.18	0.22	0.24	0.19	0.32	0.34	0.10	0.16	0.17
Crit Moves:			****	****					****	****		

Santa Ana Circulation Element

Level Of Service Computation Report

ICU 1(Loss as Cycle Length %) Method (Base Volume Alternative)

Intersection #38 Bristol St and Alton Ave

Cycle (sec): 100 Critical Vol./Cap.(X): 0.553
Loss Time (sec): 5 Average Delay (sec/veh): xxxxxx
Optimal Cycle: 26 Level Of Service: A

Table with 4 columns: North Bound, South Bound, East Bound, West Bound. Rows include Movement (L-T-R), Control, Rights, Min. Green, Y+R, and Lanes.

Volume Module: Table with 12 columns representing different traffic movements and 10 rows of adjustment factors like Base Vol, Growth Adj, etc.

Saturation Flow Module: Table with 12 columns and 4 rows showing saturation flow rates and adjustment factors.

Capacity Analysis Module: Table with 12 columns and 3 rows showing volume/saturation ratios and critical moves.

Santa Ana Circulation Element

Level Of Service Computation Report

ICU 1(Loss as Cycle Length %) Method (Base Volume Alternative)

Intersection #39 Bristol St and MacArthur Blvd

Cycle (sec): 100 Critical Vol./Cap.(X): 0.759
 Loss Time (sec): 5 Average Delay (sec/veh): xxxxxx
 Optimal Cycle: 45 Level Of Service: C

Approach:	North Bound			South Bound			East Bound			West Bound		
Movement:	L	T	R	L	T	R	L	T	R	L	T	R
Control:	Protected			Protected			Protected			Protected		
Rights:	Include			Include			Include			Include		
Min. Green:	0	0	0	0	0	0	0	0	0	0	0	0
Y+R:	4.0	4.0	4.0	4.0	4.0	4.0	4.0	4.0	4.0	4.0	4.0	4.0
Lanes:	2	0	3	0	1		2	0	2	1	0	

Volume Module:

Base Vol:	95	491	123	319	1389	145	211	1531	311	191	910	132
Growth Adj:	1.00	1.00	1.00	1.00	1.00	1.00	1.00	1.00	1.00	1.00	1.00	1.00
Initial Bse:	95	491	123	319	1389	145	211	1531	311	191	910	132
User Adj:	1.00	1.00	1.00	1.00	1.00	1.00	1.00	1.00	1.00	1.00	1.00	1.00
PHF Adj:	1.00	1.00	1.00	1.00	1.00	1.00	1.00	1.00	1.00	1.00	1.00	1.00
PHF Volume:	95	491	123	319	1389	145	211	1531	311	191	910	132
Reduct Vol:	0	0	0	0	0	0	0	0	0	0	0	0
Reduced Vol:	95	491	123	319	1389	145	211	1531	311	191	910	132
PCE Adj:	1.00	1.00	1.00	1.00	1.00	1.00	1.00	1.00	1.00	1.00	1.00	1.00
MLF Adj:	1.00	1.00	1.00	1.00	1.00	1.00	1.00	1.00	1.00	1.00	1.00	1.00
FinalVolume:	95	491	123	319	1389	145	211	1531	311	191	910	132

Saturation Flow Module:

Sat/Lane:	1600	1600	1600	1600	1600	1600	1600	1600	1600	1600	1600	1600
Adjustment:	1.00	1.06	1.00	1.00	1.05	1.00	1.00	1.06	1.00	1.00	1.06	1.00
Lanes:	2.00	3.00	1.00	2.00	2.72	0.28	2.00	3.00	1.00	2.00	3.00	1.00
Final Sat.:	3200	5100	1600	3200	4546	454	3200	5100	1600	3200	5100	1600

Capacity Analysis Module:

Vol/Sat:	0.03	0.10	0.08	0.10	0.31	0.32	0.07	0.30	0.19	0.06	0.18	0.08
Crit Moves:	****					****		****		****		

Santa Ana Circulation Element

Level Of Service Computation Report

ICU 1(Loss as Cycle Length %) Method (Base Volume Alternative)

Intersection #40 Bristol St and Sunflower Ave

Cycle (sec): 100 Critical Vol./Cap.(X): 0.682
 Loss Time (sec): 5 Average Delay (sec/veh): xxxxxx
 Optimal Cycle: 35 Level Of Service: B

Approach:	North Bound			South Bound			East Bound			West Bound														
Movement:	L	T	R	L	T	R	L	T	R	L	T	R												
Control:	Protected			Protected			Protected			Protected														
Rights:	Include			Include			Include			Include														
Min. Green:	0	0	0	0	0	0	0	0	0	0	0	0												
Y+R:	4.0	4.0	4.0	4.0	4.0	4.0	4.0	4.0	4.0	4.0	4.0	4.0												
Lanes:	2	0	2	1	1		2	0	3	0	1		2	0	2	1	1		2	0	3	0	1	

Volume Module:

Base Vol:	119	583	172	232	1316	99	135	1115	451	295	480	166
Growth Adj:	1.00	1.00	1.00	1.00	1.00	1.00	1.00	1.00	1.00	1.00	1.00	1.00
Initial Bse:	119	583	172	232	1316	99	135	1115	451	295	480	166
User Adj:	1.00	1.00	1.00	1.00	1.00	1.00	1.00	1.00	1.00	1.00	1.00	1.00
PHF Adj:	1.00	1.00	1.00	1.00	1.00	1.00	1.00	1.00	1.00	1.00	1.00	1.00
PHF Volume:	119	583	172	232	1316	99	135	1115	451	295	480	166
Reduct Vol:	0	0	0	0	0	0	0	0	0	0	0	0
Reduced Vol:	119	583	172	232	1316	99	135	1115	451	295	480	166
PCE Adj:	1.00	1.00	1.00	1.00	1.00	1.00	1.00	1.00	1.00	1.00	1.00	1.00
MLF Adj:	1.00	1.00	1.00	1.00	1.00	1.00	1.00	1.00	1.00	1.00	1.00	1.00
FinalVolume:	119	583	172	232	1316	99	135	1115	451	295	480	166

Saturation Flow Module:

Sat/Lane:	1600	1600	1600	1600	1600	1600	1600	1600	1600	1600	1600	1600
Adjustment:	1.00	1.06	1.00	1.00	1.06	1.00	1.00	1.04	1.00	1.00	1.06	1.00
Lanes:	2.00	3.00	1.00	2.00	3.00	1.00	2.00	2.85	1.15	2.00	3.00	1.00
Final Sat.:	3200	5100	1600	3200	5100	1600	3200	4757	1843	3200	5100	1600

Capacity Analysis Module:

Vol/Sat:	0.04	0.11	0.11	0.07	0.26	0.06	0.04	0.23	0.24	0.09	0.09	0.10
Crit Moves:	****			****			****		****	****		

Santa Ana Circulation Element

Level Of Service Computation Report
 2000 HCM Operations Method (Base Volume Alternative)

 Intersection #41 Bristol St and I-405 NB Ramps

Cycle (sec): 100 Critical Vol./Cap.(X): 0.568
 Loss Time (sec): 5 Average Delay (sec/veh): 20.9
 Optimal Cycle: 28 Level Of Service: C

Approach:	North Bound			South Bound			East Bound			West Bound		
Movement:	L	T	R	L	T	R	L	T	R	L	T	R
Control:	Protected			Protected			Split Phase			Split Phase		
Rights:	Include			Include			Include			Ovl		
Min. Green:	0	0	0	0	0	0	0	0	0	0	0	0
Y+R:	4.0	4.0	4.0	4.0	4.0	4.0	4.0	4.0	4.0	4.0	4.0	4.0
Lanes:	0	0	4	0	0	4	0	0	0	1	1	0

Volume Module:	North Bound			South Bound			East Bound			West Bound		
Base Vol:	0	1638	210	0	2088	8	0	0	36	147	89	807
Growth Adj:	1.00	1.00	1.00	1.00	1.00	1.00	1.00	1.00	1.00	1.00	1.00	1.00
Initial Bse:	0	1638	210	0	2088	8	0	0	36	147	89	807
User Adj:	1.00	1.00	1.00	1.00	1.00	1.00	1.00	1.00	1.00	1.00	1.00	1.00
PHF Adj:	1.00	1.00	1.00	1.00	1.00	1.00	1.00	1.00	1.00	1.00	1.00	1.00
PHF Volume:	0	1638	210	0	2088	8	0	0	36	147	89	807
Reduct Vol:	0	0	0	0	0	0	0	0	0	0	0	0
Reduced Vol:	0	1638	210	0	2088	8	0	0	36	147	89	807
PCE Adj:	1.00	1.00	1.00	1.00	1.00	1.00	1.00	1.00	1.00	1.00	1.00	1.00
MLF Adj:	1.00	1.00	1.00	1.00	1.00	1.00	1.00	1.00	1.00	1.00	1.00	1.00
FinalVolume:	0	1638	210	0	2088	8	0	0	36	147	89	807

Saturation Flow Module:	North Bound			South Bound			East Bound			West Bound		
Sat/Lane:	1900	1900	1900	1900	1900	1900	1900	1900	1900	1900	1900	1900
Adjustment:	1.00	0.91	0.85	1.00	0.91	0.91	1.00	1.00	0.75	0.92	0.92	0.75
Lanes:	0.00	4.00	1.00	0.00	4.98	0.02	0.00	0.00	2.00	1.87	1.13	2.00
Final Sat.:	0	6916	1615	0	8603	33	0	0	2842	3272	1981	2842

Capacity Analysis Module:	North Bound			South Bound			East Bound			West Bound		
Vol/Sat:	0.00	0.24	0.13	0.00	0.24	0.24	0.00	0.00	0.01	0.04	0.04	0.28
Crit Moves:	****			****					****			****
Green/Cycle:	0.00	0.43	0.43	0.00	0.43	0.43	0.00	0.00	0.02	0.50	0.50	0.50
Volume/Cap:	0.00	0.55	0.30	0.00	0.57	0.57	0.00	0.00	0.57	0.09	0.09	0.57
Delay/Veh:	0.0	21.7	19.1	0.0	21.8	21.8	0.0	0.0	60.0	13.1	13.1	18.0
User DelAdj:	1.00	1.00	1.00	1.00	1.00	1.00	1.00	1.00	1.00	1.00	1.00	1.00
AdjDel/Veh:	0.0	21.7	19.1	0.0	21.8	21.8	0.0	0.0	60.0	13.1	13.1	18.0
LOS by Move:	A	C	B	A	C	C	A	A	E	B	B	B
HCM2k85thQ:	0	16	7	0	17	17	0	0	2	2	2	15

 Note: Queue reported is the number of cars per lane.

Santa Ana Circulation Element

Level Of Service Computation Report
 2000 HCM Operations Method (Base Volume Alternative)

 Intersection #42 Bristol St and I-405 SB Ramps

Cycle (sec): 100 Critical Vol./Cap.(X): 0.697
 Loss Time (sec): 5 Average Delay (sec/veh): 23.6
 Optimal Cycle: 38 Level Of Service: C

Approach:	North Bound			South Bound			East Bound			West Bound		
Movement:	L	T	R	L	T	R	L	T	R	L	T	R
Control:	Protected			Protected			Split Phase			Split Phase		
Rights:	Include			Ignore			Include			Include		
Min. Green:	0	0	0	0	0	0	0	0	0	0	0	0
Y+R:	4.0	4.0	4.0	4.0	4.0	4.0	4.0	4.0	4.0	4.0	4.0	4.0
Lanes:	1	0	4	0	0	2	1	1	3	0	0	0

Volume Module:

Base Vol:	122	1195	0	0	1097	943	675	0	618	0	0	0
Growth Adj:	1.00	1.00	1.00	1.00	1.00	1.00	1.00	1.00	1.00	1.00	1.00	1.00
Initial Bse:	122	1195	0	0	1097	943	675	0	618	0	0	0
User Adj:	1.00	1.00	1.00	1.00	1.00	0.00	1.00	1.00	1.00	1.00	1.00	1.00
PHF Adj:	1.00	1.00	1.00	1.00	1.00	0.00	1.00	1.00	1.00	1.00	1.00	1.00
PHF Volume:	122	1195	0	0	1097	0	675	0	618	0	0	0
Reduct Vol:	0	0	0	0	0	0	0	0	0	0	0	0
Reduced Vol:	122	1195	0	0	1097	0	675	0	618	0	0	0
PCE Adj:	1.00	1.00	1.00	1.00	1.00	0.00	1.00	1.00	1.00	1.00	1.00	1.00
MLF Adj:	1.00	1.00	1.00	1.00	1.00	0.00	1.00	1.00	1.00	1.00	1.00	1.00
FinalVolume:	122	1195	0	0	1097	0	675	0	618	0	0	0

Saturation Flow Module:

Sat/Lane:	1900	1900	1900	1900	1900	1900	1900	1900	1900	1900	1900	1900
Adjustment:	0.95	0.91	1.00	1.00	0.91	0.91	0.92	1.00	0.85	1.00	1.00	1.00
Lanes:	1.00	4.00	0.00	0.00	3.00	1.00	3.00	0.00	1.00	0.00	0.00	0.00
Final Sat.:	1805	6916	0	0	5187	1729	5253	0	1615	0	0	0

Capacity Analysis Module:

Vol/Sat:	0.07	0.17	0.00	0.00	0.21	0.00	0.13	0.00	0.38	0.00	0.00	0.00
Crit Moves:	****			****					****			
Green/Cycle:	0.10	0.40	0.00	0.00	0.30	0.00	0.55	0.00	0.55	0.00	0.00	0.00
Volume/Cap:	0.70	0.43	0.00	0.00	0.70	0.00	0.23	0.00	0.70	0.00	0.00	0.00
Delay/Veh:	55.3	21.8	0.0	0.0	32.1	0.0	11.7	0.0	18.9	0.0	0.0	0.0
User DelAdj:	1.00	1.00	1.00	1.00	1.00	1.00	1.00	1.00	1.00	1.00	1.00	1.00
AdjDel/Veh:	55.3	21.8	0.0	0.0	32.1	0.0	11.7	0.0	18.9	0.0	0.0	0.0
LOS by Move:	E	C	A	A	C	A	B	A	B	A	A	A
HCM2k85thQ:	8	11	0	0	18	0	6	0	22	0	0	0

 Note: Queue reported is the number of cars per lane.

Santa Ana Circulation Element

Level Of Service Computation Report

ICU 1(Loss as Cycle Length %) Method (Base Volume Alternative)

Intersection #43 Flower St and Santa Ana Blvd

Cycle (sec): 100 Critical Vol./Cap.(X): 0.586
Loss Time (sec): 5 Average Delay (sec/veh): xxxxxx
Optimal Cycle: 28 Level Of Service: A

Table with 4 columns: North Bound, South Bound, East Bound, West Bound. Rows include Movement (L-T-R), Control (Prot+Permit), Rights (Include), Min. Green, Y+R, and Lanes.

Volume Module: Table with 12 columns representing different traffic volumes and adjustment factors like Base Vol, Growth Adj, Initial Bse, etc.

Saturation Flow Module: Table with 12 columns showing saturation flow values and adjustment factors like Sat/Lane, Adjustment, Lanes, Final Sat.

Capacity Analysis Module: Table with 12 columns showing capacity analysis metrics like Vol/Sat, Crit Moves.

Santa Ana Circulation Element

Level Of Service Computation Report

ICU 1(Loss as Cycle Length %) Method (Base Volume Alternative)

Intersection #44 Flower St and 1st St

Cycle (sec): 100 Critical Vol./Cap.(X): 0.926
 Loss Time (sec): 5 Average Delay (sec/veh): xxxxxx
 Optimal Cycle: 105 Level Of Service: E

Approach:	North Bound			South Bound			East Bound			West Bound		
Movement:	L	T	R	L	T	R	L	T	R	L	T	R
Control:	Protected			Protected			Protected			Protected		
Rights:	Include			Include			Include			Include		
Min. Green:	0	0	0	0	0	0	0	0	0	0	0	0
Y+R:	4.0	4.0	4.0	4.0	4.0	4.0	4.0	4.0	4.0	4.0	4.0	4.0
Lanes:	1	0	1	0	1	0	1	0	1	1	0	1

Volume Module:

Base Vol:	89	387	102	366	1158	121	107	983	39	161	664	95
Growth Adj:	1.00	1.00	1.00	1.00	1.00	1.00	1.00	1.00	1.00	1.00	1.00	1.00
Initial Bse:	89	387	102	366	1158	121	107	983	39	161	664	95
User Adj:	1.00	1.00	1.00	1.00	1.00	1.00	1.00	1.00	1.00	1.00	1.00	1.00
PHF Adj:	1.00	1.00	1.00	1.00	1.00	1.00	1.00	1.00	1.00	1.00	1.00	1.00
PHF Volume:	89	387	102	366	1158	121	107	983	39	161	664	95
Reduct Vol:	0	0	0	0	0	0	0	0	0	0	0	0
Reduced Vol:	89	387	102	366	1158	121	107	983	39	161	664	95
PCE Adj:	1.00	1.00	1.00	1.00	1.00	1.00	1.00	1.00	1.00	1.00	1.00	1.00
MLF Adj:	1.00	1.00	1.00	1.00	1.00	1.00	1.00	1.00	1.00	1.00	1.00	1.00
FinalVolume:	89	387	102	366	1158	121	107	983	39	161	664	95

Saturation Flow Module:

Sat/Lane:	1600	1600	1600	1600	1600	1600	1600	1600	1600	1600	1600	1600
Adjustment:	1.00	1.06	1.00	1.00	1.03	1.00	1.00	1.03	1.00	1.00	1.04	1.00
Lanes:	1.00	1.00	1.00	1.00	1.81	0.19	1.00	1.92	0.08	1.00	1.75	0.25
Final Sat.:	1600	1700	1600	1600	2997	303	1600	3178	122	1600	2899	401

Capacity Analysis Module:

Vol/Sat:	0.06	0.23	0.06	0.23	0.39	0.40	0.07	0.31	0.32	0.10	0.23	0.24
Crit Moves:	****			****			****			****		

Santa Ana Circulation Element

Level Of Service Computation Report

ICU 1(Loss as Cycle Length %) Method (Base Volume Alternative)

Intersection #45 Flower St and McFadden Ave

Cycle (sec): 100 Critical Vol./Cap.(X): 0.807
 Loss Time (sec): 5 Average Delay (sec/veh): xxxxxx
 Optimal Cycle: 54 Level Of Service: D

Approach:	North Bound			South Bound			East Bound			West Bound		
Movement:	L	T	R	L	T	R	L	T	R	L	T	R
Control:	Permitted			Permitted			Permitted			Permitted		
Rights:	Include			Include			Include			Include		
Min. Green:	0	0	0	0	0	0	0	0	0	0	0	0
Y+R:	4.0	4.0	4.0	4.0	4.0	4.0	4.0	4.0	4.0	4.0	4.0	4.0
Lanes:	1	0	0	1	0	0	1	0	0	1	0	0

Volume Module:

Base Vol:	30	219	19	66	367	53	58	658	50	54	366	49
Growth Adj:	1.00	1.00	1.00	1.00	1.00	1.00	1.00	1.00	1.00	1.00	1.00	1.00
Initial Bse:	30	219	19	66	367	53	58	658	50	54	366	49
User Adj:	1.00	1.00	1.00	1.00	1.00	1.00	1.00	1.00	1.00	1.00	1.00	1.00
PHF Adj:	1.00	1.00	1.00	1.00	1.00	1.00	1.00	1.00	1.00	1.00	1.00	1.00
PHF Volume:	30	219	19	66	367	53	58	658	50	54	366	49
Reduct Vol:	0	0	0	0	0	0	0	0	0	0	0	0
Reduced Vol:	30	219	19	66	367	53	58	658	50	54	366	49
PCE Adj:	1.00	1.00	1.00	1.00	1.00	1.00	1.00	1.00	1.00	1.00	1.00	1.00
MLF Adj:	1.00	1.00	1.00	1.00	1.00	1.00	1.00	1.00	1.00	1.00	1.00	1.00
FinalVolume:	30	219	19	66	367	53	58	658	50	54	366	49

Saturation Flow Module:

Sat/Lane:	1600	1600	1600	1600	1600	1600	1600	1600	1600	1600	1600	1600
Adjustment:	1.00	1.00	1.00	1.00	1.00	1.00	1.00	1.00	1.00	1.00	1.00	1.00
Lanes:	1.00	0.92	0.08	1.00	0.87	0.13	1.00	0.93	0.07	1.00	0.88	0.12
Final Sat.:	1600	1472	128	1600	1398	202	1600	1487	113	1600	1411	189

Capacity Analysis Module:

Vol/Sat:	0.02	0.15	0.15	0.04	0.26	0.26	0.04	0.44	0.44	0.03	0.26	0.26
Crit Moves:	****			****			****			****		

Santa Ana Circulation Element

Level Of Service Computation Report

ICU 1(Loss as Cycle Length %) Method (Base Volume Alternative)

Intersection #46 Flower St and Segerstrom Ave

Cycle (sec): 100 Critical Vol./Cap.(X): 0.818
 Loss Time (sec): 5 Average Delay (sec/veh): xxxxxx
 Optimal Cycle: 56 Level Of Service: D

Approach:	North Bound			South Bound			East Bound			West Bound		
Movement:	L	T	R	L	T	R	L	T	R	L	T	R
Control:	Permitted			Permitted			Protected			Protected		
Rights:	Include			Include			Include			Include		
Min. Green:	0	0	0	0	0	0	0	0	0	0	0	0
Y+R:	4.0	4.0	4.0	4.0	4.0	4.0	4.0	4.0	4.0	4.0	4.0	4.0
Lanes:	1	0	1	1	0	1	2	1	0	1	0	2

Volume Module:

Base Vol:	86	451	100	98	544	120	237	1631	455	115	846	93
Growth Adj:	1.00	1.00	1.00	1.00	1.00	1.00	1.00	1.00	1.00	1.00	1.00	1.00
Initial Bse:	86	451	100	98	544	120	237	1631	455	115	846	93
User Adj:	1.00	1.00	1.00	1.00	1.00	1.00	1.00	1.00	1.00	1.00	1.00	1.00
PHF Adj:	1.00	1.00	1.00	1.00	1.00	1.00	1.00	1.00	1.00	1.00	1.00	1.00
PHF Volume:	86	451	100	98	544	120	237	1631	455	115	846	93
Reduct Vol:	0	0	0	0	0	0	0	0	0	0	0	0
Reduced Vol:	86	451	100	98	544	120	237	1631	455	115	846	93
PCE Adj:	1.00	1.00	1.00	1.00	1.00	1.00	1.00	1.00	1.00	1.00	1.00	1.00
MLF Adj:	1.00	1.00	1.00	1.00	1.00	1.00	1.00	1.00	1.00	1.00	1.00	1.00
FinalVolume:	86	451	100	98	544	120	237	1631	455	115	846	93

Saturation Flow Module:

Sat/Lane:	1600	1600	1600	1600	1600	1600	1600	1600	1600	1600	1600	1600
Adjustment:	1.00	1.04	1.00	1.00	1.04	1.00	1.00	1.05	1.00	1.00	1.05	1.00
Lanes:	1.00	1.64	0.36	1.00	1.64	0.36	1.00	2.35	0.65	1.00	2.70	0.30
Final Sat.:	1600	2719	581	1600	2722	578	1600	3953	1047	1600	4525	475

Capacity Analysis Module:

Vol/Sat:	0.05	0.17	0.17	0.06	0.20	0.21	0.15	0.41	0.43	0.07	0.19	0.20
Crit Moves:	****					****			****	****		

Santa Ana Circulation Element

Level Of Service Computation Report

ICU 1(Loss as Cycle Length %) Method (Base Volume Alternative)

Intersection #47 Flower St and MacArthur Blvd

Cycle (sec): 100 Critical Vol./Cap.(X): 0.710
 Loss Time (sec): 5 Average Delay (sec/veh): xxxxxx
 Optimal Cycle: 38 Level Of Service: C

Approach:	North Bound			South Bound			East Bound			West Bound		
Movement:	L	T	R	L	T	R	L	T	R	L	T	R
Control:	Permitted			Permitted			Protected			Protected		
Rights:	Include			Include			Include			Include		
Min. Green:	0	0	0	0	0	0	0	0	0	0	0	0
Y+R:	4.0	4.0	4.0	4.0	4.0	4.0	4.0	4.0	4.0	4.0	4.0	4.0
Lanes:	1	0	1	1	0	1	1	0	2	1	0	2

Volume Module:

Base Vol:	26	170	88	163	352	264	163	1852	79	79	1329	85
Growth Adj:	1.00	1.00	1.00	1.00	1.00	1.00	1.00	1.00	1.00	1.00	1.00	1.00
Initial Bse:	26	170	88	163	352	264	163	1852	79	79	1329	85
User Adj:	1.00	1.00	1.00	1.00	1.00	1.00	1.00	1.00	1.00	1.00	1.00	1.00
PHF Adj:	1.00	1.00	1.00	1.00	1.00	1.00	1.00	1.00	1.00	1.00	1.00	1.00
PHF Volume:	26	170	88	163	352	264	163	1852	79	79	1329	85
Reduct Vol:	0	0	0	0	0	0	0	0	0	0	0	0
Reduced Vol:	26	170	88	163	352	264	163	1852	79	79	1329	85
PCE Adj:	1.00	1.00	1.00	1.00	1.00	1.00	1.00	1.00	1.00	1.00	1.00	1.00
MLF Adj:	1.00	1.00	1.00	1.00	1.00	1.00	1.00	1.00	1.00	1.00	1.00	1.00
FinalVolume:	26	170	88	163	352	264	163	1852	79	79	1329	85

Saturation Flow Module:

Sat/Lane:	1600	1600	1600	1600	1600	1600	1600	1600	1600	1600	1600	1600
Adjustment:	1.00	1.05	1.00	1.00	1.05	1.00	1.00	1.04	1.00	1.00	1.04	1.00
Lanes:	1.00	1.32	0.68	1.00	1.14	0.86	1.00	2.88	0.12	1.00	2.82	0.18
Final Sat.:	1600	2209	1091	1600	1929	1371	1600	4804	196	1600	4711	289

Capacity Analysis Module:

Vol/Sat:	0.02	0.08	0.08	0.10	0.18	0.19	0.10	0.39	0.40	0.05	0.28	0.29
Crit Moves:	****					****			****	****		

Santa Ana Circulation Element

Level Of Service Computation Report

ICU 1(Loss as Cycle Length %) Method (Base Volume Alternative)

Intersection #48 Main St and La Veta Ave

Cycle (sec): 100 Critical Vol./Cap.(X): 0.536
 Loss Time (sec): 5 Average Delay (sec/veh): xxxxxx
 Optimal Cycle: 25 Level Of Service: A

Approach:	North Bound			South Bound			East Bound			West Bound								
Movement:	L	T	R	L	T	R	L	T	R	L	T	R						
Control:	Protected			Protected			Protected			Protected								
Rights:	Ovl			Include			Include			Ovl								
Min. Green:	0	0	0	0	0	0	0	0	0	0	0	0						
Y+R:	4.0	4.0	4.0	4.0	4.0	4.0	4.0	4.0	4.0	4.0	4.0	4.0						
Lanes:	2	0	3	0	1		2	0	2	1	0		2	0	2	0	1	

Volume Module:

Base Vol:	123	844	438	161	843	141	350	495	215	334	291	243
Growth Adj:	1.00	1.00	1.00	1.00	1.00	1.00	1.00	1.00	1.00	1.00	1.00	1.00
Initial Bse:	123	844	438	161	843	141	350	495	215	334	291	243
User Adj:	1.00	1.00	1.00	1.00	1.00	1.00	1.00	1.00	1.00	1.00	1.00	1.00
PHF Adj:	1.00	1.00	1.00	1.00	1.00	1.00	1.00	1.00	1.00	1.00	1.00	1.00
PHF Volume:	123	844	438	161	843	141	350	495	215	334	291	243
Reduct Vol:	0	0	0	0	0	0	0	0	0	0	0	0
Reduced Vol:	123	844	438	161	843	141	350	495	215	334	291	243
PCE Adj:	1.00	1.00	1.00	1.00	1.00	1.00	1.00	1.00	1.00	1.00	1.00	1.00
MLF Adj:	1.00	1.00	1.00	1.00	1.00	1.00	1.00	1.00	1.00	1.00	1.00	1.00
FinalVolume:	123	844	438	161	843	141	350	495	215	334	291	243
OvlAdjVol:	271									163		

Saturation Flow Module:

Sat/Lane:	1600	1600	1600	1600	1600	1600	1600	1600	1600	1600	1600	1600
Adjustment:	1.00	1.06	1.00	1.00	1.05	1.00	1.00	1.06	1.00	1.00	1.06	1.00
Lanes:	2.00	3.00	1.00	2.00	2.57	0.43	2.00	2.09	0.91	2.00	2.00	1.00
Final Sat.:	3200	5100	1600	3200	4312	688	3200	3546	1454	3200	3400	1600

Capacity Analysis Module:

Vol/Sat:	0.04	0.17	0.27	0.05	0.20	0.20	0.11	0.14	0.15	0.10	0.09	0.15
OvlAdjV/S:	0.17									0.10		
Crit Moves:	****			****			****			****		

Santa Ana Circulation Element

Level Of Service Computation Report

ICU 1(Loss as Cycle Length %) Method (Base Volume Alternative)

Intersection #49 Main St and Mainplace Dr / Memory Ln

Cycle (sec): 100 Critical Vol./Cap.(X): 0.456
 Loss Time (sec): 5 Average Delay (sec/veh): xxxxxx
 Optimal Cycle: 22 Level Of Service: A

Approach:	North Bound			South Bound			East Bound			West Bound		
Movement:	L	T	R	L	T	R	L	T	R	L	T	R
Control:	Protected			Protected			Protected			Protected		
Rights:	Include			Include			Include			Include		
Min. Green:	0	0	0	0	0	0	0	0	0	0	0	0
Y+R:	4.0	4.0	4.0	4.0	4.0	4.0	4.0	4.0	4.0	4.0	4.0	4.0
Lanes:	2	0	2	1	0	0	2	0	2	1	0	1

Volume Module:

Base Vol:	35	955	313	27	1066	223	123	194	13	264	301	20
Growth Adj:	1.00	1.00	1.00	1.00	1.00	1.00	1.00	1.00	1.00	1.00	1.00	1.00
Initial Bse:	35	955	313	27	1066	223	123	194	13	264	301	20
User Adj:	1.00	1.00	1.00	1.00	1.00	1.00	1.00	1.00	1.00	1.00	1.00	1.00
PHF Adj:	1.00	1.00	1.00	1.00	1.00	1.00	1.00	1.00	1.00	1.00	1.00	1.00
PHF Volume:	35	955	313	27	1066	223	123	194	13	264	301	20
Reduct Vol:	0	0	0	0	0	0	0	0	0	0	0	0
Reduced Vol:	35	955	313	27	1066	223	123	194	13	264	301	20
PCE Adj:	1.00	1.00	1.00	1.00	1.00	1.00	1.00	1.00	1.00	1.00	1.00	1.00
MLF Adj:	1.00	1.00	1.00	1.00	1.00	1.00	1.00	1.00	1.00	1.00	1.00	1.00
FinalVolume:	35	955	313	27	1066	223	123	194	13	264	301	20

Saturation Flow Module:

Sat/Lane:	1600	1600	1600	1600	1600	1600	1600	1600	1600	1600	1600	1600
Adjustment:	1.00	1.06	1.00	1.00	1.05	1.00	1.00	1.04	1.00	1.00	1.06	1.00
Lanes:	2.00	2.26	0.74	2.00	2.48	0.52	2.00	2.81	0.19	2.00	2.00	1.00
Final Sat.:	3200	3815	1185	3200	4170	830	3200	4699	301	3200	3400	1600

Capacity Analysis Module:

Vol/Sat:	0.01	0.25	0.26	0.01	0.26	0.27	0.04	0.04	0.04	0.08	0.09	0.01
Crit Moves:	****					****	****				****	

Santa Ana Circulation Element

Level Of Service Computation Report

ICU 1(Loss as Cycle Length %) Method (Base Volume Alternative)

Intersection #50 Main St and 17th St

Cycle (sec): 100 Critical Vol./Cap.(X): 0.845
 Loss Time (sec): 5 Average Delay (sec/veh): xxxxxx
 Optimal Cycle: 63 Level Of Service: D

Approach:	North Bound			South Bound			East Bound			West Bound		
Movement:	L	T	R	L	T	R	L	T	R	L	T	R
Control:	Protected			Protected			Protected			Protected		
Rights:	Include			Include			Include			Include		
Min. Green:	0	0	0	0	0	0	0	0	0	0	0	0
Y+R:	4.0	4.0	4.0	4.0	4.0	4.0	4.0	4.0	4.0	4.0	4.0	4.0
Lanes:	2	0	2	0	2	1	2	0	2	1	0	2

Volume Module:

Base Vol:	156	929	199	225	1251	81	114	1203	60	369	1475	22
Growth Adj:	1.00	1.00	1.00	1.00	1.00	1.00	1.00	1.00	1.00	1.00	1.00	1.00
Initial Bse:	156	929	199	225	1251	81	114	1203	60	369	1475	22
User Adj:	1.00	1.00	1.00	1.00	1.00	1.00	1.00	1.00	1.00	1.00	1.00	1.00
PHF Adj:	1.00	1.00	1.00	1.00	1.00	1.00	1.00	1.00	1.00	1.00	1.00	1.00
PHF Volume:	156	929	199	225	1251	81	114	1203	60	369	1475	22
Reduct Vol:	0	0	0	0	0	0	0	0	0	0	0	0
Reduced Vol:	156	929	199	225	1251	81	114	1203	60	369	1475	22
PCE Adj:	1.00	1.00	1.00	1.00	1.00	1.00	1.00	1.00	1.00	1.00	1.00	1.00
MLF Adj:	1.00	1.00	1.00	1.00	1.00	1.00	1.00	1.00	1.00	1.00	1.00	1.00
FinalVolume:	156	929	199	225	1251	81	114	1203	60	369	1475	22

Saturation Flow Module:

Sat/Lane:	1600	1600	1600	1600	1600	1600	1600	1600	1600	1600	1600	1600
Adjustment:	1.00	1.06	1.00	1.00	1.06	1.00	1.00	1.04	1.00	1.00	1.04	1.00
Lanes:	2.00	2.00	1.00	2.00	2.00	1.00	2.00	2.86	0.14	2.00	2.96	0.04
Final Sat.:	3200	3400	1600	3200	3400	1600	3200	4772	228	3200	4929	71

Capacity Analysis Module:

Vol/Sat:	0.05	0.27	0.12	0.07	0.37	0.05	0.04	0.25	0.26	0.12	0.30	0.31
Crit Moves:	****			****			****		****	****		

Santa Ana Circulation Element

Level Of Service Computation Report

ICU 1(Loss as Cycle Length %) Method (Base Volume Alternative)

Intersection #51 Main St and Civic Center Dr

Cycle (sec): 100 Critical Vol./Cap.(X): 0.848
 Loss Time (sec): 5 Average Delay (sec/veh): xxxxxx
 Optimal Cycle: 64 Level Of Service: D

Approach:	North Bound			South Bound			East Bound			West Bound		
Movement:	L	T	R	L	T	R	L	T	R	L	T	R
Control:	Permitted			Permitted			Permitted			Permitted		
Rights:	Include			Include			Include			Include		
Min. Green:	0	0	0	0	0	0	0	0	0	0	0	0
Y+R:	4.0	4.0	4.0	4.0	4.0	4.0	4.0	4.0	4.0	4.0	4.0	4.0
Lanes:	1	0	1	1	0	1	1	0	1	1	0	1

Volume Module:

Base Vol:	138	901	79	69	1222	186	75	454	83	52	679	41
Growth Adj:	1.00	1.00	1.00	1.00	1.00	1.00	1.00	1.00	1.00	1.00	1.00	1.00
Initial Bse:	138	901	79	69	1222	186	75	454	83	52	679	41
User Adj:	1.00	1.00	1.00	1.00	1.00	1.00	1.00	1.00	1.00	1.00	1.00	1.00
PHF Adj:	1.00	1.00	1.00	1.00	1.00	1.00	1.00	1.00	1.00	1.00	1.00	1.00
PHF Volume:	138	901	79	69	1222	186	75	454	83	52	679	41
Reduct Vol:	0	0	0	0	0	0	0	0	0	0	0	0
Reduced Vol:	138	901	79	69	1222	186	75	454	83	52	679	41
PCE Adj:	1.00	1.00	1.00	1.00	1.00	1.00	1.00	1.00	1.00	1.00	1.00	1.00
MLF Adj:	1.00	1.00	1.00	1.00	1.00	1.00	1.00	1.00	1.00	1.00	1.00	1.00
Final Volume:	138	901	79	69	1222	186	75	454	83	52	679	41

Saturation Flow Module:

Sat/Lane:	1600	1600	1600	1600	1600	1600	1600	1600	1600	1600	1600	1600
Adjustment:	1.00	1.03	1.00	1.00	1.04	1.00	1.00	1.04	1.00	1.00	1.03	1.00
Lanes:	1.00	1.84	0.16	1.00	1.74	0.26	1.00	1.69	0.31	1.00	1.89	0.11
Final Sat.:	1600	3042	258	1600	2877	423	1600	2805	495	1600	3118	182

Capacity Analysis Module:

Vol/Sat:	0.09	0.30	0.31	0.04	0.42	0.44	0.05	0.16	0.17	0.03	0.22	0.23
Crit Moves:	****					****	****					****

Santa Ana Circulation Element

Level Of Service Computation Report

ICU 1(Loss as Cycle Length %) Method (Base Volume Alternative)

Intersection #52 Main St and Santa Ana Blvd

Cycle (sec): 100 Critical Vol./Cap.(X): 0.791
 Loss Time (sec): 5 Average Delay (sec/veh): xxxxxx
 Optimal Cycle: 50 Level Of Service: C

Approach:	North Bound			South Bound			East Bound			West Bound		
Movement:	L	T	R	L	T	R	L	T	R	L	T	R
Control:	Permitted			Permitted			Permitted			Permitted		
Rights:	Include			Include			Include			Include		
Min. Green:	0	0	0	0	0	0	0	0	0	0	0	0
Y+R:	4.0	4.0	4.0	4.0	4.0	4.0	4.0	4.0	4.0	4.0	4.0	4.0
Lanes:	1	0	2	0	0	1	0	0	0	0	1	0

Volume Module:

Base Vol:	66	1050	0	0	1162	103	0	0	0	61	848	65
Growth Adj:	1.00	1.00	1.00	1.00	1.00	1.00	1.00	1.00	1.00	1.00	1.00	1.00
Initial Bse:	66	1050	0	0	1162	103	0	0	0	61	848	65
User Adj:	1.00	1.00	1.00	1.00	1.00	1.00	1.00	1.00	1.00	1.00	1.00	1.00
PHF Adj:	1.00	1.00	1.00	1.00	1.00	1.00	1.00	1.00	1.00	1.00	1.00	1.00
PHF Volume:	66	1050	0	0	1162	103	0	0	0	61	848	65
Reduct Vol:	0	0	0	0	0	0	0	0	0	0	0	0
Reduced Vol:	66	1050	0	0	1162	103	0	0	0	61	848	65
PCE Adj:	1.00	1.00	1.00	1.00	1.00	1.00	1.00	1.00	1.00	1.00	1.00	1.00
MLF Adj:	1.00	1.00	1.00	1.00	1.00	1.00	1.00	1.00	1.00	1.00	1.00	1.00
Final Volume:	66	1050	0	0	1162	103	0	0	0	61	848	65

Saturation Flow Module:

Sat/Lane:	1600	1600	1600	1600	1600	1600	1600	1600	1600	1600	1600	1600
Adjustment:	1.00	1.06	1.00	1.00	1.03	1.00	1.00	1.06	1.00	1.00	1.00	1.00
Lanes:	1.00	2.00	0.00	0.00	1.84	0.16	0.00	0.00	0.00	0.13	1.74	0.13
Final Sat.:	1600	3400	0	0	3039	261	0	0	0	200	2786	214

Capacity Analysis Module:

Vol/Sat:	0.04	0.31	0.00	0.00	0.38	0.40	0.00	0.00	0.00	0.04	0.30	0.30
Crit Moves:	****					****					****	

Santa Ana Circulation Element

Level Of Service Computation Report

ICU 1(Loss as Cycle Length %) Method (Base Volume Alternative)

Intersection #53 Main St and 4th St

Cycle (sec): 100 Critical Vol./Cap.(X): 0.441
 Loss Time (sec): 5 Average Delay (sec/veh): xxxxxx
 Optimal Cycle: 21 Level Of Service: A

Approach:	North Bound			South Bound			East Bound			West Bound		
Movement:	L	T	R	L	T	R	L	T	R	L	T	R
Control:	Permitted			Permitted			Permitted			Permitted		
Rights:	Include			Include			Include			Include		
Min. Green:	0	0	0	0	0	0	0	0	0	0	0	0
Y+R:	4.0	4.0	4.0	4.0	4.0	4.0	4.0	4.0	4.0	4.0	4.0	4.0
Lanes:	0	0	1	1	0	0	0	0	1	1	0	0

Volume Module:

Base Vol:	0	1052	25	0	1098	27	0	93	14	0	105	26
Growth Adj:	1.00	1.00	1.00	1.00	1.00	1.00	1.00	1.00	1.00	1.00	1.00	1.00
Initial Bse:	0	1052	25	0	1098	27	0	93	14	0	105	26
User Adj:	1.00	1.00	1.00	1.00	1.00	1.00	1.00	1.00	1.00	1.00	1.00	1.00
PHF Adj:	1.00	1.00	1.00	1.00	1.00	1.00	1.00	1.00	1.00	1.00	1.00	1.00
PHF Volume:	0	1052	25	0	1098	27	0	93	14	0	105	26
Reduct Vol:	0	0	0	0	0	0	0	0	0	0	0	0
Reduced Vol:	0	1052	25	0	1098	27	0	93	14	0	105	26
PCE Adj:	1.00	1.00	1.00	1.00	1.00	1.00	1.00	1.00	1.00	1.00	1.00	1.00
MLF Adj:	1.00	1.00	1.00	1.00	1.00	1.00	1.00	1.00	1.00	1.00	1.00	1.00
FinalVolume:	0	1052	25	0	1098	27	0	93	14	0	105	26

Saturation Flow Module:

Sat/Lane:	1600	1600	1600	1600	1600	1600	1600	1600	1600	1600	1600	1600
Adjustment:	1.00	1.03	1.00	1.00	1.03	1.00	1.00	1.04	1.00	1.00	1.04	1.00
Lanes:	0.00	1.95	0.05	0.00	1.95	0.05	0.00	1.74	0.26	0.00	1.60	0.40
Final Sat.:	0	3226	74	0	3223	77	0	2881	419	0	2665	635

Capacity Analysis Module:

Vol/Sat:	0.00	0.33	0.34	0.00	0.34	0.35	0.00	0.03	0.03	0.00	0.04	0.04
Crit Moves:	****				****	****	****				****	

Santa Ana Circulation Element

Level Of Service Computation Report

ICU 1(Loss as Cycle Length %) Method (Base Volume Alternative)

Intersection #54 Main St and 1st St

Cycle (sec): 100 Critical Vol./Cap.(X): 0.754
 Loss Time (sec): 5 Average Delay (sec/veh): xxxxxx
 Optimal Cycle: 44 Level Of Service: C

Approach:	North Bound			South Bound			East Bound			West Bound		
Movement:	L	T	R	L	T	R	L	T	R	L	T	R
Control:	Protected			Protected			Protected			Protected		
Rights:	Include			Include			Include			Include		
Min. Green:	0	0	0	0	0	0	0	0	0	0	0	0
Y+R:	4.0	4.0	4.0	4.0	4.0	4.0	4.0	4.0	4.0	4.0	4.0	4.0
Lanes:	1	0	1	1	0	1	1	0	1	1	0	1

Volume Module:

Base Vol:	103	532	54	94	937	69	69	805	85	78	972	54
Growth Adj:	1.00	1.00	1.00	1.00	1.00	1.00	1.00	1.00	1.00	1.00	1.00	1.00
Initial Bse:	103	532	54	94	937	69	69	805	85	78	972	54
User Adj:	1.00	1.00	1.00	1.00	1.00	1.00	1.00	1.00	1.00	1.00	1.00	1.00
PHF Adj:	1.00	1.00	1.00	1.00	1.00	1.00	1.00	1.00	1.00	1.00	1.00	1.00
PHF Volume:	103	532	54	94	937	69	69	805	85	78	972	54
Reduct Vol:	0	0	0	0	0	0	0	0	0	0	0	0
Reduced Vol:	103	532	54	94	937	69	69	805	85	78	972	54
PCE Adj:	1.00	1.00	1.00	1.00	1.00	1.00	1.00	1.00	1.00	1.00	1.00	1.00
MLF Adj:	1.00	1.00	1.00	1.00	1.00	1.00	1.00	1.00	1.00	1.00	1.00	1.00
FinalVolume:	103	532	54	94	937	69	69	805	85	78	972	54

Saturation Flow Module:

Sat/Lane:	1600	1600	1600	1600	1600	1600	1600	1600	1600	1600	1600	1600
Adjustment:	1.00	1.03	1.00	1.00	1.06	1.00	1.00	1.03	1.00	1.00	1.03	1.00
Lanes:	1.00	1.82	0.18	1.00	2.00	1.00	1.00	1.81	0.19	1.00	1.89	0.11
Final Sat.:	1600	3005	295	1600	3400	1600	1600	2994	306	1600	3132	168

Capacity Analysis Module:

Vol/Sat:	0.06	0.18	0.18	0.06	0.28	0.04	0.04	0.27	0.28	0.05	0.31	0.32
Crit Moves:	****			****			****			****		

Santa Ana Circulation Element

Level Of Service Computation Report

ICU 1(Loss as Cycle Length %) Method (Base Volume Alternative)

Intersection #55 Main St and McFadden Ave

Cycle (sec): 100 Critical Vol./Cap.(X): 0.916
 Loss Time (sec): 5 Average Delay (sec/veh): xxxxxx
 Optimal Cycle: 97 Level Of Service: E

Approach:	North Bound			South Bound			East Bound			West Bound		
Movement:	L	T	R	L	T	R	L	T	R	L	T	R
Control:	Prot+Permit			Prot+Permit			Protected			Protected		
Rights:	Include			Include			Include			Include		
Min. Green:	0	0	0	0	0	0	0	0	0	0	0	0
Y+R:	4.0	4.0	4.0	4.0	4.0	4.0	4.0	4.0	4.0	4.0	4.0	4.0
Lanes:	1	0	1	1	0	1	0	0	1	1	0	0

Volume Module:

Base Vol:	93	874	44	184	1434	28	44	419	46	97	259	74
Growth Adj:	1.00	1.00	1.00	1.00	1.00	1.00	1.00	1.00	1.00	1.00	1.00	1.00
Initial Bse:	93	874	44	184	1434	28	44	419	46	97	259	74
User Adj:	1.00	1.00	1.00	1.00	1.00	1.00	1.00	1.00	1.00	1.00	1.00	1.00
PHF Adj:	1.00	1.00	1.00	1.00	1.00	1.00	1.00	1.00	1.00	1.00	1.00	1.00
PHF Volume:	93	874	44	184	1434	28	44	419	46	97	259	74
Reduct Vol:	0	0	0	0	0	0	0	0	0	0	0	0
Reduced Vol:	93	874	44	184	1434	28	44	419	46	97	259	74
PCE Adj:	1.00	1.00	1.00	1.00	1.00	1.00	1.00	1.00	1.00	1.00	1.00	1.00
MLF Adj:	1.00	1.00	1.00	1.00	1.00	1.00	1.00	1.00	1.00	1.00	1.00	1.00
FinalVolume:	93	874	44	184	1434	28	44	419	46	97	259	74

Saturation Flow Module:

Sat/Lane:	1600	1600	1600	1600	1600	1600	1600	1600	1600	1600	1600	1600
Adjustment:	1.00	1.03	1.00	1.00	1.03	1.00	1.00	1.00	1.00	1.00	1.00	1.00
Lanes:	1.00	1.90	0.10	1.00	1.96	0.04	1.00	0.90	0.10	1.00	0.78	0.22
Final Sat.:	1600	3147	153	1600	3239	61	1600	1442	158	1600	1244	356

Capacity Analysis Module:

Vol/Sat:	0.06	0.28	0.29	0.12	0.44	0.46	0.03	0.29	0.29	0.06	0.21	0.21
Crit Moves:	****					****		****		****		

Santa Ana Circulation Element

Level Of Service Computation Report

ICU 1(Loss as Cycle Length %) Method (Base Volume Alternative)

Intersection #56 Main St and Edinger Ave

Cycle (sec): 100 Critical Vol./Cap.(X): 0.876
Loss Time (sec): 5 Average Delay (sec/veh): xxxxxx
Optimal Cycle: 75 Level Of Service: D

Table with 4 columns: North Bound, South Bound, East Bound, West Bound. Rows include Movement (L-T-R), Control (Protected), Rights (Include), Min. Green, Y+R, and Lanes.

Volume Module table with 12 columns representing different traffic volumes and 10 rows of adjustment factors like Growth Adj, PHF Adj, etc.

Saturation Flow Module table with 12 columns for saturation flow and 4 rows for Sat/Lane, Adjustment, Lanes, and Final Sat.

Capacity Analysis Module table with 12 columns for capacity analysis and 3 rows for Vol/Sat, Crit Moves, and other metrics.

Santa Ana Circulation Element

Level Of Service Computation Report

ICU 1(Loss as Cycle Length %) Method (Base Volume Alternative)

Intersection #57 Main St and MacArthur Blvd

Cycle (sec): 100 Critical Vol./Cap.(X): 0.721
 Loss Time (sec): 5 Average Delay (sec/veh): xxxxxx
 Optimal Cycle: 40 Level Of Service: C

Approach:	North Bound			South Bound			East Bound			West Bound		
Movement:	L	T	R	L	T	R	L	T	R	L	T	R
Control:	Protected			Protected			Protected			Protected		
Rights:	Include			Include			Include			Include		
Min. Green:	0	0	0	0	0	0	0	0	0	0	0	0
Y+R:	4.0	4.0	4.0	4.0	4.0	4.0	4.0	4.0	4.0	4.0	4.0	4.0
Lanes:	2	0	3	0	1		2	0	3	0	1	

Volume Module:	North Bound			South Bound			East Bound			West Bound		
Base Vol:	60	344	292	539	709	160	230	1336	242	187	556	279
Growth Adj:	1.00	1.00	1.00	1.00	1.00	1.00	1.00	1.00	1.00	1.00	1.00	1.00
Initial Bse:	60	344	292	539	709	160	230	1336	242	187	556	279
User Adj:	1.00	1.00	1.00	1.00	1.00	1.00	1.00	1.00	1.00	1.00	1.00	1.00
PHF Adj:	1.00	1.00	1.00	1.00	1.00	1.00	1.00	1.00	1.00	1.00	1.00	1.00
PHF Volume:	60	344	292	539	709	160	230	1336	242	187	556	279
Reduct Vol:	0	0	0	0	0	0	0	0	0	0	0	0
Reduced Vol:	60	344	292	539	709	160	230	1336	242	187	556	279
PCE Adj:	1.00	1.00	1.00	1.00	1.00	1.00	1.00	1.00	1.00	1.00	1.00	1.00
MLF Adj:	1.00	1.00	1.00	1.00	1.00	1.00	1.00	1.00	1.00	1.00	1.00	1.00
Final Volume:	60	344	292	539	709	160	230	1336	242	187	556	279

Saturation Flow Module:	North Bound			South Bound			East Bound			West Bound		
Sat/Lane:	1600	1600	1600	1600	1600	1600	1600	1600	1600	1600	1600	1600
Adjustment:	1.00	1.06	1.00	1.00	1.06	1.00	1.00	1.06	1.00	1.00	1.06	1.00
Lanes:	2.00	3.00	1.00	2.00	3.00	1.00	2.00	3.00	1.00	2.00	3.00	1.00
Final Sat.:	3200	5100	1600	3200	5100	1600	3200	5100	1600	3200	5100	1600

Capacity Analysis Module:	North Bound			South Bound			East Bound			West Bound		
Vol/Sat:	0.02	0.07	0.18	0.17	0.14	0.10	0.07	0.26	0.15	0.06	0.11	0.17
Crit Moves:			****	****			****			****		

Santa Ana Circulation Element

Level Of Service Computation Report
2000 HCM Operations Method (Base Volume Alternative)

Intersection #58 Penn Wy and 17th St

Cycle (sec): 100 Critical Vol./Cap.(X): 0.648
Loss Time (sec): 5 Average Delay (sec/veh): 12.1
Optimal Cycle: 34 Level Of Service: B

Table with 4 columns: North Bound, South Bound, East Bound, West Bound. Rows include Movement (L-T-R), Control (Split Phase, Protected), Rights (Include), Min. Green, Y+R, and Lanes.

Volume Module table with 12 columns representing different traffic flows and 11 rows of adjustment factors like Growth Adj, User Adj, PHF Adj, etc.

Saturation Flow Module table with 12 columns and 4 rows showing Sat/Lane, Adjustment, Lanes, and Final Sat.

Capacity Analysis Module table with 12 columns and 10 rows showing Vol/Sat, Crit Moves, Green/Cycle, Volume/Cap, Delay/Veh, etc.

Note: Queue reported is the number of cars per lane.

Santa Ana Circulation Element

Level Of Service Computation Report
 2000 HCM Operations Method (Base Volume Alternative)

 Intersection #59 I-5 NB Off Ramps/17th Street

Cycle (sec): 100 Critical Vol./Cap.(X): 0.792
 Loss Time (sec): 5 Average Delay (sec/veh): 31.4
 Optimal Cycle: 53 Level Of Service: C

Street Name:	I-5 NB Off Ramps						17th Street					
Approach:	North Bound			South Bound			East Bound			West Bound		
Movement:	L	T	R	L	T	R	L	T	R	L	T	R
Control:	Split Phase			Split Phase			Protected			Permitted		
Rights:	Include			Include			Ignore			Include		
Min. Green:	0	0	0	0	0	0	0	0	0	0	0	0
Y+R:	4.0	4.0	4.0	4.0	4.0	4.0	4.0	4.0	4.0	4.0	4.0	4.0
Lanes:	1	1	0	0	0	1	1	0	3	0	1	0

Volume Module:

Base Vol:	720	33	21	60	0	312	101	1062	384	0	1508	24
Growth Adj:	1.00	1.00	1.00	1.00	1.00	1.00	1.00	1.00	1.00	1.00	1.00	1.00
Initial Bse:	720	33	21	60	0	312	101	1062	384	0	1508	24
User Adj:	1.00	1.00	1.00	1.00	1.00	1.00	1.00	1.00	0.00	1.00	1.00	1.00
PHF Adj:	1.00	1.00	1.00	1.00	1.00	1.00	1.00	1.00	0.00	1.00	1.00	1.00
PHF Volume:	720	33	21	60	0	312	101	1062	0	0	1508	24
Reduct Vol:	0	0	0	0	0	0	0	0	0	0	0	0
Reduced Vol:	720	33	21	60	0	312	101	1062	0	0	1508	24
PCE Adj:	1.00	1.00	1.00	1.00	1.00	1.00	1.00	1.00	0.00	1.00	1.00	1.00
MLF Adj:	1.00	1.00	1.00	1.00	1.00	1.00	1.00	1.00	0.00	1.00	1.00	1.00
Final Volume:	720	33	21	60	0	312	101	1062	0	0	1508	24

Saturation Flow Module:

Sat/Lane:	1900	1900	1900	1900	1900	1900	1900	1900	1900	1900	1900	1900
Adjustment:	0.95	0.95	0.85	0.95	1.00	0.85	0.95	0.91	1.00	1.00	0.91	0.91
Lanes:	1.91	0.09	1.00	1.00	0.00	1.00	1.00	3.00	1.00	0.00	2.95	0.05
Final Sat.:	3466	159	1615	1805	0	1615	1805	5187	1900	0	5096	81

Capacity Analysis Module:

Vol/Sat:	0.21	0.21	0.01	0.03	0.00	0.19	0.06	0.20	0.00	0.00	0.30	0.30
Crit Moves:	****					****	****				****	
Green/Cycle:	0.26	0.26	0.26	0.24	0.00	0.24	0.07	0.44	0.00	0.00	0.37	0.37
Volume/Cap:	0.79	0.79	0.05	0.14	0.00	0.79	0.79	0.46	0.00	0.00	0.79	0.79
Delay/Veh:	39.0	39.0	27.6	29.7	0.0	45.9	73.6	19.6	0.0	0.0	30.2	30.2
User DelAdj:	1.00	1.00	1.00	1.00	1.00	1.00	1.00	1.00	1.00	1.00	1.00	1.00
AdjDel/Veh:	39.0	39.0	27.6	29.7	0.0	45.9	73.6	19.6	0.0	0.0	30.2	30.2
LOS by Move:	D	D	C	C	A	D	E	B	A	A	C	C
HCM2k85thQ:	19	19	1	2	0	17	8	13	0	0	25	25

Note: Queue reported is the number of cars per lane.

Santa Ana Circulation Element

Level Of Service Computation Report
 2000 HCM Operations Method (Base Volume Alternative)

 Intersection #60 Penn Wy and I-5 SB Ramps

Cycle (sec): 100 Critical Vol./Cap.(X): 0.462
 Loss Time (sec): 5 Average Delay (sec/veh): 19.5
 Optimal Cycle: 23 Level Of Service: B

Approach:	North Bound			South Bound			East Bound			West Bound		
Movement:	L	T	R	L	T	R	L	T	R	L	T	R
Control:	Protected			Protected			Split Phase			Split Phase		
Rights:	Include			Include			Include			Ovl		
Min. Green:	0	0	0	0	0	0	0	0	0	0	0	0
Y+R:	4.0	4.0	4.0	4.0	4.0	4.0	4.0	4.0	4.0	4.0	4.0	4.0
Lanes:	0	0	2	0	1	1	2	0	0	0	0	2

Volume Module:

Base Vol:	0	192	170	837	173	0	0	0	0	170	0	95
Growth Adj:	1.00	1.00	1.00	1.00	1.00	1.00	1.00	1.00	1.00	1.00	1.00	1.00
Initial Bse:	0	192	170	837	173	0	0	0	0	170	0	95
User Adj:	1.00	1.00	1.00	1.00	1.00	1.00	1.00	1.00	1.00	1.00	1.00	1.00
PHF Adj:	1.00	1.00	1.00	1.00	1.00	1.00	1.00	1.00	1.00	1.00	1.00	1.00
PHF Volume:	0	192	170	837	173	0	0	0	0	170	0	95
Reduct Vol:	0	0	0	0	0	0	0	0	0	0	0	0
Reduced Vol:	0	192	170	837	173	0	0	0	0	170	0	95
PCE Adj:	1.00	1.00	1.00	1.00	1.00	1.00	1.00	1.00	1.00	1.00	1.00	1.00
MLF Adj:	1.00	1.00	1.00	1.00	1.00	1.00	1.00	1.00	1.00	1.00	1.00	1.00
FinalVolume:	0	192	170	837	173	0	0	0	0	170	0	95

Saturation Flow Module:

Sat/Lane:	1900	1900	1900	1900	1900	1900	1900	1900	1900	1900	1900	1900
Adjustment:	1.00	0.95	0.85	0.92	0.95	1.00	1.00	1.00	1.00	0.95	1.00	0.75
Lanes:	0.00	2.00	1.00	2.00	2.00	0.00	0.00	0.00	0.00	1.00	0.00	2.00
Final Sat.:	0	3610	1615	3502	3610	0	0	0	0	1805	0	2842

Capacity Analysis Module:

Vol/Sat:	0.00	0.05	0.11	0.24	0.05	0.00	0.00	0.00	0.00	0.09	0.00	0.03
Crit Moves:	****			****						****		
Green/Cycle:	0.00	0.23	0.23	0.52	0.75	0.00	0.00	0.00	0.00	0.20	0.00	0.72
Volume/Cap:	0.00	0.23	0.46	0.46	0.06	0.00	0.00	0.00	0.00	0.46	0.00	0.05
Delay/Veh:	0.0	31.6	34.2	15.5	3.4	0.0	0.0	0.0	0.0	35.9	0.0	4.0
User DelAdj:	1.00	1.00	1.00	1.00	1.00	1.00	1.00	1.00	1.00	1.00	1.00	1.00
AdjDel/Veh:	0.0	31.6	34.2	15.5	3.4	0.0	0.0	0.0	0.0	35.9	0.0	4.0
LOS by Move:	A	C	C	B	A	A	A	A	A	D	A	A
HCM2k85thQ:	0	4	8	13	1	0	0	0	0	8	0	1

 Note: Queue reported is the number of cars per lane.

Santa Ana Circulation Element

Level Of Service Computation Report
 2000 HCM 4-Way Stop Method (Base Volume Alternative)

 Intersection #61 Santiago St and Civic Center Dr

Cycle (sec): 100 Critical Vol./Cap.(X): 1.147
 Loss Time (sec): 5 Average Delay (sec/veh): 62.6
 Optimal Cycle: 0 Level Of Service: F

Approach:	North Bound			South Bound			East Bound			West Bound		
Movement:	L	T	R	L	T	R	L	T	R	L	T	R
Control:	Stop Sign			Stop Sign			Stop Sign			Stop Sign		
Rights:	Include			Include			Include			Include		
Min. Green:	0	0	0	0	0	0	0	0	0	0	0	0
Lanes:	1	0	0	1	0	0	1	0	0	0	0	1

Volume Module:

Base Vol:	318	221	31	6	335	82	212	81	431	126	116	23
Growth Adj:	1.00	1.00	1.00	1.00	1.00	1.00	1.00	1.00	1.00	1.00	1.00	1.00
Initial Bse:	318	221	31	6	335	82	212	81	431	126	116	23
User Adj:	1.00	1.00	1.00	1.00	1.00	1.00	1.00	1.00	1.00	1.00	1.00	1.00
PHF Adj:	1.00	1.00	1.00	1.00	1.00	1.00	1.00	1.00	1.00	1.00	1.00	1.00
PHF Volume:	318	221	31	6	335	82	212	81	431	126	116	23
Reduct Vol:	0	0	0	0	0	0	0	0	0	0	0	0
Reduced Vol:	318	221	31	6	335	82	212	81	431	126	116	23
PCE Adj:	1.00	1.00	1.00	1.00	1.00	1.00	1.00	1.00	1.00	1.00	1.00	1.00
MLF Adj:	1.00	1.00	1.00	1.00	1.00	1.00	1.00	1.00	1.00	1.00	1.00	1.00
FinalVolume:	318	221	31	6	335	82	212	81	431	126	116	23

Saturation Flow Module:

Adjustment:	1.00	1.00	1.00	1.00	1.00	1.00	1.00	1.00	1.00	1.00	1.00	1.00
Lanes:	1.00	0.88	0.12	1.00	0.80	0.20	1.00	0.16	0.84	0.47	0.44	0.09
Final Sat.:	387	362	51	383	333	81	393	71	376	177	163	32

Capacity Analysis Module:

Vol/Sat:	0.82	0.61	0.61	0.02	1.01	1.01	0.54	1.15	1.15	0.71	0.71	0.71
Crit Moves:	****			****			****			****		
Delay/Veh:	42.6	24.0	24.0	12.2	75.9	75.9	22.0	116	116.2	32.7	32.7	32.7
Delay Adj:	1.00	1.00	1.00	1.00	1.00	1.00	1.00	1.00	1.00	1.00	1.00	1.00
AdjDel/Veh:	42.6	24.0	24.0	12.2	75.9	75.9	22.0	116	116.2	32.7	32.7	32.7
LOS by Move:	E	C	C	B	F	F	C	F	F	D	D	D
ApproachDel:	34.4			75.0			88.6			32.7		
Delay Adj:	1.00			1.00			1.00			1.00		
ApprAdjDel:	34.4			75.0			88.6			32.7		
LOS by Appr:	D			F			F			D		
AllWayAvgQ:	3.3	1.4	1.4	0.0	7.4	7.4	1.1	13.1	13.1	2.1	2.1	2.1

 Note: Queue reported is the number of cars per lane.

Santa Ana Circulation Element

Level Of Service Computation Report

ICU 1(Loss as Cycle Length %) Method (Base Volume Alternative)

Intersection #62 Santiago St and Santa Ana Blvd

Cycle (sec): 100 Critical Vol./Cap.(X): 1.444
 Loss Time (sec): 5 Average Delay (sec/veh): xxxxxx
 Optimal Cycle: 180 Level Of Service: F

Approach:	North Bound			South Bound			East Bound			West Bound		
Movement:	L	T	R	L	T	R	L	T	R	L	T	R
Control:	Permitted			Permitted			Protected			Protected		
Rights:	Include			Include			Include			Include		
Min. Green:	0	0	0	0	0	0	0	0	0	0	0	0
Y+R:	4.0	4.0	4.0	4.0	4.0	4.0	4.0	4.0	4.0	4.0	4.0	4.0
Lanes:	1	0	1	0	1	0	1	0	0	1	0	1

Volume Module:

Base Vol:	188	611	303	409	972	253	118	732	99	297	699	258
Growth Adj:	1.00	1.00	1.00	1.00	1.00	1.00	1.00	1.00	1.00	1.00	1.00	1.00
Initial Bse:	188	611	303	409	972	253	118	732	99	297	699	258
User Adj:	1.00	1.00	1.00	1.00	1.00	1.00	1.00	1.00	1.00	1.00	1.00	1.00
PHF Adj:	1.00	1.00	1.00	1.00	1.00	1.00	1.00	1.00	1.00	1.00	1.00	1.00
PHF Volume:	188	611	303	409	972	253	118	732	99	297	699	258
Reduct Vol:	0	0	0	0	0	0	0	0	0	0	0	0
Reduced Vol:	188	611	303	409	972	253	118	732	99	297	699	258
PCE Adj:	1.00	1.00	1.00	1.00	1.00	1.00	1.00	1.00	1.00	1.00	1.00	1.00
MLF Adj:	1.00	1.00	1.00	1.00	1.00	1.00	1.00	1.00	1.00	1.00	1.00	1.00
FinalVolume:	188	611	303	409	972	253	118	732	99	297	699	258

Saturation Flow Module:

Sat/Lane:	1600	1600	1600	1600	1600	1600	1600	1600	1600	1600	1600	1600
Adjustment:	1.00	1.06	1.00	1.00	1.06	1.00	1.00	1.00	1.00	1.00	1.06	1.00
Lanes:	1.00	1.00	1.00	1.00	1.00	1.00	1.00	0.88	0.12	1.00	2.00	1.00
Final Sat.:	1600	1700	1600	1600	1700	1600	1600	1409	191	1600	3400	1600

Capacity Analysis Module:

Vol/Sat:	0.12	0.36	0.19	0.26	0.57	0.16	0.07	0.52	0.52	0.19	0.21	0.16
Crit Moves:	****				****			****		****		

Santa Ana Circulation Element

Level Of Service Computation Report

ICU 1(Loss as Cycle Length %) Method (Base Volume Alternative)

Intersection #63 Standard Ave and 4th St

Cycle (sec): 100 Critical Vol./Cap.(X): 1.340
Loss Time (sec): 5 Average Delay (sec/veh): xxxxxx
Optimal Cycle: 180 Level Of Service: F

Table with 4 columns: North Bound, South Bound, East Bound, West Bound. Rows include Movement (L-T-R), Control (Protected), Rights (Include), Min. Green, Y+R, and Lanes.

Volume Module: Table with 12 columns representing different traffic movements and 10 rows of adjustment factors like Base Vol, Growth Adj, PHF Adj, etc.

Saturation Flow Module: Table with 12 columns and 4 rows showing Sat/Lane, Adjustment, Lanes, and Final Sat.

Capacity Analysis Module: Table with 12 columns and 3 rows showing Vol/Sat, Crit Moves, and other capacity metrics.

Santa Ana Circulation Element

Level Of Service Computation Report

ICU 1(Loss as Cycle Length %) Method (Base Volume Alternative)

Intersection #64 Standard Ave and 1st St

Cycle (sec): 100 Critical Vol./Cap.(X): 1.515
 Loss Time (sec): 5 Average Delay (sec/veh): xxxxxx
 Optimal Cycle: 180 Level Of Service: F

Approach:	North Bound			South Bound			East Bound			West Bound		
Movement:	L	T	R	L	T	R	L	T	R	L	T	R
Control:	Permitted			Permitted			Protected			Protected		
Rights:	Include			Include			Include			Include		
Min. Green:	0	0	0	0	0	0	0	0	0	0	0	0
Y+R:	4.0	4.0	4.0	4.0	4.0	4.0	4.0	4.0	4.0	4.0	4.0	4.0
Lanes:	1	0	0	1	0	0	1	0	1	1	0	1

Volume Module:

Base Vol:	45	631	312	123	901	41	161	1959	121	194	1282	120
Growth Adj:	1.00	1.00	1.00	1.00	1.00	1.00	1.00	1.00	1.00	1.00	1.00	1.00
Initial Bse:	45	631	312	123	901	41	161	1959	121	194	1282	120
User Adj:	1.00	1.00	1.00	1.00	1.00	1.00	1.00	1.00	1.00	1.00	1.00	1.00
PHF Adj:	1.00	1.00	1.00	1.00	1.00	1.00	1.00	1.00	1.00	1.00	1.00	1.00
PHF Volume:	45	631	312	123	901	41	161	1959	121	194	1282	120
Reduct Vol:	0	0	0	0	0	0	0	0	0	0	0	0
Reduced Vol:	45	631	312	123	901	41	161	1959	121	194	1282	120
PCE Adj:	1.00	1.00	1.00	1.00	1.00	1.00	1.00	1.00	1.00	1.00	1.00	1.00
MLF Adj:	1.00	1.00	1.00	1.00	1.00	1.00	1.00	1.00	1.00	1.00	1.00	1.00
FinalVolume:	45	631	312	123	901	41	161	1959	121	194	1282	120

Saturation Flow Module:

Sat/Lane:	1600	1600	1600	1600	1600	1600	1600	1600	1600	1600	1600	1600
Adjustment:	1.00	1.00	1.00	1.00	1.00	1.00	1.00	1.03	1.00	1.00	1.03	1.00
Lanes:	1.00	0.67	0.33	0.11	0.85	0.04	1.00	1.88	0.12	1.00	1.83	0.17
Final Sat.:	1600	1071	529	185	1354	62	1600	3114	186	1600	3026	274

Capacity Analysis Module:

Vol/Sat:	0.03	0.59	0.59	0.08	0.67	0.67	0.10	0.63	0.65	0.12	0.42	0.44
Crit Moves:	****			****			****		****	****		

Santa Ana Circulation Element

Level Of Service Computation Report

ICU 1(Loss as Cycle Length %) Method (Base Volume Alternative)

Intersection #65 Standard Ave and Mcfadden Ave

Cycle (sec): 100 Critical Vol./Cap.(X): 0.843
 Loss Time (sec): 5 Average Delay (sec/veh): xxxxxx
 Optimal Cycle: 63 Level Of Service: D

Approach:	North Bound			South Bound			East Bound			West Bound		
Movement:	L	T	R	L	T	R	L	T	R	L	T	R
Control:	Protected			Protected			Protected			Protected		
Rights:	Include			Include			Include			Include		
Min. Green:	0	0	0	0	0	0	0	0	0	0	0	0
Y+R:	4.0	4.0	4.0	4.0	4.0	4.0	4.0	4.0	4.0	4.0	4.0	4.0
Lanes:	1	0	0	1	0	0	1	0	0	1	0	0

Volume Module:

Base Vol:	44	170	77	123	297	21	21	736	89	81	214	48
Growth Adj:	1.00	1.00	1.00	1.00	1.00	1.00	1.00	1.00	1.00	1.00	1.00	1.00
Initial Bse:	44	170	77	123	297	21	21	736	89	81	214	48
User Adj:	1.00	1.00	1.00	1.00	1.00	1.00	1.00	1.00	1.00	1.00	1.00	1.00
PHF Adj:	1.00	1.00	1.00	1.00	1.00	1.00	1.00	1.00	1.00	1.00	1.00	1.00
PHF Volume:	44	170	77	123	297	21	21	736	89	81	214	48
Reduct Vol:	0	0	0	0	0	0	0	0	0	0	0	0
Reduced Vol:	44	170	77	123	297	21	21	736	89	81	214	48
PCE Adj:	1.00	1.00	1.00	1.00	1.00	1.00	1.00	1.00	1.00	1.00	1.00	1.00
MLF Adj:	1.00	1.00	1.00	1.00	1.00	1.00	1.00	1.00	1.00	1.00	1.00	1.00
FinalVolume:	44	170	77	123	297	21	21	736	89	81	214	48

Saturation Flow Module:

Sat/Lane:	1600	1600	1600	1600	1600	1600	1600	1600	1600	1600	1600	1600
Adjustment:	1.00	1.00	1.00	1.00	1.00	1.00	1.00	1.00	1.00	1.00	1.00	1.00
Lanes:	1.00	0.69	0.31	1.00	0.93	0.07	1.00	0.89	0.11	1.00	0.82	0.18
Final Sat.:	1600	1101	499	1600	1494	106	1600	1427	173	1600	1307	293

Capacity Analysis Module:

Vol/Sat:	0.03	0.15	0.15	0.08	0.20	0.20	0.01	0.52	0.52	0.05	0.16	0.16
Crit Moves:	****			****			****			****		

Santa Ana Circulation Element

Level Of Service Computation Report

ICU 1(Loss as Cycle Length %) Method (Base Volume Alternative)

Intersection #66 Halladay St and Warner Ave

Cycle (sec): 100 Critical Vol./Cap.(X): 0.692
 Loss Time (sec): 5 Average Delay (sec/veh): xxxxxx
 Optimal Cycle: 36 Level Of Service: B

Approach:	North Bound			South Bound			East Bound			West Bound		
Movement:	L	T	R	L	T	R	L	T	R	L	T	R
Control:	Permitted			Permitted			Permitted			Permitted		
Rights:	Include			Include			Include			Include		
Min. Green:	0	0	0	0	0	0	0	0	0	0	0	0
Y+R:	4.0	4.0	4.0	4.0	4.0	4.0	4.0	4.0	4.0	4.0	4.0	4.0
Lanes:	1	0	0	0	0	0	0	0	2	1	0	0

Volume Module:

Base Vol:	69	0	160	0	0	0	0	1772	200	210	797	0
Growth Adj:	1.00	1.00	1.00	1.00	1.00	1.00	1.00	1.00	1.00	1.00	1.00	1.00
Initial Bse:	69	0	160	0	0	0	0	1772	200	210	797	0
User Adj:	1.00	1.00	1.00	1.00	1.00	1.00	1.00	1.00	1.00	1.00	1.00	1.00
PHF Adj:	1.00	1.00	1.00	1.00	1.00	1.00	1.00	1.00	1.00	1.00	1.00	1.00
PHF Volume:	69	0	160	0	0	0	0	1772	200	210	797	0
Reduct Vol:	0	0	0	0	0	0	0	0	0	0	0	0
Reduced Vol:	69	0	160	0	0	0	0	1772	200	210	797	0
PCE Adj:	1.00	1.00	1.00	1.00	1.00	1.00	1.00	1.00	1.00	1.00	1.00	1.00
MLF Adj:	1.00	1.00	1.00	1.00	1.00	1.00	1.00	1.00	1.00	1.00	1.00	1.00
FinalVolume:	69	0	160	0	0	0	0	1772	200	210	797	0

Saturation Flow Module:

Sat/Lane:	1600	1600	1600	1600	1600	1600	1600	1600	1600	1600	1600	1600
Adjustment:	1.00	1.06	1.00	1.00	1.06	1.00	1.00	1.05	1.00	1.00	1.05	1.00
Lanes:	1.00	0.00	1.00	0.00	0.00	0.00	0.00	2.70	0.30	0.63	2.37	0.00
Final Sat.:	1600	0	1600	0	0	0	0	4513	487	1001	3999	0

Capacity Analysis Module:

Vol/Sat:	0.04	0.00	0.10	0.00	0.00	0.00	0.00	0.39	0.41	0.13	0.20	0.00
Crit Moves:	****			****			****			****		

Santa Ana Circulation Element

Level Of Service Computation Report

ICU 1(Loss as Cycle Length %) Method (Base Volume Alternative)

Intersection #67 Halladay St and Dyer Rd

Cycle (sec): 100 Critical Vol./Cap.(X): 0.668
 Loss Time (sec): 5 Average Delay (sec/veh): xxxxxx
 Optimal Cycle: 34 Level Of Service: B

Approach:	North Bound			South Bound			East Bound			West Bound		
Movement:	L	T	R	L	T	R	L	T	R	L	T	R
Control:	Split Phase			Split Phase			Protected			Protected		
Rights:	Include			Include			Include			Include		
Min. Green:	0	0	0	0	0	0	0	0	0	0	0	0
Y+R:	4.0	4.0	4.0	4.0	4.0	4.0	4.0	4.0	4.0	4.0	4.0	4.0
Lanes:	1	0	0	1	0	0	1	0	2	1	0	2

Volume Module:

Base Vol:	16	26	71	155	31	33	54	1820	13	126	686	111
Growth Adj:	1.00	1.00	1.00	1.00	1.00	1.00	1.00	1.00	1.00	1.00	1.00	1.00
Initial Bse:	16	26	71	155	31	33	54	1820	13	126	686	111
User Adj:	1.00	1.00	1.00	1.00	1.00	1.00	1.00	1.00	1.00	1.00	1.00	1.00
PHF Adj:	1.00	1.00	1.00	1.00	1.00	1.00	1.00	1.00	1.00	1.00	1.00	1.00
PHF Volume:	16	26	71	155	31	33	54	1820	13	126	686	111
Reduct Vol:	0	0	0	0	0	0	0	0	0	0	0	0
Reduced Vol:	16	26	71	155	31	33	54	1820	13	126	686	111
PCE Adj:	1.00	1.00	1.00	1.00	1.00	1.00	1.00	1.00	1.00	1.00	1.00	1.00
MLF Adj:	1.00	1.00	1.00	1.00	1.00	1.00	1.00	1.00	1.00	1.00	1.00	1.00
FinalVolume:	16	26	71	155	31	33	54	1820	13	126	686	111

Saturation Flow Module:

Sat/Lane:	1600	1600	1600	1600	1600	1600	1600	1600	1600	1600	1600	1600
Adjustment:	1.00	1.00	1.00	1.00	1.00	1.00	1.00	1.04	1.00	1.00	1.05	1.00
Lanes:	1.00	0.27	0.73	1.00	0.48	0.52	1.00	2.98	0.02	1.00	2.58	0.42
Final Sat.:	1600	429	1171	1600	775	825	1600	4966	34	1600	4331	669

Capacity Analysis Module:

Vol/Sat:	0.01	0.06	0.06	0.10	0.04	0.04	0.03	0.37	0.38	0.08	0.16	0.17
Crit Moves:			****	****					****	****		

Santa Ana Circulation Element

Level Of Service Computation Report
 2000 HCM Operations Method (Base Volume Alternative)

 Intersection #68 SR-55 SB Ramps and MacArthur Blvd

Cycle (sec): 100 Critical Vol./Cap.(X): 0.623
 Loss Time (sec): 5 Average Delay (sec/veh): 20.2
 Optimal Cycle: 32 Level Of Service: C

Approach:	North Bound			South Bound			East Bound			West Bound		
Movement:	L	T	R	L	T	R	L	T	R	L	T	R
Control:	Split Phase			Split Phase			Protected			Protected		
Rights:	Include			Include			Ignore			Ignore		
Min. Green:	0	0	0	0	0	0	0	0	0	0	0	0
Y+R:	4.0	4.0	4.0	4.0	4.0	4.0	4.0	4.0	4.0	4.0	4.0	4.0
Lanes:	0	0	0	2	0	0	0	0	2	1	1	0

Volume Module:

Base Vol:	0	0	0	998	0	903	0	1423	1014	0	1363	155
Growth Adj:	1.00	1.00	1.00	1.00	1.00	1.00	1.00	1.00	1.00	1.00	1.00	1.00
Initial Bse:	0	0	0	998	0	903	0	1423	1014	0	1363	155
User Adj:	1.00	1.00	1.00	1.00	1.00	1.00	1.00	1.00	0.00	1.00	1.00	0.00
PHF Adj:	1.00	1.00	1.00	1.00	1.00	1.00	1.00	1.00	0.00	1.00	1.00	0.00
PHF Volume:	0	0	0	998	0	903	0	1423	0	0	1363	0
Reduct Vol:	0	0	0	0	0	0	0	0	0	0	0	0
Reduced Vol:	0	0	0	998	0	903	0	1423	0	0	1363	0
PCE Adj:	1.00	1.00	1.00	1.00	1.00	1.00	1.00	1.00	0.00	1.00	1.00	0.00
MLF Adj:	1.00	1.00	1.00	1.00	1.00	1.00	1.00	1.00	0.00	1.00	1.00	0.00
FinalVolume:	0	0	0	998	0	903	0	1423	0	0	1363	0

Saturation Flow Module:

Sat/Lane:	1900	1900	1900	1900	1900	1900	1900	1900	1900	1900	1900	1900
Adjustment:	1.00	1.00	1.00	0.92	1.00	0.75	1.00	0.91	0.91	1.00	0.91	1.00
Lanes:	0.00	0.00	0.00	2.00	0.00	2.00	0.00	3.00	1.00	0.00	3.00	1.00
Final Sat.:	0	0	0	3502	0	2842	0	5187	1729	0	5187	1900

Capacity Analysis Module:

Vol/Sat:	0.00	0.00	0.00	0.29	0.00	0.32	0.00	0.27	0.00	0.00	0.26	0.00
Crit Moves:						****		****		****		
Green/Cycle:	0.00	0.00	0.00	0.51	0.00	0.51	0.00	0.44	0.00	0.00	0.44	0.00
Volume/Cap:	0.00	0.00	0.00	0.56	0.00	0.62	0.00	0.62	0.00	0.00	0.60	0.00
Delay/Veh:	0.0	0.0	0.0	17.2	0.0	18.5	0.0	22.1	0.0	0.0	21.7	0.0
User DelAdj:	1.00	1.00	1.00	1.00	1.00	1.00	1.00	1.00	1.00	1.00	1.00	1.00
AdjDel/Veh:	0.0	0.0	0.0	17.2	0.0	18.5	0.0	22.1	0.0	0.0	21.7	0.0
LOS by Move:	A	A	A	B	A	B	A	C	A	A	C	A
HCM2k85thQ:	0	0	0	17	0	18	0	19	0	0	18	0

 Note: Queue reported is the number of cars per lane.

Santa Ana Circulation Element

Level Of Service Computation Report
 2000 HCM Operations Method (Base Volume Alternative)

 Intersection #69 SR-55 NB Ramps and MacArthur Blvd

Cycle (sec): 100 Critical Vol./Cap.(X): 0.728
 Loss Time (sec): 5 Average Delay (sec/veh): 19.5
 Optimal Cycle: 42 Level Of Service: B

Approach:	North Bound			South Bound			East Bound			West Bound		
Movement:	L	T	R	L	T	R	L	T	R	L	T	R
Control:	Split Phase			Split Phase			Protected			Protected		
Rights:	Ignore			Include			Ignore			Ignore		
Min. Green:	0	0	0	0	0	0	0	0	0	0	0	0
Y+R:	4.0	4.0	4.0	4.0	4.0	4.0	4.0	4.0	4.0	4.0	4.0	4.0
Lanes:	2	0	0	0	0	0	0	0	2	0	0	3

Volume Module:

Base Vol:	965	0	1037	0	0	0	0	1503	744	0	591	279
Growth Adj:	1.00	1.00	1.00	1.00	1.00	1.00	1.00	1.00	1.00	1.00	1.00	1.00
Initial Bse:	965	0	1037	0	0	0	0	1503	744	0	591	279
User Adj:	1.00	1.00	0.00	1.00	1.00	1.00	1.00	1.00	0.00	1.00	1.00	0.00
PHF Adj:	1.00	1.00	0.00	1.00	1.00	1.00	1.00	1.00	0.00	1.00	1.00	0.00
PHF Volume:	965	0	0	0	0	0	0	1503	0	0	591	0
Reduct Vol:	0	0	0	0	0	0	0	0	0	0	0	0
Reduced Vol:	965	0	0	0	0	0	0	1503	0	0	591	0
PCE Adj:	1.00	1.00	0.00	1.00	1.00	1.00	1.00	1.00	0.00	1.00	1.00	0.00
MLF Adj:	1.00	1.00	0.00	1.00	1.00	1.00	1.00	1.00	0.00	1.00	1.00	0.00
FinalVolume:	965	0	0	0	0	0	0	1503	0	0	591	0

Saturation Flow Module:

Sat/Lane:	1900	1900	1900	1900	1900	1900	1900	1900	1900	1900	1900	1900
Adjustment:	0.92	1.00	1.00	1.00	1.00	1.00	1.00	0.95	0.88	1.00	0.91	1.00
Lanes:	2.00	0.00	1.00	0.00	0.00	0.00	0.00	2.00	2.00	0.00	3.00	1.00
Final Sat.:	3502	0	1900	0	0	0	0	3610	3344	0	5187	1900

Capacity Analysis Module:

Vol/Sat:	0.28	0.00	0.00	0.00	0.00	0.00	0.00	0.42	0.00	0.00	0.11	0.00
Crit Moves:	****							****		****		
Green/Cycle:	0.38	0.00	0.00	0.00	0.00	0.00	0.00	0.57	0.00	0.00	0.57	0.00
Volume/Cap:	0.73	0.00	0.00	0.00	0.00	0.00	0.00	0.73	0.00	0.00	0.20	0.00
Delay/Veh:	28.7	0.0	0.0	0.0	0.0	0.0	0.0	17.1	0.0	0.0	10.4	0.0
User DelAdj:	1.00	1.00	1.00	1.00	1.00	1.00	1.00	1.00	1.00	1.00	1.00	1.00
AdjDel/Veh:	28.7	0.0	0.0	0.0	0.0	0.0	0.0	17.1	0.0	0.0	10.4	0.0
LOS by Move:	C	A	A	A	A	A	A	B	A	A	B	A
HCM2k85thQ:	21	0	0	0	0	0	0	27	0	0	5	0

 Note: Queue reported is the number of cars per lane.

Santa Ana Circulation Element

Level Of Service Computation Report
 2000 HCM Operations Method (Base Volume Alternative)

 Intersection #70 SR-55 SB Ramps and Dyer Rd

Cycle (sec): 100 Critical Vol./Cap.(X): 0.610
 Loss Time (sec): 5 Average Delay (sec/veh): 25.9
 Optimal Cycle: 31 Level Of Service: C

Approach:	North Bound			South Bound			East Bound			West Bound		
Movement:	L	T	R	L	T	R	L	T	R	L	T	R
Control:	Split Phase			Split Phase			Protected			Protected		
Rights:	Ovl			Include			Include			Include		
Min. Green:	0	0	0	0	0	0	0	0	0	0	0	0
Y+R:	4.0	4.0	4.0	4.0	4.0	4.0	4.0	4.0	4.0	4.0	4.0	4.0
Lanes:	1	1	0	0	1	1	1	0	3	2	0	3

Volume Module:

Base Vol:	312	37	713	50	242	60	34	1282	273	418	663	111
Growth Adj:	1.00	1.00	1.00	1.00	1.00	1.00	1.00	1.00	1.00	1.00	1.00	1.00
Initial Bse:	312	37	713	50	242	60	34	1282	273	418	663	111
User Adj:	1.00	1.00	1.00	1.00	1.00	1.00	1.00	1.00	1.00	1.00	1.00	1.00
PHF Adj:	1.00	1.00	1.00	1.00	1.00	1.00	1.00	1.00	1.00	1.00	1.00	1.00
PHF Volume:	312	37	713	50	242	60	34	1282	273	418	663	111
Reduct Vol:	0	0	0	0	0	0	0	0	0	0	0	0
Reduced Vol:	312	37	713	50	242	60	34	1282	273	418	663	111
PCE Adj:	1.00	1.00	1.00	1.00	1.00	1.00	1.00	1.00	1.00	1.00	1.00	1.00
MLF Adj:	1.00	1.00	1.00	1.00	1.00	1.00	1.00	1.00	1.00	1.00	1.00	1.00
FinalVolume:	312	37	713	50	242	60	34	1282	273	418	663	111

Saturation Flow Module:

Sat/Lane:	1900	1900	1900	1900	1900	1900	1900	1900	1900	1900	1900	1900
Adjustment:	0.96	0.96	0.75	0.94	0.94	0.85	0.95	0.91	0.85	0.92	0.91	0.85
Lanes:	1.79	0.21	2.00	0.34	1.66	1.00	1.00	3.00	1.00	2.00	3.00	1.00
Final Sat.:	3251	386	2842	613	2968	1615	1805	5187	1615	3502	5187	1615

Capacity Analysis Module:

Vol/Sat:	0.10	0.10	0.25	0.08	0.08	0.04	0.02	0.25	0.17	0.12	0.13	0.07
Crit Moves:	****			****			****			****		
Green/Cycle:	0.22	0.22	0.41	0.13	0.13	0.13	0.08	0.41	0.41	0.20	0.52	0.52
Volume/Cap:	0.45	0.45	0.61	0.61	0.61	0.28	0.24	0.61	0.42	0.61	0.24	0.13
Delay/Veh:	34.4	34.4	24.1	43.2	43.2	39.7	44.3	24.0	21.7	38.3	13.1	12.3
User DelAdj:	1.00	1.00	1.00	1.00	1.00	1.00	1.00	1.00	1.00	1.00	1.00	1.00
AdjDel/Veh:	34.4	34.4	24.1	43.2	43.2	39.7	44.3	24.0	21.7	38.3	13.1	12.3
LOS by Move:	C	C	C	D	D	D	D	C	C	D	B	B
HCM2k85thQ:	8	8	16	8	8	3	2	18	9	11	6	3

Note: Queue reported is the number of cars per lane.

Santa Ana Circulation Element

Level Of Service Computation Report

ICU 1(Loss as Cycle Length %) Method (Base Volume Alternative)

Intersection #71 Glassell St and La Veta Ave

Cycle (sec): 100 Critical Vol./Cap.(X): 0.826
 Loss Time (sec): 5 Average Delay (sec/veh): xxxxxx
 Optimal Cycle: 58 Level Of Service: D

Approach:	North Bound			South Bound			East Bound			West Bound		
Movement:	L	T	R	L	T	R	L	T	R	L	T	R
Control:	Protected			Protected			Protected			Protected		
Rights:	Ovl			Include			Ovl			Include		
Min. Green:	0	0	0	0	0	0	0	0	0	0	0	0
Y+R:	4.0	4.0	4.0	4.0	4.0	4.0	4.0	4.0	4.0	4.0	4.0	4.0
Lanes:	2	0	1	0	1	0	1	0	1	0	1	0

Volume Module:	North Bound			South Bound			East Bound			West Bound		
Base Vol:	292	458	139	13	274	60	57	293	563	380	401	10
Growth Adj:	1.00	1.00	1.00	1.00	1.00	1.00	1.00	1.00	1.00	1.00	1.00	1.00
Initial Bse:	292	458	139	13	274	60	57	293	563	380	401	10
User Adj:	1.00	1.00	1.00	1.00	1.00	1.00	1.00	1.00	1.00	1.00	1.00	1.00
PHF Adj:	1.00	1.00	1.00	1.00	1.00	1.00	1.00	1.00	1.00	1.00	1.00	1.00
PHF Volume:	292	458	139	13	274	60	57	293	563	380	401	10
Reduct Vol:	0	0	0	0	0	0	0	0	0	0	0	0
Reduced Vol:	292	458	139	13	274	60	57	293	563	380	401	10
PCE Adj:	1.00	1.00	1.00	1.00	1.00	1.00	1.00	1.00	1.00	1.00	1.00	1.00
MLF Adj:	1.00	1.00	1.00	1.00	1.00	1.00	1.00	1.00	1.00	1.00	1.00	1.00
FinalVolume:	292	458	139	13	274	60	57	293	563	380	401	10
OvlAdjVol:	0						417					

Saturation Flow Module:	North Bound			South Bound			East Bound			West Bound		
Sat/Lane:	1600	1600	1600	1600	1600	1600	1600	1600	1600	1600	1600	1600
Adjustment:	1.00	1.06	1.00	1.00	1.04	1.00	1.00	1.06	1.00	1.00	1.03	1.00
Lanes:	2.00	1.00	1.00	1.00	1.64	0.36	1.00	1.00	1.00	1.00	1.95	0.05
Final Sat.:	3200	1700	1600	1600	2725	575	1600	1700	1600	1600	3222	78

Capacity Analysis Module:	North Bound			South Bound			East Bound			West Bound		
Vol/Sat:	0.09	0.27	0.09	0.01	0.10	0.10	0.04	0.17	0.35	0.24	0.12	0.13
OvlAdjV/S:	0.00						0.26					
Crit Moves:	****			****			****			****		

Santa Ana Circulation Element

Level Of Service Computation Report
 2000 HCM Operations Method (Base Volume Alternative)

 Intersection #72 Glassell St and SR-22 WB Ramps

Cycle (sec): 100 Critical Vol./Cap.(X): 0.841
 Loss Time (sec): 5 Average Delay (sec/veh): 30.1
 Optimal Cycle: 65 Level Of Service: C

Approach:	North Bound			South Bound			East Bound			West Bound		
Movement:	L	T	R	L	T	R	L	T	R	L	T	R
Control:	Protected			Permitted			Split Phase			Split Phase		
Rights:	Include			Include			Include			Include		
Min. Green:	0	0	0	0	0	0	0	0	0	0	0	0
Y+R:	4.0	4.0	4.0	4.0	4.0	4.0	4.0	4.0	4.0	4.0	4.0	4.0
Lanes:	1	0	2	0	0	2	0	0	0	1	0	1

Volume Module:

Base Vol:	568	638	0	0	1017	473	0	0	0	247	4	369
Growth Adj:	1.00	1.00	1.00	1.00	1.00	1.00	1.00	1.00	1.00	1.00	1.00	1.00
Initial Bse:	568	638	0	0	1017	473	0	0	0	247	4	369
User Adj:	1.00	1.00	1.00	1.00	1.00	1.00	1.00	1.00	1.00	1.00	1.00	1.00
PHF Adj:	1.00	1.00	1.00	1.00	1.00	1.00	1.00	1.00	1.00	1.00	1.00	1.00
PHF Volume:	568	638	0	0	1017	473	0	0	0	247	4	369
Reduct Vol:	0	0	0	0	0	0	0	0	0	0	0	0
Reduced Vol:	568	638	0	0	1017	473	0	0	0	247	4	369
PCE Adj:	1.00	1.00	1.00	1.00	1.00	1.00	1.00	1.00	1.00	1.00	1.00	1.00
MLF Adj:	1.00	1.00	1.00	1.00	1.00	1.00	1.00	1.00	1.00	1.00	1.00	1.00
Final Volume:	568	638	0	0	1017	473	0	0	0	247	4	369

Saturation Flow Module:

Sat/Lane:	1900	1900	1900	1900	1900	1900	1900	1900	1900	1900	1900	1900
Adjustment:	0.95	0.95	1.00	1.00	0.95	0.85	1.00	1.00	1.00	0.86	0.86	0.86
Lanes:	1.00	2.00	0.00	0.00	2.00	1.00	0.00	0.00	0.00	1.40	0.01	1.59
Final Sat.:	1805	3610	0	0	3610	1615	0	0	0	2271	21	2589

Capacity Analysis Module:

Vol/Sat:	0.31	0.18	0.00	0.00	0.28	0.29	0.00	0.00	0.00	0.11	0.19	0.14
Crit Moves:	****					****				****		
Green/Cycle:	0.37	0.72	0.00	0.00	0.35	0.35	0.00	0.00	0.00	0.23	0.23	0.23
Volume/Cap:	0.84	0.24	0.00	0.00	0.81	0.84	0.00	0.00	0.00	0.48	0.84	0.63
Delay/Veh:	37.9	4.7	0.0	0.0	33.6	41.0	0.0	0.0	0.0	33.7	45.5	36.0
User DelAdj:	1.00	1.00	1.00	1.00	1.00	1.00	1.00	1.00	1.00	1.00	1.00	1.00
AdjDel/Veh:	37.9	4.7	0.0	0.0	33.6	41.0	0.0	0.0	0.0	33.7	45.5	36.0
LOS by Move:	D	A	A	A	C	D	A	A	A	C	D	D
HCM2k85thQ:	27	5	0	0	25	24	0	0	0	8	18	11

 Note: Queue reported is the number of cars per lane.

Santa Ana Circulation Element

Level of Service Computation Report
 2000 HCM Operations Method (Base Volume Alternative)

 Intersection #73 Grand Ave / Glassell St and SR-22 EB Ramps

Cycle (sec): 100 Critical Vol./Cap.(X): 0.842
 Loss Time (sec): 5 Average Delay (sec/veh): 29.6
 Optimal Cycle: 65 Level of Service: C

Approach: Movement:	North Bound			South Bound			East Bound			West Bound					
	L	T	R	L	T	R	L	T	R	L	T	R			
Control:	Permitted			Protected			Split Phase			Split Phase					
Rights:	Include			Include			Include			Include					
Min. Green:	0	0	0	0	0	0	0	0	0	0	0	0			
Y+R:	4.0	4.0	4.0	4.0	4.0	4.0	4.0	4.0	4.0	4.0	4.0	4.0			
Lanes:	0	0	2	0	1	1	0	2	0	0	1	0	0	0	0

Volume Module:

Base Vol:	0	968	258	345	904	0	258	0	1012	0	0	0
Growth Adj:	1.00	1.00	1.00	1.00	1.00	1.00	1.00	1.00	1.00	1.00	1.00	1.00
Initial Bse:	0	968	258	345	904	0	258	0	1012	0	0	0
User Adj:	1.00	1.00	1.00	1.00	1.00	1.00	1.00	1.00	1.00	1.00	1.00	1.00
PHF Adj:	1.00	1.00	1.00	1.00	1.00	1.00	1.00	1.00	1.00	1.00	1.00	1.00
PHF Volume:	0	968	258	345	904	0	258	0	1012	0	0	0
Reduct Vol:	0	0	0	0	0	0	0	0	0	0	0	0
Reduced Vol:	0	968	258	345	904	0	258	0	1012	0	0	0
PCE Adj:	1.00	1.00	1.00	1.00	1.00	1.00	1.00	1.00	1.00	1.00	1.00	1.00
MLF Adj:	1.00	1.00	1.00	1.00	1.00	1.00	1.00	1.00	1.00	1.00	1.00	1.00
Final Volume:	0	968	258	345	904	0	258	0	1012	0	0	0

Saturation Flow Module:

Sat/Lane:	1900	1900	1900	1900	1900	1900	1900	1900	1900	1900	1900	1900
Adjustment:	1.00	0.95	0.85	0.95	0.95	1.00	0.87	1.00	0.87	1.00	1.00	1.00
Lanes:	0.00	2.00	1.00	1.00	2.00	0.00	1.20	0.00	1.80	0.00	0.00	0.00
Final Sat.:	0	3610	1615	1805	3610	0	1992	0	2974	0	0	0

Capacity Analysis Module:

Vol/Sat:	0.00	0.27	0.16	0.19	0.25	0.00	0.13	0.00	0.34	0.00	0.00	0.00
Crit Moves:	****			****			****			****		
Green/Cycle:	0.00	0.32	0.32	0.23	0.55	0.00	0.40	0.00	0.40	0.00	0.00	0.00
Volume/Cap:	0.00	0.84	0.50	0.84	0.46	0.00	0.32	0.00	0.84	0.00	0.00	0.00
Delay/Veh:	0.0	37.5	28.4	51.4	13.9	0.0	20.4	0.0	31.3	0.0	0.0	0.0
User DelAdj:	1.00	1.00	1.00	1.00	1.00	1.00	1.00	1.00	1.00	1.00	1.00	1.00
AdjDel/Veh:	0.0	37.5	28.4	51.4	13.9	0.0	20.4	0.0	31.3	0.0	0.0	0.0
LOS by Move:	A	D	C	D	B	A	C	A	C	A	A	A
HCM2k85thQ:	0	25	10	19	13	0	7	0	27	0	0	0

 Note: Queue reported is the number of cars per lane.

Santa Ana Circulation Element

Level of Service Computation Report

ICU 1(Loss as Cycle Length %) Method (Base Volume Alternative)

Intersection #74 Grand Ave and Fairhaven Ave

Cycle (sec): 100 Critical Vol./Cap.(X): 0.569
 Loss Time (sec): 5 Average Delay (sec/veh): xxxxxx
 Optimal Cycle: 27 Level of Service: A

Approach:	North Bound			South Bound			East Bound			West Bound		
Movement:	L	T	R	L	T	R	L	T	R	L	T	R
Control:	Protected			Protected			Permitted			Permitted		
Rights:	Include			Include			Include			Include		
Min. Green:	0	0	0	0	0	0	0	0	0	0	0	0
Y+R:	4.0	4.0	4.0	4.0	4.0	4.0	4.0	4.0	4.0	4.0	4.0	4.0
Lanes:	1	0	2	1	0	2	1	0	1	1	0	1

Volume Module:

Base Vol:	25	1032	148	184	1531	34	99	60	59	152	17	137
Growth Adj:	1.00	1.00	1.00	1.00	1.00	1.00	1.00	1.00	1.00	1.00	1.00	1.00
Initial Bse:	25	1032	148	184	1531	34	99	60	59	152	17	137
User Adj:	1.00	1.00	1.00	1.00	1.00	1.00	1.00	1.00	1.00	1.00	1.00	1.00
PHF Adj:	1.00	1.00	1.00	1.00	1.00	1.00	1.00	1.00	1.00	1.00	1.00	1.00
PHF Volume:	25	1032	148	184	1531	34	99	60	59	152	17	137
Reduct Vol:	0	0	0	0	0	0	0	0	0	0	0	0
Reduced Vol:	25	1032	148	184	1531	34	99	60	59	152	17	137
PCE Adj:	1.00	1.00	1.00	1.00	1.00	1.00	1.00	1.00	1.00	1.00	1.00	1.00
MLF Adj:	1.00	1.00	1.00	1.00	1.00	1.00	1.00	1.00	1.00	1.00	1.00	1.00
Final Volume:	25	1032	148	184	1531	34	99	60	59	152	17	137

Saturation Flow Module:

Sat/Lane:	1600	1600	1600	1600	1600	1600	1600	1600	1600	1600	1600	1600
Adjustment:	1.00	1.05	1.00	1.00	1.04	1.00	1.00	1.06	1.00	1.00	1.00	1.00
Lanes:	1.00	2.62	0.38	1.00	2.93	0.07	1.00	1.01	0.99	1.00	0.11	0.89
Final Sat.:	1600	4398	602	1600	4896	104	1600	1713	1587	1600	177	1423

Capacity Analysis Module:

Vol/Sat:	0.02	0.23	0.25	0.12	0.31	0.33	0.06	0.04	0.04	0.10	0.10	0.10
Crit Moves:			****	****			****			****		

Santa Ana Circulation Element

Level Of Service Computation Report

ICU 1(Loss as Cycle Length %) Method (Base Volume Alternative)

Intersection #75 Grand Ave and Santa Clara Ave

Cycle (sec): 100 Critical Vol./Cap.(X): 0.798
 Loss Time (sec): 5 Average Delay (sec/veh): xxxxxx
 Optimal Cycle: 52 Level Of Service: C

Approach:	North Bound			South Bound			East Bound			West Bound		
Movement:	L	T	R	L	T	R	L	T	R	L	T	R
Control:	Protected			Protected			Permitted			Permitted		
Rights:	Include			WideBypass			Include			Include		
Min. Green:	0	0	0	0	0	0	0	0	0	0	0	0
Y+R:	4.0	4.0	4.0	4.0	4.0	4.0	4.0	4.0	4.0	4.0	4.0	4.0
Lanes:	1	0	2	1	0	2	1	0	0	1	0	1

Volume Module:

Base Vol:	92	648	167	307	1503	338	179	291	60	140	270	246
Growth Adj:	1.00	1.00	1.00	1.00	1.00	1.00	1.00	1.00	1.00	1.00	1.00	1.00
Initial Bse:	92	648	167	307	1503	338	179	291	60	140	270	246
User Adj:	1.00	1.00	1.00	1.00	1.00	1.00	1.00	1.00	1.00	1.00	1.00	1.00
PHF Adj:	1.00	1.00	1.00	1.00	1.00	1.00	1.00	1.00	1.00	1.00	1.00	1.00
PHF Volume:	92	648	167	307	1503	338	179	291	60	140	270	246
Reduct Vol:	0	0	0	0	0	0	0	0	0	0	0	0
Reduced Vol:	92	648	167	307	1503	338	179	291	60	140	270	246
PCE Adj:	1.00	1.00	1.00	1.00	1.00	1.00	1.00	1.00	1.00	1.00	1.00	1.00
MLF Adj:	1.00	1.00	1.00	1.00	1.00	1.00	1.00	1.00	1.00	1.00	1.00	1.00
FinalVolume:	92	648	167	307	1503	338	179	291	60	140	270	246

Saturation Flow Module:

Sat/Lane:	1600	1600	1600	1600	1600	1600	1600	1600	1600	1600	1600	1600
Adjustment:	1.00	1.05	1.00	1.00	1.05	1.00	1.00	1.00	1.00	1.00	1.06	1.00
Lanes:	1.00	2.39	0.61	1.00	2.45	0.55	1.00	0.83	0.17	1.00	1.00	1.00
Final Sat.:	1600	4016	984	1600	4119	881	1600	1326	274	1600	1700	1600

Capacity Analysis Module:

Vol/Sat:	0.06	0.16	0.17	0.19	0.36	0.38	0.11	0.22	0.22	0.09	0.16	0.15
Crit Moves:	****					****	****			****		

Santa Ana Circulation Element

Level Of Service Computation Report

ICU 1(Loss as Cycle Length %) Method (Base Volume Alternative)

Intersection #76 Grand Ave and 17th St

Cycle (sec): 100 Critical Vol./Cap.(X): 0.856
 Loss Time (sec): 5 Average Delay (sec/veh): xxxxxx
 Optimal Cycle: 67 Level Of Service: D

Approach:	North Bound			South Bound			East Bound			West Bound		
Movement:	L	T	R	L	T	R	L	T	R	L	T	R
Control:	Protected			Protected			Protected			Protected		
Rights:	Include			Include			Include			Include		
Min. Green:	0	0	0	0	0	0	0	0	0	0	0	0
Y+R:	4.0	4.0	4.0	4.0	4.0	4.0	4.0	4.0	4.0	4.0	4.0	4.0
Lanes:	1	0	2	1	0	2	1	0	2	1	0	2

Volume Module:

Base Vol:	228	666	458	303	1270	249	246	915	116	401	1047	114
Growth Adj:	1.00	1.00	1.00	1.00	1.00	1.00	1.00	1.00	1.00	1.00	1.00	1.00
Initial Bse:	228	666	458	303	1270	249	246	915	116	401	1047	114
User Adj:	1.00	1.00	1.00	1.00	1.00	1.00	1.00	1.00	1.00	1.00	1.00	1.00
PHF Adj:	1.00	1.00	1.00	1.00	1.00	1.00	1.00	1.00	1.00	1.00	1.00	1.00
PHF Volume:	228	666	458	303	1270	249	246	915	116	401	1047	114
Reduct Vol:	0	0	0	0	0	0	0	0	0	0	0	0
Reduced Vol:	228	666	458	303	1270	249	246	915	116	401	1047	114
PCE Adj:	1.00	1.00	1.00	1.00	1.00	1.00	1.00	1.00	1.00	1.00	1.00	1.00
MLF Adj:	1.00	1.00	1.00	1.00	1.00	1.00	1.00	1.00	1.00	1.00	1.00	1.00
Final Volume:	228	666	458	303	1270	249	246	915	116	401	1047	114

Saturation Flow Module:

Sat/Lane:	1600	1600	1600	1600	1600	1600	1600	1600	1600	1600	1600	1600
Adjustment:	1.00	1.06	1.00	1.00	1.05	1.00	1.00	1.05	1.00	1.00	1.05	1.00
Lanes:	1.00	2.00	1.00	1.00	2.51	0.49	2.00	2.66	0.34	2.00	2.71	0.29
Final Sat.:	1600	3400	1600	1600	4213	787	3200	4460	540	3200	4529	471

Capacity Analysis Module:

Vol/Sat:	0.14	0.20	0.29	0.19	0.30	0.32	0.08	0.21	0.21	0.13	0.23	0.24
Crit Moves:			****	****			****			****		

Santa Ana Circulation Element

Level Of Service Computation Report
 2000 HCM Operations Method (Base Volume Alternative)

 Intersection #77 Grand Ave and I-5 NB Ramps

Cycle (sec): 100 Critical Vol./Cap.(X): 0.845
 Loss Time (sec): 5 Average Delay (sec/veh): 15.3
 Optimal Cycle: 66 Level Of Service: B

Approach:	North Bound			South Bound			East Bound			West Bound		
Movement:	L	T	R	L	T	R	L	T	R	L	T	R
Control:	Protected			Protected			Split Phase			Split Phase		
Rights:	Ignore			Include			Include			Include		
Min. Green:	0	0	0	0	0	0	0	0	0	0	0	0
Y+R:	4.0	4.0	4.0	4.0	4.0	4.0	4.0	4.0	4.0	4.0	4.0	4.0
Lanes:	0	0	2	0	1	1	0	0	3	0	0	0

Volume Module:

Base Vol:	0	1145	662	104	3338	0	0	0	0	557	0	154
Growth Adj:	1.00	1.00	1.00	1.00	1.00	1.00	1.00	1.00	1.00	1.00	1.00	1.00
Initial Bse:	0	1145	662	104	3338	0	0	0	0	557	0	154
User Adj:	1.00	1.00	0.00	1.00	1.00	1.00	1.00	1.00	1.00	1.00	1.00	1.00
PHF Adj:	1.00	1.00	0.00	1.00	1.00	1.00	1.00	1.00	1.00	1.00	1.00	1.00
PHF Volume:	0	1145	0	104	3338	0	0	0	0	557	0	154
Reduct Vol:	0	0	0	0	0	0	0	0	0	0	0	0
Reduced Vol:	0	1145	0	104	3338	0	0	0	0	557	0	154
PCE Adj:	1.00	1.00	0.00	1.00	1.00	1.00	1.00	1.00	1.00	1.00	1.00	1.00
MLF Adj:	1.00	1.00	0.00	1.00	1.00	1.00	1.00	1.00	1.00	1.00	1.00	1.00
FinalVolume:	0	1145	0	104	3338	0	0	0	0	557	0	154

Saturation Flow Module:

Sat/Lane:	1900	1900	1900	1900	1900	1900	1900	1900	1900	1900	1900	1900
Adjustment:	1.00	0.95	1.00	0.95	0.91	1.00	1.00	1.00	1.00	0.92	1.00	0.85
Lanes:	0.00	2.00	1.00	1.00	3.00	0.00	0.00	0.00	0.00	2.00	0.00	1.00
Final Sat.:	0	3610	1900	1805	5187	0	0	0	0	3502	0	1615

Capacity Analysis Module:

Vol/Sat:	0.00	0.32	0.00	0.06	0.64	0.00	0.00	0.00	0.00	0.16	0.00	0.10
Crit Moves:	****				****					****		
Green/Cycle:	0.00	0.64	0.00	0.12	0.76	0.00	0.00	0.00	0.00	0.19	0.00	0.19
Volume/Cap:	0.00	0.49	0.00	0.49	0.84	0.00	0.00	0.00	0.00	0.84	0.00	0.51
Delay/Veh:	0.0	9.4	0.0	43.2	9.8	0.0	0.0	0.0	0.0	49.0	0.0	37.8
User DelAdj:	1.00	1.00	1.00	1.00	1.00	1.00	1.00	1.00	1.00	1.00	1.00	1.00
AdjDel/Veh:	0.0	9.4	0.0	43.2	9.8	0.0	0.0	0.0	0.0	49.0	0.0	37.8
LOS by Move:	A	A	A	D	A	A	A	A	A	D	A	D
HCM2k85thQ:	0	15	0	6	39	0	0	0	0	17	0	7

Note: Queue reported is the number of cars per lane.

Santa Ana Circulation Element

Level Of Service Computation Report
 2000 HCM Operations Method (Base Volume Alternative)

 Intersection #78 Grand Ave and Santa Ana Blvd

Cycle (sec): 100 Critical Vol./Cap.(X): 0.881
 Loss Time (sec): 5 Average Delay (sec/veh): 26.3
 Optimal Cycle: 80 Level Of Service: C

Approach:	North Bound			South Bound			East Bound			West Bound		
Movement:	L	T	R	L	T	R	L	T	R	L	T	R
Control:	Protected			Protected			Split Phase			Split Phase		
Rights:	Include			Ovl			Include			Include		
Min. Green:	0	0	0	0	0	0	0	0	0	0	0	0
Y+R:	4.0	4.0	4.0	4.0	4.0	4.0	4.0	4.0	4.0	4.0	4.0	4.0
Lanes:	1	0	2	1	0	2	2	0	1	0	1	0

Volume Module:

Base Vol:	79	1119	57	231	1908	1684	242	200	394	5	407	37
Growth Adj:	1.00	1.00	1.00	1.00	1.00	1.00	1.00	1.00	1.00	1.00	1.00	1.00
Initial Bse:	79	1119	57	231	1908	1684	242	200	394	5	407	37
User Adj:	1.00	1.00	1.00	1.00	1.00	1.00	1.00	1.00	1.00	1.00	1.00	1.00
PHF Adj:	1.00	1.00	1.00	1.00	1.00	1.00	1.00	1.00	1.00	1.00	1.00	1.00
PHF Volume:	79	1119	57	231	1908	1684	242	200	394	5	407	37
Reduct Vol:	0	0	0	0	0	0	0	0	0	0	0	0
Reduced Vol:	79	1119	57	231	1908	1684	242	200	394	5	407	37
PCE Adj:	1.00	1.00	1.00	1.00	1.00	1.00	1.00	1.00	1.00	1.00	1.00	1.00
MLF Adj:	1.00	1.00	1.00	1.00	1.00	1.00	1.00	1.00	1.00	1.00	1.00	1.00
Final Volume:	79	1119	57	231	1908	1684	242	200	394	5	407	37

Saturation Flow Module:

Sat/Lane:	1900	1900	1900	1900	1900	1900	1900	1900	1900	1900	1900	1900
Adjustment:	0.95	0.90	0.90	0.95	0.95	0.75	0.92	1.00	0.75	0.94	0.94	0.94
Lanes:	1.00	2.85	0.15	1.00	2.00	2.00	2.00	1.00	2.00	0.02	1.82	0.16
Final Sat.:	1805	4901	250	1805	3610	2842	3502	1900	2842	40	3230	294

Capacity Analysis Module:

Vol/Sat:	0.04	0.23	0.23	0.13	0.53	0.59	0.07	0.11	0.14	0.13	0.13	0.13
Crit Moves:	****			****			****	****				
Green/Cycle:	0.05	0.42	0.42	0.23	0.60	0.76	0.16	0.16	0.16	0.14	0.14	0.14
Volume/Cap:	0.88	0.55	0.55	0.55	0.88	0.78	0.44	0.67	0.88	0.88	0.88	0.88
Delay/Veh:	105.1	22.4	22.4	35.2	21.6	9.2	38.7	45.4	59.3	58.3	58.3	58.3
User DelAdj:	1.00	1.00	1.00	1.00	1.00	1.00	1.00	1.00	1.00	1.00	1.00	1.00
AdjDel/Veh:	105.1	22.4	22.4	35.2	21.6	9.2	38.7	45.4	59.3	58.3	58.3	58.3
LOS by Move:	F	C	C	D	C	A	D	D	E	E	E	E
HCM2k85thQ:	7	15	15	10	41	28	6	11	15	15	15	15

 Note: Queue reported is the number of cars per lane.

Santa Ana Circulation Element

Level Of Service Computation Report

ICU 1(Loss as Cycle Length %) Method (Base Volume Alternative)

Intersection #79 Grand Ave and 1st St

Cycle (sec): 100 Critical Vol./Cap.(X): 0.827
 Loss Time (sec): 5 Average Delay (sec/veh): xxxxxx
 Optimal Cycle: 58 Level Of Service: D

Approach:	North Bound			South Bound			East Bound			West Bound		
Movement:	L	T	R	L	T	R	L	T	R	L	T	R
Control:	Protected			Protected			Protected			Protected		
Rights:	Include			Include			Include			Include		
Min. Green:	0	0	0	0	0	0	0	0	0	0	0	0
Y+R:	4.0	4.0	4.0	4.0	4.0	4.0	4.0	4.0	4.0	4.0	4.0	4.0
Lanes:	2	0	2	1	0	0	2	0	3	0	1	0

Volume Module:

Base Vol:	186	655	31	121	1753	213	318	760	216	268	939	107
Growth Adj:	1.00	1.00	1.00	1.00	1.00	1.00	1.00	1.00	1.00	1.00	1.00	1.00
Initial Bse:	186	655	31	121	1753	213	318	760	216	268	939	107
User Adj:	1.00	1.00	1.00	1.00	1.00	1.00	1.00	1.00	1.00	1.00	1.00	1.00
PHF Adj:	1.00	1.00	1.00	1.00	1.00	1.00	1.00	1.00	1.00	1.00	1.00	1.00
PHF Volume:	186	655	31	121	1753	213	318	760	216	268	939	107
Reduct Vol:	0	0	0	0	0	0	0	0	0	0	0	0
Reduced Vol:	186	655	31	121	1753	213	318	760	216	268	939	107
PCE Adj:	1.00	1.00	1.00	1.00	1.00	1.00	1.00	1.00	1.00	1.00	1.00	1.00
MLF Adj:	1.00	1.00	1.00	1.00	1.00	1.00	1.00	1.00	1.00	1.00	1.00	1.00
FinalVolume:	186	655	31	121	1753	213	318	760	216	268	939	107

Saturation Flow Module:

Sat/Lane:	1600	1600	1600	1600	1600	1600	1600	1600	1600	1600	1600	1600
Adjustment:	1.00	1.04	1.00	1.00	1.06	1.00	1.00	1.06	1.00	1.00	1.06	1.00
Lanes:	2.00	2.86	0.14	2.00	3.00	1.00	2.00	2.00	1.00	2.00	2.00	1.00
Final Sat.:	3200	4783	217	3200	5100	1600	3200	3400	1600	3200	3400	1600

Capacity Analysis Module:

Vol/Sat:	0.06	0.14	0.14	0.04	0.34	0.13	0.10	0.22	0.14	0.08	0.28	0.07
Crit Moves:	****			****			****			****		

Santa Ana Circulation Element

Level Of Service Computation Report

ICU 1(Loss as Cycle Length %) Method (Base Volume Alternative)

Intersection #80 Grand Ave and Chestnut Ave

Cycle (sec): 100 Critical Vol./Cap.(X): 0.935
 Loss Time (sec): 5 Average Delay (sec/veh): xxxxxx
 Optimal Cycle: 113 Level Of Service: E

Approach:	North Bound			South Bound			East Bound			West Bound		
Movement:	L	T	R	L	T	R	L	T	R	L	T	R
Control:	Protected			Protected			Permitted			Permitted		
Rights:	Include			Include			Include			Include		
Min. Green:	0	0	0	0	0	0	0	0	0	0	0	0
Y+R:	4.0	4.0	4.0	4.0	4.0	4.0	4.0	4.0	4.0	4.0	4.0	4.0
Lanes:	1	0	2	1	0	2	1	0	1	1	0	1

Volume Module:

Base Vol:	53	737	163	174	2086	57	64	449	118	81	237	148
Growth Adj:	1.00	1.00	1.00	1.00	1.00	1.00	1.00	1.00	1.00	1.00	1.00	1.00
Initial Bse:	53	737	163	174	2086	57	64	449	118	81	237	148
User Adj:	1.00	1.00	1.00	1.00	1.00	1.00	1.00	1.00	1.00	1.00	1.00	1.00
PHF Adj:	1.00	1.00	1.00	1.00	1.00	1.00	1.00	1.00	1.00	1.00	1.00	1.00
PHF Volume:	53	737	163	174	2086	57	64	449	118	81	237	148
Reduct Vol:	0	0	0	0	0	0	0	0	0	0	0	0
Reduced Vol:	53	737	163	174	2086	57	64	449	118	81	237	148
PCE Adj:	1.00	1.00	1.00	1.00	1.00	1.00	1.00	1.00	1.00	1.00	1.00	1.00
MLF Adj:	1.00	1.00	1.00	1.00	1.00	1.00	1.00	1.00	1.00	1.00	1.00	1.00
FinalVolume:	53	737	163	174	2086	57	64	449	118	81	237	148

Saturation Flow Module:

Sat/Lane:	1600	1600	1600	1600	1600	1600	1600	1600	1600	1600	1600	1600
Adjustment:	1.00	1.05	1.00	1.00	1.04	1.00	1.00	1.00	1.00	1.00	1.00	1.00
Lanes:	1.00	2.46	0.54	1.00	2.92	0.08	1.00	0.79	0.21	1.00	0.62	0.38
Final Sat.:	1600	4131	869	1600	4872	128	1600	1267	333	1600	985	615

Capacity Analysis Module:

Vol/Sat:	0.03	0.18	0.19	0.11	0.43	0.45	0.04	0.35	0.35	0.05	0.24	0.24
Crit Moves:	****				****	****	****			****		

Santa Ana Circulation Element

Level of Service Computation Report

ICU 1(Loss as Cycle Length %) Method (Base Volume Alternative)

Intersection #81 Grand Ave and McFadden Ave

Cycle (sec): 100 Critical Vol./Cap.(X): 1.011
 Loss Time (sec): 5 Average Delay (sec/veh): xxxxxx
 Optimal Cycle: 180 Level Of Service: F

Approach:	North Bound			South Bound			East Bound			West Bound		
Movement:	L	T	R	L	T	R	L	T	R	L	T	R
Control:	Protected			Protected			Protected			Protected		
Rights:	Include			Include			Include			Include		
Min. Green:	0	0	0	0	0	0	0	0	0	0	0	0
Y+R:	4.0	4.0	4.0	4.0	4.0	4.0	4.0	4.0	4.0	4.0	4.0	4.0
Lanes:	1	0	2	1	0	2	1	0	0	1	0	1

Volume Module:

Base Vol:	262	1104	165	294	1974	192	109	352	107	95	340	86
Growth Adj:	1.00	1.00	1.00	1.00	1.00	1.00	1.00	1.00	1.00	1.00	1.00	1.00
Initial Bse:	262	1104	165	294	1974	192	109	352	107	95	340	86
User Adj:	1.00	1.00	1.00	1.00	1.00	1.00	1.00	1.00	1.00	1.00	1.00	1.00
PHF Adj:	1.00	1.00	1.00	1.00	1.00	1.00	1.00	1.00	1.00	1.00	1.00	1.00
PHF Volume:	262	1104	165	294	1974	192	109	352	107	95	340	86
Reduct Vol:	0	0	0	0	0	0	0	0	0	0	0	0
Reduced Vol:	262	1104	165	294	1974	192	109	352	107	95	340	86
PCE Adj:	1.00	1.00	1.00	1.00	1.00	1.00	1.00	1.00	1.00	1.00	1.00	1.00
MLF Adj:	1.00	1.00	1.00	1.00	1.00	1.00	1.00	1.00	1.00	1.00	1.00	1.00
FinalVolume:	262	1104	165	294	1974	192	109	352	107	95	340	86

Saturation Flow Module:

Sat/Lane:	1600	1600	1600	1600	1600	1600	1600	1600	1600	1600	1600	1600
Adjustment:	1.00	1.05	1.00	1.00	1.05	1.00	1.00	1.00	1.00	1.00	1.04	1.00
Lanes:	1.00	2.61	0.39	1.00	2.73	0.27	1.00	0.77	0.23	1.00	1.60	0.40
Final Sat.:	1600	4376	624	1600	4575	425	1600	1227	373	1600	2654	646

Capacity Analysis Module:

Vol/Sat:	0.16	0.25	0.26	0.18	0.43	0.45	0.07	0.29	0.29	0.06	0.13	0.13
Crit Moves:	****				****	****	****			****		

Santa Ana Circulation Element

Level Of Service Computation Report

ICU 1(Loss as Cycle Length %) Method (Base Volume Alternative)

Intersection #82 Grand Ave and Edinger Ave

Cycle (sec): 100 Critical Vol./Cap.(X): 0.897
 Loss Time (sec): 5 Average Delay (sec/veh): xxxxxx
 Optimal Cycle: 85 Level Of Service: D

Approach:	North Bound			South Bound			East Bound			West Bound		
Movement:	L	T	R	L	T	R	L	T	R	L	T	R
Control:	Protected			Protected			Protected			Protected		
Rights:	Include			Include			Include			Include		
Min. Green:	0	0	0	0	0	0	0	0	0	0	0	0
Y+R:	4.0	4.0	4.0	4.0	4.0	4.0	4.0	4.0	4.0	4.0	4.0	4.0
Lanes:	1	0	2	1	0	2	1	0	2	1	0	2

Volume Module:

Base Vol:	65	649	127	253	1293	253	396	1654	159	170	651	142
Growth Adj:	1.00	1.00	1.00	1.00	1.00	1.00	1.00	1.00	1.00	1.00	1.00	1.00
Initial Bse:	65	649	127	253	1293	253	396	1654	159	170	651	142
User Adj:	1.00	1.00	1.00	1.00	1.00	1.00	1.00	1.00	1.00	1.00	1.00	1.00
PHF Adj:	1.00	1.00	1.00	1.00	1.00	1.00	1.00	1.00	1.00	1.00	1.00	1.00
PHF Volume:	65	649	127	253	1293	253	396	1654	159	170	651	142
Reduct Vol:	0	0	0	0	0	0	0	0	0	0	0	0
Reduced Vol:	65	649	127	253	1293	253	396	1654	159	170	651	142
PCE Adj:	1.00	1.00	1.00	1.00	1.00	1.00	1.00	1.00	1.00	1.00	1.00	1.00
MLF Adj:	1.00	1.00	1.00	1.00	1.00	1.00	1.00	1.00	1.00	1.00	1.00	1.00
FinalVolume:	65	649	127	253	1293	253	396	1654	159	170	651	142

Saturation Flow Module:

Sat/Lane:	1600	1600	1600	1600	1600	1600	1600	1600	1600	1600	1600	1600
Adjustment:	1.00	1.05	1.00	1.00	1.05	1.00	1.00	1.05	1.00	1.00	1.05	1.00
Lanes:	1.00	2.51	0.49	1.00	2.51	0.49	1.00	2.74	0.26	1.00	2.46	0.54
Final Sat.:	1600	4214	786	1600	4214	786	1600	4579	421	1600	4140	860

Capacity Analysis Module:

Vol/Sat:	0.04	0.15	0.16	0.16	0.31	0.32	0.25	0.36	0.38	0.11	0.16	0.17
Crit Moves:	****					****			****	****		

Santa Ana Circulation Element

Level Of Service Computation Report

ICU 1(Loss as Cycle Length %) Method (Base Volume Alternative)

Intersection #83 Grand Ave and Warner Ave

Cycle (sec): 100 Critical Vol./Cap.(X): 0.664
 Loss Time (sec): 5 Average Delay (sec/veh): xxxxxx
 Optimal Cycle: 34 Level Of Service: B

Approach:	North Bound			South Bound			East Bound			West Bound		
Movement:	L	T	R	L	T	R	L	T	R	L	T	R
Control:	Protected			Protected			Protected			Protected		
Rights:	Include			Include			Include			Include		
Min. Green:	0	0	0	0	0	0	0	0	0	0	0	0
Y+R:	4.0	4.0	4.0	4.0	4.0	4.0	4.0	4.0	4.0	4.0	4.0	4.0
Lanes:	1	0	2	1	0	2	2	0	3	2	0	2

Volume Module:

Base Vol:	187	564	241	204	589	199	314	1120	440	140	617	208
Growth Adj:	1.00	1.00	1.00	1.00	1.00	1.00	1.00	1.00	1.00	1.00	1.00	1.00
Initial Bse:	187	564	241	204	589	199	314	1120	440	140	617	208
User Adj:	1.00	1.00	1.00	1.00	1.00	1.00	1.00	1.00	1.00	1.00	1.00	1.00
PHF Adj:	1.00	1.00	1.00	1.00	1.00	1.00	1.00	1.00	1.00	1.00	1.00	1.00
PHF Volume:	187	564	241	204	589	199	314	1120	440	140	617	208
Reduct Vol:	0	0	0	0	0	0	0	0	0	0	0	0
Reduced Vol:	187	564	241	204	589	199	314	1120	440	140	617	208
PCE Adj:	1.00	1.00	1.00	1.00	1.00	1.00	1.00	1.00	1.00	1.00	1.00	1.00
MLF Adj:	1.00	1.00	1.00	1.00	1.00	1.00	1.00	1.00	1.00	1.00	1.00	1.00
FinalVolume:	187	564	241	204	589	199	314	1120	440	140	617	208

Saturation Flow Module:

Sat/Lane:	1600	1600	1600	1600	1600	1600	1600	1600	1600	1600	1600	1600
Adjustment:	1.00	1.06	1.00	1.00	1.06	1.00	1.00	1.06	1.00	1.00	1.06	1.00
Lanes:	1.00	2.10	0.90	1.00	2.24	0.76	2.00	3.00	1.00	2.00	2.24	0.76
Final Sat.:	1600	3563	1437	1600	3788	1212	3200	5100	1600	3200	3790	1210

Capacity Analysis Module:

Vol/Sat:	0.12	0.16	0.17	0.13	0.16	0.16	0.10	0.22	0.28	0.04	0.16	0.17
Crit Moves:			****	****					****	****		

Santa Ana Circulation Element

Level Of Service Computation Report
 2000 HCM Operations Method (Base Volume Alternative)

 Intersection #84 SR-55 NB Ramps and Dyer Rd

Cycle (sec): 100 Critical Vol./Cap.(X): 0.565
 Loss Time (sec): 5 Average Delay (sec/veh): 17.3
 Optimal Cycle: 28 Level Of Service: B

Approach:	North Bound			South Bound			East Bound			West Bound		
Movement:	L	T	R	L	T	R	L	T	R	L	T	R
Control:	Split Phase			Split Phase			Protected			Protected		
Rights:	Include			Include			Ignore			Ignore		
Min. Green:	0	0	0	0	0	0	0	0	0	0	0	0
Y+R:	4.0	4.0	4.0	4.0	4.0	4.0	4.0	4.0	4.0	4.0	4.0	4.0
Lanes:	1	0	1	0	0	1	0	0	3	0	1	0

Volume Module:

Base Vol:	637	0	521	0	0	0	0	1550	620	0	859	517
Growth Adj:	1.00	1.00	1.00	1.00	1.00	1.00	1.00	1.00	1.00	1.00	1.00	1.00
Initial Bse:	637	0	521	0	0	0	0	1550	620	0	859	517
User Adj:	1.00	1.00	1.00	1.00	1.00	1.00	1.00	1.00	0.00	1.00	1.00	0.00
PHF Adj:	1.00	1.00	1.00	1.00	1.00	1.00	1.00	1.00	0.00	1.00	1.00	0.00
PHF Volume:	637	0	521	0	0	0	0	1550	0	0	859	0
Reduct Vol:	0	0	0	0	0	0	0	0	0	0	0	0
Reduced Vol:	637	0	521	0	0	0	0	1550	0	0	859	0
PCE Adj:	1.00	1.00	1.00	1.00	1.00	1.00	1.00	1.00	0.00	1.00	1.00	0.00
MLF Adj:	1.00	1.00	1.00	1.00	1.00	1.00	1.00	1.00	0.00	1.00	1.00	0.00
Final Volume:	637	0	521	0	0	0	0	1550	0	0	859	0

Saturation Flow Module:

Sat/Lane:	1900	1900	1900	1900	1900	1900	1900	1900	1900	1900	1900	1900
Adjustment:	0.91	1.00	0.91	1.00	1.00	1.00	1.00	0.91	1.00	1.00	0.91	0.91
Lanes:	1.55	0.00	1.45	0.00	0.00	0.00	0.00	3.00	1.00	0.00	3.00	0.00
Final Sat.:	2674	0	2501	0	0	0	0	5187	1900	0	5187	0

Capacity Analysis Module:

Vol/Sat:	0.24	0.00	0.21	0.00	0.00	0.00	0.00	0.30	0.00	0.00	0.17	0.00
Crit Moves:	****						****			****		
Green/Cycle:	0.42	0.00	0.42	0.00	0.00	0.00	0.00	0.53	0.00	0.00	0.53	0.00
Volume/Cap:	0.57	0.00	0.49	0.00	0.00	0.00	0.00	0.57	0.00	0.00	0.31	0.00
Delay/Veh:	22.3	0.0	21.3	0.0	0.0	0.0	0.0	16.1	0.0	0.0	13.4	0.0
User DelAdj:	1.00	1.00	1.00	1.00	1.00	1.00	1.00	1.00	1.00	1.00	1.00	1.00
AdjDel/Veh:	22.3	0.0	21.3	0.0	0.0	0.0	0.0	16.1	0.0	0.0	13.4	0.0
LOS by Move:	C	A	C	A	A	A	A	B	A	A	B	A
HCM2k85thQ:	15	0	13	0	0	0	0	18	0	0	8	0

 Note: Queue reported is the number of cars per lane.

Santa Ana Circulation Element

Level Of Service Computation Report
 2000 HCM 4-Way Stop Method (Base Volume Alternative)

 Intersection #85 Cambridge St and La Veta Ave

Cycle (sec): 100 Critical Vol./Cap.(X): 0.900
 Loss Time (sec): 5 Average Delay (sec/veh): 23.4
 Optimal Cycle: 0 Level Of Service: C

Approach:	North Bound			South Bound			East Bound			West Bound		
Movement:	L	T	R	L	T	R	L	T	R	L	T	R
Control:	Stop Sign			Stop Sign			Stop Sign			Stop Sign		
Rights:	Include			Include			Include			Include		
Min. Green:	0	0	0	0	0	0	0	0	0	0	0	0
Lanes:	1	0	1	0	0	1	1	0	0	0	0	0

Volume Module:

Base Vol:	185	235	0	0	480	245	195	0	312	0	0	0
Growth Adj:	1.00	1.00	1.00	1.00	1.00	1.00	1.00	1.00	1.00	1.00	1.00	1.00
Initial Bse:	185	235	0	0	480	245	195	0	312	0	0	0
User Adj:	1.00	1.00	1.00	1.00	1.00	1.00	1.00	1.00	1.00	1.00	1.00	1.00
PHF Adj:	1.00	1.00	1.00	1.00	1.00	1.00	1.00	1.00	1.00	1.00	1.00	1.00
PHF Volume:	185	235	0	0	480	245	195	0	312	0	0	0
Reduct Vol:	0	0	0	0	0	0	0	0	0	0	0	0
Reduced Vol:	185	235	0	0	480	245	195	0	312	0	0	0
PCE Adj:	1.00	1.00	1.00	1.00	1.00	1.00	1.00	1.00	1.00	1.00	1.00	1.00
MLF Adj:	1.00	1.00	1.00	1.00	1.00	1.00	1.00	1.00	1.00	1.00	1.00	1.00
FinalVolume:	185	235	0	0	480	245	195	0	312	0	0	0

Saturation Flow Module:

Adjustment:	1.00	1.00	1.00	1.00	1.00	1.00	1.00	1.00	1.00	1.00	1.00	1.00
Lanes:	1.00	1.00	0.00	0.00	1.00	1.00	1.00	0.00	1.00	0.00	0.00	0.00
Final Sat.:	465	498	0	0	534	586	459	0	541	0	0	0

Capacity Analysis Module:

Vol/Sat:	0.40	0.47	xxxx	xxxx	0.90	0.42	0.43	xxxx	0.58	xxxx	xxxx	xxxx
Crit Moves:	****			****			****			****		
Delay/Veh:	15.0	15.6	0.0	0.0	42.9	12.8	15.7	0.0	17.1	0.0	0.0	0.0
Delay Adj:	1.00	1.00	1.00	1.00	1.00	1.00	1.00	1.00	1.00	1.00	1.00	1.00
AdjDel/Veh:	15.0	15.6	0.0	0.0	42.9	12.8	15.7	0.0	17.1	0.0	0.0	0.0
LOS by Move:	B	C	*	*	E	B	C	*	C	*	*	*
ApproachDel:	15.3			32.8			16.6			xxxxxxx		
Delay Adj:	1.00			1.00			1.00			xxxxxxx		
ApprAdjDel:	15.3			32.8			16.6			xxxxxxx		
LOS by Appr:	C			D			C			*		
AllWayAvgQ:	0.6	0.8	0.0	0.0	5.0	0.7	0.7	0.0	1.2	0.0	0.0	0.0

 Note: Queue reported is the number of cars per lane.

Santa Ana Circulation Element

Level Of Service Computation Report

ICU 1(Loss as Cycle Length %) Method (Base Volume Alternative)

 Intersection #86 Cambridge St and Fairhaven Ave

Cycle (sec): 100 Critical Vol./Cap.(X): 0.624
 Loss Time (sec): 5 Average Delay (sec/veh): xxxxxx
 Optimal Cycle: 30 Level Of Service: B

Approach:	North Bound			South Bound			East Bound			West Bound		
Movement:	L	T	R	L	T	R	L	T	R	L	T	R
Control:	Permitted			Permitted			Permitted			Permitted		
Rights:	Include			Include			Include			Include		
Min. Green:	0	0	0	0	0	0	0	0	0	0	0	0
Y+R:	4.0	4.0	4.0	4.0	4.0	4.0	4.0	4.0	4.0	4.0	4.0	4.0
Lanes:	0	0	0	1	0	0	1	0	1	0	0	1

Volume Module:

Base Vol:	0	0	0	618	0	199	69	185	0	0	130	101
Growth Adj:	1.00	1.00	1.00	1.00	1.00	1.00	1.00	1.00	1.00	1.00	1.00	1.00
Initial Bse:	0	0	0	618	0	199	69	185	0	0	130	101
User Adj:	1.00	1.00	1.00	1.00	1.00	1.00	1.00	1.00	1.00	1.00	1.00	1.00
PHF Adj:	1.00	1.00	1.00	1.00	1.00	1.00	1.00	1.00	1.00	1.00	1.00	1.00
PHF Volume:	0	0	0	618	0	199	69	185	0	0	130	101
Reduct Vol:	0	0	0	0	0	0	0	0	0	0	0	0
Reduced Vol:	0	0	0	618	0	199	69	185	0	0	130	101
PCE Adj:	1.00	1.00	1.00	1.00	1.00	1.00	1.00	1.00	1.00	1.00	1.00	1.00
MLF Adj:	1.00	1.00	1.00	1.00	1.00	1.00	1.00	1.00	1.00	1.00	1.00	1.00
FinalVolume:	0	0	0	618	0	199	69	185	0	0	130	101

Saturation Flow Module:

Sat/Lane:	1600	1600	1600	1600	1600	1600	1600	1600	1600	1600	1600	1600
Adjustment:	1.00	1.06	1.00	1.00	1.06	1.00	1.00	1.06	1.00	1.00	1.00	1.00
Lanes:	0.00	0.00	0.00	1.00	0.00	1.00	1.00	1.00	0.00	0.00	0.56	0.44
Final Sat.:	0	0	0	1600	0	1600	1600	1700	0	0	900	700

Capacity Analysis Module:

Vol/Sat:	0.00	0.00	0.00	0.39	0.00	0.12	0.04	0.11	0.00	0.00	0.14	0.14
Crit Moves:				****			****			****		

Santa Ana Circulation Element

Level of Service Computation Report
 2000 HCM Operations Method (Base Volume Alternative)

 Intersection #87 Mabury St and 1st Street

Cycle (sec): 100 Critical Vol./Cap.(X): 0.755
 Loss Time (sec): 5 Average Delay (sec/veh): 27.4
 Optimal Cycle: 46 Level of Service: C

Street Name:	Mabury						1st Street					
Approach:	North Bound			South Bound			East Bound			West Bound		
Movement:	L	T	R	L	T	R	L	T	R	L	T	R
Control:	Split Phase			Split Phase			Protected			Protected		
Rights:	Include			Include			Include			Include		
Min. Green:	0	0	0	0	0	0	0	0	0	0	0	0
Y+R:	4.0	4.0	4.0	4.0	4.0	4.0	4.0	4.0	4.0	4.0	4.0	4.0
Lanes:	1	0	0	0	1	0	0	0	1	1	0	1

Volume Module:

Base Vol:	5	0	122	276	164	618	0	922	10	46	701	0
Growth Adj:	1.00	1.00	1.00	1.00	1.00	1.00	1.00	1.00	1.00	1.00	1.00	1.00
Initial Bse:	5	0	122	276	164	618	0	922	10	46	701	0
User Adj:	1.00	1.00	1.00	1.00	1.00	1.00	1.00	1.00	1.00	1.00	1.00	1.00
PHF Adj:	1.00	1.00	1.00	1.00	1.00	1.00	1.00	1.00	1.00	1.00	1.00	1.00
PHF Volume:	5	0	122	276	164	618	0	922	10	46	701	0
Reduct Vol:	0	0	0	0	0	0	0	0	0	0	0	0
Reduced Vol:	5	0	122	276	164	618	0	922	10	46	701	0
PCE Adj:	1.00	1.00	1.00	1.00	1.00	1.00	1.00	1.00	1.00	1.00	1.00	1.00
MLF Adj:	1.00	1.00	1.00	1.00	1.00	1.00	1.00	1.00	1.00	1.00	1.00	1.00
FinalVolume:	5	0	122	276	164	618	0	922	10	46	701	0

Saturation Flow Module:

Sat/Lane:	1900	1900	1900	1900	1900	1900	1900	1900	1900	1900	1900	1900
Adjustment:	0.95	1.00	0.85	0.90	0.90	0.90	1.00	0.95	0.95	0.95	0.95	0.95
Lanes:	1.00	0.00	1.00	1.23	0.27	1.50	0.00	1.98	0.02	1.00	2.00	0.00
Final Sat.:	1805	0	1615	2097	459	2575	0	3564	39	1805	3610	0

Capacity Analysis Module:

Vol/Sat:	0.00	0.00	0.08	0.13	0.36	0.24	0.00	0.26	0.26	0.03	0.19	0.00
Crit Moves:			****		****			****		****		
Green/Cycle:	0.10	0.00	0.10	0.47	0.47	0.47	0.00	0.34	0.34	0.03	0.38	0.00
Volume/Cap:	0.03	0.00	0.75	0.28	0.75	0.51	0.00	0.75	0.75	0.75	0.52	0.00
Delay/Veh:	40.7	0.0	61.9	16.0	24.0	18.5	0.0	31.8	31.8	88.8	24.5	0.0
User DelAdj:	1.00	1.00	1.00	1.00	1.00	1.00	1.00	1.00	1.00	1.00	1.00	1.00
AdjDel/Veh:	40.7	0.0	61.9	16.0	24.0	18.5	0.0	31.8	31.8	88.8	24.5	0.0
LOS by Move:	D	A	E	B	C	B	A	C	C	F	C	A
HCM2k85thQ:	0	0	8	7	25	14	0	22	22	5	14	0

Note: Queue reported is the number of cars per lane.

Santa Ana Circulation Element

Level of Service Computation Report

ICU 1(Loss as Cycle Length %) Method (Base Volume Alternative)

 Intersection #88 Tustin St and La Veta Ave

Cycle (sec): 100 Critical Vol./Cap.(X): 0.362
 Loss Time (sec): 5 Average Delay (sec/veh): xxxxxx
 Optimal Cycle: 19 Level Of Service: A

Approach:	North Bound			South Bound			East Bound			West Bound		
Movement:	L	T	R	L	T	R	L	T	R	L	T	R
Control:	Protected			Protected			Split Phase			Split Phase		
Rights:	Include			Include			Include			Ovl		
Min. Green:	0	0	0	0	0	0	0	0	0	0	0	0
Y+R:	4.0	4.0	4.0	4.0	4.0	4.0	4.0	4.0	4.0	4.0	4.0	4.0
Lanes:	1	0	2	1	0	2	1	0	1	1	0	0

Volume Module:

Base Vol:	9	365	105	48	944	3	9	11	35	279	1	43
Growth Adj:	1.00	1.00	1.00	1.00	1.00	1.00	1.00	1.00	1.00	1.00	1.00	1.00
Initial Bse:	9	365	105	48	944	3	9	11	35	279	1	43
User Adj:	1.00	1.00	1.00	1.00	1.00	1.00	1.00	1.00	1.00	1.00	1.00	1.00
PHF Adj:	1.00	1.00	1.00	1.00	1.00	1.00	1.00	1.00	1.00	1.00	1.00	1.00
PHF Volume:	9	365	105	48	944	3	9	11	35	279	1	43
Reduct Vol:	0	0	0	0	0	0	0	0	0	0	0	0
Reduced Vol:	9	365	105	48	944	3	9	11	35	279	1	43
PCE Adj:	1.00	1.00	1.00	1.00	1.00	1.00	1.00	1.00	1.00	1.00	1.00	1.00
MLF Adj:	1.00	1.00	1.00	1.00	1.00	1.00	1.00	1.00	1.00	1.00	1.00	1.00
FinalVolume:	9	365	105	48	944	3	9	11	35	279	1	43
OvlAdjVol:												0

Saturation Flow Module:

Sat/Lane:	1600	1600	1600	1600	1600	1600	1600	1600	1600	1600	1600	1600
Adjustment:	1.00	1.05	1.00	1.00	1.04	1.00	1.00	1.06	1.00	1.00	1.00	1.00
Lanes:	1.00	2.33	0.67	1.00	2.99	0.01	1.00	1.00	1.00	1.99	0.01	1.00
Final Sat.:	1600	3928	1072	1600	4985	15	1600	1700	1600	3189	11	1600

Capacity Analysis Module:

Vol/Sat:	0.01	0.09	0.10	0.03	0.19	0.20	0.01	0.01	0.02	0.09	0.09	0.03
OvlAdjV/S:												0.00
Crit Moves:	****				****			****			****	

Santa Ana Circulation Element

Level Of Service Computation Report

2000 HCM Operations Method (Base Volume Alternative)

Intersection #89 Tustin St and SR-22 WB On-Ramp

Cycle (sec): 100 Critical Vol./Cap.(X): 0.575
 Loss Time (sec): 5 Average Delay (sec/veh): 13.2
 Optimal Cycle: 29 Level Of Service: B

Approach:	North Bound			South Bound			East Bound			West Bound		
Movement:	L	T	R	L	T	R	L	T	R	L	T	R
Control:	Protected			Permitted			Protected			Protected		
Rights:	Include			Include			Include			Include		
Min. Green:	0	0	0	0	0	0	0	0	0	0	0	0
Y+R:	4.0	4.0	4.0	4.0	4.0	4.0	4.0	4.0	4.0	4.0	4.0	4.0
Lanes:	2	0	2	0	0	2	1	0	0	0	0	0

Volume Module:

Base Vol:	762	708	0	0	897	536	0	0	0	0	0	0
Growth Adj:	1.00	1.00	1.00	1.00	1.00	1.00	1.00	1.00	1.00	1.00	1.00	1.00
Initial Bse:	762	708	0	0	897	536	0	0	0	0	0	0
User Adj:	1.00	1.00	1.00	1.00	1.00	1.00	1.00	1.00	1.00	1.00	1.00	1.00
PHF Adj:	1.00	1.00	1.00	1.00	1.00	1.00	1.00	1.00	1.00	1.00	1.00	1.00
PHF Volume:	762	708	0	0	897	536	0	0	0	0	0	0
Reduct Vol:	0	0	0	0	0	0	0	0	0	0	0	0
Reduced Vol:	762	708	0	0	897	536	0	0	0	0	0	0
PCE Adj:	1.00	1.00	1.00	1.00	1.00	1.00	1.00	1.00	1.00	1.00	1.00	1.00
MLF Adj:	1.00	1.00	1.00	1.00	1.00	1.00	1.00	1.00	1.00	1.00	1.00	1.00
Final Volume:	762	708	0	0	897	536	0	0	0	0	0	0

Saturation Flow Module:

Sat/Lane:	1900	1900	1900	1900	1900	1900	1900	1900	1900	1900	1900	1900
Adjustment:	0.92	0.95	1.00	1.00	0.86	0.86	1.00	1.00	1.00	1.00	1.00	1.00
Lanes:	2.00	2.00	0.00	0.00	2.00	1.00	0.00	0.00	0.00	0.00	0.00	0.00
Final Sat.:	3502	3610	0	0	3264	1632	0	0	0	0	0	0

Capacity Analysis Module:

Vol/Sat:	0.22	0.20	0.00	0.00	0.27	0.33	0.00	0.00	0.00	0.00	0.00	0.00
Crit Moves:	****			****								
Green/Cycle:	0.38	0.95	0.00	0.00	0.57	0.57	0.00	0.00	0.00	0.00	0.00	0.00
Volume/Cap:	0.57	0.21	0.00	0.00	0.48	0.57	0.00	0.00	0.00	0.00	0.00	0.00
Delay/Veh:	25.3	0.2	0.0	0.0	12.8	14.0	0.0	0.0	0.0	0.0	0.0	0.0
User DelAdj:	1.00	1.00	1.00	1.00	1.00	1.00	1.00	1.00	1.00	1.00	1.00	1.00
AdjDel/Veh:	25.3	0.2	0.0	0.0	12.8	14.0	0.0	0.0	0.0	0.0	0.0	0.0
LOS by Move:	C	A	A	A	B	B	A	A	A	A	A	A
HCM2k85thQ:	15	1	0	0	14	18	0	0	0	0	0	0

Note: Queue reported is the number of cars per lane.

Santa Ana Circulation Element

Level Of Service Computation Report

2000 HCM Operations Method (Base Volume Alternative)

 Intersection #90 Tustin St and SR-22 EB Off-Ramp / Seba Ave

Cycle (sec): 100 Critical Vol./Cap.(X): 0.718
 Loss Time (sec): 5 Average Delay (sec/veh): 23.8
 Optimal Cycle: 41 Level Of Service: C

Approach:	North Bound			South Bound			East Bound			West Bound		
Movement:	L	T	R	L	T	R	L	T	R	L	T	R
Control:	Permitted			Permitted			Split Phase			Split Phase		
Rights:	Include			Include			Include			Include		
Min. Green:	0	0	0	0	0	0	0	0	0	0	0	0
Y+R:	4.0	4.0	4.0	4.0	4.0	4.0	4.0	4.0	4.0	4.0	4.0	4.0
Lanes:	0	0	2	1	0	3	0	1	0	1	0	0

Volume Module:	North Bound			South Bound			East Bound			West Bound		
Base Vol:	0	1213	6	13	779	0	252	25	1084	6	0	43
Growth Adj:	1.00	1.00	1.00	1.00	1.00	1.00	1.00	1.00	1.00	1.00	1.00	1.00
Initial Bse:	0	1213	6	13	779	0	252	25	1084	6	0	43
User Adj:	1.00	1.00	1.00	1.00	1.00	1.00	1.00	1.00	1.00	1.00	1.00	1.00
PHF Adj:	1.00	1.00	1.00	1.00	1.00	1.00	1.00	1.00	1.00	1.00	1.00	1.00
PHF Volume:	0	1213	6	13	779	0	252	25	1084	6	0	43
Reduct Vol:	0	0	0	0	0	0	0	0	0	0	0	0
Reduced Vol:	0	1213	6	13	779	0	252	25	1084	6	0	43
PCE Adj:	1.00	1.00	1.00	1.00	1.00	1.00	1.00	1.00	1.00	1.00	1.00	1.00
MLF Adj:	1.00	1.00	1.00	1.00	1.00	1.00	1.00	1.00	1.00	1.00	1.00	1.00
FinalVolume:	0	1213	6	13	779	0	252	25	1084	6	0	43

Saturation Flow Module:	North Bound			South Bound			East Bound			West Bound		
Sat/Lane:	1900	1900	1900	1900	1900	1900	1900	1900	1900	1900	1900	1900
Adjustment:	1.00	0.91	0.91	0.12	0.91	1.00	0.87	0.87	0.87	0.88	1.00	0.88
Lanes:	0.00	2.99	0.01	1.00	3.00	0.00	1.18	0.04	1.78	0.12	0.00	0.88
Final Sat.:	0	5156	26	232	5187	0	1960	60	2956	204	0	1460

Capacity Analysis Module:	North Bound			South Bound			East Bound			West Bound		
Vol/Sat:	0.00	0.24	0.24	0.06	0.15	0.00	0.13	0.42	0.37	0.03	0.00	0.03
Crit Moves:	****						****			****		
Green/Cycle:	0.00	0.33	0.33	0.33	0.33	0.00	0.58	0.58	0.58	0.04	0.00	0.04
Volume/Cap:	0.00	0.72	0.72	0.17	0.46	0.00	0.22	0.72	0.63	0.72	0.00	0.72
Delay/Veh:	0.0	31.1	31.1	25.0	26.8	0.0	10.1	16.4	14.4	78.0	0.0	78.0
User DelAdj:	1.00	1.00	1.00	1.00	1.00	1.00	1.00	1.00	1.00	1.00	1.00	1.00
AdjDel/Veh:	0.0	31.1	31.1	25.0	26.8	0.0	10.1	16.4	14.4	78.0	0.0	78.0
LOS by Move:	A	C	C	C	C	A	B	B	B	E	A	E
HCM2k85thQ:	0	20	20	1	11	0	5	24	19	5	0	5

 Note: Queue reported is the number of cars per lane.

Santa Ana Circulation Element

Level Of Service Computation Report

ICU 1(Loss as Cycle Length %) Method (Base Volume Alternative)

Intersection #91 Tustin Ave and Fairhaven Ave

Cycle (sec): 100 Critical Vol./Cap.(X): 1.242
 Loss Time (sec): 5 Average Delay (sec/veh): xxxxxx
 Optimal Cycle: 180 Level Of Service: F

Approach:	North Bound			South Bound			East Bound			West Bound		
Movement:	L	T	R	L	T	R	L	T	R	L	T	R
Control:	Protected			Protected			Protected			Protected		
Rights:	Include			Include			Include			Include		
Min. Green:	0	0	0	0	0	0	0	0	0	0	0	0
Y+R:	4.0	4.0	4.0	4.0	4.0	4.0	4.0	4.0	4.0	4.0	4.0	4.0
Lanes:	2	0	2	1	0	0	2	0	2	1	0	0

Volume Module:	North Bound			South Bound			East Bound			West Bound		
Base Vol:	125	720	126	249	2148	42	78	297	511	306	338	442
Growth Adj:	1.00	1.00	1.00	1.00	1.00	1.00	1.00	1.00	1.00	1.00	1.00	1.00
Initial Bse:	125	720	126	249	2148	42	78	297	511	306	338	442
User Adj:	1.00	1.00	1.00	1.00	1.00	1.00	1.00	1.00	1.00	1.00	1.00	1.00
PHF Adj:	1.00	1.00	1.00	1.00	1.00	1.00	1.00	1.00	1.00	1.00	1.00	1.00
PHF Volume:	125	720	126	249	2148	42	78	297	511	306	338	442
Reduct Vol:	0	0	0	0	0	0	0	0	0	0	0	0
Reduced Vol:	125	720	126	249	2148	42	78	297	511	306	338	442
PCE Adj:	1.00	1.00	1.00	1.00	1.00	1.00	1.00	1.00	1.00	1.00	1.00	1.00
MLF Adj:	1.00	1.00	1.00	1.00	1.00	1.00	1.00	1.00	1.00	1.00	1.00	1.00
FinalVolume:	125	720	126	249	2148	42	78	297	511	306	338	442

Saturation Flow Module:	North Bound			South Bound			East Bound			West Bound		
Sat/Lane:	1600	1600	1600	1600	1600	1600	1600	1600	1600	1600	1600	1600
Adjustment:	1.00	1.05	1.00	1.00	1.04	1.00	1.00	1.00	1.00	1.00	1.00	1.00
Lanes:	2.00	2.55	0.45	2.00	2.94	0.06	1.00	0.37	0.63	1.00	0.43	0.57
Final Sat.:	3200	4285	715	3200	4908	92	1600	588	1012	1600	693	907

Capacity Analysis Module:	North Bound			South Bound			East Bound			West Bound		
Vol/Sat:	0.04	0.17	0.18	0.08	0.44	0.46	0.05	0.51	0.50	0.19	0.49	0.49
Crit Moves:	****				****			****		****		

Santa Ana Circulation Element

Level Of Service Computation Report

ICU 1(Loss as Cycle Length %) Method (Base Volume Alternative)

Intersection #92 Tustin Ave and Santa Clara Ave

Cycle (sec): 100 Critical Vol./Cap.(X): 1.097
 Loss Time (sec): 5 Average Delay (sec/veh): xxxxxx
 Optimal Cycle: 180 Level Of Service: F

Approach:	North Bound			South Bound			East Bound			West Bound		
Movement:	L	T	R	L	T	R	L	T	R	L	T	R
Control:	Protected			Protected			Permitted			Permitted		
Rights:	Include			Include			Include			Include		
Min. Green:	0	0	0	0	0	0	0	0	0	0	0	0
Y+R:	4.0	4.0	4.0	4.0	4.0	4.0	4.0	4.0	4.0	4.0	4.0	4.0
Lanes:	1	0	2	1	0	2	1	0	2	1	0	2

Volume Module:

Base Vol:	102	556	104	135	2756	87	116	293	214	118	244	122
Growth Adj:	1.00	1.00	1.00	1.00	1.00	1.00	1.00	1.00	1.00	1.00	1.00	1.00
Initial Bse:	102	556	104	135	2756	87	116	293	214	118	244	122
User Adj:	1.00	1.00	1.00	1.00	1.00	1.00	1.00	1.00	1.00	1.00	1.00	1.00
PHF Adj:	1.00	1.00	1.00	1.00	1.00	1.00	1.00	1.00	1.00	1.00	1.00	1.00
PHF Volume:	102	556	104	135	2756	87	116	293	214	118	244	122
Reduct Vol:	0	0	0	0	0	0	0	0	0	0	0	0
Reduced Vol:	102	556	104	135	2756	87	116	293	214	118	244	122
PCE Adj:	1.00	1.00	1.00	1.00	1.00	1.00	1.00	1.00	1.00	1.00	1.00	1.00
MLF Adj:	1.00	1.00	1.00	1.00	1.00	1.00	1.00	1.00	1.00	1.00	1.00	1.00
FinalVolume:	102	556	104	135	2756	87	116	293	214	118	244	122

Saturation Flow Module:

Sat/Lane:	1600	1600	1600	1600	1600	1600	1600	1600	1600	1600	1600	1600
Adjustment:	1.00	1.05	1.00	1.00	1.04	1.00	1.00	1.00	1.00	1.00	1.00	1.00
Lanes:	1.00	2.53	0.47	2.00	2.91	0.09	1.00	0.58	0.42	1.00	0.67	0.33
Final Sat.:	1600	4244	756	3200	4853	147	1600	925	675	1600	1067	533

Capacity Analysis Module:

Vol/Sat:	0.06	0.13	0.14	0.04	0.57	0.59	0.07	0.32	0.32	0.07	0.23	0.23
Crit Moves:	****					****	****			****		

Santa Ana Circulation Element

Level Of Service Computation Report

ICU 1(Loss as Cycle Length %) Method (Base Volume Alternative)

 Intersection #93 Tustin Ave and 17th St

Cycle (sec): 100 Critical Vol./Cap.(X): 0.805
 Loss Time (sec): 5 Average Delay (sec/veh): xxxxxx
 Optimal Cycle: 53 Level Of Service: D

Approach:	North Bound			South Bound			East Bound			West Bound		
Movement:	L	T	R	L	T	R	L	T	R	L	T	R
Control:	Protected			Protected			Protected			Protected		
Rights:	Ovl			Include			Include			Ovl		
Min. Green:	0	0	0	0	0	0	0	0	0	0	0	0
Y+R:	4.0	4.0	4.0	4.0	4.0	4.0	4.0	4.0	4.0	4.0	4.0	4.0
Lanes:	2	0	2	0	1	0	2	0	3	0	1	2

Volume Module:

Base Vol:	155	277	330	638	1841	20	215	849	145	488	770	188
Growth Adj:	1.00	1.00	1.00	1.00	1.00	1.00	1.00	1.00	1.00	1.00	1.00	1.00
Initial Bse:	155	277	330	638	1841	20	215	849	145	488	770	188
User Adj:	1.00	1.00	1.00	1.00	1.00	1.00	1.00	1.00	1.00	1.00	1.00	1.00
PHF Adj:	1.00	1.00	1.00	1.00	1.00	1.00	1.00	1.00	1.00	1.00	1.00	1.00
PHF Volume:	155	277	330	638	1841	20	215	849	145	488	770	188
Reduct Vol:	0	0	0	0	0	0	0	0	0	0	0	0
Reduced Vol:	155	277	330	638	1841	20	215	849	145	488	770	188
PCE Adj:	1.00	1.00	1.00	1.00	1.00	1.00	1.00	1.00	1.00	1.00	1.00	1.00
MLF Adj:	1.00	1.00	1.00	1.00	1.00	1.00	1.00	1.00	1.00	1.00	1.00	1.00
FinalVolume:	155	277	330	638	1841	20	215	849	145	488	770	188
OvlAdjVol:	86									0		

Saturation Flow Module:

Sat/Lane:	1600	1600	1600	1600	1600	1600	1600	1600	1600	1600	1600	1600
Adjustment:	1.00	1.06	1.00	1.00	1.04	1.00	1.00	1.06	1.00	1.00	1.06	1.00
Lanes:	2.00	2.00	1.00	2.00	2.97	0.03	2.00	3.00	1.00	2.00	3.00	1.00
Final Sat.:	3200	3400	1600	3200	4948	52	3200	5100	1600	3200	5100	1600

Capacity Analysis Module:

Vol/Sat:	0.05	0.08	0.21	0.20	0.37	0.39	0.07	0.17	0.09	0.15	0.15	0.12
OvlAdjV/S:	0.05									0.00		
Crit Moves:	****			****			****			****		

Santa Ana Circulation Element

Level Of Service Computation Report

ICU 1(Loss as Cycle Length %) Method (Base Volume Alternative)

Intersection #94 Tustin Ave and 4th St

Cycle (sec): 100 Critical Vol./Cap.(X): 0.791
 Loss Time (sec): 5 Average Delay (sec/veh): xxxxxx
 Optimal Cycle: 50 Level Of Service: C

Approach:	North Bound			South Bound			East Bound			West Bound		
Movement:	L	T	R	L	T	R	L	T	R	L	T	R
Control:	Protected			Protected			Protected			Protected		
Rights:	Include			Include			Include			Include		
Min. Green:	0	0	0	0	0	0	0	0	0	0	0	0
Y+R:	4.0	4.0	4.0	4.0	4.0	4.0	4.0	4.0	4.0	4.0	4.0	4.0
Lanes:	1	0	2	1	0	2	1	0	2	1	0	2

Volume Module:

Base Vol:	40	204	183	743	946	293	159	942	39	129	727	472
Growth Adj:	1.00	1.00	1.00	1.00	1.00	1.00	1.00	1.00	1.00	1.00	1.00	1.00
Initial Bse:	40	204	183	743	946	293	159	942	39	129	727	472
User Adj:	1.00	1.00	1.00	1.00	1.00	1.00	1.00	1.00	1.00	1.00	1.00	1.00
PHF Adj:	1.00	1.00	1.00	1.00	1.00	1.00	1.00	1.00	1.00	1.00	1.00	1.00
PHF Volume:	40	204	183	743	946	293	159	942	39	129	727	472
Reduct Vol:	0	0	0	0	0	0	0	0	0	0	0	0
Reduced Vol:	40	204	183	743	946	293	159	942	39	129	727	472
PCE Adj:	1.00	1.00	1.00	1.00	1.00	1.00	1.00	1.00	1.00	1.00	1.00	1.00
MLF Adj:	1.00	1.00	1.00	1.00	1.00	1.00	1.00	1.00	1.00	1.00	1.00	1.00
FinalVolume:	40	204	183	743	946	293	159	942	39	129	727	472

Saturation Flow Module:

Sat/Lane:	1600	1600	1600	1600	1600	1600	1600	1600	1600	1600	1600	1600
Adjustment:	1.00	1.06	1.00	1.00	1.06	1.00	1.00	1.06	1.00	1.00	1.06	1.00
Lanes:	1.00	2.00	1.00	2.00	2.00	1.00	1.00	3.00	1.00	1.00	2.00	1.00
Final Sat.:	1600	3400	1600	3200	3400	1600	1600	5100	1600	1600	3400	1600

Capacity Analysis Module:

Vol/Sat:	0.03	0.06	0.11	0.23	0.28	0.18	0.10	0.18	0.02	0.08	0.21	0.30
Crit Moves:			****	****			****				****	

Santa Ana Circulation Element

Level Of Service Computation Report

2000 HCM Operations Method (Base Volume Alternative)

Intersection #95 SR-55 SB Ramps / Auto Mall Dr and Edinger Ave

Cycle (sec): 100 Critical Vol./Cap.(X): 0.653
 Loss Time (sec): 5 Average Delay (sec/veh): 25.1
 Optimal Cycle: 34 Level Of Service: C

Approach:	North Bound			South Bound			East Bound			West Bound		
Movement:	L	T	R	L	T	R	L	T	R	L	T	R
Control:	Split Phase			Split Phase			Protected			Protected		
Rights:	Include			Include			Ignore			Include		
Min. Green:	0	0	0	0	0	0	0	0	0	0	0	0
Y+R:	4.0	4.0	4.0	4.0	4.0	4.0	4.0	4.0	4.0	4.0	4.0	4.0
Lanes:	1	1	0	0	0	2	1	0	1	0	1	0

Volume Module:	North Bound			South Bound			East Bound			West Bound		
Base Vol:	456	68	540	50	30	8	34	1334	493	510	1202	157
Growth Adj:	1.00	1.00	1.00	1.00	1.00	1.00	1.00	1.00	1.00	1.00	1.00	1.00
Initial Bse:	456	68	540	50	30	8	34	1334	493	510	1202	157
User Adj:	1.00	1.00	1.00	1.00	1.00	1.00	1.00	1.00	0.00	1.00	1.00	1.00
PHF Adj:	1.00	1.00	1.00	1.00	1.00	1.00	1.00	1.00	0.00	1.00	1.00	1.00
PHF Volume:	456	68	540	50	30	8	34	1334	0	510	1202	157
Reduct Vol:	0	0	0	0	0	0	0	0	0	0	0	0
Reduced Vol:	456	68	540	50	30	8	34	1334	0	510	1202	157
PCE Adj:	1.00	1.00	1.00	1.00	1.00	1.00	1.00	1.00	0.00	1.00	1.00	1.00
MLF Adj:	1.00	1.00	1.00	1.00	1.00	1.00	1.00	1.00	0.00	1.00	1.00	1.00
FinalVolume:	456	68	540	50	30	8	34	1334	0	510	1202	157

Saturation Flow Module:	North Bound			South Bound			East Bound			West Bound		
Sat/Lane:	1900	1900	1900	1900	1900	1900	1900	1900	1900	1900	1900	1900
Adjustment:	0.96	0.96	0.75	0.95	1.00	0.85	0.95	0.91	1.00	0.92	0.89	0.89
Lanes:	1.74	0.26	2.00	1.00	1.00	1.00	1.00	3.00	1.00	2.00	2.65	0.35
Final Sat.:	3168	472	2842	1805	1900	1615	1805	5187	1900	3502	4510	589

Capacity Analysis Module:	North Bound			South Bound			East Bound			West Bound		
Vol/Sat:	0.14	0.14	0.19	0.03	0.02	0.00	0.02	0.26	0.00	0.15	0.27	0.27
Crit Moves:	****			****			****			****		
Green/Cycle:	0.29	0.29	0.29	0.04	0.04	0.04	0.04	0.39	0.00	0.22	0.58	0.58
Volume/Cap:	0.49	0.49	0.65	0.65	0.37	0.12	0.46	0.65	0.00	0.65	0.46	0.46
Delay/Veh:	29.7	29.7	32.9	65.6	49.5	46.8	51.5	25.5	0.0	37.3	12.4	12.4
User DelAdj:	1.00	1.00	1.00	1.00	1.00	1.00	1.00	1.00	1.00	1.00	1.00	1.00
AdjDel/Veh:	29.7	29.7	32.9	65.6	49.5	46.8	51.5	25.5	0.0	37.3	12.4	12.4
LOS by Move:	C	C	C	E	D	D	D	C	A	D	B	B
HCM2k85thQ:	11	11	14	4	2	1	3	19	0	13	13	13

Note: Queue reported is the number of cars per lane.

Santa Ana Circulation Element

Level Of Service Computation Report

2000 HCM Operations Method (Base Volume Alternative)

 Intersection #96 SR-55 NB Ramps / Del Amo Ave and Newport Avenue

Cycle (sec): 100 Critical Vol./Cap.(X): 0.665
 Loss Time (sec): 5 Average Delay (sec/veh): 25.6
 Optimal Cycle: 35 Level Of Service: C

Approach:	North Bound			South Bound			East Bound			West Bound		
Movement:	L	T	R	L	T	R	L	T	R	L	T	R
Control:	Protected			Protected			Protected			Protected		
Rights:	Include			Ovl			Include			Include		
Min. Green:	0	0	0	0	0	0	0	0	0	0	0	0
Y+R:	4.0	4.0	4.0	4.0	4.0	4.0	4.0	4.0	4.0	4.0	4.0	4.0
Lanes:	2	0	2	1	0	3	0	1	1	0	1	1

Volume Module:	North Bound			South Bound			East Bound			West Bound		
Base Vol:	413	109	69	20	497	728	269	163	155	8	223	4
Growth Adj:	1.00	1.00	1.00	1.00	1.00	1.00	1.00	1.00	1.00	1.00	1.00	1.00
Initial Bse:	413	109	69	20	497	728	269	163	155	8	223	4
User Adj:	1.00	1.00	1.00	1.00	1.00	1.00	1.00	1.00	1.00	1.00	1.00	1.00
PHF Adj:	1.00	1.00	1.00	1.00	1.00	1.00	1.00	1.00	1.00	1.00	1.00	1.00
PHF Volume:	413	109	69	20	497	728	269	163	155	8	223	4
Reduct Vol:	0	0	0	0	0	0	0	0	0	0	0	0
Reduced Vol:	413	109	69	20	497	728	269	163	155	8	223	4
PCE Adj:	1.00	1.00	1.00	1.00	1.00	1.00	1.00	1.00	1.00	1.00	1.00	1.00
MLF Adj:	1.00	1.00	1.00	1.00	1.00	1.00	1.00	1.00	1.00	1.00	1.00	1.00
FinalVolume:	413	109	69	20	497	728	269	163	155	8	223	4

Saturation Flow Module:	North Bound			South Bound			East Bound			West Bound		
Sat/Lane:	1900	1900	1900	1900	1900	1900	1900	1900	1900	1900	1900	1900
Adjustment:	0.92	0.86	0.86	0.95	0.91	0.85	0.92	0.88	0.88	0.95	0.95	0.95
Lanes:	2.00	2.00	1.00	1.00	3.00	1.00	2.00	1.03	0.97	1.00	1.96	0.04
Final Sat.:	3502	3257	1629	1805	5187	1615	3502	1715	1631	1805	3536	63

Capacity Analysis Module:	North Bound			South Bound			East Bound			West Bound		
Vol/Sat:	0.12	0.03	0.04	0.01	0.10	0.45	0.08	0.10	0.10	0.00	0.06	0.06
Crit Moves:	****			****			****			****		
Green/Cycle:	0.18	0.59	0.59	0.15	0.56	0.68	0.12	0.20	0.20	0.01	0.09	0.09
Volume/Cap:	0.67	0.06	0.07	0.07	0.17	0.67	0.67	0.47	0.47	0.47	0.67	0.67
Delay/Veh:	41.1	8.9	8.9	36.4	10.6	11.0	46.5	35.8	35.8	68.7	48.6	48.6
User DelAdj:	1.00	1.00	1.00	1.00	1.00	1.00	1.00	1.00	1.00	1.00	1.00	1.00
AdjDel/Veh:	41.1	8.9	8.9	36.4	10.6	11.0	46.5	35.8	35.8	68.7	48.6	48.6
LOS by Move:	D	A	A	D	B	B	D	D	D	E	D	D
HCM2k85thQ:	11	1	2	1	4	21	8	8	8	1	8	8

 Note: Queue reported is the number of cars per lane.

Santa Ana Circulation Element

Level Of Service Computation Report

ICU 1(Loss as Cycle Length %) Method (Base Volume Alternative)

 Intersection #97 Red Hill Ave and Edinger Ave

Cycle (sec): 100 Critical Vol./Cap.(X): 0.619
 Loss Time (sec): 5 Average Delay (sec/veh): xxxxxx
 Optimal Cycle: 30 Level Of Service: B

Approach:	North Bound			South Bound			East Bound			West Bound		
Movement:	L	T	R	L	T	R	L	T	R	L	T	R
Control:	Protected			Protected			Protected			Protected		
Rights:	Include			Ovl			Ovl			Include		
Min. Green:	0	0	0	0	0	0	0	0	0	0	0	0
Y+R:	4.0	4.0	4.0	4.0	4.0	4.0	4.0	4.0	4.0	4.0	4.0	4.0
Lanes:	2	0	3	0	1		2	0	3	0	1	

Volume Module:

Base Vol:	122	449	128	203	861	403	397	1276	271	250	1213	170	
Growth Adj:	1.00	1.00	1.00	1.00	1.00	1.00	1.00	1.00	1.00	1.00	1.00	1.00	
Initial Bse:	122	449	128	203	861	403	397	1276	271	250	1213	170	
User Adj:	1.00	1.00	1.00	1.00	1.00	1.00	1.00	1.00	1.00	1.00	1.00	1.00	
PHF Adj:	1.00	1.00	1.00	1.00	1.00	1.00	1.00	1.00	1.00	1.00	1.00	1.00	
PHF Volume:	122	449	128	203	861	403	397	1276	271	250	1213	170	
Reduct Vol:	0	0	0	0	0	0	0	0	0	0	0	0	
Reduced Vol:	122	449	128	203	861	403	397	1276	271	250	1213	170	
PCE Adj:	1.00	1.00	1.00	1.00	1.00	1.00	1.00	1.00	1.00	1.00	1.00	1.00	
MLF Adj:	1.00	1.00	1.00	1.00	1.00	1.00	1.00	1.00	1.00	1.00	1.00	1.00	
FinalVolume:	122	449	128	203	861	403	397	1276	271	250	1213	170	
OvlAdjVol:							205				210		

Saturation Flow Module:

Sat/Lane:	1600	1600	1600	1600	1600	1600	1600	1600	1600	1600	1600	1600
Adjustment:	1.00	1.06	1.00	1.00	1.06	1.00	1.00	1.06	1.00	1.00	1.06	1.00
Lanes:	2.00	3.00	1.00	2.00	3.00	1.00	2.00	3.00	1.00	2.00	3.00	1.00
Final Sat.:	3200	5100	1600	3200	5100	1600	3200	5100	1600	3200	5100	1600

Capacity Analysis Module:

Vol/Sat:	0.04	0.09	0.08	0.06	0.17	0.25	0.12	0.25	0.17	0.08	0.24	0.11	
OvlAdjV/S:							0.13				0.13		
Crit Moves:	****			****			****			****			

Santa Ana Circulation Element

Level Of Service Computation Report

ICU 1(Loss as Cycle Length %) Method (Base Volume Alternative)

Intersection #98 Red Hill Ave and Warner Ave

Cycle (sec): 100 Critical Vol./Cap.(X): 0.580
 Loss Time (sec): 5 Average Delay (sec/veh): xxxxxxx
 Optimal Cycle: 28 Level Of Service: A

Approach:	North Bound			South Bound			East Bound			West Bound		
Movement:	L	T	R	L	T	R	L	T	R	L	T	R
Control:	Protected			Protected			Protected			Protected		
Rights:	Include			Include			Include			Ovl		
Min. Green:	0	0	0	0	0	0	0	0	0	0	0	0
Y+R:	4.0	4.0	4.0	4.0	4.0	4.0	4.0	4.0	4.0	4.0	4.0	4.0
Lanes:	2	0	3	1	0	0	2	0	2	1	0	3

Volume Module:

Base Vol:	118	716	97	20	949	191	239	407	300	152	543	96
Growth Adj:	1.00	1.00	1.00	1.00	1.00	1.00	1.00	1.00	1.00	1.00	1.00	1.00
Initial Bse:	118	716	97	20	949	191	239	407	300	152	543	96
User Adj:	1.00	1.00	1.00	1.00	1.00	1.00	1.00	1.00	1.00	1.00	1.00	1.00
PHF Adj:	1.00	1.00	1.00	1.00	1.00	1.00	1.00	1.00	1.00	1.00	1.00	1.00
PHF Volume:	118	716	97	20	949	191	239	407	300	152	543	96
Reduct Vol:	0	0	0	0	0	0	0	0	0	0	0	0
Reduced Vol:	118	716	97	20	949	191	239	407	300	152	543	96
PCE Adj:	1.00	1.00	1.00	1.00	1.00	1.00	1.00	1.00	1.00	1.00	1.00	1.00
MLF Adj:	1.00	1.00	1.00	1.00	1.00	1.00	1.00	1.00	1.00	1.00	1.00	1.00
FinalVolume:	118	716	97	20	949	191	239	407	300	152	543	96
OvlAdjVol:	86											

Saturation Flow Module:

Sat/Lane:	1600	1600	1600	1600	1600	1600	1600	1600	1600	1600	1600	1600
Adjustment:	1.00	1.05	1.00	1.00	1.05	1.00	1.00	1.06	1.00	1.00	1.06	1.00
Lanes:	2.00	3.52	0.48	2.00	2.50	0.50	1.00	2.00	1.00	2.00	3.00	1.00
Final Sat.:	3200	5936	764	3200	4196	804	1600	3400	1600	3200	5100	1600

Capacity Analysis Module:

Vol/Sat:	0.04	0.12	0.13	0.01	0.23	0.24	0.15	0.12	0.19	0.05	0.11	0.06
OvlAdjV/S:	0.05											
Crit Moves:	****			****			****			****		

 Santa Ana Circulation Element

Level Of Service Computation Report

ICU 1(Loss as Cycle Length %) Method (Base Volume Alternative)

Intersection #99 Red Hill Ave and Dyer Rd / barranca Pkwy

Cycle (sec): 100 Critical Vol./Cap.(X): 0.577
 Loss Time (sec): 5 Average Delay (sec/veh): xxxxxxx
 Optimal Cycle: 27 Level Of Service: A

Approach:	North Bound			South Bound			East Bound			West Bound		
Movement:	L	T	R	L	T	R	L	T	R	L	T	R
Control:	Protected			Protected			Protected			Protected		
Rights:	Include			Include			Include			Include		
Min. Green:	0	0	0	0	0	0	0	0	0	0	0	0
Y+R:	4.0	4.0	4.0	4.0	4.0	4.0	4.0	4.0	4.0	4.0	4.0	4.0
Lanes:	2	0	4	0	1		2	0	4	0	1	

Volume Module:

Base Vol:	184	458	151	184	809	106	126	758	300	522	583	114
Growth Adj:	1.00	1.00	1.00	1.00	1.00	1.00	1.00	1.00	1.00	1.00	1.00	1.00
Initial Bse:	184	458	151	184	809	106	126	758	300	522	583	114
User Adj:	1.00	1.00	1.00	1.00	1.00	1.00	1.00	1.00	1.00	1.00	1.00	1.00
PHF Adj:	1.00	1.00	1.00	1.00	1.00	1.00	1.00	1.00	1.00	1.00	1.00	1.00
PHF Volume:	184	458	151	184	809	106	126	758	300	522	583	114
Reduct Vol:	0	0	0	0	0	0	0	0	0	0	0	0
Reduced Vol:	184	458	151	184	809	106	126	758	300	522	583	114
PCE Adj:	1.00	1.00	1.00	1.00	1.00	1.00	1.00	1.00	1.00	1.00	1.00	1.00
MLF Adj:	1.00	1.00	1.00	1.00	1.00	1.00	1.00	1.00	1.00	1.00	1.00	1.00
Final Volume:	184	458	151	184	809	106	126	758	300	522	583	114

Saturation Flow Module:

Sat/Lane:	1600	1600	1600	1600	1600	1600	1600	1600	1600	1600	1600	1600
Adjustment:	1.00	1.06	1.00	1.00	1.06	1.00	1.00	1.06	1.00	1.00	1.06	1.00
Lanes:	2.00	4.00	1.00	2.00	4.00	1.00	2.00	3.00	1.00	2.00	4.00	1.00
Final Sat.:	3200	6800	1600	3200	6800	1600	3200	5100	1600	3200	6800	1600

Capacity Analysis Module:

Vol/Sat:	0.06	0.07	0.09	0.06	0.12	0.07	0.04	0.15	0.19	0.16	0.09	0.07
Crit Moves:	****			****			****	****	****	****		

Santa Ana Circulation Element

Level Of Service Computation Report

ICU 1(Loss as Cycle Length %) Method (Base Volume Alternative)

Intersection #100 Red Hill Ave and Alton Pkwy

Cycle (sec): 100 Critical Vol./Cap.(X): 0.930
 Loss Time (sec): 5 Average Delay (sec/veh): xxxxxx
 Optimal Cycle: 109 Level Of Service: E

Approach:	North Bound			South Bound			East Bound			West Bound		
Movement:	L	T	R	L	T	R	L	T	R	L	T	R
Control:	Protected			Protected			Protected			Protected		
Rights:	Include			Include			Include			Include		
Min. Green:	0	0	0	0	0	0	0	0	0	0	0	0
Y+R:	4.0	4.0	4.0	4.0	4.0	4.0	4.0	4.0	4.0	4.0	4.0	4.0
Lanes:	1	0	3	0	1	1	1	0	2	0	1	0

Volume Module:

Base Vol:	235	693	434	233	1059	170	185	574	574	335	284	159
Growth Adj:	1.00	1.00	1.00	1.00	1.00	1.00	1.00	1.00	1.00	1.00	1.00	1.00
Initial Bse:	235	693	434	233	1059	170	185	574	574	335	284	159
User Adj:	1.00	1.00	1.00	1.00	1.00	1.00	1.00	1.00	1.00	1.00	1.00	1.00
PHF Adj:	1.00	1.00	1.00	1.00	1.00	1.00	1.00	1.00	1.00	1.00	1.00	1.00
PHF Volume:	235	693	434	233	1059	170	185	574	574	335	284	159
Reduct Vol:	0	0	0	0	0	0	0	0	0	0	0	0
Reduced Vol:	235	693	434	233	1059	170	185	574	574	335	284	159
PCE Adj:	1.00	1.00	1.00	1.00	1.00	1.00	1.00	1.00	1.00	1.00	1.00	1.00
MLF Adj:	1.00	1.00	1.00	1.00	1.00	1.00	1.00	1.00	1.00	1.00	1.00	1.00
FinalVolume:	235	693	434	233	1059	170	185	574	574	335	284	159

Saturation Flow Module:

Sat/Lane:	1600	1600	1600	1600	1600	1600	1600	1600	1600	1600	1600	1600
Adjustment:	1.00	1.06	1.00	1.00	1.06	1.00	1.00	1.06	1.00	1.00	1.06	1.00
Lanes:	1.00	3.00	1.00	1.00	3.00	1.00	1.00	2.00	1.00	2.00	1.00	1.00
Final Sat.:	1600	5100	1600	1600	5100	1600	1600	3400	1600	3200	1700	1600

Capacity Analysis Module:

Vol/Sat:	0.15	0.14	0.27	0.15	0.21	0.11	0.12	0.17	0.36	0.10	0.17	0.10
Crit Moves:	****			****			****			****		

Santa Ana Circulation Element

Level Of Service Computation Report

ICU 1(Loss as Cycle Length %) Method (Base Volume Alternative)

 Intersection #101 Red Hill Ave and MacArthur Blvd

Cycle (sec): 100 Critical Vol./Cap.(X): 0.709
 Loss Time (sec): 5 Average Delay (sec/veh): xxxxxx
 Optimal Cycle: 38 Level Of Service: C

Approach:	North Bound			South Bound			East Bound			West Bound		
Movement:	L	T	R	L	T	R	L	T	R	L	T	R
Control:	Protected			Protected			Protected			Protected		
Rights:	Include			Ignore			Include			Ignore		
Min. Green:	0	0	0	0	0	0	0	0	0	0	0	0
Y+R:	4.0	4.0	4.0	4.0	4.0	4.0	4.0	4.0	4.0	4.0	4.0	4.0
Lanes:	2	0	2	1	0	0	2	0	3	0	1	0

Volume Module:

Base Vol:	83	742	13	205	529	485	1194	617	101	34	329	843
Growth Adj:	1.00	1.00	1.00	1.00	1.00	1.00	1.00	1.00	1.00	1.00	1.00	1.00
Initial Bse:	83	742	13	205	529	485	1194	617	101	34	329	843
User Adj:	1.00	1.00	1.00	1.00	1.00	0.00	1.00	1.00	1.00	1.00	1.00	0.00
PHF Adj:	1.00	1.00	1.00	1.00	1.00	0.00	1.00	1.00	1.00	1.00	1.00	0.00
PHF Volume:	83	742	13	205	529	0	1194	617	101	34	329	0
Reduct Vol:	0	0	0	0	0	0	0	0	0	0	0	0
Reduced Vol:	83	742	13	205	529	0	1194	617	101	34	329	0
PCE Adj:	1.00	1.00	1.00	1.00	1.00	0.00	1.00	1.00	1.00	1.00	1.00	0.00
MLF Adj:	1.00	1.00	1.00	1.00	1.00	0.00	1.00	1.00	1.00	1.00	1.00	0.00
FinalVolume:	83	742	13	205	529	0	1194	617	101	34	329	0

Saturation Flow Module:

Sat/Lane:	1600	1600	1600	1600	1600	1600	1600	1600	1600	1600	1600	1600
Adjustment:	1.00	1.04	1.00	1.00	1.06	1.00	1.00	1.06	1.00	1.00	1.06	1.00
Lanes:	2.00	2.95	0.05	2.00	3.00	1.00	2.00	3.00	1.00	1.00	3.00	1.00
Final Sat.:	3200	4917	83	3200	5100	1600	3200	5100	1600	1600	5100	1600

Capacity Analysis Module:

Vol/Sat:	0.03	0.15	0.16	0.06	0.10	0.00	0.37	0.12	0.06	0.02	0.06	0.00
Crit Moves:			****	****			****			****		

Santa Ana Circulation Element

Level Of Service Computation Report

ICU 1(Loss as Cycle Length %) Method (Base Volume Alternative)

 Intersection #102 Red Hill Ave and Main St

Cycle (sec): 100 Critical Vol./Cap.(X): 0.733
 Loss Time (sec): 5 Average Delay (sec/veh): xxxxxx
 Optimal Cycle: 41 Level Of Service: C

Approach:	North Bound			South Bound			East Bound			West Bound		
Movement:	L	T	R	L	T	R	L	T	R	L	T	R
Control:	Protected			Protected			Protected			Protected		
Rights:	Include			Include			Include			Include		
Min. Green:	0	0	0	0	0	0	0	0	0	0	0	0
Y+R:	4.0	4.0	4.0	4.0	4.0	4.0	4.0	4.0	4.0	4.0	4.0	4.0
Lanes:	2	0	2	0	2	0	1	2	0	2	1	0

Volume Module:

Base Vol:	201	691	449	78	365	126	139	1309	254	167	335	79
Growth Adj:	1.00	1.00	1.00	1.00	1.00	1.00	1.00	1.00	1.00	1.00	1.00	1.00
Initial Bse:	201	691	449	78	365	126	139	1309	254	167	335	79
User Adj:	1.00	1.00	1.00	1.00	1.00	1.00	1.00	1.00	1.00	1.00	1.00	1.00
PHF Adj:	1.00	1.00	1.00	1.00	1.00	1.00	1.00	1.00	1.00	1.00	1.00	1.00
PHF Volume:	201	691	449	78	365	126	139	1309	254	167	335	79
Reduct Vol:	0	0	0	0	0	0	0	0	0	0	0	0
Reduced Vol:	201	691	449	78	365	126	139	1309	254	167	335	79
PCE Adj:	1.00	1.00	1.00	1.00	1.00	1.00	1.00	1.00	1.00	1.00	1.00	1.00
MLF Adj:	1.00	1.00	1.00	1.00	1.00	1.00	1.00	1.00	1.00	1.00	1.00	1.00
Final Volume:	201	691	449	78	365	126	139	1309	254	167	335	79

Saturation Flow Module:

Sat/Lane:	1600	1600	1600	1600	1600	1600	1600	1600	1600	1600	1600	1600
Adjustment:	1.00	1.06	1.00	1.00	1.06	1.00	1.00	1.05	1.00	1.00	1.05	1.00
Lanes:	2.00	2.00	1.00	2.00	2.00	1.00	2.00	2.51	0.49	2.00	2.43	0.57
Final Sat.:	3200	3400	1600	3200	3400	1600	3200	4220	780	3200	4084	916

Capacity Analysis Module:

Vol/Sat:	0.06	0.20	0.28	0.02	0.11	0.08	0.04	0.31	0.33	0.05	0.08	0.09
Crit Moves:			****	****					****	****		

Santa Ana Circulation Element

Level Of Service Computation Report

2000 HCM Operations Method (Base Volume Alternative)

 Intersection #103 I-5 SB Ramps and Santa Ana Blvd

Cycle (sec): 100 Critical Vol./Cap.(X): 0.480
 Loss Time (sec): 5 Average Delay (sec/veh): 17.8
 Optimal Cycle: 24 Level Of Service: B

Approach:	North Bound			South Bound			East Bound			West Bound		
Movement:	L	T	R	L	T	R	L	T	R	L	T	R
Control:	Split Phase			Split Phase			Protected			Protected		
Rights:	Include			Ovl			Include			Include		
Min. Green:	0	0	0	0	0	0	0	0	0	0	0	0
Y+R:	4.0	4.0	4.0	4.0	4.0	4.0	4.0	4.0	4.0	4.0	4.0	4.0
Lanes:	0	0	0	2	0	0	2	0	3	0	0	2

Volume Module:	North Bound			South Bound			East Bound			West Bound		
Base Vol:	0	0	0	382	0	38	287	492	0	0	1027	300
Growth Adj:	1.00	1.00	1.00	1.00	1.00	1.00	1.00	1.00	1.00	1.00	1.00	1.00
Initial Bse:	0	0	0	382	0	38	287	492	0	0	1027	300
User Adj:	1.00	1.00	1.00	1.00	1.00	1.00	1.00	1.00	1.00	1.00	1.00	1.00
PHF Adj:	1.00	1.00	1.00	1.00	1.00	1.00	1.00	1.00	1.00	1.00	1.00	1.00
PHF Volume:	0	0	0	382	0	38	287	492	0	0	1027	300
Reduct Vol:	0	0	0	0	0	0	0	0	0	0	0	0
Reduced Vol:	0	0	0	382	0	38	287	492	0	0	1027	300
PCE Adj:	1.00	1.00	1.00	1.00	1.00	1.00	1.00	1.00	1.00	1.00	1.00	1.00
MLF Adj:	1.00	1.00	1.00	1.00	1.00	1.00	1.00	1.00	1.00	1.00	1.00	1.00
Final Volume:	0	0	0	382	0	38	287	492	0	0	1027	300

Saturation Flow Module:	North Bound			South Bound			East Bound			West Bound		
Sat/Lane:	1900	1900	1900	1900	1900	1900	1900	1900	1900	1900	1900	1900
Adjustment:	1.00	1.00	1.00	0.92	1.00	0.85	0.92	0.91	1.00	1.00	0.88	0.88
Lanes:	0.00	0.00	0.00	2.00	0.00	1.00	2.00	3.00	0.00	0.00	2.32	0.68
Final Sat.:	0	0	0	3502	0	1615	3502	5187	0	0	3878	1133

Capacity Analysis Module:	North Bound			South Bound			East Bound			West Bound		
Vol/Sat:	0.00	0.00	0.00	0.11	0.00	0.02	0.08	0.09	0.00	0.00	0.26	0.26
Crit Moves:				****			****				****	
Green/Cycle:	0.00	0.00	0.00	0.23	0.00	0.40	0.17	0.72	0.00	0.00	0.55	0.55
Volume/Cap:	0.00	0.00	0.00	0.48	0.00	0.06	0.48	0.13	0.00	0.00	0.48	0.48
Delay/Veh:	0.0	0.0	0.0	34.0	0.0	18.6	38.1	4.3	0.0	0.0	13.8	13.8
User DelAdj:	1.00	1.00	1.00	1.00	1.00	1.00	1.00	1.00	1.00	1.00	1.00	1.00

AdjDel/Veh:	0.0	0.0	0.0	34.0	0.0	18.6	38.1	4.3	0.0	0.0	13.8	13.8
LOS by Move:	A	A	A	C	A	B	D	A	A	A	B	B
HCM2k85thQ:	0	0	0	9	0	1	7	3	0	0	14	14

Note: Queue reported is the number of cars per lane.

Santa Ana Circulation Element

Level Of Service Computation Report

ICU 1(Loss as Cycle Length %) Method (Base Volume Alternative)

 Intersection #104 Tustin Ranch Rd and Warner Ave

Cycle (sec): 100 Critical Vol./Cap.(X): 0.530
 Loss Time (sec): 5 Average Delay (sec/veh): xxxxxx
 Optimal Cycle: 25 Level Of Service: A

Approach:	North Bound			South Bound			East Bound			West Bound		
Movement:	L	T	R	L	T	R	L	T	R	L	T	R
Control:	Split Phase			Split Phase			Protected			Protected		
Rights:	Include			Include			Include			Ovl		
Min. Green:	0	0	0	0	0	0	0	0	0	0	0	0
Y+R:	4.0	4.0	4.0	4.0	4.0	4.0	4.0	4.0	4.0	4.0	4.0	4.0
Lanes:	0	0	0	2	0	0	2	0	3	0	0	3

Volume Module:

Base Vol:	0	0	0	174	0	22	27	357	0	0	2130	490
Growth Adj:	1.00	1.00	1.00	1.00	1.00	1.00	1.00	1.00	1.00	1.00	1.00	1.00
Initial Bse:	0	0	0	174	0	22	27	357	0	0	2130	490
User Adj:	1.00	1.00	1.00	1.00	1.00	1.00	1.00	1.00	1.00	1.00	1.00	1.00
PHF Adj:	1.00	1.00	1.00	1.00	1.00	1.00	1.00	1.00	1.00	1.00	1.00	1.00
PHF Volume:	0	0	0	174	0	22	27	357	0	0	2130	490
Reduct Vol:	0	0	0	0	0	0	0	0	0	0	0	0
Reduced Vol:	0	0	0	174	0	22	27	357	0	0	2130	490
PCE Adj:	1.00	1.00	1.00	1.00	1.00	1.00	1.00	1.00	1.00	1.00	1.00	1.00
MLF Adj:	1.00	1.00	1.00	1.00	1.00	1.00	1.00	1.00	1.00	1.00	1.00	1.00
FinalVolume:	0	0	0	174	0	22	27	357	0	0	2130	490
OvlAdjVol:												403

Saturation Flow Module:

Sat/Lane:	1600	1600	1600	1600	1600	1600	1600	1600	1600	1600	1600	1600
Adjustment:	1.00	1.06	1.00	1.00	1.06	1.00	1.00	1.06	1.00	1.00	1.06	1.00
Lanes:	0.00	0.00	0.00	2.00	0.00	1.00	2.00	3.00	0.00	0.00	3.00	1.00
Final Sat.:	0	0	0	3200	0	1600	3200	5100	0	0	5100	1600

Capacity Analysis Module:

Vol/Sat:	0.00	0.00	0.00	0.05	0.00	0.01	0.01	0.07	0.00	0.00	0.42	0.31
OvlAdjV/S:												0.25
Crit Moves:				****				****				****

Santa Ana Circulation Element

Level Of Service Computation Report

ICU 1(Loss as Cycle Length %) Method (Base Volume Alternative)

Intersection #105 Von Karman Ave and Barranca Pkwy

Cycle (sec): 100 Critical Vol./Cap.(X): 0.930
 Loss Time (sec): 5 Average Delay (sec/veh): xxxxxxx
 Optimal Cycle: 108 Level Of Service: E

Approach:	North Bound			South Bound			East Bound			West Bound							
Movement:	L	T	R	L	T	R	L	T	R	L	T	R					
Control:	Protected			Protected			Protected			Protected							
Rights:	Include			Ovl			Include			Include							
Min. Green:	0	0	0	0	0	0	0	0	0	0	0	0					
Y+R:	4.0	4.0	4.0	4.0	4.0	4.0	4.0	4.0	4.0	4.0	4.0	4.0					
Lanes:	2	0	1	1	0	0	2	0	2	0	1	0	2	0	4	0	1

Volume Module:

Base Vol:	375	497	298	98	960	420	247	928	310	917	1506	47
Growth Adj:	1.00	1.00	1.00	1.00	1.00	1.00	1.00	1.00	1.00	1.00	1.00	1.00
Initial Bse:	375	497	298	98	960	420	247	928	310	917	1506	47
User Adj:	1.00	1.00	1.00	1.00	1.00	1.00	1.00	1.00	1.00	1.00	1.00	1.00
PHF Adj:	1.00	1.00	1.00	1.00	1.00	1.00	1.00	1.00	1.00	1.00	1.00	1.00
PHF Volume:	375	497	298	98	960	420	247	928	310	917	1506	47
Reduct Vol:	0	0	0	0	0	0	0	0	0	0	0	0
Reduced Vol:	375	497	298	98	960	420	247	928	310	917	1506	47
PCE Adj:	1.00	1.00	1.00	1.00	1.00	1.00	1.00	1.00	1.00	1.00	1.00	1.00
MLF Adj:	1.00	1.00	1.00	1.00	1.00	1.00	1.00	1.00	1.00	1.00	1.00	1.00
FinalVolume:	375	497	298	98	960	420	247	928	310	917	1506	47
OvlAdjVol:							173					

Saturation Flow Module:

Sat/Lane:	1600	1600	1600	1600	1600	1600	1600	1600	1600	1600	1600	1600
Adjustment:	1.00	1.05	1.00	1.00	1.06	1.00	1.00	1.06	1.00	1.00	1.06	1.00
Lanes:	2.00	1.25	0.75	2.00	2.00	2.00	2.00	3.00	1.00	2.00	4.00	1.00
Final Sat.:	3200	2101	1199	3200	3400	3200	3200	5100	1600	3200	6800	1600

Capacity Analysis Module:

Vol/Sat:	0.12	0.24	0.25	0.03	0.28	0.13	0.08	0.18	0.19	0.29	0.22	0.03
OvlAdjV/S:							0.05					
Crit Moves:	****			****			****			****		

Santa Ana Circulation Element

Level Of Service Computation Report

ICU 1(Loss as Cycle Length %) Method (Base Volume Alternative)

Intersection #106 Red Hill Avenue and El Camino Real

Cycle (sec): 100 Critical Vol./Cap.(X): 0.640
 Loss Time (sec): 5 Average Delay (sec/veh): xxxxxxx
 Optimal Cycle: 32 Level Of Service: B

Street Name:	Red Hill Avenue						El Camino Real					
Approach:	North Bound			South Bound			East Bound			West Bound		
Movement:	L	T	R	L	T	R	L	T	R	L	T	R
Control:	Protected			Protected			Protected			Protected		
Rights:	Include			Include			Include			Include		
Min. Green:	0	0	0	0	0	0	0	0	0	0	0	0
Y+R:	4.0	4.0	4.0	4.0	4.0	4.0	4.0	4.0	4.0	4.0	4.0	4.0
Lanes:	2	0	3	0	1	1	0	2	1	0	1	0

Volume Module:

Base Vol:	222	569	183	20	1440	88	53	120	126	197	161	12
Growth Adj:	1.00	1.00	1.00	1.00	1.00	1.00	1.00	1.00	1.00	1.00	1.00	1.00
Initial Bse:	222	569	183	20	1440	88	53	120	126	197	161	12
User Adj:	1.00	1.00	1.00	1.00	1.00	1.00	1.00	1.00	1.00	1.00	1.00	1.00
PHF Adj:	1.00	1.00	1.00	1.00	1.00	1.00	1.00	1.00	1.00	1.00	1.00	1.00
PHF Volume:	222	569	183	20	1440	88	53	120	126	197	161	12
Reduct Vol:	0	0	0	0	0	0	0	0	0	0	0	0
Reduced Vol:	222	569	183	20	1440	88	53	120	126	197	161	12
PCE Adj:	1.00	1.00	1.00	1.00	1.00	1.00	1.00	1.00	1.00	1.00	1.00	1.00
MLF Adj:	1.00	1.00	1.00	1.00	1.00	1.00	1.00	1.00	1.00	1.00	1.00	1.00
FinalVolume:	222	569	183	20	1440	88	53	120	126	197	161	12

Saturation Flow Module:

Sat/Lane:	1600	1600	1600	1600	1600	1600	1600	1600	1600	1600	1600	1600
Adjustment:	1.00	1.06	1.00	1.00	1.04	1.00	1.00	1.06	1.00	1.00	1.00	1.00
Lanes:	2.00	3.00	1.00	1.00	2.83	0.17	1.00	1.00	1.00	1.00	0.93	0.07
Final Sat.:	3200	5100	1600	1600	4724	276	1600	1700	1600	1600	1489	111

Capacity Analysis Module:

Vol/Sat:	0.07	0.11	0.11	0.01	0.30	0.32	0.03	0.07	0.08	0.12	0.11	0.11
Crit Moves:	****					****			****	****		

Santa Ana Circulation Element

Level Of Service Computation Report
 2000 HCM Operations Method (Base Volume Alternative)

 Intersection #107 Red Hill Avenue and I-5 NB Ramps

Cycle (sec): 100 Critical Vol./Cap.(X): 0.631
 Loss Time (sec): 5 Average Delay (sec/veh): 20.1
 Optimal Cycle: 32 Level Of Service: C

Street Name:	Red Hill Avenue						I-5 NB Ramps					
Approach:	North Bound			South Bound			East Bound			West Bound		
Movement:	L	T	R	L	T	R	L	T	R	L	T	R
Control:	Protected			Protected			Permitted			Permitted		
Rights:	Include			Include			Include			Include		
Min. Green:	0	0	0	0	0	0	0	0	0	0	0	0
Y+R:	4.0	4.0	4.0	4.0	4.0	4.0	4.0	4.0	4.0	4.0	4.0	4.0
Lanes:	1	0	3	0	0	3	0	0	0	2	0	0

Volume Module:												
Base Vol:	266	883	0	0	1217	458	0	0	0	238	0	272
Growth Adj:	1.00	1.00	1.00	1.00	1.00	1.00	1.00	1.00	1.00	1.00	1.00	1.00
Initial Bse:	266	883	0	0	1217	458	0	0	0	238	0	272
User Adj:	1.00	1.00	1.00	1.00	1.00	1.00	1.00	1.00	1.00	1.00	1.00	1.00
PHF Adj:	1.00	1.00	1.00	1.00	1.00	1.00	1.00	1.00	1.00	1.00	1.00	1.00
PHF Volume:	266	883	0	0	1217	458	0	0	0	238	0	272
Reduct Vol:	0	0	0	0	0	0	0	0	0	0	0	0
Reduced Vol:	266	883	0	0	1217	458	0	0	0	238	0	272
PCE Adj:	1.00	1.00	1.00	1.00	1.00	1.00	1.00	1.00	1.00	1.00	1.00	1.00
MLF Adj:	1.00	1.00	1.00	1.00	1.00	1.00	1.00	1.00	1.00	1.00	1.00	1.00
Final Volume:	266	883	0	0	1217	458	0	0	0	238	0	272

Saturation Flow Module:												
Sat/Lane:	1900	1900	1900	1900	1900	1900	1900	1900	1900	1900	1900	1900
Adjustment:	0.95	0.91	1.00	1.00	0.91	0.85	1.00	1.00	1.00	0.60	1.00	0.85
Lanes:	1.00	3.00	0.00	0.00	3.00	1.00	0.00	0.00	0.00	2.00	0.00	1.00
Final Sat.:	1805	5187	0	0	5187	1615	0	0	0	2271	0	1615

Capacity Analysis Module:												
Vol/Sat:	0.15	0.17	0.00	0.00	0.23	0.28	0.00	0.00	0.00	0.10	0.00	0.17
Crit Moves:	****					****						****
Green/Cycle:	0.23	0.68	0.00	0.00	0.45	0.45	0.00	0.00	0.00	0.27	0.00	0.27
Volume/Cap:	0.63	0.25	0.00	0.00	0.52	0.63	0.00	0.00	0.00	0.39	0.00	0.63
Delay/Veh:	37.5	6.1	0.0	0.0	20.0	23.0	0.0	0.0	0.0	30.4	0.0	35.3
User DelAdj:	1.00	1.00	1.00	1.00	1.00	1.00	1.00	1.00	1.00	1.00	1.00	1.00

AdjDel/Veh:	37.5	6.1	0.0	0.0	20.0	23.0	0.0	0.0	0.0	30.4	0.0	35.3
LOS by Move:	D	A	A	A	C	C	A	A	A	C	A	D
HCM2k85thQ:	13	6	0	0	15	17	0	0	0	5	0	13

Note: Queue reported is the number of cars per lane.

Santa Ana Circulation Element

Level of Service Computation Report
 2000 HCM Operations Method (Base Volume Alternative)

 Intersection #108 Red Hill Avenue and I-5 SB Ramps

Cycle (sec): 100 Critical Vol./Cap.(X): 0.824
 Loss Time (sec): 5 Average Delay (sec/veh): 24.7
 Optimal Cycle: 60 Level Of Service: C

Street Name:	Red Hill Avenue						I-5 SB Ramps					
	North Bound			South Bound			East Bound			West Bound		
Approach:	North Bound			South Bound			East Bound			West Bound		
Movement:	L	T	R	L	T	R	L	T	R	L	T	R
Control:	Protected			Protected			Permitted			Permitted		
Rights:	Include			Include			Include			Include		
Min. Green:	0	0	0	0	0	0	0	0	0	0	0	0
Y+R:	4.0	4.0	4.0	4.0	4.0	4.0	4.0	4.0	4.0	4.0	4.0	4.0
Lanes:	0	0	4	0	1	0	1	0	0	0	1	0

Volume Module:

Base Vol:	0	1191	527	392	1125	0	210	5	386	0	0	0
Growth Adj:	1.00	1.00	1.00	1.00	1.00	1.00	1.00	1.00	1.00	1.00	1.00	1.00
Initial Bse:	0	1191	527	392	1125	0	210	5	386	0	0	0
User Adj:	1.00	1.00	1.00	1.00	1.00	1.00	1.00	1.00	1.00	1.00	1.00	1.00
PHF Adj:	1.00	1.00	1.00	1.00	1.00	1.00	1.00	1.00	1.00	1.00	1.00	1.00
PHF Volume:	0	1191	527	392	1125	0	210	5	386	0	0	0
Reduct Vol:	0	0	0	0	0	0	0	0	0	0	0	0
Reduced Vol:	0	1191	527	392	1125	0	210	5	386	0	0	0
PCE Adj:	1.00	1.00	1.00	1.00	1.00	1.00	1.00	1.00	1.00	1.00	1.00	1.00
MLF Adj:	1.00	1.00	1.00	1.00	1.00	1.00	1.00	1.00	1.00	1.00	1.00	1.00
FinalVolume:	0	1191	527	392	1125	0	210	5	386	0	0	0

Saturation Flow Module:

Sat/Lane:	1900	1900	1900	1900	1900	1900	1900	1900	1900	1900	1900	1900
Adjustment:	1.00	0.91	0.85	0.95	0.91	1.00	0.95	0.95	0.85	1.00	1.00	1.00
Lanes:	0.00	4.00	1.00	1.00	3.00	0.00	0.98	0.02	1.00	0.00	0.00	0.00
Final Sat.:	0	6916	1615	1805	5187	0	1759	42	1615	0	0	0

Capacity Analysis Module:

Vol/Sat:	0.00	0.17	0.33	0.22	0.22	0.00	0.12	0.12	0.24	0.00	0.00	0.00
Crit Moves:	****			****			****			****		
Green/Cycle:	0.00	0.40	0.40	0.26	0.66	0.00	0.29	0.29	0.29	0.00	0.00	0.00
Volume/Cap:	0.00	0.43	0.82	0.82	0.33	0.00	0.41	0.41	0.82	0.00	0.00	0.00
Delay/Veh:	0.0	22.1	35.6	45.8	7.4	0.0	29.1	29.1	44.4	0.0	0.0	0.0
User DelAdj:	1.00	1.00	1.00	1.00	1.00	1.00	1.00	1.00	1.00	1.00	1.00	1.00
AdjDel/Veh:	0.0	22.1	35.6	45.8	7.4	0.0	29.1	29.1	44.4	0.0	0.0	0.0
LOS by Move:	A	C	D	D	A	A	C	C	D	A	A	A
HCM2k85thQ:	0	11	25	20	8	0	9	9	20	0	0	0

Note: Queue reported is the number of cars per lane.

Santa Ana Circulation Element

Level of Service Computation Report

ICU 1(Loss as Cycle Length %) Method (Base Volume Alternative)

Intersection #109 Red Hill Avenue and Nisson Road

Cycle (sec): 100 Critical Vol./Cap.(X): 0.655
 Loss Time (sec): 5 Average Delay (sec/veh): xxxxxx
 Optimal Cycle: 33 Level Of Service: B

Street Name:	Red Hill Avenue						Nisson Road					
	North Bound			South Bound			East Bound			West Bound		
Approach:	North Bound			South Bound			East Bound			West Bound		
Movement:	L	T	R	L	T	R	L	T	R	L	T	R
Control:	Protected			Protected			Split Phase			Split Phase		
Rights:	Include			Include			Include			Include		
Min. Green:	0	0	0	0	0	0	0	0	0	0	0	0
Y+R:	4.0	4.0	4.0	4.0	4.0	4.0	4.0	4.0	4.0	4.0	4.0	4.0
Lanes:	1	0	3	1	0	2	1	0	0	1	0	1

Volume Module:

Base Vol:	16	1244	23	169	1274	134	242	59	48	49	26	215
Growth Adj:	1.00	1.00	1.00	1.00	1.00	1.00	1.00	1.00	1.00	1.00	1.00	1.00
Initial Bse:	16	1244	23	169	1274	134	242	59	48	49	26	215
User Adj:	1.00	1.00	1.00	1.00	1.00	1.00	1.00	1.00	1.00	1.00	1.00	1.00
PHF Adj:	1.00	1.00	1.00	1.00	1.00	1.00	1.00	1.00	1.00	1.00	1.00	1.00
PHF Volume:	16	1244	23	169	1274	134	242	59	48	49	26	215
Reduct Vol:	0	0	0	0	0	0	0	0	0	0	0	0
Reduced Vol:	16	1244	23	169	1274	134	242	59	48	49	26	215
PCE Adj:	1.00	1.00	1.00	1.00	1.00	1.00	1.00	1.00	1.00	1.00	1.00	1.00
MLF Adj:	1.00	1.00	1.00	1.00	1.00	1.00	1.00	1.00	1.00	1.00	1.00	1.00
FinalVolume:	16	1244	23	169	1274	134	242	59	48	49	26	215

Saturation Flow Module:

Sat/Lane:	1600	1600	1600	1600	1600	1600	1600	1600	1600	1600	1600	1600
Adjustment:	1.00	1.05	1.00	1.00	1.05	1.00	1.00	1.00	1.00	1.00	1.00	1.00
Lanes:	1.00	3.93	0.07	1.00	2.71	0.29	1.00	0.55	0.45	1.00	0.11	0.89
Final Sat.:	1600	6584	116	1600	4543	457	1600	882	718	1600	173	1427

Capacity Analysis Module:

Vol/Sat:	0.01	0.19	0.20	0.11	0.28	0.29	0.15	0.07	0.07	0.03	0.15	0.15
Crit Moves:			****	****			****				****	

Santa Ana Circulation Element

Level Of Service Computation Report

ICU 1(Loss as Cycle Length %) Method (Base Volume Alternative)

Intersection #110 Red Hill Avenue and Walnut Avenue

Cycle (sec): 100 Critical Vol./Cap.(X): 0.643
 Loss Time (sec): 5 Average Delay (sec/veh): xxxxxx
 Optimal Cycle: 32 Level Of Service: B

Street Name:	Red Hill Avenue						Walnut Avenue					
Approach:	North Bound			South Bound			East Bound			West Bound		
Movement:	L	T	R	L	T	R	L	T	R	L	T	R
Control:	Protected			Protected			Protected			Protected		
Rights:	Include			Include			Include			Include		
Min. Green:	0	0	0	0	0	0	0	0	0	0	0	0
Y+R:	4.0	4.0	4.0	4.0	4.0	4.0	4.0	4.0	4.0	4.0	4.0	4.0
Lanes:	1	0	2	1	0	2	1	0	1	1	0	1

Volume Module:

Base Vol:	135	525	99	117	1180	132	99	247	244	263	348	166
Growth Adj:	1.00	1.00	1.00	1.00	1.00	1.00	1.00	1.00	1.00	1.00	1.00	1.00
Initial Bse:	135	525	99	117	1180	132	99	247	244	263	348	166
User Adj:	1.00	1.00	1.00	1.00	1.00	1.00	1.00	1.00	1.00	1.00	1.00	1.00
PHF Adj:	1.00	1.00	1.00	1.00	1.00	1.00	1.00	1.00	1.00	1.00	1.00	1.00
PHF Volume:	135	525	99	117	1180	132	99	247	244	263	348	166
Reduct Vol:	0	0	0	0	0	0	0	0	0	0	0	0
Reduced Vol:	135	525	99	117	1180	132	99	247	244	263	348	166
PCE Adj:	1.00	1.00	1.00	1.00	1.00	1.00	1.00	1.00	1.00	1.00	1.00	1.00
MLF Adj:	1.00	1.00	1.00	1.00	1.00	1.00	1.00	1.00	1.00	1.00	1.00	1.00
FinalVolume:	135	525	99	117	1180	132	99	247	244	263	348	166

Saturation Flow Module:

Sat/Lane:	1600	1600	1600	1600	1600	1600	1600	1600	1600	1600	1600	1600
Adjustment:	1.00	1.05	1.00	1.00	1.05	1.00	1.00	1.06	1.00	1.00	1.05	1.00
Lanes:	1.00	2.52	0.48	1.00	2.70	0.30	1.00	1.01	0.99	2.00	1.35	0.65
Final Sat.:	1600	4238	762	1600	4517	483	1600	1710	1590	3200	2267	1033

Capacity Analysis Module:

Vol/Sat:	0.08	0.12	0.13	0.07	0.26	0.27	0.06	0.14	0.15	0.08	0.15	0.16
Crit Moves:	****					****			****	****		

Santa Ana Circulation Element

Level Of Service Computation Report

ICU 1(Loss as Cycle Length %) Method (Base Volume Alternative)

 Intersection #111 Red Hill Avenue and Valencia Avenue

Cycle (sec): 100 Critical Vol./Cap.(X): 0.677
 Loss Time (sec): 5 Average Delay (sec/veh): xxxxxx
 Optimal Cycle: 35 Level Of Service: B

Street Name:	Red Hill Avenue						Valencia Avenue					
Approach:	North Bound			South Bound			East Bound			West Bound		
Movement:	L	T	R	L	T	R	L	T	R	L	T	R
Control:	Protected			Protected			Protected			Protected		
Rights:	Ovl			Include			Include			Ovl		
Min. Green:	0	0	0	0	0	0	0	0	0	0	0	0
Y+R:	4.0	4.0	4.0	4.0	4.0	4.0	4.0	4.0	4.0	4.0	4.0	4.0
Lanes:	1	0	3	1	0	2	1	0	1	2	0	1

Volume Module:	North Bound			South Bound			East Bound			West Bound		
Base Vol:	128	542	175	132	1132	76	48	335	130	315	433	153
Growth Adj:	1.00	1.00	1.00	1.00	1.00	1.00	1.00	1.00	1.00	1.00	1.00	1.00
Initial Bse:	128	542	175	132	1132	76	48	335	130	315	433	153
User Adj:	1.00	1.00	1.00	1.00	1.00	1.00	1.00	1.00	1.00	1.00	1.00	1.00
PHF Adj:	1.00	1.00	1.00	1.00	1.00	1.00	1.00	1.00	1.00	1.00	1.00	1.00
PHF Volume:	128	542	175	132	1132	76	48	335	130	315	433	153
Reduct Vol:	0	0	0	0	0	0	0	0	0	0	0	0
Reduced Vol:	128	542	175	132	1132	76	48	335	130	315	433	153
PCE Adj:	1.00	1.00	1.00	1.00	1.00	1.00	1.00	1.00	1.00	1.00	1.00	1.00
MLF Adj:	1.00	1.00	1.00	1.00	1.00	1.00	1.00	1.00	1.00	1.00	1.00	1.00
FinalVolume:	128	542	175	132	1132	76	48	335	130	315	433	153
OvlAdjVol:	21									21		

Saturation Flow Module:	North Bound			South Bound			East Bound			West Bound		
Sat/Lane:	1600	1600	1600	1600	1600	1600	1600	1600	1600	1600	1600	1600
Adjustment:	1.00	1.06	1.00	1.00	1.04	1.00	1.00	1.06	1.00	1.00	1.06	1.00
Lanes:	1.00	3.02	0.98	1.00	2.81	0.19	1.00	1.00	1.00	2.00	1.00	1.00
Final Sat.:	1600	5138	1562	1600	4698	302	1600	1700	1600	3200	1700	1600

Capacity Analysis Module:	North Bound			South Bound			East Bound			West Bound		
Vol/Sat:	0.08	0.11	0.11	0.08	0.24	0.25	0.03	0.20	0.08	0.10	0.25	0.10
OvlAdjV/S:	0.01									0.01		
Crit Moves:	****			****			****			****		

Santa Ana Circulation Element

Level Of Service Computation Report

ICU 1(Loss as Cycle Length %) Method (Base Volume Alternative)

Intersection #112 Tustin Ranch Road and Warner Avenue North

Cycle (sec): 100 Critical Vol./Cap.(X): 0.459

Loss Time (sec): 5 Average Delay (sec/veh): xxxxxx

Optimal Cycle: 22 Level Of Service: A

Street Name:	Tustin Ranch Road						Warner Avenue North					
Approach:	North Bound			South Bound			East Bound			West Bound		
Movement:	L	T	R	L	T	R	L	T	R	L	T	R
Control:	Protected			Protected			Split Phase			Split Phase		
Rights:	Ovl			Include			Include			Ovl		
Min. Green:	0	0	0	0	0	0	0	0	0	0	0	0
Y+R:	4.0	4.0	4.0	4.0	4.0	4.0	4.0	4.0	4.0	4.0	4.0	4.0
Lanes:	0	0	3	0	1	2	0	3	0	0	0	2

Volume Module:

Base Vol:	0	396	383	412	1165	0	0	0	0	865	0	255
Growth Adj:	1.00	1.00	1.00	1.00	1.00	1.00	1.00	1.00	1.00	1.00	1.00	1.00
Initial Bse:	0	396	383	412	1165	0	0	0	0	865	0	255
User Adj:	1.00	1.00	1.00	1.00	1.00	1.00	1.00	1.00	1.00	1.00	1.00	1.00
PHF Adj:	1.00	1.00	1.00	1.00	1.00	1.00	1.00	1.00	1.00	1.00	1.00	1.00
PHF Volume:	0	396	383	412	1165	0	0	0	0	865	0	255
Reduct Vol:	0	0	0	0	0	0	0	0	0	0	0	0
Reduced Vol:	0	396	383	412	1165	0	0	0	0	865	0	255
PCE Adj:	1.00	1.00	1.00	1.00	1.00	1.00	1.00	1.00	1.00	1.00	1.00	1.00
MLF Adj:	1.00	1.00	1.00	1.00	1.00	1.00	1.00	1.00	1.00	1.00	1.00	1.00
FinalVolume:	0	396	383	412	1165	0	0	0	0	865	0	255
OvlAdjVol:	95									0		

Saturation Flow Module:

Sat/Lane:	1600	1600	1600	1600	1600	1600	1600	1600	1600	1600	1600	1600
Adjustment:	1.00	1.06	1.00	1.00	1.06	1.00	1.00	1.06	1.00	1.00	1.06	1.00
Lanes:	0.00	3.00	1.00	2.00	3.00	0.00	0.00	0.00	0.00	3.00	0.00	2.00
Final Sat.:	0	5100	1600	3200	5100	0	0	0	0	4800	0	3200

Capacity Analysis Module:

Vol/Sat:	0.00	0.08	0.24	0.13	0.23	0.00	0.00	0.00	0.00	0.18	0.00	0.08
OvlAdjV/S:	0.06									0.00		
Crit Moves:	****			****						****		

Santa Ana Circulation Element

Level Of Service Computation Report

ICU 1(Loss as Cycle Length %) Method (Base Volume Alternative)

Intersection #113 Tustin Ranch Road and Walnut Avenue

Cycle (sec): 100 Critical Vol./Cap.(X): 1.313

Loss Time (sec): 5 Average Delay (sec/veh): xxxxxx

Optimal Cycle: 180 Level Of Service: F

Street Name:	Tustin Ranch Road						Walnut Avenue					
Approach:	North Bound			South Bound			East Bound			West Bound		
Movement:	L	T	R	L	T	R	L	T	R	L	T	R
Control:	Protected			Protected			Protected			Protected		
Rights:	Ovl			Ovl			Include			Ovl		
Min. Green:	0	0	0	0	0	0	0	0	0	0	0	0
Y+R:	4.0	4.0	4.0	4.0	4.0	4.0	4.0	4.0	4.0	4.0	4.0	4.0
Lanes:	2	0	3	0	1		2	0	3	0	1	

Volume Module:

Base Vol:	103	630	314	1123	3139	418	856	1118	675	176	260	219
Growth Adj:	1.00	1.00	1.00	1.00	1.00	1.00	1.00	1.00	1.00	1.00	1.00	1.00
Initial Bse:	103	630	314	1123	3139	418	856	1118	675	176	260	219
User Adj:	1.00	1.00	1.00	1.00	1.00	1.00	1.00	1.00	1.00	1.00	1.00	1.00
PHF Adj:	1.00	1.00	1.00	1.00	1.00	1.00	1.00	1.00	1.00	1.00	1.00	1.00
PHF Volume:	103	630	314	1123	3139	418	856	1118	675	176	260	219
Reduct Vol:	0	0	0	0	0	0	0	0	0	0	0	0
Reduced Vol:	103	630	314	1123	3139	418	856	1118	675	176	260	219
PCE Adj:	1.00	1.00	1.00	1.00	1.00	1.00	1.00	1.00	1.00	1.00	1.00	1.00
MLF Adj:	1.00	1.00	1.00	1.00	1.00	1.00	1.00	1.00	1.00	1.00	1.00	1.00
FinalVolume:	103	630	314	1123	3139	418	856	1118	675	176	260	219
OvlAdjVol:			226			0						0

Saturation Flow Module:

Sat/Lane:	1600	1600	1600	1600	1600	1600	1600	1600	1600	1600	1600	1600
Adjustment:	1.00	1.06	1.00	1.00	1.06	1.00	1.00	1.05	1.00	1.00	1.06	1.00
Lanes:	2.00	3.00	1.00	2.00	3.00	1.00	2.00	1.25	0.75	2.00	2.00	1.00
Final Sat.:	3200	5100	1600	3200	5100	1600	3200	2095	1205	3200	3400	1600

Capacity Analysis Module:

Vol/Sat:	0.03	0.12	0.20	0.35	0.62	0.26	0.27	0.53	0.56	0.06	0.08	0.14
OvlAdjV/S:			0.14			0.00						0.00
Crit Moves:	****			****			****	****		****	****	

Santa Ana Circulation Element

Level Of Service Computation Report

2000 HCM Operations Method (Base Volume Alternative)

Intersection #114 SR-55 SB Ramps and Irvine Boulevard

Cycle (sec): 100 Critical Vol./Cap.(X): 1.176

Loss Time (sec): 5 Average Delay (sec/veh): 55.4

Optimal Cycle: 180 Level Of Service: E

Street Name:	SR-55 SB Ramps						Irvine Boulevard					
	North Bound			South Bound			East Bound			West Bound		
Approach:												
Movement:	L	T	R	L	T	R	L	T	R	L	T	R
Control:	Protected			Permitted			Protected			Protected		
Rights:	Include			Include			Include			Include		
Min. Green:	0	0	0	0	0	0	0	0	0	0	0	0
Y+R:	4.0	4.0	4.0	4.0	4.0	4.0	4.0	4.0	4.0	4.0	4.0	4.0
Lanes:	0	0	0	1	0	1	0	0	2	1	0	3

Volume Module:												
Base Vol:	0	0	0	64	0	70	0	719	1290	480	1201	0
Growth Adj:	1.00	1.00	1.00	1.00	1.00	1.00	1.00	1.00	1.00	1.00	1.00	1.00
Initial Bse:	0	0	0	64	0	70	0	719	1290	480	1201	0
User Adj:	1.00	1.00	1.00	1.00	1.00	1.00	1.00	1.00	1.00	1.00	1.00	1.00
PHF Adj:	1.00	1.00	1.00	1.00	1.00	1.00	1.00	1.00	1.00	1.00	1.00	1.00
PHF Volume:	0	0	0	64	0	70	0	719	1290	480	1201	0
Reduct Vol:	0	0	0	0	0	0	0	0	0	0	0	0
Reduced Vol:	0	0	0	64	0	70	0	719	1290	480	1201	0
PCE Adj:	1.00	1.00	1.00	1.00	1.00	1.00	1.00	1.00	1.00	1.00	1.00	1.00
MLF Adj:	1.00	1.00	1.00	1.00	1.00	1.00	1.00	1.00	1.00	1.00	1.00	1.00
FinalVolume:	0	0	0	64	0	70	0	719	1290	480	1201	0

Saturation Flow Module:												
Sat/Lane:	1900	1900	1900	1900	1900	1900	1900	1900	1900	1900	1900	1900
Adjustment:	1.00	1.00	1.00	0.88	1.00	0.79	1.00	0.82	0.82	0.95	0.91	1.00
Lanes:	0.00	0.00	0.00	1.45	0.00	1.55	0.00	2.00	1.00	1.00	3.00	0.00
Final Sat.:	0	0	0	2426	0	2321	0	3126	1563	1805	5187	0

Capacity Analysis Module:												
Vol/Sat:	0.00	0.00	0.00	0.03	0.00	0.03	0.00	0.23	0.83	0.27	0.23	0.00
Crit Moves:				****				****			****	
Green/Cycle:	0.00	0.00	0.00	0.02	0.00	0.04	0.00	0.70	0.70	0.23	0.93	0.00
Volume/Cap:	0.00	0.00	0.00	0.89	0.00	0.69	0.00	0.33	1.18	1.18	0.25	0.00
Delay/Veh:	0.0	0.0	0.0	91.2	0.0	56.8	0.0	5.8	100.6	140.8	0.4	0.0
User DelAdj:	1.00	1.00	1.00	1.00	1.00	1.00	1.00	1.00	1.00	1.00	1.00	1.00
AdjDel/Veh:	0.0	0.0	0.0	91.2	0.0	56.8	0.0	5.8	100.6	140.8	0.4	0.0
LOS by Move:	A	A	A	F	A	E	A	A	F	F	A	A

HCM2k85thQ: 0 0 0 5 0 4 0 7 95 38 2 0

Note: Queue reported is the number of cars per lane.

Santa Ana Circulation Element

Level of Service Computation Report
 2000 HCM Operations Method (Base Volume Alternative)

 Intersection #115 SR-55 NB Ramps and Irvine Boulevard

Cycle (sec): 100 Critical Vol./Cap.(X): 0.824
 Loss Time (sec): 5 Average Delay (sec/veh): 20.3
 Optimal Cycle: 60 Level Of Service: C

Street Name:	SR-55 NB Ramps						Irvine Boulevard					
	North Bound			South Bound			East Bound			West Bound		
Approach:	North Bound			South Bound			East Bound			West Bound		
Movement:	L	T	R	L	T	R	L	T	R	L	T	R
Control:	Permitted			Protected			Protected			Protected		
Rights:	Include			Include			Include			Include		
Min. Green:	0	0	0	0	0	0	0	0	0	0	0	0
Y+R:	4.0	4.0	4.0	4.0	4.0	4.0	4.0	4.0	4.0	4.0	4.0	4.0
Lanes:	1	0	1	0	0	0	1	0	3	0	0	2

Volume Module:

Base Vol:	395	0	379	0	0	0	204	485	0	0	1133	788
Growth Adj:	1.00	1.00	1.00	1.00	1.00	1.00	1.00	1.00	1.00	1.00	1.00	1.00
Initial Bse:	395	0	379	0	0	0	204	485	0	0	1133	788
User Adj:	1.00	1.00	1.00	1.00	1.00	1.00	1.00	1.00	1.00	1.00	1.00	1.00
PHF Adj:	1.00	1.00	1.00	1.00	1.00	1.00	1.00	1.00	1.00	1.00	1.00	1.00
PHF Volume:	395	0	379	0	0	0	204	485	0	0	1133	788
Reduct Vol:	0	0	0	0	0	0	0	0	0	0	0	0
Reduced Vol:	395	0	379	0	0	0	204	485	0	0	1133	788
PCE Adj:	1.00	1.00	1.00	1.00	1.00	1.00	1.00	1.00	1.00	1.00	1.00	1.00
MLF Adj:	1.00	1.00	1.00	1.00	1.00	1.00	1.00	1.00	1.00	1.00	1.00	1.00
FinalVolume:	395	0	379	0	0	0	204	485	0	0	1133	788

Saturation Flow Module:

Sat/Lane:	1900	1900	1900	1900	1900	1900	1900	1900	1900	1900	1900	1900
Adjustment:	0.75	1.00	0.74	1.00	1.00	1.00	0.95	0.91	1.00	1.00	0.85	0.85
Lanes:	1.51	0.00	1.49	0.00	0.00	0.00	1.00	3.00	0.00	0.00	2.00	1.00
Final Sat.:	2138	0	2097	0	0	0	1805	5187	0	0	3247	1624

Capacity Analysis Module:

Vol/Sat:	0.18	0.00	0.18	0.00	0.00	0.00	0.11	0.09	0.00	0.00	0.35	0.49
Crit Moves:	****			****			****			****		
Green/Cycle:	0.22	0.00	0.45	0.00	0.00	0.00	0.14	0.73	0.00	0.00	0.59	0.59
Volume/Cap:	0.83	0.00	0.40	0.00	0.00	0.00	0.82	0.13	0.00	0.00	0.59	0.82
Delay/Veh:	43.0	0.0	18.8	0.0	0.0	0.0	61.5	4.2	0.0	0.0	13.3	18.9
User DelAdj:	1.00	1.00	1.00	1.00	1.00	1.00	1.00	1.00	1.00	1.00	1.00	1.00
AdjDel/Veh:	43.0	0.0	18.8	0.0	0.0	0.0	61.5	4.2	0.0	0.0	13.3	18.9
LOS by Move:	D	A	B	A	A	A	E	A	A	A	B	B
HCM2k85thQ:	15	0	8	0	0	0	13	3	0	0	18	33

Note: Queue reported is the number of cars per lane.

APPENDIX D.6
ANALYSIS WORKSHEETS –
2045 WP (PM Peak Hour)

Santa Ana Circulation Element

Scenario Report

Scenario: 2045 WP PM Peak Hour
Command: Default Command
Volume: 2045 PM
Geometry: SACE
Impact Fee: Default Impact Fee
Trip Generation: Default Trip Generation
Trip Distribution: Default Trip Distribution
Paths: Default Path
Routes: Default Route
Configuration: Default Configuration

 Santa Ana Circulation Element

 Impact Analysis Report
 Level Of Service

Intersection	Base		Future		Change in
	Del/	V/	Del/	V/	
	LOS	Veh C	LOS	Veh C	
# 1 Euclid St and 1st St	C	xxxxxx 0.787	C	xxxxxx 0.787	+ 0.000 V/C
# 2 Euclid St and McFadden Ave	C	xxxxxx 0.793	C	xxxxxx 0.793	+ 0.000 V/C
# 3 Euclid St and Edinger Ave	D	xxxxxx 0.860	D	xxxxxx 0.860	+ 0.000 V/C
# 4 Newhope St and Hazard Ave	A	xxxxxx 0.516	A	xxxxxx 0.516	+ 0.000 V/C
# 5 Newhope St and McFadden Ave	B	xxxxxx 0.684	B	xxxxxx 0.684	+ 0.000 V/C
# 6 Harbor Blvd and SR-22 WB Off-R	C	23.8 0.769	C	23.8 0.769	+ 0.000 D/V
# 7 Trask Avenue and SR-22 EB On-R	B	11.0 0.381	B	11.0 0.381	+ 0.000 D/V
# 8 Harbor Blvd and Westminster Av	D	xxxxxx 0.842	D	xxxxxx 0.842	+ 0.000 V/C
# 9 Harbor Blvd and 1st St	C	xxxxxx 0.753	C	xxxxxx 0.753	+ 0.000 V/C
# 10 Harbor Blvd and McFadden Ave	C	xxxxxx 0.711	C	xxxxxx 0.711	+ 0.000 V/C
# 11 Harbor Blvd and Edinger Ave	C	xxxxxx 0.722	C	xxxxxx 0.722	+ 0.000 V/C
# 12 Harbor Blvd and Warner Ave	F	xxxxxx 1.539	F	xxxxxx 1.539	+ 0.000 V/C
# 13 Harbor Blvd and Segerstrom Ave	E	xxxxxx 0.934	E	xxxxxx 0.934	+ 0.000 V/C
# 14 MacArthur Blvd and Hyland Ave	D	xxxxxx 0.891	D	xxxxxx 0.891	+ 0.000 V/C
# 15 MacArthur Blvd and Harbor Blvd	C	xxxxxx 0.788	C	xxxxxx 0.788	+ 0.000 V/C
# 16 Harbor Blvd and Sunflower Ave	C	xxxxxx 0.711	C	xxxxxx 0.711	+ 0.000 V/C
# 17 Harbor Blvd and I-405 NB Off-R	B	18.8 0.710	B	18.8 0.710	+ 0.000 D/V
# 18 Harbor Blvd and I-405 SB Off-R	B	18.1 0.673	B	18.1 0.673	+ 0.000 D/V
# 19 Fairview St and Civic Center D	C	xxxxxx 0.707	C	xxxxxx 0.707	+ 0.000 V/C
# 20 Fairview St and 1st St	D	xxxxxx 0.894	D	xxxxxx 0.894	+ 0.000 V/C
# 21 Fairview St and McFadden Ave	B	xxxxxx 0.684	B	xxxxxx 0.684	+ 0.000 V/C
# 22 Fairview St and Edinger Ave	E	xxxxxx 0.920	E	xxxxxx 0.920	+ 0.000 V/C
# 23 Fairview St and Warner Ave	D	xxxxxx 0.805	D	xxxxxx 0.805	+ 0.000 V/C
# 24 Fairview St and MacArthur Blvd	C	xxxxxx 0.761	C	xxxxxx 0.761	+ 0.000 V/C

 Santa Ana Circulation Element

Intersection	Base		Future		Change in
	Del/ LOS	V/ Veh C	Del/ LOS	V/ Veh C	
# 25 Fairview Rd and Sunflower Ave	B xxxxxx	0.691	B xxxxxx	0.691	+ 0.000 V/C
# 26 Greenville St and Edinger Ave	B xxxxxx	0.647	B xxxxxx	0.647	+ 0.000 V/C
# 27 Greenville St and Segerstrom A	C xxxxxx	0.797	C xxxxxx	0.797	+ 0.000 V/C
# 28 Raitt St and McFadden Ave	B xxxxxx	0.676	B xxxxxx	0.676	+ 0.000 V/C
# 29 Raitt St and Edinger Ave	E xxxxxx	0.988	E xxxxxx	0.988	+ 0.000 V/C
# 30 Bear St and MacArthur Blvd	E xxxxxx	0.904	E xxxxxx	0.904	+ 0.000 V/C
# 31 Bristol St and 17th St	D xxxxxx	0.811	D xxxxxx	0.811	+ 0.000 V/C
# 32 Bristol St and Civic Center Dr	D xxxxxx	0.898	D xxxxxx	0.898	+ 0.000 V/C
# 33 Bristol St and Santa Ana Blvd	C xxxxxx	0.732	C xxxxxx	0.732	+ 0.000 V/C
# 34 Bristol St and 1st St	E xxxxxx	0.972	E xxxxxx	0.972	+ 0.000 V/C
# 35 Bristol St and McFadden Ave	D xxxxxx	0.890	D xxxxxx	0.890	+ 0.000 V/C
# 36 Bristol St and Warner Ave	D xxxxxx	0.871	D xxxxxx	0.871	+ 0.000 V/C
# 37 Bristol St and Segerstrom Ave	E xxxxxx	0.915	E xxxxxx	0.915	+ 0.000 V/C
# 38 Bristol St and Alton Ave	A xxxxxx	0.583	A xxxxxx	0.583	+ 0.000 V/C
# 39 Bristol St and MacArthur Blvd	C xxxxxx	0.796	C xxxxxx	0.796	+ 0.000 V/C
# 40 Bristol St and Sunflower Ave	C xxxxxx	0.744	C xxxxxx	0.744	+ 0.000 V/C
# 41 Bristol St and I-405 NB Ramps	C 29.0	0.854	C 29.0	0.854	+ 0.000 D/V
# 42 Bristol St and I-405 SB Ramps	B 18.2	0.631	B 18.2	0.631	+ 0.000 D/V
# 43 Flower St and Santa Ana Blvd	B xxxxxx	0.668	B xxxxxx	0.668	+ 0.000 V/C
# 44 Flower St and 1st St	F xxxxxx	1.215	F xxxxxx	1.215	+ 0.000 V/C
# 45 Flower St and McFadden Ave	E xxxxxx	0.968	E xxxxxx	0.968	+ 0.000 V/C
# 46 Flower St and Segerstrom Ave	E xxxxxx	0.916	E xxxxxx	0.916	+ 0.000 V/C
# 47 Flower St and MacArthur Blvd	E xxxxxx	0.908	E xxxxxx	0.908	+ 0.000 V/C
# 48 Main St and La Veta Ave	C xxxxxx	0.764	C xxxxxx	0.764	+ 0.000 V/C
# 49 Main St and Mainplace Dr / Mem	A xxxxxx	0.504	A xxxxxx	0.504	+ 0.000 V/C
# 50 Main St and 17th St	C xxxxxx	0.799	C xxxxxx	0.799	+ 0.000 V/C

Traffix 8.0.0715 (c) 2008 Dowling Assoc. Licensed to IBI GROUP, IRVINE, CA

 Santa Ana Circulation Element

Intersection	Base		Future		Change in
	Del/ LOS	V/ Veh C	Del/ LOS	V/ Veh C	
# 51 Main St and Civic Center Dr	D	xxxxxx 0.856	D	xxxxxx 0.856	+ 0.000 V/C
# 52 Main St and Santa Ana Blvd	C	xxxxxx 0.700	C	xxxxxx 0.700	+ 0.000 V/C
# 53 Main St and 4th St	A	xxxxxx 0.472	A	xxxxxx 0.472	+ 0.000 V/C
# 54 Main St and 1st St	D	xxxxxx 0.803	D	xxxxxx 0.803	+ 0.000 V/C
# 55 Main St and McFadden Ave	E	xxxxxx 0.935	E	xxxxxx 0.935	+ 0.000 V/C
# 56 Main St and Edinger Ave	E	xxxxxx 0.977	E	xxxxxx 0.977	+ 0.000 V/C
# 57 Main St and MacArthur Blvd	C	xxxxxx 0.781	C	xxxxxx 0.781	+ 0.000 V/C
# 58 Penn Wy and 17th St	C	20.3 0.790	C	20.3 0.790	+ 0.000 D/V
# 59 I-5 NB Off Ramps/17th Street	C	20.3 0.630	C	20.3 0.630	+ 0.000 D/V
# 60 Penn Wy and I-5 SB Ramps	C	22.8 0.433	C	22.8 0.433	+ 0.000 D/V
# 61 Santiago St and Civic Center D	D	27.6 0.896	D	27.6 0.896	+ 0.000 V/C
# 62 Santiago St and Santa Ana Blvd	F	xxxxxx 1.411	F	xxxxxx 1.411	+ 0.000 V/C
# 63 Standard Ave and 4th St	F	xxxxxx 1.341	F	xxxxxx 1.341	+ 0.000 V/C
# 64 Standard Ave and 1st St	F	xxxxxx 1.484	F	xxxxxx 1.484	+ 0.000 V/C
# 65 Standard Ave and Mcfadden Ave	C	xxxxxx 0.769	C	xxxxxx 0.769	+ 0.000 V/C
# 66 Halladay St and Warner Ave	D	xxxxxx 0.824	D	xxxxxx 0.824	+ 0.000 V/C
# 67 Halladay St and Dyer Rd	E	xxxxxx 0.945	E	xxxxxx 0.945	+ 0.000 V/C
# 68 SR-55 SB Ramps and MacArthur B	B	18.4 0.602	B	18.4 0.602	+ 0.000 D/V
# 69 SR-55 NB Ramps and MacArthur B	B	16.2 0.511	B	16.2 0.511	+ 0.000 D/V
# 70 SR-55 SB Ramps and Dyer Rd	C	26.5 0.679	C	26.5 0.679	+ 0.000 D/V
# 71 Glassell St and La Veta Ave	C	xxxxxx 0.766	C	xxxxxx 0.766	+ 0.000 V/C
# 72 Glassell St and SR-22 WB Ramps	C	33.4 0.943	C	33.4 0.943	+ 0.000 D/V
# 73 Grand Ave / Glassell St and SR	C	31.8 0.927	C	31.8 0.927	+ 0.000 D/V
# 74 Grand Ave and Fairhaven Ave	B	xxxxxx 0.665	B	xxxxxx 0.665	+ 0.000 V/C
# 75 Grand Ave and Santa Clara Ave	C	xxxxxx 0.731	C	xxxxxx 0.731	+ 0.000 V/C

 Santa Ana Circulation Element

Intersection	Base		Future		Change in	
	Del/ LOS	V/ Veh C	Del/ LOS	V/ Veh C		
# 76 Grand Ave and 17th St	D	xxxxxx 0.854	D	xxxxxx 0.854	+ 0.000	V/C
# 77 Grand Ave and I-5 NB Ramps	B	11.3 0.764	B	11.3 0.764	+ 0.000	D/V
# 78 Grand Ave and Santa Ana Blvd	C	28.5 0.827	C	28.5 0.827	+ 0.000	D/V
# 79 Grand Ave and 1st St	C	xxxxxx 0.718	C	xxxxxx 0.718	+ 0.000	V/C
# 80 Grand Ave and Chestnut Ave	C	xxxxxx 0.783	C	xxxxxx 0.783	+ 0.000	V/C
# 81 Grand Ave and McFadden Ave	D	xxxxxx 0.813	D	xxxxxx 0.813	+ 0.000	V/C
# 82 Grand Ave and Edinger Ave	F	xxxxxx 1.079	F	xxxxxx 1.079	+ 0.000	V/C
# 83 Grand Ave and Warner Ave	D	xxxxxx 0.899	D	xxxxxx 0.899	+ 0.000	V/C
# 84 SR-55 NB Ramps and Dyer Rd	A	6.0 0.349	A	6.0 0.349	+ 0.000	D/V
# 85 Cambridge St and La Veta Ave	D	26.1 0.938	D	26.1 0.938	+ 0.000	V/C
# 86 Cambridge St and Fairhaven Ave	A	xxxxxx 0.531	A	xxxxxx 0.531	+ 0.000	V/C
# 87 Mabury St and 1st Street	C	27.2 0.752	C	27.2 0.752	+ 0.000	D/V
# 88 Tustin St and La Veta Ave	A	xxxxxx 0.344	A	xxxxxx 0.344	+ 0.000	V/C
# 89 Tustin St and SR-22 WB On-Ramp	A	7.7 0.321	A	7.7 0.321	+ 0.000	D/V
# 90 Tustin St and SR-22 EB Off-Ram	C	23.3 0.625	C	23.3 0.625	+ 0.000	D/V
# 91 Tustin Ave and Fairhaven Ave	C	xxxxxx 0.757	C	xxxxxx 0.757	+ 0.000	V/C
# 92 Tustin Ave and Santa Clara Ave	C	xxxxxx 0.779	C	xxxxxx 0.779	+ 0.000	V/C
# 93 Tustin Ave and 17th St	C	xxxxxx 0.741	C	xxxxxx 0.741	+ 0.000	V/C
# 94 Tustin Ave and 4th St	C	xxxxxx 0.784	C	xxxxxx 0.784	+ 0.000	V/C
# 95 SR-55 SB Ramps / Auto Mall Dr	C	25.4 0.687	C	25.4 0.687	+ 0.000	D/V
# 96 SR-55 NB Ramps / Del Amo Ave a	D	46.2 0.951	D	46.2 0.951	+ 0.000	D/V
# 97 Red Hill Ave and Edinger Ave	D	xxxxxx 0.865	D	xxxxxx 0.865	+ 0.000	V/C
# 98 Red Hill Ave and Warner Ave	E	xxxxxx 0.952	E	xxxxxx 0.952	+ 0.000	V/C
# 99 Red Hill Ave and Dyer Rd / bar	A	xxxxxx 0.591	A	xxxxxx 0.591	+ 0.000	V/C
#100 Red Hill Ave and Alton Pkwy	F	xxxxxx 1.494	F	xxxxxx 1.494	+ 0.000	V/C
#101 Red Hill Ave and MacArthur Blv	C	xxxxxx 0.722	C	xxxxxx 0.722	+ 0.000	V/C

Traffix 8.0.0715 (c) 2008 Dowling Assoc. Licensed to IBI GROUP, IRVINE, CA

 Santa Ana Circulation Element

Intersection	Base		Future		Change in
	Del/ LOS	V/ Veh C	Del/ LOS	V/ Veh C	
#102 Red Hill Ave and Main St	D	xxxxx 0.836	D	xxxxx 0.836	+ 0.000 V/C
#103 I-5 SB Ramps and Santa Ana Blv	B	19.9 0.444	B	19.9 0.444	+ 0.000 D/V
#104 Tustin Ranch Rd and Warner Ave	B	xxxxx 0.671	B	xxxxx 0.671	+ 0.000 V/C
#105 Von Karman Ave and Barranca Pk	F	xxxxx 1.284	F	xxxxx 1.284	+ 0.000 V/C
#106 Red Hill Avenue and El Camino	B	xxxxx 0.696	B	xxxxx 0.696	+ 0.000 V/C
#107 Red Hill Avenue and I-5 NB Ram	C	23.6 0.623	C	23.6 0.623	+ 0.000 D/V
#108 Red Hill Avenue and I-5 SB Ram	C	21.8 0.713	C	21.8 0.713	+ 0.000 D/V
#109 Red Hill Avenue and Nisson Roa	C	xxxxx 0.715	C	xxxxx 0.715	+ 0.000 V/C
#110 Red Hill Avenue and Walnut Ave	C	xxxxx 0.749	C	xxxxx 0.749	+ 0.000 V/C
#111 Red Hill Avenue and Valencia A	C	xxxxx 0.753	C	xxxxx 0.753	+ 0.000 V/C
#112 Tustin Ranch Road and Warner A	E	xxxxx 0.924	E	xxxxx 0.924	+ 0.000 V/C
#113 Tustin Ranch Road and Walnut A	F	xxxxx 1.772	F	xxxxx 1.772	+ 0.000 V/C
#114 SR-55 SB Ramps and Irvine Boul	C	26.5 0.929	C	26.5 0.929	+ 0.000 D/V
#115 SR-55 NB Ramps and Irvine Boul	C	22.3 0.841	C	22.3 0.841	+ 0.000 D/V

Santa Ana Circulation Element

Level Of Service Computation Report

ICU 1(Loss as Cycle Length %) Method (Base Volume Alternative)

Intersection #1 Euclid St and 1st St

Cycle (sec): 100 Critical Vol./Cap.(X): 0.787
 Loss Time (sec): 5 Average Delay (sec/veh): xxxxxx
 Optimal Cycle: 49 Level Of Service: C

Approach:	North Bound			South Bound			East Bound			West Bound		
Movement:	L	T	R	L	T	R	L	T	R	L	T	R
Control:	Protected			Protected			Protected			Protected		
Rights:	Include			Include			WideBypass			WideBypass		
Min. Green:	0	0	0	0	0	0	0	0	0	0	0	0
Y+R:	4.0	4.0	4.0	4.0	4.0	4.0	4.0	4.0	4.0	4.0	4.0	4.0
Lanes:	1	0	2	1	0	2	1	0	2	1	0	2

Volume Module:

Base Vol:	165	1532	123	137	781	148	201	641	100	168	702	168
Growth Adj:	1.00	1.00	1.00	1.00	1.00	1.00	1.00	1.00	1.00	1.00	1.00	1.00
Initial Bse:	165	1532	123	137	781	148	201	641	100	168	702	168
User Adj:	1.00	1.00	1.00	1.00	1.00	1.00	1.00	1.00	1.00	1.00	1.00	1.00
PHF Adj:	1.00	1.00	1.00	1.00	1.00	1.00	1.00	1.00	1.00	1.00	1.00	1.00
PHF Volume:	165	1532	123	137	781	148	201	641	100	168	702	168
Reduct Vol:	0	0	0	0	0	0	0	0	0	0	0	0
Reduced Vol:	165	1532	123	137	781	148	201	641	100	168	702	168
PCE Adj:	1.00	1.00	1.00	1.00	1.00	1.00	1.00	1.00	1.00	1.00	1.00	1.00
MLF Adj:	1.00	1.00	1.00	1.00	1.00	1.00	1.00	1.00	1.00	1.00	1.00	1.00
FinalVolume:	165	1532	123	137	781	148	201	641	100	168	702	168

Saturation Flow Module:

Sat/Lane:	1600	1600	1600	1600	1600	1600	1600	1600	1600	1600	1600	1600
Adjustment:	1.00	1.05	1.00	1.00	1.05	1.00	1.00	1.05	1.00	1.00	1.05	1.00
Lanes:	1.00	2.78	0.22	1.00	2.52	0.48	1.00	2.60	0.40	1.00	2.42	0.58
Final Sat.:	1600	4643	357	1600	4235	765	1600	4352	648	1600	4073	927

Capacity Analysis Module:

Vol/Sat:	0.10	0.33	0.34	0.09	0.18	0.19	0.13	0.15	0.15	0.11	0.17	0.18
Crit Moves:			****	****			****			****		

Santa Ana Circulation Element

Level Of Service Computation Report

ICU 1(Loss as Cycle Length %) Method (Base Volume Alternative)

Intersection #2 Euclid St and McFadden Ave

Cycle (sec): 100 Critical Vol./Cap.(X): 0.793
 Loss Time (sec): 5 Average Delay (sec/veh): xxxxxx
 Optimal Cycle: 51 Level Of Service: C

Approach:	North Bound			South Bound			East Bound			West Bound		
Movement:	L	T	R	L	T	R	L	T	R	L	T	R
Control:	Protected			Protected			Prot+Permit			Prot+Permit		
Rights:	WideBypass			Include			Include			Include		
Min. Green:	0	0	0	0	0	0	0	0	0	0	0	0
Y+R:	4.0	4.0	4.0	4.0	4.0	4.0	4.0	4.0	4.0	4.0	4.0	4.0
Lanes:	1	0	2	1	0	2	1	0	1	1	0	1

Volume Module:

Base Vol:	248	2020	130	87	1070	130	134	307	136	86	359	166
Growth Adj:	1.00	1.00	1.00	1.00	1.00	1.00	1.00	1.00	1.00	1.00	1.00	1.00
Initial Bse:	248	2020	130	87	1070	130	134	307	136	86	359	166
User Adj:	1.00	1.00	1.00	1.00	1.00	1.00	1.00	1.00	1.00	1.00	1.00	1.00
PHF Adj:	1.00	1.00	1.00	1.00	1.00	1.00	1.00	1.00	1.00	1.00	1.00	1.00
PHF Volume:	248	2020	130	87	1070	130	134	307	136	86	359	166
Reduct Vol:	0	0	0	0	0	0	0	0	0	0	0	0
Reduced Vol:	248	2020	130	87	1070	130	134	307	136	86	359	166
PCE Adj:	1.00	1.00	1.00	1.00	1.00	1.00	1.00	1.00	1.00	1.00	1.00	1.00
MLF Adj:	1.00	1.00	1.00	1.00	1.00	1.00	1.00	1.00	1.00	1.00	1.00	1.00
FinalVolume:	248	2020	130	87	1070	130	134	307	136	86	359	166

Saturation Flow Module:

Sat/Lane:	1600	1600	1600	1600	1600	1600	1600	1600	1600	1600	1600	1600
Adjustment:	1.00	1.04	1.00	1.00	1.05	1.00	1.00	1.05	1.00	1.00	1.05	1.00
Lanes:	1.00	2.82	0.18	1.00	2.68	0.32	1.00	1.39	0.61	1.00	1.37	0.63
Final Sat.:	1600	4710	290	1600	4480	520	1600	2318	982	1600	2288	1012

Capacity Analysis Module:

Vol/Sat:	0.16	0.43	0.45	0.05	0.24	0.25	0.08	0.13	0.14	0.05	0.16	0.16
Crit Moves:			****	****			****			****		

Santa Ana Circulation Element

Level Of Service Computation Report

ICU 1(Loss as Cycle Length %) Method (Base Volume Alternative)

Intersection #3 Euclid St and Edinger Ave

Cycle (sec): 100 Critical Vol./Cap.(X): 0.860
 Loss Time (sec): 5 Average Delay (sec/veh): xxxxxx
 Optimal Cycle: 69 Level Of Service: D

Approach:	North Bound			South Bound			East Bound			West Bound		
Movement:	L	T	R	L	T	R	L	T	R	L	T	R
Control:	Protected			Protected			Protected			Protected		
Rights:	Include			Include			Include			Include		
Min. Green:	0	0	0	0	0	0	0	0	0	0	0	0
Y+R:	4.0	4.0	4.0	4.0	4.0	4.0	4.0	4.0	4.0	4.0	4.0	4.0
Lanes:	2	0	2	1	0	0	2	0	2	0	1	0

Volume Module:

Base Vol:	551	1648	117	136	897	228	121	467	140	119	1103	179
Growth Adj:	1.00	1.00	1.00	1.00	1.00	1.00	1.00	1.00	1.00	1.00	1.00	1.00
Initial Bse:	551	1648	117	136	897	228	121	467	140	119	1103	179
User Adj:	1.00	1.00	1.00	1.00	1.00	1.00	1.00	1.00	1.00	1.00	1.00	1.00
PHF Adj:	1.00	1.00	1.00	1.00	1.00	1.00	1.00	1.00	1.00	1.00	1.00	1.00
PHF Volume:	551	1648	117	136	897	228	121	467	140	119	1103	179
Reduct Vol:	0	0	0	0	0	0	0	0	0	0	0	0
Reduced Vol:	551	1648	117	136	897	228	121	467	140	119	1103	179
PCE Adj:	1.00	1.00	1.00	1.00	1.00	1.00	1.00	1.00	1.00	1.00	1.00	1.00
MLF Adj:	1.00	1.00	1.00	1.00	1.00	1.00	1.00	1.00	1.00	1.00	1.00	1.00
FinalVolume:	551	1648	117	136	897	228	121	467	140	119	1103	179

Saturation Flow Module:

Sat/Lane:	1600	1600	1600	1600	1600	1600	1600	1600	1600	1600	1600	1600
Adjustment:	1.00	1.04	1.00	1.00	1.05	1.00	1.00	1.06	1.00	1.00	1.06	1.00
Lanes:	2.00	2.80	0.20	2.00	2.39	0.61	1.00	2.00	1.00	1.00	2.00	1.00
Final Sat.:	3200	4682	318	3200	4027	973	1600	3400	1600	1600	3400	1600

Capacity Analysis Module:

Vol/Sat:	0.17	0.35	0.37	0.04	0.22	0.23	0.08	0.14	0.09	0.07	0.32	0.11
Crit Moves:			****	****			****			****		

Santa Ana Circulation Element

Level Of Service Computation Report

ICU 1(Loss as Cycle Length %) Method (Base Volume Alternative)

Intersection #4 Newhope St and Hazard Ave

Cycle (sec): 100 Critical Vol./Cap.(X): 0.516
 Loss Time (sec): 5 Average Delay (sec/veh): xxxxxx
 Optimal Cycle: 24 Level Of Service: A

Approach:	North Bound			South Bound			East Bound			West Bound		
Movement:	L	T	R	L	T	R	L	T	R	L	T	R
Control:	Prot+Permit			Prot+Permit			Permitted			Permitted		
Rights:	Include			Include			Include			Include		
Min. Green:	0	0	0	0	0	0	0	0	0	0	0	0
Y+R:	4.0	4.0	4.0	4.0	4.0	4.0	4.0	4.0	4.0	4.0	4.0	4.0
Lanes:	1	0	1	1	0	1	0	0	1	1	0	0

Volume Module:

Base Vol:	102	1129	44	45	954	114	33	66	40	8	51	15
Growth Adj:	1.00	1.00	1.00	1.00	1.00	1.00	1.00	1.00	1.00	1.00	1.00	1.00
Initial Bse:	102	1129	44	45	954	114	33	66	40	8	51	15
User Adj:	1.00	1.00	1.00	1.00	1.00	1.00	1.00	1.00	1.00	1.00	1.00	1.00
PHF Adj:	1.00	1.00	1.00	1.00	1.00	1.00	1.00	1.00	1.00	1.00	1.00	1.00
PHF Volume:	102	1129	44	45	954	114	33	66	40	8	51	15
Reduct Vol:	0	0	0	0	0	0	0	0	0	0	0	0
Reduced Vol:	102	1129	44	45	954	114	33	66	40	8	51	15
PCE Adj:	1.00	1.00	1.00	1.00	1.00	1.00	1.00	1.00	1.00	1.00	1.00	1.00
MLF Adj:	1.00	1.00	1.00	1.00	1.00	1.00	1.00	1.00	1.00	1.00	1.00	1.00
FinalVolume:	102	1129	44	45	954	114	33	66	40	8	51	15

Saturation Flow Module:

Sat/Lane:	1600	1600	1600	1600	1600	1600	1600	1600	1600	1600	1600	1600
Adjustment:	1.00	1.03	1.00	1.00	1.03	1.00	1.00	1.00	1.00	1.00	1.00	1.00
Lanes:	1.00	1.92	0.08	1.00	1.79	0.21	1.00	0.62	0.38	1.00	0.77	0.23
Final Sat.:	1600	3180	120	1600	2958	342	1600	996	604	1600	1236	364

Capacity Analysis Module:

Vol/Sat:	0.06	0.36	0.37	0.03	0.32	0.33	0.02	0.07	0.07	0.01	0.04	0.04
Crit Moves:			****	****			****			****		

Santa Ana Circulation Element

Level Of Service Computation Report

ICU 1(Loss as Cycle Length %) Method (Base Volume Alternative)

Intersection #5 Newhope St and McFadden Ave

Cycle (sec): 100 Critical Vol./Cap.(X): 0.684
Loss Time (sec): 5 Average Delay (sec/veh): xxxxxx
Optimal Cycle: 36 Level Of Service: B

Table with 4 columns: North Bound, South Bound, East Bound, West Bound. Rows include Movement, Control, Rights, Min. Green, Y+R, and Lanes.

Volume Module table with 12 columns representing different traffic volumes and adjustment factors.

Saturation Flow Module table with 12 columns representing saturation flow rates and adjustments.

Capacity Analysis Module table with 12 columns representing volume-to-saturation ratios and critical moves.

Santa Ana Circulation Element

Level Of Service Computation Report
 2000 HCM Operations Method (Base Volume Alternative)

 Intersection #6 Harbor Blvd and SR-22 WB Off-Ramp / Banner Dr

Cycle (sec): 100 Critical Vol./Cap.(X): 0.769
 Loss Time (sec): 5 Average Delay (sec/veh): 23.8
 Optimal Cycle: 48 Level Of Service: C

Approach:	North Bound			South Bound			East Bound			West Bound		
Movement:	L	T	R	L	T	R	L	T	R	L	T	R
Control:	Protected			Protected			Split Phase			Split Phase		
Rights:	Include			Include			Include			Include		
Min. Green:	0	0	0	0	0	0	0	0	0	0	0	0
Y+R:	4.0	4.0	4.0	4.0	4.0	4.0	4.0	4.0	4.0	4.0	4.0	4.0
Lanes:	1	0	3	0	0	2	1	0	0	1	1	0

Volume Module:

Base Vol:	103	2324	0	0	1823	59	102	0	86	558	75	160
Growth Adj:	1.00	1.00	1.00	1.00	1.00	1.00	1.00	1.00	1.00	1.00	1.00	1.00
Initial Bse:	103	2324	0	0	1823	59	102	0	86	558	75	160
User Adj:	1.00	1.00	1.00	1.00	1.00	1.00	1.00	1.00	1.00	1.00	1.00	1.00
PHF Adj:	1.00	1.00	1.00	1.00	1.00	1.00	1.00	1.00	1.00	1.00	1.00	1.00
PHF Volume:	103	2324	0	0	1823	59	102	0	86	558	75	160
Reduct Vol:	0	0	0	0	0	0	0	0	0	0	0	0
Reduced Vol:	103	2324	0	0	1823	59	102	0	86	558	75	160
PCE Adj:	1.00	1.00	1.00	1.00	1.00	1.00	1.00	1.00	1.00	1.00	1.00	1.00
MLF Adj:	1.00	1.00	1.00	1.00	1.00	1.00	1.00	1.00	1.00	1.00	1.00	1.00
FinalVolume:	103	2324	0	0	1823	59	102	0	86	558	75	160

Saturation Flow Module:

Sat/Lane:	1900	1900	1900	1900	1900	1900	1900	1900	1900	1900	1900	1900
Adjustment:	0.95	0.91	1.00	1.00	0.91	0.91	0.91	1.00	0.91	0.96	0.96	0.85
Lanes:	1.00	3.00	0.00	0.00	2.91	0.09	0.54	0.00	0.46	1.76	0.24	1.00
Final Sat.:	1805	5187	0	0	4999	162	942	0	794	3209	431	1615

Capacity Analysis Module:

Vol/Sat:	0.06	0.45	0.00	0.00	0.36	0.36	0.11	0.00	0.11	0.17	0.17	0.10
Crit Moves:	****			****			****			****		
Green/Cycle:	0.08	0.58	0.00	0.00	0.50	0.50	0.14	0.00	0.14	0.23	0.23	0.23
Volume/Cap:	0.72	0.77	0.00	0.00	0.72	0.72	0.77	0.00	0.77	0.77	0.77	0.44
Delay/Veh:	61.7	17.0	0.0	0.0	20.4	20.4	55.1	0.0	55.1	40.7	40.7	34.1
User DelAdj:	1.00	1.00	1.00	1.00	1.00	1.00	1.00	1.00	1.00	1.00	1.00	1.00
AdjDel/Veh:	61.7	17.0	0.0	0.0	20.4	20.4	55.1	0.0	55.1	40.7	40.7	34.1
LOS by Move:	E	B	A	A	C	C	E	A	E	D	D	C
HCM2k85thQ:	7	30	0	0	26	26	11	0	11	17	17	7

 Note: Queue reported is the number of cars per lane.

Santa Ana Circulation Element

Level Of Service Computation Report
 2000 HCM Operations Method (Base Volume Alternative)

 Intersection #7 Trask Avenue and SR-22 EB On-Ramp

Cycle (sec): 100 Critical Vol./Cap.(X): 0.381
 Loss Time (sec): 5 Average Delay (sec/veh): 11.0
 Optimal Cycle: 20 Level Of Service: B

Approach:	North Bound			South Bound			East Bound			West Bound		
Movement:	L	T	R	L	T	R	L	T	R	L	T	R
Control:	Protected			Protected			Protected			Protected		
Rights:	Include			Include			Include			Include		
Min. Green:	0	0	0	0	0	0	0	0	0	0	0	0
Y+R:	4.0	4.0	4.0	4.0	4.0	4.0	4.0	4.0	4.0	4.0	4.0	4.0
Lanes:	0	0	0	0	0	0	2	0	1	0	0	1

Volume Module:

Base Vol:	0	0	0	0	0	0	785	588	0	0	449	42
Growth Adj:	1.00	1.00	1.00	1.00	1.00	1.00	1.00	1.00	1.00	1.00	1.00	1.00
Initial Bse:	0	0	0	0	0	0	785	588	0	0	449	42
User Adj:	1.00	1.00	1.00	1.00	1.00	1.00	1.00	1.00	1.00	1.00	1.00	1.00
PHF Adj:	1.00	1.00	1.00	1.00	1.00	1.00	1.00	1.00	1.00	1.00	1.00	1.00
PHF Volume:	0	0	0	0	0	0	785	588	0	0	449	42
Reduct Vol:	0	0	0	0	0	0	0	0	0	0	0	0
Reduced Vol:	0	0	0	0	0	0	785	588	0	0	449	42
PCE Adj:	1.00	1.00	1.00	1.00	1.00	1.00	1.00	1.00	1.00	1.00	1.00	1.00
MLF Adj:	1.00	1.00	1.00	1.00	1.00	1.00	1.00	1.00	1.00	1.00	1.00	1.00
FinalVolume:	0	0	0	0	0	0	785	588	0	0	449	42

Saturation Flow Module:

Sat/Lane:	1900	1900	1900	1900	1900	1900	1900	1900	1900	1900	1900	1900
Adjustment:	1.00	1.00	1.00	1.00	1.00	1.00	0.92	1.00	1.00	1.00	0.94	0.94
Lanes:	0.00	0.00	0.00	0.00	0.00	0.00	2.00	1.00	0.00	0.00	1.83	0.17
Final Sat.:	0	0	0	0	0	0	3502	1900	0	0	3258	305

Capacity Analysis Module:

Vol/Sat:	0.00	0.00	0.00	0.00	0.00	0.00	0.22	0.31	0.00	0.00	0.14	0.14	
Crit Moves:							****	****					
Green/Cycle:	0.00	0.00	0.00	0.00	0.00	0.00	0.59	0.95	0.00	0.00	0.36	0.36	
Volume/Cap:	0.00	0.00	0.00	0.00	0.00	0.00	0.38	0.33	0.00	0.00	0.38	0.38	
Delay/Veh:	0.0	0.0	0.0	0.0	0.0	0.0	11.0	0.3	0.0	0.0	23.8	23.8	
User DelAdj:	1.00	1.00	1.00	1.00	1.00	1.00	1.00	1.00	1.00	1.00	1.00	1.00	
AdjDel/Veh:	0.0	0.0	0.0	0.0	0.0	0.0	11.0	0.3	0.0	0.0	23.8	23.8	
LOS by Move:	A	A	A	A	A	A	B	A	A	A	C	C	
HCM2k85thQ:	0	0	0	0	0	0	10	3	0	0	9	9	

 Note: Queue reported is the number of cars per lane.

Santa Ana Circulation Element

Level Of Service Computation Report

ICU 1(Loss as Cycle Length %) Method (Base Volume Alternative)

Intersection #8 Harbor Blvd and Westminster Ave

Cycle (sec): 100 Critical Vol./Cap.(X): 0.842
Loss Time (sec): 0 Average Delay (sec/veh): xxxxxx
Optimal Cycle: 145 Level Of Service: D

Table with 4 columns: North Bound, South Bound, East Bound, West Bound. Rows include Movement (L-T-R), Control, Rights, Min. Green, Y+R, and Lanes.

Volume Module: Table with 12 columns representing traffic volumes and 10 rows for various adjustment factors like Growth Adj, Initial Bse, User Adj, etc.

Saturation Flow Module: Table with 12 columns for saturation flow and 4 rows for Sat/Lane, Adjustment, Lanes, and Final Sat.

Capacity Analysis Module: Table with 12 columns for capacity analysis and 3 rows for Vol/Sat, Crit Moves, and asterisks.

Santa Ana Circulation Element

Level Of Service Computation Report

ICU 1(Loss as Cycle Length %) Method (Base Volume Alternative)

Intersection #9 Harbor Blvd and 1st St

Cycle (sec): 100 Critical Vol./Cap.(X): 0.753
 Loss Time (sec): 5 Average Delay (sec/veh): xxxxxx
 Optimal Cycle: 44 Level Of Service: C

Approach:	North Bound			South Bound			East Bound			West Bound		
Movement:	L	T	R	L	T	R	L	T	R	L	T	R
Control:	Protected			Protected			Protected			Protected		
Rights:	Include			Include			Include			Include		
Min. Green:	0	0	0	0	0	0	0	0	0	0	0	0
Y+R:	4.0	4.0	4.0	4.0	4.0	4.0	4.0	4.0	4.0	4.0	4.0	4.0
Lanes:	1	0	3	0	1	1	2	0	2	1	0	2

Volume Module:

Base Vol:	280	1446	160	240	1053	142	192	784	148	185	865	141
Growth Adj:	1.00	1.00	1.00	1.00	1.00	1.00	1.00	1.00	1.00	1.00	1.00	1.00
Initial Bse:	280	1446	160	240	1053	142	192	784	148	185	865	141
User Adj:	1.00	1.00	1.00	1.00	1.00	1.00	1.00	1.00	1.00	1.00	1.00	1.00
PHF Adj:	1.00	1.00	1.00	1.00	1.00	1.00	1.00	1.00	1.00	1.00	1.00	1.00
PHF Volume:	280	1446	160	240	1053	142	192	784	148	185	865	141
Reduct Vol:	0	0	0	0	0	0	0	0	0	0	0	0
Reduced Vol:	280	1446	160	240	1053	142	192	784	148	185	865	141
PCE Adj:	1.00	1.00	1.00	1.00	1.00	1.00	1.00	1.00	1.00	1.00	1.00	1.00
MLF Adj:	1.00	1.00	1.00	1.00	1.00	1.00	1.00	1.00	1.00	1.00	1.00	1.00
FinalVolume:	280	1446	160	240	1053	142	192	784	148	185	865	141

Saturation Flow Module:

Sat/Lane:	1600	1600	1600	1600	1600	1600	1600	1600	1600	1600	1600	1600
Adjustment:	1.00	1.06	1.00	1.00	1.06	1.00	1.00	1.05	1.00	1.00	1.05	1.00
Lanes:	1.00	3.00	1.00	1.00	3.00	1.00	2.00	2.52	0.48	2.00	2.58	0.42
Final Sat.:	1600	5100	1600	1600	5100	1600	3200	4238	762	3200	4327	673

Capacity Analysis Module:

Vol/Sat:	0.17	0.28	0.10	0.15	0.21	0.09	0.06	0.19	0.19	0.06	0.20	0.21
Crit Moves:	****			****			****			****		

Santa Ana Circulation Element

Level Of Service Computation Report

ICU 1(Loss as Cycle Length %) Method (Base Volume Alternative)

Intersection #10 Harbor Blvd and McFadden Ave

Cycle (sec): 100 Critical Vol./Cap.(X): 0.711
 Loss Time (sec): 5 Average Delay (sec/veh): xxxxxx
 Optimal Cycle: 38 Level Of Service: C

Approach:	North Bound			South Bound			East Bound			West Bound		
Movement:	L	T	R	L	T	R	L	T	R	L	T	R
Control:	Protected			Protected			Protected			Protected		
Rights:	Include			Include			Include			Include		
Min. Green:	0	0	0	0	0	0	0	0	0	0	0	0
Y+R:	4.0	4.0	4.0	4.0	4.0	4.0	4.0	4.0	4.0	4.0	4.0	4.0
Lanes:	2	0	3	0	1	0	2	0	2	1	0	1

Volume Module:

Base Vol:	182	1866	136	261	1114	101	147	358	45	63	151	43
Growth Adj:	1.00	1.00	1.00	1.00	1.00	1.00	1.00	1.00	1.00	1.00	1.00	1.00
Initial Bse:	182	1866	136	261	1114	101	147	358	45	63	151	43
User Adj:	1.00	1.00	1.00	1.00	1.00	1.00	1.00	1.00	1.00	1.00	1.00	1.00
PHF Adj:	1.00	1.00	1.00	1.00	1.00	1.00	1.00	1.00	1.00	1.00	1.00	1.00
PHF Volume:	182	1866	136	261	1114	101	147	358	45	63	151	43
Reduct Vol:	0	0	0	0	0	0	0	0	0	0	0	0
Reduced Vol:	182	1866	136	261	1114	101	147	358	45	63	151	43
PCE Adj:	1.00	1.00	1.00	1.00	1.00	1.00	1.00	1.00	1.00	1.00	1.00	1.00
MLF Adj:	1.00	1.00	1.00	1.00	1.00	1.00	1.00	1.00	1.00	1.00	1.00	1.00
FinalVolume:	182	1866	136	261	1114	101	147	358	45	63	151	43

Saturation Flow Module:

Sat/Lane:	1600	1600	1600	1600	1600	1600	1600	1600	1600	1600	1600	1600
Adjustment:	1.00	1.06	1.00	1.00	1.05	1.00	1.00	1.04	1.00	1.00	1.00	1.00
Lanes:	2.00	3.00	1.00	2.00	2.75	0.25	1.00	1.78	0.22	1.00	0.78	0.22
Final Sat.:	3200	5100	1600	3200	4601	399	1600	2943	357	1600	1245	355

Capacity Analysis Module:

Vol/Sat:	0.06	0.37	0.09	0.08	0.24	0.25	0.09	0.12	0.13	0.04	0.12	0.12
Crit Moves:	****			****			****			****		

Santa Ana Circulation Element

Level Of Service Computation Report

ICU 1(Loss as Cycle Length %) Method (Base Volume Alternative)

Intersection #11 Harbor Blvd and Edinger Ave

Cycle (sec): 100 Critical Vol./Cap.(X): 0.722
 Loss Time (sec): 5 Average Delay (sec/veh): xxxxxx
 Optimal Cycle: 40 Level Of Service: C

Approach:	North Bound			South Bound			East Bound			West Bound		
Movement:	L	T	R	L	T	R	L	T	R	L	T	R
Control:	Protected			Protected			Protected			Protected		
Rights:	Include			Include			Include			Include		
Min. Green:	0	0	0	0	0	0	0	0	0	0	0	0
Y+R:	4.0	4.0	4.0	4.0	4.0	4.0	4.0	4.0	4.0	4.0	4.0	4.0
Lanes:	2	0	3	0	1		2	0	3	0	1	

Volume Module:

Base Vol:	262	1645	199	283	822	75	109	460	81	188	1089	363
Growth Adj:	1.00	1.00	1.00	1.00	1.00	1.00	1.00	1.00	1.00	1.00	1.00	1.00
Initial Bse:	262	1645	199	283	822	75	109	460	81	188	1089	363
User Adj:	1.00	1.00	1.00	1.00	1.00	1.00	1.00	1.00	1.00	1.00	1.00	1.00
PHF Adj:	1.00	1.00	1.00	1.00	1.00	1.00	1.00	1.00	1.00	1.00	1.00	1.00
PHF Volume:	262	1645	199	283	822	75	109	460	81	188	1089	363
Reduct Vol:	0	0	0	0	0	0	0	0	0	0	0	0
Reduced Vol:	262	1645	199	283	822	75	109	460	81	188	1089	363
PCE Adj:	1.00	1.00	1.00	1.00	1.00	1.00	1.00	1.00	1.00	1.00	1.00	1.00
MLF Adj:	1.00	1.00	1.00	1.00	1.00	1.00	1.00	1.00	1.00	1.00	1.00	1.00
FinalVolume:	262	1645	199	283	822	75	109	460	81	188	1089	363

Saturation Flow Module:

Sat/Lane:	1600	1600	1600	1600	1600	1600	1600	1600	1600	1600	1600	1600
Adjustment:	1.00	1.06	1.00	1.00	1.06	1.00	1.00	1.05	1.00	1.00	1.06	1.00
Lanes:	2.00	3.00	1.00	2.00	3.00	1.00	2.00	2.55	0.45	2.00	3.00	1.00
Final Sat.:	3200	5100	1600	3200	5100	1600	3200	4281	719	3200	5100	1600

Capacity Analysis Module:

Vol/Sat:	0.08	0.32	0.12	0.09	0.16	0.05	0.03	0.11	0.11	0.06	0.21	0.23
Crit Moves:	****			****			****			****		

Santa Ana Circulation Element

Level Of Service Computation Report

ICU 1(Loss as Cycle Length %) Method (Base Volume Alternative)

Intersection #12 Harbor Blvd and Warner Ave

Cycle (sec): 100 Critical Vol./Cap.(X): 1.539
 Loss Time (sec): 5 Average Delay (sec/veh): xxxxxx
 Optimal Cycle: 180 Level Of Service: F

Approach:	North Bound			South Bound			East Bound			West Bound		
Movement:	L	T	R	L	T	R	L	T	R	L	T	R
Control:	Protected			Protected			Protected			Protected		
Rights:	Include			Include			Include			Include		
Min. Green:	0	0	0	0	0	0	0	0	0	0	0	0
Y+R:	4.0	4.0	4.0	4.0	4.0	4.0	4.0	4.0	4.0	4.0	4.0	4.0
Lanes:	2	0	2	1	0	0	2	0	3	0	1	0

Volume Module:

Base Vol:	768	3685	277	250	1389	166	198	1399	320	253	2626	838
Growth Adj:	1.00	1.00	1.00	1.00	1.00	1.00	1.00	1.00	1.00	1.00	1.00	1.00
Initial Bse:	768	3685	277	250	1389	166	198	1399	320	253	2626	838
User Adj:	1.00	1.00	1.00	1.00	1.00	1.00	1.00	1.00	1.00	1.00	1.00	1.00
PHF Adj:	1.00	1.00	1.00	1.00	1.00	1.00	1.00	1.00	1.00	1.00	1.00	1.00
PHF Volume:	768	3685	277	250	1389	166	198	1399	320	253	2626	838
Reduct Vol:	0	0	0	0	0	0	0	0	0	0	0	0
Reduced Vol:	768	3685	277	250	1389	166	198	1399	320	253	2626	838
PCE Adj:	1.00	1.00	1.00	1.00	1.00	1.00	1.00	1.00	1.00	1.00	1.00	1.00
MLF Adj:	1.00	1.00	1.00	1.00	1.00	1.00	1.00	1.00	1.00	1.00	1.00	1.00
Final Volume:	768	3685	277	250	1389	166	198	1399	320	253	2626	838

Saturation Flow Module:

Sat/Lane:	1600	1600	1600	1600	1600	1600	1600	1600	1600	1600	1600	1600
Adjustment:	1.00	1.04	1.00	1.00	1.06	1.00	1.00	1.06	1.00	1.00	1.06	1.00
Lanes:	2.00	2.79	0.21	2.00	3.00	1.00	2.00	3.00	1.00	2.00	3.00	1.00
Final Sat.:	3200	4664	336	3200	5100	1600	3200	5100	1600	3200	5100	1600

Capacity Analysis Module:

Vol/Sat:	0.24	0.79	0.83	0.08	0.27	0.10	0.06	0.27	0.20	0.08	0.51	0.52
Crit Moves:			****	****			****				****	

Santa Ana Circulation Element

Level Of Service Computation Report

ICU 1(Loss as Cycle Length %) Method (Base Volume Alternative)

Intersection #13 Harbor Blvd and Segerstrom Ave

Cycle (sec): 100 Critical Vol./Cap.(X): 0.934
 Loss Time (sec): 5 Average Delay (sec/veh): xxxxxx
 Optimal Cycle: 113 Level Of Service: E

Approach:	North Bound			South Bound			East Bound			West Bound		
Movement:	L	T	R	L	T	R	L	T	R	L	T	R
Control:	Protected			Protected			Prot+Permit			Prot+Permit		
Rights:	Include			Include			Include			Include		
Min. Green:	0	0	0	0	0	0	0	0	0	0	0	0
Y+R:	4.0	4.0	4.0	4.0	4.0	4.0	4.0	4.0	4.0	4.0	4.0	4.0
Lanes:	2	0	2	1	0	2	1	0	1	1	0	2

Volume Module:

Base Vol:	275	1732	55	86	973	86	118	585	192	121	1308	475
Growth Adj:	1.00	1.00	1.00	1.00	1.00	1.00	1.00	1.00	1.00	1.00	1.00	1.00
Initial Bse:	275	1732	55	86	973	86	118	585	192	121	1308	475
User Adj:	1.00	1.00	1.00	1.00	1.00	1.00	1.00	1.00	1.00	1.00	1.00	1.00
PHF Adj:	1.00	1.00	1.00	1.00	1.00	1.00	1.00	1.00	1.00	1.00	1.00	1.00
PHF Volume:	275	1732	55	86	973	86	118	585	192	121	1308	475
Reduct Vol:	0	0	0	0	0	0	0	0	0	0	0	0
Reduced Vol:	275	1732	55	86	973	86	118	585	192	121	1308	475
PCE Adj:	1.00	1.00	1.00	1.00	1.00	1.00	1.00	1.00	1.00	1.00	1.00	1.00
MLF Adj:	1.00	1.00	1.00	1.00	1.00	1.00	1.00	1.00	1.00	1.00	1.00	1.00
Final Volume:	275	1732	55	86	973	86	118	585	192	121	1308	475

Saturation Flow Module:

Sat/Lane:	1600	1600	1600	1600	1600	1600	1600	1600	1600	1600	1600	1600
Adjustment:	1.00	1.04	1.00	1.00	1.05	1.00	1.00	1.04	1.00	1.00	1.06	1.00
Lanes:	2.00	2.91	0.09	1.00	2.76	0.24	1.00	1.51	0.49	1.00	2.00	1.00
Final Sat.:	3200	4852	148	1600	4610	390	1600	2509	791	1600	3400	1600

Capacity Analysis Module:

Vol/Sat:	0.09	0.36	0.37	0.05	0.21	0.22	0.07	0.23	0.24	0.08	0.38	0.30
Crit Moves:			****	****			****			****		

Santa Ana Circulation Element

Level Of Service Computation Report

ICU 1(Loss as Cycle Length %) Method (Base Volume Alternative)

Intersection #14 MacArthur Blvd and Hyland Ave

Cycle (sec): 100 Critical Vol./Cap.(X): 0.891
 Loss Time (sec): 5 Average Delay (sec/veh): xxxxxx
 Optimal Cycle: 82 Level Of Service: D

Approach:	North Bound			South Bound			East Bound			West Bound		
Movement:	L	T	R	L	T	R	L	T	R	L	T	R
Control:	Protected			Protected			Prot+Permit			Prot+Permit		
Rights:	Include			Include			Include			Include		
Min. Green:	0	0	0	0	0	0	0	0	0	0	0	0
Y+R:	4.0	4.0	4.0	4.0	4.0	4.0	4.0	4.0	4.0	4.0	4.0	4.0
Lanes:	2	0	0	1	0	1	3	0	1	1	0	3

Volume Module:

Base Vol:	1139	7	66	12	4	14	35	869	156	25	2320	12
Growth Adj:	1.00	1.00	1.00	1.00	1.00	1.00	1.00	1.00	1.00	1.00	1.00	1.00
Initial Bse:	1139	7	66	12	4	14	35	869	156	25	2320	12
User Adj:	1.00	1.00	1.00	1.00	1.00	1.00	1.00	1.00	1.00	1.00	1.00	1.00
PHF Adj:	1.00	1.00	1.00	1.00	1.00	1.00	1.00	1.00	1.00	1.00	1.00	1.00
PHF Volume:	1139	7	66	12	4	14	35	869	156	25	2320	12
Reduct Vol:	0	0	0	0	0	0	0	0	0	0	0	0
Reduced Vol:	1139	7	66	12	4	14	35	869	156	25	2320	12
PCE Adj:	1.00	1.00	1.00	1.00	1.00	1.00	1.00	1.00	1.00	1.00	1.00	1.00
MLF Adj:	1.00	1.00	1.00	1.00	1.00	1.00	1.00	1.00	1.00	1.00	1.00	1.00
FinalVolume:	1139	7	66	12	4	14	35	869	156	25	2320	12

Saturation Flow Module:

Sat/Lane:	1600	1600	1600	1600	1600	1600	1600	1600	1600	1600	1600	1600
Adjustment:	1.00	1.00	1.00	1.00	1.06	1.00	1.00	1.06	1.00	1.00	1.06	1.00
Lanes:	2.00	0.10	0.90	1.00	1.00	1.00	1.00	3.00	1.00	1.00	3.00	1.00
Final Sat.:	3200	153	1447	1600	1700	1600	1600	5100	1600	1600	5100	1600

Capacity Analysis Module:

Vol/Sat:	0.36	0.05	0.05	0.01	0.00	0.01	0.02	0.17	0.10	0.02	0.45	0.01
Crit Moves:	****					****	****				****	

Santa Ana Circulation Element

Level Of Service Computation Report

ICU 1(Loss as Cycle Length %) Method (Base Volume Alternative)

Intersection #15 MacArthur Blvd and Harbor Blvd

Cycle (sec): 100 Critical Vol./Cap.(X): 0.788
 Loss Time (sec): 5 Average Delay (sec/veh): xxxxxx
 Optimal Cycle: 50 Level Of Service: C

Approach:	North Bound			South Bound			East Bound			West Bound		
Movement:	L	T	R	L	T	R	L	T	R	L	T	R
Control:	Protected			Protected			Protected			Protected		
Rights:	Include			Include			Include			Include		
Min. Green:	0	0	0	0	0	0	0	0	0	0	0	0
Y+R:	4.0	4.0	4.0	4.0	4.0	4.0	4.0	4.0	4.0	4.0	4.0	4.0
Lanes:	2	0	3	0	1		2	0	3	0	1	

Volume Module:

Base Vol:	527	1362	79	206	1039	170	143	501	185	85	1429	269
Growth Adj:	1.00	1.00	1.00	1.00	1.00	1.00	1.00	1.00	1.00	1.00	1.00	1.00
Initial Bse:	527	1362	79	206	1039	170	143	501	185	85	1429	269
User Adj:	1.00	1.00	1.00	1.00	1.00	1.00	1.00	1.00	1.00	1.00	1.00	1.00
PHF Adj:	1.00	1.00	1.00	1.00	1.00	1.00	1.00	1.00	1.00	1.00	1.00	1.00
PHF Volume:	527	1362	79	206	1039	170	143	501	185	85	1429	269
Reduct Vol:	0	0	0	0	0	0	0	0	0	0	0	0
Reduced Vol:	527	1362	79	206	1039	170	143	501	185	85	1429	269
PCE Adj:	1.00	1.00	1.00	1.00	1.00	1.00	1.00	1.00	1.00	1.00	1.00	1.00
MLF Adj:	1.00	1.00	1.00	1.00	1.00	1.00	1.00	1.00	1.00	1.00	1.00	1.00
FinalVolume:	527	1362	79	206	1039	170	143	501	185	85	1429	269

Saturation Flow Module:

Sat/Lane:	1600	1600	1600	1600	1600	1600	1600	1600	1600	1600	1600	1600
Adjustment:	1.00	1.06	1.00	1.00	1.06	1.00	1.00	1.06	1.00	1.00	1.06	1.00
Lanes:	2.00	3.00	1.00	2.00	3.00	1.00	1.00	3.00	1.00	1.00	3.00	1.00
Final Sat.:	3200	5100	1600	3200	5100	1600	1600	5100	1600	1600	5100	1600

Capacity Analysis Module:

Vol/Sat:	0.16	0.27	0.05	0.06	0.20	0.11	0.09	0.10	0.12	0.05	0.28	0.17
Crit Moves:	****				****		****				****	

Santa Ana Circulation Element

Level Of Service Computation Report

ICU 1(Loss as Cycle Length %) Method (Base Volume Alternative)

Intersection #16 Harbor Blvd and Sunflower Ave

Cycle (sec): 100 Critical Vol./Cap.(X): 0.711
 Loss Time (sec): 5 Average Delay (sec/veh): xxxxxx
 Optimal Cycle: 38 Level Of Service: C

Approach:	North Bound			South Bound			East Bound			West Bound		
Movement:	L	T	R	L	T	R	L	T	R	L	T	R
Control:	Protected			Protected			Protected			Protected		
Rights:	Include			Include			Include			Include		
Min. Green:	0	0	0	0	0	0	0	0	0	0	0	0
Y+R:	4.0	4.0	4.0	4.0	4.0	4.0	4.0	4.0	4.0	4.0	4.0	4.0
Lanes:	2	0	3	0	1		2	0	3	0	1	

Volume Module:

Base Vol:	156	1552	230	118	1464	44	85	230	239	282	592	221
Growth Adj:	1.00	1.00	1.00	1.00	1.00	1.00	1.00	1.00	1.00	1.00	1.00	1.00
Initial Bse:	156	1552	230	118	1464	44	85	230	239	282	592	221
User Adj:	1.00	1.00	1.00	1.00	1.00	1.00	1.00	1.00	1.00	1.00	1.00	1.00
PHF Adj:	1.00	1.00	1.00	1.00	1.00	1.00	1.00	1.00	1.00	1.00	1.00	1.00
PHF Volume:	156	1552	230	118	1464	44	85	230	239	282	592	221
Reduct Vol:	0	0	0	0	0	0	0	0	0	0	0	0
Reduced Vol:	156	1552	230	118	1464	44	85	230	239	282	592	221
PCE Adj:	1.00	1.00	1.00	1.00	1.00	1.00	1.00	1.00	1.00	1.00	1.00	1.00
MLF Adj:	1.00	1.00	1.00	1.00	1.00	1.00	1.00	1.00	1.00	1.00	1.00	1.00
FinalVolume:	156	1552	230	118	1464	44	85	230	239	282	592	221

Saturation Flow Module:

Sat/Lane:	1600	1600	1600	1600	1600	1600	1600	1600	1600	1600	1600	1600
Adjustment:	1.00	1.06	1.00	1.00	1.06	1.00	1.00	1.06	1.00	1.00	1.04	1.00
Lanes:	2.00	3.00	1.00	2.00	3.00	1.00	1.00	1.00	1.00	1.00	1.39	0.61
Final Sat.:	3200	5100	1600	3200	5100	1600	1600	1700	1600	1600	2322	974

Capacity Analysis Module:

Vol/Sat:	0.05	0.30	0.14	0.04	0.29	0.03	0.05	0.14	0.15	0.18	0.25	0.23
Crit Moves:	****			****			****		****	****		

Santa Ana Circulation Element

Level Of Service Computation Report
 2000 HCM Operations Method (Base Volume Alternative)

 Intersection #17 Harbor Blvd and I-405 NB Off-Ramp

Cycle (sec): 100 Critical Vol./Cap.(X): 0.710
 Loss Time (sec): 5 Average Delay (sec/veh): 18.8
 Optimal Cycle: 40 Level Of Service: B

Approach:	North Bound			South Bound			East Bound			West Bound		
Movement:	L	T	R	L	T	R	L	T	R	L	T	R
Control:	Protected			Protected			Split Phase			Split Phase		
Rights:	Include			Include			Include			Include		
Min. Green:	0	0	0	0	0	0	0	0	0	0	0	0
Y+R:	4.0	4.0	4.0	4.0	4.0	4.0	4.0	4.0	4.0	4.0	4.0	4.0
Lanes:	0	0	4	0	0	4	0	0	0	1	0	1

Volume Module:

Base Vol:	0	1488	0	0	2570	0	0	0	0	513	0	828
Growth Adj:	1.00	1.00	1.00	1.00	1.00	1.00	1.00	1.00	1.00	1.00	1.00	1.00
Initial Bse:	0	1488	0	0	2570	0	0	0	0	513	0	828
User Adj:	1.00	1.00	1.00	1.00	1.00	1.00	1.00	1.00	1.00	1.00	1.00	1.00
PHF Adj:	1.00	1.00	1.00	1.00	1.00	1.00	1.00	1.00	1.00	1.00	1.00	1.00
PHF Volume:	0	1488	0	0	2570	0	0	0	0	513	0	828
Reduct Vol:	0	0	0	0	0	0	0	0	0	0	0	0
Reduced Vol:	0	1488	0	0	2570	0	0	0	0	513	0	828
PCE Adj:	1.00	1.00	1.00	1.00	1.00	1.00	1.00	1.00	1.00	1.00	1.00	1.00
MLF Adj:	1.00	1.00	1.00	1.00	1.00	1.00	1.00	1.00	1.00	1.00	1.00	1.00
FinalVolume:	0	1488	0	0	2570	0	0	0	0	513	0	828

Saturation Flow Module:

Sat/Lane:	1900	1900	1900	1900	1900	1900	1900	1900	1900	1900	1900	1900
Adjustment:	1.00	0.91	1.00	1.00	0.91	1.00	1.00	1.00	1.00	0.89	1.00	0.89
Lanes:	0.00	4.00	0.00	0.00	4.00	0.00	0.00	0.00	0.00	1.38	0.00	1.62
Final Sat.:	0	6916	0	0	6916	0	0	0	0	2337	0	2734

Capacity Analysis Module:

Vol/Sat:	0.00	0.22	0.00	0.00	0.37	0.00	0.00	0.00	0.00	0.22	0.00	0.30
Crit Moves:	****			****								****
Green/Cycle:	0.00	0.52	0.00	0.00	0.52	0.00	0.00	0.00	0.00	0.43	0.00	0.43
Volume/Cap:	0.00	0.41	0.00	0.00	0.71	0.00	0.00	0.00	0.00	0.51	0.00	0.71
Delay/Veh:	0.0	14.5	0.0	0.0	18.7	0.0	0.0	0.0	0.0	21.2	0.0	24.9
User DelAdj:	1.00	1.00	1.00	1.00	1.00	1.00	1.00	1.00	1.00	1.00	1.00	1.00
AdjDel/Veh:	0.0	14.5	0.0	0.0	18.7	0.0	0.0	0.0	0.0	21.2	0.0	24.9
LOS by Move:	A	B	A	A	B	A	A	A	A	C	A	C
HCM2k85thQ:	0	12	0	0	25	0	0	0	0	13	0	21

 Note: Queue reported is the number of cars per lane.

Santa Ana Circulation Element

Level Of Service Computation Report
 2000 HCM Operations Method (Base Volume Alternative)

 Intersection #18 Harbor Blvd and I-405 SB Off-Ramp

Cycle (sec): 100 Critical Vol./Cap.(X): 0.673
 Loss Time (sec): 5 Average Delay (sec/veh): 18.1
 Optimal Cycle: 36 Level Of Service: B

Approach:	North Bound			South Bound			East Bound			West Bound		
Movement:	L	T	R	L	T	R	L	T	R	L	T	R
Control:	Protected			Protected			Split Phase			Split Phase		
Rights:	Ignore			Include			Include			Include		
Min. Green:	0	0	0	0	0	0	0	0	0	0	0	0
Y+R:	4.0	4.0	4.0	4.0	4.0	4.0	4.0	4.0	4.0	4.0	4.0	4.0
Lanes:	0	0	3	0	0	4	1	0	1	0	0	0

Volume Module:	North Bound			South Bound			East Bound			West Bound		
Base Vol:	0	1881	0	0	2254	0	181	0	833	0	0	0
Growth Adj:	1.00	1.00	1.00	1.00	1.00	1.00	1.00	1.00	1.00	1.00	1.00	1.00
Initial Bse:	0	1881	0	0	2254	0	181	0	833	0	0	0
User Adj:	1.00	1.00	0.00	1.00	1.00	1.00	1.00	1.00	1.00	1.00	1.00	1.00
PHF Adj:	1.00	1.00	0.00	1.00	1.00	1.00	1.00	1.00	1.00	1.00	1.00	1.00
PHF Volume:	0	1881	0	0	2254	0	181	0	833	0	0	0
Reduct Vol:	0	0	0	0	0	0	0	0	0	0	0	0
Reduced Vol:	0	1881	0	0	2254	0	181	0	833	0	0	0
PCE Adj:	1.00	1.00	0.00	1.00	1.00	1.00	1.00	1.00	1.00	1.00	1.00	1.00
MLF Adj:	1.00	1.00	0.00	1.00	1.00	1.00	1.00	1.00	1.00	1.00	1.00	1.00
FinalVolume:	0	1881	0	0	2254	0	181	0	833	0	0	0

Saturation Flow Module:	North Bound			South Bound			East Bound			West Bound		
Sat/Lane:	1900	1900	1900	1900	1900	1900	1900	1900	1900	1900	1900	1900
Adjustment:	1.00	0.91	1.00	1.00	0.91	1.00	0.87	1.00	0.87	1.00	1.00	1.00
Lanes:	0.00	3.00	1.00	0.00	4.00	0.00	1.18	0.00	1.82	0.00	0.00	0.00
Final Sat.:	0	5187	1900	0	6916	0	1946	0	3008	0	0	0

Capacity Analysis Module:	North Bound			South Bound			East Bound			West Bound		
Vol/Sat:	0.00	0.36	0.00	0.00	0.33	0.00	0.09	0.00	0.28	0.00	0.00	0.00
Crit Moves:	****			****			****			****		
Green/Cycle:	0.00	0.54	0.00	0.00	0.54	0.00	0.41	0.00	0.41	0.00	0.00	0.00
Volume/Cap:	0.00	0.67	0.00	0.00	0.61	0.00	0.23	0.00	0.67	0.00	0.00	0.00
Delay/Veh:	0.0	17.4	0.0	0.0	16.1	0.0	19.1	0.0	25.2	0.0	0.0	0.0
User DelAdj:	1.00	1.00	1.00	1.00	1.00	1.00	1.00	1.00	1.00	1.00	1.00	1.00
AdjDel/Veh:	0.0	17.4	0.0	0.0	16.1	0.0	19.1	0.0	25.2	0.0	0.0	0.0
LOS by Move:	A	B	A	A	B	A	B	A	C	A	A	A
HCM2k85thQ:	0	23	0	0	20	0	5	0	18	0	0	0

 Note: Queue reported is the number of cars per lane.

Santa Ana Circulation Element

Level Of Service Computation Report

ICU 1(Loss as Cycle Length %) Method (Base Volume Alternative)

Intersection #19 Fairview St and Civic Center Dr

Cycle (sec): 100 Critical Vol./Cap.(X): 0.707
 Loss Time (sec): 5 Average Delay (sec/veh): xxxxxx
 Optimal Cycle: 38 Level Of Service: C

Approach:	North Bound			South Bound			East Bound			West Bound		
Movement:	L	T	R	L	T	R	L	T	R	L	T	R
Control:	Protected			Protected			Split Phase			Split Phase		
Rights:	WideBypass			Include			Include			Include		
Min. Green:	0	0	0	0	0	0	0	0	0	0	0	0
Y+R:	4.0	4.0	4.0	4.0	4.0	4.0	4.0	4.0	4.0	4.0	4.0	4.0
Lanes:	1	0	2	1	0	2	1	0	1	1	1	0

Volume Module:

Base Vol:	6	1777	499	205	1903	0	2	6	4	164	0	61
Growth Adj:	1.00	1.00	1.00	1.00	1.00	1.00	1.00	1.00	1.00	1.00	1.00	1.00
Initial Bse:	6	1777	499	205	1903	0	2	6	4	164	0	61
User Adj:	1.00	1.00	1.00	1.00	1.00	1.00	1.00	1.00	1.00	1.00	1.00	1.00
PHF Adj:	1.00	1.00	1.00	1.00	1.00	1.00	1.00	1.00	1.00	1.00	1.00	1.00
PHF Volume:	6	1777	499	205	1903	0	2	6	4	164	0	61
Reduct Vol:	0	0	0	0	0	0	0	0	0	0	0	0
Reduced Vol:	6	1777	499	205	1903	0	2	6	4	164	0	61
PCE Adj:	1.00	1.00	1.00	1.00	1.00	1.00	1.00	1.00	1.00	1.00	1.00	1.00
MLF Adj:	1.00	1.00	1.00	1.00	1.00	1.00	1.00	1.00	1.00	1.00	1.00	1.00
FinalVolume:	6	1777	499	205	1903	0	2	6	4	164	0	61

Saturation Flow Module:

Sat/Lane:	1600	1600	1600	1600	1600	1600	1600	1600	1600	1600	1600	1600
Adjustment:	1.00	1.05	1.00	1.00	1.04	1.00	1.00	1.00	1.00	1.00	1.06	1.00
Lanes:	1.00	2.34	0.66	1.00	3.00	0.00	0.33	1.00	0.67	2.00	0.00	1.00
Final Sat.:	1600	3948	1052	1600	5000	0	533	1600	1067	3200	0	1600

Capacity Analysis Module:

Vol/Sat:	0.00	0.45	0.47	0.13	0.38	0.00	0.00	0.00	0.00	0.05	0.00	0.04
Crit Moves:			****	****			****			****		

Santa Ana Circulation Element

Level Of Service Computation Report

ICU 1(Loss as Cycle Length %) Method (Base Volume Alternative)

Intersection #20 Fairview St and 1st St

Cycle (sec): 100 Critical Vol./Cap.(X): 0.894
 Loss Time (sec): 5 Average Delay (sec/veh): xxxxxx
 Optimal Cycle: 83 Level Of Service: D

Approach:	North Bound			South Bound			East Bound			West Bound		
Movement:	L	T	R	L	T	R	L	T	R	L	T	R
Control:	Protected			Protected			Protected			Protected		
Rights:	Include			Include			Include			Include		
Min. Green:	0	0	0	0	0	0	0	0	0	0	0	0
Y+R:	4.0	4.0	4.0	4.0	4.0	4.0	4.0	4.0	4.0	4.0	4.0	4.0
Lanes:	1	0	3	0	1	1	0	1	0	1	0	2

Volume Module:

Base Vol:	182	1339	121	236	1468	291	215	870	151	126	952	147
Growth Adj:	1.00	1.00	1.00	1.00	1.00	1.00	1.00	1.00	1.00	1.00	1.00	1.00
Initial Bse:	182	1339	121	236	1468	291	215	870	151	126	952	147
User Adj:	1.00	1.00	1.00	1.00	1.00	1.00	1.00	1.00	1.00	1.00	1.00	1.00
PHF Adj:	1.00	1.00	1.00	1.00	1.00	1.00	1.00	1.00	1.00	1.00	1.00	1.00
PHF Volume:	182	1339	121	236	1468	291	215	870	151	126	952	147
Reduct Vol:	0	0	0	0	0	0	0	0	0	0	0	0
Reduced Vol:	182	1339	121	236	1468	291	215	870	151	126	952	147
PCE Adj:	1.00	1.00	1.00	1.00	1.00	1.00	1.00	1.00	1.00	1.00	1.00	1.00
MLF Adj:	1.00	1.00	1.00	1.00	1.00	1.00	1.00	1.00	1.00	1.00	1.00	1.00
FinalVolume:	182	1339	121	236	1468	291	215	870	151	126	952	147

Saturation Flow Module:

Sat/Lane:	1600	1600	1600	1600	1600	1600	1600	1600	1600	1600	1600	1600
Adjustment:	1.00	1.06	1.00	1.00	1.05	1.00	1.00	1.05	1.00	1.00	1.05	1.00
Lanes:	1.00	3.00	1.00	1.00	2.50	0.50	1.00	2.56	0.44	1.00	2.60	0.40
Final Sat.:	1600	5100	1600	1600	4206	794	1600	4290	710	1600	4358	642

Capacity Analysis Module:

Vol/Sat:	0.11	0.26	0.08	0.15	0.35	0.37	0.13	0.20	0.21	0.08	0.22	0.23
Crit Moves:	****					****	****					****

Santa Ana Circulation Element

Level Of Service Computation Report

ICU 1(Loss as Cycle Length %) Method (Base Volume Alternative)

Intersection #21 Fairview St and McFadden Ave

Cycle (sec): 100 Critical Vol./Cap.(X): 0.684
Loss Time (sec): 5 Average Delay (sec/veh): xxxxxx
Optimal Cycle: 35 Level Of Service: B

Table with 4 columns: North Bound, South Bound, East Bound, West Bound. Rows include Movement, Control, Rights, Min. Green, Y+R, and Lanes.

Volume Module: Table with 12 columns representing different traffic volumes and adjustment factors.

Saturation Flow Module: Table with 12 columns representing saturation flow rates and adjustment factors.

Capacity Analysis Module: Table with 12 columns representing volume/saturation ratios and critical moves.

Santa Ana Circulation Element

Level Of Service Computation Report

ICU 1(Loss as Cycle Length %) Method (Base Volume Alternative)

Intersection #22 Fairview St and Edinger Ave

Cycle (sec): 100 Critical Vol./Cap.(X): 0.920
 Loss Time (sec): 5 Average Delay (sec/veh): xxxxxx
 Optimal Cycle: 100 Level Of Service: E

Approach:	North Bound			South Bound			East Bound			West Bound		
Movement:	L	T	R	L	T	R	L	T	R	L	T	R
Control:	Protected			Protected			Protected			Protected		
Rights:	Include			Include			Include			Include		
Min. Green:	0	0	0	0	0	0	0	0	0	0	0	0
Y+R:	4.0	4.0	4.0	4.0	4.0	4.0	4.0	4.0	4.0	4.0	4.0	4.0
Lanes:	2	0	2	1	0	0	2	0	2	1	0	0

Volume Module:

Base Vol:	190	1810	111	198	616	151	205	628	168	639	1353	297
Growth Adj:	1.00	1.00	1.00	1.00	1.00	1.00	1.00	1.00	1.00	1.00	1.00	1.00
Initial Bse:	190	1810	111	198	616	151	205	628	168	639	1353	297
User Adj:	1.00	1.00	1.00	1.00	1.00	1.00	1.00	1.00	1.00	1.00	1.00	1.00
PHF Adj:	1.00	1.00	1.00	1.00	1.00	1.00	1.00	1.00	1.00	1.00	1.00	1.00
PHF Volume:	190	1810	111	198	616	151	205	628	168	639	1353	297
Reduct Vol:	0	0	0	0	0	0	0	0	0	0	0	0
Reduced Vol:	190	1810	111	198	616	151	205	628	168	639	1353	297
PCE Adj:	1.00	1.00	1.00	1.00	1.00	1.00	1.00	1.00	1.00	1.00	1.00	1.00
MLF Adj:	1.00	1.00	1.00	1.00	1.00	1.00	1.00	1.00	1.00	1.00	1.00	1.00
Final Volume:	190	1810	111	198	616	151	205	628	168	639	1353	297

Saturation Flow Module:

Sat/Lane:	1600	1600	1600	1600	1600	1600	1600	1600	1600	1600	1600	1600
Adjustment:	1.00	1.04	1.00	1.00	1.05	1.00	1.00	1.05	1.00	1.00	1.05	1.00
Lanes:	2.00	2.83	0.17	2.00	2.41	0.59	2.00	2.37	0.63	2.00	2.46	0.54
Final Sat.:	3200	4723	277	3200	4055	945	3200	3987	1013	3200	4136	864

Capacity Analysis Module:

Vol/Sat:	0.06	0.38	0.40	0.06	0.15	0.16	0.06	0.16	0.17	0.20	0.33	0.34
Crit Moves:			****	****			****			****		

Santa Ana Circulation Element

Level Of Service Computation Report

ICU 1(Loss as Cycle Length %) Method (Base Volume Alternative)

Intersection #23 Fairview St and Warner Ave

Cycle (sec): 100 Critical Vol./Cap.(X): 0.805
 Loss Time (sec): 5 Average Delay (sec/veh): xxxxxx
 Optimal Cycle: 53 Level Of Service: D

Approach:	North Bound			South Bound			East Bound			West Bound		
Movement:	L	T	R	L	T	R	L	T	R	L	T	R
Control:	Protected			Protected			Protected			Protected		
Rights:	Include			Include			Include			Include		
Min. Green:	0	0	0	0	0	0	0	0	0	0	0	0
Y+R:	4.0	4.0	4.0	4.0	4.0	4.0	4.0	4.0	4.0	4.0	4.0	4.0
Lanes:	2	0	2	1	0	0	2	0	2	1	0	0

Volume Module:

Base Vol:	211	1679	156	179	906	92	163	792	123	178	1049	227
Growth Adj:	1.00	1.00	1.00	1.00	1.00	1.00	1.00	1.00	1.00	1.00	1.00	1.00
Initial Bse:	211	1679	156	179	906	92	163	792	123	178	1049	227
User Adj:	1.00	1.00	1.00	1.00	1.00	1.00	1.00	1.00	1.00	1.00	1.00	1.00
PHF Adj:	1.00	1.00	1.00	1.00	1.00	1.00	1.00	1.00	1.00	1.00	1.00	1.00
PHF Volume:	211	1679	156	179	906	92	163	792	123	178	1049	227
Reduct Vol:	0	0	0	0	0	0	0	0	0	0	0	0
Reduced Vol:	211	1679	156	179	906	92	163	792	123	178	1049	227
PCE Adj:	1.00	1.00	1.00	1.00	1.00	1.00	1.00	1.00	1.00	1.00	1.00	1.00
MLF Adj:	1.00	1.00	1.00	1.00	1.00	1.00	1.00	1.00	1.00	1.00	1.00	1.00
FinalVolume:	211	1679	156	179	906	92	163	792	123	178	1049	227

Saturation Flow Module:

Sat/Lane:	1600	1600	1600	1600	1600	1600	1600	1600	1600	1600	1600	1600
Adjustment:	1.00	1.05	1.00	1.00	1.05	1.00	1.00	1.05	1.00	1.00	1.05	1.00
Lanes:	2.00	2.74	0.26	2.00	2.72	0.28	2.00	2.60	0.40	2.00	2.47	0.53
Final Sat.:	3200	4592	408	3200	4558	442	3200	4355	645	3200	4146	854

Capacity Analysis Module:

Vol/Sat:	0.07	0.37	0.38	0.06	0.20	0.21	0.05	0.18	0.19	0.06	0.25	0.27
Crit Moves:			****	****			****			****		

Santa Ana Circulation Element

Level Of Service Computation Report

ICU 1(Loss as Cycle Length %) Method (Base Volume Alternative)

Intersection #24 Fairview St and MacArthur Blvd

Cycle (sec): 100 Critical Vol./Cap.(X): 0.761
Loss Time (sec): 5 Average Delay (sec/veh): xxxxxx
Optimal Cycle: 45 Level Of Service: C

Table with 4 columns: North Bound, South Bound, East Bound, West Bound. Rows include Movement (L-T-R), Control (Protected), Rights (Include), Min. Green, Y+R, and Lanes.

Volume Module table with 12 columns representing different traffic movements and 10 rows of adjustment factors like Growth Adj, PHF Adj, etc.

Saturation Flow Module table with 12 columns and 4 rows showing Sat/Lane, Adjustment, Lanes, and Final Sat.

Capacity Analysis Module table with 12 columns and 3 rows showing Vol/Sat, Crit Moves, and asterisks for critical moves.

Santa Ana Circulation Element

Level Of Service Computation Report

ICU 1(Loss as Cycle Length %) Method (Base Volume Alternative)

Intersection #25 Fairview Rd and Sunflower Ave

Cycle (sec): 100 Critical Vol./Cap.(X): 0.691
Loss Time (sec): 5 Average Delay (sec/veh): xxxxxx
Optimal Cycle: 36 Level Of Service: B

Table with 4 columns: North Bound, South Bound, East Bound, West Bound. Rows include Movement (L-T-R), Control (Protected), Rights (Include), Min. Green, Y+R, and Lanes.

Volume Module table with 12 columns representing different volume categories and 12 rows of adjustment factors like Base Vol, Growth Adj, etc.

Saturation Flow Module table with 12 columns and 4 rows showing Sat/Lane, Adjustment, Lanes, and Final Sat.

Capacity Analysis Module table with 12 columns and 3 rows showing Vol/Sat, Crit Moves, and asterisks.

Santa Ana Circulation Element

Level Of Service Computation Report

ICU 1(Loss as Cycle Length %) Method (Base Volume Alternative)

Intersection #26 Greenville St and Edinger Ave

Cycle (sec): 100 Critical Vol./Cap.(X): 0.647
Loss Time (sec): 5 Average Delay (sec/veh): xxxxxx
Optimal Cycle: 32 Level Of Service: B

Table with 4 columns: North Bound, South Bound, East Bound, West Bound. Rows include Movement, Control, Rights, Min. Green, Y+R, and Lanes.

Volume Module table with 12 columns representing different traffic volumes and adjustment factors.

Saturation Flow Module table with 12 columns representing saturation flow rates and adjustments.

Capacity Analysis Module table with 12 columns representing capacity analysis metrics.

Santa Ana Circulation Element

Level Of Service Computation Report

ICU 1(Loss as Cycle Length %) Method (Base Volume Alternative)

Intersection #27 Greenville St and Segerstrom Ave

Cycle (sec): 100 Critical Vol./Cap.(X): 0.797
Loss Time (sec): 5 Average Delay (sec/veh): xxxxxx
Optimal Cycle: 51 Level Of Service: C

Table with 4 columns: North Bound, South Bound, East Bound, West Bound. Rows include Movement (L-T-R), Control (Permitted), Rights (Include), Min. Green, Y+R, and Lanes.

Volume Module table with 12 columns representing different traffic movements and 10 rows of adjustment factors like Base Vol, Growth Adj, PHF Adj, etc.

Saturation Flow Module table with 12 columns and 4 rows showing Sat/Lane, Adjustment, Lanes, and Final Sat.

Capacity Analysis Module table with 12 columns and 2 rows showing Vol/Sat and Crit Moves.

Santa Ana Circulation Element

Level Of Service Computation Report

ICU 1(Loss as Cycle Length %) Method (Base Volume Alternative)

Intersection #28 Raitt St and McFadden Ave

Cycle (sec): 100 Critical Vol./Cap.(X): 0.676
 Loss Time (sec): 5 Average Delay (sec/veh): xxxxxx
 Optimal Cycle: 35 Level Of Service: B

Approach:	North Bound			South Bound			East Bound			West Bound		
Movement:	L	T	R	L	T	R	L	T	R	L	T	R
Control:	Protected			Protected			Protected			Protected		
Rights:	Include			Include			Include			Include		
Min. Green:	0	0	0	0	0	0	0	0	0	0	0	0
Y+R:	4.0	4.0	4.0	4.0	4.0	4.0	4.0	4.0	4.0	4.0	4.0	4.0
Lanes:	1	0	0	1	0	0	1	0	0	1	0	0

Volume Module:

Base Vol:	34	482	75	24	252	40	59	347	30	38	318	44
Growth Adj:	1.00	1.00	1.00	1.00	1.00	1.00	1.00	1.00	1.00	1.00	1.00	1.00
Initial Bse:	34	482	75	24	252	40	59	347	30	38	318	44
User Adj:	1.00	1.00	1.00	1.00	1.00	1.00	1.00	1.00	1.00	1.00	1.00	1.00
PHF Adj:	1.00	1.00	1.00	1.00	1.00	1.00	1.00	1.00	1.00	1.00	1.00	1.00
PHF Volume:	34	482	75	24	252	40	59	347	30	38	318	44
Reduct Vol:	0	0	0	0	0	0	0	0	0	0	0	0
Reduced Vol:	34	482	75	24	252	40	59	347	30	38	318	44
PCE Adj:	1.00	1.00	1.00	1.00	1.00	1.00	1.00	1.00	1.00	1.00	1.00	1.00
MLF Adj:	1.00	1.00	1.00	1.00	1.00	1.00	1.00	1.00	1.00	1.00	1.00	1.00
FinalVolume:	34	482	75	24	252	40	59	347	30	38	318	44

Saturation Flow Module:

Sat/Lane:	1600	1600	1600	1600	1600	1600	1600	1600	1600	1600	1600	1600
Adjustment:	1.00	1.00	1.00	1.00	1.00	1.00	1.00	1.00	1.00	1.00	1.00	1.00
Lanes:	1.00	0.87	0.13	1.00	0.86	0.14	1.00	0.92	0.08	1.00	0.88	0.12
Final Sat.:	1600	1385	215	1600	1381	219	1600	1473	127	1600	1406	194

Capacity Analysis Module:

Vol/Sat:	0.02	0.35	0.35	0.02	0.18	0.18	0.04	0.24	0.24	0.02	0.23	0.23
Crit Moves:	****			****			****			****		

Santa Ana Circulation Element

Level Of Service Computation Report

ICU 1(Loss as Cycle Length %) Method (Base Volume Alternative)

Intersection #29 Raitt St and Edinger Ave

Cycle (sec): 100 Critical Vol./Cap.(X): 0.988
Loss Time (sec): 5 Average Delay (sec/veh): xxxxxx
Optimal Cycle: 180 Level Of Service: E

Table with 4 columns: North Bound, South Bound, East Bound, West Bound. Rows include Movement (L-T-R), Control (Protected), Rights (Include), Min. Green, Y+R, and Lanes.

Volume Module: Table with 12 columns representing traffic volumes and adjustment factors for Base Vol, Growth Adj, Initial Bse, User Adj, PHF Adj, PHF Volume, Reduct Vol, Reduced Vol, PCE Adj, MLF Adj, and Final Volume.

Saturation Flow Module: Table with 12 columns for Sat/Lane, Adjustment, Lanes, and Final Sat. values.

Capacity Analysis Module: Table with 12 columns for Vol/Sat and Crit Moves values.

Santa Ana Circulation Element

Level Of Service Computation Report

ICU 1(Loss as Cycle Length %) Method (Base Volume Alternative)

Intersection #30 Bear St and MacArthur Blvd

Cycle (sec): 100 Critical Vol./Cap.(X): 0.904
 Loss Time (sec): 5 Average Delay (sec/veh): xxxxxx
 Optimal Cycle: 89 Level Of Service: E

Approach:	North Bound			South Bound			East Bound			West Bound		
Movement:	L	T	R	L	T	R	L	T	R	L	T	R
Control:	Protected			Protected			Protected			Protected		
Rights:	Include			Include			Include			Include		
Min. Green:	0	0	0	0	0	0	0	0	0	0	0	0
Y+R:	4.0	4.0	4.0	4.0	4.0	4.0	4.0	4.0	4.0	4.0	4.0	4.0
Lanes:	1	0	2	0	1	0	1	0	2	1	0	2

Volume Module:

Base Vol:	262	1258	328	115	278	84	90	847	88	82	1475	235
Growth Adj:	1.00	1.00	1.00	1.00	1.00	1.00	1.00	1.00	1.00	1.00	1.00	1.00
Initial Bse:	262	1258	328	115	278	84	90	847	88	82	1475	235
User Adj:	1.00	1.00	1.00	1.00	1.00	1.00	1.00	1.00	1.00	1.00	1.00	1.00
PHF Adj:	1.00	1.00	1.00	1.00	1.00	1.00	1.00	1.00	1.00	1.00	1.00	1.00
PHF Volume:	262	1258	328	115	278	84	90	847	88	82	1475	235
Reduct Vol:	0	0	0	0	0	0	0	0	0	0	0	0
Reduced Vol:	262	1258	328	115	278	84	90	847	88	82	1475	235
PCE Adj:	1.00	1.00	1.00	1.00	1.00	1.00	1.00	1.00	1.00	1.00	1.00	1.00
MLF Adj:	1.00	1.00	1.00	1.00	1.00	1.00	1.00	1.00	1.00	1.00	1.00	1.00
FinalVolume:	262	1258	328	115	278	84	90	847	88	82	1475	235

Saturation Flow Module:

Sat/Lane:	1600	1600	1600	1600	1600	1600	1600	1600	1600	1600	1600	1600
Adjustment:	1.00	1.06	1.00	1.00	1.06	1.00	1.00	1.05	1.00	1.00	1.05	1.00
Lanes:	1.00	2.00	1.00	1.00	2.00	1.00	1.00	2.72	0.28	1.00	2.59	0.41
Final Sat.:	1600	3400	1600	1600	3400	1600	1600	4548	452	1600	4340	660

Capacity Analysis Module:

Vol/Sat:	0.16	0.37	0.21	0.07	0.08	0.05	0.06	0.19	0.19	0.05	0.34	0.36
Crit Moves:	****			****			****			****		

Santa Ana Circulation Element

Level Of Service Computation Report

ICU 1(Loss as Cycle Length %) Method (Base Volume Alternative)

 Intersection #31 Bristol St and 17th St

Cycle (sec): 100 Critical Vol./Cap.(X): 0.811
 Loss Time (sec): 5 Average Delay (sec/veh): xxxxxx
 Optimal Cycle: 54 Level Of Service: D

Approach:	North Bound			South Bound			East Bound			West Bound		
Movement:	L	T	R	L	T	R	L	T	R	L	T	R
Control:	Protected			Protected			Protected			Protected		
Rights:	Include			Include			Include			Ovl		
Min. Green:	0	0	0	0	0	0	0	0	0	0	0	0
Y+R:	4.0	4.0	4.0	4.0	4.0	4.0	4.0	4.0	4.0	4.0	4.0	4.0
Lanes:	2	0	3	0	1		2	0	3	0	1	

Volume Module:

Base Vol:	370	1801	300	347	1847	314	243	543	98	280	1055	357
Growth Adj:	1.00	1.00	1.00	1.00	1.00	1.00	1.00	1.00	1.00	1.00	1.00	1.00
Initial Bse:	370	1801	300	347	1847	314	243	543	98	280	1055	357
User Adj:	1.00	1.00	1.00	1.00	1.00	1.00	1.00	1.00	1.00	1.00	1.00	1.00
PHF Adj:	1.00	1.00	1.00	1.00	1.00	1.00	1.00	1.00	1.00	1.00	1.00	1.00
PHF Volume:	370	1801	300	347	1847	314	243	543	98	280	1055	357
Reduct Vol:	0	0	0	0	0	0	0	0	0	0	0	0
Reduced Vol:	370	1801	300	347	1847	314	243	543	98	280	1055	357
PCE Adj:	1.00	1.00	1.00	1.00	1.00	1.00	1.00	1.00	1.00	1.00	1.00	1.00
MLF Adj:	1.00	1.00	1.00	1.00	1.00	1.00	1.00	1.00	1.00	1.00	1.00	1.00
FinalVolume:	370	1801	300	347	1847	314	243	543	98	280	1055	357
OvlAdjVol:												183

Saturation Flow Module:

Sat/Lane:	1600	1600	1600	1600	1600	1600	1600	1600	1600	1600	1600	1600
Adjustment:	1.00	1.06	1.00	1.00	1.06	1.00	1.00	1.05	1.00	1.00	1.06	1.00
Lanes:	2.00	3.00	1.00	2.00	3.00	1.00	2.00	2.54	0.46	2.00	3.00	1.00
Final Sat.:	3200	5100	1600	3200	5100	1600	3200	4266	734	3200	5100	1600

Capacity Analysis Module:

Vol/Sat:	0.12	0.35	0.19	0.11	0.36	0.20	0.08	0.13	0.13	0.09	0.21	0.22
OvlAdjV/S:												0.11
Crit Moves:	****						****	****				****

Santa Ana Circulation Element

Level Of Service Computation Report

ICU 1(Loss as Cycle Length %) Method (Base Volume Alternative)

Intersection #32 Bristol St and Civic Center Dr

Cycle (sec): 100 Critical Vol./Cap.(X): 0.898
 Loss Time (sec): 5 Average Delay (sec/veh): xxxxxx
 Optimal Cycle: 85 Level Of Service: D

Approach:	North Bound			South Bound			East Bound			West Bound		
Movement:	L	T	R	L	T	R	L	T	R	L	T	R
Control:	Protected			Protected			Prot+Permit			Prot+Permit		
Rights:	Include			Include			Include			Include		
Min. Green:	0	0	0	0	0	0	0	0	0	0	0	0
Y+R:	4.0	4.0	4.0	4.0	4.0	4.0	4.0	4.0	4.0	4.0	4.0	4.0
Lanes:	1	0	2	1	0	2	1	0	0	1	0	1

Volume Module:

Base Vol:	214	1494	78	173	1589	163	130	366	43	149	635	72
Growth Adj:	1.00	1.00	1.00	1.00	1.00	1.00	1.00	1.00	1.00	1.00	1.00	1.00
Initial Bse:	214	1494	78	173	1589	163	130	366	43	149	635	72
User Adj:	1.00	1.00	1.00	1.00	1.00	1.00	1.00	1.00	1.00	1.00	1.00	1.00
PHF Adj:	1.00	1.00	1.00	1.00	1.00	1.00	1.00	1.00	1.00	1.00	1.00	1.00
PHF Volume:	214	1494	78	173	1589	163	130	366	43	149	635	72
Reduct Vol:	0	0	0	0	0	0	0	0	0	0	0	0
Reduced Vol:	214	1494	78	173	1589	163	130	366	43	149	635	72
PCE Adj:	1.00	1.00	1.00	1.00	1.00	1.00	1.00	1.00	1.00	1.00	1.00	1.00
MLF Adj:	1.00	1.00	1.00	1.00	1.00	1.00	1.00	1.00	1.00	1.00	1.00	1.00
FinalVolume:	214	1494	78	173	1589	163	130	366	43	149	635	72

Saturation Flow Module:

Sat/Lane:	1600	1600	1600	1600	1600	1600	1600	1600	1600	1600	1600	1600
Adjustment:	1.00	1.04	1.00	1.00	1.05	1.00	1.00	1.00	1.00	1.00	1.03	1.00
Lanes:	1.00	2.85	0.15	1.00	2.72	0.28	1.00	0.89	0.11	1.00	1.80	0.20
Final Sat.:	1600	4762	238	1600	4553	447	1600	1432	168	1600	2974	326

Capacity Analysis Module:

Vol/Sat:	0.13	0.31	0.33	0.11	0.35	0.37	0.08	0.26	0.26	0.09	0.21	0.22
Crit Moves:	****					****		****		****		

Santa Ana Circulation Element

Level Of Service Computation Report

ICU 1(Loss as Cycle Length %) Method (Base Volume Alternative)

Intersection #33 Bristol St and Santa Ana Blvd

Cycle (sec): 100 Critical Vol./Cap.(X): 0.732
 Loss Time (sec): 5 Average Delay (sec/veh): xxxxxx
 Optimal Cycle: 41 Level Of Service: C

Approach:	North Bound			South Bound			East Bound			West Bound		
Movement:	L	T	R	L	T	R	L	T	R	L	T	R
Control:	Protected			Protected			Prot+Permit			Prot+Permit		
Rights:	Include			Include			Include			Include		
Min. Green:	0	0	0	0	0	0	0	0	0	0	0	0
Y+R:	4.0	4.0	4.0	4.0	4.0	4.0	4.0	4.0	4.0	4.0	4.0	4.0
Lanes:	1	0	2	1	0	2	1	0	0	1	0	0

Volume Module:

Base Vol:	85	1722	98	120	1597	60	70	194	45	125	199	54
Growth Adj:	1.00	1.00	1.00	1.00	1.00	1.00	1.00	1.00	1.00	1.00	1.00	1.00
Initial Bse:	85	1722	98	120	1597	60	70	194	45	125	199	54
User Adj:	1.00	1.00	1.00	1.00	1.00	1.00	1.00	1.00	1.00	1.00	1.00	1.00
PHF Adj:	1.00	1.00	1.00	1.00	1.00	1.00	1.00	1.00	1.00	1.00	1.00	1.00
PHF Volume:	85	1722	98	120	1597	60	70	194	45	125	199	54
Reduct Vol:	0	0	0	0	0	0	0	0	0	0	0	0
Reduced Vol:	85	1722	98	120	1597	60	70	194	45	125	199	54
PCE Adj:	1.00	1.00	1.00	1.00	1.00	1.00	1.00	1.00	1.00	1.00	1.00	1.00
MLF Adj:	1.00	1.00	1.00	1.00	1.00	1.00	1.00	1.00	1.00	1.00	1.00	1.00
FinalVolume:	85	1722	98	120	1597	60	70	194	45	125	199	54

Saturation Flow Module:

Sat/Lane:	1600	1600	1600	1600	1600	1600	1600	1600	1600	1600	1600	1600
Adjustment:	1.00	1.04	1.00	1.00	1.04	1.00	1.00	1.00	1.00	1.00	1.00	1.00
Lanes:	1.00	2.84	0.16	1.00	2.89	0.11	1.00	0.81	0.19	1.00	0.79	0.21
Final Sat.:	1600	4742	258	1600	4826	174	1600	1299	301	1600	1258	342

Capacity Analysis Module:

Vol/Sat:	0.05	0.36	0.38	0.08	0.33	0.35	0.04	0.15	0.15	0.08	0.16	0.16
Crit Moves:			****	****			****			****		

Santa Ana Circulation Element

Level Of Service Computation Report

ICU 1(Loss as Cycle Length %) Method (Base Volume Alternative)

Intersection #34 Bristol St and 1st St

Cycle (sec): 100 Critical Vol./Cap.(X): 0.972
Loss Time (sec): 5 Average Delay (sec/veh): xxxxxx
Optimal Cycle: 167 Level Of Service: E

Table with 4 columns: North Bound, South Bound, East Bound, West Bound. Rows include Movement (L-T-R), Control (Protected), Rights (Include), Min. Green, Y+R, and Lanes.

Volume Module: Table with 12 columns representing different traffic movements and 10 rows of adjustment factors like Base Vol, Growth Adj, PHF Adj, etc.

Saturation Flow Module: Table with 12 columns and 4 rows showing Sat/Lane, Adjustment, Lanes, and Final Sat.

Capacity Analysis Module: Table with 12 columns and 2 rows showing Vol/Sat and Crit Moves.

Santa Ana Circulation Element

Level Of Service Computation Report

ICU 1(Loss as Cycle Length %) Method (Base Volume Alternative)

Intersection #35 Bristol St and McFadden Ave

Cycle (sec): 100 Critical Vol./Cap.(X): 0.890
Loss Time (sec): 5 Average Delay (sec/veh): xxxxxx
Optimal Cycle: 81 Level Of Service: D

Table with 4 columns: North Bound, South Bound, East Bound, West Bound. Rows include Movement (L-T-R), Control, Rights, Min. Green, Y+R, and Lanes.

Volume Module: Table with 12 columns representing different volume categories and 12 rows of adjustment factors like Growth Adj, User Adj, PHF Adj, etc.

Saturation Flow Module: Table with 12 columns and 4 rows showing Sat/Lane, Adjustment, Lanes, and Final Sat.

Capacity Analysis Module: Table with 12 columns and 2 rows showing Vol/Sat and Crit Moves.

Santa Ana Circulation Element

Level Of Service Computation Report

ICU 1(Loss as Cycle Length %) Method (Base Volume Alternative)

Intersection #36 Bristol St and Warner Ave

Cycle (sec): 100 Critical Vol./Cap.(X): 0.871
 Loss Time (sec): 5 Average Delay (sec/veh): xxxxxx
 Optimal Cycle: 72 Level Of Service: D

Approach:	North Bound			South Bound			East Bound			West Bound		
Movement:	L	T	R	L	T	R	L	T	R	L	T	R
Control:	Protected			Protected			Protected			Protected		
Rights:	Include			Include			Include			Include		
Min. Green:	0	0	0	0	0	0	0	0	0	0	0	0
Y+R:	4.0	4.0	4.0	4.0	4.0	4.0	4.0	4.0	4.0	4.0	4.0	4.0
Lanes:	2	0	2	1	0	0	2	0	2	1	0	3

Volume Module:

Base Vol:	312	1170	213	343	1144	223	159	715	126	282	1662	487
Growth Adj:	1.00	1.00	1.00	1.00	1.00	1.00	1.00	1.00	1.00	1.00	1.00	1.00
Initial Bse:	312	1170	213	343	1144	223	159	715	126	282	1662	487
User Adj:	1.00	1.00	1.00	1.00	1.00	1.00	1.00	1.00	1.00	1.00	1.00	1.00
PHF Adj:	1.00	1.00	1.00	1.00	1.00	1.00	1.00	1.00	1.00	1.00	1.00	1.00
PHF Volume:	312	1170	213	343	1144	223	159	715	126	282	1662	487
Reduct Vol:	0	0	0	0	0	0	0	0	0	0	0	0
Reduced Vol:	312	1170	213	343	1144	223	159	715	126	282	1662	487
PCE Adj:	1.00	1.00	1.00	1.00	1.00	1.00	1.00	1.00	1.00	1.00	1.00	1.00
MLF Adj:	1.00	1.00	1.00	1.00	1.00	1.00	1.00	1.00	1.00	1.00	1.00	1.00
FinalVolume:	312	1170	213	343	1144	223	159	715	126	282	1662	487

Saturation Flow Module:

Sat/Lane:	1600	1600	1600	1600	1600	1600	1600	1600	1600	1600	1600	1600
Adjustment:	1.00	1.05	1.00	1.00	1.05	1.00	1.00	1.06	1.00	1.00	1.06	1.00
Lanes:	2.00	2.54	0.46	2.00	2.51	0.49	1.00	3.00	1.00	1.00	3.00	1.00
Final Sat.:	3200	4261	739	3200	4217	783	1600	5100	1600	1600	5100	1600

Capacity Analysis Module:

Vol/Sat:	0.10	0.27	0.29	0.11	0.27	0.28	0.10	0.14	0.08	0.18	0.33	0.30
Crit Moves:			****	****			****			****		

Santa Ana Circulation Element

Level Of Service Computation Report

ICU 1(Loss as Cycle Length %) Method (Base Volume Alternative)

Intersection #37 Bristol St and Segerstrom Ave

Cycle (sec): 100 Critical Vol./Cap.(X): 0.915
 Loss Time (sec): 5 Average Delay (sec/veh): xxxxxx
 Optimal Cycle: 96 Level Of Service: E

Approach:	North Bound			South Bound			East Bound			West Bound		
Movement:	L	T	R	L	T	R	L	T	R	L	T	R
Control:	Protected			Protected			Protected			Protected		
Rights:	WideBypass			Include			Include			Include		
Min. Green:	0	0	0	0	0	0	0	0	0	0	0	0
Y+R:	4.0	4.0	4.0	4.0	4.0	4.0	4.0	4.0	4.0	4.0	4.0	4.0
Lanes:	1	0	2	1	0	2	1	0	2	1	0	2

Volume Module:

Base Vol:	177	1309	231	98	894	187	279	998	79	156	1408	71
Growth Adj:	1.00	1.00	1.00	1.00	1.00	1.00	1.00	1.00	1.00	1.00	1.00	1.00
Initial Bse:	177	1309	231	98	894	187	279	998	79	156	1408	71
User Adj:	1.00	1.00	1.00	1.00	1.00	1.00	1.00	1.00	1.00	1.00	1.00	1.00
PHF Adj:	1.00	1.00	1.00	1.00	1.00	1.00	1.00	1.00	1.00	1.00	1.00	1.00
PHF Volume:	177	1309	231	98	894	187	279	998	79	156	1408	71
Reduct Vol:	0	0	0	0	0	0	0	0	0	0	0	0
Reduced Vol:	177	1309	231	98	894	187	279	998	79	156	1408	71
PCE Adj:	1.00	1.00	1.00	1.00	1.00	1.00	1.00	1.00	1.00	1.00	1.00	1.00
MLF Adj:	1.00	1.00	1.00	1.00	1.00	1.00	1.00	1.00	1.00	1.00	1.00	1.00
FinalVolume:	177	1309	231	98	894	187	279	998	79	156	1408	71

Saturation Flow Module:

Sat/Lane:	1600	1600	1600	1600	1600	1600	1600	1600	1600	1600	1600	1600
Adjustment:	1.00	1.05	1.00	1.00	1.05	1.00	1.00	1.04	1.00	1.00	1.04	1.00
Lanes:	1.00	2.55	0.45	1.00	2.48	0.52	1.00	2.78	0.22	1.00	2.86	0.14
Final Sat.:	1600	4280	720	1600	4170	830	1600	4648	352	1600	4770	230

Capacity Analysis Module:

Vol/Sat:	0.11	0.31	0.32	0.06	0.21	0.23	0.17	0.21	0.22	0.10	0.30	0.31
Crit Moves:			****	****			****			****		

Santa Ana Circulation Element

Level Of Service Computation Report

ICU 1(Loss as Cycle Length %) Method (Base Volume Alternative)

Intersection #38 Bristol St and Alton Ave

Cycle (sec): 100 Critical Vol./Cap.(X): 0.583
 Loss Time (sec): 5 Average Delay (sec/veh): xxxxxx
 Optimal Cycle: 28 Level Of Service: A

Approach:	North Bound			South Bound			East Bound			West Bound		
Movement:	L	T	R	L	T	R	L	T	R	L	T	R
Control:	Protected			Protected			Permitted			Permitted		
Rights:	WideBypass			Include			Include			Include		
Min. Green:	0	0	0	0	0	0	0	0	0	0	0	0
Y+R:	4.0	4.0	4.0	4.0	4.0	4.0	4.0	4.0	4.0	4.0	4.0	4.0
Lanes:	1	0	2	1	0	3	1	0	1	1	0	1

Volume Module:	North Bound			South Bound			East Bound			West Bound		
Base Vol:	43	1667	157	114	858	54	50	70	130	0	0	0
Growth Adj:	1.00	1.00	1.00	1.00	1.00	1.00	1.00	1.00	1.00	1.00	1.00	1.00
Initial Bse:	43	1667	157	114	858	54	50	70	130	0	0	0
User Adj:	1.00	1.00	1.00	1.00	1.00	1.00	1.00	1.00	1.00	1.00	1.00	1.00
PHF Adj:	1.00	1.00	1.00	1.00	1.00	1.00	1.00	1.00	1.00	1.00	1.00	1.00
PHF Volume:	43	1667	157	114	858	54	50	70	130	0	0	0
Reduct Vol:	0	0	0	0	0	0	0	0	0	0	0	0
Reduced Vol:	43	1667	157	114	858	54	50	70	130	0	0	0
PCE Adj:	1.00	1.00	1.00	1.00	1.00	1.00	1.00	1.00	1.00	1.00	1.00	1.00
MLF Adj:	1.00	1.00	1.00	1.00	1.00	1.00	1.00	1.00	1.00	1.00	1.00	1.00
FinalVolume:	43	1667	157	114	858	54	50	70	130	0	0	0

Saturation Flow Module:	North Bound			South Bound			East Bound			West Bound		
Sat/Lane:	1600	1600	1600	1600	1600	1600	1600	1600	1600	1600	1600	1600
Adjustment:	1.00	1.05	1.00	1.00	1.06	1.00	1.00	1.06	1.00	1.00	1.00	1.00
Lanes:	1.00	2.74	0.26	1.00	3.00	1.00	1.00	1.00	1.00	1.00	1.00	0.00
Final Sat.:	1600	4587	413	1600	5100	1600	1600	1700	1600	1600	1600	0

Capacity Analysis Module:	North Bound			South Bound			East Bound			West Bound		
Vol/Sat:	0.03	0.36	0.38	0.07	0.17	0.03	0.03	0.04	0.08	0.00	0.00	0.00
Crit Moves:			****	****					****			

Santa Ana Circulation Element

Level Of Service Computation Report

ICU 1(Loss as Cycle Length %) Method (Base Volume Alternative)

Intersection #39 Bristol St and MacArthur Blvd

Cycle (sec): 100 Critical Vol./Cap.(X): 0.796
 Loss Time (sec): 5 Average Delay (sec/veh): xxxxxx
 Optimal Cycle: 51 Level Of Service: C

Approach:	North Bound			South Bound			East Bound			West Bound								
Movement:	L	T	R	L	T	R	L	T	R	L	T	R						
Control:	Protected			Protected			Protected			Protected								
Rights:	Include			Include			Include			Include								
Min. Green:	0	0	0	0	0	0	0	0	0	0	0	0						
Y+R:	4.0	4.0	4.0	4.0	4.0	4.0	4.0	4.0	4.0	4.0	4.0	4.0						
Lanes:	2	0	3	0	1		2	0	2	1	0		2	0	3	0	1	

Volume Module:

Base Vol:	335	1428	260	237	871	137	357	796	169	247	1432	270
Growth Adj:	1.00	1.00	1.00	1.00	1.00	1.00	1.00	1.00	1.00	1.00	1.00	1.00
Initial Bse:	335	1428	260	237	871	137	357	796	169	247	1432	270
User Adj:	1.00	1.00	1.00	1.00	1.00	1.00	1.00	1.00	1.00	1.00	1.00	1.00
PHF Adj:	1.00	1.00	1.00	1.00	1.00	1.00	1.00	1.00	1.00	1.00	1.00	1.00
PHF Volume:	335	1428	260	237	871	137	357	796	169	247	1432	270
Reduct Vol:	0	0	0	0	0	0	0	0	0	0	0	0
Reduced Vol:	335	1428	260	237	871	137	357	796	169	247	1432	270
PCE Adj:	1.00	1.00	1.00	1.00	1.00	1.00	1.00	1.00	1.00	1.00	1.00	1.00
MLF Adj:	1.00	1.00	1.00	1.00	1.00	1.00	1.00	1.00	1.00	1.00	1.00	1.00
FinalVolume:	335	1428	260	237	871	137	357	796	169	247	1432	270

Saturation Flow Module:

Sat/Lane:	1600	1600	1600	1600	1600	1600	1600	1600	1600	1600	1600	1600
Adjustment:	1.00	1.06	1.00	1.00	1.05	1.00	1.00	1.06	1.00	1.00	1.06	1.00
Lanes:	2.00	3.00	1.00	2.00	2.59	0.41	2.00	3.00	1.00	2.00	3.00	1.00
Final Sat.:	3200	5100	1600	3200	4348	652	3200	5100	1600	3200	5100	1600

Capacity Analysis Module:

Vol/Sat:	0.10	0.28	0.16	0.07	0.20	0.21	0.11	0.16	0.11	0.08	0.28	0.17
Crit Moves:	****			****			****			****		

Santa Ana Circulation Element

Level Of Service Computation Report

ICU 1(Loss as Cycle Length %) Method (Base Volume Alternative)

Intersection #40 Bristol St and Sunflower Ave

Cycle (sec): 100 Critical Vol./Cap.(X): 0.744
 Loss Time (sec): 5 Average Delay (sec/veh): xxxxxx
 Optimal Cycle: 42 Level Of Service: C

Approach:	North Bound			South Bound			East Bound			West Bound														
Movement:	L	T	R	L	T	R	L	T	R	L	T	R												
Control:	Protected			Protected			Protected			Protected														
Rights:	Include			Include			Include			Include														
Min. Green:	0	0	0	0	0	0	0	0	0	0	0	0												
Y+R:	4.0	4.0	4.0	4.0	4.0	4.0	4.0	4.0	4.0	4.0	4.0	4.0												
Lanes:	2	0	2	1	1		2	0	3	0	1		2	0	2	1	1		2	0	3	0	1	

Volume Module:

Base Vol:	687	1452	234	226	844	242	391	764	296	254	976	311
Growth Adj:	1.00	1.00	1.00	1.00	1.00	1.00	1.00	1.00	1.00	1.00	1.00	1.00
Initial Bse:	687	1452	234	226	844	242	391	764	296	254	976	311
User Adj:	1.00	1.00	1.00	1.00	1.00	1.00	1.00	1.00	1.00	1.00	1.00	1.00
PHF Adj:	1.00	1.00	1.00	1.00	1.00	1.00	1.00	1.00	1.00	1.00	1.00	1.00
PHF Volume:	687	1452	234	226	844	242	391	764	296	254	976	311
Reduct Vol:	0	0	0	0	0	0	0	0	0	0	0	0
Reduced Vol:	687	1452	234	226	844	242	391	764	296	254	976	311
PCE Adj:	1.00	1.00	1.00	1.00	1.00	1.00	1.00	1.00	1.00	1.00	1.00	1.00
MLF Adj:	1.00	1.00	1.00	1.00	1.00	1.00	1.00	1.00	1.00	1.00	1.00	1.00
FinalVolume:	687	1452	234	226	844	242	391	764	296	254	976	311

Saturation Flow Module:

Sat/Lane:	1600	1600	1600	1600	1600	1600	1600	1600	1600	1600	1600	1600
Adjustment:	1.00	1.06	1.00	1.00	1.06	1.00	1.00	1.04	1.00	1.00	1.06	1.00
Lanes:	2.00	3.00	1.00	2.00	3.00	1.00	2.00	2.88	1.12	2.00	3.00	1.00
Final Sat.:	3200	5100	1600	3200	5100	1600	3200	4813	1787	3200	5100	1600

Capacity Analysis Module:

Vol/Sat:	0.21	0.28	0.15	0.07	0.17	0.15	0.12	0.16	0.17	0.08	0.19	0.19
Crit Moves:	****				****		****				****	

Santa Ana Circulation Element

Level Of Service Computation Report
 2000 HCM Operations Method (Base Volume Alternative)

 Intersection #41 Bristol St and I-405 NB Ramps

Cycle (sec): 100 Critical Vol./Cap.(X): 0.854
 Loss Time (sec): 5 Average Delay (sec/veh): 29.0
 Optimal Cycle: 69 Level Of Service: C

Approach:	North Bound			South Bound			East Bound			West Bound		
Movement:	L	T	R	L	T	R	L	T	R	L	T	R
Control:	Protected			Protected			Split Phase			Split Phase		
Rights:	Include			Include			Include			Ovl		
Min. Green:	0	0	0	0	0	0	0	0	0	0	0	0
Y+R:	4.0	4.0	4.0	4.0	4.0	4.0	4.0	4.0	4.0	4.0	4.0	4.0
Lanes:	0	0	4	0	0	4	0	0	0	1	1	0

Volume Module:

Base Vol:	0	2235	195	0	2458	23	0	0	204	357	306	1184
Growth Adj:	1.00	1.00	1.00	1.00	1.00	1.00	1.00	1.00	1.00	1.00	1.00	1.00
Initial Bse:	0	2235	195	0	2458	23	0	0	204	357	306	1184
User Adj:	1.00	1.00	1.00	1.00	1.00	1.00	1.00	1.00	1.00	1.00	1.00	1.00
PHF Adj:	1.00	1.00	1.00	1.00	1.00	1.00	1.00	1.00	1.00	1.00	1.00	1.00
PHF Volume:	0	2235	195	0	2458	23	0	0	204	357	306	1184
Reduct Vol:	0	0	0	0	0	0	0	0	0	0	0	0
Reduced Vol:	0	2235	195	0	2458	23	0	0	204	357	306	1184
PCE Adj:	1.00	1.00	1.00	1.00	1.00	1.00	1.00	1.00	1.00	1.00	1.00	1.00
MLF Adj:	1.00	1.00	1.00	1.00	1.00	1.00	1.00	1.00	1.00	1.00	1.00	1.00
FinalVolume:	0	2235	195	0	2458	23	0	0	204	357	306	1184

Saturation Flow Module:

Sat/Lane:	1900	1900	1900	1900	1900	1900	1900	1900	1900	1900	1900	1900
Adjustment:	1.00	0.91	0.85	1.00	0.91	0.91	1.00	1.00	0.75	0.93	0.93	0.75
Lanes:	0.00	4.00	1.00	0.00	4.95	0.05	0.00	0.00	2.00	1.62	1.38	2.00
Final Sat.:	0	6916	1615	0	8556	80	0	0	2842	2840	2434	2842

Capacity Analysis Module:

Vol/Sat:	0.00	0.32	0.12	0.00	0.29	0.29	0.00	0.00	0.07	0.13	0.13	0.42
Crit Moves:	****			****			****			****		
Green/Cycle:	0.00	0.38	0.38	0.00	0.38	0.38	0.00	0.00	0.08	0.49	0.49	0.49
Volume/Cap:	0.00	0.85	0.32	0.00	0.76	0.76	0.00	0.00	0.85	0.26	0.26	0.85
Delay/Veh:	0.0	31.5	22.3	0.0	28.2	28.2	0.0	0.0	69.8	15.1	15.1	27.9
User DelAdj:	1.00	1.00	1.00	1.00	1.00	1.00	1.00	1.00	1.00	1.00	1.00	1.00
AdjDel/Veh:	0.0	31.5	22.3	0.0	28.2	28.2	0.0	0.0	69.8	15.1	15.1	27.9
LOS by Move:	A	C	C	A	C	C	A	A	E	B	B	C
HCM2k85thQ:	0	29	7	0	24	24	0	0	9	6	6	30

 Note: Queue reported is the number of cars per lane.

Santa Ana Circulation Element

Level Of Service Computation Report
 2000 HCM Operations Method (Base Volume Alternative)

 Intersection #42 Bristol St and I-405 SB Ramps

Cycle (sec): 100 Critical Vol./Cap.(X): 0.631
 Loss Time (sec): 5 Average Delay (sec/veh): 18.2
 Optimal Cycle: 32 Level Of Service: B

Approach:	North Bound			South Bound			East Bound			West Bound		
Movement:	L	T	R	L	T	R	L	T	R	L	T	R
Control:	Protected			Protected			Split Phase			Split Phase		
Rights:	Include			Ignore			Include			Include		
Min. Green:	0	0	0	0	0	0	0	0	0	0	0	0
Y+R:	4.0	4.0	4.0	4.0	4.0	4.0	4.0	4.0	4.0	4.0	4.0	4.0
Lanes:	1	0	4	0	0	2	1	1	3	0	0	0

Volume Module:

Base Vol:	135	1647	0	0	1657	968	740	0	331	0	0	0
Growth Adj:	1.00	1.00	1.00	1.00	1.00	1.00	1.00	1.00	1.00	1.00	1.00	1.00
Initial Bse:	135	1647	0	0	1657	968	740	0	331	0	0	0
User Adj:	1.00	1.00	1.00	1.00	1.00	0.00	1.00	1.00	1.00	1.00	1.00	1.00
PHF Adj:	1.00	1.00	1.00	1.00	1.00	0.00	1.00	1.00	1.00	1.00	1.00	1.00
PHF Volume:	135	1647	0	0	1657	0	740	0	331	0	0	0
Reduct Vol:	0	0	0	0	0	0	0	0	0	0	0	0
Reduced Vol:	135	1647	0	0	1657	0	740	0	331	0	0	0
PCE Adj:	1.00	1.00	1.00	1.00	1.00	0.00	1.00	1.00	1.00	1.00	1.00	1.00
MLF Adj:	1.00	1.00	1.00	1.00	1.00	0.00	1.00	1.00	1.00	1.00	1.00	1.00
FinalVolume:	135	1647	0	0	1657	0	740	0	331	0	0	0

Saturation Flow Module:

Sat/Lane:	1900	1900	1900	1900	1900	1900	1900	1900	1900	1900	1900	1900
Adjustment:	0.95	0.91	1.00	1.00	0.91	0.91	0.92	1.00	0.85	1.00	1.00	1.00
Lanes:	1.00	4.00	0.00	0.00	3.00	1.00	3.00	0.00	1.00	0.00	0.00	0.00
Final Sat.:	1805	6916	0	0	5187	1729	5253	0	1615	0	0	0

Capacity Analysis Module:

Vol/Sat:	0.07	0.24	0.00	0.00	0.32	0.00	0.14	0.00	0.20	0.00	0.00	0.00
Crit Moves:	****				****				****			
Green/Cycle:	0.12	0.63	0.00	0.00	0.51	0.00	0.32	0.00	0.32	0.00	0.00	0.00
Volume/Cap:	0.63	0.38	0.00	0.00	0.63	0.00	0.43	0.00	0.63	0.00	0.00	0.00
Delay/Veh:	47.9	9.3	0.0	0.0	18.4	0.0	26.7	0.0	31.1	0.0	0.0	0.0
User DelAdj:	1.00	1.00	1.00	1.00	1.00	1.00	1.00	1.00	1.00	1.00	1.00	1.00
AdjDel/Veh:	47.9	9.3	0.0	0.0	18.4	0.0	26.7	0.0	31.1	0.0	0.0	0.0
LOS by Move:	D	A	A	A	B	A	C	A	C	A	A	A
HCM2k85thQ:	8	10	0	0	21	0	10	0	14	0	0	0

 Note: Queue reported is the number of cars per lane.

Santa Ana Circulation Element

Level Of Service Computation Report

ICU 1(Loss as Cycle Length %) Method (Base Volume Alternative)

Intersection #43 Flower St and Santa Ana Blvd

Cycle (sec): 100 Critical Vol./Cap.(X): 0.668
Loss Time (sec): 5 Average Delay (sec/veh): xxxxxx
Optimal Cycle: 34 Level Of Service: B

Table with 4 columns: North Bound, South Bound, East Bound, West Bound. Rows include Movement (L-T-R), Control (Prot+Permit), Rights (Include), Min. Green, Y+R, and Lanes.

Volume Module table with 12 columns representing different traffic movements and 10 rows of adjustment factors like Base Vol, Growth Adj, PHF Adj, etc.

Saturation Flow Module table with 12 columns and 4 rows showing Sat/Lane, Adjustment, Lanes, and Final Sat.

Capacity Analysis Module table with 12 columns and 3 rows showing Vol/Sat, Crit Moves, and other capacity metrics.

Santa Ana Circulation Element

Level Of Service Computation Report

ICU 1(Loss as Cycle Length %) Method (Base Volume Alternative)

Intersection #44 Flower St and 1st St

Cycle (sec): 100 Critical Vol./Cap.(X): 1.215
Loss Time (sec): 5 Average Delay (sec/veh): xxxxxx
Optimal Cycle: 180 Level Of Service: F

Table with 4 columns: North Bound, South Bound, East Bound, West Bound. Rows include Movement, Control, Rights, Min. Green, Y+R, and Lanes.

Volume Module table with 12 columns and 12 rows including Base Vol, Growth Adj, Initial Bse, User Adj, PHF Adj, PHF Volume, Reduct Vol, Reduced Vol, PCE Adj, MLF Adj, and Final Volume.

Saturation Flow Module table with 12 columns and 4 rows including Sat/Lane, Adjustment, Lanes, and Final Sat.

Capacity Analysis Module table with 12 columns and 2 rows including Vol/Sat and Crit Moves.

Santa Ana Circulation Element

Level Of Service Computation Report

ICU 1(Loss as Cycle Length %) Method (Base Volume Alternative)

Intersection #45 Flower St and McFadden Ave

Cycle (sec): 100 Critical Vol./Cap.(X): 0.968
Loss Time (sec): 5 Average Delay (sec/veh): xxxxxx
Optimal Cycle: 159 Level Of Service: E

Table with 4 columns: North Bound, South Bound, East Bound, West Bound. Rows include Movement, Control, Rights, Min. Green, Y+R, and Lanes.

Volume Module: Table with 12 columns representing different volume categories and their values.

Saturation Flow Module: Table with 12 columns representing saturation flow values and adjustment factors.

Capacity Analysis Module: Table with 12 columns representing capacity analysis values.

Santa Ana Circulation Element

Level Of Service Computation Report

ICU 1(Loss as Cycle Length %) Method (Base Volume Alternative)

Intersection #46 Flower St and Segerstrom Ave

Cycle (sec): 100 Critical Vol./Cap.(X): 0.916
 Loss Time (sec): 5 Average Delay (sec/veh): xxxxxx
 Optimal Cycle: 97 Level Of Service: E

Approach:	North Bound			South Bound			East Bound			West Bound		
Movement:	L	T	R	L	T	R	L	T	R	L	T	R
Control:	Permitted			Permitted			Protected			Protected		
Rights:	Include			Include			Include			Include		
Min. Green:	0	0	0	0	0	0	0	0	0	0	0	0
Y+R:	4.0	4.0	4.0	4.0	4.0	4.0	4.0	4.0	4.0	4.0	4.0	4.0
Lanes:	1	0	1	1	0	1	2	1	0	1	0	2

Volume Module:

Base Vol:	120	843	80	80	449	129	241	1198	126	101	1699	109
Growth Adj:	1.00	1.00	1.00	1.00	1.00	1.00	1.00	1.00	1.00	1.00	1.00	1.00
Initial Bse:	120	843	80	80	449	129	241	1198	126	101	1699	109
User Adj:	1.00	1.00	1.00	1.00	1.00	1.00	1.00	1.00	1.00	1.00	1.00	1.00
PHF Adj:	1.00	1.00	1.00	1.00	1.00	1.00	1.00	1.00	1.00	1.00	1.00	1.00
PHF Volume:	120	843	80	80	449	129	241	1198	126	101	1699	109
Reduct Vol:	0	0	0	0	0	0	0	0	0	0	0	0
Reduced Vol:	120	843	80	80	449	129	241	1198	126	101	1699	109
PCE Adj:	1.00	1.00	1.00	1.00	1.00	1.00	1.00	1.00	1.00	1.00	1.00	1.00
MLF Adj:	1.00	1.00	1.00	1.00	1.00	1.00	1.00	1.00	1.00	1.00	1.00	1.00
FinalVolume:	120	843	80	80	449	129	241	1198	126	101	1699	109

Saturation Flow Module:

Sat/Lane:	1600	1600	1600	1600	1600	1600	1600	1600	1600	1600	1600	1600
Adjustment:	1.00	1.03	1.00	1.00	1.04	1.00	1.00	1.05	1.00	1.00	1.04	1.00
Lanes:	1.00	1.83	0.17	1.00	1.55	0.45	1.00	2.71	0.29	1.00	2.82	0.18
Final Sat.:	1600	3023	277	1600	2586	714	1600	4543	457	1600	4711	289

Capacity Analysis Module:

Vol/Sat:	0.08	0.28	0.29	0.05	0.17	0.18	0.15	0.26	0.28	0.06	0.36	0.38
Crit Moves:			****	****			****					****

Santa Ana Circulation Element

Level Of Service Computation Report

ICU 1(Loss as Cycle Length %) Method (Base Volume Alternative)

Intersection #47 Flower St and MacArthur Blvd

Cycle (sec): 100 Critical Vol./Cap.(X): 0.908
 Loss Time (sec): 5 Average Delay (sec/veh): xxxxxx
 Optimal Cycle: 92 Level Of Service: E

Approach:	North Bound			South Bound			East Bound			West Bound		
Movement:	L	T	R	L	T	R	L	T	R	L	T	R
Control:	Permitted			Permitted			Protected			Protected		
Rights:	Include			Include			Include			Include		
Min. Green:	0	0	0	0	0	0	0	0	0	0	0	0
Y+R:	4.0	4.0	4.0	4.0	4.0	4.0	4.0	4.0	4.0	4.0	4.0	4.0
Lanes:	1	0	1	1	0	1	1	0	2	1	0	2

Volume Module:

Base Vol:	116	553	65	97	233	224	264	1254	80	61	1967	175
Growth Adj:	1.00	1.00	1.00	1.00	1.00	1.00	1.00	1.00	1.00	1.00	1.00	1.00
Initial Bse:	116	553	65	97	233	224	264	1254	80	61	1967	175
User Adj:	1.00	1.00	1.00	1.00	1.00	1.00	1.00	1.00	1.00	1.00	1.00	1.00
PHF Adj:	1.00	1.00	1.00	1.00	1.00	1.00	1.00	1.00	1.00	1.00	1.00	1.00
PHF Volume:	116	553	65	97	233	224	264	1254	80	61	1967	175
Reduct Vol:	0	0	0	0	0	0	0	0	0	0	0	0
Reduced Vol:	116	553	65	97	233	224	264	1254	80	61	1967	175
PCE Adj:	1.00	1.00	1.00	1.00	1.00	1.00	1.00	1.00	1.00	1.00	1.00	1.00
MLF Adj:	1.00	1.00	1.00	1.00	1.00	1.00	1.00	1.00	1.00	1.00	1.00	1.00
FinalVolume:	116	553	65	97	233	224	264	1254	80	61	1967	175

Saturation Flow Module:

Sat/Lane:	1600	1600	1600	1600	1600	1600	1600	1600	1600	1600	1600	1600
Adjustment:	1.00	1.03	1.00	1.00	1.06	1.00	1.00	1.04	1.00	1.00	1.05	1.00
Lanes:	1.00	1.79	0.21	1.00	1.02	0.98	1.00	2.82	0.18	1.00	2.75	0.25
Final Sat.:	1600	2963	337	1600	1732	1568	1600	4712	288	1600	4608	392

Capacity Analysis Module:

Vol/Sat:	0.07	0.19	0.19	0.06	0.13	0.14	0.17	0.27	0.28	0.04	0.43	0.45
Crit Moves:	****			****			****			****		

Santa Ana Circulation Element

Level Of Service Computation Report

ICU 1(Loss as Cycle Length %) Method (Base Volume Alternative)

Intersection #48 Main St and La Veta Ave

Cycle (sec): 100 Critical Vol./Cap.(X): 0.764
 Loss Time (sec): 5 Average Delay (sec/veh): xxxxxx
 Optimal Cycle: 45 Level Of Service: C

Approach:	North Bound			South Bound			East Bound			West Bound								
Movement:	L	T	R	L	T	R	L	T	R	L	T	R						
Control:	Protected			Protected			Protected			Protected								
Rights:	Ovl			Include			Include			Ovl								
Min. Green:	0	0	0	0	0	0	0	0	0	0	0	0						
Y+R:	4.0	4.0	4.0	4.0	4.0	4.0	4.0	4.0	4.0	4.0	4.0	4.0						
Lanes:	2	0	3	0	1		2	0	2	1	0		2	0	2	0	1	

Volume Module:

Base Vol:	310	948	444	191	1199	309	347	495	222	332	662	266
Growth Adj:	1.00	1.00	1.00	1.00	1.00	1.00	1.00	1.00	1.00	1.00	1.00	1.00
Initial Bse:	310	948	444	191	1199	309	347	495	222	332	662	266
User Adj:	1.00	1.00	1.00	1.00	1.00	1.00	1.00	1.00	1.00	1.00	1.00	1.00
PHF Adj:	1.00	1.00	1.00	1.00	1.00	1.00	1.00	1.00	1.00	1.00	1.00	1.00
PHF Volume:	310	948	444	191	1199	309	347	495	222	332	662	266
Reduct Vol:	0	0	0	0	0	0	0	0	0	0	0	0
Reduced Vol:	310	948	444	191	1199	309	347	495	222	332	662	266
PCE Adj:	1.00	1.00	1.00	1.00	1.00	1.00	1.00	1.00	1.00	1.00	1.00	1.00
MLF Adj:	1.00	1.00	1.00	1.00	1.00	1.00	1.00	1.00	1.00	1.00	1.00	1.00
FinalVolume:	310	948	444	191	1199	309	347	495	222	332	662	266
OvlAdjVol:	278									171		

Saturation Flow Module:

Sat/Lane:	1600	1600	1600	1600	1600	1600	1600	1600	1600	1600	1600	1600
Adjustment:	1.00	1.06	1.00	1.00	1.05	1.00	1.00	1.06	1.00	1.00	1.06	1.00
Lanes:	2.00	3.00	1.00	2.00	2.39	0.61	2.00	2.07	0.93	2.00	2.00	1.00
Final Sat.:	3200	5100	1600	3200	4016	984	3200	3514	1486	3200	3400	1600

Capacity Analysis Module:

Vol/Sat:	0.10	0.19	0.28	0.06	0.30	0.31	0.11	0.14	0.15	0.10	0.19	0.17
OvlAdjV/S:	0.17									0.11		
Crit Moves:	****			****			****			****		

Santa Ana Circulation Element

Level Of Service Computation Report

ICU 1(Loss as Cycle Length %) Method (Base Volume Alternative)

Intersection #49 Main St and Mainplace Dr / Memory Ln

Cycle (sec): 100 Critical Vol./Cap.(X): 0.504
Loss Time (sec): 5 Average Delay (sec/veh): xxxxxx
Optimal Cycle: 24 Level Of Service: A

Table with 4 columns: North Bound, South Bound, East Bound, West Bound. Rows include Movement, Control, Rights, Min. Green, Y+R, and Lanes.

Volume Module table with 12 columns representing different traffic volumes and adjustment factors.

Saturation Flow Module table with 12 columns representing saturation flow rates and adjustments.

Capacity Analysis Module table with 12 columns representing capacity analysis metrics.

Santa Ana Circulation Element

Level Of Service Computation Report

ICU 1(Loss as Cycle Length %) Method (Base Volume Alternative)

Intersection #50 Main St and 17th St

Cycle (sec): 100 Critical Vol./Cap.(X): 0.799
 Loss Time (sec): 5 Average Delay (sec/veh): xxxxxx
 Optimal Cycle: 52 Level Of Service: C

Approach:	North Bound			South Bound			East Bound			West Bound		
Movement:	L	T	R	L	T	R	L	T	R	L	T	R
Control:	Protected			Protected			Protected			Protected		
Rights:	Include			Include			Include			Include		
Min. Green:	0	0	0	0	0	0	0	0	0	0	0	0
Y+R:	4.0	4.0	4.0	4.0	4.0	4.0	4.0	4.0	4.0	4.0	4.0	4.0
Lanes:	2	0	2	0	2	1	2	0	2	1	0	2

Volume Module:

Base Vol:	239	1237	270	243	1062	164	174	975	58	187	1147	76
Growth Adj:	1.00	1.00	1.00	1.00	1.00	1.00	1.00	1.00	1.00	1.00	1.00	1.00
Initial Bse:	239	1237	270	243	1062	164	174	975	58	187	1147	76
User Adj:	1.00	1.00	1.00	1.00	1.00	1.00	1.00	1.00	1.00	1.00	1.00	1.00
PHF Adj:	1.00	1.00	1.00	1.00	1.00	1.00	1.00	1.00	1.00	1.00	1.00	1.00
PHF Volume:	239	1237	270	243	1062	164	174	975	58	187	1147	76
Reduct Vol:	0	0	0	0	0	0	0	0	0	0	0	0
Reduced Vol:	239	1237	270	243	1062	164	174	975	58	187	1147	76
PCE Adj:	1.00	1.00	1.00	1.00	1.00	1.00	1.00	1.00	1.00	1.00	1.00	1.00
MLF Adj:	1.00	1.00	1.00	1.00	1.00	1.00	1.00	1.00	1.00	1.00	1.00	1.00
FinalVolume:	239	1237	270	243	1062	164	174	975	58	187	1147	76

Saturation Flow Module:

Sat/Lane:	1600	1600	1600	1600	1600	1600	1600	1600	1600	1600	1600	1600
Adjustment:	1.00	1.06	1.00	1.00	1.06	1.00	1.00	1.04	1.00	1.00	1.04	1.00
Lanes:	2.00	2.00	1.00	2.00	2.00	1.00	2.00	2.83	0.17	2.00	2.81	0.19
Final Sat.:	3200	3400	1600	3200	3400	1600	3200	4730	270	3200	4702	298

Capacity Analysis Module:

Vol/Sat:	0.07	0.36	0.17	0.08	0.31	0.10	0.05	0.21	0.22	0.06	0.24	0.25
Crit Moves:	****			****			****			****		

Santa Ana Circulation Element

Level Of Service Computation Report

ICU 1(Loss as Cycle Length %) Method (Base Volume Alternative)

Intersection #51 Main St and Civic Center Dr

Cycle (sec): 100 Critical Vol./Cap.(X): 0.856
Loss Time (sec): 5 Average Delay (sec/veh): xxxxxx
Optimal Cycle: 67 Level Of Service: D

Table with 4 columns: North Bound, South Bound, East Bound, West Bound. Rows include Movement (L-T-R), Control (Permitted), Rights (Include), Min. Green, Y+R, and Lanes.

Volume Module: Table with 12 columns representing different traffic volumes and adjustment factors like Base Vol, Growth Adj, Initial Bse, User Adj, PHF Adj, PHF Volume, Reduct Vol, Reduced Vol, PCE Adj, MLF Adj, Final Volume.

Saturation Flow Module: Table with 12 columns for saturation flow values and adjustment factors like Sat/Lane, Adjustment, Lanes, Final Sat.

Capacity Analysis Module: Table with 12 columns for capacity analysis metrics like Vol/Sat, Crit Moves.

Santa Ana Circulation Element

Level Of Service Computation Report

ICU 1(Loss as Cycle Length %) Method (Base Volume Alternative)

Intersection #52 Main St and Santa Ana Blvd

Cycle (sec): 100 Critical Vol./Cap.(X): 0.700
 Loss Time (sec): 5 Average Delay (sec/veh): xxxxxx
 Optimal Cycle: 37 Level Of Service: C

Approach:	North Bound			South Bound			East Bound			West Bound		
Movement:	L	T	R	L	T	R	L	T	R	L	T	R
Control:	Permitted			Permitted			Permitted			Permitted		
Rights:	Include			Include			Include			Include		
Min. Green:	0	0	0	0	0	0	0	0	0	0	0	0
Y+R:	4.0	4.0	4.0	4.0	4.0	4.0	4.0	4.0	4.0	4.0	4.0	4.0
Lanes:	1	0	2	0	0	1	0	0	0	0	1	0

Volume Module:

Base Vol:	56	1280	0	0	1108	54	0	0	0	65	656	85
Growth Adj:	1.00	1.00	1.00	1.00	1.00	1.00	1.00	1.00	1.00	1.00	1.00	1.00
Initial Bse:	56	1280	0	0	1108	54	0	0	0	65	656	85
User Adj:	1.00	1.00	1.00	1.00	1.00	1.00	1.00	1.00	1.00	1.00	1.00	1.00
PHF Adj:	1.00	1.00	1.00	1.00	1.00	1.00	1.00	1.00	1.00	1.00	1.00	1.00
PHF Volume:	56	1280	0	0	1108	54	0	0	0	65	656	85
Reduct Vol:	0	0	0	0	0	0	0	0	0	0	0	0
Reduced Vol:	56	1280	0	0	1108	54	0	0	0	65	656	85
PCE Adj:	1.00	1.00	1.00	1.00	1.00	1.00	1.00	1.00	1.00	1.00	1.00	1.00
MLF Adj:	1.00	1.00	1.00	1.00	1.00	1.00	1.00	1.00	1.00	1.00	1.00	1.00
FinalVolume:	56	1280	0	0	1108	54	0	0	0	65	656	85

Saturation Flow Module:

Sat/Lane:	1600	1600	1600	1600	1600	1600	1600	1600	1600	1600	1600	1600
Adjustment:	1.00	1.06	1.00	1.00	1.03	1.00	1.00	1.06	1.00	1.00	1.00	1.00
Lanes:	1.00	2.00	0.00	0.00	1.91	0.09	0.00	0.00	0.00	0.16	1.63	0.21
Final Sat.:	1600	3400	0	0	3151	149	0	0	0	258	2604	337

Capacity Analysis Module:

Vol/Sat:	0.04	0.38	0.00	0.00	0.35	0.36	0.00	0.00	0.00	0.04	0.25	0.25
Crit Moves:	****					****					****	

Santa Ana Circulation Element

Level Of Service Computation Report

ICU 1(Loss as Cycle Length %) Method (Base Volume Alternative)

Intersection #53 Main St and 4th St

Cycle (sec): 100 Critical Vol./Cap.(X): 0.472
 Loss Time (sec): 5 Average Delay (sec/veh): xxxxxx
 Optimal Cycle: 22 Level Of Service: A

Approach:	North Bound			South Bound			East Bound			West Bound		
Movement:	L	T	R	L	T	R	L	T	R	L	T	R
Control:	Permitted			Permitted			Permitted			Permitted		
Rights:	Include			Include			Include			Include		
Min. Green:	0	0	0	0	0	0	0	0	0	0	0	0
Y+R:	4.0	4.0	4.0	4.0	4.0	4.0	4.0	4.0	4.0	4.0	4.0	4.0
Lanes:	0	0	1	1	0	0	0	0	1	1	0	0

Volume Module:

Base Vol:	0	1108	53	0	951	43	0	112	63	0	157	40
Growth Adj:	1.00	1.00	1.00	1.00	1.00	1.00	1.00	1.00	1.00	1.00	1.00	1.00
Initial Bse:	0	1108	53	0	951	43	0	112	63	0	157	40
User Adj:	1.00	1.00	1.00	1.00	1.00	1.00	1.00	1.00	1.00	1.00	1.00	1.00
PHF Adj:	1.00	1.00	1.00	1.00	1.00	1.00	1.00	1.00	1.00	1.00	1.00	1.00
PHF Volume:	0	1108	53	0	951	43	0	112	63	0	157	40
Reduct Vol:	0	0	0	0	0	0	0	0	0	0	0	0
Reduced Vol:	0	1108	53	0	951	43	0	112	63	0	157	40
PCE Adj:	1.00	1.00	1.00	1.00	1.00	1.00	1.00	1.00	1.00	1.00	1.00	1.00
MLF Adj:	1.00	1.00	1.00	1.00	1.00	1.00	1.00	1.00	1.00	1.00	1.00	1.00
FinalVolume:	0	1108	53	0	951	43	0	112	63	0	157	40

Saturation Flow Module:

Sat/Lane:	1600	1600	1600	1600	1600	1600	1600	1600	1600	1600	1600	1600
Adjustment:	1.00	1.03	1.00	1.00	1.03	1.00	1.00	1.05	1.00	1.00	1.04	1.00
Lanes:	0.00	1.91	0.09	0.00	1.91	0.09	0.00	1.28	0.72	0.00	1.59	0.41
Final Sat.:	0	3154	146	0	3162	138	0	2148	1152	0	2650	650

Capacity Analysis Module:

Vol/Sat:	0.00	0.35	0.36	0.00	0.30	0.31	0.00	0.05	0.05	0.00	0.06	0.06
Crit Moves:			****	****			****			****		

Santa Ana Circulation Element

Level Of Service Computation Report

ICU 1(Loss as Cycle Length %) Method (Base Volume Alternative)

Intersection #54 Main St and 1st St

Cycle (sec): 100 Critical Vol./Cap.(X): 0.803
 Loss Time (sec): 5 Average Delay (sec/veh): xxxxxx
 Optimal Cycle: 53 Level Of Service: D

Approach:	North Bound			South Bound			East Bound			West Bound		
Movement:	L	T	R	L	T	R	L	T	R	L	T	R
Control:	Protected			Protected			Protected			Protected		
Rights:	Include			Include			Include			Include		
Min. Green:	0	0	0	0	0	0	0	0	0	0	0	0
Y+R:	4.0	4.0	4.0	4.0	4.0	4.0	4.0	4.0	4.0	4.0	4.0	4.0
Lanes:	1	0	1	1	0	1	1	0	1	1	0	1

Volume Module:

Base Vol:	179	875	76	160	615	131	91	921	68	75	834	58
Growth Adj:	1.00	1.00	1.00	1.00	1.00	1.00	1.00	1.00	1.00	1.00	1.00	1.00
Initial Bse:	179	875	76	160	615	131	91	921	68	75	834	58
User Adj:	1.00	1.00	1.00	1.00	1.00	1.00	1.00	1.00	1.00	1.00	1.00	1.00
PHF Adj:	1.00	1.00	1.00	1.00	1.00	1.00	1.00	1.00	1.00	1.00	1.00	1.00
PHF Volume:	179	875	76	160	615	131	91	921	68	75	834	58
Reduct Vol:	0	0	0	0	0	0	0	0	0	0	0	0
Reduced Vol:	179	875	76	160	615	131	91	921	68	75	834	58
PCE Adj:	1.00	1.00	1.00	1.00	1.00	1.00	1.00	1.00	1.00	1.00	1.00	1.00
MLF Adj:	1.00	1.00	1.00	1.00	1.00	1.00	1.00	1.00	1.00	1.00	1.00	1.00
FinalVolume:	179	875	76	160	615	131	91	921	68	75	834	58

Saturation Flow Module:

Sat/Lane:	1600	1600	1600	1600	1600	1600	1600	1600	1600	1600	1600	1600
Adjustment:	1.00	1.03	1.00	1.00	1.06	1.00	1.00	1.03	1.00	1.00	1.03	1.00
Lanes:	1.00	1.84	0.16	1.00	2.00	1.00	1.00	1.86	0.14	1.00	1.87	0.13
Final Sat.:	1600	3044	256	1600	3400	1600	1600	3080	220	1600	3092	208

Capacity Analysis Module:

Vol/Sat:	0.11	0.29	0.30	0.10	0.18	0.08	0.06	0.30	0.31	0.05	0.27	0.28
Crit Moves:			****	****					****	****		

Santa Ana Circulation Element

Level Of Service Computation Report

ICU 1(Loss as Cycle Length %) Method (Base Volume Alternative)

Intersection #55 Main St and McFadden Ave

Cycle (sec): 100 Critical Vol./Cap.(X): 0.935
Loss Time (sec): 5 Average Delay (sec/veh): xxxxxx
Optimal Cycle: 113 Level Of Service: E

Table with 4 columns: North Bound, South Bound, East Bound, West Bound. Rows include Movement (L-T-R), Control (Prot+Permit, Protected), Rights (Include), Min. Green, Y+R, and Lanes.

Volume Module: Table with 12 columns representing different volume categories and 12 rows for various adjustment factors like Base Vol, Growth Adj, PHF Adj, etc.

Saturation Flow Module: Table with 12 columns for saturation flow values and 4 rows for Sat/Lane, Adjustment, Lanes, and Final Sat.

Capacity Analysis Module: Table with 12 columns for capacity analysis values and 3 rows for Vol/Sat, Crit Moves, and asterisks.

Santa Ana Circulation Element

Level Of Service Computation Report

ICU 1(Loss as Cycle Length %) Method (Base Volume Alternative)

Intersection #56 Main St and Edinger Ave

Cycle (sec): 100 Critical Vol./Cap.(X): 0.977
 Loss Time (sec): 5 Average Delay (sec/veh): xxxxxx
 Optimal Cycle: 177 Level Of Service: E

Approach:	North Bound			South Bound			East Bound			West Bound		
Movement:	L	T	R	L	T	R	L	T	R	L	T	R
Control:	Protected			Protected			Protected			Protected		
Rights:	Include			Include			Include			Include		
Min. Green:	0	0	0	0	0	0	0	0	0	0	0	0
Y+R:	4.0	4.0	4.0	4.0	4.0	4.0	4.0	4.0	4.0	4.0	4.0	4.0
Lanes:	1	0	1	1	0	1	1	0	2	1	0	2

Volume Module:

Base Vol:	111	1181	54	129	646	88	159	940	105	117	1569	162
Growth Adj:	1.00	1.00	1.00	1.00	1.00	1.00	1.00	1.00	1.00	1.00	1.00	1.00
Initial Bse:	111	1181	54	129	646	88	159	940	105	117	1569	162
User Adj:	1.00	1.00	1.00	1.00	1.00	1.00	1.00	1.00	1.00	1.00	1.00	1.00
PHF Adj:	1.00	1.00	1.00	1.00	1.00	1.00	1.00	1.00	1.00	1.00	1.00	1.00
PHF Volume:	111	1181	54	129	646	88	159	940	105	117	1569	162
Reduct Vol:	0	0	0	0	0	0	0	0	0	0	0	0
Reduced Vol:	111	1181	54	129	646	88	159	940	105	117	1569	162
PCE Adj:	1.00	1.00	1.00	1.00	1.00	1.00	1.00	1.00	1.00	1.00	1.00	1.00
MLF Adj:	1.00	1.00	1.00	1.00	1.00	1.00	1.00	1.00	1.00	1.00	1.00	1.00
FinalVolume:	111	1181	54	129	646	88	159	940	105	117	1569	162

Saturation Flow Module:

Sat/Lane:	1600	1600	1600	1600	1600	1600	1600	1600	1600	1600	1600	1600
Adjustment:	1.00	1.03	1.00	1.00	1.04	1.00	1.00	1.05	1.00	1.00	1.05	1.00
Lanes:	1.00	1.91	0.09	1.00	1.76	0.24	1.00	2.70	0.30	1.00	2.72	0.28
Final Sat.:	1600	3160	140	1600	2916	384	1600	4518	482	1600	4551	449

Capacity Analysis Module:

Vol/Sat:	0.07	0.37	0.39	0.08	0.22	0.23	0.10	0.21	0.22	0.07	0.34	0.36
Crit Moves:			****	****			****					****

Santa Ana Circulation Element

Level Of Service Computation Report

ICU 1(Loss as Cycle Length %) Method (Base Volume Alternative)

Intersection #57 Main St and MacArthur Blvd

Cycle (sec): 100 Critical Vol./Cap.(X): 0.781
 Loss Time (sec): 5 Average Delay (sec/veh): xxxxxx
 Optimal Cycle: 48 Level Of Service: C

Approach:	North Bound			South Bound			East Bound			West Bound		
Movement:	L	T	R	L	T	R	L	T	R	L	T	R
Control:	Protected			Protected			Protected			Protected		
Rights:	Include			Include			Include			Include		
Min. Green:	0	0	0	0	0	0	0	0	0	0	0	0
Y+R:	4.0	4.0	4.0	4.0	4.0	4.0	4.0	4.0	4.0	4.0	4.0	4.0
Lanes:	2	0	3	0	1		2	0	3	0	1	

Volume Module:

Base Vol:	488	1169	321	271	352	266	385	792	76	188	1488	432
Growth Adj:	1.00	1.00	1.00	1.00	1.00	1.00	1.00	1.00	1.00	1.00	1.00	1.00
Initial Bse:	488	1169	321	271	352	266	385	792	76	188	1488	432
User Adj:	1.00	1.00	1.00	1.00	1.00	1.00	1.00	1.00	1.00	1.00	1.00	1.00
PHF Adj:	1.00	1.00	1.00	1.00	1.00	1.00	1.00	1.00	1.00	1.00	1.00	1.00
PHF Volume:	488	1169	321	271	352	266	385	792	76	188	1488	432
Reduct Vol:	0	0	0	0	0	0	0	0	0	0	0	0
Reduced Vol:	488	1169	321	271	352	266	385	792	76	188	1488	432
PCE Adj:	1.00	1.00	1.00	1.00	1.00	1.00	1.00	1.00	1.00	1.00	1.00	1.00
MLF Adj:	1.00	1.00	1.00	1.00	1.00	1.00	1.00	1.00	1.00	1.00	1.00	1.00
Final Volume:	488	1169	321	271	352	266	385	792	76	188	1488	432

Saturation Flow Module:

Sat/Lane:	1600	1600	1600	1600	1600	1600	1600	1600	1600	1600	1600	1600
Adjustment:	1.00	1.06	1.00	1.00	1.06	1.00	1.00	1.06	1.00	1.00	1.06	1.00
Lanes:	2.00	3.00	1.00	2.00	3.00	1.00	2.00	3.00	1.00	2.00	3.00	1.00
Final Sat.:	3200	5100	1600	3200	5100	1600	3200	5100	1600	3200	5100	1600

Capacity Analysis Module:

Vol/Sat:	0.15	0.23	0.20	0.08	0.07	0.17	0.12	0.16	0.05	0.06	0.29	0.27
Crit Moves:	****					****	****				****	

Santa Ana Circulation Element

Level Of Service Computation Report
 2000 HCM Operations Method (Base Volume Alternative)

 Intersection #58 Penn Wy and 17th St

Cycle (sec): 100 Critical Vol./Cap.(X): 0.790
 Loss Time (sec): 5 Average Delay (sec/veh): 20.3
 Optimal Cycle: 52 Level Of Service: C

Approach:	North Bound			South Bound			East Bound			West Bound		
Movement:	L	T	R	L	T	R	L	T	R	L	T	R
Control:	Split Phase			Split Phase			Protected			Protected		
Rights:	Include			Include			Include			Include		
Min. Green:	0	0	0	0	0	0	0	0	0	0	0	0
Y+R:	4.0	4.0	4.0	4.0	4.0	4.0	4.0	4.0	4.0	4.0	4.0	4.0
Lanes:	2	0	0	0	0	0	2	1	0	1	0	0

Volume Module:

Base Vol:	795	0	388	0	0	0	0	1712	552	126	1480	0
Growth Adj:	1.00	1.00	1.00	1.00	1.00	1.00	1.00	1.00	1.00	1.00	1.00	1.00
Initial Bse:	795	0	388	0	0	0	0	1712	552	126	1480	0
User Adj:	1.00	1.00	1.00	1.00	1.00	1.00	1.00	1.00	1.00	1.00	1.00	1.00
PHF Adj:	1.00	1.00	1.00	1.00	1.00	1.00	1.00	1.00	1.00	1.00	1.00	1.00
PHF Volume:	795	0	388	0	0	0	0	1712	552	126	1480	0
Reduct Vol:	0	0	0	0	0	0	0	0	0	0	0	0
Reduced Vol:	795	0	388	0	0	0	0	1712	552	126	1480	0
PCE Adj:	1.00	1.00	1.00	1.00	1.00	1.00	1.00	1.00	1.00	1.00	1.00	1.00
MLF Adj:	1.00	1.00	1.00	1.00	1.00	1.00	1.00	1.00	1.00	1.00	1.00	1.00
FinalVolume:	795	0	388	0	0	0	0	1712	552	126	1480	0

Saturation Flow Module:

Sat/Lane:	1900	1900	1900	1900	1900	1900	1900	1900	1900	1900	1900	1900
Adjustment:	0.92	1.00	0.75	1.00	1.00	1.00	1.00	0.88	0.88	0.95	0.91	1.00
Lanes:	2.00	0.00	2.00	0.00	0.00	0.00	0.00	2.27	0.73	1.00	3.00	0.00
Final Sat.:	3502	0	2842	0	0	0	0	3777	1218	1805	5187	0

Capacity Analysis Module:

Vol/Sat:	0.23	0.00	0.14	0.00	0.00	0.00	0.00	0.45	0.45	0.07	0.29	0.00
Crit Moves:	****							****		****		
Green/Cycle:	0.29	0.00	0.29	0.00	0.00	0.00	0.00	0.57	0.57	0.09	0.66	0.00
Volume/Cap:	0.79	0.00	0.47	0.00	0.00	0.00	0.00	0.79	0.79	0.79	0.43	0.00
Delay/Veh:	37.1	0.0	29.8	0.0	0.0	0.0	0.0	18.1	18.1	67.4	8.1	0.0
User DelAdj:	1.00	1.00	1.00	1.00	1.00	1.00	1.00	1.00	1.00	1.00	1.00	1.00
AdjDel/Veh:	37.1	0.0	29.8	0.0	0.0	0.0	0.0	18.1	18.1	67.4	8.1	0.0
LOS by Move:	D	A	C	A	A	A	A	B	B	E	A	A
HCM2k85thQ:	20	0	9	0	0	0	0	31	31	9	12	0

 Note: Queue reported is the number of cars per lane.

Santa Ana Circulation Element

Level Of Service Computation Report
 2000 HCM Operations Method (Base Volume Alternative)

 Intersection #59 I-5 NB Off Ramps/17th Street

Cycle (sec): 100 Critical Vol./Cap.(X): 0.630
 Loss Time (sec): 5 Average Delay (sec/veh): 20.3
 Optimal Cycle: 32 Level Of Service: C

Street Name:	I-5 NB Off Ramps						17th Street													
Approach:	North Bound			South Bound			East Bound			West Bound										
Movement:	L	T	R	L	T	R	L	T	R	L	T	R								
Control:	Split Phase			Split Phase			Protected			Permitted										
Rights:	Include			Include			Ignore			Include										
Min. Green:	0	0	0	0	0	0	0	0	0	0	0	0								
Y+R:	4.0	4.0	4.0	4.0	4.0	4.0	4.0	4.0	4.0	4.0	4.0	4.0								
Lanes:	1	1	0	0	1	1	0	0	0	1	1	0	3	0	1	0	0	2	1	0

Volume Module:

Base Vol:	375	50	20	55	0	142	128	1168	767	0	1622	44
Growth Adj:	1.00	1.00	1.00	1.00	1.00	1.00	1.00	1.00	1.00	1.00	1.00	1.00
Initial Bse:	375	50	20	55	0	142	128	1168	767	0	1622	44
User Adj:	1.00	1.00	1.00	1.00	1.00	1.00	1.00	1.00	0.00	1.00	1.00	1.00
PHF Adj:	1.00	1.00	1.00	1.00	1.00	1.00	1.00	1.00	0.00	1.00	1.00	1.00
PHF Volume:	375	50	20	55	0	142	128	1168	0	0	1622	44
Reduct Vol:	0	0	0	0	0	0	0	0	0	0	0	0
Reduced Vol:	375	50	20	55	0	142	128	1168	0	0	1622	44
PCE Adj:	1.00	1.00	1.00	1.00	1.00	1.00	1.00	1.00	0.00	1.00	1.00	1.00
MLF Adj:	1.00	1.00	1.00	1.00	1.00	1.00	1.00	1.00	0.00	1.00	1.00	1.00
Final Volume:	375	50	20	55	0	142	128	1168	0	0	1622	44

Saturation Flow Module:

Sat/Lane:	1900	1900	1900	1900	1900	1900	1900	1900	1900	1900	1900	1900
Adjustment:	0.96	0.96	0.85	0.95	1.00	0.85	0.95	0.91	1.00	1.00	0.91	0.91
Lanes:	1.76	0.24	1.00	1.00	0.00	1.00	1.00	3.00	1.00	0.00	2.92	0.08
Final Sat.:	3212	428	1615	1805	0	1615	1805	5187	1900	0	5030	136

Capacity Analysis Module:

Vol/Sat:	0.12	0.12	0.01	0.03	0.00	0.09	0.07	0.23	0.00	0.00	0.32	0.32
Crit Moves:	****			****			****			****		
Green/Cycle:	0.19	0.19	0.19	0.14	0.00	0.14	0.11	0.62	0.00	0.00	0.51	0.51
Volume/Cap:	0.63	0.63	0.07	0.22	0.00	0.63	0.63	0.36	0.00	0.00	0.63	0.63
Delay/Veh:	39.5	39.5	33.7	38.6	0.0	46.2	48.6	9.1	0.0	0.0	18.1	18.1
User DelAdj:	1.00	1.00	1.00	1.00	1.00	1.00	1.00	1.00	1.00	1.00	1.00	1.00
AdjDel/Veh:	39.5	39.5	33.7	38.6	0.0	46.2	48.6	9.1	0.0	0.0	18.1	18.1
LOS by Move:	D	D	C	D	A	D	D	A	A	A	B	B
HCM2k85thQ:	11	11	1	3	0	8	8	10	0	0	21	21

Note: Queue reported is the number of cars per lane.

Santa Ana Circulation Element

Level Of Service Computation Report
 2000 HCM Operations Method (Base Volume Alternative)

 Intersection #60 Penn Wy and I-5 SB Ramps

Cycle (sec): 100 Critical Vol./Cap.(X): 0.433
 Loss Time (sec): 5 Average Delay (sec/veh): 22.8
 Optimal Cycle: 22 Level Of Service: C

Approach:	North Bound			South Bound			East Bound			West Bound		
Movement:	L	T	R	L	T	R	L	T	R	L	T	R
Control:	Protected			Protected			Split Phase			Split Phase		
Rights:	Include			Include			Include			Ovl		
Min. Green:	0	0	0	0	0	0	0	0	0	0	0	0
Y+R:	4.0	4.0	4.0	4.0	4.0	4.0	4.0	4.0	4.0	4.0	4.0	4.0
Lanes:	0	0	2	0	1	1	2	0	0	0	0	2

Volume Module:

Base Vol:	0	363	238	508	117	0	0	0	0	214	0	183
Growth Adj:	1.00	1.00	1.00	1.00	1.00	1.00	1.00	1.00	1.00	1.00	1.00	1.00
Initial Bse:	0	363	238	508	117	0	0	0	0	214	0	183
User Adj:	1.00	1.00	1.00	1.00	1.00	1.00	1.00	1.00	1.00	1.00	1.00	1.00
PHF Adj:	1.00	1.00	1.00	1.00	1.00	1.00	1.00	1.00	1.00	1.00	1.00	1.00
PHF Volume:	0	363	238	508	117	0	0	0	0	214	0	183
Reduct Vol:	0	0	0	0	0	0	0	0	0	0	0	0
Reduced Vol:	0	363	238	508	117	0	0	0	0	214	0	183
PCE Adj:	1.00	1.00	1.00	1.00	1.00	1.00	1.00	1.00	1.00	1.00	1.00	1.00
MLF Adj:	1.00	1.00	1.00	1.00	1.00	1.00	1.00	1.00	1.00	1.00	1.00	1.00
Final Volume:	0	363	238	508	117	0	0	0	0	214	0	183

Saturation Flow Module:

Sat/Lane:	1900	1900	1900	1900	1900	1900	1900	1900	1900	1900	1900	1900
Adjustment:	1.00	0.95	0.85	0.92	0.95	1.00	1.00	1.00	1.00	0.95	1.00	0.75
Lanes:	0.00	2.00	1.00	2.00	2.00	0.00	0.00	0.00	0.00	1.00	0.00	2.00
Final Sat.:	0	3610	1615	3502	3610	0	0	0	0	1805	0	2842

Capacity Analysis Module:

Vol/Sat:	0.00	0.10	0.15	0.15	0.03	0.00	0.00	0.00	0.00	0.12	0.00	0.06
Crit Moves:	****			****						****		
Green/Cycle:	0.00	0.34	0.34	0.34	0.68	0.00	0.00	0.00	0.00	0.27	0.00	0.61
Volume/Cap:	0.00	0.30	0.43	0.43	0.05	0.00	0.00	0.00	0.00	0.43	0.00	0.11
Delay/Veh:	0.0	24.3	26.0	26.1	5.4	0.0	0.0	0.0	0.0	30.5	0.0	8.2
User DelAdj:	1.00	1.00	1.00	1.00	1.00	1.00	1.00	1.00	1.00	1.00	1.00	1.00
AdjDel/Veh:	0.0	24.3	26.0	26.1	5.4	0.0	0.0	0.0	0.0	30.5	0.0	8.2
LOS by Move:	A	C	C	C	A	A	A	A	A	C	A	A
HCM2k85thQ:	0	7	9	10	1	0	0	0	0	9	0	2

 Note: Queue reported is the number of cars per lane.

Santa Ana Circulation Element

Level Of Service Computation Report
 2000 HCM 4-Way Stop Method (Base Volume Alternative)

 Intersection #61 Santiago St and Civic Center Dr

Cycle (sec): 100 Critical Vol./Cap.(X): 0.896
 Loss Time (sec): 5 Average Delay (sec/veh): 27.6
 Optimal Cycle: 0 Level Of Service: D

Approach:	North Bound			South Bound			East Bound			West Bound		
Movement:	L	T	R	L	T	R	L	T	R	L	T	R
Control:	Stop Sign			Stop Sign			Stop Sign			Stop Sign		
Rights:	Include			Include			Include			Include		
Min. Green:	0	0	0	0	0	0	0	0	0	0	0	0
Lanes:	1	0	0	1	0	0	1	0	0	0	0	1

Volume Module:

Base Vol:	133	411	41	20	281	72	266	76	269	14	19	18
Growth Adj:	1.00	1.00	1.00	1.00	1.00	1.00	1.00	1.00	1.00	1.00	1.00	1.00
Initial Bse:	133	411	41	20	281	72	266	76	269	14	19	18
User Adj:	1.00	1.00	1.00	1.00	1.00	1.00	1.00	1.00	1.00	1.00	1.00	1.00
PHF Adj:	1.00	1.00	1.00	1.00	1.00	1.00	1.00	1.00	1.00	1.00	1.00	1.00
PHF Volume:	133	411	41	20	281	72	266	76	269	14	19	18
Reduct Vol:	0	0	0	0	0	0	0	0	0	0	0	0
Reduced Vol:	133	411	41	20	281	72	266	76	269	14	19	18
PCE Adj:	1.00	1.00	1.00	1.00	1.00	1.00	1.00	1.00	1.00	1.00	1.00	1.00
MLF Adj:	1.00	1.00	1.00	1.00	1.00	1.00	1.00	1.00	1.00	1.00	1.00	1.00
FinalVolume:	133	411	41	20	281	72	266	76	269	14	19	18

Saturation Flow Module:

Adjustment:	1.00	1.00	1.00	1.00	1.00	1.00	1.00	1.00	1.00	1.00	1.00	1.00
Lanes:	1.00	0.91	0.09	1.00	0.80	0.20	1.00	0.22	0.78	0.27	0.38	0.35
Final Sat.:	462	459	46	437	385	99	452	115	406	107	145	138

Capacity Analysis Module:

Vol/Sat:	0.29	0.90	0.90	0.05	0.73	0.73	0.59	0.66	0.66	0.13	0.13	0.13
Crit Moves:	****			****			****			****		
Delay/Veh:	13.4	44.0	44.0	11.0	26.6	26.6	20.7	21.2	21.2	12.7	12.7	12.7
Delay Adj:	1.00	1.00	1.00	1.00	1.00	1.00	1.00	1.00	1.00	1.00	1.00	1.00
AdjDel/Veh:	13.4	44.0	44.0	11.0	26.6	26.6	20.7	21.2	21.2	12.7	12.7	12.7
LOS by Move:	B	E	E	B	D	D	C	C	C	B	B	B
ApproachDel:	37.0			25.8			21.0			12.7		
Delay Adj:	1.00			1.00			1.00			1.00		
ApprAdjDel:	37.0			25.8			21.0			12.7		
LOS by Appr:	E			D			C			B		
AllWayAvgQ:	0.4	4.8	4.8	0.0	2.2	2.2	1.3	1.7	1.7	0.1	0.1	0.1

 Note: Queue reported is the number of cars per lane.

Santa Ana Circulation Element

Level Of Service Computation Report

ICU 1(Loss as Cycle Length %) Method (Base Volume Alternative)

Intersection #62 Santiago St and Santa Ana Blvd

Cycle (sec): 100 Critical Vol./Cap.(X): 1.411
 Loss Time (sec): 5 Average Delay (sec/veh): xxxxxx
 Optimal Cycle: 180 Level Of Service: F

Approach:	North Bound			South Bound			East Bound			West Bound		
Movement:	L	T	R	L	T	R	L	T	R	L	T	R
Control:	Permitted			Permitted			Protected			Protected		
Rights:	Include			Include			Include			Include		
Min. Green:	0	0	0	0	0	0	0	0	0	0	0	0
Y+R:	4.0	4.0	4.0	4.0	4.0	4.0	4.0	4.0	4.0	4.0	4.0	4.0
Lanes:	1	0	1	0	1	0	1	0	0	1	0	1

Volume Module:

Base Vol:	135	833	236	378	639	103	164	673	87	255	546	347
Growth Adj:	1.00	1.00	1.00	1.00	1.00	1.00	1.00	1.00	1.00	1.00	1.00	1.00
Initial Bse:	135	833	236	378	639	103	164	673	87	255	546	347
User Adj:	1.00	1.00	1.00	1.00	1.00	1.00	1.00	1.00	1.00	1.00	1.00	1.00
PHF Adj:	1.00	1.00	1.00	1.00	1.00	1.00	1.00	1.00	1.00	1.00	1.00	1.00
PHF Volume:	135	833	236	378	639	103	164	673	87	255	546	347
Reduct Vol:	0	0	0	0	0	0	0	0	0	0	0	0
Reduced Vol:	135	833	236	378	639	103	164	673	87	255	546	347
PCE Adj:	1.00	1.00	1.00	1.00	1.00	1.00	1.00	1.00	1.00	1.00	1.00	1.00
MLF Adj:	1.00	1.00	1.00	1.00	1.00	1.00	1.00	1.00	1.00	1.00	1.00	1.00
FinalVolume:	135	833	236	378	639	103	164	673	87	255	546	347

Saturation Flow Module:

Sat/Lane:	1600	1600	1600	1600	1600	1600	1600	1600	1600	1600	1600	1600
Adjustment:	1.00	1.06	1.00	1.00	1.06	1.00	1.00	1.00	1.00	1.00	1.06	1.00
Lanes:	1.00	1.00	1.00	1.00	1.00	1.00	1.00	0.89	0.11	1.00	2.00	1.00
Final Sat.:	1600	1700	1600	1600	1700	1600	1600	1417	183	1600	3400	1600

Capacity Analysis Module:

Vol/Sat:	0.08	0.49	0.15	0.24	0.38	0.06	0.10	0.47	0.48	0.16	0.16	0.22
Crit Moves:	****			****			****			****		

Santa Ana Circulation Element

Level Of Service Computation Report

ICU 1(Loss as Cycle Length %) Method (Base Volume Alternative)

Intersection #63 Standard Ave and 4th St

Cycle (sec): 100 Critical Vol./Cap.(X): 1.341
Loss Time (sec): 5 Average Delay (sec/veh): xxxxxx
Optimal Cycle: 180 Level Of Service: F

Table with 4 columns: North Bound, South Bound, East Bound, West Bound. Rows include Movement (L-T-R), Control (Protected), Rights (Include), Min. Green, Y+R, and Lanes.

Volume Module:

Table with 13 columns representing different volume metrics: Base Vol, Growth Adj, Initial Bse, User Adj, PHF Adj, PHF Volume, Reduct Vol, Reduced Vol, PCE Adj, MLF Adj, Final Volume.

Saturation Flow Module:

Table with 13 columns representing saturation flow metrics: Sat/Lane, Adjustment, Lanes, Final Sat.

Capacity Analysis Module:

Table with 13 columns representing capacity analysis metrics: Vol/Sat, Crit Moves.

Santa Ana Circulation Element

Level Of Service Computation Report

ICU 1(Loss as Cycle Length %) Method (Base Volume Alternative)

Intersection #64 Standard Ave and 1st St

Cycle (sec): 100 Critical Vol./Cap.(X): 1.484
Loss Time (sec): 5 Average Delay (sec/veh): xxxxxx
Optimal Cycle: 180 Level Of Service: F

Table with 4 columns: North Bound, South Bound, East Bound, West Bound. Rows include Movement (L-T-R), Control, Rights, Min. Green, Y+R, and Lanes.

Volume Module table with 12 columns representing different traffic flows and 10 rows of adjustment factors like Growth Adj, PHF Adj, etc.

Saturation Flow Module table with 12 columns and 4 rows showing Sat/Lane, Adjustment, Lanes, and Final Sat.

Capacity Analysis Module table with 12 columns and 3 rows showing Vol/Sat, Crit Moves, and other metrics.

Santa Ana Circulation Element

Level Of Service Computation Report

ICU 1(Loss as Cycle Length %) Method (Base Volume Alternative)

Intersection #65 Standard Ave and Mcfadden Ave

Cycle (sec): 100 Critical Vol./Cap.(X): 0.769
Loss Time (sec): 5 Average Delay (sec/veh): xxxxxx
Optimal Cycle: 46 Level Of Service: C

Table with 4 columns: North Bound, South Bound, East Bound, West Bound. Rows include Movement (L-T-R), Control (Protected), Rights (Include), Min. Green, Y+R, and Lanes.

Volume Module: Table with 12 columns representing different traffic volumes and adjustment factors like Growth Adj, User Adj, PHF Adj, etc.

Saturation Flow Module: Table with 12 columns showing saturation flow rates and adjustment factors for different lanes.

Capacity Analysis Module: Table with 12 columns showing volume-to-saturation ratios and critical moves.

Santa Ana Circulation Element

Level Of Service Computation Report

ICU 1(Loss as Cycle Length %) Method (Base Volume Alternative)

Intersection #66 Halladay St and Warner Ave

Cycle (sec): 100 Critical Vol./Cap.(X): 0.824
 Loss Time (sec): 5 Average Delay (sec/veh): xxxxxx
 Optimal Cycle: 57 Level Of Service: D

Approach:	North Bound			South Bound			East Bound			West Bound		
Movement:	L	T	R	L	T	R	L	T	R	L	T	R
Control:	Permitted			Permitted			Permitted			Permitted		
Rights:	Include			Include			Include			Include		
Min. Green:	0	0	0	0	0	0	0	0	0	0	0	0
Y+R:	4.0	4.0	4.0	4.0	4.0	4.0	4.0	4.0	4.0	4.0	4.0	4.0
Lanes:	1	0	0	0	0	0	0	1	1	0	0	1

Volume Module:

Base Vol:	200	0	417	0	0	0	2	955	96	287	2284	0
Growth Adj:	1.00	1.00	1.00	1.00	1.00	1.00	1.00	1.00	1.00	1.00	1.00	1.00
Initial Bse:	200	0	417	0	0	0	2	955	96	287	2284	0
User Adj:	1.00	1.00	1.00	1.00	1.00	1.00	1.00	1.00	1.00	1.00	1.00	1.00
PHF Adj:	1.00	1.00	1.00	1.00	1.00	1.00	1.00	1.00	1.00	1.00	1.00	1.00
PHF Volume:	200	0	417	0	0	0	2	955	96	287	2284	0
Reduct Vol:	0	0	0	0	0	0	0	0	0	0	0	0
Reduced Vol:	200	0	417	0	0	0	2	955	96	287	2284	0
PCE Adj:	1.00	1.00	1.00	1.00	1.00	1.00	1.00	1.00	1.00	1.00	1.00	1.00
MLF Adj:	1.00	1.00	1.00	1.00	1.00	1.00	1.00	1.00	1.00	1.00	1.00	1.00
FinalVolume:	200	0	417	0	0	0	2	955	96	287	2284	0

Saturation Flow Module:

Sat/Lane:	1600	1600	1600	1600	1600	1600	1600	1600	1600	1600	1600	1600
Adjustment:	1.00	1.06	1.00	1.00	1.06	1.00	1.00	1.02	1.00	1.00	1.05	1.00
Lanes:	1.00	0.00	1.00	0.00	0.00	0.00	0.01	2.72	0.27	0.33	2.67	0.00
Final Sat.:	1600	0	1600	0	0	0	9	4453	438	536	4464	0

Capacity Analysis Module:

Vol/Sat:	0.13	0.00	0.26	0.00	0.00	0.00	0.00	0.21	0.22	0.18	0.51	0.00
Crit Moves:	****			****			****			****		

Santa Ana Circulation Element

Level Of Service Computation Report

ICU 1(Loss as Cycle Length %) Method (Base Volume Alternative)

Intersection #67 Halladay St and Dyer Rd

Cycle (sec): 100 Critical Vol./Cap.(X): 0.945
Loss Time (sec): 5 Average Delay (sec/veh): xxxxxx
Optimal Cycle: 124 Level Of Service: E

Table with 4 columns: North Bound, South Bound, East Bound, West Bound. Rows include Movement (L-T-R), Control (Split Phase, Protected), Rights (Include), Min. Green, Y+R, and Lanes.

Volume Module: Table with 12 columns representing traffic volumes for different movements and lanes. Rows include Base Vol, Growth Adj, Initial Bse, User Adj, PHF Adj, PHF Volume, Reduct Vol, Reduced Vol, PCE Adj, MLF Adj, and Final Volume.

Saturation Flow Module: Table with 12 columns representing saturation flow rates. Rows include Sat/Lane, Adjustment, Lanes, and Final Sat.

Capacity Analysis Module: Table with 12 columns representing capacity analysis metrics. Rows include Vol/Sat and Crit Moves.

Santa Ana Circulation Element

Level Of Service Computation Report
 2000 HCM Operations Method (Base Volume Alternative)

 Intersection #68 SR-55 SB Ramps and MacArthur Blvd

Cycle (sec): 100 Critical Vol./Cap.(X): 0.602
 Loss Time (sec): 5 Average Delay (sec/veh): 18.4
 Optimal Cycle: 30 Level Of Service: B

Approach:	North Bound			South Bound			East Bound			West Bound		
Movement:	L	T	R	L	T	R	L	T	R	L	T	R
Control:	Split Phase			Split Phase			Protected			Protected		
Rights:	Include			Include			Ignore			Ignore		
Min. Green:	0	0	0	0	0	0	0	0	0	0	0	0
Y+R:	4.0	4.0	4.0	4.0	4.0	4.0	4.0	4.0	4.0	4.0	4.0	4.0
Lanes:	0	0	0	2	0	0	0	0	2	1	1	0

Volume Module:

Base Vol:	0	0	0	321	0	777	0	1305	1163	0	1547	608
Growth Adj:	1.00	1.00	1.00	1.00	1.00	1.00	1.00	1.00	1.00	1.00	1.00	1.00
Initial Bse:	0	0	0	321	0	777	0	1305	1163	0	1547	608
User Adj:	1.00	1.00	1.00	1.00	1.00	1.00	1.00	1.00	0.00	1.00	1.00	0.00
PHF Adj:	1.00	1.00	1.00	1.00	1.00	1.00	1.00	1.00	0.00	1.00	1.00	0.00
PHF Volume:	0	0	0	321	0	777	0	1305	0	0	1547	0
Reduct Vol:	0	0	0	0	0	0	0	0	0	0	0	0
Reduced Vol:	0	0	0	321	0	777	0	1305	0	0	1547	0
PCE Adj:	1.00	1.00	1.00	1.00	1.00	1.00	1.00	1.00	0.00	1.00	1.00	0.00
MLF Adj:	1.00	1.00	1.00	1.00	1.00	1.00	1.00	1.00	0.00	1.00	1.00	0.00
FinalVolume:	0	0	0	321	0	777	0	1305	0	0	1547	0

Saturation Flow Module:

Sat/Lane:	1900	1900	1900	1900	1900	1900	1900	1900	1900	1900	1900	1900
Adjustment:	1.00	1.00	1.00	0.92	1.00	0.75	1.00	0.91	0.91	1.00	0.91	1.00
Lanes:	0.00	0.00	0.00	2.00	0.00	2.00	0.00	3.00	1.00	0.00	3.00	1.00
Final Sat.:	0	0	0	3502	0	2842	0	5187	1729	0	5187	1900

Capacity Analysis Module:

Vol/Sat:	0.00	0.00	0.00	0.09	0.00	0.27	0.00	0.25	0.00	0.00	0.30	0.00
Crit Moves:						****	****				****	
Green/Cycle:	0.00	0.00	0.00	0.45	0.00	0.45	0.00	0.50	0.00	0.00	0.50	0.00
Volume/Cap:	0.00	0.00	0.00	0.20	0.00	0.60	0.00	0.51	0.00	0.00	0.60	0.00
Delay/Veh:	0.0	0.0	0.0	16.5	0.0	21.3	0.0	17.2	0.0	0.0	18.5	0.0
User DelAdj:	1.00	1.00	1.00	1.00	1.00	1.00	1.00	1.00	1.00	1.00	1.00	1.00
AdjDel/Veh:	0.0	0.0	0.0	16.5	0.0	21.3	0.0	17.2	0.0	0.0	18.5	0.0
LOS by Move:	A	A	A	B	A	C	A	B	A	A	B	A
HCM2k85thQ:	0	0	0	5	0	16	0	15	0	0	19	0

 Note: Queue reported is the number of cars per lane.

Santa Ana Circulation Element

Level Of Service Computation Report
 2000 HCM Operations Method (Base Volume Alternative)

 Intersection #69 SR-55 NB Ramps and MacArthur Blvd

Cycle (sec): 100 Critical Vol./Cap.(X): 0.511
 Loss Time (sec): 5 Average Delay (sec/veh): 16.2
 Optimal Cycle: 25 Level Of Service: B

Approach:	North Bound			South Bound			East Bound			West Bound		
Movement:	L	T	R	L	T	R	L	T	R	L	T	R
Control:	Split Phase			Split Phase			Protected			Protected		
Rights:	Ignore			Include			Ignore			Ignore		
Min. Green:	0	0	0	0	0	0	0	0	0	0	0	0
Y+R:	4.0	4.0	4.0	4.0	4.0	4.0	4.0	4.0	4.0	4.0	4.0	4.0
Lanes:	2	0	0	0	0	0	0	0	2	0	0	3

Volume Module:

Base Vol:	726	0	483	0	0	0	0	764	785	0	1444	1040
Growth Adj:	1.00	1.00	1.00	1.00	1.00	1.00	1.00	1.00	1.00	1.00	1.00	1.00
Initial Bse:	726	0	483	0	0	0	0	764	785	0	1444	1040
User Adj:	1.00	1.00	0.00	1.00	1.00	1.00	1.00	1.00	0.00	1.00	1.00	0.00
PHF Adj:	1.00	1.00	0.00	1.00	1.00	1.00	1.00	1.00	0.00	1.00	1.00	0.00
PHF Volume:	726	0	0	0	0	0	0	764	0	0	1444	0
Reduct Vol:	0	0	0	0	0	0	0	0	0	0	0	0
Reduced Vol:	726	0	0	0	0	0	0	764	0	0	1444	0
PCE Adj:	1.00	1.00	0.00	1.00	1.00	1.00	1.00	1.00	0.00	1.00	1.00	0.00
MLF Adj:	1.00	1.00	0.00	1.00	1.00	1.00	1.00	1.00	0.00	1.00	1.00	0.00
FinalVolume:	726	0	0	0	0	0	0	764	0	0	1444	0

Saturation Flow Module:

Sat/Lane:	1900	1900	1900	1900	1900	1900	1900	1900	1900	1900	1900	1900
Adjustment:	0.92	1.00	1.00	1.00	1.00	1.00	1.00	0.95	0.88	1.00	0.91	1.00
Lanes:	2.00	0.00	1.00	0.00	0.00	0.00	0.00	2.00	2.00	0.00	3.00	1.00
Final Sat.:	3502	0	1900	0	0	0	0	3610	3344	0	5187	1900

Capacity Analysis Module:

Vol/Sat:	0.21	0.00	0.00	0.00	0.00	0.00	0.00	0.21	0.00	0.00	0.28	0.00
Crit Moves:	****						****			****		
Green/Cycle:	0.41	0.00	0.00	0.00	0.00	0.00	0.00	0.54	0.00	0.00	0.54	0.00
Volume/Cap:	0.51	0.00	0.00	0.00	0.00	0.00	0.00	0.39	0.00	0.00	0.51	0.00
Delay/Veh:	22.6	0.0	0.0	0.0	0.0	0.0	0.0	13.3	0.0	0.0	14.5	0.0
User DelAdj:	1.00	1.00	1.00	1.00	1.00	1.00	1.00	1.00	1.00	1.00	1.00	1.00
AdjDel/Veh:	22.6	0.0	0.0	0.0	0.0	0.0	0.0	13.3	0.0	0.0	14.5	0.0
LOS by Move:	C	A	A	A	A	A	A	B	A	A	B	A
HCM2k85thQ:	13	0	0	0	0	0	0	11	0	0	16	0

 Note: Queue reported is the number of cars per lane.

Santa Ana Circulation Element

Level Of Service Computation Report
 2000 HCM Operations Method (Base Volume Alternative)

 Intersection #70 SR-55 SB Ramps and Dyer Rd

Cycle (sec): 100 Critical Vol./Cap.(X): 0.679
 Loss Time (sec): 5 Average Delay (sec/veh): 26.5
 Optimal Cycle: 37 Level Of Service: C

Approach:	North Bound			South Bound			East Bound			West Bound		
Movement:	L	T	R	L	T	R	L	T	R	L	T	R
Control:	Split Phase			Split Phase			Protected			Protected		
Rights:	Ovl			Include			Include			Include		
Min. Green:	0	0	0	0	0	0	0	0	0	0	0	0
Y+R:	4.0	4.0	4.0	4.0	4.0	4.0	4.0	4.0	4.0	4.0	4.0	4.0
Lanes:	1	1	0	0	1	1	0	3	0	2	0	3

Volume Module:

Base Vol:	386	12	291	103	226	110	66	1544	210	507	904	58
Growth Adj:	1.00	1.00	1.00	1.00	1.00	1.00	1.00	1.00	1.00	1.00	1.00	1.00
Initial Bse:	386	12	291	103	226	110	66	1544	210	507	904	58
User Adj:	1.00	1.00	1.00	1.00	1.00	1.00	1.00	1.00	1.00	1.00	1.00	1.00
PHF Adj:	1.00	1.00	1.00	1.00	1.00	1.00	1.00	1.00	1.00	1.00	1.00	1.00
PHF Volume:	386	12	291	103	226	110	66	1544	210	507	904	58
Reduct Vol:	0	0	0	0	0	0	0	0	0	0	0	0
Reduced Vol:	386	12	291	103	226	110	66	1544	210	507	904	58
PCE Adj:	1.00	1.00	1.00	1.00	1.00	1.00	1.00	1.00	1.00	1.00	1.00	1.00
MLF Adj:	1.00	1.00	1.00	1.00	1.00	1.00	1.00	1.00	1.00	1.00	1.00	1.00
FinalVolume:	386	12	291	103	226	110	66	1544	210	507	904	58

Saturation Flow Module:

Sat/Lane:	1900	1900	1900	1900	1900	1900	1900	1900	1900	1900	1900	1900
Adjustment:	0.95	0.95	0.75	0.94	0.94	0.85	0.95	0.91	0.85	0.92	0.91	0.85
Lanes:	1.94	0.06	2.00	0.63	1.37	1.00	1.00	3.00	1.00	2.00	3.00	1.00
Final Sat.:	3516	109	2842	1113	2443	1615	1805	5187	1615	3502	5187	1615

Capacity Analysis Module:

Vol/Sat:	0.11	0.11	0.10	0.09	0.09	0.07	0.04	0.30	0.13	0.14	0.17	0.04
Crit Moves:	****			****			****			****		
Green/Cycle:	0.16	0.16	0.38	0.14	0.14	0.14	0.11	0.44	0.44	0.21	0.54	0.54
Volume/Cap:	0.68	0.68	0.27	0.68	0.68	0.50	0.32	0.68	0.30	0.68	0.32	0.07
Delay/Veh:	42.7	42.7	21.9	45.0	45.0	41.8	41.8	23.3	18.4	38.7	12.9	11.1
User DelAdj:	1.00	1.00	1.00	1.00	1.00	1.00	1.00	1.00	1.00	1.00	1.00	1.00
AdjDel/Veh:	42.7	42.7	21.9	45.0	45.0	41.8	41.8	23.3	18.4	38.7	12.9	11.1
LOS by Move:	D	D	C	D	D	D	D	C	B	D	B	B
HCM2k85thQ:	11	11	6	10	10	6	3	22	7	13	9	1

 Note: Queue reported is the number of cars per lane.

Santa Ana Circulation Element

Level Of Service Computation Report

ICU 1(Loss as Cycle Length %) Method (Base Volume Alternative)

Intersection #71 Glassell St and La Veta Ave

Cycle (sec): 100 Critical Vol./Cap.(X): 0.766
Loss Time (sec): 5 Average Delay (sec/veh): xxxxxx
Optimal Cycle: 46 Level Of Service: C

Approach: North Bound South Bound East Bound West Bound
Movement: L - T - R L - T - R L - T - R L - T - R
Control: Protected Protected Protected Protected
Rights: Ovl Include Ovl Include
Min. Green: 0 0 0 0 0 0 0 0 0 0 0 0
Y+R: 4.0 4.0 4.0 4.0 4.0 4.0 4.0 4.0 4.0 4.0 4.0 4.0
Lanes: 2 0 1 0 1 1 0 1 1 0 1 1 0 1 0 1 1 0

Volume Module:
Base Vol: 573 595 194 15 499 37 112 367 631 225 407 16
Growth Adj: 1.00 1.00 1.00 1.00 1.00 1.00 1.00 1.00 1.00 1.00 1.00 1.00
Initial Bse: 573 595 194 15 499 37 112 367 631 225 407 16
User Adj: 1.00 1.00 1.00 1.00 1.00 1.00 1.00 1.00 1.00 1.00 1.00 1.00
PHF Adj: 1.00 1.00 1.00 1.00 1.00 1.00 1.00 1.00 1.00 1.00 1.00 1.00
PHF Volume: 573 595 194 15 499 37 112 367 631 225 407 16
Reduct Vol: 0 0 0 0 0 0 0 0 0 0 0 0
Reduced Vol: 573 595 194 15 499 37 112 367 631 225 407 16
PCE Adj: 1.00 1.00 1.00 1.00 1.00 1.00 1.00 1.00 1.00 1.00 1.00 1.00
MLF Adj: 1.00 1.00 1.00 1.00 1.00 1.00 1.00 1.00 1.00 1.00 1.00 1.00
FinalVolume: 573 595 194 15 499 37 112 367 631 225 407 16
OvlAdjVol: 0 344

Saturation Flow Module:
Sat/Lane: 1600 1600 1600 1600 1600 1600 1600 1600 1600 1600 1600 1600
Adjustment: 1.00 1.06 1.00 1.00 1.03 1.00 1.00 1.06 1.00 1.00 1.03 1.00
Lanes: 2.00 1.00 1.00 1.00 1.86 0.14 1.00 1.00 1.00 1.00 1.92 0.08
Final Sat.: 3200 1700 1600 1600 3079 221 1600 1700 1600 1600 3179 121

Capacity Analysis Module:
Vol/Sat: 0.18 0.35 0.12 0.01 0.16 0.17 0.07 0.22 0.39 0.14 0.13 0.13
OvlAdjV/S: 0.00 0.22
Crit Moves: **** **** **** ****

Santa Ana Circulation Element

Level Of Service Computation Report
 2000 HCM Operations Method (Base Volume Alternative)

 Intersection #72 Glassell St and SR-22 WB Ramps

Cycle (sec): 100 Critical Vol./Cap.(X): 0.943
 Loss Time (sec): 5 Average Delay (sec/veh): 33.4
 Optimal Cycle: 125 Level Of Service: C

Approach:	North Bound			South Bound			East Bound			West Bound		
Movement:	L	T	R	L	T	R	L	T	R	L	T	R
Control:	Protected			Permitted			Split Phase			Split Phase		
Rights:	Include			Include			Include			Include		
Min. Green:	0	0	0	0	0	0	0	0	0	0	0	0
Y+R:	4.0	4.0	4.0	4.0	4.0	4.0	4.0	4.0	4.0	4.0	4.0	4.0
Lanes:	1	0	2	0	0	2	0	0	0	1	0	1

Volume Module:

Base Vol:	640	1045	0	0	1110	323	0	0	0	268	9	476
Growth Adj:	1.00	1.00	1.00	1.00	1.00	1.00	1.00	1.00	1.00	1.00	1.00	1.00
Initial Bse:	640	1045	0	0	1110	323	0	0	0	268	9	476
User Adj:	1.00	1.00	1.00	1.00	1.00	1.00	1.00	1.00	1.00	1.00	1.00	1.00
PHF Adj:	1.00	1.00	1.00	1.00	1.00	1.00	1.00	1.00	1.00	1.00	1.00	1.00
PHF Volume:	640	1045	0	0	1110	323	0	0	0	268	9	476
Reduct Vol:	0	0	0	0	0	0	0	0	0	0	0	0
Reduced Vol:	640	1045	0	0	1110	323	0	0	0	268	9	476
PCE Adj:	1.00	1.00	1.00	1.00	1.00	1.00	1.00	1.00	1.00	1.00	1.00	1.00
MLF Adj:	1.00	1.00	1.00	1.00	1.00	1.00	1.00	1.00	1.00	1.00	1.00	1.00
Final Volume:	640	1045	0	0	1110	323	0	0	0	268	9	476

Saturation Flow Module:

Sat/Lane:	1900	1900	1900	1900	1900	1900	1900	1900	1900	1900	1900	1900
Adjustment:	0.95	0.95	1.00	1.00	0.95	0.85	1.00	1.00	1.00	0.86	0.86	0.86
Lanes:	1.00	2.00	0.00	0.00	2.00	1.00	0.00	0.00	0.00	1.35	0.02	1.63
Final Sat.:	1805	3610	0	0	3610	1615	0	0	0	2201	38	2646

Capacity Analysis Module:

Vol/Sat:	0.35	0.29	0.00	0.00	0.31	0.20	0.00	0.00	0.00	0.12	0.23	0.18
Crit Moves:	****				****					****		
Green/Cycle:	0.38	0.70	0.00	0.00	0.33	0.33	0.00	0.00	0.00	0.25	0.25	0.25
Volume/Cap:	0.94	0.41	0.00	0.00	0.94	0.61	0.00	0.00	0.00	0.49	0.94	0.73
Delay/Veh:	51.9	6.4	0.0	0.0	47.5	30.5	0.0	0.0	0.0	32.4	56.2	37.0
User DelAdj:	1.00	1.00	1.00	1.00	1.00	1.00	1.00	1.00	1.00	1.00	1.00	1.00
AdjDel/Veh:	51.9	6.4	0.0	0.0	47.5	30.5	0.0	0.0	0.0	32.4	56.2	37.0
LOS by Move:	D	A	A	A	D	C	A	A	A	C	E	D
HCM2k85thQ:	34	11	0	0	32	14	0	0	0	9	24	15

 Note: Queue reported is the number of cars per lane.

Santa Ana Circulation Element

Level of Service Computation Report
 2000 HCM Operations Method (Base Volume Alternative)

 Intersection #73 Grand Ave / Glassell St and SR-22 EB Ramps

Cycle (sec): 100 Critical Vol./Cap.(X): 0.927
 Loss Time (sec): 5 Average Delay (sec/veh): 31.8
 Optimal Cycle: 109 Level of Service: C

Approach: Movement:	North Bound			South Bound			East Bound			West Bound		
	L	T	R	L	T	R	L	T	R	L	T	R
Control:	Permitted			Protected			Split Phase			Split Phase		
Rights:	Include			Include			Include			Include		
Min. Green:	0	0	0	0	0	0	0	0	0	0	0	0
Y+R:	4.0	4.0	4.0	4.0	4.0	4.0	4.0	4.0	4.0	4.0	4.0	4.0
Lanes:	0	0	2	0	1	0	1	0	1	0	0	0

Volume Module:												
Base Vol:	0	1316	336	505	903	0	238	4	522	0	0	0
Growth Adj:	1.00	1.00	1.00	1.00	1.00	1.00	1.00	1.00	1.00	1.00	1.00	1.00
Initial Bse:	0	1316	336	505	903	0	238	4	522	0	0	0
User Adj:	1.00	1.00	1.00	1.00	1.00	1.00	1.00	1.00	1.00	1.00	1.00	1.00
PHF Adj:	1.00	1.00	1.00	1.00	1.00	1.00	1.00	1.00	1.00	1.00	1.00	1.00
PHF Volume:	0	1316	336	505	903	0	238	4	522	0	0	0
Reduct Vol:	0	0	0	0	0	0	0	0	0	0	0	0
Reduced Vol:	0	1316	336	505	903	0	238	4	522	0	0	0
PCE Adj:	1.00	1.00	1.00	1.00	1.00	1.00	1.00	1.00	1.00	1.00	1.00	1.00
MLF Adj:	1.00	1.00	1.00	1.00	1.00	1.00	1.00	1.00	1.00	1.00	1.00	1.00
Final Volume:	0	1316	336	505	903	0	238	4	522	0	0	0

Saturation Flow Module:												
Sat/Lane:	1900	1900	1900	1900	1900	1900	1900	1900	1900	1900	1900	1900
Adjustment:	1.00	0.95	0.85	0.95	0.95	1.00	0.86	0.86	0.86	1.00	1.00	1.00
Lanes:	0.00	2.00	1.00	1.00	2.00	0.00	1.31	0.01	1.68	0.00	0.00	0.00
Final Sat.:	0	3610	1615	1805	3610	0	2130	17	2731	0	0	0

Capacity Analysis Module:												
Vol/Sat:	0.00	0.36	0.21	0.28	0.25	0.00	0.11	0.24	0.19	0.00	0.00	0.00
Crit Moves:	****			****			****			****		
Green/Cycle:	0.00	0.39	0.39	0.30	0.70	0.00	0.25	0.25	0.25	0.00	0.00	0.00
Volume/Cap:	0.00	0.93	0.53	0.93	0.36	0.00	0.44	0.93	0.75	0.00	0.00	0.00
Delay/Veh:	0.0	39.7	24.1	55.9	6.3	0.0	31.4	52.7	37.5	0.0	0.0	0.0
User DelAdj:	1.00	1.00	1.00	1.00	1.00	1.00	1.00	1.00	1.00	1.00	1.00	1.00
AdjDel/Veh:	0.0	39.7	24.1	55.9	6.3	0.0	31.4	52.7	37.5	0.0	0.0	0.0
LOS by Move:	A	D	C	E	A	A	C	D	D	A	A	A
HCM2k85thQ:	0	36	13	28	9	0	8	23	16	0	0	0

Note: Queue reported is the number of cars per lane.

Santa Ana Circulation Element

Level Of Service Computation Report

ICU 1(Loss as Cycle Length %) Method (Base Volume Alternative)

Intersection #74 Grand Ave and Fairhaven Ave

Cycle (sec): 100 Critical Vol./Cap.(X): 0.665
 Loss Time (sec): 5 Average Delay (sec/veh): xxxxxx
 Optimal Cycle: 34 Level Of Service: B

Approach:	North Bound			South Bound			East Bound			West Bound		
Movement:	L	T	R	L	T	R	L	T	R	L	T	R
Control:	Protected			Protected			Permitted			Permitted		
Rights:	Include			Include			Include			Include		
Min. Green:	0	0	0	0	0	0	0	0	0	0	0	0
Y+R:	4.0	4.0	4.0	4.0	4.0	4.0	4.0	4.0	4.0	4.0	4.0	4.0
Lanes:	1	0	2	1	0	2	1	0	1	1	0	1

Volume Module:

Base Vol:	50	1311	262	242	974	89	79	45	33	153	29	109
Growth Adj:	1.00	1.00	1.00	1.00	1.00	1.00	1.00	1.00	1.00	1.00	1.00	1.00
Initial Bse:	50	1311	262	242	974	89	79	45	33	153	29	109
User Adj:	1.00	1.00	1.00	1.00	1.00	1.00	1.00	1.00	1.00	1.00	1.00	1.00
PHF Adj:	1.00	1.00	1.00	1.00	1.00	1.00	1.00	1.00	1.00	1.00	1.00	1.00
PHF Volume:	50	1311	262	242	974	89	79	45	33	153	29	109
Reduct Vol:	0	0	0	0	0	0	0	0	0	0	0	0
Reduced Vol:	50	1311	262	242	974	89	79	45	33	153	29	109
PCE Adj:	1.00	1.00	1.00	1.00	1.00	1.00	1.00	1.00	1.00	1.00	1.00	1.00
MLF Adj:	1.00	1.00	1.00	1.00	1.00	1.00	1.00	1.00	1.00	1.00	1.00	1.00
Final Volume:	50	1311	262	242	974	89	79	45	33	153	29	109

Saturation Flow Module:

Sat/Lane:	1600	1600	1600	1600	1600	1600	1600	1600	1600	1600	1600	1600
Adjustment:	1.00	1.05	1.00	1.00	1.05	1.00	1.00	1.05	1.00	1.00	1.00	1.00
Lanes:	1.00	2.50	0.50	1.00	2.75	0.25	1.00	1.15	0.85	1.00	0.21	0.79
Final Sat.:	1600	4201	799	1600	4598	402	1600	1946	1354	1600	336	1264

Capacity Analysis Module:

Vol/Sat:	0.03	0.31	0.33	0.15	0.21	0.22	0.05	0.02	0.02	0.10	0.09	0.09
Crit Moves:			****	****			****			****		

Santa Ana Circulation Element

Level Of Service Computation Report

ICU 1(Loss as Cycle Length %) Method (Base Volume Alternative)

Intersection #75 Grand Ave and Santa Clara Ave

Cycle (sec): 100 Critical Vol./Cap.(X): 0.731
 Loss Time (sec): 5 Average Delay (sec/veh): xxxxxx
 Optimal Cycle: 41 Level Of Service: C

Approach:	North Bound			South Bound			East Bound			West Bound		
Movement:	L	T	R	L	T	R	L	T	R	L	T	R
Control:	Protected			Protected			Permitted			Permitted		
Rights:	Include			WideBypass			Include			Include		
Min. Green:	0	0	0	0	0	0	0	0	0	0	0	0
Y+R:	4.0	4.0	4.0	4.0	4.0	4.0	4.0	4.0	4.0	4.0	4.0	4.0
Lanes:	1	0	2	1	0	2	1	0	0	1	0	1

Volume Module:

Base Vol:	95	1280	266	240	946	240	114	139	26	115	206	220
Growth Adj:	1.00	1.00	1.00	1.00	1.00	1.00	1.00	1.00	1.00	1.00	1.00	1.00
Initial Bse:	95	1280	266	240	946	240	114	139	26	115	206	220
User Adj:	1.00	1.00	1.00	1.00	1.00	1.00	1.00	1.00	1.00	1.00	1.00	1.00
PHF Adj:	1.00	1.00	1.00	1.00	1.00	1.00	1.00	1.00	1.00	1.00	1.00	1.00
PHF Volume:	95	1280	266	240	946	240	114	139	26	115	206	220
Reduct Vol:	0	0	0	0	0	0	0	0	0	0	0	0
Reduced Vol:	95	1280	266	240	946	240	114	139	26	115	206	220
PCE Adj:	1.00	1.00	1.00	1.00	1.00	1.00	1.00	1.00	1.00	1.00	1.00	1.00
MLF Adj:	1.00	1.00	1.00	1.00	1.00	1.00	1.00	1.00	1.00	1.00	1.00	1.00
FinalVolume:	95	1280	266	240	946	240	114	139	26	115	206	220

Saturation Flow Module:

Sat/Lane:	1600	1600	1600	1600	1600	1600	1600	1600	1600	1600	1600	1600
Adjustment:	1.00	1.05	1.00	1.00	1.05	1.00	1.00	1.00	1.00	1.00	1.06	1.00
Lanes:	1.00	2.48	0.52	1.00	2.39	0.61	1.00	0.84	0.16	1.00	1.00	1.00
Final Sat.:	1600	4174	826	1600	4029	971	1600	1348	252	1600	1700	1600

Capacity Analysis Module:

Vol/Sat:	0.06	0.31	0.32	0.15	0.23	0.25	0.07	0.10	0.10	0.07	0.12	0.14
Crit Moves:			****	****			****					****

Santa Ana Circulation Element

Level Of Service Computation Report

ICU 1(Loss as Cycle Length %) Method (Base Volume Alternative)

Intersection #76 Grand Ave and 17th St

Cycle (sec): 100 Critical Vol./Cap.(X): 0.854
 Loss Time (sec): 5 Average Delay (sec/veh): xxxxxx
 Optimal Cycle: 66 Level Of Service: D

Approach:	North Bound			South Bound			East Bound			West Bound		
Movement:	L	T	R	L	T	R	L	T	R	L	T	R
Control:	Protected			Protected			Protected			Protected		
Rights:	Include			Include			Include			Include		
Min. Green:	0	0	0	0	0	0	0	0	0	0	0	0
Y+R:	4.0	4.0	4.0	4.0	4.0	4.0	4.0	4.0	4.0	4.0	4.0	4.0
Lanes:	1	0	2	1	0	2	2	0	2	1	0	2

Volume Module:

Base Vol:	266	947	239	294	634	140	371	949	160	284	1046	190
Growth Adj:	1.00	1.00	1.00	1.00	1.00	1.00	1.00	1.00	1.00	1.00	1.00	1.00
Initial Bse:	266	947	239	294	634	140	371	949	160	284	1046	190
User Adj:	1.00	1.00	1.00	1.00	1.00	1.00	1.00	1.00	1.00	1.00	1.00	1.00
PHF Adj:	1.00	1.00	1.00	1.00	1.00	1.00	1.00	1.00	1.00	1.00	1.00	1.00
PHF Volume:	266	947	239	294	634	140	371	949	160	284	1046	190
Reduct Vol:	0	0	0	0	0	0	0	0	0	0	0	0
Reduced Vol:	266	947	239	294	634	140	371	949	160	284	1046	190
PCE Adj:	1.00	1.00	1.00	1.00	1.00	1.00	1.00	1.00	1.00	1.00	1.00	1.00
MLF Adj:	1.00	1.00	1.00	1.00	1.00	1.00	1.00	1.00	1.00	1.00	1.00	1.00
FinalVolume:	266	947	239	294	634	140	371	949	160	284	1046	190

Saturation Flow Module:

Sat/Lane:	1600	1600	1600	1600	1600	1600	1600	1600	1600	1600	1600	1600
Adjustment:	1.00	1.05	1.00	1.00	1.05	1.00	1.00	1.05	1.00	1.00	1.05	1.00
Lanes:	1.00	2.40	0.60	1.00	2.46	0.54	2.00	2.57	0.43	2.00	2.54	0.46
Final Sat.:	1600	4033	967	1600	4132	868	3200	4307	693	3200	4262	738

Capacity Analysis Module:

Vol/Sat:	0.17	0.23	0.25	0.18	0.15	0.16	0.12	0.22	0.23	0.09	0.25	0.26
Crit Moves:			****	****			****					****

Santa Ana Circulation Element

Level Of Service Computation Report
 2000 HCM Operations Method (Base Volume Alternative)

 Intersection #77 Grand Ave and I-5 NB Ramps

Cycle (sec): 100 Critical Vol./Cap.(X): 0.764
 Loss Time (sec): 5 Average Delay (sec/veh): 11.3
 Optimal Cycle: 47 Level Of Service: B

Approach:	North Bound			South Bound			East Bound			West Bound		
Movement:	L	T	R	L	T	R	L	T	R	L	T	R
Control:	Protected			Protected			Split Phase			Split Phase		
Rights:	Ignore			Include			Include			Include		
Min. Green:	0	0	0	0	0	0	0	0	0	0	0	0
Y+R:	4.0	4.0	4.0	4.0	4.0	4.0	4.0	4.0	4.0	4.0	4.0	4.0
Lanes:	0	0	2	0	1	1	0	0	3	0	0	0

Volume Module:

Base Vol:	0	2036	1571	67	1623	0	0	0	0	168	0	202
Growth Adj:	1.00	1.00	1.00	1.00	1.00	1.00	1.00	1.00	1.00	1.00	1.00	1.00
Initial Bse:	0	2036	1571	67	1623	0	0	0	0	168	0	202
User Adj:	1.00	1.00	0.00	1.00	1.00	1.00	1.00	1.00	1.00	1.00	1.00	1.00
PHF Adj:	1.00	1.00	0.00	1.00	1.00	1.00	1.00	1.00	1.00	1.00	1.00	1.00
PHF Volume:	0	2036	0	67	1623	0	0	0	0	168	0	202
Reduct Vol:	0	0	0	0	0	0	0	0	0	0	0	0
Reduced Vol:	0	2036	0	67	1623	0	0	0	0	168	0	202
PCE Adj:	1.00	1.00	0.00	1.00	1.00	1.00	1.00	1.00	1.00	1.00	1.00	1.00
MLF Adj:	1.00	1.00	0.00	1.00	1.00	1.00	1.00	1.00	1.00	1.00	1.00	1.00
FinalVolume:	0	2036	0	67	1623	0	0	0	0	168	0	202

Saturation Flow Module:

Sat/Lane:	1900	1900	1900	1900	1900	1900	1900	1900	1900	1900	1900	1900
Adjustment:	1.00	0.95	1.00	0.95	0.91	1.00	1.00	1.00	1.00	0.92	1.00	0.85
Lanes:	0.00	2.00	1.00	1.00	3.00	0.00	0.00	0.00	0.00	2.00	0.00	1.00
Final Sat.:	0	3610	1900	1805	5187	0	0	0	0	3502	0	1615

Capacity Analysis Module:

Vol/Sat:	0.00	0.56	0.00	0.04	0.31	0.00	0.00	0.00	0.00	0.05	0.00	0.13
Crit Moves:	****			****						****		
Green/Cycle:	0.00	0.74	0.00	0.05	0.79	0.00	0.00	0.00	0.00	0.16	0.00	0.16
Volume/Cap:	0.00	0.76	0.00	0.76	0.40	0.00	0.00	0.00	0.00	0.29	0.00	0.76
Delay/Veh:	0.0	9.2	0.0	79.2	3.4	0.0	0.0	0.0	0.0	37.0	0.0	52.4
User DelAdj:	1.00	1.00	1.00	1.00	1.00	1.00	1.00	1.00	1.00	1.00	1.00	1.00
AdjDel/Veh:	0.0	9.2	0.0	79.2	3.4	0.0	0.0	0.0	0.0	37.0	0.0	52.4
LOS by Move:	A	A	A	E	A	A	A	A	A	D	A	D
HCM2k85thQ:	0	30	0	6	9	0	0	0	0	4	0	12

Note: Queue reported is the number of cars per lane.

Santa Ana Circulation Element

Level Of Service Computation Report
 2000 HCM Operations Method (Base Volume Alternative)

 Intersection #78 Grand Ave and Santa Ana Blvd

Cycle (sec): 100 Critical Vol./Cap.(X): 0.827
 Loss Time (sec): 5 Average Delay (sec/veh): 28.5
 Optimal Cycle: 61 Level Of Service: C

Approach:	North Bound			South Bound			East Bound			West Bound		
Movement:	L	T	R	L	T	R	L	T	R	L	T	R
Control:	Protected			Protected			Split Phase			Split Phase		
Rights:	Include			Ovl			Include			Include		
Min. Green:	0	0	0	0	0	0	0	0	0	0	0	0
Y+R:	4.0	4.0	4.0	4.0	4.0	4.0	4.0	4.0	4.0	4.0	4.0	4.0
Lanes:	1	0	2	1	0	2	2	0	1	0	1	0

Volume Module:

Base Vol:	213	2411	40	44	964	684	370	226	356	44	295	213
Growth Adj:	1.00	1.00	1.00	1.00	1.00	1.00	1.00	1.00	1.00	1.00	1.00	1.00
Initial Bse:	213	2411	40	44	964	684	370	226	356	44	295	213
User Adj:	1.00	1.00	1.00	1.00	1.00	1.00	1.00	1.00	1.00	1.00	1.00	1.00
PHF Adj:	1.00	1.00	1.00	1.00	1.00	1.00	1.00	1.00	1.00	1.00	1.00	1.00
PHF Volume:	213	2411	40	44	964	684	370	226	356	44	295	213
Reduct Vol:	0	0	0	0	0	0	0	0	0	0	0	0
Reduced Vol:	213	2411	40	44	964	684	370	226	356	44	295	213
PCE Adj:	1.00	1.00	1.00	1.00	1.00	1.00	1.00	1.00	1.00	1.00	1.00	1.00
MLF Adj:	1.00	1.00	1.00	1.00	1.00	1.00	1.00	1.00	1.00	1.00	1.00	1.00
Final Volume:	213	2411	40	44	964	684	370	226	356	44	295	213

Saturation Flow Module:

Sat/Lane:	1900	1900	1900	1900	1900	1900	1900	1900	1900	1900	1900	1900
Adjustment:	0.95	0.91	0.91	0.95	0.95	0.75	0.92	1.00	0.75	0.89	0.89	0.89
Lanes:	1.00	2.95	0.05	1.00	2.00	2.00	2.00	1.00	2.00	0.16	1.07	0.77
Final Sat.:	1805	5092	84	1805	3610	2842	3502	1900	2842	270	1810	1307

Capacity Analysis Module:

Vol/Sat:	0.12	0.47	0.47	0.02	0.27	0.24	0.11	0.12	0.13	0.16	0.16	0.16
Crit Moves:	****			****			****			****		
Green/Cycle:	0.18	0.57	0.57	0.03	0.42	0.57	0.15	0.15	0.15	0.20	0.20	0.20
Volume/Cap:	0.64	0.83	0.83	0.83	0.64	0.42	0.70	0.79	0.83	0.83	0.83	0.83
Delay/Veh:	41.9	19.4	19.4	112.6	24.1	12.4	44.4	54.2	53.7	47.0	47.0	47.0
User DelAdj:	1.00	1.00	1.00	1.00	1.00	1.00	1.00	1.00	1.00	1.00	1.00	1.00
AdjDel/Veh:	41.9	19.4	19.4	112.6	24.1	12.4	44.4	54.2	53.7	47.0	47.0	47.0
LOS by Move:	D	B	B	F	C	B	D	D	D	D	D	D
HCM2k85thQ:	11	35	35	5	19	11	11	13	13	17	17	17

 Note: Queue reported is the number of cars per lane.

Santa Ana Circulation Element

Level Of Service Computation Report

ICU 1(Loss as Cycle Length %) Method (Base Volume Alternative)

Intersection #79 Grand Ave and 1st St

Cycle (sec): 100 Critical Vol./Cap.(X): 0.718
 Loss Time (sec): 5 Average Delay (sec/veh): xxxxxx
 Optimal Cycle: 39 Level Of Service: C

Approach:	North Bound			South Bound			East Bound			West Bound		
Movement:	L	T	R	L	T	R	L	T	R	L	T	R
Control:	Protected			Protected			Protected			Protected		
Rights:	Include			Include			Include			Include		
Min. Green:	0	0	0	0	0	0	0	0	0	0	0	0
Y+R:	4.0	4.0	4.0	4.0	4.0	4.0	4.0	4.0	4.0	4.0	4.0	4.0
Lanes:	2	0	2	1	0	0	2	0	2	0	1	0

Volume Module:

Base Vol:	195	1493	45	133	784	313	272	900	89	121	753	138
Growth Adj:	1.00	1.00	1.00	1.00	1.00	1.00	1.00	1.00	1.00	1.00	1.00	1.00
Initial Bse:	195	1493	45	133	784	313	272	900	89	121	753	138
User Adj:	1.00	1.00	1.00	1.00	1.00	1.00	1.00	1.00	1.00	1.00	1.00	1.00
PHF Adj:	1.00	1.00	1.00	1.00	1.00	1.00	1.00	1.00	1.00	1.00	1.00	1.00
PHF Volume:	195	1493	45	133	784	313	272	900	89	121	753	138
Reduct Vol:	0	0	0	0	0	0	0	0	0	0	0	0
Reduced Vol:	195	1493	45	133	784	313	272	900	89	121	753	138
PCE Adj:	1.00	1.00	1.00	1.00	1.00	1.00	1.00	1.00	1.00	1.00	1.00	1.00
MLF Adj:	1.00	1.00	1.00	1.00	1.00	1.00	1.00	1.00	1.00	1.00	1.00	1.00
FinalVolume:	195	1493	45	133	784	313	272	900	89	121	753	138

Saturation Flow Module:

Sat/Lane:	1600	1600	1600	1600	1600	1600	1600	1600	1600	1600	1600	1600
Adjustment:	1.00	1.04	1.00	1.00	1.06	1.00	1.00	1.06	1.00	1.00	1.06	1.00
Lanes:	2.00	2.91	0.09	2.00	3.00	1.00	2.00	2.00	1.00	2.00	2.00	1.00
Final Sat.:	3200	4860	140	3200	5100	1600	3200	3400	1600	3200	3400	1600

Capacity Analysis Module:

Vol/Sat:	0.06	0.31	0.32	0.04	0.15	0.20	0.09	0.26	0.06	0.04	0.22	0.09
Crit Moves:		****	****				****			****		

Santa Ana Circulation Element

Level Of Service Computation Report

ICU 1(Loss as Cycle Length %) Method (Base Volume Alternative)

Intersection #80 Grand Ave and Chestnut Ave

Cycle (sec): 100 Critical Vol./Cap.(X): 0.783
 Loss Time (sec): 5 Average Delay (sec/veh): xxxxxx
 Optimal Cycle: 49 Level Of Service: C

Approach:	North Bound			South Bound			East Bound			West Bound		
Movement:	L	T	R	L	T	R	L	T	R	L	T	R
Control:	Protected			Protected			Permitted			Permitted		
Rights:	Include			Include			Include			Include		
Min. Green:	0	0	0	0	0	0	0	0	0	0	0	0
Y+R:	4.0	4.0	4.0	4.0	4.0	4.0	4.0	4.0	4.0	4.0	4.0	4.0
Lanes:	1	0	2	1	0	2	1	0	1	1	0	1

Volume Module:

Base Vol:	180	1352	234	149	664	112	47	143	31	91	283	165
Growth Adj:	1.00	1.00	1.00	1.00	1.00	1.00	1.00	1.00	1.00	1.00	1.00	1.00
Initial Bse:	180	1352	234	149	664	112	47	143	31	91	283	165
User Adj:	1.00	1.00	1.00	1.00	1.00	1.00	1.00	1.00	1.00	1.00	1.00	1.00
PHF Adj:	1.00	1.00	1.00	1.00	1.00	1.00	1.00	1.00	1.00	1.00	1.00	1.00
PHF Volume:	180	1352	234	149	664	112	47	143	31	91	283	165
Reduct Vol:	0	0	0	0	0	0	0	0	0	0	0	0
Reduced Vol:	180	1352	234	149	664	112	47	143	31	91	283	165
PCE Adj:	1.00	1.00	1.00	1.00	1.00	1.00	1.00	1.00	1.00	1.00	1.00	1.00
MLF Adj:	1.00	1.00	1.00	1.00	1.00	1.00	1.00	1.00	1.00	1.00	1.00	1.00
FinalVolume:	180	1352	234	149	664	112	47	143	31	91	283	165

Saturation Flow Module:

Sat/Lane:	1600	1600	1600	1600	1600	1600	1600	1600	1600	1600	1600	1600
Adjustment:	1.00	1.05	1.00	1.00	1.05	1.00	1.00	1.00	1.00	1.00	1.00	1.00
Lanes:	1.00	2.56	0.44	1.00	2.57	0.43	1.00	0.82	0.18	1.00	0.63	0.37
Final Sat.:	1600	4292	708	1600	4307	693	1600	1315	285	1600	1011	589

Capacity Analysis Module:

Vol/Sat:	0.11	0.32	0.33	0.09	0.15	0.16	0.03	0.11	0.11	0.06	0.28	0.28
Crit Moves:		****	****				****			****		

Santa Ana Circulation Element

Level of Service Computation Report

ICU 1(Loss as Cycle Length %) Method (Base Volume Alternative)

Intersection #81 Grand Ave and McFadden Ave

Cycle (sec): 100 Critical Vol./Cap.(X): 0.813
 Loss Time (sec): 5 Average Delay (sec/veh): xxxxxx
 Optimal Cycle: 55 Level Of Service: D

Approach:	North Bound			South Bound			East Bound			West Bound		
Movement:	L	T	R	L	T	R	L	T	R	L	T	R
Control:	Protected			Protected			Protected			Protected		
Rights:	Include			Include			Include			Include		
Min. Green:	0	0	0	0	0	0	0	0	0	0	0	0
Y+R:	4.0	4.0	4.0	4.0	4.0	4.0	4.0	4.0	4.0	4.0	4.0	4.0
Lanes:	1	0	2	1	0	2	1	0	1	1	0	1

Volume Module:

Base Vol:	232	1320	227	176	800	215	64	238	42	96	762	168
Growth Adj:	1.00	1.00	1.00	1.00	1.00	1.00	1.00	1.00	1.00	1.00	1.00	1.00
Initial Bse:	232	1320	227	176	800	215	64	238	42	96	762	168
User Adj:	1.00	1.00	1.00	1.00	1.00	1.00	1.00	1.00	1.00	1.00	1.00	1.00
PHF Adj:	1.00	1.00	1.00	1.00	1.00	1.00	1.00	1.00	1.00	1.00	1.00	1.00
PHF Volume:	232	1320	227	176	800	215	64	238	42	96	762	168
Reduct Vol:	0	0	0	0	0	0	0	0	0	0	0	0
Reduced Vol:	232	1320	227	176	800	215	64	238	42	96	762	168
PCE Adj:	1.00	1.00	1.00	1.00	1.00	1.00	1.00	1.00	1.00	1.00	1.00	1.00
MLF Adj:	1.00	1.00	1.00	1.00	1.00	1.00	1.00	1.00	1.00	1.00	1.00	1.00
FinalVolume:	232	1320	227	176	800	215	64	238	42	96	762	168

Saturation Flow Module:

Sat/Lane:	1600	1600	1600	1600	1600	1600	1600	1600	1600	1600	1600	1600
Adjustment:	1.00	1.05	1.00	1.00	1.05	1.00	1.00	1.00	1.00	1.00	1.04	1.00
Lanes:	1.00	2.56	0.44	1.00	2.36	0.64	1.00	0.85	0.15	1.00	1.64	0.36
Final Sat.:	1600	4296	704	1600	3983	1017	1600	1360	240	1600	2722	578

Capacity Analysis Module:

Vol/Sat:	0.15	0.31	0.32	0.11	0.20	0.21	0.04	0.17	0.17	0.06	0.28	0.29
Crit Moves:			****	****			****					****

Santa Ana Circulation Element

Level of Service Computation Report

ICU 1(Loss as Cycle Length %) Method (Base Volume Alternative)

Intersection #82 Grand Ave and Edinger Ave

Cycle (sec): 100 Critical Vol./Cap.(X): 1.079
 Loss Time (sec): 5 Average Delay (sec/veh): xxxxxx
 Optimal Cycle: 180 Level Of Service: F

Approach:	North Bound			South Bound			East Bound			West Bound		
Movement:	L	T	R	L	T	R	L	T	R	L	T	R
Control:	Protected			Protected			Protected			Protected		
Rights:	Include			Include			Include			Include		
Min. Green:	0	0	0	0	0	0	0	0	0	0	0	0
Y+R:	4.0	4.0	4.0	4.0	4.0	4.0	4.0	4.0	4.0	4.0	4.0	4.0
Lanes:	1	0	2	1	0	2	1	0	2	1	0	2

Volume Module:

Base Vol:	259	1494	129	236	583	327	207	895	72	98	1758	228
Growth Adj:	1.00	1.00	1.00	1.00	1.00	1.00	1.00	1.00	1.00	1.00	1.00	1.00
Initial Bse:	259	1494	129	236	583	327	207	895	72	98	1758	228
User Adj:	1.00	1.00	1.00	1.00	1.00	1.00	1.00	1.00	1.00	1.00	1.00	1.00
PHF Adj:	1.00	1.00	1.00	1.00	1.00	1.00	1.00	1.00	1.00	1.00	1.00	1.00
PHF Volume:	259	1494	129	236	583	327	207	895	72	98	1758	228
Reduct Vol:	0	0	0	0	0	0	0	0	0	0	0	0
Reduced Vol:	259	1494	129	236	583	327	207	895	72	98	1758	228
PCE Adj:	1.00	1.00	1.00	1.00	1.00	1.00	1.00	1.00	1.00	1.00	1.00	1.00
MLF Adj:	1.00	1.00	1.00	1.00	1.00	1.00	1.00	1.00	1.00	1.00	1.00	1.00
FinalVolume:	259	1494	129	236	583	327	207	895	72	98	1758	228

Saturation Flow Module:

Sat/Lane:	1600	1600	1600	1600	1600	1600	1600	1600	1600	1600	1600	1600
Adjustment:	1.00	1.05	1.00	1.00	1.06	1.00	1.00	1.05	1.00	1.00	1.05	1.00
Lanes:	1.00	2.76	0.24	1.00	2.00	1.00	1.00	2.78	0.22	1.00	2.66	0.34
Final Sat.:	1600	4618	382	1600	3400	1600	1600	4643	357	1600	4449	551

Capacity Analysis Module:

Vol/Sat:	0.16	0.32	0.34	0.15	0.17	0.20	0.13	0.19	0.20	0.06	0.40	0.41
Crit Moves:			****	****			****					****

Santa Ana Circulation Element

Level Of Service Computation Report

ICU 1(Loss as Cycle Length %) Method (Base Volume Alternative)

Intersection #83 Grand Ave and Warner Ave

Cycle (sec): 100 Critical Vol./Cap.(X): 0.899
 Loss Time (sec): 5 Average Delay (sec/veh): xxxxxx
 Optimal Cycle: 86 Level Of Service: D

Approach:	North Bound			South Bound			East Bound			West Bound		
Movement:	L	T	R	L	T	R	L	T	R	L	T	R
Control:	Protected			Protected			Protected			Protected		
Rights:	Include			Include			Include			Include		
Min. Green:	0	0	0	0	0	0	0	0	0	0	0	0
Y+R:	4.0	4.0	4.0	4.0	4.0	4.0	4.0	4.0	4.0	4.0	4.0	4.0
Lanes:	1	0	2	1	0	2	2	0	3	2	0	2

Volume Module:

Base Vol:	218	788	174	178	575	265	342	656	142	244	1556	510
Growth Adj:	1.00	1.00	1.00	1.00	1.00	1.00	1.00	1.00	1.00	1.00	1.00	1.00
Initial Bse:	218	788	174	178	575	265	342	656	142	244	1556	510
User Adj:	1.00	1.00	1.00	1.00	1.00	1.00	1.00	1.00	1.00	1.00	1.00	1.00
PHF Adj:	1.00	1.00	1.00	1.00	1.00	1.00	1.00	1.00	1.00	1.00	1.00	1.00
PHF Volume:	218	788	174	178	575	265	342	656	142	244	1556	510
Reduct Vol:	0	0	0	0	0	0	0	0	0	0	0	0
Reduced Vol:	218	788	174	178	575	265	342	656	142	244	1556	510
PCE Adj:	1.00	1.00	1.00	1.00	1.00	1.00	1.00	1.00	1.00	1.00	1.00	1.00
MLF Adj:	1.00	1.00	1.00	1.00	1.00	1.00	1.00	1.00	1.00	1.00	1.00	1.00
FinalVolume:	218	788	174	178	575	265	342	656	142	244	1556	510

Saturation Flow Module:

Sat/Lane:	1600	1600	1600	1600	1600	1600	1600	1600	1600	1600	1600	1600
Adjustment:	1.00	1.05	1.00	1.00	1.06	1.00	1.00	1.06	1.00	1.00	1.06	1.00
Lanes:	1.00	2.46	0.54	1.00	2.05	0.95	2.00	3.00	1.00	2.00	2.26	0.74
Final Sat.:	1600	4132	868	1600	3486	1514	3200	5100	1600	3200	3815	1185

Capacity Analysis Module:

Vol/Sat:	0.14	0.19	0.20	0.11	0.16	0.18	0.11	0.13	0.09	0.08	0.41	0.43
Crit Moves:	****				****	****	****	****			****	****

Santa Ana Circulation Element

Level Of Service Computation Report
 2000 HCM Operations Method (Base Volume Alternative)

 Intersection #84 SR-55 NB Ramps and Dyer Rd

Cycle (sec): 100 Critical Vol./Cap.(X): 0.349
 Loss Time (sec): 5 Average Delay (sec/veh): 6.0
 Optimal Cycle: 19 Level Of Service: A

Approach:	North Bound			South Bound			East Bound			West Bound		
Movement:	L	T	R	L	T	R	L	T	R	L	T	R
Control:	Split Phase			Split Phase			Protected			Protected		
Rights:	Include			Include			Ignore			Ignore		
Min. Green:	0	0	0	0	0	0	0	0	0	0	0	0
Y+R:	4.0	4.0	4.0	4.0	4.0	4.0	4.0	4.0	4.0	4.0	4.0	4.0
Lanes:	1	0	1	0	0	0	0	0	3	0	2	1

Volume Module:	North Bound			South Bound			East Bound			West Bound		
Base Vol:	188	0	51	0	0	0	0	1355	689	0	1411	882
Growth Adj:	1.00	1.00	1.00	1.00	1.00	1.00	1.00	1.00	1.00	1.00	1.00	1.00
Initial Bse:	188	0	51	0	0	0	0	1355	689	0	1411	882
User Adj:	1.00	1.00	1.00	1.00	1.00	1.00	1.00	1.00	0.00	1.00	1.00	0.00
PHF Adj:	1.00	1.00	1.00	1.00	1.00	1.00	1.00	1.00	0.00	1.00	1.00	0.00
PHF Volume:	188	0	51	0	0	0	0	1355	0	0	1411	0
Reduct Vol:	0	0	0	0	0	0	0	0	0	0	0	0
Reduced Vol:	188	0	51	0	0	0	0	1355	0	0	1411	0
PCE Adj:	1.00	1.00	1.00	1.00	1.00	1.00	1.00	1.00	0.00	1.00	1.00	0.00
MLF Adj:	1.00	1.00	1.00	1.00	1.00	1.00	1.00	1.00	0.00	1.00	1.00	0.00
Final Volume:	188	0	51	0	0	0	0	1355	0	0	1411	0

Saturation Flow Module:	North Bound			South Bound			East Bound			West Bound		
Sat/Lane:	1900	1900	1900	1900	1900	1900	1900	1900	1900	1900	1900	1900
Adjustment:	0.93	1.00	0.93	1.00	1.00	1.00	1.00	0.91	1.00	1.00	0.91	0.91
Lanes:	1.79	0.00	1.21	0.00	0.00	0.00	0.00	3.00	1.00	0.00	3.00	0.00
Final Sat.:	3161	0	2147	0	0	0	0	5187	1900	0	5187	0

Capacity Analysis Module:	North Bound			South Bound			East Bound			West Bound		
Vol/Sat:	0.06	0.00	0.02	0.00	0.00	0.00	0.00	0.26	0.00	0.00	0.27	0.00
Crit Moves:	****			****			****			****		
Green/Cycle:	0.17	0.00	0.17	0.00	0.00	0.00	0.00	0.78	0.00	0.00	0.78	0.00
Volume/Cap:	0.35	0.00	0.14	0.00	0.00	0.00	0.00	0.34	0.00	0.00	0.35	0.00
Delay/Veh:	36.9	0.0	35.3	0.0	0.0	0.0	0.0	3.3	0.0	0.0	3.4	0.0
User DelAdj:	1.00	1.00	1.00	1.00	1.00	1.00	1.00	1.00	1.00	1.00	1.00	1.00
AdjDel/Veh:	36.9	0.0	35.3	0.0	0.0	0.0	0.0	3.3	0.0	0.0	3.4	0.0
LOS by Move:	D	A	D	A	A	A	A	A	A	A	A	A
HCM2k85thQ:	5	0	2	0	0	0	0	7	0	0	8	0

 Note: Queue reported is the number of cars per lane.

Santa Ana Circulation Element

Level Of Service Computation Report

2000 HCM 4-Way Stop Method (Base Volume Alternative)

 Intersection #85 Cambridge St and La Veta Ave

Cycle (sec): 100 Critical Vol./Cap.(X): 0.938
 Loss Time (sec): 5 Average Delay (sec/veh): 26.1
 Optimal Cycle: 0 Level Of Service: D

Approach:	North Bound			South Bound			East Bound			West Bound		
Movement:	L	T	R	L	T	R	L	T	R	L	T	R
Control:	Stop Sign			Stop Sign			Stop Sign			Stop Sign		
Rights:	Include			Include			Include			Include		
Min. Green:	0	0	0	0	0	0	0	0	0	0	0	0
Lanes:	1	0	1	0	0	1	1	0	0	0	0	0

Volume Module:	North Bound			South Bound			East Bound			West Bound		
Base Vol:	176	246	0	0	206	191	469	0	309	0	0	0
Growth Adj:	1.00	1.00	1.00	1.00	1.00	1.00	1.00	1.00	1.00	1.00	1.00	1.00
Initial Bse:	176	246	0	0	206	191	469	0	309	0	0	0
User Adj:	1.00	1.00	1.00	1.00	1.00	1.00	1.00	1.00	1.00	1.00	1.00	1.00
PHF Adj:	1.00	1.00	1.00	1.00	1.00	1.00	1.00	1.00	1.00	1.00	1.00	1.00
PHF Volume:	176	246	0	0	206	191	469	0	309	0	0	0
Reduct Vol:	0	0	0	0	0	0	0	0	0	0	0	0
Reduced Vol:	176	246	0	0	206	191	469	0	309	0	0	0
PCE Adj:	1.00	1.00	1.00	1.00	1.00	1.00	1.00	1.00	1.00	1.00	1.00	1.00
MLF Adj:	1.00	1.00	1.00	1.00	1.00	1.00	1.00	1.00	1.00	1.00	1.00	1.00
FinalVolume:	176	246	0	0	206	191	469	0	309	0	0	0

Saturation Flow Module:	North Bound			South Bound			East Bound			West Bound		
Adjustment:	1.00	1.00	1.00	1.00	1.00	1.00	1.00	1.00	1.00	1.00	1.00	1.00
Lanes:	1.00	1.00	0.00	0.00	1.00	1.00	1.00	0.00	1.00	0.00	0.00	0.00
Final Sat.:	454	486	0	0	479	528	500	0	592	0	0	0

Capacity Analysis Module:	North Bound			South Bound			East Bound			West Bound		
Vol/Sat:	0.39	0.51	xxxx	xxxx	0.43	0.36	0.94	xxxx	0.52	xxxx	xxxx	xxxx
Crit Moves:	****			****			****			****		
Delay/Veh:	15.1	16.9	0.0	0.0	15.3	12.9	52.4	0.0	14.9	0.0	0.0	0.0
Delay Adj:	1.00	1.00	1.00	1.00	1.00	1.00	1.00	1.00	1.00	1.00	1.00	1.00
AdjDel/Veh:	15.1	16.9	0.0	0.0	15.3	12.9	52.4	0.0	14.9	0.0	0.0	0.0
LOS by Move:	C	C	*	*	C	B	F	*	B	*	*	*
ApproachDel:	16.2			14.1			37.5			xxxxxxx		
Delay Adj:	1.00			1.00			1.00			xxxxxxx		
ApprAdjDel:	16.2			14.1			37.5			xxxxxxx		
LOS by Appr:	C			B			E			*		
AllWayAvgQ:	0.6	0.9	0.0	0.0	0.7	0.5	5.9	0.0	1.0	0.0	0.0	0.0

 Note: Queue reported is the number of cars per lane.

Santa Ana Circulation Element

Level Of Service Computation Report

ICU 1(Loss as Cycle Length %) Method (Base Volume Alternative)

Intersection #86 Cambridge St and Fairhaven Ave

Cycle (sec): 100 Critical Vol./Cap.(X): 0.531

Loss Time (sec): 5 Average Delay (sec/veh): xxxxxx

Optimal Cycle: 25 Level Of Service: A

Approach:	North Bound			South Bound			East Bound			West Bound		
Movement:	L	T	R	L	T	R	L	T	R	L	T	R
Control:	Permitted			Permitted			Permitted			Permitted		
Rights:	Include			Include			Include			Include		
Min. Green:	0	0	0	0	0	0	0	0	0	0	0	0
Y+R:	4.0	4.0	4.0	4.0	4.0	4.0	4.0	4.0	4.0	4.0	4.0	4.0
Lanes:	0	0	0	1	0	0	1	0	1	0	0	1

Volume Module:												
Base Vol:	0	0	0	195	0	68	85	148	0	0	218	272
Growth Adj:	1.00	1.00	1.00	1.00	1.00	1.00	1.00	1.00	1.00	1.00	1.00	1.00
Initial Bse:	0	0	0	195	0	68	85	148	0	0	218	272
User Adj:	1.00	1.00	1.00	1.00	1.00	1.00	1.00	1.00	1.00	1.00	1.00	1.00
PHF Adj:	1.00	1.00	1.00	1.00	1.00	1.00	1.00	1.00	1.00	1.00	1.00	1.00
PHF Volume:	0	0	0	195	0	68	85	148	0	0	218	272
Reduct Vol:	0	0	0	0	0	0	0	0	0	0	0	0
Reduced Vol:	0	0	0	195	0	68	85	148	0	0	218	272
PCE Adj:	1.00	1.00	1.00	1.00	1.00	1.00	1.00	1.00	1.00	1.00	1.00	1.00
MLF Adj:	1.00	1.00	1.00	1.00	1.00	1.00	1.00	1.00	1.00	1.00	1.00	1.00
FinalVolume:	0	0	0	195	0	68	85	148	0	0	218	272

Saturation Flow Module:												
Sat/Lane:	1600	1600	1600	1600	1600	1600	1600	1600	1600	1600	1600	1600
Adjustment:	1.00	1.06	1.00	1.00	1.06	1.00	1.00	1.06	1.00	1.00	1.00	1.00
Lanes:	0.00	0.00	0.00	1.00	0.00	1.00	1.00	1.00	0.00	0.00	0.44	0.56
Final Sat.:	0	0	0	1600	0	1600	1600	1700	0	0	712	888

Capacity Analysis Module:												
Vol/Sat:	0.00	0.00	0.00	0.12	0.00	0.04	0.05	0.09	0.00	0.00	0.31	0.31
Crit Moves:				****			****			****		

Santa Ana Circulation Element

Level of Service Computation Report
 2000 HCM Operations Method (Base Volume Alternative)

 Intersection #87 Mabury St and 1st Street

Cycle (sec): 100 Critical Vol./Cap.(X): 0.752
 Loss Time (sec): 5 Average Delay (sec/veh): 27.2
 Optimal Cycle: 46 Level of Service: C

Street Name:	Mabury						1st Street					
Approach:	North Bound			South Bound			East Bound			West Bound		
Movement:	L	T	R	L	T	R	L	T	R	L	T	R
Control:	Split Phase			Split Phase			Protected			Protected		
Rights:	Include			Include			Include			Include		
Min. Green:	0	0	0	0	0	0	0	0	0	0	0	0
Y+R:	4.0	4.0	4.0	4.0	4.0	4.0	4.0	4.0	4.0	4.0	4.0	4.0
Lanes:	1	0	0	0	1	0	0	0	1	1	0	1

Volume Module:	Mabury NB			Mabury SB			1st St EB			1st St WB		
Base Vol:	25	0	256	164	70	310	0	1275	20	31	423	0
Growth Adj:	1.00	1.00	1.00	1.00	1.00	1.00	1.00	1.00	1.00	1.00	1.00	1.00
Initial Bse:	25	0	256	164	70	310	0	1275	20	31	423	0
User Adj:	1.00	1.00	1.00	1.00	1.00	1.00	1.00	1.00	1.00	1.00	1.00	1.00
PHF Adj:	1.00	1.00	1.00	1.00	1.00	1.00	1.00	1.00	1.00	1.00	1.00	1.00
PHF Volume:	25	0	256	164	70	310	0	1275	20	31	423	0
Reduct Vol:	0	0	0	0	0	0	0	0	0	0	0	0
Reduced Vol:	25	0	256	164	70	310	0	1275	20	31	423	0
PCE Adj:	1.00	1.00	1.00	1.00	1.00	1.00	1.00	1.00	1.00	1.00	1.00	1.00
MLF Adj:	1.00	1.00	1.00	1.00	1.00	1.00	1.00	1.00	1.00	1.00	1.00	1.00
Final Volume:	25	0	256	164	70	310	0	1275	20	31	423	0

Saturation Flow Module:	Mabury NB			Mabury SB			1st St EB			1st St WB		
Sat/Lane:	1900	1900	1900	1900	1900	1900	1900	1900	1900	1900	1900	1900
Adjustment:	0.95	1.00	0.85	0.90	0.90	0.90	1.00	0.95	0.95	0.95	0.95	0.95
Lanes:	1.00	0.00	1.00	1.27	0.23	1.50	0.00	1.97	0.03	1.00	2.00	0.00
Final Sat.:	1805	0	1615	2170	390	2577	0	3547	56	1805	3610	0

Capacity Analysis Module:	Mabury NB			Mabury SB			1st St EB			1st St WB		
Vol/Sat:	0.01	0.00	0.16	0.08	0.18	0.12	0.00	0.36	0.36	0.02	0.12	0.00
Crit Moves:			****		****			****		****		
Green/Cycle:	0.21	0.00	0.21	0.24	0.24	0.24	0.00	0.48	0.48	0.02	0.50	0.00
Volume/Cap:	0.07	0.00	0.75	0.32	0.75	0.50	0.00	0.75	0.75	0.75	0.23	0.00
Delay/Veh:	31.7	0.0	46.1	31.5	39.8	33.4	0.0	23.2	23.2	103.1	14.2	0.0
User DelAdj:	1.00	1.00	1.00	1.00	1.00	1.00	1.00	1.00	1.00	1.00	1.00	1.00
AdjDel/Veh:	31.7	0.0	46.1	31.5	39.8	33.4	0.0	23.2	23.2	103.1	14.2	0.0
LOS by Move:	C	A	D	C	D	C	A	C	C	F	B	A
HCM2k85thQ:	1	0	14	5	16	9	0	27	27	4	6	0

Note: Queue reported is the number of cars per lane.

Santa Ana Circulation Element

Level Of Service Computation Report

ICU 1(Loss as Cycle Length %) Method (Base Volume Alternative)

Intersection #88 Tustin St and La Veta Ave

Cycle (sec): 100 Critical Vol./Cap.(X): 0.344
 Loss Time (sec): 5 Average Delay (sec/veh): xxxxxx
 Optimal Cycle: 18 Level Of Service: A

Approach:	North Bound			South Bound			East Bound			West Bound		
Movement:	L	T	R	L	T	R	L	T	R	L	T	R
Control:	Protected			Protected			Split Phase			Split Phase		
Rights:	Include			Include			Include			Ovl		
Min. Green:	0	0	0	0	0	0	0	0	0	0	0	0
Y+R:	4.0	4.0	4.0	4.0	4.0	4.0	4.0	4.0	4.0	4.0	4.0	4.0
Lanes:	1	0	2	1	0	2	1	0	1	1	0	0

Volume Module:

Base Vol:	31	693	164	96	851	16	13	5	20	134	4	82
Growth Adj:	1.00	1.00	1.00	1.00	1.00	1.00	1.00	1.00	1.00	1.00	1.00	1.00
Initial Bse:	31	693	164	96	851	16	13	5	20	134	4	82
User Adj:	1.00	1.00	1.00	1.00	1.00	1.00	1.00	1.00	1.00	1.00	1.00	1.00
PHF Adj:	1.00	1.00	1.00	1.00	1.00	1.00	1.00	1.00	1.00	1.00	1.00	1.00
PHF Volume:	31	693	164	96	851	16	13	5	20	134	4	82
Reduct Vol:	0	0	0	0	0	0	0	0	0	0	0	0
Reduced Vol:	31	693	164	96	851	16	13	5	20	134	4	82
PCE Adj:	1.00	1.00	1.00	1.00	1.00	1.00	1.00	1.00	1.00	1.00	1.00	1.00
MLF Adj:	1.00	1.00	1.00	1.00	1.00	1.00	1.00	1.00	1.00	1.00	1.00	1.00
FinalVolume:	31	693	164	96	851	16	13	5	20	134	4	82
OvlAdjVol:												0

Saturation Flow Module:

Sat/Lane:	1600	1600	1600	1600	1600	1600	1600	1600	1600	1600	1600	1600
Adjustment:	1.00	1.05	1.00	1.00	1.04	1.00	1.00	1.06	1.00	1.00	1.00	1.00
Lanes:	1.00	2.43	0.57	1.00	2.94	0.06	1.00	1.00	1.00	1.94	0.06	1.00
Final Sat.:	1600	4081	919	1600	4911	89	1600	1700	1600	3107	93	1600

Capacity Analysis Module:

Vol/Sat:	0.02	0.17	0.18	0.06	0.17	0.18	0.01	0.00	0.01	0.04	0.04	0.05
OvlAdjV/S:												0.00

Crit Moves: **** *

Santa Ana Circulation Element

Level Of Service Computation Report

2000 HCM Operations Method (Base Volume Alternative)

 Intersection #89 Tustin St and SR-22 WB On-Ramp

Cycle (sec): 100 Critical Vol./Cap.(X): 0.321
 Loss Time (sec): 5 Average Delay (sec/veh): 7.7
 Optimal Cycle: 19 Level Of Service: A

Approach:	North Bound			South Bound			East Bound			West Bound		
Movement:	L	T	R	L	T	R	L	T	R	L	T	R
Control:	Protected			Permitted			Protected			Protected		
Rights:	Include			Include			Include			Include		
Min. Green:	0	0	0	0	0	0	0	0	0	0	0	0
Y+R:	4.0	4.0	4.0	4.0	4.0	4.0	4.0	4.0	4.0	4.0	4.0	4.0
Lanes:	2	0	2	0	0	2	1	0	0	0	0	0

Volume Module:

Base Vol:	383	1100	0	0	642	330	0	0	0	0	0	0
Growth Adj:	1.00	1.00	1.00	1.00	1.00	1.00	1.00	1.00	1.00	1.00	1.00	1.00
Initial Bse:	383	1100	0	0	642	330	0	0	0	0	0	0
User Adj:	1.00	1.00	1.00	1.00	1.00	1.00	1.00	1.00	1.00	1.00	1.00	1.00
PHF Adj:	1.00	1.00	1.00	1.00	1.00	1.00	1.00	1.00	1.00	1.00	1.00	1.00
PHF Volume:	383	1100	0	0	642	330	0	0	0	0	0	0
Reduct Vol:	0	0	0	0	0	0	0	0	0	0	0	0
Reduced Vol:	383	1100	0	0	642	330	0	0	0	0	0	0
PCE Adj:	1.00	1.00	1.00	1.00	1.00	1.00	1.00	1.00	1.00	1.00	1.00	1.00
MLF Adj:	1.00	1.00	1.00	1.00	1.00	1.00	1.00	1.00	1.00	1.00	1.00	1.00
Final Volume:	383	1100	0	0	642	330	0	0	0	0	0	0

Saturation Flow Module:

Sat/Lane:	1900	1900	1900	1900	1900	1900	1900	1900	1900	1900	1900	1900
Adjustment:	0.92	0.95	1.00	1.00	0.86	0.86	1.00	1.00	1.00	1.00	1.00	1.00
Lanes:	2.00	2.00	0.00	0.00	2.00	1.00	0.00	0.00	0.00	0.00	0.00	0.00
Final Sat.:	3502	3610	0	0	3282	1641	0	0	0	0	0	0

Capacity Analysis Module:

Vol/Sat:	0.11	0.30	0.00	0.00	0.20	0.20	0.00	0.00	0.00	0.00	0.00	0.00
Crit Moves:	****			****								
Green/Cycle:	0.34	0.95	0.00	0.00	0.61	0.61	0.00	0.00	0.00	0.00	0.00	0.00
Volume/Cap:	0.32	0.32	0.00	0.00	0.32	0.33	0.00	0.00	0.00	0.00	0.00	0.00
Delay/Veh:	24.6	0.2	0.0	0.0	9.6	9.6	0.0	0.0	0.0	0.0	0.0	0.0
User DelAdj:	1.00	1.00	1.00	1.00	1.00	1.00	1.00	1.00	1.00	1.00	1.00	1.00
AdjDel/Veh:	24.6	0.2	0.0	0.0	9.6	9.6	0.0	0.0	0.0	0.0	0.0	0.0
LOS by Move:	C	A	A	A	A	A	A	A	A	A	A	A
HCM2k85thQ:	7	3	0	0	8	8	0	0	0	0	0	0

Note: Queue reported is the number of cars per lane.

Santa Ana Circulation Element

Level Of Service Computation Report
 2000 HCM Operations Method (Base Volume Alternative)

 Intersection #90 Tustin St and SR-22 EB Off-Ramp / Seba Ave

Cycle (sec): 100 Critical Vol./Cap.(X): 0.625
 Loss Time (sec): 5 Average Delay (sec/veh): 23.3
 Optimal Cycle: 32 Level Of Service: C

Approach:	North Bound			South Bound			East Bound			West Bound		
Movement:	L	T	R	L	T	R	L	T	R	L	T	R
Control:	Permitted			Permitted			Split Phase			Split Phase		
Rights:	Include			Include			Include			Include		
Min. Green:	0	0	0	0	0	0	0	0	0	0	0	0
Y+R:	4.0	4.0	4.0	4.0	4.0	4.0	4.0	4.0	4.0	4.0	4.0	4.0
Lanes:	0	0	2	1	0	3	0	1	0	1	0	0

Volume Module:	North Bound			South Bound			East Bound			West Bound		
Base Vol:	0	1155	3	43	589	0	440	39	558	28	0	67
Growth Adj:	1.00	1.00	1.00	1.00	1.00	1.00	1.00	1.00	1.00	1.00	1.00	1.00
Initial Bse:	0	1155	3	43	589	0	440	39	558	28	0	67
User Adj:	1.00	1.00	1.00	1.00	1.00	1.00	1.00	1.00	1.00	1.00	1.00	1.00
PHF Adj:	1.00	1.00	1.00	1.00	1.00	1.00	1.00	1.00	1.00	1.00	1.00	1.00
PHF Volume:	0	1155	3	43	589	0	440	39	558	28	0	67
Reduct Vol:	0	0	0	0	0	0	0	0	0	0	0	0
Reduced Vol:	0	1155	3	43	589	0	440	39	558	28	0	67
PCE Adj:	1.00	1.00	1.00	1.00	1.00	1.00	1.00	1.00	1.00	1.00	1.00	1.00
MLF Adj:	1.00	1.00	1.00	1.00	1.00	1.00	1.00	1.00	1.00	1.00	1.00	1.00
Final Volume:	0	1155	3	43	589	0	440	39	558	28	0	67

Saturation Flow Module:	North Bound			South Bound			East Bound			West Bound		
Sat/Lane:	1900	1900	1900	1900	1900	1900	1900	1900	1900	1900	1900	1900
Adjustment:	1.00	0.91	0.91	0.11	0.91	1.00	0.90	0.90	0.90	0.89	1.00	0.89
Lanes:	0.00	2.99	0.01	1.00	3.00	0.00	1.41	0.07	1.52	0.29	0.00	0.71
Final Sat.:	0	5174	13	217	5187	0	2408	124	2596	499	0	1195

Capacity Analysis Module:	North Bound			South Bound			East Bound			West Bound		
Vol/Sat:	0.00	0.22	0.22	0.20	0.11	0.00	0.18	0.31	0.21	0.06	0.00	0.06
Crit Moves:	****						****			****		
Green/Cycle:	0.00	0.36	0.36	0.36	0.36	0.00	0.50	0.50	0.50	0.09	0.00	0.09
Volume/Cap:	0.00	0.63	0.63	0.56	0.32	0.00	0.36	0.63	0.43	0.63	0.00	0.63
Delay/Veh:	0.0	27.3	27.3	34.4	23.4	0.0	15.2	18.8	15.8	51.8	0.0	51.8
User DelAdj:	1.00	1.00	1.00	1.00	1.00	1.00	1.00	1.00	1.00	1.00	1.00	1.00
AdjDel/Veh:	0.0	27.3	27.3	34.4	23.4	0.0	15.2	18.8	15.8	51.8	0.0	51.8
LOS by Move:	A	C	C	C	C	A	B	B	B	D	A	D
HCM2k85thQ:	0	17	17	3	7	0	9	19	11	6	0	6

 Note: Queue reported is the number of cars per lane.

Santa Ana Circulation Element

Level Of Service Computation Report

ICU 1(Loss as Cycle Length %) Method (Base Volume Alternative)

Intersection #91 Tustin Ave and Fairhaven Ave

Cycle (sec): 100 Critical Vol./Cap.(X): 0.757

Loss Time (sec): 5 Average Delay (sec/veh): xxxxxx

Optimal Cycle: 44 Level Of Service: C

Approach:	North Bound			South Bound			East Bound			West Bound		
Movement:	L	T	R	L	T	R	L	T	R	L	T	R
Control:	Protected			Protected			Protected			Protected		
Rights:	Include			Include			Include			Include		
Min. Green:	0	0	0	0	0	0	0	0	0	0	0	0
Y+R:	4.0	4.0	4.0	4.0	4.0	4.0	4.0	4.0	4.0	4.0	4.0	4.0
Lanes:	2	0	2	1	0	0	2	0	2	1	0	0

Volume Module:	North Bound			South Bound			East Bound			West Bound		
Base Vol:	258	1377	122	356	940	108	82	185	151	86	191	180
Growth Adj:	1.00	1.00	1.00	1.00	1.00	1.00	1.00	1.00	1.00	1.00	1.00	1.00
Initial Bse:	258	1377	122	356	940	108	82	185	151	86	191	180
User Adj:	1.00	1.00	1.00	1.00	1.00	1.00	1.00	1.00	1.00	1.00	1.00	1.00
PHF Adj:	1.00	1.00	1.00	1.00	1.00	1.00	1.00	1.00	1.00	1.00	1.00	1.00
PHF Volume:	258	1377	122	356	940	108	82	185	151	86	191	180
Reduct Vol:	0	0	0	0	0	0	0	0	0	0	0	0
Reduced Vol:	258	1377	122	356	940	108	82	185	151	86	191	180
PCE Adj:	1.00	1.00	1.00	1.00	1.00	1.00	1.00	1.00	1.00	1.00	1.00	1.00
MLF Adj:	1.00	1.00	1.00	1.00	1.00	1.00	1.00	1.00	1.00	1.00	1.00	1.00
Final Volume:	258	1377	122	356	940	108	82	185	151	86	191	180

Saturation Flow Module:	North Bound			South Bound			East Bound			West Bound		
Sat/Lane:	1600	1600	1600	1600	1600	1600	1600	1600	1600	1600	1600	1600
Adjustment:	1.00	1.05	1.00	1.00	1.05	1.00	1.00	1.00	1.00	1.00	1.00	1.00
Lanes:	2.00	2.76	0.24	2.00	2.69	0.31	1.00	0.55	0.45	1.00	0.51	0.49
Final Sat.:	3200	4609	391	3200	4505	495	1600	881	719	1600	824	776

Capacity Analysis Module:	North Bound			South Bound			East Bound			West Bound		
Vol/Sat:	0.08	0.30	0.31	0.11	0.21	0.22	0.05	0.21	0.21	0.05	0.23	0.23
Crit Moves:	****			****			****			****		

Santa Ana Circulation Element

Level Of Service Computation Report

ICU 1(Loss as Cycle Length %) Method (Base Volume Alternative)

Intersection #92 Tustin Ave and Santa Clara Ave

Cycle (sec): 100 Critical Vol./Cap.(X): 0.779
 Loss Time (sec): 5 Average Delay (sec/veh): xxxxxx
 Optimal Cycle: 48 Level Of Service: C

Approach:	North Bound			South Bound			East Bound			West Bound		
Movement:	L	T	R	L	T	R	L	T	R	L	T	R
Control:	Protected			Protected			Permitted			Permitted		
Rights:	Include			Include			Include			Include		
Min. Green:	0	0	0	0	0	0	0	0	0	0	0	0
Y+R:	4.0	4.0	4.0	4.0	4.0	4.0	4.0	4.0	4.0	4.0	4.0	4.0
Lanes:	1	0	2	1	0	0	1	0	0	1	0	0

Volume Module:

Base Vol:	176	852	131	199	1574	109	63	198	116	115	144	136
Growth Adj:	1.00	1.00	1.00	1.00	1.00	1.00	1.00	1.00	1.00	1.00	1.00	1.00
Initial Bse:	176	852	131	199	1574	109	63	198	116	115	144	136
User Adj:	1.00	1.00	1.00	1.00	1.00	1.00	1.00	1.00	1.00	1.00	1.00	1.00
PHF Adj:	1.00	1.00	1.00	1.00	1.00	1.00	1.00	1.00	1.00	1.00	1.00	1.00
PHF Volume:	176	852	131	199	1574	109	63	198	116	115	144	136
Reduct Vol:	0	0	0	0	0	0	0	0	0	0	0	0
Reduced Vol:	176	852	131	199	1574	109	63	198	116	115	144	136
PCE Adj:	1.00	1.00	1.00	1.00	1.00	1.00	1.00	1.00	1.00	1.00	1.00	1.00
MLF Adj:	1.00	1.00	1.00	1.00	1.00	1.00	1.00	1.00	1.00	1.00	1.00	1.00
FinalVolume:	176	852	131	199	1574	109	63	198	116	115	144	136

Saturation Flow Module:

Sat/Lane:	1600	1600	1600	1600	1600	1600	1600	1600	1600	1600	1600	1600
Adjustment:	1.00	1.05	1.00	1.00	1.04	1.00	1.00	1.00	1.00	1.00	1.00	1.00
Lanes:	1.00	2.60	0.40	2.00	2.81	0.19	1.00	0.63	0.37	1.00	0.51	0.49
Final Sat.:	1600	4360	640	3200	4689	311	1600	1009	591	1600	823	777

Capacity Analysis Module:

Vol/Sat:	0.11	0.20	0.20	0.06	0.34	0.35	0.04	0.20	0.20	0.07	0.18	0.17
Crit Moves:	****					****	****			****		

Santa Ana Circulation Element

Level Of Service Computation Report

ICU 1(Loss as Cycle Length %) Method (Base Volume Alternative)

 Intersection #93 Tustin Ave and 17th St

Cycle (sec): 100 Critical Vol./Cap.(X): 0.741
 Loss Time (sec): 5 Average Delay (sec/veh): xxxxxx
 Optimal Cycle: 42 Level Of Service: C

Approach:	North Bound			South Bound			East Bound			West Bound		
Movement:	L	T	R	L	T	R	L	T	R	L	T	R
Control:	Protected			Protected			Protected			Protected		
Rights:	Ovl			Include			Include			Ovl		
Min. Green:	0	0	0	0	0	0	0	0	0	0	0	0
Y+R:	4.0	4.0	4.0	4.0	4.0	4.0	4.0	4.0	4.0	4.0	4.0	4.0
Lanes:	2	0	2	0	1	0	2	0	3	0	1	2

Volume Module:

Base Vol:	233	1000	514	377	404	40	457	898	122	211	693	385
Growth Adj:	1.00	1.00	1.00	1.00	1.00	1.00	1.00	1.00	1.00	1.00	1.00	1.00
Initial Bse:	233	1000	514	377	404	40	457	898	122	211	693	385
User Adj:	1.00	1.00	1.00	1.00	1.00	1.00	1.00	1.00	1.00	1.00	1.00	1.00
PHF Adj:	1.00	1.00	1.00	1.00	1.00	1.00	1.00	1.00	1.00	1.00	1.00	1.00
PHF Volume:	233	1000	514	377	404	40	457	898	122	211	693	385
Reduct Vol:	0	0	0	0	0	0	0	0	0	0	0	0
Reduced Vol:	233	1000	514	377	404	40	457	898	122	211	693	385
PCE Adj:	1.00	1.00	1.00	1.00	1.00	1.00	1.00	1.00	1.00	1.00	1.00	1.00
MLF Adj:	1.00	1.00	1.00	1.00	1.00	1.00	1.00	1.00	1.00	1.00	1.00	1.00
FinalVolume:	233	1000	514	377	404	40	457	898	122	211	693	385
OvlAdjVol:	409									197		

Saturation Flow Module:

Sat/Lane:	1600	1600	1600	1600	1600	1600	1600	1600	1600	1600	1600	1600
Adjustment:	1.00	1.06	1.00	1.00	1.05	1.00	1.00	1.06	1.00	1.00	1.06	1.00
Lanes:	2.00	2.00	1.00	2.00	2.73	0.27	2.00	3.00	1.00	2.00	3.00	1.00
Final Sat.:	3200	3400	1600	3200	4568	432	3200	5100	1600	3200	5100	1600

Capacity Analysis Module:

Vol/Sat:	0.07	0.29	0.32	0.12	0.09	0.09	0.14	0.18	0.08	0.07	0.14	0.24
OvlAdjV/S:	0.26									0.12		
Crit Moves:	****			****			****			****		

Santa Ana Circulation Element

Level Of Service Computation Report

ICU 1(Loss as Cycle Length %) Method (Base Volume Alternative)

Intersection #94 Tustin Ave and 4th St

Cycle (sec): 100 Critical Vol./Cap.(X): 0.784
 Loss Time (sec): 5 Average Delay (sec/veh): xxxxxx
 Optimal Cycle: 49 Level Of Service: C

Approach:	North Bound			South Bound			East Bound			West Bound		
Movement:	L	T	R	L	T	R	L	T	R	L	T	R
Control:	Protected			Protected			Protected			Protected		
Rights:	Include			Include			Include			Include		
Min. Green:	0	0	0	0	0	0	0	0	0	0	0	0
Y+R:	4.0	4.0	4.0	4.0	4.0	4.0	4.0	4.0	4.0	4.0	4.0	4.0
Lanes:	1	0	2	1	0	2	1	0	2	1	0	2

Volume Module:

Base Vol:	35	381	123	536	396	145	226	806	41	123	833	513
Growth Adj:	1.00	1.00	1.00	1.00	1.00	1.00	1.00	1.00	1.00	1.00	1.00	1.00
Initial Bse:	35	381	123	536	396	145	226	806	41	123	833	513
User Adj:	1.00	1.00	1.00	1.00	1.00	1.00	1.00	1.00	1.00	1.00	1.00	1.00
PHF Adj:	1.00	1.00	1.00	1.00	1.00	1.00	1.00	1.00	1.00	1.00	1.00	1.00
PHF Volume:	35	381	123	536	396	145	226	806	41	123	833	513
Reduct Vol:	0	0	0	0	0	0	0	0	0	0	0	0
Reduced Vol:	35	381	123	536	396	145	226	806	41	123	833	513
PCE Adj:	1.00	1.00	1.00	1.00	1.00	1.00	1.00	1.00	1.00	1.00	1.00	1.00
MLF Adj:	1.00	1.00	1.00	1.00	1.00	1.00	1.00	1.00	1.00	1.00	1.00	1.00
FinalVolume:	35	381	123	536	396	145	226	806	41	123	833	513

Saturation Flow Module:

Sat/Lane:	1600	1600	1600	1600	1600	1600	1600	1600	1600	1600	1600	1600
Adjustment:	1.00	1.06	1.00	1.00	1.06	1.00	1.00	1.06	1.00	1.00	1.06	1.00
Lanes:	1.00	2.27	0.73	2.00	2.00	1.00	1.00	3.00	1.00	1.00	2.00	1.00
Final Sat.:	1600	3829	1171	3200	3400	1600	1600	5100	1600	1600	3400	1600

Capacity Analysis Module:

Vol/Sat:	0.02	0.10	0.11	0.17	0.12	0.09	0.14	0.16	0.03	0.08	0.25	0.32
Crit Moves:			****	****			****					****

Santa Ana Circulation Element

Level Of Service Computation Report

2000 HCM Operations Method (Base Volume Alternative)

Intersection #95 SR-55 SB Ramps / Auto Mall Dr and Edinger Ave

Cycle (sec): 100 Critical Vol./Cap.(X): 0.687
 Loss Time (sec): 5 Average Delay (sec/veh): 25.4
 Optimal Cycle: 37 Level Of Service: C

Approach:	North Bound			South Bound			East Bound			West Bound		
Movement:	L	T	R	L	T	R	L	T	R	L	T	R
Control:	Split Phase			Split Phase			Protected			Protected		
Rights:	Include			Include			Ignore			Include		
Min. Green:	0	0	0	0	0	0	0	0	0	0	0	0
Y+R:	4.0	4.0	4.0	4.0	4.0	4.0	4.0	4.0	4.0	4.0	4.0	4.0
Lanes:	1	1	0	0	0	2	1	0	1	0	1	1

Volume Module:

Base Vol:	401	32	423	110	50	37	46	1649	464	437	1139	136
Growth Adj:	1.00	1.00	1.00	1.00	1.00	1.00	1.00	1.00	1.00	1.00	1.00	1.00
Initial Bse:	401	32	423	110	50	37	46	1649	464	437	1139	136
User Adj:	1.00	1.00	1.00	1.00	1.00	1.00	1.00	1.00	0.00	1.00	1.00	1.00
PHF Adj:	1.00	1.00	1.00	1.00	1.00	1.00	1.00	1.00	0.00	1.00	1.00	1.00
PHF Volume:	401	32	423	110	50	37	46	1649	0	437	1139	136
Reduct Vol:	0	0	0	0	0	0	0	0	0	0	0	0
Reduced Vol:	401	32	423	110	50	37	46	1649	0	437	1139	136
PCE Adj:	1.00	1.00	1.00	1.00	1.00	1.00	1.00	1.00	0.00	1.00	1.00	1.00
MLF Adj:	1.00	1.00	1.00	1.00	1.00	1.00	1.00	1.00	0.00	1.00	1.00	1.00
FinalVolume:	401	32	423	110	50	37	46	1649	0	437	1139	136

Saturation Flow Module:

Sat/Lane:	1900	1900	1900	1900	1900	1900	1900	1900	1900	1900	1900	1900
Adjustment:	0.96	0.96	0.75	0.95	1.00	0.85	0.95	0.91	1.00	0.92	0.90	0.90
Lanes:	1.85	0.15	2.00	1.00	1.00	1.00	1.00	3.00	1.00	2.00	2.68	0.32
Final Sat.:	3364	268	2842	1805	1900	1615	1805	5187	1900	3502	4560	544

Capacity Analysis Module:

Vol/Sat:	0.12	0.12	0.15	0.06	0.03	0.02	0.03	0.32	0.00	0.12	0.25	0.25
Crit Moves:			****	****				****		****		
Green/Cycle:	0.22	0.22	0.22	0.09	0.09	0.09	0.06	0.46	0.00	0.18	0.58	0.58
Volume/Cap:	0.55	0.55	0.69	0.69	0.30	0.26	0.43	0.69	0.00	0.69	0.43	0.43
Delay/Veh:	35.7	35.7	39.3	56.0	43.6	43.5	48.1	22.0	0.0	41.4	11.6	11.6
User DelAdj:	1.00	1.00	1.00	1.00	1.00	1.00	1.00	1.00	1.00	1.00	1.00	1.00
AdjDel/Veh:	35.7	35.7	39.3	56.0	43.6	43.5	48.1	22.0	0.0	41.4	11.6	11.6
LOS by Move:	D	D	D	E	D	D	D	C	A	D	B	B
HCM2k85thQ:	10	10	12	7	3	2	3	23	0	12	12	12

Note: Queue reported is the number of cars per lane.

Santa Ana Circulation Element

Level Of Service Computation Report

2000 HCM Operations Method (Base Volume Alternative)

 Intersection #96 SR-55 NB Ramps / Del Amo Ave and Newport Avenue

Cycle (sec): 100 Critical Vol./Cap.(X): 0.951
 Loss Time (sec): 5 Average Delay (sec/veh): 46.2
 Optimal Cycle: 134 Level Of Service: D

Approach:	North Bound			South Bound			East Bound			West Bound		
Movement:	L	T	R	L	T	R	L	T	R	L	T	R
Control:	Protected			Protected			Protected			Protected		
Rights:	Include			Ovl			Include			Include		
Min. Green:	0	0	0	0	0	0	0	0	0	0	0	0
Y+R:	4.0	4.0	4.0	4.0	4.0	4.0	4.0	4.0	4.0	4.0	4.0	4.0
Lanes:	2	0	2	1	0	3	0	1	1	0	1	1

Volume Module:	North Bound			South Bound			East Bound			West Bound		
Base Vol:	879	262	51	19	231	889	165	57	33	23	348	16
Growth Adj:	1.00	1.00	1.00	1.00	1.00	1.00	1.00	1.00	1.00	1.00	1.00	1.00
Initial Bse:	879	262	51	19	231	889	165	57	33	23	348	16
User Adj:	1.00	1.00	1.00	1.00	1.00	1.00	1.00	1.00	1.00	1.00	1.00	1.00
PHF Adj:	1.00	1.00	1.00	1.00	1.00	1.00	1.00	1.00	1.00	1.00	1.00	1.00
PHF Volume:	879	262	51	19	231	889	165	57	33	23	348	16
Reduct Vol:	0	0	0	0	0	0	0	0	0	0	0	0
Reduced Vol:	879	262	51	19	231	889	165	57	33	23	348	16
PCE Adj:	1.00	1.00	1.00	1.00	1.00	1.00	1.00	1.00	1.00	1.00	1.00	1.00
MLF Adj:	1.00	1.00	1.00	1.00	1.00	1.00	1.00	1.00	1.00	1.00	1.00	1.00
FinalVolume:	879	262	51	19	231	889	165	57	33	23	348	16

Saturation Flow Module:	North Bound			South Bound			East Bound			West Bound		
Sat/Lane:	1900	1900	1900	1900	1900	1900	1900	1900	1900	1900	1900	1900
Adjustment:	0.92	0.89	0.89	0.95	0.91	0.85	0.92	0.90	0.90	0.95	0.94	0.94
Lanes:	2.00	2.51	0.49	1.00	3.00	1.00	2.00	1.27	0.73	1.00	1.91	0.09
Final Sat.:	3502	4238	825	1805	5187	1615	3502	2161	1251	1805	3427	158

Capacity Analysis Module:	North Bound			South Bound			East Bound			West Bound		
Vol/Sat:	0.25	0.06	0.06	0.01	0.04	0.55	0.05	0.03	0.03	0.01	0.10	0.10
Crit Moves:	****			****			****			****		
Green/Cycle:	0.26	0.68	0.68	0.12	0.53	0.58	0.05	0.11	0.11	0.05	0.11	0.11
Volume/Cap:	0.95	0.09	0.09	0.09	0.08	0.95	0.95	0.25	0.25	0.25	0.95	0.95
Delay/Veh:	54.9	5.5	5.5	39.7	11.6	38.3	101.1	41.5	41.5	47.0	77.7	77.7
User DelAdj:	1.00	1.00	1.00	1.00	1.00	1.00	1.00	1.00	1.00	1.00	1.00	1.00
AdjDel/Veh:	54.9	5.5	5.5	39.7	11.6	38.3	101.1	41.5	41.5	47.0	77.7	77.7
LOS by Move:	D	A	A	D	B	D	F	D	D	D	E	E
HCM2k85thQ:	27	2	2	1	2	44	8	2	2	1	15	15

Note: Queue reported is the number of cars per lane.

Santa Ana Circulation Element

Level Of Service Computation Report

ICU 1(Loss as Cycle Length %) Method (Base Volume Alternative)

 Intersection #97 Red Hill Ave and Edinger Ave

Cycle (sec): 100 Critical Vol./Cap.(X): 0.865
 Loss Time (sec): 5 Average Delay (sec/veh): xxxxxx
 Optimal Cycle: 70 Level Of Service: D

Approach:	North Bound			South Bound			East Bound			West Bound		
Movement:	L	T	R	L	T	R	L	T	R	L	T	R
Control:	Protected			Protected			Protected			Protected		
Rights:	Include			Ovl			Ovl			Include		
Min. Green:	0	0	0	0	0	0	0	0	0	0	0	0
Y+R:	4.0	4.0	4.0	4.0	4.0	4.0	4.0	4.0	4.0	4.0	4.0	4.0
Lanes:	2	0	3	0	1		2	0	3	0	1	

Volume Module:

Base Vol:	208	1501	238	108	214	173	410	1051	128	91	1176	574	
Growth Adj:	1.00	1.00	1.00	1.00	1.00	1.00	1.00	1.00	1.00	1.00	1.00	1.00	
Initial Bse:	208	1501	238	108	214	173	410	1051	128	91	1176	574	
User Adj:	1.00	1.00	1.00	1.00	1.00	1.00	1.00	1.00	1.00	1.00	1.00	1.00	
PHF Adj:	1.00	1.00	1.00	1.00	1.00	1.00	1.00	1.00	1.00	1.00	1.00	1.00	
PHF Volume:	208	1501	238	108	214	173	410	1051	128	91	1176	574	
Reduct Vol:	0	0	0	0	0	0	0	0	0	0	0	0	
Reduced Vol:	208	1501	238	108	214	173	410	1051	128	91	1176	574	
PCE Adj:	1.00	1.00	1.00	1.00	1.00	1.00	1.00	1.00	1.00	1.00	1.00	1.00	
MLF Adj:	1.00	1.00	1.00	1.00	1.00	1.00	1.00	1.00	1.00	1.00	1.00	1.00	
FinalVolume:	208	1501	238	108	214	173	410	1051	128	91	1176	574	
OvlAdjVol:							0				24		

Saturation Flow Module:

Sat/Lane:	1600	1600	1600	1600	1600	1600	1600	1600	1600	1600	1600	1600
Adjustment:	1.00	1.06	1.00	1.00	1.06	1.00	1.00	1.06	1.00	1.00	1.06	1.00
Lanes:	2.00	3.00	1.00	2.00	3.00	1.00	2.00	3.00	1.00	2.00	3.00	1.00
Final Sat.:	3200	5100	1600	3200	5100	1600	3200	5100	1600	3200	5100	1600

Capacity Analysis Module:

Vol/Sat:	0.07	0.29	0.15	0.03	0.04	0.11	0.13	0.21	0.08	0.03	0.23	0.36	
OvlAdjV/S:							0.00				0.02		
Crit Moves:	****			****			****			****			

 Santa Ana Circulation Element

Level Of Service Computation Report

ICU 1(Loss as Cycle Length %) Method (Base Volume Alternative)

Intersection #98 Red Hill Ave and Warner Ave

Cycle (sec): 100 Critical Vol./Cap.(X): 0.952
 Loss Time (sec): 5 Average Delay (sec/veh): xxxxxxx
 Optimal Cycle: 132 Level Of Service: E

Approach:	North Bound			South Bound			East Bound			West Bound		
Movement:	L	T	R	L	T	R	L	T	R	L	T	R
Control:	Protected			Protected			Protected			Protected		
Rights:	Include			Include			Include			Ovl		
Min. Green:	0	0	0	0	0	0	0	0	0	0	0	0
Y+R:	4.0	4.0	4.0	4.0	4.0	4.0	4.0	4.0	4.0	4.0	4.0	4.0
Lanes:	2	0	3	1	0	0	2	0	2	1	0	3

Volume Module:	North Bound			South Bound			East Bound			West Bound		
Base Vol:	343	1175	135	89	341	432	324	880	137	78	1643	216
Growth Adj:	1.00	1.00	1.00	1.00	1.00	1.00	1.00	1.00	1.00	1.00	1.00	1.00
Initial Bse:	343	1175	135	89	341	432	324	880	137	78	1643	216
User Adj:	1.00	1.00	1.00	1.00	1.00	1.00	1.00	1.00	1.00	1.00	1.00	1.00
PHF Adj:	1.00	1.00	1.00	1.00	1.00	1.00	1.00	1.00	1.00	1.00	1.00	1.00
PHF Volume:	343	1175	135	89	341	432	324	880	137	78	1643	216
Reduct Vol:	0	0	0	0	0	0	0	0	0	0	0	0
Reduced Vol:	343	1175	135	89	341	432	324	880	137	78	1643	216
PCE Adj:	1.00	1.00	1.00	1.00	1.00	1.00	1.00	1.00	1.00	1.00	1.00	1.00
MLF Adj:	1.00	1.00	1.00	1.00	1.00	1.00	1.00	1.00	1.00	1.00	1.00	1.00
FinalVolume:	343	1175	135	89	341	432	324	880	137	78	1643	216
OvlAdjVol:												172

Saturation Flow Module:	North Bound			South Bound			East Bound			West Bound		
Sat/Lane:	1600	1600	1600	1600	1600	1600	1600	1600	1600	1600	1600	1600
Adjustment:	1.00	1.05	1.00	1.00	1.06	1.00	1.00	1.05	1.00	1.00	1.06	1.00
Lanes:	2.00	3.59	0.41	2.00	2.00	1.00	1.00	2.60	0.40	2.00	3.00	1.00
Final Sat.:	3200	6040	660	3200	3400	1600	1600	4353	647	3200	5100	1600

Capacity Analysis Module:	North Bound			South Bound			East Bound			West Bound		
Vol/Sat:	0.11	0.19	0.20	0.03	0.10	0.27	0.20	0.20	0.21	0.02	0.32	0.14
OvlAdjV/S:												0.11
Crit Moves:	****			****			****			****		

 Santa Ana Circulation Element

Level Of Service Computation Report

ICU 1(Loss as Cycle Length %) Method (Base Volume Alternative)

Intersection #99 Red Hill Ave and Dyer Rd / barranca Pkwy

Cycle (sec): 100 Critical Vol./Cap.(X): 0.591
 Loss Time (sec): 5 Average Delay (sec/veh): xxxxxxx
 Optimal Cycle: 28 Level Of Service: A

Approach:	North Bound			South Bound			East Bound			West Bound		
Movement:	L	T	R	L	T	R	L	T	R	L	T	R
Control:	Protected			Protected			Protected			Protected		
Rights:	Include			Include			Include			Include		
Min. Green:	0	0	0	0	0	0	0	0	0	0	0	0
Y+R:	4.0	4.0	4.0	4.0	4.0	4.0	4.0	4.0	4.0	4.0	4.0	4.0
Lanes:	2	0	4	0	1		2	0	4	0	1	

Volume Module:

Base Vol:	344	1293	333	314	531	249	178	662	87	129	979	286
Growth Adj:	1.00	1.00	1.00	1.00	1.00	1.00	1.00	1.00	1.00	1.00	1.00	1.00
Initial Bse:	344	1293	333	314	531	249	178	662	87	129	979	286
User Adj:	1.00	1.00	1.00	1.00	1.00	1.00	1.00	1.00	1.00	1.00	1.00	1.00
PHF Adj:	1.00	1.00	1.00	1.00	1.00	1.00	1.00	1.00	1.00	1.00	1.00	1.00
PHF Volume:	344	1293	333	314	531	249	178	662	87	129	979	286
Reduct Vol:	0	0	0	0	0	0	0	0	0	0	0	0
Reduced Vol:	344	1293	333	314	531	249	178	662	87	129	979	286
PCE Adj:	1.00	1.00	1.00	1.00	1.00	1.00	1.00	1.00	1.00	1.00	1.00	1.00
MLF Adj:	1.00	1.00	1.00	1.00	1.00	1.00	1.00	1.00	1.00	1.00	1.00	1.00
FinalVolume:	344	1293	333	314	531	249	178	662	87	129	979	286

Saturation Flow Module:

Sat/Lane:	1600	1600	1600	1600	1600	1600	1600	1600	1600	1600	1600	1600
Adjustment:	1.00	1.06	1.00	1.00	1.06	1.00	1.00	1.05	1.00	1.00	1.06	1.00
Lanes:	2.00	4.00	1.00	2.00	4.00	1.00	2.00	3.54	0.46	2.00	4.00	1.00
Final Sat.:	3200	6800	1600	3200	6800	1600	3200	5957	743	3200	6800	1600

Capacity Analysis Module:

Vol/Sat:	0.11	0.19	0.21	0.10	0.08	0.16	0.06	0.11	0.12	0.04	0.14	0.18
Crit Moves:	****			****			****			****		

Santa Ana Circulation Element

Level Of Service Computation Report

ICU 1(Loss as Cycle Length %) Method (Base Volume Alternative)

Intersection #100 Red Hill Ave and Alton Pkwy

Cycle (sec): 100 Critical Vol./Cap.(X): 1.494
 Loss Time (sec): 5 Average Delay (sec/veh): xxxxxx
 Optimal Cycle: 180 Level Of Service: F

Approach:	North Bound			South Bound			East Bound			West Bound		
Movement:	L	T	R	L	T	R	L	T	R	L	T	R
Control:	Protected			Protected			Protected			Protected		
Rights:	Include			Include			Include			Include		
Min. Green:	0	0	0	0	0	0	0	0	0	0	0	0
Y+R:	4.0	4.0	4.0	4.0	4.0	4.0	4.0	4.0	4.0	4.0	4.0	4.0
Lanes:	1	0	3	0	1	1	1	0	2	0	1	0

Volume Module:

Base Vol:	27	1513	219	148	628	5	453	1111	569	2003	342	1235
Growth Adj:	1.00	1.00	1.00	1.00	1.00	1.00	1.00	1.00	1.00	1.00	1.00	1.00
Initial Bse:	27	1513	219	148	628	5	453	1111	569	2003	342	1235
User Adj:	1.00	1.00	1.00	1.00	1.00	1.00	1.00	1.00	1.00	1.00	1.00	1.00
PHF Adj:	1.00	1.00	1.00	1.00	1.00	1.00	1.00	1.00	1.00	1.00	1.00	1.00
PHF Volume:	27	1513	219	148	628	5	453	1111	569	2003	342	1235
Reduct Vol:	0	0	0	0	0	0	0	0	0	0	0	0
Reduced Vol:	27	1513	219	148	628	5	453	1111	569	2003	342	1235
PCE Adj:	1.00	1.00	1.00	1.00	1.00	1.00	1.00	1.00	1.00	1.00	1.00	1.00
MLF Adj:	1.00	1.00	1.00	1.00	1.00	1.00	1.00	1.00	1.00	1.00	1.00	1.00
FinalVolume:	27	1513	219	148	628	5	453	1111	569	2003	342	1235

Saturation Flow Module:

Sat/Lane:	1600	1600	1600	1600	1600	1600	1600	1600	1600	1600	1600	1600
Adjustment:	1.00	1.06	1.00	1.00	1.06	1.00	1.00	1.06	1.00	1.00	1.06	1.00
Lanes:	1.00	3.00	1.00	1.00	3.00	1.00	1.00	2.00	1.00	2.00	1.00	1.00
Final Sat.:	1600	5100	1600	1600	5100	1600	1600	3400	1600	3200	1700	1600

Capacity Analysis Module:

Vol/Sat:	0.02	0.30	0.14	0.09	0.12	0.00	0.28	0.33	0.36	0.63	0.20	0.77
Crit Moves:	****			****			****			****		

Santa Ana Circulation Element

Level Of Service Computation Report

ICU 1(Loss as Cycle Length %) Method (Base Volume Alternative)

 Intersection #101 Red Hill Ave and MacArthur Blvd

Cycle (sec): 100 Critical Vol./Cap.(X): 0.722
 Loss Time (sec): 5 Average Delay (sec/veh): xxxxxx
 Optimal Cycle: 40 Level Of Service: C

Approach:	North Bound			South Bound			East Bound			West Bound		
Movement:	L	T	R	L	T	R	L	T	R	L	T	R
Control:	Protected			Protected			Protected			Protected		
Rights:	Include			Ignore			Include			Ignore		
Min. Green:	0	0	0	0	0	0	0	0	0	0	0	0
Y+R:	4.0	4.0	4.0	4.0	4.0	4.0	4.0	4.0	4.0	4.0	4.0	4.0
Lanes:	2	0	2	1	0	0	2	0	3	0	1	0

Volume Module:

Base Vol:	179	1160	14	340	707	1240	515	237	36	39	818	574
Growth Adj:	1.00	1.00	1.00	1.00	1.00	1.00	1.00	1.00	1.00	1.00	1.00	1.00
Initial Bse:	179	1160	14	340	707	1240	515	237	36	39	818	574
User Adj:	1.00	1.00	1.00	1.00	1.00	0.00	1.00	1.00	1.00	1.00	1.00	0.00
PHF Adj:	1.00	1.00	1.00	1.00	1.00	0.00	1.00	1.00	1.00	1.00	1.00	0.00
PHF Volume:	179	1160	14	340	707	0	515	237	36	39	818	0
Reduct Vol:	0	0	0	0	0	0	0	0	0	0	0	0
Reduced Vol:	179	1160	14	340	707	0	515	237	36	39	818	0
PCE Adj:	1.00	1.00	1.00	1.00	1.00	0.00	1.00	1.00	1.00	1.00	1.00	0.00
MLF Adj:	1.00	1.00	1.00	1.00	1.00	0.00	1.00	1.00	1.00	1.00	1.00	0.00
FinalVolume:	179	1160	14	340	707	0	515	237	36	39	818	0

Saturation Flow Module:

Sat/Lane:	1600	1600	1600	1600	1600	1600	1600	1600	1600	1600	1600	1600
Adjustment:	1.00	1.04	1.00	1.00	1.06	1.00	1.00	1.06	1.00	1.00	1.06	1.00
Lanes:	2.00	2.96	0.04	2.00	3.00	1.00	2.00	3.00	1.00	1.00	3.00	1.00
Final Sat.:	3200	4943	57	3200	5100	1600	3200	5100	1600	1600	5100	1600

Capacity Analysis Module:

Vol/Sat:	0.06	0.23	0.24	0.11	0.14	0.00	0.16	0.05	0.02	0.02	0.16	0.00
Crit Moves:			****	****			****				****	

Santa Ana Circulation Element

Level Of Service Computation Report

ICU 1(Loss as Cycle Length %) Method (Base Volume Alternative)

 Intersection #102 Red Hill Ave and Main St

Cycle (sec): 100 Critical Vol./Cap.(X): 0.836
 Loss Time (sec): 5 Average Delay (sec/veh): xxxxxx
 Optimal Cycle: 61 Level Of Service: D

Approach:	North Bound			South Bound			East Bound			West Bound		
Movement:	L	T	R	L	T	R	L	T	R	L	T	R
Control:	Protected			Protected			Protected			Protected		
Rights:	Include			Include			Include			Include		
Min. Green:	0	0	0	0	0	0	0	0	0	0	0	0
Y+R:	4.0	4.0	4.0	4.0	4.0	4.0	4.0	4.0	4.0	4.0	4.0	4.0
Lanes:	2	0	2	0	2	0	1	2	0	2	1	0

Volume Module:

Base Vol:	467	1006	272	88	640	348	212	757	205	284	1617	91
Growth Adj:	1.00	1.00	1.00	1.00	1.00	1.00	1.00	1.00	1.00	1.00	1.00	1.00
Initial Bse:	467	1006	272	88	640	348	212	757	205	284	1617	91
User Adj:	1.00	1.00	1.00	1.00	1.00	1.00	1.00	1.00	1.00	1.00	1.00	1.00
PHF Adj:	1.00	1.00	1.00	1.00	1.00	1.00	1.00	1.00	1.00	1.00	1.00	1.00
PHF Volume:	467	1006	272	88	640	348	212	757	205	284	1617	91
Reduct Vol:	0	0	0	0	0	0	0	0	0	0	0	0
Reduced Vol:	467	1006	272	88	640	348	212	757	205	284	1617	91
PCE Adj:	1.00	1.00	1.00	1.00	1.00	1.00	1.00	1.00	1.00	1.00	1.00	1.00
MLF Adj:	1.00	1.00	1.00	1.00	1.00	1.00	1.00	1.00	1.00	1.00	1.00	1.00
FinalVolume:	467	1006	272	88	640	348	212	757	205	284	1617	91

Saturation Flow Module:

Sat/Lane:	1600	1600	1600	1600	1600	1600	1600	1600	1600	1600	1600	1600
Adjustment:	1.00	1.06	1.00	1.00	1.06	1.00	1.00	1.05	1.00	1.00	1.04	1.00
Lanes:	2.00	2.00	1.00	2.00	2.00	1.00	2.00	2.36	0.64	2.00	2.84	0.16
Final Sat.:	3200	3400	1600	3200	3400	1600	3200	3977	1023	3200	4744	256

Capacity Analysis Module:

Vol/Sat:	0.15	0.30	0.17	0.03	0.19	0.22	0.07	0.19	0.20	0.09	0.34	0.36
Crit Moves:	****					****	****					****

Santa Ana Circulation Element

Level Of Service Computation Report

2000 HCM Operations Method (Base Volume Alternative)

 Intersection #103 I-5 SB Ramps and Santa Ana Blvd

Cycle (sec): 100 Critical Vol./Cap.(X): 0.444
 Loss Time (sec): 5 Average Delay (sec/veh): 19.9
 Optimal Cycle: 22 Level Of Service: B

Approach:	North Bound			South Bound			East Bound			West Bound		
Movement:	L	T	R	L	T	R	L	T	R	L	T	R
Control:	Split Phase			Split Phase			Protected			Protected		
Rights:	Include			Ovl			Include			Include		
Min. Green:	0	0	0	0	0	0	0	0	0	0	0	0
Y+R:	4.0	4.0	4.0	4.0	4.0	4.0	4.0	4.0	4.0	4.0	4.0	4.0
Lanes:	0	0	0	2	0	0	2	0	3	0	0	2

Volume Module:	North Bound			South Bound			East Bound			West Bound		
Base Vol:	0	0	0	357	0	78	595	672	0	0	590	162
Growth Adj:	1.00	1.00	1.00	1.00	1.00	1.00	1.00	1.00	1.00	1.00	1.00	1.00
Initial Bse:	0	0	0	357	0	78	595	672	0	0	590	162
User Adj:	1.00	1.00	1.00	1.00	1.00	1.00	1.00	1.00	1.00	1.00	1.00	1.00
PHF Adj:	1.00	1.00	1.00	1.00	1.00	1.00	1.00	1.00	1.00	1.00	1.00	1.00
PHF Volume:	0	0	0	357	0	78	595	672	0	0	590	162
Reduct Vol:	0	0	0	0	0	0	0	0	0	0	0	0
Reduced Vol:	0	0	0	357	0	78	595	672	0	0	590	162
PCE Adj:	1.00	1.00	1.00	1.00	1.00	1.00	1.00	1.00	1.00	1.00	1.00	1.00
MLF Adj:	1.00	1.00	1.00	1.00	1.00	1.00	1.00	1.00	1.00	1.00	1.00	1.00
Final Volume:	0	0	0	357	0	78	595	672	0	0	590	162

Saturation Flow Module:	North Bound			South Bound			East Bound			West Bound		
Sat/Lane:	1900	1900	1900	1900	1900	1900	1900	1900	1900	1900	1900	1900
Adjustment:	1.00	1.00	1.00	0.92	1.00	0.85	0.92	0.91	1.00	1.00	0.88	0.88
Lanes:	0.00	0.00	0.00	2.00	0.00	1.00	2.00	3.00	0.00	0.00	2.35	0.65
Final Sat.:	0	0	0	3502	0	1615	3502	5187	0	0	3939	1082

Capacity Analysis Module:	North Bound			South Bound			East Bound			West Bound		
Vol/Sat:	0.00	0.00	0.00	0.10	0.00	0.05	0.17	0.13	0.00	0.00	0.15	0.15
Crit Moves:				****			****			****		
Green/Cycle:	0.00	0.00	0.00	0.23	0.00	0.61	0.38	0.72	0.00	0.00	0.34	0.34
Volume/Cap:	0.00	0.00	0.00	0.44	0.00	0.08	0.44	0.18	0.00	0.00	0.44	0.44
Delay/Veh:	0.0	0.0	0.0	33.4	0.0	7.9	23.2	4.5	0.0	0.0	26.0	26.0
User DelAdj:	1.00	1.00	1.00	1.00	1.00	1.00	1.00	1.00	1.00	1.00	1.00	1.00

AdjDel/Veh:	0.0	0.0	0.0	33.4	0.0	7.9	23.2	4.5	0.0	0.0	26.0	26.0
LOS by Move:	A	A	A	C	A	A	C	A	A	A	C	C
HCM2k85thQ:	0	0	0	8	0	2	11	4	0	0	10	10

Note: Queue reported is the number of cars per lane.

Santa Ana Circulation Element

Level Of Service Computation Report

ICU 1(Loss as Cycle Length %) Method (Base Volume Alternative)

 Intersection #104 Tustin Ranch Rd and Warner Ave

Cycle (sec): 100 Critical Vol./Cap.(X): 0.671
 Loss Time (sec): 5 Average Delay (sec/veh): xxxxxx
 Optimal Cycle: 34 Level Of Service: B

Approach:	North Bound			South Bound			East Bound			West Bound		
Movement:	L	T	R	L	T	R	L	T	R	L	T	R
Control:	Split Phase			Split Phase			Protected			Protected		
Rights:	Include			Include			Include			Ovl		
Min. Green:	0	0	0	0	0	0	0	0	0	0	0	0
Y+R:	4.0	4.0	4.0	4.0	4.0	4.0	4.0	4.0	4.0	4.0	4.0	4.0
Lanes:	0	0	0	2	0	0	2	0	3	0	0	3

Volume Module:

Base Vol:	0	0	0	653	0	45	64	2124	0	0	925	398
Growth Adj:	1.00	1.00	1.00	1.00	1.00	1.00	1.00	1.00	1.00	1.00	1.00	1.00
Initial Bse:	0	0	0	653	0	45	64	2124	0	0	925	398
User Adj:	1.00	1.00	1.00	1.00	1.00	1.00	1.00	1.00	1.00	1.00	1.00	1.00
PHF Adj:	1.00	1.00	1.00	1.00	1.00	1.00	1.00	1.00	1.00	1.00	1.00	1.00
PHF Volume:	0	0	0	653	0	45	64	2124	0	0	925	398
Reduct Vol:	0	0	0	0	0	0	0	0	0	0	0	0
Reduced Vol:	0	0	0	653	0	45	64	2124	0	0	925	398
PCE Adj:	1.00	1.00	1.00	1.00	1.00	1.00	1.00	1.00	1.00	1.00	1.00	1.00
MLF Adj:	1.00	1.00	1.00	1.00	1.00	1.00	1.00	1.00	1.00	1.00	1.00	1.00
FinalVolume:	0	0	0	653	0	45	64	2124	0	0	925	398
OvlAdjVol:												71

Saturation Flow Module:

Sat/Lane:	1600	1600	1600	1600	1600	1600	1600	1600	1600	1600	1600	1600
Adjustment:	1.00	1.06	1.00	1.00	1.06	1.00	1.00	1.06	1.00	1.00	1.06	1.00
Lanes:	0.00	0.00	0.00	2.00	0.00	1.00	2.00	3.00	0.00	0.00	3.00	1.00
Final Sat.:	0	0	0	3200	0	1600	3200	5100	0	0	5100	1600

Capacity Analysis Module:

Vol/Sat:	0.00	0.00	0.00	0.20	0.00	0.03	0.02	0.42	0.00	0.00	0.18	0.25
OvlAdjV/S:												0.04
Crit Moves:				****				****				****

Santa Ana Circulation Element

Level Of Service Computation Report

ICU 1(Loss as Cycle Length %) Method (Base Volume Alternative)

Intersection #105 Von Karman Ave and Barranca Pkwy

Cycle (sec): 100 Critical Vol./Cap.(X): 1.284
 Loss Time (sec): 5 Average Delay (sec/veh): xxxxxxx
 Optimal Cycle: 180 Level Of Service: F

Approach:	North Bound			South Bound			East Bound			West Bound		
Movement:	L	T	R	L	T	R	L	T	R	L	T	R
Control:	Protected			Protected			Protected			Protected		
Rights:	Include			Ovl			Include			Include		
Min. Green:	0	0	0	0	0	0	0	0	0	0	0	0
Y+R:	4.0	4.0	4.0	4.0	4.0	4.0	4.0	4.0	4.0	4.0	4.0	4.0
Lanes:	2	0	1	1	0	2	2	0	3	0	1	2

Volume Module:

Base Vol:	362	2082	454	80	407	280	785	1435	201	254	805	274
Growth Adj:	1.00	1.00	1.00	1.00	1.00	1.00	1.00	1.00	1.00	1.00	1.00	1.00
Initial Bse:	362	2082	454	80	407	280	785	1435	201	254	805	274
User Adj:	1.00	1.00	1.00	1.00	1.00	1.00	1.00	1.00	1.00	1.00	1.00	1.00
PHF Adj:	1.00	1.00	1.00	1.00	1.00	1.00	1.00	1.00	1.00	1.00	1.00	1.00
PHF Volume:	362	2082	454	80	407	280	785	1435	201	254	805	274
Reduct Vol:	0	0	0	0	0	0	0	0	0	0	0	0
Reduced Vol:	362	2082	454	80	407	280	785	1435	201	254	805	274
PCE Adj:	1.00	1.00	1.00	1.00	1.00	1.00	1.00	1.00	1.00	1.00	1.00	1.00
MLF Adj:	1.00	1.00	1.00	1.00	1.00	1.00	1.00	1.00	1.00	1.00	1.00	1.00
FinalVolume:	362	2082	454	80	407	280	785	1435	201	254	805	274
OvlAdjVol:	0											

Saturation Flow Module:

Sat/Lane:	1600	1600	1600	1600	1600	1600	1600	1600	1600	1600	1600	1600
Adjustment:	1.00	1.04	1.00	1.00	1.06	1.00	1.00	1.06	1.00	1.00	1.06	1.00
Lanes:	2.00	1.64	0.36	2.00	2.00	2.00	2.00	3.00	1.00	2.00	4.00	1.00
Final Sat.:	3200	2727	573	3200	3400	3200	3200	5100	1600	3200	6800	1600

Capacity Analysis Module:

Vol/Sat:	0.11	0.76	0.79	0.03	0.12	0.09	0.25	0.28	0.13	0.08	0.12	0.17
OvlAdjV/S:							0.00					
Crit Moves:	****			****			****			****		

Santa Ana Circulation Element

Level Of Service Computation Report

ICU 1(Loss as Cycle Length %) Method (Base Volume Alternative)

Intersection #106 Red Hill Avenue and El Camino Real

Cycle (sec): 100 Critical Vol./Cap.(X): 0.696
 Loss Time (sec): 5 Average Delay (sec/veh): xxxxxx
 Optimal Cycle: 37 Level Of Service: B

Street Name:	Red Hill Avenue						El Camino Real					
	North Bound			South Bound			East Bound			West Bound		
Approach:	North Bound			South Bound			East Bound			West Bound		
Movement:	L	T	R	L	T	R	L	T	R	L	T	R
Control:	Protected			Protected			Protected			Protected		
Rights:	Include			Include			Include			Include		
Min. Green:	0	0	0	0	0	0	0	0	0	0	0	0
Y+R:	4.0	4.0	4.0	4.0	4.0	4.0	4.0	4.0	4.0	4.0	4.0	4.0
Lanes:	2	0	3	0	1	1	0	2	1	0	1	0

Volume Module:												
Base Vol:	433	1372	253	20	728	96	52	113	148	265	439	51
Growth Adj:	1.00	1.00	1.00	1.00	1.00	1.00	1.00	1.00	1.00	1.00	1.00	1.00
Initial Bse:	433	1372	253	20	728	96	52	113	148	265	439	51
User Adj:	1.00	1.00	1.00	1.00	1.00	1.00	1.00	1.00	1.00	1.00	1.00	1.00
PHF Adj:	1.00	1.00	1.00	1.00	1.00	1.00	1.00	1.00	1.00	1.00	1.00	1.00
PHF Volume:	433	1372	253	20	728	96	52	113	148	265	439	51
Reduct Vol:	0	0	0	0	0	0	0	0	0	0	0	0
Reduced Vol:	433	1372	253	20	728	96	52	113	148	265	439	51
PCE Adj:	1.00	1.00	1.00	1.00	1.00	1.00	1.00	1.00	1.00	1.00	1.00	1.00
MLF Adj:	1.00	1.00	1.00	1.00	1.00	1.00	1.00	1.00	1.00	1.00	1.00	1.00
FinalVolume:	433	1372	253	20	728	96	52	113	148	265	439	51

Saturation Flow Module:												
Sat/Lane:	1600	1600	1600	1600	1600	1600	1600	1600	1600	1600	1600	1600
Adjustment:	1.00	1.06	1.00	1.00	1.05	1.00	1.00	1.06	1.00	1.00	1.00	1.00
Lanes:	2.00	3.00	1.00	1.00	2.65	0.35	1.00	1.00	1.00	1.00	0.90	0.10
Final Sat.:	3200	5100	1600	1600	4441	559	1600	1700	1600	1600	1433	167

Capacity Analysis Module:												
Vol/Sat:	0.14	0.27	0.16	0.01	0.16	0.17	0.03	0.07	0.09	0.17	0.31	0.31
Crit Moves:	****					****	****				****	

Santa Ana Circulation Element

Level Of Service Computation Report
 2000 HCM Operations Method (Base Volume Alternative)

 Intersection #107 Red Hill Avenue and I-5 NB Ramps

 Cycle (sec): 100 Critical Vol./Cap.(X): 0.623
 Loss Time (sec): 5 Average Delay (sec/veh): 23.6
 Optimal Cycle: 32 Level Of Service: C

Street Name:	Red Hill Avenue						I-5 NB Ramps					
	North Bound			South Bound			East Bound			West Bound		
Approach:	L	T	R	L	T	R	L	T	R	L	T	R
Movement:												
Control:	Protected			Protected			Permitted			Permitted		
Rights:	Include			Include			Include			Include		
Min. Green:	0	0	0	0	0	0	0	0	0	0	0	0
Y+R:	4.0	4.0	4.0	4.0	4.0	4.0	4.0	4.0	4.0	4.0	4.0	4.0
Lanes:	1	0	3	0	0	3	0	0	0	1	1	0

Volume Module:												
Base Vol:	292	1670	0	0	865	175	0	0	0	256	96	415
Growth Adj:	1.00	1.00	1.00	1.00	1.00	1.00	1.00	1.00	1.00	1.00	1.00	1.00
Initial Bse:	292	1670	0	0	865	175	0	0	0	256	96	415
User Adj:	1.00	1.00	1.00	1.00	1.00	1.00	1.00	1.00	1.00	1.00	1.00	1.00
PHF Adj:	1.00	1.00	1.00	1.00	1.00	1.00	1.00	1.00	1.00	1.00	1.00	1.00
PHF Volume:	292	1670	0	0	865	175	0	0	0	256	96	415
Reduct Vol:	0	0	0	0	0	0	0	0	0	0	0	0
Reduced Vol:	292	1670	0	0	865	175	0	0	0	256	96	415
PCE Adj:	1.00	1.00	1.00	1.00	1.00	1.00	1.00	1.00	1.00	1.00	1.00	1.00
MLF Adj:	1.00	1.00	1.00	1.00	1.00	1.00	1.00	1.00	1.00	1.00	1.00	1.00
FinalVolume:	292	1670	0	0	865	175	0	0	0	256	96	415

Saturation Flow Module:												
Sat/Lane:	1900	1900	1900	1900	1900	1900	1900	1900	1900	1900	1900	1900
Adjustment:	0.95	0.91	1.00	1.00	0.91	0.85	1.00	1.00	1.00	0.83	0.83	0.83
Lanes:	1.00	3.00	0.00	0.00	3.00	1.00	0.00	0.00	0.00	1.45	0.55	1.00
Final Sat.:	1805	5187	0	0	5187	1615	0	0	0	2292	860	1576

Capacity Analysis Module:												
Vol/Sat:	0.16	0.32	0.00	0.00	0.17	0.11	0.00	0.00	0.00	0.11	0.11	0.26
Crit Moves:	****				****							****
Green/Cycle:	0.26	0.53	0.00	0.00	0.27	0.27	0.00	0.00	0.00	0.42	0.42	0.42
Volume/Cap:	0.62	0.61	0.00	0.00	0.62	0.40	0.00	0.00	0.00	0.26	0.26	0.62
Delay/Veh:	35.3	16.9	0.0	0.0	33.1	30.7	0.0	0.0	0.0	18.8	18.8	23.6
User DelAdj:	1.00	1.00	1.00	1.00	1.00	1.00	1.00	1.00	1.00	1.00	1.00	1.00

AdjDel/Veh:	35.3	16.9	0.0	0.0	33.1	30.7	0.0	0.0	0.0	18.8	18.8	23.6
LOS by Move:	D	B	A	A	C	C	A	A	A	B	B	C
HCM2k85thQ:	13	20	0	0	14	7	0	0	0	6	6	17

Note: Queue reported is the number of cars per lane.

Santa Ana Circulation Element

Level of Service Computation Report
 2000 HCM Operations Method (Base Volume Alternative)

 Intersection #108 Red Hill Avenue and I-5 SB Ramps

Cycle (sec): 100 Critical Vol./Cap.(X): 0.713
 Loss Time (sec): 5 Average Delay (sec/veh): 21.8
 Optimal Cycle: 40 Level Of Service: C

Street Name:	Red Hill Avenue						I-5 SB Ramps					
Approach:	North Bound			South Bound			East Bound			West Bound		
Movement:	L	T	R	L	T	R	L	T	R	L	T	R
Control:	Protected			Protected			Permitted			Permitted		
Rights:	Include			Include			Include			Include		
Min. Green:	0	0	0	0	0	0	0	0	0	0	0	0
Y+R:	4.0	4.0	4.0	4.0	4.0	4.0	4.0	4.0	4.0	4.0	4.0	4.0
Lanes:	0	0	4	0	1	0	1	0	0	1	0	0

Volume Module:	North Bound			South Bound			East Bound			West Bound		
Base Vol:	0	1700	540	310	744	0	296	3	265	0	0	0
Growth Adj:	1.00	1.00	1.00	1.00	1.00	1.00	1.00	1.00	1.00	1.00	1.00	1.00
Initial Bse:	0	1700	540	310	744	0	296	3	265	0	0	0
User Adj:	1.00	1.00	1.00	1.00	1.00	1.00	1.00	1.00	1.00	1.00	1.00	1.00
PHF Adj:	1.00	1.00	1.00	1.00	1.00	1.00	1.00	1.00	1.00	1.00	1.00	1.00
PHF Volume:	0	1700	540	310	744	0	296	3	265	0	0	0
Reduct Vol:	0	0	0	0	0	0	0	0	0	0	0	0
Reduced Vol:	0	1700	540	310	744	0	296	3	265	0	0	0
PCE Adj:	1.00	1.00	1.00	1.00	1.00	1.00	1.00	1.00	1.00	1.00	1.00	1.00
MLF Adj:	1.00	1.00	1.00	1.00	1.00	1.00	1.00	1.00	1.00	1.00	1.00	1.00
Final Volume:	0	1700	540	310	744	0	296	3	265	0	0	0

Saturation Flow Module:	North Bound			South Bound			East Bound			West Bound		
Sat/Lane:	1900	1900	1900	1900	1900	1900	1900	1900	1900	1900	1900	1900
Adjustment:	1.00	0.91	0.85	0.95	0.91	1.00	0.92	0.92	0.85	1.00	1.00	1.00
Lanes:	0.00	4.00	1.00	1.00	3.00	0.00	0.99	0.01	1.00	0.00	0.00	0.00
Final Sat.:	0	6916	1615	1805	5187	0	1732	18	1615	0	0	0

Capacity Analysis Module:	North Bound			South Bound			East Bound			West Bound		
Vol/Sat:	0.00	0.25	0.33	0.17	0.14	0.00	0.17	0.17	0.16	0.00	0.00	0.00
Crit Moves:	****			****			****			****		
Green/Cycle:	0.00	0.47	0.47	0.24	0.71	0.00	0.24	0.24	0.24	0.00	0.00	0.00
Volume/Cap:	0.00	0.52	0.71	0.71	0.20	0.00	0.71	0.71	0.68	0.00	0.00	0.00
Delay/Veh:	0.0	18.8	24.4	40.3	4.9	0.0	40.5	40.5	39.6	0.0	0.0	0.0
User DelAdj:	1.00	1.00	1.00	1.00	1.00	1.00	1.00	1.00	1.00	1.00	1.00	1.00
AdjDel/Veh:	0.0	18.8	24.4	40.3	4.9	0.0	40.5	40.5	39.6	0.0	0.0	0.0
LOS by Move:	A	B	C	D	A	A	D	D	D	A	A	A
HCM2k85thQ:	0	15	21	15	4	0	15	15	13	0	0	0

 Note: Queue reported is the number of cars per lane.

Santa Ana Circulation Element

Level of Service Computation Report

ICU 1(Loss as Cycle Length %) Method (Base Volume Alternative)

 Intersection #109 Red Hill Avenue and Nisson Road

Cycle (sec): 100 Critical Vol./Cap.(X): 0.715
 Loss Time (sec): 5 Average Delay (sec/veh): xxxxxx
 Optimal Cycle: 39 Level Of Service: C

Street Name:	Red Hill Avenue						Nisson Road					
	North Bound			South Bound			East Bound			West Bound		
Approach:	North Bound			South Bound			East Bound			West Bound		
Movement:	L	T	R	L	T	R	L	T	R	L	T	R
Control:	Protected			Protected			Split Phase			Split Phase		
Rights:	Include			Include			Include			Include		
Min. Green:	0	0	0	0	0	0	0	0	0	0	0	0
Y+R:	4.0	4.0	4.0	4.0	4.0	4.0	4.0	4.0	4.0	4.0	4.0	4.0
Lanes:	1	0	3	1	0	2	1	0	0	1	0	0

Volume Module:

Base Vol:	34	1769	36	142	730	73	247	90	40	48	83	141
Growth Adj:	1.00	1.00	1.00	1.00	1.00	1.00	1.00	1.00	1.00	1.00	1.00	1.00
Initial Bse:	34	1769	36	142	730	73	247	90	40	48	83	141
User Adj:	1.00	1.00	1.00	1.00	1.00	1.00	1.00	1.00	1.00	1.00	1.00	1.00
PHF Adj:	1.00	1.00	1.00	1.00	1.00	1.00	1.00	1.00	1.00	1.00	1.00	1.00
PHF Volume:	34	1769	36	142	730	73	247	90	40	48	83	141
Reduct Vol:	0	0	0	0	0	0	0	0	0	0	0	0
Reduced Vol:	34	1769	36	142	730	73	247	90	40	48	83	141
PCE Adj:	1.00	1.00	1.00	1.00	1.00	1.00	1.00	1.00	1.00	1.00	1.00	1.00
MLF Adj:	1.00	1.00	1.00	1.00	1.00	1.00	1.00	1.00	1.00	1.00	1.00	1.00
FinalVolume:	34	1769	36	142	730	73	247	90	40	48	83	141

Saturation Flow Module:

Sat/Lane:	1600	1600	1600	1600	1600	1600	1600	1600	1600	1600	1600	1600
Adjustment:	1.00	1.05	1.00	1.00	1.05	1.00	1.00	1.00	1.00	1.00	1.00	1.00
Lanes:	1.00	3.92	0.08	1.00	2.73	0.27	1.00	0.69	0.31	1.00	0.37	0.63
Final Sat.:	1600	6572	128	1600	4564	436	1600	1108	492	1600	593	1007

Capacity Analysis Module:

Vol/Sat:	0.02	0.27	0.28	0.09	0.16	0.17	0.15	0.08	0.08	0.03	0.14	0.14
Crit Moves:			****	****			****			****		

Santa Ana Circulation Element

Level Of Service Computation Report

ICU 1(Loss as Cycle Length %) Method (Base Volume Alternative)

Intersection #110 Red Hill Avenue and Walnut Avenue

Cycle (sec): 100 Critical Vol./Cap.(X): 0.749
 Loss Time (sec): 5 Average Delay (sec/veh): xxxxxx
 Optimal Cycle: 43 Level Of Service: C

Street Name:	Red Hill Avenue						Walnut Avenue					
Approach:	North Bound			South Bound			East Bound			West Bound		
Movement:	L	T	R	L	T	R	L	T	R	L	T	R
Control:	Protected			Protected			Protected			Protected		
Rights:	Include			Include			Include			Include		
Min. Green:	0	0	0	0	0	0	0	0	0	0	0	0
Y+R:	4.0	4.0	4.0	4.0	4.0	4.0	4.0	4.0	4.0	4.0	4.0	4.0
Lanes:	1	0	2	1	0	2	1	0	1	1	0	1

Volume Module:

Base Vol:	283	1378	99	123	382	160	91	218	90	196	654	171
Growth Adj:	1.00	1.00	1.00	1.00	1.00	1.00	1.00	1.00	1.00	1.00	1.00	1.00
Initial Bse:	283	1378	99	123	382	160	91	218	90	196	654	171
User Adj:	1.00	1.00	1.00	1.00	1.00	1.00	1.00	1.00	1.00	1.00	1.00	1.00
PHF Adj:	1.00	1.00	1.00	1.00	1.00	1.00	1.00	1.00	1.00	1.00	1.00	1.00
PHF Volume:	283	1378	99	123	382	160	91	218	90	196	654	171
Reduct Vol:	0	0	0	0	0	0	0	0	0	0	0	0
Reduced Vol:	283	1378	99	123	382	160	91	218	90	196	654	171
PCE Adj:	1.00	1.00	1.00	1.00	1.00	1.00	1.00	1.00	1.00	1.00	1.00	1.00
MLF Adj:	1.00	1.00	1.00	1.00	1.00	1.00	1.00	1.00	1.00	1.00	1.00	1.00
FinalVolume:	283	1378	99	123	382	160	91	218	90	196	654	171

Saturation Flow Module:

Sat/Lane:	1600	1600	1600	1600	1600	1600	1600	1600	1600	1600	1600	1600
Adjustment:	1.00	1.04	1.00	1.00	1.06	1.00	1.00	1.04	1.00	1.00	1.04	1.00
Lanes:	1.00	2.80	0.20	1.00	2.11	0.89	1.00	1.42	0.58	2.00	1.59	0.41
Final Sat.:	1600	4678	322	1600	3583	1417	1600	2365	935	3200	2637	663

Capacity Analysis Module:

Vol/Sat:	0.18	0.29	0.31	0.08	0.11	0.11	0.06	0.09	0.10	0.06	0.25	0.26
Crit Moves:			****	****			****				****	****

Santa Ana Circulation Element

Level Of Service Computation Report

ICU 1(Loss as Cycle Length %) Method (Base Volume Alternative)

Intersection #111 Red Hill Avenue and Valencia Avenue

Cycle (sec): 100 Critical Vol./Cap.(X): 0.753
 Loss Time (sec): 5 Average Delay (sec/veh): xxxxxx
 Optimal Cycle: 44 Level Of Service: C

Street Name:	Red Hill Avenue						Valencia Avenue					
Approach:	North Bound			South Bound			East Bound			West Bound		
Movement:	L	T	R	L	T	R	L	T	R	L	T	R
Control:	Protected			Protected			Protected			Protected		
Rights:	Ovl			Include			Include			Ovl		
Min. Green:	0	0	0	0	0	0	0	0	0	0	0	0
Y+R:	4.0	4.0	4.0	4.0	4.0	4.0	4.0	4.0	4.0	4.0	4.0	4.0
Lanes:	1	0	3	1	0	2	1	0	1	2	0	1

Volume Module:	Red Hill Avenue			Red Hill Avenue			Valencia Avenue			Valencia Avenue		
Base Vol:	248	1849	305	116	467	52	110	297	130	284	412	272
Growth Adj:	1.00	1.00	1.00	1.00	1.00	1.00	1.00	1.00	1.00	1.00	1.00	1.00
Initial Bse:	248	1849	305	116	467	52	110	297	130	284	412	272
User Adj:	1.00	1.00	1.00	1.00	1.00	1.00	1.00	1.00	1.00	1.00	1.00	1.00
PHF Adj:	1.00	1.00	1.00	1.00	1.00	1.00	1.00	1.00	1.00	1.00	1.00	1.00
PHF Volume:	248	1849	305	116	467	52	110	297	130	284	412	272
Reduct Vol:	0	0	0	0	0	0	0	0	0	0	0	0
Reduced Vol:	248	1849	305	116	467	52	110	297	130	284	412	272
PCE Adj:	1.00	1.00	1.00	1.00	1.00	1.00	1.00	1.00	1.00	1.00	1.00	1.00
MLF Adj:	1.00	1.00	1.00	1.00	1.00	1.00	1.00	1.00	1.00	1.00	1.00	1.00
FinalVolume:	248	1849	305	116	467	52	110	297	130	284	412	272
OvlAdjVol:	225									156		

Saturation Flow Module:	Red Hill Avenue			Red Hill Avenue			Valencia Avenue			Valencia Avenue		
Sat/Lane:	1600	1600	1600	1600	1600	1600	1600	1600	1600	1600	1600	1600
Adjustment:	1.00	1.05	1.00	1.00	1.05	1.00	1.00	1.06	1.00	1.00	1.06	1.00
Lanes:	1.00	3.43	0.57	1.00	2.70	0.30	1.00	1.00	1.00	2.00	1.00	1.00
Final Sat.:	1600	5794	906	1600	4519	481	1600	1700	1600	3200	1700	1600

Capacity Analysis Module:	Red Hill Avenue			Red Hill Avenue			Valencia Avenue			Valencia Avenue		
Vol/Sat:	0.16	0.32	0.34	0.07	0.10	0.11	0.07	0.17	0.08	0.09	0.24	0.17
OvlAdjV/S:	0.25									0.10		
Crit Moves:	****			****			****			****		

Santa Ana Circulation Element

Level of Service Computation Report

ICU 1(Loss as Cycle Length %) Method (Base Volume Alternative)

Intersection #112 Tustin Ranch Road and Warner Avenue North

Cycle (sec): 100 Critical Vol./Cap.(X): 0.924
 Loss Time (sec): 5 Average Delay (sec/veh): xxxxxx
 Optimal Cycle: 103 Level Of Service: E

Street Name:	Tustin Ranch Road						Warner Avenue North					
Approach:	North Bound			South Bound			East Bound			West Bound		
Movement:	L	T	R	L	T	R	L	T	R	L	T	R
Control:	Protected			Protected			Split Phase			Split Phase		
Rights:	Ovl			Include			Include			Ovl		
Min. Green:	0	0	0	0	0	0	0	0	0	0	0	0
Y+R:	4.0	4.0	4.0	4.0	4.0	4.0	4.0	4.0	4.0	4.0	4.0	4.0
Lanes:	0	0	3	0	1		2	0	3	0	0	2

Volume Module:	Tustin Ranch Road			Tustin Ranch Road			Warner Avenue North			Warner Avenue North		
Base Vol:	0	1995	1175	447	657	0	0	0	0	792	0	716
Growth Adj:	1.00	1.00	1.00	1.00	1.00	1.00	1.00	1.00	1.00	1.00	1.00	1.00
Initial Bse:	0	1995	1175	447	657	0	0	0	0	792	0	716
User Adj:	1.00	1.00	1.00	1.00	1.00	1.00	1.00	1.00	1.00	1.00	1.00	1.00
PHF Adj:	1.00	1.00	1.00	1.00	1.00	1.00	1.00	1.00	1.00	1.00	1.00	1.00
PHF Volume:	0	1995	1175	447	657	0	0	0	0	792	0	716
Reduct Vol:	0	0	0	0	0	0	0	0	0	0	0	0
Reduced Vol:	0	1995	1175	447	657	0	0	0	0	792	0	716
PCE Adj:	1.00	1.00	1.00	1.00	1.00	1.00	1.00	1.00	1.00	1.00	1.00	1.00
MLF Adj:	1.00	1.00	1.00	1.00	1.00	1.00	1.00	1.00	1.00	1.00	1.00	1.00
FinalVolume:	0	1995	1175	447	657	0	0	0	0	792	0	716
OvlAdjVol:	911									269		

Saturation Flow Module:	Tustin Ranch Road			Tustin Ranch Road			Warner Avenue North			Warner Avenue North		
Sat/Lane:	1600	1600	1600	1600	1600	1600	1600	1600	1600	1600	1600	1600
Adjustment:	1.00	1.06	1.00	1.00	1.06	1.00	1.00	1.06	1.00	1.00	1.06	1.00
Lanes:	0.00	3.00	1.00	2.00	3.00	0.00	0.00	0.00	0.00	3.00	0.00	2.00
Final Sat.:	0	5100	1600	3200	5100	0	0	0	0	4800	0	3200

Capacity Analysis Module:	Tustin Ranch Road			Tustin Ranch Road			Warner Avenue North			Warner Avenue North		
Vol/Sat:	0.00	0.39	0.73	0.14	0.13	0.00	0.00	0.00	0.00	0.17	0.00	0.22
OvlAdjV/S:	0.57									0.08		
Crit Moves:	****			****						****		

Santa Ana Circulation Element

Level of Service Computation Report

ICU 1(Loss as Cycle Length %) Method (Base Volume Alternative)

Intersection #113 Tustin Ranch Road and Walnut Avenue

Cycle (sec): 100 Critical Vol./Cap.(X): 1.772
 Loss Time (sec): 5 Average Delay (sec/veh): xxxxxx
 Optimal Cycle: 180 Level Of Service: F

Street Name:	Tustin Ranch Road						Walnut Avenue					
Approach:	North Bound			South Bound			East Bound			West Bound		
Movement:	L	T	R	L	T	R	L	T	R	L	T	R
Control:	Protected			Protected			Protected			Protected		
Rights:	Ovl			Ovl			Include			Ovl		
Min. Green:	0	0	0	0	0	0	0	0	0	0	0	0
Y+R:	4.0	4.0	4.0	4.0	4.0	4.0	4.0	4.0	4.0	4.0	4.0	4.0
Lanes:	2	0	3	0	1		2	0	3	0	1	

Volume Module:

Base Vol:	876	3814	401	550	1460	947	329	402	230	307	1760	1394
Growth Adj:	1.00	1.00	1.00	1.00	1.00	1.00	1.00	1.00	1.00	1.00	1.00	1.00
Initial Bse:	876	3814	401	550	1460	947	329	402	230	307	1760	1394
User Adj:	1.00	1.00	1.00	1.00	1.00	1.00	1.00	1.00	1.00	1.00	1.00	1.00
PHF Adj:	1.00	1.00	1.00	1.00	1.00	1.00	1.00	1.00	1.00	1.00	1.00	1.00
PHF Volume:	876	3814	401	550	1460	947	329	402	230	307	1760	1394
Reduct Vol:	0	0	0	0	0	0	0	0	0	0	0	0
Reduced Vol:	876	3814	401	550	1460	947	329	402	230	307	1760	1394
PCE Adj:	1.00	1.00	1.00	1.00	1.00	1.00	1.00	1.00	1.00	1.00	1.00	1.00
MLF Adj:	1.00	1.00	1.00	1.00	1.00	1.00	1.00	1.00	1.00	1.00	1.00	1.00
FinalVolume:	876	3814	401	550	1460	947	329	402	230	307	1760	1394
OvlAdjVol:			247			783						1119

Saturation Flow Module:

Sat/Lane:	1600	1600	1600	1600	1600	1600	1600	1600	1600	1600	1600	1600
Adjustment:	1.00	1.06	1.00	1.00	1.06	1.00	1.00	1.05	1.00	1.00	1.06	1.00
Lanes:	2.00	3.00	1.00	2.00	3.00	1.00	2.00	1.27	0.73	2.00	2.00	1.00
Final Sat.:	3200	5100	1600	3200	5100	1600	3200	2135	1165	3200	3400	1600

Capacity Analysis Module:

Vol/Sat:	0.27	0.75	0.25	0.17	0.29	0.59	0.10	0.19	0.20	0.10	0.52	0.87
OvlAdjV/S:			0.15			0.49						0.70
Crit Moves:	****			****			****			****		

Santa Ana Circulation Element

Level Of Service Computation Report

2000 HCM Operations Method (Base Volume Alternative)

 Intersection #114 SR-55 SB Ramps and Irvine Boulevard

Cycle (sec): 100 Critical Vol./Cap.(X): 0.929
 Loss Time (sec): 5 Average Delay (sec/veh): 26.5
 Optimal Cycle: 111 Level Of Service: C

Street Name:	SR-55 SB Ramps						Irvine Boulevard					
	North Bound			South Bound			East Bound			West Bound		
Approach:	North Bound			South Bound			East Bound			West Bound		
Movement:	L	T	R	L	T	R	L	T	R	L	T	R
Control:	Protected			Permitted			Protected			Protected		
Rights:	Include			Include			Include			Include		
Min. Green:	0	0	0	0	0	0	0	0	0	0	0	0
Y+R:	4.0	4.0	4.0	4.0	4.0	4.0	4.0	4.0	4.0	4.0	4.0	4.0
Lanes:	0	0	0	1	0	1	0	0	2	1	0	3

Volume Module:	SR-55 SB Ramps			SR-55 SB Ramps			Irvine Boulevard			Irvine Boulevard		
Base Vol:	0	0	0	484	0	289	0	1049	707	425	1222	0
Growth Adj:	1.00	1.00	1.00	1.00	1.00	1.00	1.00	1.00	1.00	1.00	1.00	1.00
Initial Bse:	0	0	0	484	0	289	0	1049	707	425	1222	0
User Adj:	1.00	1.00	1.00	1.00	1.00	1.00	1.00	1.00	1.00	1.00	1.00	1.00
PHF Adj:	1.00	1.00	1.00	1.00	1.00	1.00	1.00	1.00	1.00	1.00	1.00	1.00
PHF Volume:	0	0	0	484	0	289	0	1049	707	425	1222	0
Reduct Vol:	0	0	0	0	0	0	0	0	0	0	0	0
Reduced Vol:	0	0	0	484	0	289	0	1049	707	425	1222	0
PCE Adj:	1.00	1.00	1.00	1.00	1.00	1.00	1.00	1.00	1.00	1.00	1.00	1.00
MLF Adj:	1.00	1.00	1.00	1.00	1.00	1.00	1.00	1.00	1.00	1.00	1.00	1.00
FinalVolume:	0	0	0	484	0	289	0	1049	707	425	1222	0

Saturation Flow Module:	SR-55 SB Ramps			SR-55 SB Ramps			Irvine Boulevard			Irvine Boulevard		
Sat/Lane:	1900	1900	1900	1900	1900	1900	1900	1900	1900	1900	1900	1900
Adjustment:	1.00	1.00	1.00	0.74	1.00	0.73	1.00	0.86	0.86	0.95	0.91	1.00
Lanes:	0.00	0.00	0.00	1.62	0.00	1.38	0.00	2.00	1.00	1.00	3.00	0.00
Final Sat.:	0	0	0	2278	0	1915	0	3251	1625	1805	5187	0

Capacity Analysis Module:	SR-55 SB Ramps			SR-55 SB Ramps			Irvine Boulevard			Irvine Boulevard		
Vol/Sat:	0.00	0.00	0.00	0.21	0.00	0.15	0.00	0.32	0.44	0.24	0.24	0.00
Crit Moves:				****					****	****		
Green/Cycle:	0.00	0.00	0.00	0.23	0.00	0.46	0.00	0.47	0.47	0.25	0.72	0.00
Volume/Cap:	0.00	0.00	0.00	0.93	0.00	0.33	0.00	0.69	0.93	0.93	0.33	0.00
Delay/Veh:	0.0	0.0	0.0	54.5	0.0	17.5	0.0	21.7	33.7	61.9	5.1	0.0
User DelAdj:	1.00	1.00	1.00	1.00	1.00	1.00	1.00	1.00	1.00	1.00	1.00	1.00
AdjDel/Veh:	0.0	0.0	0.0	54.5	0.0	17.5	0.0	21.7	33.7	61.9	5.1	0.0
LOS by Move:	A	A	A	D	A	B	A	C	C	E	A	A

HCM2k85thQ: 0 0 0 19 0 7 0 22 39 25 8 0

Note: Queue reported is the number of cars per lane.

Santa Ana Circulation Element

Level of Service Computation Report

2000 HCM Operations Method (Base Volume Alternative)

 Intersection #115 SR-55 NB Ramps and Irvine Boulevard

Cycle (sec): 100 Critical Vol./Cap.(X): 0.841
 Loss Time (sec): 5 Average Delay (sec/veh): 22.3
 Optimal Cycle: 65 Level Of Service: C

Street Name:	SR-55 NB Ramps						Irvine Boulevard					
Approach:	North Bound			South Bound			East Bound			West Bound		
Movement:	L	T	R	L	T	R	L	T	R	L	T	R
Control:	Permitted			Protected			Protected			Protected		
Rights:	Include			Include			Include			Include		
Min. Green:	0	0	0	0	0	0	0	0	0	0	0	0
Y+R:	4.0	4.0	4.0	4.0	4.0	4.0	4.0	4.0	4.0	4.0	4.0	4.0
Lanes:	1	0	1	0	0	0	1	0	3	0	0	2

Volume Module:

Base Vol:	424	21	386	0	0	0	239	1094	0	0	1043	660
Growth Adj:	1.00	1.00	1.00	1.00	1.00	1.00	1.00	1.00	1.00	1.00	1.00	1.00
Initial Bse:	424	21	386	0	0	0	239	1094	0	0	1043	660
User Adj:	1.00	1.00	1.00	1.00	1.00	1.00	1.00	1.00	1.00	1.00	1.00	1.00
PHF Adj:	1.00	1.00	1.00	1.00	1.00	1.00	1.00	1.00	1.00	1.00	1.00	1.00
PHF Volume:	424	21	386	0	0	0	239	1094	0	0	1043	660
Reduct Vol:	0	0	0	0	0	0	0	0	0	0	0	0
Reduced Vol:	424	21	386	0	0	0	239	1094	0	0	1043	660
PCE Adj:	1.00	1.00	1.00	1.00	1.00	1.00	1.00	1.00	1.00	1.00	1.00	1.00
MLF Adj:	1.00	1.00	1.00	1.00	1.00	1.00	1.00	1.00	1.00	1.00	1.00	1.00
FinalVolume:	424	21	386	0	0	0	239	1094	0	0	1043	660

Saturation Flow Module:

Sat/Lane:	1900	1900	1900	1900	1900	1900	1900	1900	1900	1900	1900	1900
Adjustment:	0.86	0.86	0.86	1.00	1.00	1.00	0.95	0.91	1.00	1.00	0.86	0.86
Lanes:	1.50	0.05	1.45	0.00	0.00	0.00	1.00	3.00	0.00	0.00	2.00	1.00
Final Sat.:	2445	80	2372	0	0	0	1805	5187	0	0	3257	1629

Capacity Analysis Module:

Vol/Sat:	0.17	0.26	0.16	0.00	0.00	0.00	0.13	0.21	0.00	0.00	0.32	0.41
Crit Moves:	****						****			****		
Green/Cycle:	0.31	0.31	0.31	0.00	0.00	0.00	0.16	0.64	0.00	0.00	0.48	0.48
Volume/Cap:	0.56	0.84	0.52	0.00	0.00	0.00	0.84	0.33	0.00	0.00	0.66	0.84
Delay/Veh:	29.2	38.7	28.7	0.0	0.0	0.0	60.5	8.3	0.0	0.0	20.4	25.9
User DelAdj:	1.00	1.00	1.00	1.00	1.00	1.00	1.00	1.00	1.00	1.00	1.00	1.00
AdjDel/Veh:	29.2	38.7	28.7	0.0	0.0	0.0	60.5	8.3	0.0	0.0	20.4	25.9
LOS by Move:	C	D	C	A	A	A	E	A	A	A	C	C
HCM2k85thQ:	12	22	11	0	0	0	15	9	0	0	21	31

Note: Queue reported is the number of cars per lane.

APPENDIX E

MITIGATION WORKSHEETS

Santa Ana Circulation Element

Level Of Service Computation Report

ICU 1(Loss as Cycle Length %) Method (Future Volume Alternative)

Intersection #3 Euclid St and Edinger Ave

Cycle (sec): 100 Critical Vol./Cap.(X): 0.995
Loss Time (sec): 5 Average Delay (sec/veh): xxxxxx
Optimal Cycle: 180 Level Of Service: E

Table with 4 columns: North Bound, South Bound, East Bound, West Bound. Rows include Movement (L-T-R), Control, Rights, Min. Green, Y+R, and Lanes.

Volume Module table with 12 columns representing different traffic movements and 13 rows of volume-related metrics like Base Vol, Growth Adj, etc.

Saturation Flow Module table with 12 columns and 5 rows showing Sat/Lane, Adjustment, Lanes, and Final Sat.

Capacity Analysis Module table with 12 columns and 3 rows showing Vol/Sat, Crit Moves, and other capacity metrics.

Santa Ana Circulation Element

Level Of Service Computation Report

ICU 1(Loss as Cycle Length %) Method (Future Volume Alternative)

Intersection #3 Euclid St and Edinger Ave

Cycle (sec): 100 Critical Vol./Cap.(X): 0.803
Loss Time (sec): 5 Average Delay (sec/veh): xxxxxx
Optimal Cycle: 53 Level Of Service: D

Table with 4 columns: North Bound, South Bound, East Bound, West Bound. Rows include Movement (L-T-R), Control, Rights, Min. Green, Y+R, and Lanes.

Volume Module table with 12 columns representing different volume categories and 12 rows of adjustment factors like Growth Adj, PHF Adj, etc.

Saturation Flow Module table with 12 columns for saturation flow and 4 rows for Sat/Lane, Adjustment, Lanes, and Final Sat.

Capacity Analysis Module table with 12 columns for capacity analysis and 3 rows for Vol/Sat, Crit Moves, and a summary row.

Santa Ana Circulation Element

Level Of Service Computation Report

ICU 1(Loss as Cycle Length %) Method (Future Volume Alternative)

Intersection #3 Euclid St and Edinger Ave

Cycle (sec): 100 Critical Vol./Cap.(X): 0.995
Loss Time (sec): 5 Average Delay (sec/veh): xxxxxx
Optimal Cycle: 180 Level Of Service: E

Table with 4 columns: North Bound, South Bound, East Bound, West Bound. Rows include Movement, Control, Rights, Min. Green, Y+R, and Lanes.

Volume Module table with 12 columns representing different traffic movements and 13 rows of volume-related metrics.

Saturation Flow Module table with 12 columns and 5 rows of saturation flow data.

Capacity Analysis Module table with 12 columns and 3 rows of capacity analysis data.

Santa Ana Circulation Element

Level Of Service Computation Report

ICU 1(Loss as Cycle Length %) Method (Future Volume Alternative)

Intersection #3 Euclid St and Edinger Ave

Cycle (sec): 100 Critical Vol./Cap.(X): 0.822
Loss Time (sec): 5 Average Delay (sec/veh): xxxxxxx
Optimal Cycle: 57 Level Of Service: D

Table with 4 columns: North Bound, South Bound, East Bound, West Bound. Rows include Movement, Control, Rights, Min. Green, Y+R, and Lanes.

Volume Module: Table with 12 columns representing different volume categories and 12 rows of adjustment factors.

Saturation Flow Module: Table with 12 columns representing saturation flow and 4 rows of adjustment factors.

Capacity Analysis Module: Table with 12 columns representing capacity analysis and 2 rows of data.

Santa Ana Circulation Element

Level Of Service Computation Report

ICU 1(Loss as Cycle Length %) Method (Future Volume Alternative)

Intersection #3 Euclid St and Edinger Ave

Cycle (sec): 100 Critical Vol./Cap.(X): 0.965
 Loss Time (sec): 5 Average Delay (sec/veh): xxxxxx
 Optimal Cycle: 154 Level Of Service: E

Approach:	North Bound			South Bound			East Bound			West Bound		
Movement:	L	T	R	L	T	R	L	T	R	L	T	R
Control:	Protected			Protected			Protected			Protected		
Rights:	Include			Include			Include			Include		
Min. Green:	0	0	0	0	0	0	0	0	0	0	0	0
Y+R:	4.0	4.0	4.0	4.0	4.0	4.0	4.0	4.0	4.0	4.0	4.0	4.0
Lanes:	2	0	2	1	0	0	2	0	2	0	1	0

Volume Module:

Base Vol:	127	801	68	180	2613	240	136	595	364	133	812	148
Growth Adj:	1.00	1.00	1.00	1.00	1.00	1.00	1.00	1.00	1.00	1.00	1.00	1.00
Initial Bse:	127	801	68	180	2613	240	136	595	364	133	812	148
Added Vol:	0	0	0	0	0	0	0	0	0	0	0	0
PasserByVol:	0	0	0	0	0	0	0	0	0	0	0	0
Initial Fut:	127	801	68	180	2613	240	136	595	364	133	812	148
User Adj:	1.00	1.00	1.00	1.00	1.00	1.00	1.00	1.00	1.00	1.00	1.00	1.00
PHF Adj:	1.00	1.00	1.00	1.00	1.00	1.00	1.00	1.00	1.00	1.00	1.00	1.00
PHF Volume:	127	801	68	180	2613	240	136	595	364	133	812	148
Reduct Vol:	0	0	0	0	0	0	0	0	0	0	0	0
Reduced Vol:	127	801	68	180	2613	240	136	595	364	133	812	148
PCE Adj:	1.00	1.00	1.00	1.00	1.00	1.00	1.00	1.00	1.00	1.00	1.00	1.00
MLF Adj:	1.00	1.00	1.00	1.00	1.00	1.00	1.00	1.00	1.00	1.00	1.00	1.00
FinalVolume:	127	801	68	180	2613	240	136	595	364	133	812	148

Saturation Flow Module:

Sat/Lane:	1600	1600	1600	1600	1600	1600	1600	1600	1600	1600	1600	1600
Adjustment:	1.00	1.05	1.00	1.00	1.05	1.00	1.00	1.06	1.00	1.00	1.06	1.00
Lanes:	2.00	2.77	0.23	2.00	2.75	0.25	2.00	2.00	1.00	2.00	2.00	1.00
Final Sat.:	3200	4624	376	3200	4596	404	3200	3400	1600	3200	3400	1600

Capacity Analysis Module:

Vol/Sat:	0.04	0.17	0.18	0.06	0.57	0.59	0.04	0.17	0.23	0.04	0.24	0.09
Crit Moves:	****					****	****				****	

Santa Ana Circulation Element

Level Of Service Computation Report

ICU 1(Loss as Cycle Length %) Method (Future Volume Alternative)

Intersection #3 Euclid St and Edinger Ave

Cycle (sec): 100 Critical Vol./Cap.(X): 0.822
Loss Time (sec): 5 Average Delay (sec/veh): xxxxxx
Optimal Cycle: 57 Level Of Service: D

Table with 4 columns: North Bound, South Bound, East Bound, West Bound. Rows include Movement (L-T-R), Control, Rights, Min. Green, Y+R, and Lanes.

Volume Module table with 12 columns representing traffic volumes and 12 rows for various adjustment factors like Growth Adj, PHF Volume, etc.

Saturation Flow Module table with 12 columns for saturation flow and 4 rows for Sat/Lane, Adjustment, Lanes, and Final Sat.

Capacity Analysis Module table with 12 columns for capacity analysis and 2 rows for Vol/Sat and Crit Moves.

Santa Ana Circulation Element

Level Of Service Computation Report

ICU 1(Loss as Cycle Length %) Method (Base Volume Alternative)

Intersection #13 Harbor Blvd and Segerstrom Ave

Cycle (sec): 100 Critical Vol./Cap.(X): 0.961
 Loss Time (sec): 5 Average Delay (sec/veh): xxxxxx
 Optimal Cycle: 147 Level Of Service: E

Approach:	North Bound			South Bound			East Bound			West Bound		
Movement:	L	T	R	L	T	R	L	T	R	L	T	R
Control:	Protected			Protected			Protected			Protected		
Rights:	Include			Include			Include			Include		
Min. Green:	0	0	0	0	0	0	0	0	0	0	0	0
Y+R:	4.0	4.0	4.0	4.0	4.0	4.0	4.0	4.0	4.0	4.0	4.0	4.0
Lanes:	2	0	2	1	0	2	1	0	1	2	0	2

Volume Module:

Base Vol:	107	759	48	173	2324	87	90	753	303	146	453	103
Growth Adj:	1.00	1.00	1.00	1.00	1.00	1.00	1.00	1.00	1.00	1.00	1.00	1.00
Initial Bse:	107	759	48	173	2324	87	90	753	303	146	453	103
User Adj:	1.00	1.00	1.00	1.00	1.00	1.00	1.00	1.00	1.00	1.00	1.00	1.00
PHF Adj:	1.00	1.00	1.00	1.00	1.00	1.00	1.00	1.00	1.00	1.00	1.00	1.00
PHF Volume:	107	759	48	173	2324	87	90	753	303	146	453	103
Reduct Vol:	0	0	0	0	0	0	0	0	0	0	0	0
Reduced Vol:	107	759	48	173	2324	87	90	753	303	146	453	103
PCE Adj:	1.00	1.00	1.00	1.00	1.00	1.00	1.00	1.00	1.00	1.00	1.00	1.00
MLF Adj:	1.00	1.00	1.00	1.00	1.00	1.00	1.00	1.00	1.00	1.00	1.00	1.00
FinalVolume:	107	759	48	173	2324	87	90	753	303	146	453	103

Saturation Flow Module:

Sat/Lane:	1600	1600	1600	1600	1600	1600	1600	1600	1600	1600	1600	1600
Adjustment:	1.00	1.04	1.00	1.00	1.04	1.00	1.00	1.04	1.00	1.00	1.06	1.00
Lanes:	2.00	2.82	0.18	1.00	2.89	0.11	1.00	1.43	0.57	2.00	2.00	1.00
Final Sat.:	3200	4714	286	1600	4827	173	1600	2382	918	3200	3400	1600

Capacity Analysis Module:

Vol/Sat:	0.03	0.16	0.17	0.11	0.48	0.50	0.06	0.32	0.33	0.05	0.13	0.06
Crit Moves:	****					****			****	****		

Santa Ana Circulation Element

Level Of Service Computation Report

ICU 1(Loss as Cycle Length %) Method (Base Volume Alternative)

Intersection #13 Harbor Blvd and Segerstrom Ave

Cycle (sec): 100 Critical Vol./Cap.(X): 0.934
Loss Time (sec): 5 Average Delay (sec/veh): xxxxxx
Optimal Cycle: 113 Level Of Service: E

Table with 4 columns: North Bound, South Bound, East Bound, West Bound. Rows include Movement, Control, Rights, Min. Green, Y+R, and Lanes.

Volume Module: Table with 12 columns representing different volume categories and their values.

Saturation Flow Module: Table with 12 columns representing saturation flow values for various lanes.

Capacity Analysis Module: Table with 12 columns representing capacity analysis values.

Santa Ana Circulation Element

Level Of Service Computation Report

ICU 1(Loss as Cycle Length %) Method (Base Volume Alternative)

Intersection #34 Bristol St and 1st St

Cycle (sec): 100 Critical Vol./Cap.(X): 0.788
Loss Time (sec): 5 Average Delay (sec/veh): xxxxxx
Optimal Cycle: 50 Level Of Service: C

Table with columns: Approach (North Bound, South Bound, East Bound, West Bound), Movement (L, T, R), Control, Rights, Min. Green, Y+R, Lanes.

Volume Module table with columns: Base Vol, Growth Adj, Initial Bse, User Adj, PHF Adj, PHF Volume, Reduct Vol, Reduced Vol, PCE Adj, MLF Adj, Final Volume.

Saturation Flow Module table with columns: Sat/Lane, Adjustment, Lanes, Final Sat.

Capacity Analysis Module table with columns: Vol/Sat, Crit Moves.

Santa Ana Circulation Element

Level Of Service Computation Report

ICU 1(Loss as Cycle Length %) Method (Base Volume Alternative)

Intersection #34 Bristol St and 1st St

Cycle (sec): 100 Critical Vol./Cap.(X): 0.867
 Loss Time (sec): 5 Average Delay (sec/veh): xxxxxx
 Optimal Cycle: 71 Level Of Service: D

Approach:	North Bound			South Bound			East Bound			West Bound													
Movement:	L	T	R	L	T	R	L	T	R	L	T	R											
Control:	Protected			Protected			Protected			Protected													
Rights:	Include			Include			Include			Include													
Min. Green:	0	0	0	0	0	0	0	0	0	0	0	0											
Y+R:	4.0	4.0	4.0	4.0	4.0	4.0	4.0	4.0	4.0	4.0	4.0	4.0											
Lanes:	2	0	3	0	1		2	0	3	0	1		1	0	2	1	1		1	0	2	1	0

Volume Module:

Base Vol:	434	1872	276	216	1169	264	259	1454	186	155	953	90
Growth Adj:	1.00	1.00	1.00	1.00	1.00	1.00	1.00	1.00	1.00	1.00	1.00	1.00
Initial Bse:	434	1872	276	216	1169	264	259	1454	186	155	953	90
User Adj:	1.00	1.00	1.00	1.00	1.00	1.00	1.00	1.00	1.00	1.00	1.00	1.00
PHF Adj:	1.00	1.00	1.00	1.00	1.00	1.00	1.00	1.00	1.00	1.00	1.00	1.00
PHF Volume:	434	1872	276	216	1169	264	259	1454	186	155	953	90
Reduct Vol:	0	0	0	0	0	0	0	0	0	0	0	0
Reduced Vol:	434	1872	276	216	1169	264	259	1454	186	155	953	90
PCE Adj:	1.00	1.00	1.00	1.00	1.00	1.00	1.00	1.00	1.00	1.00	1.00	1.00
MLF Adj:	1.00	1.00	1.00	1.00	1.00	1.00	1.00	1.00	1.00	1.00	1.00	1.00
FinalVolume:	434	1872	276	216	1169	264	259	1454	186	155	953	90

Saturation Flow Module:

Sat/Lane:	1600	1600	1600	1600	1600	1600	1600	1600	1600	1600	1600	1600
Adjustment:	1.00	1.06	1.00	1.00	1.06	1.00	1.00	1.06	1.00	1.00	1.05	1.00
Lanes:	2.00	3.00	1.00	2.00	3.00	1.00	1.00	3.00	1.00	1.00	2.74	0.26
Final Sat.:	3200	5100	1600	3200	5100	1600	1600	5100	1600	1600	4586	414

Capacity Analysis Module:

Vol/Sat:	0.14	0.37	0.17	0.07	0.23	0.17	0.16	0.29	0.12	0.10	0.21	0.22
Crit Moves:	****			****			****			****		

Santa Ana Circulation Element

Level Of Service Computation Report

ICU 1(Loss as Cycle Length %) Method (Base Volume Alternative)

Intersection #37 Bristol St and Segerstrom Ave

Cycle (sec): 100 Critical Vol./Cap.(X): 0.814
 Loss Time (sec): 5 Average Delay (sec/veh): xxxxxx
 Optimal Cycle: 55 Level Of Service: D

Approach:	North Bound			South Bound			East Bound			West Bound		
Movement:	L	T	R	L	T	R	L	T	R	L	T	R
Control:	Protected			Protected			Protected			Protected		
Rights:	WideBypass			Include			Include			Include		
Min. Green:	0	0	0	0	0	0	0	0	0	0	0	0
Y+R:	4.0	4.0	4.0	4.0	4.0	4.0	4.0	4.0	4.0	4.0	4.0	4.0
Lanes:	1	0	2	1	0	2	1	0	2	1	0	2

Volume Module:

Base Vol:	70	778	146	283	1011	119	306	1480	136	157	712	91
Growth Adj:	1.00	1.00	1.00	1.00	1.00	1.00	1.00	1.00	1.00	1.00	1.00	1.00
Initial Bse:	70	778	146	283	1011	119	306	1480	136	157	712	91
User Adj:	1.00	1.00	1.00	1.00	1.00	1.00	1.00	1.00	1.00	1.00	1.00	1.00
PHF Adj:	1.00	1.00	1.00	1.00	1.00	1.00	1.00	1.00	1.00	1.00	1.00	1.00
PHF Volume:	70	778	146	283	1011	119	306	1480	136	157	712	91
Reduct Vol:	0	0	0	0	0	0	0	0	0	0	0	0
Reduced Vol:	70	778	146	283	1011	119	306	1480	136	157	712	91
PCE Adj:	1.00	1.00	1.00	1.00	1.00	1.00	1.00	1.00	1.00	1.00	1.00	1.00
MLF Adj:	1.00	1.00	1.00	1.00	1.00	1.00	1.00	1.00	1.00	1.00	1.00	1.00
FinalVolume:	70	778	146	283	1011	119	306	1480	136	157	712	91

Saturation Flow Module:

Sat/Lane:	1600	1600	1600	1600	1600	1600	1600	1600	1600	1600	1600	1600
Adjustment:	1.00	1.06	1.00	1.00	1.05	1.00	1.00	1.05	1.00	1.00	1.05	1.00
Lanes:	1.00	3.00	1.00	1.00	2.68	0.32	1.00	2.75	0.25	1.00	2.66	0.34
Final Sat.:	1600	5100	1600	1600	4495	505	1600	4596	404	1600	4456	544

Capacity Analysis Module:

Vol/Sat:	0.04	0.15	0.09	0.18	0.22	0.24	0.19	0.32	0.34	0.10	0.16	0.17
Crit Moves:	****			****			****			****		

Santa Ana Circulation Element

Level Of Service Computation Report

ICU 1(Loss as Cycle Length %) Method (Base Volume Alternative)

Intersection #37 Bristol St and Segerstrom Ave

Cycle (sec): 100 Critical Vol./Cap.(X): 0.868
Loss Time (sec): 5 Average Delay (sec/veh): xxxxxx
Optimal Cycle: 72 Level Of Service: D

Table with 4 columns: North Bound, South Bound, East Bound, West Bound. Rows include Movement (L-T-R), Control, Rights, Min. Green, Y+R, and Lanes.

Volume Module: Table with 12 columns representing different volume categories and 12 rows of adjustment factors like Growth Adj, User Adj, PHF Adj, etc.

Saturation Flow Module: Table with 12 columns and 4 rows showing Sat/Lane, Adjustment, Lanes, and Final Sat.

Capacity Analysis Module: Table with 12 columns and 2 rows showing Vol/Sat and Crit Moves.

Santa Ana Circulation Element

Level Of Service Computation Report

ICU 1(Loss as Cycle Length %) Method (Future Volume Alternative)

Intersection #44 Flower St and 1st St

Cycle (sec): 100 Critical Vol./Cap.(X): 0.925
Loss Time (sec): 5 Average Delay (sec/veh): xxxxxx
Optimal Cycle: 104 Level Of Service: E

Table with 4 columns: North Bound, South Bound, East Bound, West Bound. Rows include Movement, Control, Rights, Min. Green, Y+R, and Lanes.

Volume Module: Table with 12 columns representing different traffic movements and 13 rows of volume-related metrics like Base Vol, Growth Adj, etc.

Saturation Flow Module: Table with 12 columns and 5 rows showing saturation flow rates and adjustment factors.

Capacity Analysis Module: Table with 12 columns and 3 rows showing capacity analysis metrics like Vol/Sat and Crit Moves.

Santa Ana Circulation Element

Level Of Service Computation Report

ICU 1(Loss as Cycle Length %) Method (Future Volume Alternative)

Intersection #44 Flower St and 1st St

Cycle (sec): 100 Critical Vol./Cap.(X): 0.921
Loss Time (sec): 5 Average Delay (sec/veh): xxxxxx
Optimal Cycle: 101 Level Of Service: E

Table with 4 columns: North Bound, South Bound, East Bound, West Bound. Rows include Movement (L-T-R), Control, Rights, Min. Green, Y+R, and Lanes.

Volume Module table with 12 columns representing different traffic flows and 12 rows of volume-related metrics like Base Vol, Growth Adj, etc.

Saturation Flow Module table with 12 columns and 5 rows of saturation flow data.

Capacity Analysis Module table with 12 columns and 3 rows of capacity analysis data.

Santa Ana Circulation Element

Level Of Service Computation Report

ICU 1(Loss as Cycle Length %) Method (Base Volume Alternative)

Intersection #62 Santiago St and Santa Ana Blvd

Cycle (sec): 100 Critical Vol./Cap.(X): 1.241
Loss Time (sec): 5 Average Delay (sec/veh): xxxxxx
Optimal Cycle: 180 Level Of Service: F

Table with 4 columns: North Bound, South Bound, East Bound, West Bound. Rows include Movement, Control, Rights, Min. Green, Y+R, and Lanes.

Volume Module: Table with 12 columns representing different volume categories and their values.

Saturation Flow Module: Table with 12 columns representing saturation flow values.

Capacity Analysis Module: Table with 12 columns representing capacity analysis values.

Santa Ana Circulation Element

Level Of Service Computation Report

ICU 1(Loss as Cycle Length %) Method (Base Volume Alternative)

Intersection #62 Santiago St and Santa Ana Blvd

Cycle (sec): 100 Critical Vol./Cap.(X): 1.282
 Loss Time (sec): 5 Average Delay (sec/veh): xxxxxx
 Optimal Cycle: 180 Level Of Service: F

Approach:	North Bound			South Bound			East Bound			West Bound		
Movement:	L	T	R	L	T	R	L	T	R	L	T	R
Control:	Protected			Protected			Split Phase			Split Phase		
Rights:	Include			Include			Include			Include		
Min. Green:	0	0	0	0	0	0	0	0	0	0	0	0
Y+R:	4.0	4.0	4.0	4.0	4.0	4.0	4.0	4.0	4.0	4.0	4.0	4.0
Lanes:	1	0	1	0	1	0	1	0	1	0	1	0

Volume Module:

Base Vol:	135	833	236	378	639	103	164	673	87	255	546	347
Growth Adj:	1.00	1.00	1.00	1.00	1.00	1.00	1.00	1.00	1.00	1.00	1.00	1.00
Initial Bse:	135	833	236	378	639	103	164	673	87	255	546	347
User Adj:	1.00	1.00	1.00	1.00	1.00	1.00	1.00	1.00	1.00	1.00	1.00	1.00
PHF Adj:	1.00	1.00	1.00	1.00	1.00	1.00	1.00	1.00	1.00	1.00	1.00	1.00
PHF Volume:	135	833	236	378	639	103	164	673	87	255	546	347
Reduct Vol:	0	0	0	0	0	0	0	0	0	0	0	0
Reduced Vol:	135	833	236	378	639	103	164	673	87	255	546	347
PCE Adj:	1.00	1.00	1.00	1.00	1.00	1.00	1.00	1.00	1.00	1.00	1.00	1.00
MLF Adj:	1.00	1.00	1.00	1.00	1.00	1.00	1.00	1.00	1.00	1.00	1.00	1.00
FinalVolume:	135	833	236	378	639	103	164	673	87	255	546	347

Saturation Flow Module:

Sat/Lane:	1600	1600	1600	1600	1600	1600	1600	1600	1600	1600	1600	1600
Adjustment:	1.00	1.06	1.00	1.00	1.06	1.00	1.00	1.00	1.00	1.00	1.06	1.00
Lanes:	1.00	1.00	1.00	1.00	1.00	1.00	0.35	1.46	0.19	1.00	2.00	1.00
Final Sat.:	1600	1700	1600	1600	1700	1600	568	2331	301	1600	3400	1600

Capacity Analysis Module:

Vol/Sat:	0.08	0.49	0.15	0.24	0.38	0.06	0.29	0.29	0.29	0.16	0.16	0.22
Crit Moves:	****			****			****			****		

Santa Ana Circulation Element

Level Of Service Computation Report

ICU 1(Loss as Cycle Length %) Method (Future Volume Alternative)

Intersection #63 Standard Ave and 4th St

Cycle (sec): 100 Critical Vol./Cap.(X): 1.062
Loss Time (sec): 5 Average Delay (sec/veh): xxxxxx
Optimal Cycle: 180 Level Of Service: F

Table with 4 columns: North Bound, South Bound, East Bound, West Bound. Rows include Movement (L-T-R), Control, Rights, Min. Green, Y+R, and Lanes.

Volume Module: Table with 13 columns representing different volume metrics (Base Vol, Growth Adj, Initial Bse, Added Vol, PasserByVol, Initial Fut, User Adj, PHF Adj, PHF Volume, Reduct Vol, Reduced Vol, PCE Adj, MLF Adj, FinalVolume).

Saturation Flow Module: Table with 13 columns representing saturation flow metrics (Sat/Lane, Adjustment, Lanes, Final Sat.).

Capacity Analysis Module: Table with 13 columns representing capacity analysis metrics (Vol/Sat, Crit Moves).

Santa Ana Circulation Element

Level Of Service Computation Report

ICU 1(Loss as Cycle Length %) Method (Future Volume Alternative)

Intersection #63 Standard Ave and 4th St

Cycle (sec): 100 Critical Vol./Cap.(X): 1.029
 Loss Time (sec): 5 Average Delay (sec/veh): xxxxxx
 Optimal Cycle: 180 Level Of Service: F

Approach:	North Bound			South Bound			East Bound			West Bound		
Movement:	L	T	R	L	T	R	L	T	R	L	T	R
Control:	Protected			Protected			Protected			Protected		
Rights:	Include			Include			Include			Include		
Min. Green:	0	0	0	0	0	0	0	0	0	0	0	0
Y+R:	4.0	4.0	4.0	4.0	4.0	4.0	4.0	4.0	4.0	4.0	4.0	4.0
Lanes:	1	0	1	0	1	0	1	1	0	1	1	0

Volume Module:

Base Vol:	251	543	214	254	428	297	302	477	201	233	648	351
Growth Adj:	1.00	1.00	1.00	1.00	1.00	1.00	1.00	1.00	1.00	1.00	1.00	1.00
Initial Bse:	251	543	214	254	428	297	302	477	201	233	648	351
Added Vol:	0	0	0	0	0	0	0	0	0	0	0	0
PasserByVol:	0	0	0	0	0	0	0	0	0	0	0	0
Initial Fut:	251	543	214	254	428	297	302	477	201	233	648	351
User Adj:	1.00	1.00	1.00	1.00	1.00	1.00	1.00	1.00	1.00	1.00	1.00	1.00
PHF Adj:	1.00	1.00	1.00	1.00	1.00	1.00	1.00	1.00	1.00	1.00	1.00	1.00
PHF Volume:	251	543	214	254	428	297	302	477	201	233	648	351
Reduct Vol:	0	0	0	0	0	0	0	0	0	0	0	0
Reduced Vol:	251	543	214	254	428	297	302	477	201	233	648	351
PCE Adj:	1.00	1.00	1.00	1.00	1.00	1.00	1.00	1.00	1.00	1.00	1.00	1.00
MLF Adj:	1.00	1.00	1.00	1.00	1.00	1.00	1.00	1.00	1.00	1.00	1.00	1.00
FinalVolume:	251	543	214	254	428	297	302	477	201	233	648	351

Saturation Flow Module:

Sat/Lane:	1600	1600	1600	1600	1600	1600	1600	1600	1600	1600	1600	1600
Adjustment:	1.00	1.06	1.00	1.00	1.06	1.00	1.00	1.04	1.00	1.00	1.05	1.00
Lanes:	1.00	1.00	1.00	1.00	1.00	1.00	1.00	1.41	0.59	1.00	1.30	0.70
Final Sat.:	1600	1700	1600	1600	1700	1600	1600	2351	949	1600	2176	1124

Capacity Analysis Module:

Vol/Sat:	0.16	0.32	0.13	0.16	0.25	0.19	0.19	0.20	0.21	0.15	0.30	0.31
Crit Moves:	****			****			****			****		

Santa Ana Circulation Element

Level Of Service Computation Report

ICU 1(Loss as Cycle Length %) Method (Base Volume Alternative)

Intersection #81 Grand Ave and McFadden Ave

Cycle (sec): 100 Critical Vol./Cap.(X): 0.861
 Loss Time (sec): 5 Average Delay (sec/veh): xxxxxx
 Optimal Cycle: 69 Level Of Service: D

Approach:	North Bound			South Bound			East Bound			West Bound		
Movement:	L	T	R	L	T	R	L	T	R	L	T	R
Control:	Protected			Protected			Protected			Protected		
Rights:	Include			Include			Include			Include		
Min. Green:	0	0	0	0	0	0	0	0	0	0	0	0
Y+R:	4.0	4.0	4.0	4.0	4.0	4.0	4.0	4.0	4.0	4.0	4.0	4.0
Lanes:	1	0	2	1	0	2	1	0	1	1	0	1

Volume Module:

Base Vol:	262	1104	165	294	1974	192	109	352	107	95	340	86
Growth Adj:	1.00	1.00	1.00	1.00	1.00	1.00	1.00	1.00	1.00	1.00	1.00	1.00
Initial Bse:	262	1104	165	294	1974	192	109	352	107	95	340	86
User Adj:	1.00	1.00	1.00	1.00	1.00	1.00	1.00	1.00	1.00	1.00	1.00	1.00
PHF Adj:	1.00	1.00	1.00	1.00	1.00	1.00	1.00	1.00	1.00	1.00	1.00	1.00
PHF Volume:	262	1104	165	294	1974	192	109	352	107	95	340	86
Reduct Vol:	0	0	0	0	0	0	0	0	0	0	0	0
Reduced Vol:	262	1104	165	294	1974	192	109	352	107	95	340	86
PCE Adj:	1.00	1.00	1.00	1.00	1.00	1.00	1.00	1.00	1.00	1.00	1.00	1.00
MLF Adj:	1.00	1.00	1.00	1.00	1.00	1.00	1.00	1.00	1.00	1.00	1.00	1.00
FinalVolume:	262	1104	165	294	1974	192	109	352	107	95	340	86

Saturation Flow Module:

Sat/Lane:	1600	1600	1600	1600	1600	1600	1600	1600	1600	1600	1600	1600
Adjustment:	1.00	1.05	1.00	1.00	1.05	1.00	1.00	1.04	1.00	1.00	1.04	1.00
Lanes:	1.00	2.61	0.39	1.00	2.73	0.27	1.00	1.53	0.47	1.00	1.60	0.40
Final Sat.:	1600	4376	624	1600	4575	425	1600	2554	746	1600	2654	646

Capacity Analysis Module:

Vol/Sat:	0.16	0.25	0.26	0.18	0.43	0.45	0.07	0.14	0.14	0.06	0.13	0.13
Crit Moves:	****					****	****				****	

Santa Ana Circulation Element

Level Of Service Computation Report

ICU 1(Loss as Cycle Length %) Method (Base Volume Alternative)

Intersection #81 Grand Ave and McFadden Ave

Cycle (sec): 100 Critical Vol./Cap.(X): 0.813
Loss Time (sec): 5 Average Delay (sec/veh): xxxxxx
Optimal Cycle: 55 Level Of Service: D

Table with 4 columns: North Bound, South Bound, East Bound, West Bound. Rows include Movement, Control, Rights, Min. Green, Y+R, and Lanes.

Volume Module table with 12 columns representing different volume categories and their values.

Saturation Flow Module table with 12 columns representing saturation flow values.

Capacity Analysis Module table with 12 columns representing capacity analysis values.

Santa Ana Circulation Element

Level Of Service Computation Report

ICU 1(Loss as Cycle Length %) Method (Future Volume Alternative)

Intersection #91 Tustin Ave and Fairhaven Ave

Cycle (sec): 100 Critical Vol./Cap.(X): 1.056
Loss Time (sec): 5 Average Delay (sec/veh): xxxxxx
Optimal Cycle: 180 Level Of Service: F

Table with 4 columns: North Bound, South Bound, East Bound, West Bound. Rows include Movement (L-T-R), Control, Rights, Min. Green, Y+R, and Lanes.

Volume Module: Table with 12 columns representing different volume categories and 13 rows of adjustment factors.

Saturation Flow Module: Table with 12 columns for saturation flow and 4 rows of adjustment factors.

Capacity Analysis Module: Table with 12 columns for capacity analysis and 2 rows of critical moves.

Santa Ana Circulation Element

Level Of Service Computation Report

ICU 1(Loss as Cycle Length %) Method (Future Volume Alternative)

Intersection #91 Tustin Ave and Fairhaven Ave

Cycle (sec): 100 Critical Vol./Cap.(X): 0.641
Loss Time (sec): 5 Average Delay (sec/veh): xxxxxx
Optimal Cycle: 32 Level Of Service: B

Table with 4 columns: North Bound, South Bound, East Bound, West Bound. Rows include Movement (L-T-R), Control, Rights, Min. Green, Y+R, and Lanes.

Volume Module: Table with 12 columns representing different volume categories and 12 rows of adjustment factors like Growth Adj, PHF Volume, etc.

Saturation Flow Module: Table with 12 columns for saturation flow and 4 rows for Sat/Lane, Adjustment, Lanes, and Final Sat.

Capacity Analysis Module: Table with 12 columns for capacity analysis and 3 rows for Vol/Sat, Crit Moves, and a summary row.

Santa Ana Circulation Element

Level Of Service Computation Report

ICU 1(Loss as Cycle Length %) Method (Future Volume Alternative)

Intersection #92 Tustin Ave and Santa Clara Ave

Cycle (sec): 100 Critical Vol./Cap.(X): 0.938
Loss Time (sec): 5 Average Delay (sec/veh): xxxxxx
Optimal Cycle: 116 Level Of Service: E

Table with 4 columns: North Bound, South Bound, East Bound, West Bound. Rows include Movement, Control, Rights, Min. Green, Y+R, and Lanes.

Volume Module table with 12 columns representing different traffic movements and 13 rows of volume-related metrics.

Saturation Flow Module table with 12 columns and 5 rows of saturation flow data.

Capacity Analysis Module table with 12 columns and 3 rows of capacity analysis data.

Santa Ana Circulation Element

Level Of Service Computation Report

ICU 1(Loss as Cycle Length %) Method (Future Volume Alternative)

Intersection #92 Tustin Ave and Santa Clara Ave

Cycle (sec): 100 Critical Vol./Cap.(X): 0.681
Loss Time (sec): 5 Average Delay (sec/veh): xxxxxx
Optimal Cycle: 35 Level Of Service: B

Table with 4 columns: North Bound, South Bound, East Bound, West Bound. Rows include Movement, Control, Rights, Min. Green, Y+R, and Lanes.

Volume Module table with 12 columns representing different traffic movements and 13 rows of volume-related metrics.

Saturation Flow Module table with 12 columns and 5 rows of saturation flow data.

Capacity Analysis Module table with 12 columns and 2 rows of capacity analysis data.

Santa Ana Circulation Element

Level Of Service Computation Report
2000 HCM Operations Method (Base Volume Alternative)

Intersection #96 SR-55 NB Ramps / Del Amo Ave and Newport Avenue

Cycle (sec): 100 Critical Vol./Cap.(X): 0.460
Loss Time (sec): 5 Average Delay (sec/veh): 24.4
Optimal Cycle: 23 Level Of Service: C

Table with columns for Approach (North, South, East, West Bound) and Movement (L, T, R). Rows include Control, Rights, Min. Green, Y+R, and Lanes.

Volume Module table with columns for movement and rows for Base Vol, Growth Adj, Initial Bse, User Adj, PHF Adj, PHF Volume, Reduct Vol, Reduced Vol, PCE Adj, MLF Adj, and Final Volume.

Saturation Flow Module table with columns for movement and rows for Sat/Lane, Adjustment, Lanes, and Final Sat.

Capacity Analysis Module table with columns for movement and rows for Vol/Sat, Crit Moves, Green/Cycle, Volume/Cap, Delay/Veh, User DelAdj, AdjDel/Veh, LOS by Move, and HCM2k85thQ.

Note: Queue reported is the number of cars per lane.

Santa Ana Circulation Element

Level Of Service Computation Report

2000 HCM Operations Method (Base Volume Alternative)

 Intersection #96 SR-55 NB Ramps / Del Amo Ave and Newport Avenue

Cycle (sec): 100 Critical Vol./Cap.(X): 0.700
 Loss Time (sec): 5 Average Delay (sec/veh): 28.5
 Optimal Cycle: 39 Level Of Service: C

Approach:	North Bound			South Bound			East Bound			West Bound		
Movement:	L	T	R	L	T	R	L	T	R	L	T	R
Control:	Protected			Protected			Protected			Protected		
Rights:	Include			Ovl			Include			Include		
Min. Green:	0	0	0	0	0	0	0	0	0	0	0	0
Y+R:	4.0	4.0	4.0	4.0	4.0	4.0	4.0	4.0	4.0	4.0	4.0	4.0
Lanes:	2	0	2	1	0	3	2	0	1	1	0	1

Volume Module:

Base Vol:	879	262	51	19	231	889	165	57	33	23	348	16
Growth Adj:	1.00	1.00	1.00	1.00	1.00	1.00	1.00	1.00	1.00	1.00	1.00	1.00
Initial Bse:	879	262	51	19	231	889	165	57	33	23	348	16
User Adj:	1.00	1.00	1.00	1.00	1.00	1.00	1.00	1.00	1.00	1.00	1.00	1.00
PHF Adj:	1.00	1.00	1.00	1.00	1.00	1.00	1.00	1.00	1.00	1.00	1.00	1.00
PHF Volume:	879	262	51	19	231	889	165	57	33	23	348	16
Reduct Vol:	0	0	0	0	0	0	0	0	0	0	0	0
Reduced Vol:	879	262	51	19	231	889	165	57	33	23	348	16
PCE Adj:	1.00	1.00	1.00	1.00	1.00	1.00	1.00	1.00	1.00	1.00	1.00	1.00
MLF Adj:	1.00	1.00	1.00	1.00	1.00	1.00	1.00	1.00	1.00	1.00	1.00	1.00
FinalVolume:	879	262	51	19	231	889	165	57	33	23	348	16

Saturation Flow Module:

Sat/Lane:	1900	1900	1900	1900	1900	1900	1900	1900	1900	1900	1900	1900
Adjustment:	0.92	0.89	0.89	0.95	0.91	0.75	0.92	0.90	0.90	0.95	0.94	0.94
Lanes:	2.00	2.51	0.49	1.00	3.00	2.00	2.00	1.27	0.73	1.00	1.91	0.09
Final Sat.:	3502	4238	825	1805	5187	2842	3502	2161	1251	1805	3427	158

Capacity Analysis Module:

Vol/Sat:	0.25	0.06	0.06	0.01	0.04	0.31	0.05	0.03	0.03	0.01	0.10	0.10
Crit Moves:	****					****	****				****	
Green/Cycle:	0.36	0.63	0.63	0.11	0.38	0.45	0.07	0.14	0.14	0.07	0.14	0.14
Volume/Cap:	0.70	0.10	0.10	0.10	0.12	0.70	0.70	0.18	0.18	0.18	0.70	0.70
Delay/Veh:	29.3	7.3	7.3	40.5	20.2	24.1	54.7	37.9	37.9	44.6	44.9	44.9
User DelAdj:	1.00	1.00	1.00	1.00	1.00	1.00	1.00	1.00	1.00	1.00	1.00	1.00
AdjDel/Veh:	29.3	7.3	7.3	40.5	20.2	24.1	54.7	37.9	37.9	44.6	44.9	44.9
LOS by Move:	C	A	A	D	C	C	D	D	D	D	D	D
HCM2k85thQ:	19	2	2	1	3	20	6	2	2	1	11	11

 Note: Queue reported is the number of cars per lane.

Santa Ana Circulation Element

Level Of Service Computation Report

ICU 1(Loss as Cycle Length %) Method (Future Volume Alternative)

Intersection #98 Red Hill Ave and Warner Ave

Cycle (sec): 100 Critical Vol./Cap.(X): 0.559
Loss Time (sec): 5 Average Delay (sec/veh): xxxxxx
Optimal Cycle: 26 Level Of Service: A

Table with 4 columns: North Bound, South Bound, East Bound, West Bound. Rows include Movement, Control, Rights, Min. Green, Y+R, and Lanes.

Volume Module: Table with 12 columns representing different volume categories and 12 rows of data including Base Vol, Growth Adj, Initial Bse, etc.

Saturation Flow Module: Table with 12 columns and 5 rows of data including Sat/Lane, Adjustment, Lanes, and Final Sat.

Capacity Analysis Module: Table with 12 columns and 4 rows of data including Vol/Sat, OvlAdjV/S, and Crit Moves.

Santa Ana Circulation Element

Level Of Service Computation Report

ICU 1(Loss as Cycle Length %) Method (Future Volume Alternative)

Intersection #98 Red Hill Ave and Warner Ave

Cycle (sec): 100 Critical Vol./Cap.(X): 0.804
Loss Time (sec): 5 Average Delay (sec/veh): xxxxxx
Optimal Cycle: 53 Level Of Service: D

Table with 4 columns: North Bound, South Bound, East Bound, West Bound. Rows include Movement (L-T-R), Control, Rights, Min. Green, Y+R, and Lanes.

Volume Module table with 12 columns representing different traffic movements and 13 rows of volume-related metrics like Base Vol, Growth Adj, etc.

Saturation Flow Module table with 12 columns and 5 rows of saturation flow metrics.

Capacity Analysis Module table with 12 columns and 4 rows of capacity analysis metrics.

Santa Ana Circulation Element

Level Of Service Computation Report

ICU 1(Loss as Cycle Length %) Method (Future Volume Alternative)

Intersection #100 Red Hill Ave and Alton Pkwy

Cycle (sec): 100 Critical Vol./Cap.(X): 0.684
Loss Time (sec): 5 Average Delay (sec/veh): xxxxxx
Optimal Cycle: 36 Level Of Service: B

Table with 4 columns: North Bound, South Bound, East Bound, West Bound. Rows include Movement (L-T-R), Control, Rights, Min. Green, Y+R, and Lanes.

Volume Module table with 12 columns representing different traffic movements and 13 rows of volume-related metrics like Base Vol, Growth Adj, etc.

Saturation Flow Module table with 12 columns and 4 rows showing Sat/Lane, Adjustment, Lanes, and Final Sat.

Capacity Analysis Module table with 12 columns and 3 rows showing Vol/Sat, Crit Moves, and a row of asterisks.

Santa Ana Circulation Element

Level Of Service Computation Report

ICU 1(Loss as Cycle Length %) Method (Future Volume Alternative)

Intersection #100 Red Hill Ave and Alton Pkwy

Cycle (sec): 100 Critical Vol./Cap.(X): 1.278
Loss Time (sec): 5 Average Delay (sec/veh): xxxxxx
Optimal Cycle: 180 Level Of Service: F

Table with 4 columns: North Bound, South Bound, East Bound, West Bound. Rows include Movement (L-T-R), Control, Rights, Min. Green, Y+R, and Lanes.

Volume Module table with 12 columns representing different traffic flows and 13 rows of volume-related metrics.

Saturation Flow Module table with 12 columns and 5 rows of saturation flow data.

Capacity Analysis Module table with 12 columns and 3 rows of capacity analysis data.

Santa Ana Circulation Element

Level Of Service Computation Report

ICU 1(Loss as Cycle Length %) Method (Base Volume Alternative)

Intersection #105 Von Karman Ave and Barranca Pkwy

Cycle (sec): 100 Critical Vol./Cap.(X): 0.930
Loss Time (sec): 5 Average Delay (sec/veh): xxxxxx
Optimal Cycle: 108 Level Of Service: E

Table with 4 columns: North Bound, South Bound, East Bound, West Bound. Rows include Movement (L-T-R), Control, Rights, Min. Green, Y+R, and Lanes.

Volume Module: Table with 12 columns representing different volume categories and their values.

Saturation Flow Module: Table with 12 columns representing saturation flow values and adjustments.

Capacity Analysis Module: Table with 12 columns representing capacity analysis metrics.

Santa Ana Circulation Element

Level Of Service Computation Report

ICU 1(Loss as Cycle Length %) Method (Base Volume Alternative)

Intersection #105 Von Karman Ave and Barranca Pkwy

Cycle (sec): 100 Critical Vol./Cap.(X): 1.241
Loss Time (sec): 5 Average Delay (sec/veh): xxxxxx
Optimal Cycle: 180 Level Of Service: F

Table with 4 columns: North Bound, South Bound, East Bound, West Bound. Rows include Movement (L-T-R), Control, Rights, Min. Green, Y+R, and Lanes.

Volume Module: Table with 12 columns representing different volume categories and their values.

Saturation Flow Module: Table with 12 columns representing saturation flow values and adjustment factors.

Capacity Analysis Module: Table with 12 columns representing capacity analysis metrics.

Santa Ana Circulation Element

Level Of Service Computation Report

ICU 1(Loss as Cycle Length %) Method (Future Volume Alternative)

Intersection #112 Tustin Ranch Road and Warner Avenue North

Cycle (sec): 100 Critical Vol./Cap.(X): 0.459
Loss Time (sec): 5 Average Delay (sec/veh): xxxxxx
Optimal Cycle: 22 Level Of Service: A

Street Name: Tustin Ranch Road Warner Avenue North
Approach: North Bound South Bound East Bound West Bound
Movement: L - T - R L - T - R L - T - R L - T - R
Control: Protected Protected Split Phase Split Phase
Rights: Ovl Include Include Ovl
Min. Green: 0 0 0 0 0 0 0 0 0 0 0 0
Y+R: 4.0 4.0 4.0 4.0 4.0 4.0 4.0 4.0 4.0 4.0 4.0 4.0
Lanes: 0 0 3 0 2 2 0 3 0 0 0 0 0 0 0 0 3 0 0 0 2

Volume Module:
Base Vol: 0 396 383 412 1165 0 0 0 0 865 0 255
Growth Adj: 1.00 1.00 1.00 1.00 1.00 1.00 1.00 1.00 1.00 1.00 1.00 1.00
Initial Bse: 0 396 383 412 1165 0 0 0 0 865 0 255
Added Vol: 0 0 0 0 0 0 0 0 0 0 0 0
PasserByVol: 0 0 0 0 0 0 0 0 0 0 0 0
Initial Fut: 0 396 383 412 1165 0 0 0 0 865 0 255
User Adj: 1.00 1.00 1.00 1.00 1.00 1.00 1.00 1.00 1.00 1.00 1.00 1.00
PHF Adj: 1.00 1.00 1.00 1.00 1.00 1.00 1.00 1.00 1.00 1.00 1.00 1.00
PHF Volume: 0 396 383 412 1165 0 0 0 0 865 0 255
Reduct Vol: 0 0 0 0 0 0 0 0 0 0 0 0
Reduced Vol: 0 396 383 412 1165 0 0 0 0 865 0 255
PCE Adj: 1.00 1.00 1.00 1.00 1.00 1.00 1.00 1.00 1.00 1.00 1.00 1.00
MLF Adj: 1.00 1.00 1.00 1.00 1.00 1.00 1.00 1.00 1.00 1.00 1.00 1.00
FinalVolume: 0 396 383 412 1165 0 0 0 0 865 0 255
OvlAdjVol: 0 0 0 0 0 0 0 0 0 0 0 0

Saturation Flow Module:
Sat/Lane: 1600 1600 1600 1600 1600 1600 1600 1600 1600 1600 1600 1600
Adjustment: 1.00 1.06 1.00 1.00 1.06 1.00 1.00 1.06 1.00 1.00 1.06 1.00
Lanes: 0.00 3.00 2.00 2.00 3.00 0.00 0.00 0.00 0.00 3.00 0.00 2.00
Final Sat.: 0 5100 3200 3200 5100 0 0 0 0 4800 0 3200

Capacity Analysis Module:
Vol/Sat: 0.00 0.08 0.12 0.13 0.23 0.00 0.00 0.00 0.00 0.18 0.00 0.08
OvlAdjV/S: 0.00 0.00 0.00 0.00 0.00 0.00 0.00 0.00 0.00 0.00 0.00 0.00
Crit Moves: ****

Santa Ana Circulation Element

Level Of Service Computation Report

ICU 1(Loss as Cycle Length %) Method (Future Volume Alternative)

Intersection #112 Tustin Ranch Road and Warner Avenue North

Cycle (sec): 100 Critical Vol./Cap.(X): 0.746
Loss Time (sec): 5 Average Delay (sec/veh): xxxxxx
Optimal Cycle: 43 Level Of Service: C

Street Name: Tustin Ranch Road Warner Avenue North
Approach: North Bound South Bound East Bound West Bound
Movement: L - T - R L - T - R L - T - R L - T - R
Control: Protected Protected Split Phase Split Phase
Rights: Ovl Include Include Ovl
Min. Green: 0 0 0 0 0 0 0 0 0 0 0 0
Y+R: 4.0 4.0 4.0 4.0 4.0 4.0 4.0 4.0 4.0 4.0 4.0 4.0
Lanes: 0 0 3 0 2 2 0 3 0 0 0 0 0 0 0 0 3 0 0 0 2

Volume Module:
Base Vol: 0 1995 1175 447 657 0 0 0 0 792 0 716
Growth Adj: 1.00 1.00 1.00 1.00 1.00 1.00 1.00 1.00 1.00 1.00 1.00 1.00
Initial Bse: 0 1995 1175 447 657 0 0 0 0 792 0 716
Added Vol: 0 0 0 0 0 0 0 0 0 0 0 0
PasserByVol: 0 0 0 0 0 0 0 0 0 0 0 0
Initial Fut: 0 1995 1175 447 657 0 0 0 0 792 0 716
User Adj: 1.00 1.00 1.00 1.00 1.00 1.00 1.00 1.00 1.00 1.00 1.00 1.00
PHF Adj: 1.00 1.00 1.00 1.00 1.00 1.00 1.00 1.00 1.00 1.00 1.00 1.00
PHF Volume: 0 1995 1175 447 657 0 0 0 0 792 0 716
Reduct Vol: 0 0 0 0 0 0 0 0 0 0 0 0
Reduced Vol: 0 1995 1175 447 657 0 0 0 0 792 0 716
PCE Adj: 1.00 1.00 1.00 1.00 1.00 1.00 1.00 1.00 1.00 1.00 1.00 1.00
MLF Adj: 1.00 1.00 1.00 1.00 1.00 1.00 1.00 1.00 1.00 1.00 1.00 1.00
FinalVolume: 0 1995 1175 447 657 0 0 0 0 792 0 716
OvlAdjVol: 647 269

Saturation Flow Module:
Sat/Lane: 1600 1600 1600 1600 1600 1600 1600 1600 1600 1600 1600 1600
Adjustment: 1.00 1.06 1.00 1.00 1.06 1.00 1.00 1.06 1.00 1.00 1.06 1.00
Lanes: 0.00 3.00 2.00 2.00 3.00 0.00 0.00 0.00 0.00 3.00 0.00 2.00
Final Sat.: 0 5100 3200 3200 5100 0 0 0 0 4800 0 3200

Capacity Analysis Module:
Vol/Sat: 0.00 0.39 0.37 0.14 0.13 0.00 0.00 0.00 0.00 0.17 0.00 0.22
OvlAdjV/S: 0.20 0.08
Crit Moves: ****

Santa Ana Circulation Element

Level Of Service Computation Report

ICU 1(Loss as Cycle Length %) Method (Future Volume Alternative)

Intersection #113 Tustin Ranch Road and Walnut Avenue

Cycle (sec): 100 Critical Vol./Cap.(X): 1.175
Loss Time (sec): 5 Average Delay (sec/veh): xxxxxx
Optimal Cycle: 180 Level Of Service: F

Table with columns for Street Name (Tustin Ranch Road, Walnut Avenue), Approach (North Bound, South Bound, East Bound, West Bound), Movement (L, T, R), Control, Rights, Min. Green, Y+R, and Lanes.

Volume Module: Table with columns for Base Vol, Growth Adj, Initial Bse, Added Vol, PasserByVol, Initial Fut, User Adj, PHF Adj, PHF Volume, Reduct Vol, Reduced Vol, PCE Adj, MLF Adj, FinalVolume, and OvlAdjVol.

Saturation Flow Module: Table with columns for Sat/Lane, Adjustment, Lanes, and Final Sat.

Capacity Analysis Module: Table with columns for Vol/Sat, OvlAdjV/S, and Crit Moves.

Santa Ana Circulation Element

Level Of Service Computation Report

ICU 1(Loss as Cycle Length %) Method (Future Volume Alternative)

Intersection #113 Tustin Ranch Road and Walnut Avenue

Cycle (sec): 100 Critical Vol./Cap.(X): 1.590
Loss Time (sec): 5 Average Delay (sec/veh): xxxxxx
Optimal Cycle: 180 Level Of Service: F

Table with columns for Street Name (Tustin Ranch Road, Walnut Avenue), Approach (North Bound, South Bound, East Bound, West Bound), Movement (L, T, R), Control, Rights, Min. Green, Y+R, and Lanes.

Volume Module: Table with columns for Base Vol, Growth Adj, Initial Bse, Added Vol, PasserByVol, Initial Fut, User Adj, PHF Adj, PHF Volume, Reduct Vol, Reduced Vol, PCE Adj, MLF Adj, FinalVolume, and OvlAdjVol.

Saturation Flow Module: Table with columns for Sat/Lane, Adjustment, Lanes, and Final Sat.

Capacity Analysis Module: Table with columns for Vol/Sat, OvlAdjV/S, and Crit Moves.

APPENDIX F

VMT CALCULATIONS

Base Year 2016										
SCENARIO	I-I	I-X	X-I	Total VMT	TOT_POP	Total Employees	VMT/Capita	TOT_POP	Total Employees - Reduced	VMT / Capita
Citywide	698,590	5,295,496	5,291,968	11,286,054	364,042	176,354	20.9	364,042	139,672	22.4
Countywide	47,482,030	24,809,328	24,994,227	97,285,585	3,179,626	1,710,147	19.9	3,179,626	593,421	25.8

Existing Year 2020										
SCENARIO	I-I	I-X	X-I	Total VMT	TOT_POP	Total Employees	VMT/Capita	TOT_POP	Total Employees - Reduced	VMT / Capita
Citywide	697,779	5,356,504	5,352,841	11,407,124	367,064	177,854	20.9	367,064	140,860	22.5
Countywide	48,242,429	25,463,887	25,637,825	99,344,141	3,228,591	1,747,428	20.0	3,228,591	606,358	25.9

Future Year 2045 Baseline										
SCENARIO	I-I	I-X	X-I	Total VMT	TOT_POP	Total Employees	VMT/Capita	TOT_POP	Total Employees - Reduced	VMT / Capita
Citywide	692,704	5,737,798	5,733,292	12,163,794	385,955	187,226	21.2	385,955	148,283	22.8
Countywide	52,994,916	29,554,879	29,660,308	112,210,103	3,534,620	1,980,433	20.3	3,534,620	687,210	26.6

Future Year 2045 WP - 80% Buildout										
SCENARIO	I-I	I-X	X-I	Total VMT	TOT_POP	Total Employees	VMT/Capita	TOT_POP	Total Employees - Reduced	VMT / Capita
Citywide	637,655	5,432,337	5,448,967	11,518,959	432,421	169,438	19.1	432,421	134,195	20.3
Countywide	52,931,787	29,642,498	29,748,229	112,322,514	3,581,086	1,962,645	20.3	3,581,086	681,038	26.4

*In order to mitigate double-counting, a reduction factor was applied to the employee population to account for the amount of employees who are also residents of the City. Per SCAG Local Profile Report (2019), 20.8% of commuters live in the City. Thus, a reduction of 20.8% was applied to the employee population. (<https://www.scag.ca.gov/Documents/SantaAna.pdf>)

*In order to mitigate double-counting, a reduction factor was applied to the employee population to account for the amount of employees who are also residents of the County. Per SCAG Local Profile Report (2019), 65.3% of commuters live in the County. Thus, a reduction of 65.3% was applied to the employee population. (<https://www.scag.ca.gov/Documents/OrangeCountyLP.pdf>)

APPENDIX G

OCTAM VOLUME COMPARISON PLOTS

OCTAM 5.0 – Daily Traffic Volume Comparison Between 2045 80% Buildout and 2045 80% Buildout with Baseline Network

Volume in Thousands

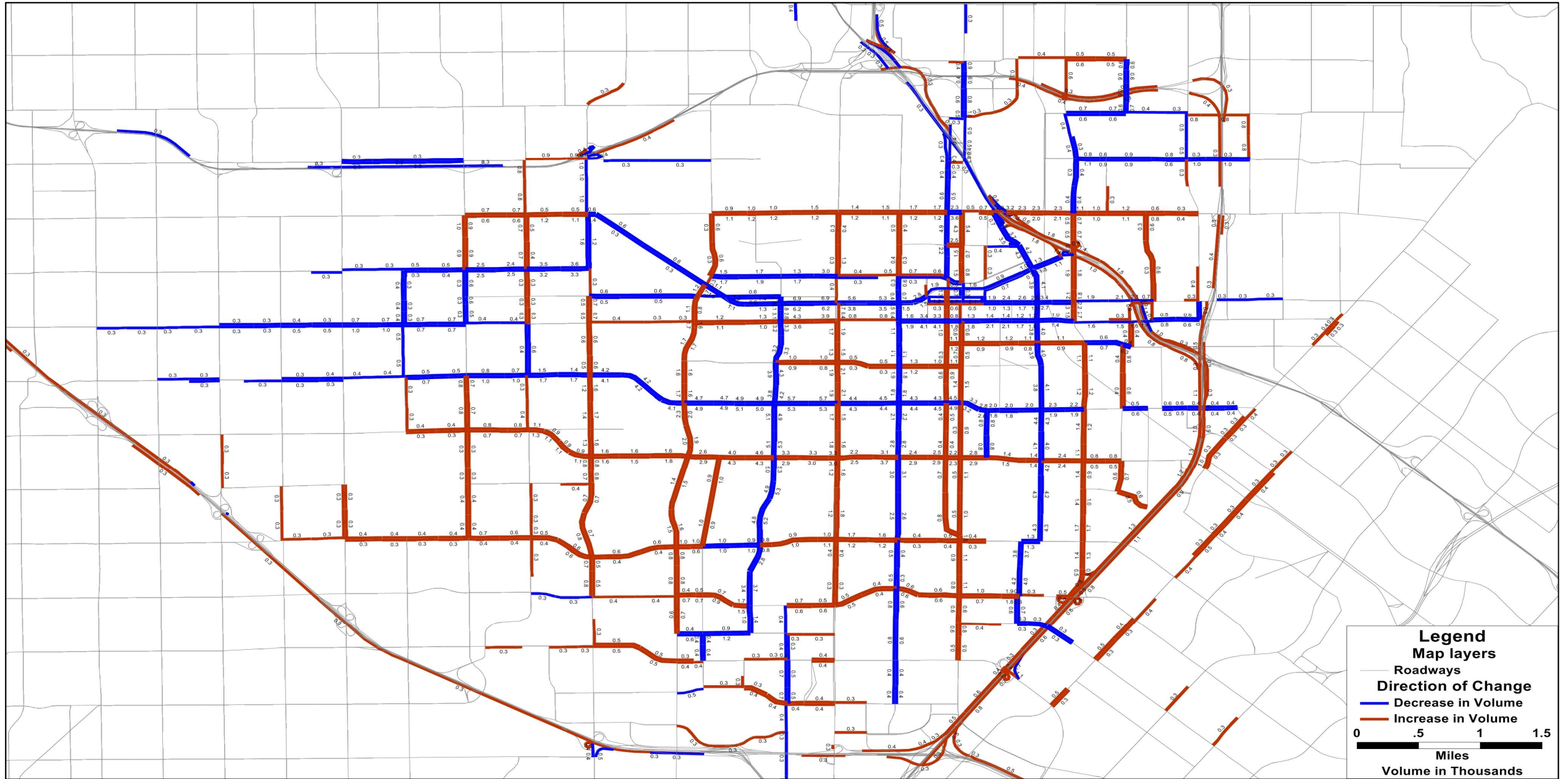

OCTAM 5.0 – AM Peak Traffic Volume Comparison Between 2045 80% Buildout and 2045 80% Buildout with Baseline Network

Volume in Thousands

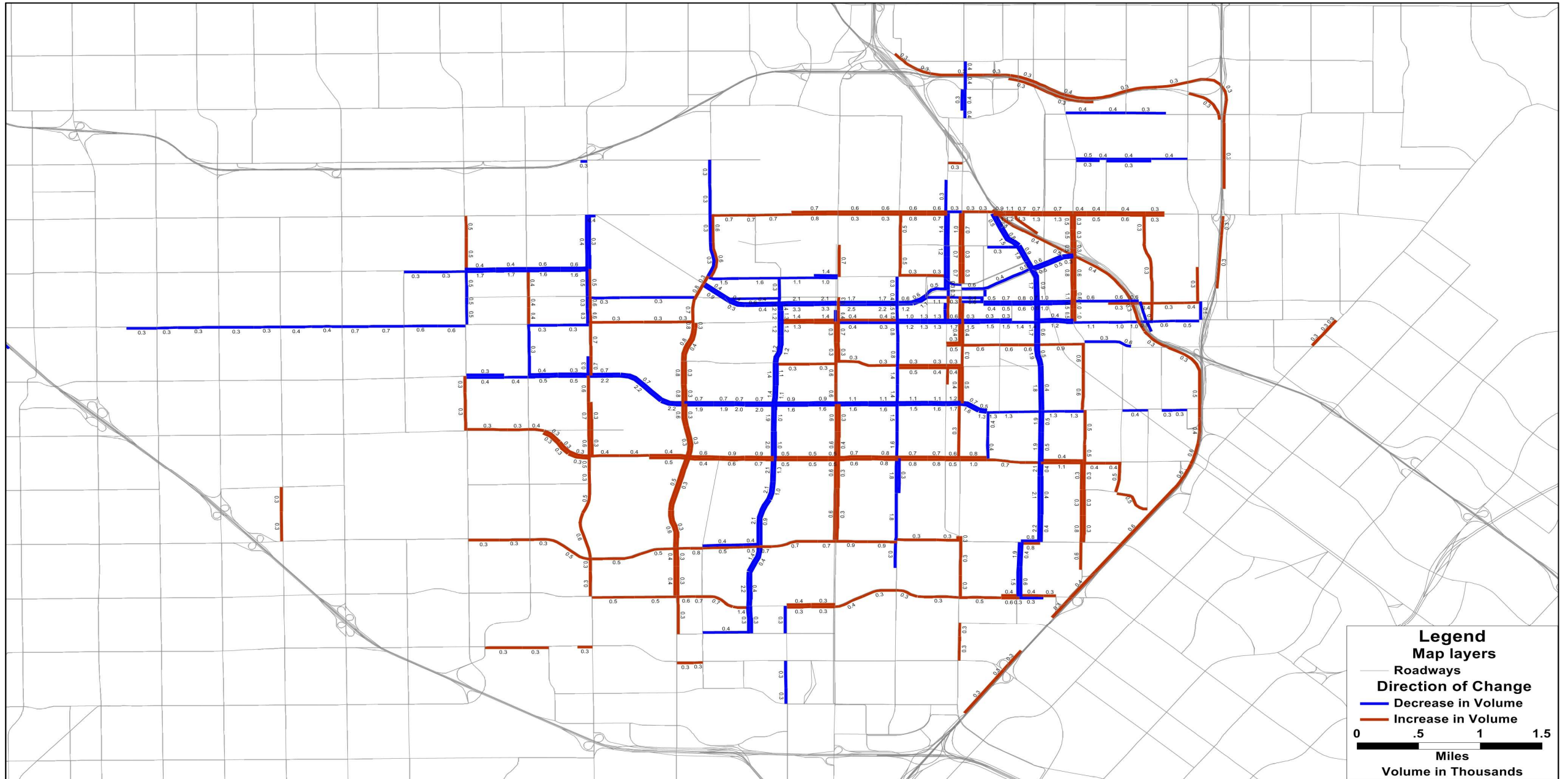

OCTAM 5.0 – PM Peak Traffic Volume Comparison Between 2045 80% Buildout and 2045 80% Buildout with Baseline Network

Volume in Thousands

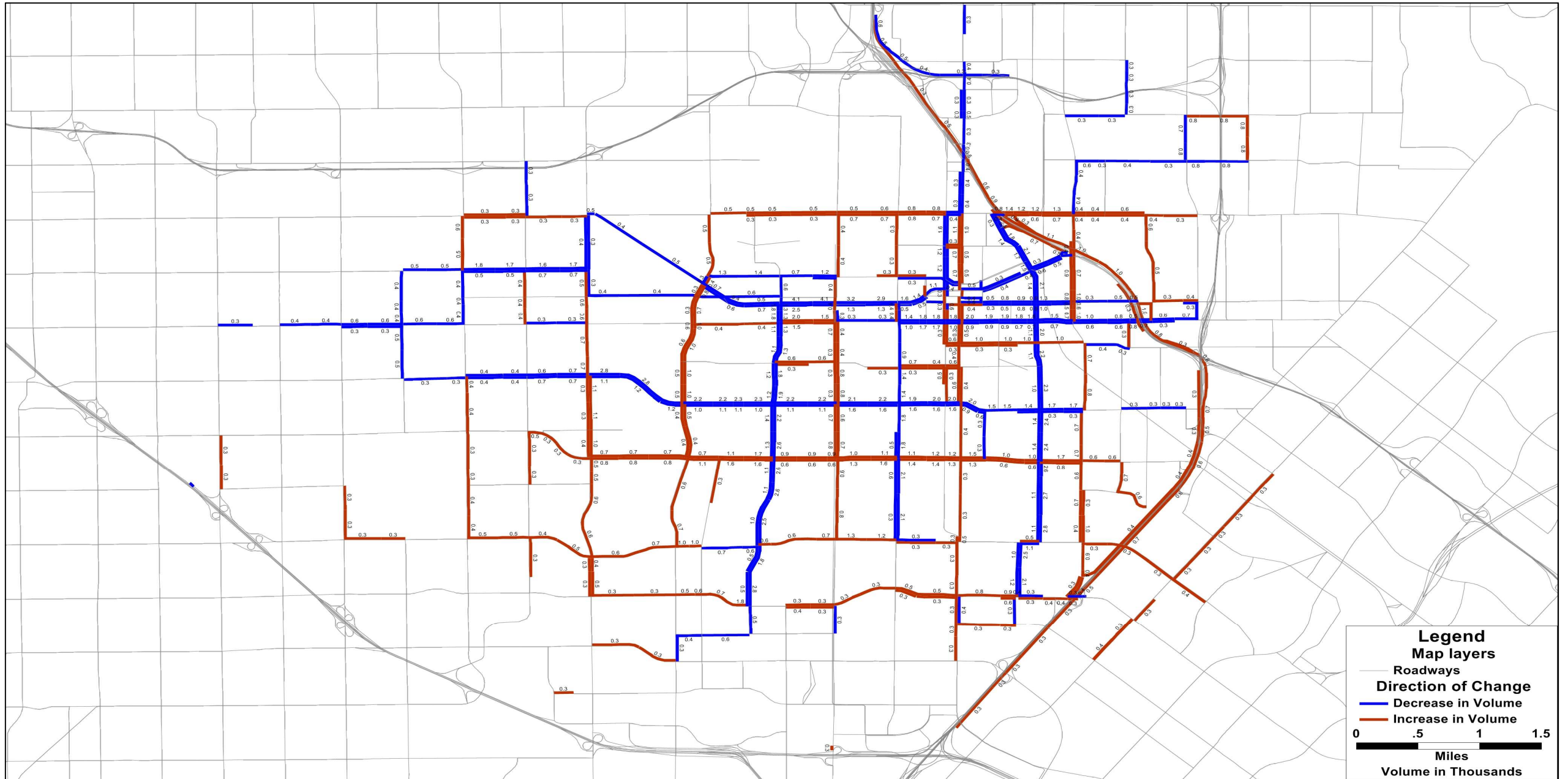

APPENDIX H

COUNTS

INTERSECTION TURNING MOVEMENT COUNTS

PREPARED BY: AimTD LLC. tel: 714 253 7888 cs@aimtd.com

DATE: Tue, May 14, 19
LOCATION: Santa Ana
 NORTH & SOUTH: Euclid
 EAST & WEST: 1st
PROJECT #: SC2183
LOCATION #: 1
CONTROL: SIGNAL



Add U-Turns to Left Turns

LANES:	NORTHBOUND			SOUTHBOUND			EASTBOUND			WESTBOUND			TOTAL
	Euclid			Euclid			1st			1st			
	NL	NT	NR	SL	ST	SR	EL	ET	ER	WL	WT	WR	

U-TURNS				
NB	SB	EB	WB	TTL
0	0	0	0	0

AM	AM												
	7:00 AM	7	180	40	42	475	14	33	136	22	23	71	18
7:15 AM	10	203	43	53	504	12	36	138	32	37	109	29	1,206
7:30 AM	28	245	48	48	503	19	44	147	38	60	125	42	1,347
7:45 AM	34	271	44	47	473	15	62	205	41	47	173	49	1,461
8:00 AM	33	264	41	60	432	23	52	210	43	44	168	49	1,419
8:15 AM	27	253	44	49	417	45	57	240	29	31	114	46	1,352
8:30 AM	21	235	43	58	400	35	41	168	22	37	123	32	1,215
8:45 AM	35	179	31	48	377	39	56	117	23	35	141	34	1,115
VOLUMES	195	1,830	334	405	3,581	202	381	1,361	250	314	1,024	299	10,176
APPROACH %	8%	78%	14%	10%	86%	5%	19%	68%	13%	19%	63%	18%	
APP/DEPART	2,359	/	2,508	4,188	/	4,139	1,992	/	2,110	1,637	/	1,419	0
BEGIN PEAK HR	7:30 AM												
VOLUMES	122	1,033	177	204	1,825	102	215	802	151	182	580	186	5,579
APPROACH %	9%	78%	13%	10%	86%	5%	18%	69%	13%	19%	61%	20%	
PEAK HR FACTOR	0.954												
APP/DEPART	1,332	/	1,433	2,131	/	2,157	1,168	/	1,186	948	/	803	0
PM	PM												
	4:00 PM	46	364	41	36	244	43	55	161	20	44	162	58
4:15 PM	45	404	28	44	213	42	44	121	19	39	174	52	1,225
4:30 PM	23	318	73	50	283	48	57	161	20	46	170	43	1,292
4:45 PM	36	367	29	39	258	47	53	154	20	48	196	61	1,308
5:00 PM	34	363	33	43	289	47	46	162	28	59	225	55	1,384
5:15 PM	43	371	28	49	261	46	58	169	28	56	226	55	1,390
5:30 PM	41	370	23	38	245	56	53	162	25	45	223	58	1,339
5:45 PM	39	358	33	53	247	48	52	178	23	54	226	46	1,357
VOLUMES	307	2,915	288	352	2,040	377	418	1,268	183	391	1,602	428	10,569
APPROACH %	9%	83%	8%	13%	74%	14%	22%	68%	10%	16%	66%	18%	
APP/DEPART	3,510	/	3,753	2,769	/	2,610	1,869	/	1,912	2,421	/	2,294	0
BEGIN PEAK HR	5:00 PM												
VOLUMES	157	1,462	117	183	1,042	197	209	671	104	214	900	214	5,470
APPROACH %	9%	84%	7%	13%	73%	14%	21%	68%	11%	16%	68%	16%	
PEAK HR FACTOR	0.982												
APP/DEPART	1,736	/	1,880	1,422	/	1,361	984	/	971	1,328	/	1,258	0

1	0	0	2	3
0	0	0	2	2
0	0	0	1	1
0	0	1	0	1
1	0	0	0	1
1	0	0	2	3
0	0	1	3	4
1	0	0	0	1
4	0	2	10	16

0	1	1	1	3
0	0	0	1	1
0	0	1	1	2
0	0	2	2	4
0	0	3	0	3
0	0	2	0	2
1	0	0	0	1
0	0	0	0	0
1	1	9	5	16

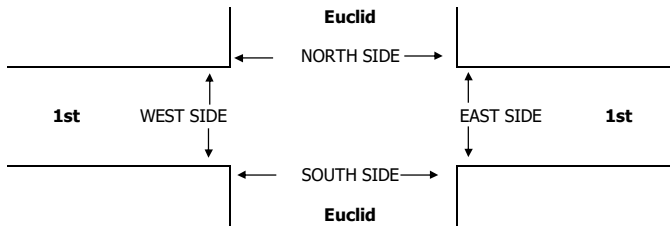

AM	7:00 AM	7	180	40	42	475	14	33	136	22	23	71	18	1,061
	7:15 AM	10	203	43	53	504	12	36	138	32	37	109	29	1,206
7:30 AM	28	245	48	48	503	19	44	147	38	60	125	42	1,347	
7:45 AM	34	271	44	47	473	15	62	205	41	47	173	49	1,461	
8:00 AM	33	264	41	60	432	23	52	210	43	44	168	49	1,419	
8:15 AM	27	253	44	49	417	45	57	240	29	31	114	46	1,352	
8:30 AM	21	235	43	58	400	35	41	168	22	37	123	32	1,215	
8:45 AM	35	179	31	48	377	39	56	117	23	35	141	34	1,115	
TOTAL	195	1,830	334	405	3,581	202	381	1,361	250	314	1,024	299	10,176	
AM BEGIN PEAK HR	7:30 AM													
4:00 PM	46	364	41	36	244	43	55	161	20	44	162	58	1,274	
4:15 PM	45	404	28	44	213	42	44	121	19	39	174	52	1,225	
4:30 PM	23	318	73	50	283	48	57	161	20	46	170	43	1,292	
4:45 PM	36	367	29	39	258	47	53	154	20	48	196	61	1,308	
5:00 PM	34	363	33	43	289	47	46	162	28	59	225	55	1,384	
5:15 PM	43	371	28	49	261	46	58	169	28	56	226	55	1,390	
5:30 PM	41	370	23	38	245	56	53	162	25	45	223	58	1,339	
5:45 PM	39	358	33	53	247	48	52	178	23	54	226	46	1,357	
TOTAL	307	2,915	288	352	2,040	377	418	1,268	183	391	1,602	428	10,569	
PM BEGIN PEAK HR	5:00 PM													

PEDESTRIAN + BIKE CROSSINGS				
N SIDE	S SIDE	E SIDE	W SIDE	TOTAL
0	0	0	0	0
0	0	0	0	0
0	0	0	0	0
0	0	0	0	0
0	0	0	0	0
0	0	0	0	0
0	0	0	0	0
0	0	0	0	0
0	0	0	0	0
0	0	0	0	0
0	0	0	0	0
0	0	0	0	0
0	0	0	0	0
0	0	0	0	0

PEDESTRIAN CROSSINGS				
N SIDE	S SIDE	E SIDE	W SIDE	TOTAL
0	0	0	0	0
0	0	0	0	0
0	0	0	0	0
0	0	0	0	0
0	0	0	0	0
0	0	0	0	0
0	0	0	0	0
0	0	0	0	0
0	0	0	0	0
0	0	0	0	0
0	0	0	0	0
0	0	0	0	0
0	0	0	0	0

BICYCLE CROSSINGS				
NS	SS	ES	WS	TOTAL
0	0	0	0	0
0	0	0	0	0
0	0	0	0	0
0	0	0	0	0
0	0	0	0	0
0	0	0	0	0
0	0	0	0	0
0	0	0	0	0
0	0	0	0	0
0	0	0	0	0
0	0	0	0	0
0	0	0	0	0
0	0	0	0	0
0	0	0	0	0

INTERSECTION TURNING MOVEMENT COUNTS

PREPARED BY: AimTD LLC. tel: 714 253 7888 pacific@aimtd.com

DATE:
Wed, Feb 10, 16

LOCATION:
NORTH & SOUTH: Santa Ana
EAST & WEST: Euclid
McFadden

PROJECT #: SC0846
LOCATION #: 30
CONTROL: SIGNAL

NOTES:	AM		▲ N	
	PM		W ←	E →
	MD		S ▼	
	OTHER			

Add U-Turns to Left Turns

	NORTHBOUND			SOUTHBOUND			EASTBOUND			WESTBOUND			TOTAL
	Euclid			Euclid			McFadden			McFadden			
LANES:	NL 1	NT 2	NR 0	SL 1	ST 3	SR 0	EL 1	ET 2	ER 0	WL 1	WT 2	WR 0	
AM													
7:00 AM	15	164	8	14	479	23	19	68	16	23	52	12	893
7:15 AM	16	272	20	26	548	20	27	78	41	17	64	25	1,154
7:30 AM	29	263	38	32	395	18	51	118	71	45	65	39	1,164
7:45 AM	34	265	27	38	470	34	58	101	81	49	75	38	1,270
8:00 AM	43	258	30	26	431	58	55	111	62	41	133	35	1,283
8:15 AM	33	271	30	35	535	41	54	114	61	24	80	22	1,300
8:30 AM	22	263	15	22	469	31	39	118	48	17	73	34	1,151
8:45 AM	20	229	17	20	432	18	34	90	28	20	56	25	989
VOLUMES	212	1,985	185	213	3,759	243	337	798	408	236	598	230	9,204
APPROACH %	9%	83%	8%	5%	89%	6%	22%	52%	26%	22%	56%	22%	
APP/DEPART	2,382	/	2,552	4,215	/	4,403	1,543	/	1,196	1,064	/	1,053	0
BEGIN PEAK HR	7:30 AM												
VOLUMES	139	1,057	125	131	1,831	151	218	444	275	159	353	134	5,017
APPROACH %	11%	80%	9%	6%	87%	7%	23%	47%	29%	25%	55%	21%	
PEAK HR FACTOR	0.989			0.865			0.976			0.773			0.965
APP/DEPART	1,321	/	1,409	2,113	/	2,265	937	/	700	646	/	643	0
PM													
4:00 PM	29	286	20	25	278	27	45	83	35	14	96	25	963
4:15 PM	30	297	15	27	284	35	53	96	47	17	109	30	1,040
4:30 PM	34	315	21	22	287	40	55	101	43	21	123	35	1,097
4:45 PM	36	327	20	26	300	39	49	98	52	27	130	47	1,151
5:00 PM	44	335	23	24	285	35	51	104	40	30	134	53	1,158
5:15 PM	34	374	19	22	365	40	40	100	41	34	130	63	1,262
5:30 PM	54	334	26	33	351	43	35	100	44	31	117	73	1,241
5:45 PM	51	352	17	28	267	36	36	115	29	21	121	64	1,137
VOLUMES	312	2,620	161	207	2,417	295	364	797	331	195	960	390	9,049
APPROACH %	10%	85%	5%	7%	83%	10%	24%	53%	22%	13%	62%	25%	
APP/DEPART	3,093	/	3,374	2,919	/	2,943	1,492	/	1,165	1,545	/	1,567	0
BEGIN PEAK HR	4:45 PM												
VOLUMES	168	1,370	88	105	1,301	157	175	402	177	122	511	236	4,812
APPROACH %	10%	84%	5%	7%	83%	10%	23%	53%	23%	14%	59%	27%	
PEAK HR FACTOR	0.952			0.915			0.947			0.957			0.953
APP/DEPART	1,626	/	1,781	1,563	/	1,600	754	/	595	869	/	836	0

U-TURNS				
NB	SB	EB	WB	TTL
0	0	0	0	0
0	0	0	0	0
0	0	0	0	0
0	0	0	0	0
0	0	0	0	0
0	0	0	0	0
0	0	0	0	0
0	0	0	0	0
0	0	0	0	0
0	0	0	0	0
0	0	0	0	0
0	0	0	0	0
0	0	0	0	0
0	0	0	0	0
0	0	0	0	0
0	0	0	0	0
0	0	0	0	0
0	0	0	0	0

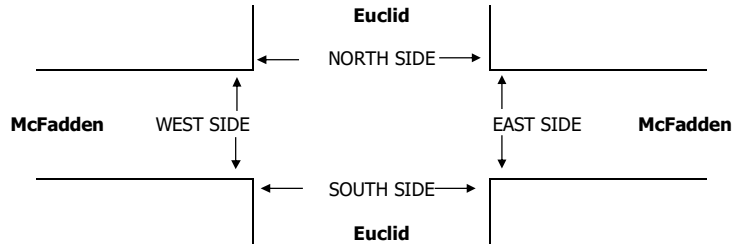

		N SIDE	S SIDE	E SIDE	W SIDE	TOTAL
AM	7:00 AM	8	4	2	8	22
	7:15 AM	8	13	6	27	54
	7:30 AM	21	52	21	55	149
	7:45 AM	7	12	11	4	34
	8:00 AM	9	20	4	11	44
	8:15 AM	6	4	5	9	24
	8:30 AM	4	6	4	2	16
	8:45 AM	1	2	2	0	5
	TOTAL	64	113	55	116	348
PM	4:00 PM	8	14	9	7	38
	4:15 PM	8	12	13	4	37
	4:30 PM	10	15	8	10	43
	4:45 PM	8	4	5	9	26
	5:00 PM	35	14	11	51	111
	5:15 PM	19	46	15	34	114
	5:30 PM	15	24	6	42	87
	5:45 PM	6	7	4	11	28
	TOTAL	109	136	71	168	484

PEDESTRIAN + BIKE CROSSINGS				
N SIDE	S SIDE	E SIDE	W SIDE	TOTAL
7	1	2	5	15
6	12	5	27	50
20	50	19	52	141
6	8	8	3	25
3	15	4	7	29
6	3	4	9	22
3	5	4	2	14
1	1	2	0	4
52	95	48	105	300
5	12	7	5	29
7	8	8	3	26
4	10	6	6	26
6	3	4	9	22
31	12	10	47	100
16	44	11	33	104
14	22	6	41	83
5	7	2	10	24
88	118	54	154	414

PEDESTRIAN CROSSINGS				
N SIDE	S SIDE	E SIDE	W SIDE	TOTAL
7	1	2	5	15
6	12	5	27	50
20	50	19	52	141
6	8	8	3	25
3	15	4	7	29
6	3	4	9	22
3	5	4	2	14
1	1	2	0	4
52	95	48	105	300
5	12	7	5	29
7	8	8	3	26
4	10	6	6	26
6	3	4	9	22
31	12	10	47	100
16	44	11	33	104
14	22	6	41	83
5	7	2	10	24
88	118	54	154	414

BICYCLE CROSSINGS				
NS	SS	ES	WS	TOTAL
1	3	0	3	7
2	1	1	0	4
1	2	2	3	8
1	4	3	1	9
6	5	0	4	15
0	1	1	0	2
1	1	0	0	2
0	1	0	0	1
12	18	7	11	48
3	2	2	2	9
1	4	5	1	11
6	5	2	4	17
2	1	1	0	4
4	2	1	4	11
3	2	4	1	10
1	2	0	1	4
1	0	2	1	4
21	18	17	14	70

INTERSECTION TURNING MOVEMENT COUNTS

PREPARED BY: AimTD LLC. tel: 714 253 7888 cs@aimtd.com

DATE:
Tue, May 14, 19

LOCATION:
NORTH & SOUTH: Santa Ana
EAST & WEST: Euclid Edinger

PROJECT #: SC2183
LOCATION #: 2
CONTROL: SIGNAL

NOTES:

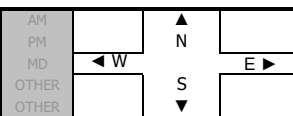

Add U-Turns to Left Turns

LANES:	NORTHBOUND			SOUTHBOUND			EASTBOUND			WESTBOUND			TOTAL
	NL	NT	NR	SL	ST	SR	EL	ET	ER	WL	WT	WR	
	2	2.5	0.5	2	2.5	0.5	1	2	1	1	2	1	

U-TURNS				
NB	SB	EB	WB	TTL
0	0	0	0	0

AM	7:00 AM	15	137	5	17	426	24	33	131	88	25	101	18	1,020	0	0	0	1	1
	7:15 AM	23	134	8	27	485	31	50	141	86	18	119	24	1,146	0	0	3	1	4
	7:30 AM	30	214	8	35	494	39	42	152	124	27	165	32	1,362	3	0	2	0	5
	7:45 AM	47	199	18	27	478	57	50	188	138	29	155	29	1,415	3	0	2	1	6
	8:00 AM	30	221	16	34	424	30	37	204	109	27	149	30	1,311	3	1	4	0	8
	8:15 AM	25	202	29	29	427	41	41	201	84	16	133	18	1,246	0	0	1	1	2
	8:30 AM	27	161	13	26	456	45	50	144	87	27	117	21	1,174	1	1	2	0	4
	8:45 AM	33	152	19	26	397	33	31	140	86	20	125	26	1,088	2	0	5	0	7
	VOLUMES	230	1,420	116	221	3,587	300	334	1,301	802	189	1,064	198	9,762	12	2	19	4	37
	APPROACH %	13%	80%	7%	5%	87%	7%	14%	53%	33%	13%	73%	14%						
APP/DEPART	1,766	/	1,935	4,108	/	4,586	2,437	/	1,640	1,451	/	1,601	0						
BEGIN PEAK HR	7:30 AM																		
VOLUMES	132	836	71	125	1,823	167	170	745	455	99	602	109	5,334						
APPROACH %	13%	80%	7%	6%	86%	8%	12%	54%	33%	12%	74%	13%							
PEAK HR FACTOR	0.973																		
APP/DEPART	1,039	/	1,107	2,115	/	2,384	1,370	/	942	810	/	901	0						
PM	4:00 PM	86	347	11	24	179	36	39	162	39	23	186	22	1,154	2	3	1	1	7
	4:15 PM	104	390	27	25	179	41	37	150	36	18	214	21	1,242	1	0	2	0	3
	4:30 PM	107	350	19	28	178	47	40	150	46	17	208	32	1,222	0	1	5	1	7
	4:45 PM	102	415	34	32	191	46	46	139	41	20	203	35	1,304	1	1	2	0	4
	5:00 PM	140	374	27	36	195	48	37	130	55	21	217	36	1,316	3	0	8	0	11
	5:15 PM	136	401	29	27	216	63	43	172	45	19	191	29	1,371	6	1	4	1	12
	5:30 PM	142	366	20	25	193	44	33	174	43	30	220	34	1,324	3	0	1	0	4
	5:45 PM	112	313	25	32	191	43	40	171	38	17	207	32	1,221	0	2	8	0	10
	VOLUMES	929	2,956	192	229	1,522	368	315	1,248	343	165	1,646	241	10,154	16	8	31	3	58
	APPROACH %	23%	73%	5%	11%	72%	17%	17%	65%	18%	8%	80%	12%						
APP/DEPART	4,077	/	3,489	2,119	/	2,043	1,906	/	1,664	2,052	/	2,958	0						
BEGIN PEAK HR	4:45 PM																		
VOLUMES	520	1,556	110	120	795	201	159	615	184	90	831	134	5,315						
APPROACH %	24%	71%	5%	11%	71%	18%	17%	64%	19%	9%	79%	13%							
PEAK HR FACTOR	0.966																		
APP/DEPART	2,186	/	1,836	1,116	/	1,081	958	/	844	1,055	/	1,554	0						

0	0	0	1	1
0	0	3	1	4
3	0	2	0	5
3	0	2	1	6
3	1	4	0	8
0	0	1	1	2
1	1	2	0	4
2	0	5	0	7

2	3	1	1	7
1	0	2	0	3
0	1	5	1	7
1	1	2	0	4
3	0	8	0	11
6	1	4	1	12
3	0	1	0	4
0	2	8	0	10

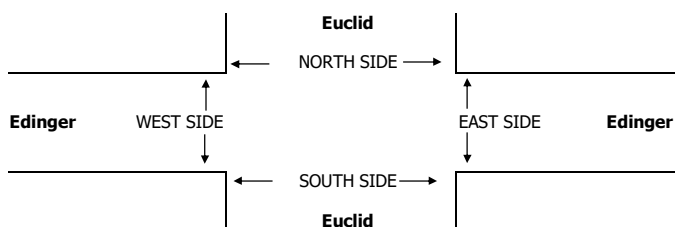

AM	7:00 AM	0	0	0	0	0
	7:15 AM	0	0	0	0	0
	7:30 AM	0	0	0	0	0
	7:45 AM	0	0	0	0	0
	8:00 AM	0	0	0	0	0
	8:15 AM	0	0	0	0	0
	8:30 AM	0	0	0	0	0
	8:45 AM	0	0	0	0	0
TOTAL	0	0	0	0	0	
AM BEGIN PEAK HR	7:30 AM					
PM	4:00 PM	0	0	0	0	0
	4:15 PM	0	0	0	0	0
	4:30 PM	0	0	0	0	0
	4:45 PM	0	0	0	0	0
	5:00 PM	0	0	0	0	0
	5:15 PM	0	0	0	0	0
	5:30 PM	0	0	0	0	0
	5:45 PM	0	0	0	0	0
TOTAL	0	0	0	0	0	
PM BEGIN PEAK HR	4:45 PM					

PEDESTRIAN + BIKE CROSSINGS				
N SIDE	S SIDE	E SIDE	W SIDE	TOTAL
0	0	0	0	0
0	0	0	0	0
0	0	0	0	0
0	0	0	0	0
0	0	0	0	0
0	0	0	0	0
0	0	0	0	0
0	0	0	0	0
0	0	0	0	0
0	0	0	0	0
0	0	0	0	0
0	0	0	0	0
0	0	0	0	0
0	0	0	0	0
0	0	0	0	0

PEDESTRIAN CROSSINGS				
N SIDE	S SIDE	E SIDE	W SIDE	TOTAL
0	0	0	0	0
0	0	0	0	0
0	0	0	0	0
0	0	0	0	0
0	0	0	0	0
0	0	0	0	0
0	0	0	0	0
0	0	0	0	0
0	0	0	0	0
0	0	0	0	0
0	0	0	0	0
0	0	0	0	0
0	0	0	0	0
0	0	0	0	0
0	0	0	0	0

BICYCLE CROSSINGS				
NS	SS	ES	WS	TOTAL
0	0	0	0	0
0	0	0	0	0
0	0	0	0	0
0	0	0	0	0
0	0	0	0	0
0	0	0	0	0
0	0	0	0	0
0	0	0	0	0
0	0	0	0	0
0	0	0	0	0
0	0	0	0	0
0	0	0	0	0
0	0	0	0	0
0	0	0	0	0

INTERSECTION TURNING MOVEMENT COUNTS

PREPARED BY: AimTD LLC. tel: 714 253 7888 pacific@aimtd.com

DATE:
Wed, Feb 10, 16

LOCATION:
NORTH & SOUTH: Santa Ana
EAST & WEST: Newhope
Hazard

PROJECT #: SC0846
LOCATION #: 11
CONTROL: SIGNAL

NOTES:	AM		▲	
	PM		N	
	MD	◀ W	S	E ▶
	OTHER		▼	

Add U-Turns to Left Turns

	NORTHBOUND			SOUTHBOUND			EASTBOUND			WESTBOUND			TOTAL		
	Newhope			Newhope			Hazard			Hazard					
	NL	NT	NR	SL	ST	SR	EL	ET	ER	WL	WT	WR			
LANES:	1	2	0	1	2	0	1	2	0	1	2	0			
7:00 AM	10	146	6	7	257	4	13	28	16	4	15	9	515		
7:15 AM	15	178	15	15	352	21	10	36	28	8	39	9	726		
7:30 AM	24	190	22	21	308	31	19	50	25	17	39	13	759		
7:45 AM	40	165	48	37	281	41	26	57	59	10	45	19	828		
8:00 AM	15	176	15	14	347	25	19	48	29	14	40	24	766		
8:15 AM	20	174	4	17	316	16	30	59	22	1	23	11	693		
8:30 AM	13	163	3	17	322	23	22	48	24	9	32	10	686		
8:45 AM	29	161	11	9	282	13	24	32	26	4	29	12	632		
VOLUMES	166	1,353	124	137	2,465	174	163	358	229	67	262	107	5,605		
APPROACH %	10%	82%	8%	5%	89%	6%	22%	48%	31%	15%	60%	25%			
APP/DEPART	1,643	/	1,623	2,776	/	2,761	750	/	619	436	/	602	0		
BEGIN PEAK HR	7:15 AM														
VOLUMES	94	709	100	87	1,288	118	74	191	141	49	163	65	3,079		
APPROACH %	10%	79%	11%	6%	86%	8%	18%	47%	35%	18%	59%	23%			
PEAK HR FACTOR	0.892			0.962			0.715			0.888			0.930		
APP/DEPART	903	/	848	1,493	/	1,478	406	/	378	277	/	375	0		
4:00 PM	20	292	8	11	223	24	24	30	18	3	42	38	733		
4:15 PM	18	304	12	16	194	17	27	35	17	10	30	37	717		
4:30 PM	21	340	12	10	199	27	29	49	14	6	41	13	761		
4:45 PM	27	299	18	13	193	19	24	51	23	8	59	12	746		
5:00 PM	22	315	9	15	267	35	19	48	29	10	52	7	828		
5:15 PM	31	298	7	9	252	31	29	49	29	5	54	19	813		
5:30 PM	28	294	15	14	251	26	29	56	37	12	37	13	812		
5:45 PM	30	324	17	9	227	27	26	52	30	3	51	16	812		
VOLUMES	197	2,466	98	97	1,806	206	207	370	197	57	366	155	6,222		
APPROACH %	7%	89%	4%	5%	86%	10%	27%	48%	25%	10%	63%	27%			
APP/DEPART	2,761	/	2,828	2,109	/	2,060	774	/	565	578	/	769	0		
BEGIN PEAK HR	5:00 PM														
VOLUMES	111	1,231	48	47	997	119	103	205	125	30	194	55	3,265		
APPROACH %	8%	89%	3%	4%	86%	10%	24%	47%	29%	11%	70%	20%			
PEAK HR FACTOR	0.937			0.917			0.887			0.894			0.986		
APP/DEPART	1,390	/	1,389	1,163	/	1,152	433	/	300	279	/	424	0		

U-TURNS				
NB	SB	EB	WB	TTL
0	0	0	0	0
0	0	0	0	0
0	0	0	0	0
0	0	0	0	0
0	0	0	0	0
0	0	0	0	0
0	0	0	0	0
0	0	0	0	0
0	0	0	0	0
0	0	0	0	0

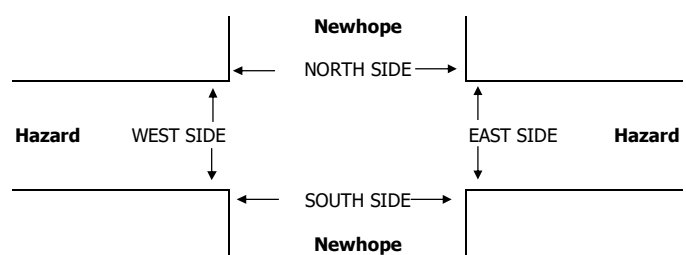

	AM	PM
7:00 AM		
7:15 AM		
7:30 AM		
7:45 AM		
8:00 AM		
8:15 AM		
8:30 AM		
8:45 AM		
TOTAL		
4:00 PM		
4:15 PM		
4:30 PM		
4:45 PM		
5:00 PM		
5:15 PM		
5:30 PM		
5:45 PM		
TOTAL		

PEDESTRIAN + BIKE CROSSINGS				
N SIDE	S SIDE	E SIDE	W SIDE	TOTAL
1	1	1	0	3
2	3	1	0	6
4	3	5	0	12
1	3	8	2	14
1	12	8	0	21
1	6	7	4	18
14	6	5	0	25
1	12	2	0	15
TOTAL	25	46	37	114
1	0	3	2	6
1	2	1	3	7
4	0	2	4	10
3	0	0	5	8
0	2	4	1	7
2	3	5	2	12
1	4	2	1	8
2	2	2	2	8
TOTAL	14	13	19	66

PEDESTRIAN CROSSINGS				
N SIDE	S SIDE	E SIDE	W SIDE	TOTAL
0	0	0	0	0
1	2	1	0	4
4	3	4	0	11
1	3	6	1	11
1	11	5	0	17
0	6	5	2	13
14	6	4	0	24
1	12	1	0	14
TOTAL	22	43	26	94
0	0	3	2	5
0	0	0	0	0
4	0	1	3	8
3	0	0	3	6
0	1	4	0	5
1	2	2	0	5
0	2	1	0	3
2	1	1	0	4
TOTAL	10	6	12	36

BICYCLE CROSSINGS					
NS	SS	ES	WS	TOTAL	
1	1	1	0	3	
1	1	0	0	2	
0	0	1	0	1	
0	0	2	1	3	
0	1	3	0	4	
1	0	2	2	5	
0	0	1	0	1	
0	0	1	0	1	
TOTAL	3	3	11	3	20
1	0	0	0	1	
1	2	1	3	7	
0	0	1	1	2	
0	0	0	2	2	
0	1	0	1	2	
1	1	3	2	7	
1	2	1	1	5	
0	1	1	2	4	
TOTAL	4	7	7	12	30

INTERSECTION TURNING MOVEMENT COUNTS

PREPARED BY: AimTD LLC. tel: 714 253 7888 pacific@aimtd.com

DATE:
Wed, Feb 10, 16

LOCATION:
NORTH & SOUTH:
EAST & WEST:

Santa Ana
Newhope
McFadden

PROJECT #: SC0846
LOCATION #: 31
CONTROL: SIGNAL

NOTES:	AM		▲	
	PM		N	
	MD	◀	W	E ▶
	OTHER		S	
	OTHER		▼	

Add U-Turns to Left Turns

LANES:	NORTHBOUND Newhope			SOUTHBOUND Newhope			EASTBOUND McFadden			WESTBOUND McFadden			TOTAL	U-TURNS				
	NL	NT	NR	SL	ST	SR	EL	ET	ER	WL	WT	WR		NB	SB	EB	WB	TTL
7:00 AM	5	97	11	18	281	11	10	54	17	11	67	21	603	0	0	0	0	0
7:15 AM	14	91	15	22	301	19	8	73	38	17	72	17	687	0	0	0	0	0
7:30 AM	17	94	28	18	318	17	33	113	37	37	112	22	846	0	0	0	0	0
7:45 AM	38	110	45	29	247	20	24	102	43	49	110	34	851	0	0	0	0	0
8:00 AM	31	144	60	31	249	37	52	129	38	53	133	22	979	0	0	0	0	0
8:15 AM	19	123	33	36	322	31	20	128	35	30	76	18	871	0	0	0	0	0
8:30 AM	9	127	28	22	291	17	25	108	30	35	88	25	805	0	0	0	0	0
8:45 AM	23	162	38	26	355	23	10	83	21	40	61	31	873	0	0	0	0	0
VOLUMES	156	948	258	202	2,364	175	182	790	259	272	719	190	6,515	0	0	0	0	0
APPROACH %	11%	70%	19%	7%	86%	6%	15%	64%	21%	23%	61%	16%						
APP/DEPART	1,362	/	1,320	2,741	/	2,895	1,231	/	1,250	1,181	/	1,050	0					
BEGIN PEAK HR	7:30 AM																	
VOLUMES	105	471	166	114	1,136	105	129	472	153	169	431	96	3,547					
APPROACH %	14%	63%	22%	8%	84%	8%	17%	63%	20%	24%	62%	14%						
PEAK HR FACTOR	0.789			0.871			0.861			0.837			0.906					
APP/DEPART	742	/	696	1,355	/	1,458	754	/	752	696	/	641	0					
4:00 PM	37	275	38	37	140	30	15	103	11	35	104	51	876	0	0	0	0	0
4:15 PM	26	283	41	37	158	26	22	118	17	27	99	40	894	0	0	0	0	0
4:30 PM	35	278	42	30	134	31	11	104	13	31	103	38	850	0	0	0	0	0
4:45 PM	42	274	39	22	146	18	11	106	16	26	130	46	876	0	0	0	0	0
5:00 PM	43	262	42	26	158	32	26	110	18	25	138	39	919	0	0	0	0	0
5:15 PM	52	260	53	37	169	40	19	108	11	24	135	39	947	0	0	0	0	0
5:30 PM	50	245	42	48	191	36	20	122	23	32	138	39	986	0	0	0	0	0
5:45 PM	49	274	45	46	186	28	12	136	17	21	155	44	1,013	0	0	0	0	0
VOLUMES	334	2,151	342	283	1,282	241	136	907	126	221	1,002	336	7,361					
APPROACH %	12%	76%	12%	16%	71%	13%	12%	78%	11%	14%	64%	22%						
APP/DEPART	2,827	/	2,623	1,806	/	1,629	1,169	/	1,532	1,559	/	1,577	0					
BEGIN PEAK HR	5:00 PM																	
VOLUMES	194	1,041	182	157	704	136	77	476	69	102	566	161	3,865					
APPROACH %	14%	73%	13%	16%	71%	14%	12%	77%	11%	12%	68%	19%						
PEAK HR FACTOR	0.963			0.906			0.942			0.942			0.954					
APP/DEPART	1,417	/	1,279	997	/	875	622	/	815	829	/	896	0					

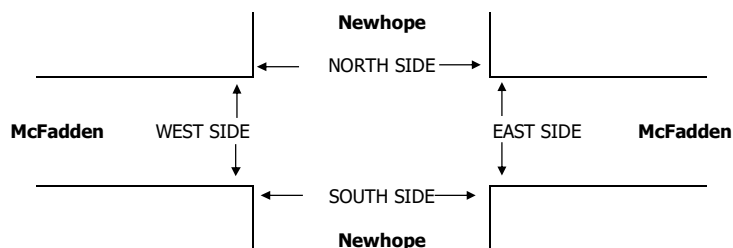

	PEDESTRIAN + BIKE CROSSINGS				
	N SIDE	S SIDE	E SIDE	W SIDE	TOTAL
7:00 AM	1	5	4	0	10
7:15 AM	4	4	7	0	15
7:30 AM	4	24	19	1	48
7:45 AM	13	17	20	32	82
8:00 AM	36	57	47	40	180
8:15 AM	11	30	34	17	92
8:30 AM	5	7	19	4	35
8:45 AM	3	3	14	0	20
TOTAL	77	147	164	94	482

	PEDESTRIAN CROSSINGS				
	N SIDE	S SIDE	E SIDE	W SIDE	TOTAL
7:00 AM	1	4	3	0	8
7:15 AM	1	2	6	0	9
7:30 AM	3	21	18	0	42
7:45 AM	13	16	19	31	79
8:00 AM	35	55	43	38	171
8:15 AM	9	30	32	15	86
8:30 AM	5	6	17	3	31
8:45 AM	3	2	13	0	18
TOTAL	70	136	151	87	444

	BICYCLE CROSSINGS				
	NS	SS	ES	WS	TOTAL
7:00 AM	0	1	1	0	2
7:15 AM	3	2	1	0	6
7:30 AM	1	3	1	1	6
7:45 AM	0	1	1	1	3
8:00 AM	1	2	4	2	9
8:15 AM	2	0	2	2	6
8:30 AM	0	1	2	1	4
8:45 AM	0	1	1	0	2
TOTAL	7	11	13	7	38

	PEDESTRIAN + BIKE CROSSINGS				
	N SIDE	S SIDE	E SIDE	W SIDE	TOTAL
4:00 PM	2	2	5	4	13
4:15 PM	4	6	10	6	26
4:30 PM	2	6	1	2	11
4:45 PM	10	17	4	8	39
5:00 PM	15	9	4	4	32
5:15 PM	4	7	8	4	23
5:30 PM	7	4	5	5	21
5:45 PM	5	5	6	1	17
TOTAL	49	56	43	34	182

ITM Peak Hour Summary

Prepared by:



National Data & Surveying Services

Harbor Blvd and Banner Dr., Garden Grove

Date: 2014-10-16

Day: Thursday

Project #: Historical

City: Garden Grove

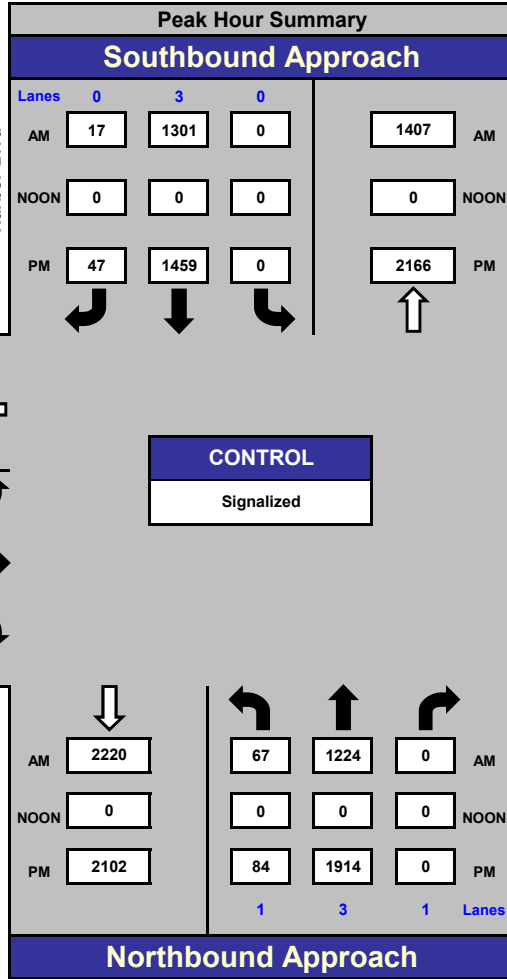

AM Peak Hour	715 AM
NOON Peak Hour	
PM Peak Hour	500 PM

Count Periods	Start	End
AM	7:00 AM	9:00 AM
NOON		
PM	4:00 PM	6:00 PM

Total Ins & Outs

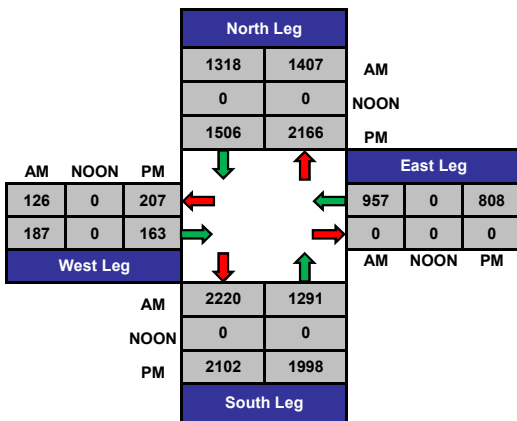

Total Volume Per Leg

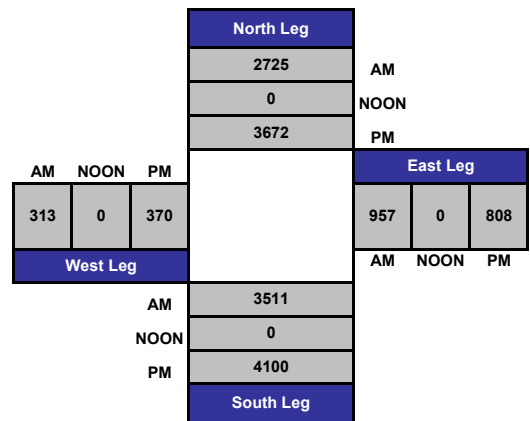

ITM Peak Hour Summary

Prepared by:



National Data & Surveying Services

SR-22 EB On-Ramp and Trask Ave., City of Santa Ana

Date: 2013-02-05

Day: Tuesday

Project #: Historical



Trask Ave

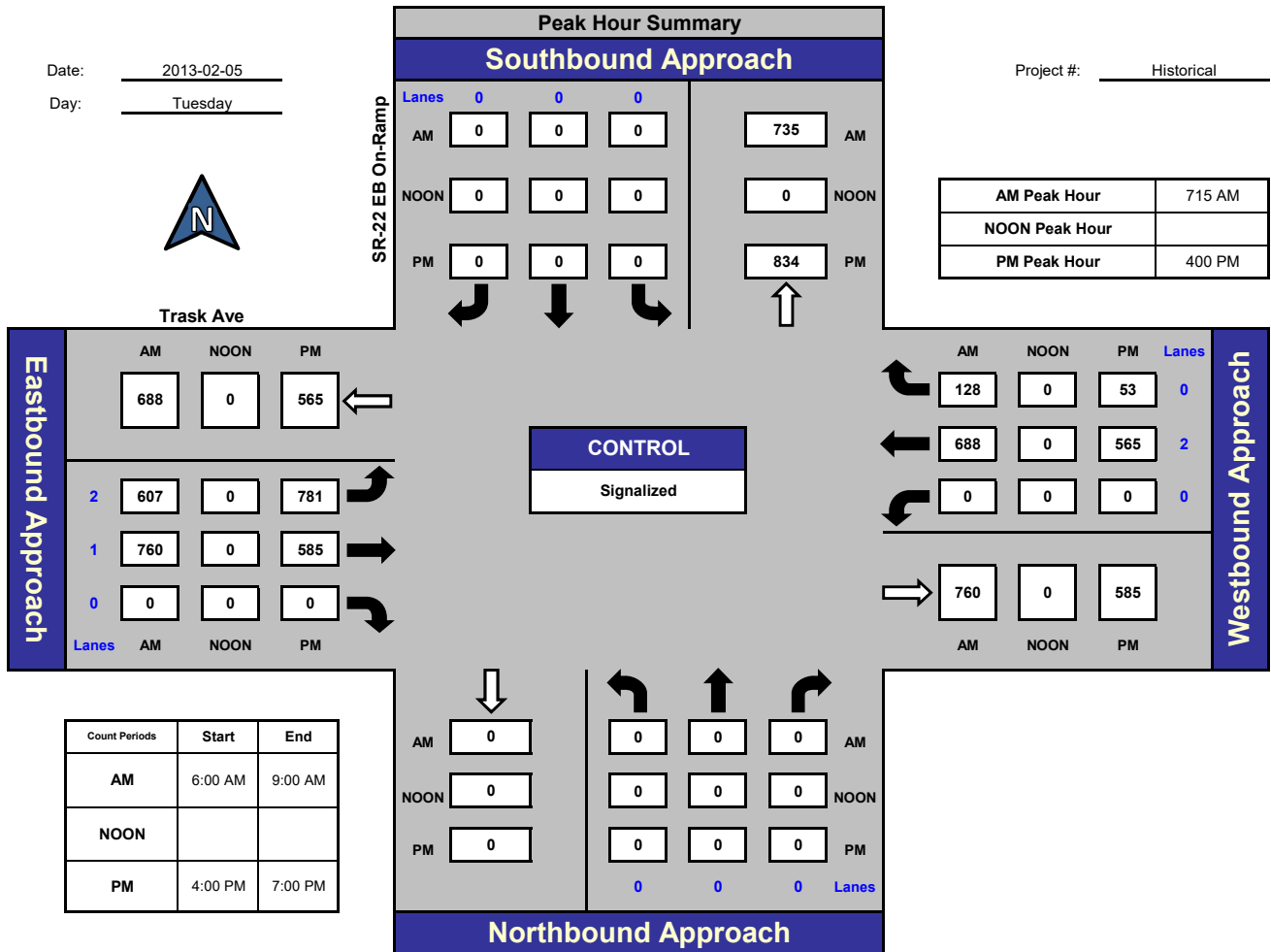

Total Ins & Outs

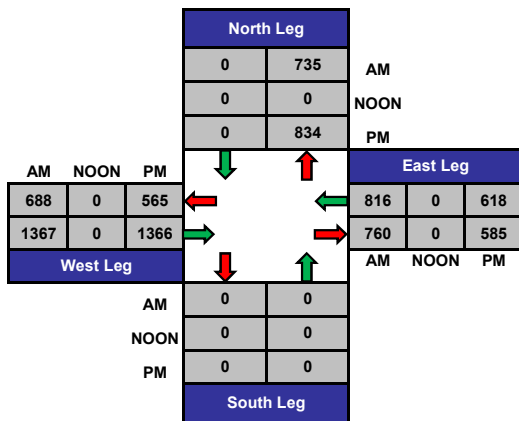

Total Volume Per Leg

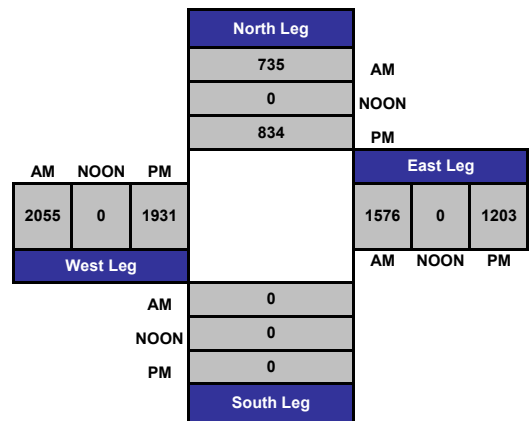

INTERSECTION TURNING MOVEMENT COUNTS

PREPARED BY: AimTD LLC. tel: 714 253 7888 cs@aimtd.com

DATE:
Thu, May 16, 19

LOCATION:
NORTH & SOUTH: Santa Ana Harbor
EAST & WEST: Westminster

PROJECT #: SC2183
LOCATION #: 3
CONTROL: SIGNAL

NOTES:

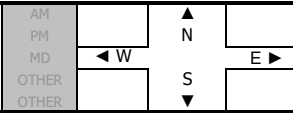

Add U-Turns to Left Turns

LANES:	NORTHBOUND			SOUTHBOUND			EASTBOUND			WESTBOUND			TOTAL
	Harbor			Harbor			Westminster			Westminster			
	NL	NT	NR	SL	ST	SR	EL	ET	ER	WL	WT	WR	
	1	3	1	1	3	1	1	3	0	1	3	1	

U-TURNS				
NB	SB	EB	WB	TTL
0	0	0	0	

AM	NORTHBOUND			SOUTHBOUND			EASTBOUND			WESTBOUND			TOTAL	
	NL	NT	NR	SL	ST	SR	EL	ET	ER	WL	WT	WR		
7:00 AM	40	258	41	40	419	20	24	160	3	51	91	25	1,172	
7:15 AM	28	298	43	43	428	13	23	214	6	50	115	32	1,293	
7:30 AM	41	336	67	56	439	24	36	237	10	61	156	33	1,496	
7:45 AM	49	299	74	56	391	22	43	236	2	52	156	38	1,418	
8:00 AM	48	288	55	55	390	28	43	234	9	48	138	45	1,381	
8:15 AM	38	238	52	42	426	20	52	210	11	48	118	38	1,293	
8:30 AM	52	282	41	56	383	36	55	182	8	40	113	35	1,283	
8:45 AM	44	234	24	35	340	34	37	145	8	48	103	48	1,100	
VOLUMES	340	2,233	397	383	3,216	197	313	1,618	57	398	990	294	10,436	
APPROACH %	11%	75%	13%	10%	85%	5%	16%	81%	3%	24%	59%	17%		
APP/DEPART	2,970	/	2,811	3,796	/	3,697	1,988	/	2,402	1,682	/	1,526	0	
BEGIN PEAK HR	7:30 AM													
VOLUMES	176	1,161	248	209	1,646	94	174	917	32	209	568	154	5,588	
APPROACH %	11%	73%	16%	11%	84%	5%	15%	82%	3%	22%	61%	17%		
PEAK HR FACTOR	0.892			0.939			0.982			0.931			0.934	
APP/DEPART	1,585	/	1,471	1,949	/	1,898	1,123	/	1,375	931	/	844	0	
PM	4:00 PM	59	331	66	47	345	48	60	170	4	63	171	50	1,414
	4:15 PM	60	331	46	44	321	37	45	136	8	54	180	48	1,310
	4:30 PM	63	336	70	58	299	46	45	127	11	62	181	46	1,344
	4:45 PM	50	363	72	48	320	41	47	153	14	59	204	49	1,420
	5:00 PM	69	341	65	48	370	40	49	142	3	57	194	52	1,430
	5:15 PM	69	320	84	55	369	39	49	177	10	59	216	42	1,489
	5:30 PM	85	336	100	53	356	43	40	188	4	52	175	36	1,468
	5:45 PM	70	337	77	57	340	31	39	170	7	50	173	38	1,389
	VOLUMES	525	2,695	580	410	2,720	325	374	1,263	61	456	1,494	361	11,264
	APPROACH %	14%	71%	15%	12%	79%	9%	22%	74%	4%	20%	65%	16%	
APP/DEPART	3,800	/	3,378	3,455	/	3,258	1,698	/	2,270	2,311	/	2,358	0	
BEGIN PEAK HR	4:45 PM													
VOLUMES	273	1,360	321	204	1,415	163	185	660	31	227	789	179	5,807	
APPROACH %	14%	70%	16%	11%	79%	9%	21%	75%	4%	19%	66%	15%		
PEAK HR FACTOR	0.938			0.962			0.928			0.942			0.975	
APP/DEPART	1,954	/	1,704	1,782	/	1,693	876	/	1,180	1,195	/	1,230	0	

7	3	3	4	17
5	3	4	6	18
6	4	8	7	25
9	8	10	5	32
9	4	9	5	27
10	6	13	6	35
13	8	14	5	40
9	2	6	4	21
68	38	67	42	215

9	3	13	8	33
6	2	9	6	23
6	2	7	12	27
8	7	9	5	29
10	4	10	4	28
9	7	13	7	36
12	6	12	3	33
10	1	11	4	26
70	32	84	49	235

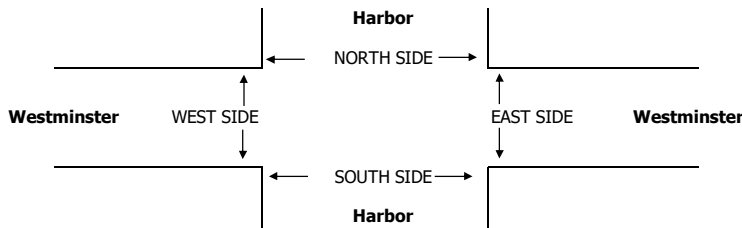

AM	PEDESTRIAN + BIKE CROSSINGS				
	N SIDE	S SIDE	E SIDE	W SIDE	TOTAL
7:00 AM	0	0	0	0	0
7:15 AM	0	0	0	0	0
7:30 AM	0	0	0	0	0
7:45 AM	0	0	0	0	0
8:00 AM	0	0	0	0	0
8:15 AM	0	0	0	0	0
8:30 AM	0	0	0	0	0
8:45 AM	0	0	0	0	0
TOTAL	0	0	0	0	0
PM	7:30 AM				
	4:00 PM	0	0	0	0
	4:15 PM	0	0	0	0
	4:30 PM	0	0	0	0
	4:45 PM	0	0	0	0
	5:00 PM	0	0	0	0
	5:15 PM	0	0	0	0
	5:30 PM	0	0	0	0
	5:45 PM	0	0	0	0
TOTAL	0	0	0	0	
4:45 PM					
PM BEGIN PEAK HR	0	0	0	0	0

AM	PEDESTRIAN CROSSINGS				
	N SIDE	S SIDE	E SIDE	W SIDE	TOTAL
7:00 AM	0	0	0	0	0
7:15 AM	0	0	0	0	0
7:30 AM	0	0	0	0	0
7:45 AM	0	0	0	0	0
8:00 AM	0	0	0	0	0
8:15 AM	0	0	0	0	0
8:30 AM	0	0	0	0	0
8:45 AM	0	0	0	0	0
TOTAL	0	0	0	0	0
PM	7:30 AM				
	4:00 PM	0	0	0	0
	4:15 PM	0	0	0	0
	4:30 PM	0	0	0	0
	4:45 PM	0	0	0	0
	5:00 PM	0	0	0	0
	5:15 PM	0	0	0	0
	5:30 PM	0	0	0	0
	5:45 PM	0	0	0	0
TOTAL	0	0	0	0	
4:45 PM					
PM BEGIN PEAK HR	0	0	0	0	0

AM	BICYCLE CROSSINGS				
	NS	SS	ES	WS	TOTAL
7:00 AM	0	0	0	0	0
7:15 AM	0	0	0	0	0
7:30 AM	0	0	0	0	0
7:45 AM	0	0	0	0	0
8:00 AM	0	0	0	0	0
8:15 AM	0	0	0	0	0
8:30 AM	0	0	0	0	0
8:45 AM	0	0	0	0	0
TOTAL	0	0	0	0	0
PM	7:30 AM				
	4:00 PM	0	0	0	0
	4:15 PM	0	0	0	0
	4:30 PM	0	0	0	0
	4:45 PM	0	0	0	0
	5:00 PM	0	0	0	0
	5:15 PM	0	0	0	0
	5:30 PM	0	0	0	0
	5:45 PM	0	0	0	0
TOTAL	0	0	0	0	
4:45 PM					
PM BEGIN PEAK HR	0	0	0	0	0

INTERSECTION TURNING MOVEMENT COUNTS AVERAGE SHEET

PREPARED BY: AimTD LLC. tel: 714 253 7888 cs@aimtd.com

DATE: AVERAGE FOR THREE DAYS
 LOCATION: NORTH & SOUTH: Santa Ana Harbor 1st
 EAST & WEST: 1st
 PROJECT #: CMP2019
 LOCATION #: 190
 CONTROL: SIGNAL



LANES:	NORTHBOUND			SOUTHBOUND			EASTBOUND			WESTBOUND			TOTAL
	NL 1	NT 3	NR 1	SL 1	ST 3	SR 1	EL 2	ET 3	ER 0	WL 2	WT 3	WR 0	
6:00 AM	11	108	14	18	225	11	21	67	22	11	54	21	583
6:15 AM	10	125	22	25	289	11	19	108	34	23	78	30	775
6:30 AM	13	143	22	37	451	15	20	137	33	22	93	30	1,015
6:45 AM	23	148	20	53	452	15	23	186	36	33	92	30	1,109
7:00 AM	19	156	32	53	487	20	23	207	42	36	93	35	1,203
7:15 AM	22	227	45	53	493	25	26	230	40	56	115	38	1,371
7:30 AM	19	237	61	53	510	26	30	229	47	78	149	36	1,478
7:45 AM	27	228	52	51	445	38	32	224	44	60	188	37	1,428
8:00 AM	24	232	42	60	446	32	37	239	47	47	162	31	1,400
8:15 AM	28	200	38	58	428	20	37	264	56	48	118	32	1,327
8:30 AM	24	184	35	53	439	24	33	253	38	37	115	36	1,270
8:45 AM	32	177	34	41	408	22	35	213	40	36	128	32	1,197
VOLUMES	254	2,165	416	554	5,073	259	338	2,355	480	486	1,385	388	14,272
APPROACH %	9%	75%	14%	9%	86%	4%	11%	73%	15%	22%	61%	17%	
APP/DEPART	2,898	/	2,914	5,910	/	6,102	3,205	/	3,326	2,259	/	1,930	
BEGIN PEAK HR	115	7:15 AM 925	200	224	1,895	122	138	922	179	242	614	143	5,717
APPROACH %	9%	75%	16%	10%	85%	5%	11%	74%	14%	24%	61%	14%	
PEAK HR FACTOR		0.958			0.948			0.950			0.875		0.960
APP/DEPART	1,239	/	1,200	2,240	/	2,337	1,238	/	1,339	999	/	840	

U-TURNS				
NB	SB	EB	WB	TTL
0	0	0	0	0
2	2	0	0	4
2	1	0	0	3
3	2	1	0	6
4	2	3	0	8
4	0	3	0	7
5	1	2	0	8
6	1	4	0	10
5	1	4	0	10
6	3	2	0	12
8	3	2	0	14
9	3	7	0	19
8	4	3	0	16
62	23	32	0	117

Right-turn Overlap			
NRR	SRR	ERR	WRR
0	0	0	0
0	0	0	0
0	0	0	0
0	0	0	0
0	0	0	0
0	0	0	0
0	0	0	0
0	0	0	0
0	0	0	0
0	0	0	0
0	0	0	0
0	0	0	0
0	0	0	0
0	0	0	0

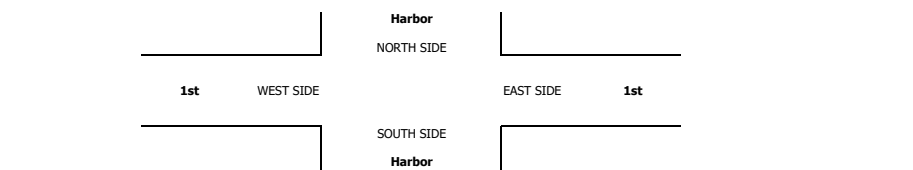

7	5	5	0	17
4	10	5	0	19
7	7	4	0	18
3	6	4	0	13
5	7	7	0	19
6	7	5	0	18
8	6	6	0	21
6	6	5	0	17
8	5	8	0	21
7	4	10	0	20
6	6	11	0	23
7	7	5	0	19
9	5	7	0	20
5	6	7	0	18
9	3	5	0	17
8	5	6	0	19
106	94	99	1	299

0	0	0	0	0
0	0	0	0	0
0	0	0	0	0
0	0	0	0	0
0	0	0	0	0
0	0	0	0	0
0	0	0	0	0
0	0	0	0	0
0	0	0	0	0
0	0	0	0	0
0	0	0	0	0
0	0	0	0	0
0	0	0	0	0
0	0	0	0	0
0	0	0	0	0
0	0	0	0	0

AM
6:00 AM
6:15 AM
6:30 AM
6:45 AM
7:00 AM
7:15 AM
7:30 AM
7:45 AM
8:00 AM
8:15 AM
8:30 AM
8:45 AM
TOTAL
AM BEGIN PEAK HR
3:00 PM
3:15 PM
3:30 PM
3:45 PM
4:00 PM
4:15 PM
4:30 PM
4:45 PM
5:00 PM
5:15 PM
5:30 PM
5:45 PM
6:00 PM
6:15 PM
6:30 PM
6:45 PM
TOTAL
PM BEGIN PEAK HR

ALL PED AND BIKE				
N SIDE	S SIDE	E SIDE	W SIDE	TOTAL
4	19	4	12	38
1	14	3	10	28
2	17	2	12	33
3	19	4	16	42
5	19	7	11	42
7	25	11	30	74
6	28	9	29	72
5	21	6	18	51
5	18	4	17	45
7	16	7	17	47
8	16	4	13	41
8	22	9	17	55
63	234	71	201	568
7:15 AM				
9	26	3	23	62
16	35	13	25	90
15	23	8	28	73
14	29	9	28	80
13	27	10	28	78
13	33	5	25	77
18	20	10	24	72
13	27	7	22	69
7	26	3	26	62
11	33	7	27	78
12	18	7	19	56
13	29	9	29	81
16	19	10	25	70
10	23	7	22	62
10	18	3	18	49
7	21	4	19	52
197	408	116	390	1,110
5:00 PM				

PEDESTRIAN CROSSINGS				
N SIDE	S SIDE	E SIDE	W SIDE	TOTAL
3	17	4	10	34
1	12	2	10	25
2	15	2	11	30
2	17	3	14	36
4	17	6	9	36
7	24	11	28	71
6	26	8	26	66
3	19	6	17	45
5	16	4	15	39
5	14	6	15	40
5	14	4	12	34
6	19	8	15	47
48	210	64	181	503
7:15 AM				
7	23	3	22	55
15	34	12	25	86
13	22	7	25	67
12	27	8	27	74
11	24	8	24	67
12	32	4	24	72
18	18	10	22	66
12	25	6	19	62
4	24	3	23	55
10	29	5	25	69
10	16	5	17	49
11	26	9	25	70
14	17	9	24	64
8	18	7	19	52
8	16	2	13	40
6	18	4	18	46
170	370	102	352	994
5:00 PM				
35	95	22	91	243

BICYCLE CROSSINGS				
NS	SS	ES	WS	TOTAL
1	1	0	2	5
0	2	1	0	3
0	2	0	1	3
1	2	1	3	6
1	2	0	2	5
0	1	0	2	3
1	2	1	3	7
2	2	1	1	6
0	3	0	2	6
2	2	1	1	6
3	2	1	1	7
2	3	1	1	8
15	24	7	20	65
7:15 AM				
2	3	0	2	7
1	1	1	0	4
1	2	0	3	6
3	1	1	1	6
2	3	2	4	11
1	2	1	1	5
2	1	1	2	6
2	1	1	3	7
1	4	2	2	9
2	2	2	1	7
3	3	1	4	11
1	2	1	1	6
1	5	0	4	10
1	2	1	5	9
1	3	0	2	6
27	38	13	38	116
5:00 PM				
8	11	5	10	34

INTERSECTION TURNING MOVEMENT COUNTS

PREPARED BY: AimTD LLC. tel: 714 253 7888 pacific@aimtd.com

DATE:
Wed, Feb 10, 16

LOCATION:
NORTH & SOUTH: Santa Ana Harbor
EAST & WEST: McFadden

PROJECT #: SC0846
LOCATION #: 32
CONTROL: SIGNAL

NOTES:	AM PM MD OTHER OTHER	◀ W E ▶	▲ N S ▼	
--------	----------------------------------	------------	------------	--

Add U-Turns to Left Turns

LANES:	NORTHBOUND			SOUTHBOUND			EASTBOUND			WESTBOUND			TOTAL
	NL	NT	NR	SL	ST	SR	EL	ET	ER	WL	WT	WR	

U-TURNS				
NB	SB	EB	WB	TTL

AM	7:00 AM	21	170	13	33	480	10	31	54	24	35	57	17	945
	7:15 AM	20	214	17	34	533	10	24	67	18	45	74	21	1,077
	7:30 AM	19	238	18	26	536	15	36	95	27	51	102	27	1,190
	7:45 AM	25	260	34	45	488	12	39	94	30	48	117	30	1,222
	8:00 AM	32	250	25	55	425	22	47	102	36	44	110	33	1,181
	8:15 AM	23	269	20	48	395	12	38	127	31	39	84	28	1,114
	8:30 AM	21	245	30	71	407	26	36	95	27	47	85	18	1,108
	8:45 AM	15	198	28	47	456	15	21	96	30	47	76	23	1,052
	VOLUMES	176	1,844	185	359	3,720	122	272	730	223	356	705	197	8,889
	APPROACH %	8%	84%	8%	9%	89%	3%	22%	60%	18%	28%	56%	16%	
APP/DEPART	2,205	/	2,378	4,201	/	4,340	1,225	/	1,209	1,258	/	962	0	
BEGIN PEAK HR	7:30 AM													
VOLUMES	99	1,017	97	174	1,844	61	160	418	124	182	413	118	4,707	
APPROACH %	8%	84%	8%	8%	89%	3%	23%	60%	18%	26%	58%	17%		
PEAK HR FACTOR	0.951			0.901			0.895			0.914			0.963	
APP/DEPART	1,213	/	1,321	2,079	/	2,168	702	/	663	713	/	555	0	
PM	4:00 PM	51	346	34	67	266	22	34	135	19	44	109	47	1,174
	4:15 PM	35	416	33	67	277	30	50	130	18	53	125	29	1,263
	4:30 PM	35	421	36	62	284	24	43	122	22	50	99	26	1,224
	4:45 PM	38	405	36	74	317	29	46	115	14	44	117	31	1,266
	5:00 PM	35	425	27	74	286	27	50	117	11	49	121	40	1,262
	5:15 PM	38	429	29	71	305	15	56	129	15	52	125	38	1,302
	5:30 PM	47	411	34	66	300	32	52	127	20	48	134	35	1,306
	5:45 PM	40	384	30	75	332	36	47	126	16	53	106	27	1,272
	VOLUMES	319	3,237	259	556	2,367	215	378	1,001	135	393	936	273	10,069
	APPROACH %	8%	85%	7%	18%	75%	7%	25%	66%	9%	25%	58%	17%	
APP/DEPART	3,815	/	3,989	3,138	/	2,930	1,514	/	1,718	1,602	/	1,432	0	
BEGIN PEAK HR	5:00 PM													
VOLUMES	160	1,649	120	286	1,223	110	205	499	62	202	486	140	5,142	
APPROACH %	8%	85%	6%	18%	76%	7%	27%	65%	8%	24%	59%	17%		
PEAK HR FACTOR	0.972			0.914			0.958			0.954			0.984	
APP/DEPART	1,929	/	2,045	1,619	/	1,506	766	/	855	828	/	736	0	

5	6	0	0	11
3	9	0	0	12
3	4	0	0	7
3	3	0	0	6
5	10	0	0	15
7	9	0	0	16
8	13	0	0	21
7	11	0	0	18
41	65	0	0	106
5	12	0	0	17
5	13	0	1	19
5	11	0	1	17
3	14	0	0	17
6	18	0	0	24
5	13	0	0	18
5	10	0	1	16
4	10	0	0	14
38	101	0	3	142

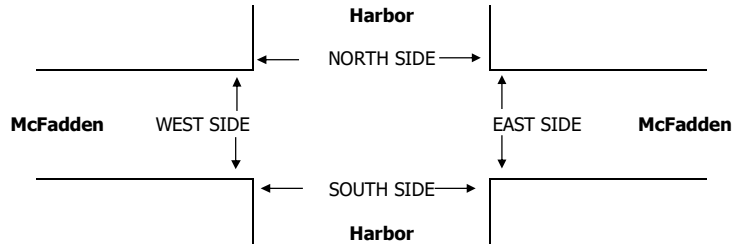

	PEDESTRIAN + BIKE CROSSINGS				
	N SIDE	S SIDE	E SIDE	W SIDE	TOTAL

AM	7:00 AM	3	18	5	4	30
	7:15 AM	8	22	14	6	50
	7:30 AM	11	8	14	9	42
	7:45 AM	16	16	13	8	53
	8:00 AM	14	27	22	13	76
	8:15 AM	12	17	11	12	52
	8:30 AM	9	14	9	6	38
	8:45 AM	20	14	14	10	58
	TOTAL	93	136	102	68	399
	PM	4:00 PM	4	27	15	11
4:15 PM		17	24	33	19	93
4:30 PM		22	27	19	23	91
4:45 PM		22	28	31	19	100
5:00 PM		14	31	21	7	73
5:15 PM		18	32	22	21	93
5:30 PM		19	17	21	16	73
5:45 PM		9	47	18	13	87
TOTAL	125	233	180	129	667	

PEDESTRIAN CROSSINGS				
N SIDE	S SIDE	E SIDE	W SIDE	TOTAL

BICYCLE CROSSINGS				
NS	SS	ES	WS	TOTAL

INTERSECTION TURNING MOVEMENT COUNTS

PREPARED BY: AimTD LLC. tel: 714 253 7888 cs@aimtd.com

DATE:
Tue, May 14, 19

LOCATION:
NORTH & SOUTH: Santa Ana Harbor
EAST & WEST: Edinger Edinger

PROJECT #: SC2183
LOCATION #: 5
CONTROL: SIGNAL

NOTES:

AM	N	E	
PM			
MD			W
OTHER			S

Add U-Turns to Left Turns

LANES:	NORTHBOUND			SOUTHBOUND			EASTBOUND			WESTBOUND			TOTAL
	NL	NT	NR	SL	ST	SR	EL	ET	ER	WL	WT	WR	
	2	3	1	2	3	1	2	2.5	0.5	2	3	1	

U-TURNS				
NB	SB	EB	WB	TTL
0	0	0	0	

AM	7:00 AM	20	139	20	58	478	5	16	144	56	27	90	24	1,077
	7:15 AM	24	159	40	44	513	12	23	165	79	33	118	49	1,259
	7:30 AM	28	202	37	55	538	15	25	147	82	63	120	55	1,367
	7:45 AM	20	226	43	43	552	18	27	138	65	74	125	53	1,384
	8:00 AM	29	177	24	39	481	15	30	187	93	48	123	44	1,290
	8:15 AM	20	149	21	43	530	11	33	150	56	39	101	32	1,185
	8:30 AM	13	164	22	43	489	10	37	129	66	27	105	25	1,130
	8:45 AM	17	148	25	50	477	6	25	117	47	50	98	28	1,088
	VOLUMES	171	1,364	232	375	4,058	92	216	1,177	544	361	880	310	9,780
	APPROACH %	10%	77%	13%	8%	90%	2%	11%	61%	28%	23%	57%	20%	
APP/DEPART	1,767	/	1,912	4,525	/	4,986	1,937	/	1,758	1,551	/	1,124	0	
BEGIN PEAK HR	7:15 AM													
VOLUMES	101	764	144	181	2,084	60	105	637	319	218	486	201	5,300	
APPROACH %	10%	76%	14%	8%	90%	3%	10%	60%	30%	24%	54%	22%		
PEAK HR FACTOR		0.873			0.948			0.856			0.898		0.957	
APP/DEPART	1,009	/	1,077	2,325	/	2,632	1,061	/	953	905	/	638	0	
PM	4:00 PM	58	404	47	60	205	21	41	134	26	47	164	62	1,269
	4:15 PM	52	416	37	74	229	15	31	127	20	40	203	81	1,325
	4:30 PM	68	450	43	73	210	20	36	137	26	30	179	72	1,344
	4:45 PM	65	451	48	63	208	17	35	137	23	25	205	65	1,342
	5:00 PM	66	434	53	66	197	20	32	128	28	31	190	66	1,311
	5:15 PM	83	443	48	77	197	18	33	155	18	44	222	62	1,400
	5:30 PM	65	427	62	74	211	19	32	138	30	38	187	75	1,358
	5:45 PM	63	410	47	82	198	11	22	154	29	48	190	86	1,340
	VOLUMES	520	3,435	385	569	1,655	141	262	1,110	200	303	1,540	569	10,689
	APPROACH %	12%	79%	9%	24%	70%	6%	17%	71%	13%	13%	64%	24%	
APP/DEPART	4,340	/	4,306	2,365	/	2,168	1,572	/	2,000	2,412	/	2,215	0	
BEGIN PEAK HR	4:45 PM													
VOLUMES	279	1,755	211	280	813	74	132	558	99	138	804	268	5,411	
APPROACH %	12%	78%	9%	24%	70%	6%	17%	71%	13%	11%	66%	22%		
PEAK HR FACTOR		0.978			0.960			0.958			0.922		0.966	
APP/DEPART	2,245	/	2,175	1,167	/	1,060	789	/	1,014	1,210	/	1,162	0	

4	4	0	0	8
5	2	2	1	10
5	5	0	0	10
2	4	1	2	9
3	2	3	1	9
6	3	0	0	9
0	4	1	0	5
2	6	1	0	9
27	30	8	4	69

1	5	2	1	9
0	9	1	1	11
1	13	6	1	21
4	4	3	1	12
2	11	7	0	20
4	7	3	0	14
1	14	3	0	18
1	5	3	0	9
14	68	28	4	114

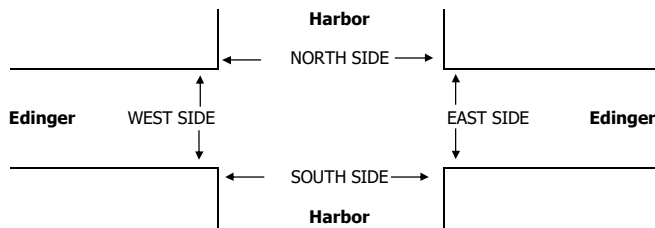

	AM	PEDESTRIAN + BIKE CROSSINGS				
		N SIDE	S SIDE	E SIDE	W SIDE	TOTAL
7:00 AM		0	0	0	0	0
7:15 AM		0	0	0	0	0
7:30 AM		0	0	0	0	0
7:45 AM		0	0	0	0	0
8:00 AM		0	0	0	0	0
8:15 AM		0	0	0	0	0
8:30 AM		0	0	0	0	0
8:45 AM		0	0	0	0	0
TOTAL		0	0	0	0	0
AM BEGIN PEAK HR		7:15 AM				
4:00 PM	PM	0	0	0	0	0
4:15 PM		0	0	0	0	0
4:30 PM		0	0	0	0	0
4:45 PM		0	0	0	0	0
5:00 PM		0	0	0	0	0
5:15 PM		0	0	0	0	0
5:30 PM		0	0	0	0	0
5:45 PM		0	0	0	0	0
TOTAL		0	0	0	0	0
PM BEGIN PEAK HR		4:45 PM				

	AM	PEDESTRIAN CROSSINGS				
		N SIDE	S SIDE	E SIDE	W SIDE	TOTAL
7:00 AM		0	0	0	0	0
7:15 AM		0	0	0	0	0
7:30 AM		0	0	0	0	0
7:45 AM		0	0	0	0	0
8:00 AM		0	0	0	0	0
8:15 AM		0	0	0	0	0
8:30 AM		0	0	0	0	0
8:45 AM		0	0	0	0	0
TOTAL		0	0	0	0	0
AM BEGIN PEAK HR		7:15 AM				
4:00 PM	PM	0	0	0	0	0
4:15 PM		0	0	0	0	0
4:30 PM		0	0	0	0	0
4:45 PM		0	0	0	0	0
5:00 PM		0	0	0	0	0
5:15 PM		0	0	0	0	0
5:30 PM		0	0	0	0	0
5:45 PM		0	0	0	0	0
TOTAL		0	0	0	0	0
PM BEGIN PEAK HR		4:45 PM				

	AM	BICYCLE CROSSINGS				
		NS	SS	ES	WS	TOTAL
7:00 AM		0	0	0	0	0
7:15 AM		0	0	0	0	0
7:30 AM		0	0	0	0	0
7:45 AM		0	0	0	0	0
8:00 AM		0	0	0	0	0
8:15 AM		0	0	0	0	0
8:30 AM		0	0	0	0	0
8:45 AM		0	0	0	0	0
TOTAL		0	0	0	0	0
AM BEGIN PEAK HR		7:15 AM				
4:00 PM	PM	0	0	0	0	0
4:15 PM		0	0	0	0	0
4:30 PM		0	0	0	0	0
4:45 PM		0	0	0	0	0
5:00 PM		0	0	0	0	0
5:15 PM		0	0	0	0	0
5:30 PM		0	0	0	0	0
5:45 PM		0	0	0	0	0
TOTAL		0	0	0	0	0
PM BEGIN PEAK HR		4:45 PM				

	AM	BICYCLE CROSSINGS				
		NS	SS	ES	WS	TOTAL
7:00 AM		0	0	0	0	0
7:15 AM		0	0	0	0	0
7:30 AM		0	0	0	0	0
7:45 AM		0	0	0	0	0
8:00 AM		0	0	0	0	0
8:15 AM		0	0	0	0	0
8:30 AM		0	0	0	0	0
8:45 AM		0	0	0	0	0
TOTAL		0	0	0	0	0
AM BEGIN PEAK HR		7:15 AM				
4:00 PM	PM	0	0	0	0	0
4:15 PM		0	0	0	0	0
4:30 PM		0	0	0	0	0
4:45 PM		0	0	0	0	0
5:00 PM		0	0	0	0	0
5:15 PM		0	0	0	0	0
5:30 PM		0	0	0	0	0
5:45 PM		0	0	0	0	0
TOTAL		0	0	0	0	0
PM BEGIN PEAK HR		4:45 PM				

INTERSECTION TURNING MOVEMENT COUNTS

PREPARED BY: AimTD LLC. tel: 714 253 7888 cs@aimtd.com

DATE:
Tue, Feb 26, 19

LOCATION:
NORTH & SOUTH:
EAST & WEST:

Santa Ana
Harbor
Warner

PROJECT #:
LOCATION #:
CONTROL:

CMP2019
191
SIGNAL

NOTES:

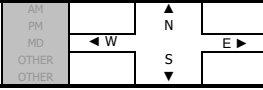

Add U-Turns to Left Turns

	NORTHBOUND			SOUTHBOUND			EASTBOUND			WESTBOUND			TOTAL
	NL	NT	NR	SL	ST	SR	EL	ET	ER	WL	WT	WR	
LANES:	2	3	0	2	3	1	2	3	1	2	3	1	
6:00 AM	10	71	22	50	246	3	2	129	28	26	87	9	683
6:15 AM	15	56	15	47	302	12	9	136	36	40	99	17	784
6:30 AM	19	70	11	95	470	27	7	166	35	35	113	10	1,058
6:45 AM	19	98	24	99	473	22	12	233	58	41	138	14	1,231
7:00 AM	24	132	33	111	491	13	15	272	73	32	121	14	1,331
7:15 AM	25	154	40	117	523	16	24	358	89	31	194	22	1,593
7:30 AM	40	196	40	104	527	32	26	318	106	33	216	30	1,668
7:45 AM	17	163	38	114	509	36	23	350	78	44	210	37	1,619
8:00 AM	31	181	58	117	479	37	23	345	87	41	164	43	1,606
8:15 AM	28	174	54	107	515	29	25	316	69	38	182	23	1,560
8:30 AM	28	141	42	106	476	29	23	280	95	34	162	27	1,443
8:45 AM	27	140	42	83	512	29	17	224	85	24	188	22	1,393
VOLUMES	283	1,576	419	1,150	5,523	285	206	3,127	839	419	1,874	268	15,969
APPROACH %	12%	69%	18%	17%	79%	4%	5%	75%	20%	16%	73%	10%	
APP/DEPART	2,278	/	2,049	6,958	/	6,793	4,172	/	4,727	2,561	/	2,400	0
BEGIN PEAK HR	7:15 AM												
VOLUMES	113	694	176	452	2,038	121	96	1,371	360	149	784	132	6,486
APPROACH %	11%	71%	18%	17%	78%	5%	5%	75%	20%	14%	74%	12%	
PEAK HR FACTOR		0.890			0.985			0.970			0.915		0.972
APP/DEPART	983	/	922	2,611	/	2,549	1,827	/	2,008	1,065	/	1,007	0
03:00 PM	77	408	43	57	185	22	37	238	49	54	250	91	1,511
3:15 PM	67	424	26	53	198	27	51	227	41	44	267	87	1,512
3:30 PM	82	446	34	39	186	30	21	182	53	50	299	106	1,528
3:45 PM	82	422	30	36	207	24	23	221	53	35	350	120	1,603
4:00 PM	101	467	46	28	163	22	12	224	46	45	337	94	1,585
4:15 PM	84	439	40	37	149	19	32	117	49	22	320	94	1,498
4:30 PM	107	446	53	28	179	21	26	197	40	28	326	106	1,557
4:45 PM	90	478	24	47	214	17	43	190	38	29	321	109	1,600
5:00 PM	100	454	28	32	196	28	52	254	50	43	320	122	1,679
5:15 PM	106	472	31	34	193	27	39	237	47	35	342	99	1,662
5:30 PM	104	498	24	30	208	22	19	154	63	26	357	109	1,614
5:45 PM	117	456	29	32	199	22	28	149	43	34	323	90	1,522
6:00 PM	112	438	27	26	175	20	31	197	50	34	308	73	1,491
6:15 PM	123	381	26	36	166	26	28	163	35	23	313	91	1,411
6:30 PM	110	412	26	33	155	31	18	196	29	29	317	53	1,409
6:45 PM	92	349	32	32	153	19	19	165	30	28	229	54	1,202
VOLUMES	1,554	6,990	519	580	2,926	377	479	3,207	716	559	4,979	1,498	24,384
APPROACH %	17%	77%	6%	15%	75%	10%	11%	73%	16%	8%	71%	21%	
APP/DEPART	9,063	/	8,939	3,883	/	4,218	4,402	/	4,326	7,036	/	6,901	0
BEGIN PEAK HR	4:45 PM												
VOLUMES	766	3,676	276	271	1,509	180	238	1,690	386	257	2,673	853	12,775
APPROACH %	16%	78%	6%	14%	77%	9%	10%	73%	17%	7%	71%	23%	
PEAK HR FACTOR		1.884			1.763			1.625			1.922		1.902
APP/DEPART	4,718	/	4,758	1,960	/	2,164	2,314	/	2,239	3,783	/	3,614	0

U-TURNS				
NB	SB	EB	WB	TTL
5	1	0	2	8
3	1	0	5	9
6	0	0	2	8
4	0	0	2	6
9	1	0	6	16
3	1	1	1	6
3	0	0	3	6
5	2	1	3	11
3	0	1	5	9
2	0	2	3	7
1	0	2	3	6
5	0	0	2	7
49	6	7	37	99

Right-turn Overlap			
NRR	SRR	ERR	WRR
0	0	0	0
0	0	0	0
0	0	0	0
0	0	0	0
0	0	0	0
0	0	0	0
0	0	0	0
0	0	0	0
0	0	0	0
0	0	0	0
0	0	0	0
0	0	0	0
0	0	0	0
0	0	0	0
0	0	0	0

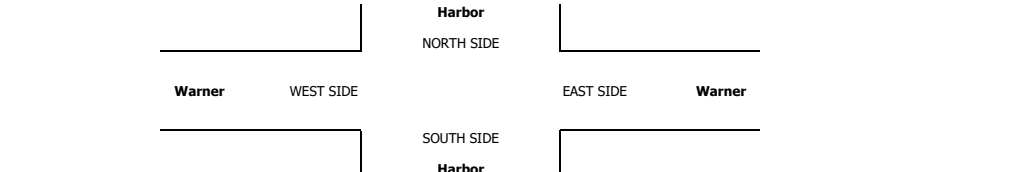

	6:00 AM	6:15 AM	6:30 AM	6:45 AM	7:00 AM	7:15 AM	7:30 AM	7:45 AM	8:00 AM	8:15 AM	8:30 AM	8:45 AM	TOTAL
AM	1	0	1	0	2	3	7	0	8	1	0	9	33
PM	0	0	0	0	0	0	0	0	0	0	0	0	0
TOTAL	1	0	1	0	2	3	7	0	8	1	0	9	33

ALL PED AND BIKE				
N SIDE	S SIDE	E SIDE	W SIDE	TOTAL
1	0	1	0	2
1	1	2	3	7
0	8	1	0	9
0	6	0	2	8
0	2	1	4	7
6	6	4	1	17
3	7	2	2	14
1	0	0	1	2
4	13	4	6	27
1	0	4	0	5
1	2	0	3	6
1	0	4	5	10
19	45	23	28	115
0	5	5	0	10
7	2	2	3	14
4	4	6	2	16
1	3	3	3	10
4	8	5	0	17
2	2	0	4	8
1	9	9	2	21
2	2	5	2	11
2	6	8	1	17
0	3	8	1	12
4	2	7	0	13
0	1	2	1	4
2	3	6	3	14
1	1	0	1	3
1	0	0	0	1
2	1	0	1	4
33	52	66	24	175

PEDESTRIAN CROSSINGS				
N SIDE	S SIDE	E SIDE	W SIDE	TOTAL
1	0	1	0	2
1	1	1	0	3
0	7	1	0	8
0	5	0	2	7
0	2	1	4	7
6	6	3	1	16
2	5	1	2	10
0	0	0	1	1
3	13	3	6	25
1	0	4	0	5
1	2	0	3	6
1	0	3	4	8
16	41	18	23	98
11	24	7	10	52
0	5	4	0	9
7	2	2	3	14
3	3	6	2	14
1	1	1	3	6
4	7	5	0	16
2	1	0	3	6
0	9	8	1	18
2	2	4	2	10
0	6	6	1	13
0	2	8	1	11
4	2	7	0	13
0	1	0	1	2
1	3	4	2	10
1	0	0	1	2
1	0	0	0	1
2	0	0	0	2
28	44	55	20	147
6	12	25	4	47

BICYCLE CROSSINGS				
NS	SS	ES	WS	TOTAL
0	0	0	1	1
0	0	1	3	4
0	1	0	0	1
0	1	0	0	1
0	0	0	0	0
1	2	1	0	4
1	0	0	0	1
1	0	1	0	2
0	0	0	0	0
0	0	0	0	0
0	0	1	1	2
3	4	5	5	17
3	2	3	0	8
0	0	1	0	1
0	0	0	0	0
1	1	0	0	2
0	2	2	0	4
0	1	0	0	1
0	1	0	1	2
1	0	1	1	3
0	1	0	0	1
2	0	2	0	4
0	1	0	0	1
0	0	0	0	0
0	0	2	0	2
1	0	2	1	4
0	1	0	0	1
0	0	0	0	0
0	1	0	1	2
5	8	11	4	28
2	1	3	0	6

INTERSECTION TURNING MOVEMENT COUNTS

PREPARED BY: AimTD LLC. tel: 714 253 7888 pacific@aimtd.com

DATE: Tue, Feb 9, 16	LOCATION: NORTH & SOUTH: EAST & WEST:	Santa Ana Harbor Segerstrom	PROJECT #: SC0846 LOCATION #: 45 CONTROL: SIGNAL
--------------------------------	--	-----------------------------------	---

NOTES:	AM PM MD OTHER OTHER	◀ W S ▼	▲ N E ▶
--------	----------------------------------	---------------	------------

Add U-Turns to Left Turns

	NORTHBOUND			SOUTHBOUND			EASTBOUND			WESTBOUND			TOTAL
	Harbor			Harbor			Segerstrom			Segerstrom			
LANES:	NL	NT	NR	SL	ST	SR	EL	ET	ER	WL	WT	WR	
AM													
7:00 AM	19	119	13	39	581	13	10	143	46	19	53	13	1,068
7:15 AM	21	169	20	29	555	13	21	198	76	15	48	16	1,181
7:30 AM	18	180	12	45	588	24	17	193	77	23	65	20	1,262
7:45 AM	31	176	11	39	556	20	18	189	66	37	101	25	1,269
8:00 AM	35	233	15	38	503	18	30	167	65	32	107	16	1,259
8:15 AM	22	171	10	42	562	20	19	159	77	20	74	17	1,193
8:30 AM	20	218	15	24	509	16	19	129	76	14	56	10	1,106
8:45 AM	19	202	9	28	501	19	24	132	58	16	64	15	1,087
VOLUMES	185	1,468	105	284	4,355	143	158	1,310	541	176	568	132	9,425
APPROACH %	11%	84%	6%	6%	91%	3%	8%	65%	27%	20%	65%	15%	
APP/DEPART	1,758	/	1,759	4,782	/	5,083	2,009	/	1,696	876	/	887	0
BEGIN PEAK HR	7:30 AM												
VOLUMES	106	760	48	164	2,209	82	84	708	285	112	347	78	4,983
APPROACH %	12%	83%	5%	7%	90%	3%	8%	66%	26%	21%	65%	15%	
PEAK HR FACTOR	0.807			0.934			0.938			0.824			0.982
APP/DEPART	914	/	924	2,455	/	2,615	1,077	/	917	537	/	527	0
PM													
4:00 PM	47	410	21	32	218	18	37	108	46	19	249	74	1,279
4:15 PM	50	455	13	19	198	13	27	101	45	22	263	65	1,271
4:30 PM	58	456	12	28	230	18	39	112	43	33	237	84	1,350
4:45 PM	66	429	10	23	243	18	25	121	50	31	248	87	1,351
5:00 PM	67	455	16	21	254	25	40	151	48	25	251	76	1,429
5:15 PM	80	454	16	23	262	26	21	144	43	21	271	114	1,475
5:30 PM	74	469	15	20	227	18	20	114	32	18	262	97	1,366
5:45 PM	52	479	13	15	223	18	18	122	31	16	261	92	1,340
VOLUMES	494	3,607	116	181	1,855	154	227	973	338	185	2,042	689	10,861
APPROACH %	12%	86%	3%	8%	85%	7%	15%	63%	22%	6%	70%	24%	
APP/DEPART	4,217	/	4,533	2,190	/	2,387	1,538	/	1,254	2,916	/	2,687	0
BEGIN PEAK HR	4:45 PM												
VOLUMES	287	1,807	57	87	986	87	106	530	173	95	1,032	374	5,621
APPROACH %	13%	84%	3%	8%	85%	8%	13%	66%	21%	6%	69%	25%	
PEAK HR FACTOR	0.964			0.932			0.846			0.924			0.953
APP/DEPART	2,151	/	2,288	1,160	/	1,258	809	/	667	1,501	/	1,408	0

U-TURNS				
NB	SB	EB	WB	TTL
0	0	0	0	0
1	0	0	0	1
0	0	0	0	0
4	0	0	0	4
3	1	1	0	5
2	2	0	0	4
1	0	1	0	2
0	0	0	0	0
11	3	2	0	16

1	4	0	0	5
2	0	0	0	2
1	5	0	0	6
2	1	1	0	4
1	1	4	0	6
0	3	1	0	4
1	2	0	0	3
1	0	0	0	1
9	16	6	0	31

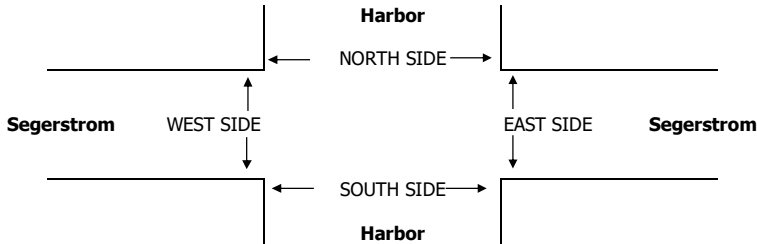

		N SIDE	S SIDE	E SIDE	W SIDE	TOTAL
AM	7:00 AM	1	1	3	5	10
	7:15 AM	0	0	0	0	0
	7:30 AM	4	3	2	2	11
	7:45 AM	3	1	0	6	10
	8:00 AM	0	1	0	2	3
	8:15 AM	0	3	0	6	9
	8:30 AM	3	4	0	2	9
	8:45 AM	2	0	1	2	5
TOTAL		13	13	6	25	57
PM	4:00 PM	0	0	3	0	3
	4:15 PM	0	0	3	1	4
	4:30 PM	2	6	0	4	12
	4:45 PM	2	0	1	0	3
	5:00 PM	2	3	1	2	8
	5:15 PM	2	0	0	0	2
	5:30 PM	2	3	1	1	7
	5:45 PM	0	0	0	1	1
TOTAL		10	12	9	9	40

PEDESTRIAN + BIKE CROSSINGS				
N SIDE	S SIDE	E SIDE	W SIDE	TOTAL
1	0	1	4	6
0	0	0	0	0
1	2	2	1	6
2	0	0	4	6
0	1	0	1	2
0	1	0	5	6
0	2	0	1	3
1	0	0	2	3
5	6	3	18	32
0	0	0	0	0
0	0	2	0	2
0	1	0	4	5
2	0	0	0	2
2	3	0	1	6
1	0	0	0	1
1	0	1	1	3
0	0	0	0	0
6	4	3	6	19

PEDESTRIAN CROSSINGS				
N SIDE	S SIDE	E SIDE	W SIDE	TOTAL
1	0	1	4	6
0	0	0	0	0
1	2	2	1	6
2	0	0	4	6
0	1	0	1	2
0	1	0	5	6
0	2	0	1	3
1	0	0	2	3
5	6	3	18	32
0	0	0	0	0
0	0	2	0	2
0	1	0	4	5
2	0	0	0	2
2	3	0	1	6
1	0	0	0	1
1	0	1	1	3
0	0	0	0	0
6	4	3	6	19

BICYCLE CROSSINGS				
NS	SS	ES	WS	TOTAL
0	1	2	1	4
0	0	0	0	0
3	1	0	1	5
1	1	0	2	4
0	0	0	1	1
0	2	0	1	3
3	2	0	1	6
1	0	1	0	2
8	7	3	7	25
0	0	3	0	3
0	0	1	1	2
2	5	0	0	7
0	0	1	0	1
0	0	1	1	2
1	0	0	0	1
1	3	0	0	4
0	0	0	1	1
4	8	6	3	21

INTERSECTION TURNING MOVEMENT COUNTS

PREPARED BY: AimTD LLC. tel: 714 253 7888 pacific@aimtd.com

DATE: Tue, Mar 1, 16	LOCATION: NORTH & SOUTH: Santa Ana EAST & WEST: Hyland MacArthur	PROJECT #: SC0846 LOCATION #: 9 CONTROL: SIGNAL
--------------------------------	--	--

NOTES:	AM PM MD OTHER OTHER	◀ W S ▼	▲ N E ▶
--------	----------------------------------	---------------	------------

Add U-Turns to Left Turns

LANES:	NORTHBOUND			SOUTHBOUND			EASTBOUND			WESTBOUND			TOTAL
	NL	NT	NR	SL	ST	SR	EL	ET	ER	WL	WT	WR	

U-TURNS				
NB	SB	EB	WB	TTL

AM	7:00 AM	10	0	8	2	1	1	1	258	105	12	78	3	479
	7:15 AM	10	0	2	2	0	13	2	434	157	10	88	5	723
	7:30 AM	20	0	6	1	0	2	0	505	178	12	92	6	822
	7:45 AM	10	0	8	1	1	2	3	491	226	22	138	2	904
	8:00 AM	26	2	2	3	0	1	1	446	183	17	152	6	839
	8:15 AM	13	1	5	5	0	0	3	412	154	13	106	4	716
	8:30 AM	9	2	6	1	0	3	5	415	134	20	107	6	708
	8:45 AM	21	4	13	4	1	0	6	319	111	13	127	4	623
	VOLUMES	119	9	50	19	3	22	21	3,280	1,248	119	888	36	5,814
	APPROACH %	67%	5%	28%	43%	7%	50%	0%	72%	27%	11%	85%	3%	
APP/DEPART	178	/	65	44	/	1,369	4,549	/	3,350	1,043	/	1,030	0	
BEGIN PEAK HR	7:15 AM			7	1	18	6	1,876	744	61	470	19	3,288	
VOLUMES	66	2	18	7	1	18	6	1,876	744	61	470	19	3,288	
APPROACH %	77%	2%	21%	27%	4%	69%	0%	71%	28%	11%	85%	3%		
PEAK HR FACTOR	0.717			0.433			0.912			0.786			0.909	
APP/DEPART	86	/	26	26	/	805	2,626	/	1,902	550	/	555	0	
PM	4:00 PM	250	2	18	4	1	6	6	192	29	6	476	2	992
	4:15 PM	254	3	10	3	0	8	3	184	34	3	582	3	1,087
	4:30 PM	270	0	15	6	3	2	6	227	45	10	532	5	1,121
	4:45 PM	282	0	14	3	2	1	9	200	45	6	561	1	1,124
	5:00 PM	284	2	24	3	0	2	7	218	32	10	556	1	1,139
	5:15 PM	302	2	18	3	1	7	9	233	38	3	556	5	1,177
	5:30 PM	286	2	11	2	0	3	9	205	38	5	585	4	1,150
	5:45 PM	280	2	6	2	2	4	7	195	44	3	566	5	1,116
	VOLUMES	2,208	13	116	26	9	33	56	1,654	305	46	4,414	26	8,906
	APPROACH %	94%	1%	5%	38%	13%	49%	3%	82%	15%	1%	98%	1%	
APP/DEPART	2,337	/	70	68	/	358	2,015	/	1,798	4,486	/	6,680	0	
BEGIN PEAK HR	4:45 PM			11	3	13	34	856	153	24	2,258	11	4,590	
VOLUMES	1,154	6	67	11	3	13	34	856	153	24	2,258	11	4,590	
APPROACH %	94%	0%	5%	41%	11%	48%	3%	82%	15%	1%	98%	0%		
PEAK HR FACTOR	0.953			0.614			0.931			0.965			0.975	
APP/DEPART	1,227	/	38	27	/	178	1,043	/	936	2,293	/	3,438	0	

0	0	0	0	0
0	0	0	1	1
0	0	0	0	0
0	0	0	0	0
0	0	1	0	1
0	0	0	0	0
0	0	0	0	0
0	0	0	0	0
0	0	1	1	2
0	0	3	0	3
0	0	2	0	2
0	0	5	0	5
0	0	4	1	5
0	0	4	0	4
0	0	4	1	5
0	0	1	0	1
0	0	2	0	2
0	0	25	2	27

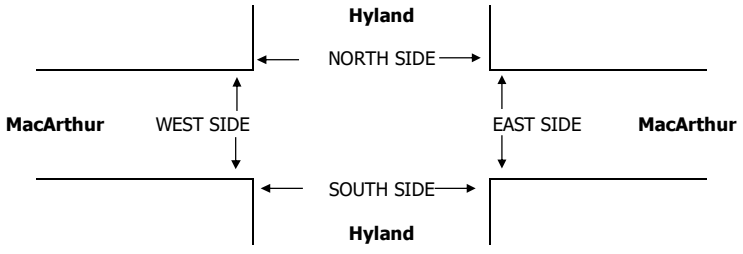

	AM	PEDESTRIAN + BIKE CROSSINGS				
		N SIDE	S SIDE	E SIDE	W SIDE	TOTAL

7:00 AM	0	0	0	0	0
7:15 AM	2	2	1	0	5
7:30 AM	0	1	0	0	1
7:45 AM	3	2	0	0	5
8:00 AM	1	0	0	0	1
8:15 AM	5	0	0	0	5
8:30 AM	1	1	0	0	2
8:45 AM	1	0	0	0	1
TOTAL	13	6	1	0	20
4:00 PM	4	2	0	0	6
4:15 PM	4	1	2	0	7
4:30 PM	3	0	2	0	5
4:45 PM	1	5	3	0	9
5:00 PM	2	1	3	0	6
5:15 PM	3	1	1	0	5
5:30 PM	8	0	0	0	8
5:45 PM	1	1	0	0	2
TOTAL	26	11	11	0	48

	PEDESTRIAN CROSSINGS				
	N SIDE	S SIDE	E SIDE	W SIDE	TOTAL

	BICYCLE CROSSINGS				
	NS	SS	ES	WS	TOTAL

INTERSECTION TURNING MOVEMENT COUNTS

PREPARED BY: AimTD LLC. tel: 714 253 7888 cs@aimtd.com

DATE:
Tue, May 22, 18

LOCATION: Costa Mesa
NORTH & SOUTH: Harbor
EAST & WEST: MacArthur

PROJECT #: SC
LOCATION #: 1
CONTROL: SIGNAL

NOTES:

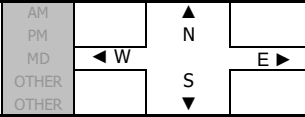

Add U-Turns to Left Turns

	NORTHBOUND			SOUTHBOUND			EASTBOUND			WESTBOUND			TOTAL
	Harbor			Harbor			MacArthur			MacArthur			
LANES:	NL	NT	NR	SL	ST	SR	EL	ET	ER	WL	WT	WR	
7:00 AM	21	181	7	74	415	39	33	217	36	14	54	16	1,107
7:15 AM	18	188	9	70	474	26	37	249	65	16	78	28	1,258
7:30 AM	27	197	19	89	468	20	36	322	102	29	93	38	1,440
7:45 AM	33	212	24	79	422	34	23	293	74	39	125	29	1,387
8:00 AM	41	251	24	59	454	35	32	254	76	33	119	38	1,416
8:15 AM	24	220	23	82	440	34	32	249	85	29	97	24	1,339
8:30 AM	39	192	21	73	412	40	30	212	68	31	80	26	1,224
8:45 AM	36	203	23	75	438	39	26	177	78	28	76	28	1,227
VOLUMES	239	1,644	150	601	3,523	267	249	1,973	584	219	722	227	10,398
APPROACH %	12%	81%	7%	14%	80%	6%	9%	70%	21%	19%	62%	19%	
APP/DEPART	2,033	/	2,126	4,391	/	4,291	2,806	/	2,767	1,168	/	1,214	0
BEGIN PEAK HR	7:30 AM												
VOLUMES	125	880	90	309	1,784	123	123	1,118	337	130	434	129	5,582
APPROACH %	11%	80%	8%	14%	81%	6%	8%	71%	21%	19%	63%	19%	
PEAK HR FACTOR	0.866			0.960			0.858			0.898			0.969
APP/DEPART	1,095	/	1,136	2,216	/	2,230	1,578	/	1,541	693	/	675	0
4:00 PM	131	418	18	47	237	38	37	138	45	26	358	73	1,566
4:15 PM	138	393	32	43	250	41	23	110	41	22	362	55	1,510
4:30 PM	144	377	26	48	291	32	38	125	35	32	340	81	1,569
4:45 PM	144	358	23	50	244	47	30	105	47	13	370	53	1,484
5:00 PM	141	355	22	64	284	67	37	126	55	18	369	61	1,599
5:15 PM	147	399	15	46	232	26	32	123	40	22	359	75	1,516
5:30 PM	112	407	13	50	253	29	45	99	43	20	346	86	1,503
5:45 PM	130	411	16	51	220	34	29	98	30	14	356	69	1,458
VOLUMES	1,087	3,118	165	399	2,011	314	271	924	336	167	2,860	553	12,205
APPROACH %	25%	71%	4%	15%	74%	12%	18%	60%	22%	5%	80%	15%	
APP/DEPART	4,370	/	3,954	2,724	/	2,478	1,531	/	1,513	3,580	/	4,260	0
BEGIN PEAK HR	4:30 PM												
VOLUMES	576	1,489	86	208	1,051	172	137	479	177	85	1,438	270	6,168
APPROACH %	27%	69%	4%	15%	73%	12%	17%	60%	22%	5%	80%	15%	
PEAK HR FACTOR	0.959			0.862			0.909			0.983			0.964
APP/DEPART	2,151	/	1,903	1,431	/	1,295	793	/	782	1,793	/	2,188	0

U-TURNS				
NB	SB	EB	WB	TTL
0	0	0	0	0
0	0	0	3	3
0	2	0	3	5
3	0	0	2	5
0	3	0	10	13
1	1	0	10	12
3	0	0	6	9
3	0	0	9	12
4	0	0	6	10
14	6	0	49	69

4	4	0	7	15
3	1	2	8	14
2	7	1	9	19
0	1	0	5	6
1	2	3	2	8
1	3	2	6	12
2	3	3	6	14
0	3	1	6	10
13	24	12	49	98

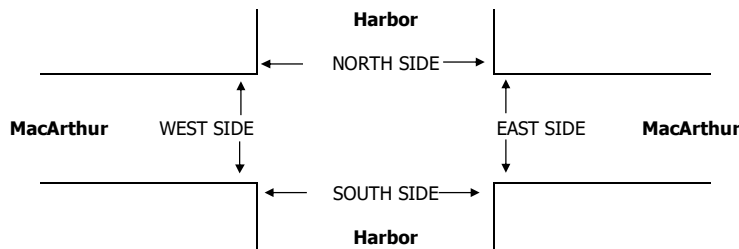

	PEDESTRIAN + BIKE CROSSINGS				
	N SIDE	S SIDE	E SIDE	W SIDE	TOTAL
7:00 AM	0	0	0	0	0
7:15 AM	0	0	0	0	0
7:30 AM	0	0	0	0	0
7:45 AM	0	0	0	0	0
8:00 AM	0	0	0	0	0
8:15 AM	0	0	0	0	0
8:30 AM	0	0	0	0	0
8:45 AM	0	0	0	0	0
TOTAL	0	0	0	0	0
AM BEGIN PEAK HR	7:30 AM				
4:00 PM	0	0	0	0	0
4:15 PM	0	0	0	0	0
4:30 PM	0	0	0	0	0
4:45 PM	0	0	0	0	0
5:00 PM	0	0	0	0	0
5:15 PM	0	0	0	0	0
5:30 PM	0	0	0	0	0
5:45 PM	0	0	0	0	0
TOTAL	0	0	0	0	0
PM BEGIN PEAK HR	4:30 PM				

	PEDESTRIAN CROSSINGS				
	N SIDE	S SIDE	E SIDE	W SIDE	TOTAL
7:00 AM	0	0	0	0	0
7:15 AM	0	0	0	0	0
7:30 AM	0	0	0	0	0
7:45 AM	0	0	0	0	0
8:00 AM	0	0	0	0	0
8:15 AM	0	0	0	0	0
8:30 AM	0	0	0	0	0
8:45 AM	0	0	0	0	0
TOTAL	0	0	0	0	0
AM BEGIN PEAK HR	7:30 AM				
4:00 PM	0	0	0	0	0
4:15 PM	0	0	0	0	0
4:30 PM	0	0	0	0	0
4:45 PM	0	0	0	0	0
5:00 PM	0	0	0	0	0
5:15 PM	0	0	0	0	0
5:30 PM	0	0	0	0	0
5:45 PM	0	0	0	0	0
TOTAL	0	0	0	0	0
PM BEGIN PEAK HR	4:30 PM				

	BICYCLE CROSSINGS				
	NS	SS	ES	WS	TOTAL
7:00 AM	0	0	0	0	0
7:15 AM	0	0	0	0	0
7:30 AM	0	0	0	0	0
7:45 AM	0	0	0	0	0
8:00 AM	0	0	0	0	0
8:15 AM	0	0	0	0	0
8:30 AM	0	0	0	0	0
8:45 AM	0	0	0	0	0
TOTAL	0	0	0	0	0
AM BEGIN PEAK HR	7:30 AM				
4:00 PM	0	0	0	0	0
4:15 PM	0	0	0	0	0
4:30 PM	0	0	0	0	0
4:45 PM	0	0	0	0	0
5:00 PM	0	0	0	0	0
5:15 PM	0	0	0	0	0
5:30 PM	0	0	0	0	0
5:45 PM	0	0	0	0	0
TOTAL	0	0	0	0	0
PM BEGIN PEAK HR	4:30 PM				

INTERSECTION TURNING MOVEMENT COUNTS

PREPARED BY: AimTD LLC. tel: 714 253 7888 pacific@aimtd.com

DATE: Tue, Mar 1, 16	LOCATION: NORTH & SOUTH: EAST & WEST:	Santa Ana Harbor Sunflower	PROJECT #: SC0846 LOCATION #: 11 CONTROL: SIGNAL
--------------------------------	--	----------------------------------	---

NOTES:	AM PM MD OTHER OTHER	▲ N ▼	◀ W E ▶	
---------------	----------------------------------	-------------	------------	--

Add U-Turns to Left Turns

	NORTHBOUND			SOUTHBOUND			EASTBOUND			WESTBOUND			TOTAL
	Harbor			Harbor			Sunflower			Sunflower			
LANES:	NL	NT	NR	SL	ST	SR	EL	ET	ER	WL	WT	WR	
AM													
7:00 AM	33	170	24	36	445	5	5	22	7	17	31	8	803
7:15 AM	48	224	32	58	556	15	0	21	6	16	16	13	1,005
7:30 AM	39	272	53	71	616	8	3	32	17	26	34	24	1,195
7:45 AM	52	334	70	57	530	16	1	33	8	41	58	19	1,219
8:00 AM	69	233	42	50	531	15	4	18	9	41	51	34	1,097
8:15 AM	69	246	40	56	453	14	0	17	14	26	34	14	983
8:30 AM	54	268	40	62	454	18	2	8	11	13	26	15	971
8:45 AM	62	241	27	39	463	13	7	20	8	26	26	15	947
VOLUMES	426	1,988	328	429	4,048	104	22	171	80	206	276	142	8,220
APPROACH %	16%	73%	12%	9%	88%	2%	8%	63%	29%	33%	44%	23%	
APP/DEPART	2,742	/	2,159	4,581	/	4,341	273	/	921	624	/	799	0
BEGIN PEAK HR	7:15 AM												
VOLUMES	208	1,063	197	236	2,233	54	8	104	40	124	159	90	4,516
APPROACH %	14%	72%	13%	9%	89%	2%	5%	68%	26%	33%	43%	24%	
PEAK HR FACTOR	0.805			0.908			0.731			0.740			0.926
APP/DEPART	1,468	/	1,162	2,523	/	2,400	152	/	536	373	/	418	0
PM													
4:00 PM	39	466	41	31	338	13	12	29	39	65	92	33	1,198
4:15 PM	47	493	42	26	300	6	8	21	29	51	110	39	1,172
4:30 PM	37	463	58	18	355	11	20	45	57	65	106	44	1,279
4:45 PM	48	467	53	30	326	12	9	30	32	55	127	58	1,247
5:00 PM	46	358	65	28	330	9	28	56	50	68	132	32	1,202
5:15 PM	40	413	76	31	327	8	7	43	42	56	147	57	1,247
5:30 PM	41	440	70	35	306	8	8	32	30	53	148	53	1,224
5:45 PM	49	485	59	25	266	10	4	31	29	61	151	46	1,216
VOLUMES	347	3,585	464	224	2,548	77	96	287	308	474	1,013	362	9,785
APPROACH %	8%	82%	11%	8%	89%	3%	14%	42%	45%	26%	55%	20%	
APP/DEPART	4,396	/	4,059	2,849	/	3,344	691	/	961	1,849	/	1,421	0
BEGIN PEAK HR	4:30 PM												
VOLUMES	171	1,701	252	107	1,338	40	64	174	181	244	512	191	4,975
APPROACH %	8%	80%	12%	7%	90%	3%	15%	42%	43%	26%	54%	20%	
PEAK HR FACTOR	0.935			0.967			0.782			0.911			0.972
APP/DEPART	2,124	/	1,964	1,485	/	1,771	419	/	525	947	/	715	0

U-TURNS				
NB	SB	EB	WB	TTL
0	0	0	0	0
1	0	0	0	1
0	0	0	0	0
2	1	0	0	3
0	0	0	0	0
1	1	0	0	2
1	4	0	0	5
2	1	0	0	3
7	7	0	0	14

3	3	0	0	6
2	1	0	0	3
2	2	0	0	4
1	2	0	0	3
4	3	0	0	7
1	1	0	0	2
2	3	0	0	5
1	1	0	2	4
16	16	0	2	34

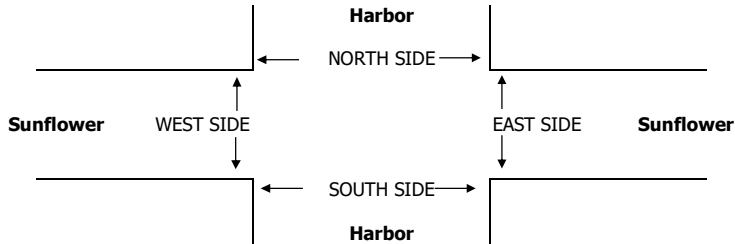

	N SIDE	S SIDE	E SIDE	W SIDE	TOTAL
AM					
7:00 AM	1	0	0	0	1
7:15 AM	2	0	0	2	4
7:30 AM	1	1	1	1	4
7:45 AM	4	2	2	2	10
8:00 AM	0	3	0	0	3
8:15 AM	2	1	2	3	8
8:30 AM	0	0	0	0	0
8:45 AM	4	1	4	3	12
TOTAL	14	8	9	11	42
PM					
4:00 PM	2	1	4	1	8
4:15 PM	2	0	2	1	5
4:30 PM	3	4	2	2	11
4:45 PM	5	1	3	1	10
5:00 PM	2	1	1	2	6
5:15 PM	2	1	3	1	7
5:30 PM	3	2	2	0	7
5:45 PM	1	1	4	0	6
TOTAL	20	11	21	8	60

PEDESTRIAN + BIKE CROSSINGS				
N SIDE	S SIDE	E SIDE	W SIDE	TOTAL
1	0	0	0	1
2	0	0	2	4
1	1	1	1	4
4	2	2	2	10
0	3	0	0	3
2	1	2	3	8
0	0	0	0	0
4	1	4	3	12
14	8	9	11	42
2	1	4	1	8
2	0	2	1	5
3	4	2	2	11
5	1	3	1	10
2	1	1	2	6
2	1	3	1	7
3	2	2	0	7
1	1	4	0	6
20	11	21	8	60

PEDESTRIAN CROSSINGS				
N SIDE	S SIDE	E SIDE	W SIDE	TOTAL
1	0	0	0	1
2	0	0	0	2
1	0	1	1	3
3	0	2	2	7
0	0	0	0	0
2	0	2	1	5
0	0	0	0	0
2	0	2	1	5
11	0	7	5	23
1	1	2	0	4
1	0	1	1	3
0	0	2	1	3
3	0	3	1	7
1	0	0	1	2
1	0	1	0	2
2	0	2	0	4
0	0	4	0	4
9	1	15	4	29

BICYCLE CROSSINGS				
NS	SS	ES	WS	TOTAL
0	0	0	0	0
0	0	0	2	2
0	1	0	0	1
1	2	0	0	3
0	3	0	0	3
0	1	0	2	3
0	0	0	0	0
2	1	2	2	7
3	8	2	6	19
1	0	2	1	4
1	0	1	0	2
3	4	0	1	8
2	1	0	0	3
1	1	1	1	4
1	1	2	1	5
1	2	0	0	3
1	1	0	0	2
11	10	6	4	31

INTERSECTION TURNING MOVEMENT COUNTS

PREPARED BY: AimTD LLC. tel: 714 253 7888 cs@aimtd.com

DATE: Tue, Mar 12, 19

LOCATION: NORTH & SOUTH: EAST & WEST:

Costa Mesa Harbor NB I-405 Ramps

PROJECT #: CMP2019 LOCATION #: 48 SIGNAL CONTROL:

NOTES:

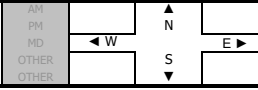

Add U-Turns to Left Turns

Main table with columns for Northbound, Southbound, Eastbound, Westbound, and Total. Rows include time slots from 6:00 AM to 6:45 PM, and summary rows for volumes and peak factors.

U-TURNS table with columns NB, SB, EB, WB, TTL.

Right-turn Overlap table with columns NRR, SRR, ERR, WRR.

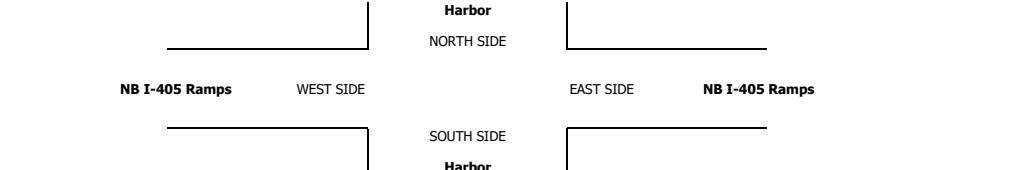

U-TURNS table with columns NB, SB, EB, WB, TTL.

Right-turn Overlap table with columns NRR, SRR, ERR, WRR.

Table with time slots (6:00 AM to 6:45 PM) and AM/PM indicators.

ALL PED AND BIKE table with columns N SIDE, S SIDE, E SIDE, W SIDE, TOTAL.

PEDESTRIAN CROSSINGS table with columns N SIDE, S SIDE, E SIDE, W SIDE, TOTAL.

BICYCLE CROSSINGS table with columns NS, SS, ES, WS, TOTAL.

INTERSECTION TURNING MOVEMENT COUNTS

PREPARED BY: AimTD LLC. tel: 714 253 7888 cs@aimtd.com

Costa Mesa Harbor SB I-405 Ramps

PROJECT #: CMP2019 LOCATION #: 42 SIGNAL CONTROL:

DATE: Tue, Apr 16, 19

LOCATION: NORTH & SOUTH: EAST & WEST:

NOTES:

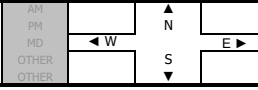

Add U-Turns to Left Turns

Main data table with columns for NORTHBOUND, SOUTHBOUND, EASTBOUND, WESTBOUND, and TOTAL. Rows include hourly volumes, peak hour factors, and peak hour counts for AM and PM.

U-TURNS table with columns NB, SB, EB, WB, TTL. Shows zero counts for all directions.

Right-turn Overlap table with columns NRR, SRR, ERR, WRR. Shows zero counts for all directions.

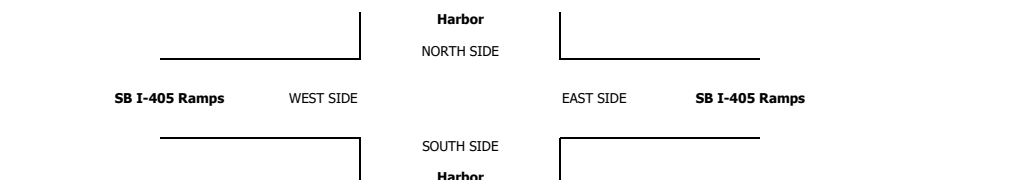

Summary table for AM and PM periods, including total counts and peak hour information.

ALL PED AND BIKE table with columns N SIDE, S SIDE, E SIDE, W SIDE, TOTAL. Shows pedestrian and bicycle counts.

PEDESTRIAN CROSSINGS table with columns N SIDE, S SIDE, E SIDE, W SIDE, TOTAL. Shows counts for pedestrian crossings.

BICYCLE CROSSINGS table with columns NS, SS, ES, WS, TOTAL. Shows counts for bicycle crossings.

INTERSECTION TURNING MOVEMENT COUNTS

PREPARED BY: AimTD LLC. tel: 714 253 7888 pacific@aimtd.com

DATE: Tue, Feb 9, 16	LOCATION: NORTH & SOUTH: EAST & WEST:	Santa Ana Fairview Civic Center	PROJECT #: LOCATION #: CONTROL:	SC0846 12 SIGNAL
--------------------------------	--	---------------------------------------	--	------------------------

NOTES:	AM PM MD OTHER OTHER	◀ W E ▶	▲ N S ▼	
---------------	----------------------------------	------------	------------	--

Add U-Turns to Left Turns

	NORTHBOUND			SOUTHBOUND			EASTBOUND			WESTBOUND			TOTAL
	NL	NT	NR	SL	ST	SR	EL	ET	ER	WL	WT	WR	
LANES:	1	3	0	1	3	0	0.5	1	0.5	1.5	0.5	1	
AM													
7:00 AM	1	313	65	39	371	1	1	5	4	78	3	22	903
7:15 AM	0	331	87	57	342	2	2	6	8	82	1	49	967
7:30 AM	2	277	122	68	316	1	2	4	3	67	3	45	910
7:45 AM	2	307	123	69	318	1	0	7	7	61	1	32	928
8:00 AM	3	272	78	49	332	3	2	2	3	63	6	21	834
8:15 AM	2	253	64	28	357	1	0	0	3	48	3	39	798
8:30 AM	3	247	56	22	373	0	2	1	8	53	2	29	796
8:45 AM	2	236	53	19	335	0	1	3	1	61	1	20	732
VOLUMES	15	2,236	648	351	2,744	9	10	28	37	513	20	257	6,868
APPROACH %	1%	77%	22%	11%	88%	0%	13%	37%	49%	65%	3%	33%	
APP/DEPART	2,899	/	2,518	3,104	/	3,294	75	/	1,012	790	/	44	0
BEGIN PEAK HR	7:00 AM												
VOLUMES	5	1,228	397	233	1,347	5	5	22	22	288	8	148	3,708
APPROACH %	0%	75%	24%	15%	85%	0%	10%	45%	45%	65%	2%	33%	
PEAK HR FACTOR	0.943												
APP/DEPART	1,630	/	1,391	1,585	/	1,657	49	/	642	444	/	18	0
PM													
4:00 PM	1	335	69	36	307	2	4	1	3	74	0	41	873
4:15 PM	3	358	78	22	317	0	0	0	3	76	0	41	898
4:30 PM	2	360	82	28	291	0	2	1	2	113	1	34	916
4:45 PM	0	337	82	26	314	0	1	1	2	111	0	38	912
5:00 PM	1	325	93	29	296	0	1	3	2	112	0	50	912
5:15 PM	0	340	99	34	330	0	0	1	1	126	0	32	963
5:30 PM	0	351	102	32	342	0	0	0	0	88	0	41	956
5:45 PM	3	358	92	43	317	0	0	0	0	94	0	32	939
VOLUMES	10	2,764	697	250	2,514	2	8	7	13	794	1	309	7,369
APPROACH %	0%	80%	20%	9%	91%	0%	29%	25%	46%	72%	0%	28%	
APP/DEPART	3,471	/	3,103	2,766	/	3,326	28	/	932	1,104	/	8	0
BEGIN PEAK HR	5:00 PM												
VOLUMES	4	1,374	386	138	1,285	0	1	4	3	420	0	155	3,770
APPROACH %	0%	78%	22%	10%	90%	0%	13%	50%	38%	73%	0%	27%	
PEAK HR FACTOR	0.974												
APP/DEPART	1,764	/	1,546	1,423	/	1,710	8	/	512	575	/	2	0

U-TURNS				
NB	SB	EB	WB	TTL
0	0	0	0	0
0	3	0	0	3
0	5	0	0	5
0	1	0	0	1
0	1	0	0	1
0	3	0	0	3
0	1	0	0	1
0	1	0	0	1
0	0	0	0	0
0	15	0	0	15

0	2	0	0	2
2	2	0	0	4
1	1	0	0	2
0	1	0	0	1
0	5	0	0	5
0	2	0	0	2
0	3	0	0	3
2	6	0	0	8
5	22	0	0	27

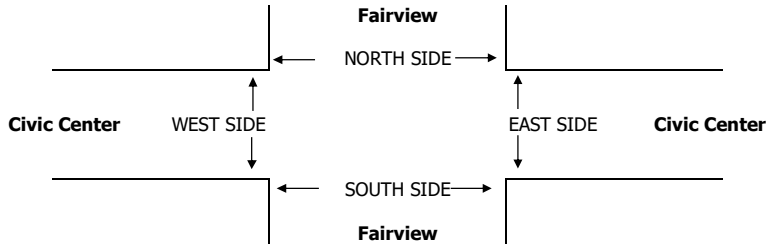

	N SIDE	S SIDE	E SIDE	W SIDE	TOTAL
AM					
7:00 AM	30	0	8	16	54
7:15 AM	24	0	0	20	44
7:30 AM	36	0	8	25	69
7:45 AM	33	0	4	25	62
8:00 AM	8	0	1	2	11
8:15 AM	10	0	2	7	19
8:30 AM	4	0	5	2	11
8:45 AM	4	0	2	5	11
TOTAL	149	0	30	102	281
PM					
4:00 PM	7	0	6	0	13
4:15 PM	10	0	1	5	16
4:30 PM	6	0	2	4	12
4:45 PM	5	0	0	5	10
5:00 PM	5	0	4	5	14
5:15 PM	3	0	4	3	10
5:30 PM	5	0	6	1	12
5:45 PM	2	0	4	2	8
TOTAL	43	0	27	25	95

PEDESTRIAN + BIKE CROSSINGS				
N SIDE	S SIDE	E SIDE	W SIDE	TOTAL
29	0	6	15	50
23	0	0	18	41
34	0	4	24	62
33	0	4	25	62
6	0	1	1	8
10	0	2	7	19
4	0	1	2	7
3	0	2	4	9
142	0	20	96	258
6	0	4	0	10
6	0	1	2	9
6	0	2	3	11
4	0	0	5	9
4	0	3	3	10
1	0	1	0	2
5	0	3	1	9
2	0	4	2	8
34	0	18	16	68

PEDESTRIAN CROSSINGS				
N SIDE	S SIDE	E SIDE	W SIDE	TOTAL
1	0	2	1	4
1	0	0	2	3
2	0	4	1	7
0	0	0	0	0
2	0	0	1	3
0	0	0	0	0
0	0	4	0	4
1	0	0	1	2
7	0	10	6	23
1	0	2	0	3
4	0	0	3	7
0	0	0	1	1
1	0	0	0	1
1	0	1	2	4
2	0	3	3	8
0	0	3	0	3
0	0	0	0	0
9	0	9	9	27

BICYCLE CROSSINGS				
NS	SS	ES	WS	TOTAL
7	0	10	6	23
1	0	2	0	3
4	0	0	3	7
0	0	0	1	1
1	0	0	0	1
1	0	1	2	4
2	0	3	3	8
0	0	3	0	3
0	0	0	0	0
9	0	9	9	27

City: SANTA ANA
 N-S Direction: FAIRVIEW STREET
 E-W Direction: 1ST STREET

File Name : H1702002
 Site Code : 00000000
 Start Date : 2/7/2017
 Page No : 1

Groups Printed- Turning Movements

Start Time	FAIRVIEW STREET Southbound				1ST STREET Westbound				FAIRVIEW STREET Northbound				1ST STREET Eastbound				Int. Total
	Right	Thru	Left	U-Turn	Right	Thru	Left	U-Turn	Right	Thru	Left	U-Turn	Right	Thru	Left	U-Turn	
07:00	20	352	41	1	39	136	32	2	45	284	30	0	54	254	59	0	1349
07:15	28	383	54	1	43	148	49	5	45	283	28	4	34	311	59	0	1475
07:30	40	378	65	2	67	177	47	4	44	302	29	2	34	290	48	0	1529
07:45	53	298	60	3	71	203	38	2	69	303	49	0	52	290	53	4	1548
Total	141	1411	220	7	220	664	166	13	203	1172	136	6	174	1145	219	4	5901
08:00	35	300	54	1	56	182	24	7	62	282	46	0	65	305	47	4	1470
08:15	28	338	53	2	32	123	29	5	39	243	34	0	56	261	53	1	1297
08:30	19	363	50	2	42	116	20	5	43	225	20	0	34	230	48	1	1218
08:45	26	293	33	0	53	127	27	7	40	206	26	4	27	230	50	1	1150
Total	108	1294	190	5	183	548	100	24	184	956	126	4	182	1026	198	7	5135
*** BREAK ***																	
16:00	51	246	45	6	45	275	31	7	30	240	43	0	43	218	30	3	1313
16:15	49	268	48	3	60	220	34	7	41	275	25	0	32	181	49	1	1293
16:30	72	277	56	2	49	281	38	13	36	259	32	2	38	173	40	1	1369
16:45	63	264	42	6	51	274	38	10	31	285	45	3	28	200	49	3	1392
Total	235	1055	191	17	205	1050	141	37	138	1059	145	5	141	772	168	8	5367
17:00	75	299	50	5	45	300	38	7	30	277	43	3	34	214	58	2	1480
17:15	57	346	48	2	39	292	39	7	32	273	25	2	30	213	59	0	1464
17:30	63	279	49	3	51	277	35	5	14	268	42	0	36	212	46	3	1383
17:45	48	302	50	2	45	299	42	11	20	243	34	2	46	205	45	3	1397
Total	243	1226	197	12	180	1168	154	30	96	1061	144	7	146	844	208	8	5724
Grand Total	727	4986	798	41	788	3430	561	104	621	4248	551	22	643	3787	793	27	22127
Apprch %	11.1	76.1	12.2	0.6	16.1	70.2	11.5	2.1	11.4	78.1	10.1	0.4	12.2	72.1	15.1	0.5	
Total %	3.3	22.5	3.6	0.2	3.6	15.5	2.5	0.5	2.8	19.2	2.5	0.1	2.9	17.1	3.6	0.1	

City: SANTA ANA
 N-S Direction: FAIRVIEW STREET
 E-W Direction: 1ST STREET

File Name : H1702002
 Site Code : 00000000
 Start Date : 2/7/2017
 Page No : 2

Start Time	FAIRVIEW STREET Southbound					1ST STREET Westbound					FAIRVIEW STREET Northbound					1ST STREET Eastbound					Int. Total
	Right	Thru	Left	U-Turn	App. Total	Right	Thru	Left	U-Turn	App. Total	Right	Thru	Left	U-Turn	App. Total	Right	Thru	Left	U-Turn	App. Total	
Peak Hour Analysis From 07:00 to 08:45 - Peak 1 of 1 Peak Hour for Entire Intersection Begins at 07:15																					
07:30	40	378	65		485	67	177	49	4	295	44	302	29	2	377	34	290	48	0	372	1529
07:45	53			3		71	203			314	69	303	49		421	52	290	53	4	399	1548
08:00	35	300	54	1	390	56	182	24	7	269	62	282	46	0	390	65	305	47	4	421	1470
Total Volume	156	1359	233	7	1755	237	710	158	18	1123	220	1170	152	6	1548	185	1196	207	8	1596	6022
% App. Total																					
PHF	.736	.887	.896	.583	.905	.835	.874	.806	.643	.894	.797	.965	.776	.375	.919	.712	.961	.877	.500	.948	.973

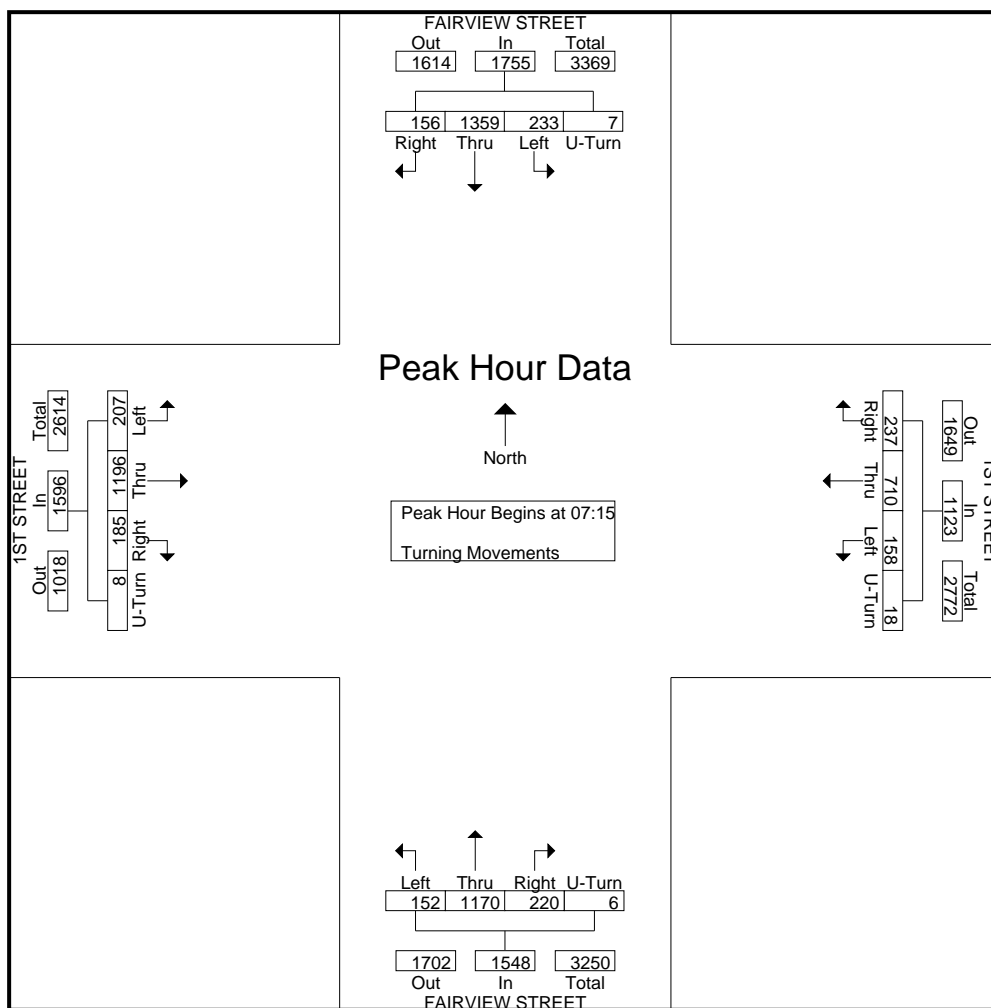

City: SANTA ANA
 N-S Direction: FAIRVIEW STREET
 E-W Direction: 1ST STREET

File Name : H1702002
 Site Code : 00000000
 Start Date : 2/7/2017
 Page No : 3

Start Time	FAIRVIEW STREET Southbound					1ST STREET Westbound					FAIRVIEW STREET Northbound					1ST STREET Eastbound					Int. Total
	Right	Thru	Left	U-Turn	App. Total	Right	Thru	Left	U-Turn	App. Total	Right	Thru	Left	U-Turn	App. Total	Right	Thru	Left	U-Turn	App. Total	
Peak Hour Analysis From 16:00 to 17:45 - Peak 1 of 1																					
Peak Hour for Entire Intersection Begins at 17:00																					
17:00	75	299	50	5	429	45	300	38	7	390	30	277	43	3	353	34	214			308	1480
17:15	57	346	48	2	453	39	292	39	7	377	32	273	25	2	332	30	213	59	0	302	1464
17:30	63	279	49	3	394	51	277	35	5	368	14	268	42	0	324	36	212	46	3	297	1383
17:45	48	302	50	2	402	45	299	42	11	397					46	205	45	3	299	1397	
Total Volume	243	1226	197	12	1678	180	1168	154	30	1532	96	1061	144	7	1308	146	844	208	8	1206	5724
% App. Total	14.5	73.1	11.7	0.7		11.7	76.2	10.1	2		7.3	81.1	11	0.5		12.1	70	17.2	0.7		
PHF	.810	.886	.985	.600	.926	.882	.973	.917	.682	.965	.750	.958	.837	.583	.926	.793	.986	.881	.667	.979	.967

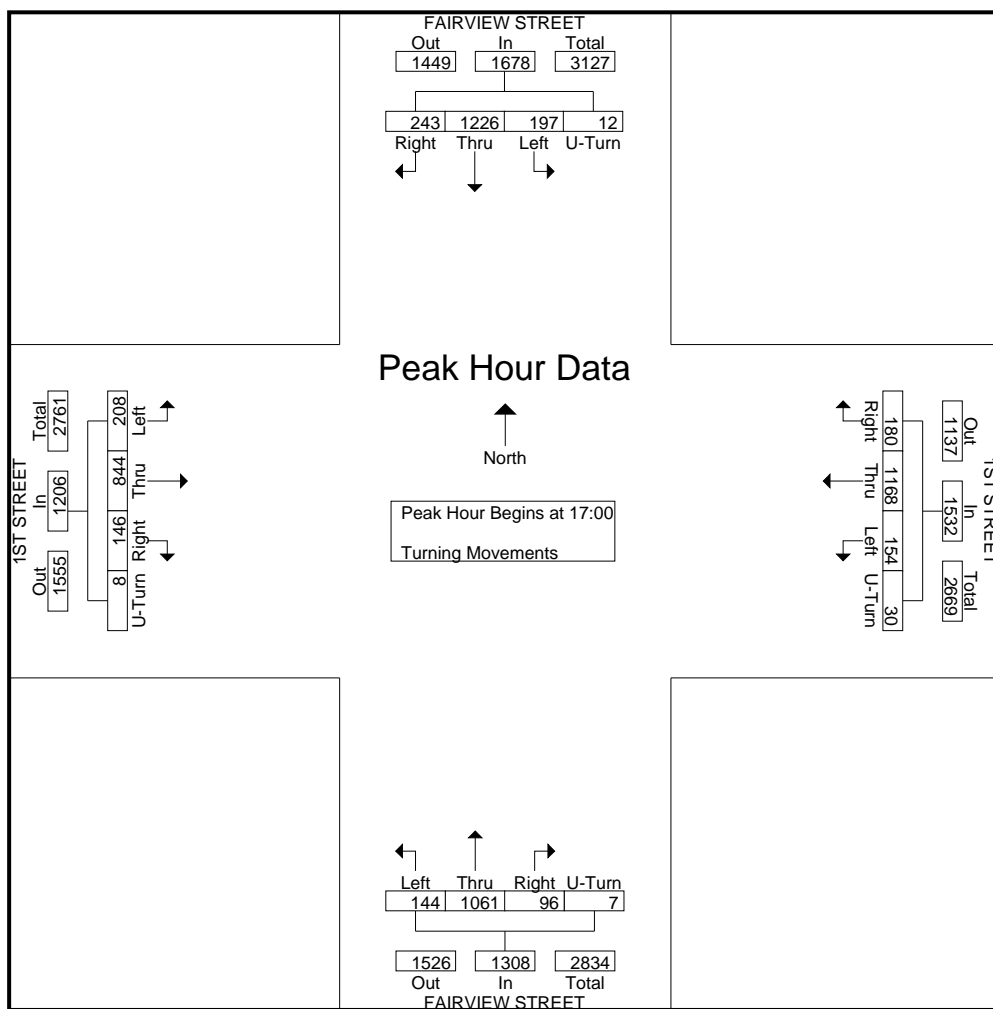

INTERSECTION TURNING MOVEMENT COUNTS

PREPARED BY: AimTD LLC. tel: 714 253 7888 pacific@aimtd.com

DATE: Tue, Feb 9, 16	LOCATION: NORTH & SOUTH: EAST & WEST:	Santa Ana Fairview McFadden	PROJECT #: SC0846 LOCATION #: 33 CONTROL: SIGNAL
--------------------------------	--	-----------------------------------	---

NOTES:	AM PM MD OTHER OTHER	▲ N ▼ S	◀ W E ▶
--------	----------------------------------	------------------	------------

Add U-Turns to Left Turns

LANES:	NORTHBOUND			SOUTHBOUND			EASTBOUND			WESTBOUND			TOTAL
	NL	NT	NR	SL	ST	SR	EL	ET	ER	WL	WT	WR	

U-TURNS				
NB	SB	EB	WB	TTL

AM	7:00 AM	20	257	19	17	393	28	44	97	23	46	79	14	1,037
	7:15 AM	20	321	30	14	493	25	57	102	30	54	105	13	1,264
	7:30 AM	29	325	41	41	426	26	54	128	26	56	152	5	1,309
	7:45 AM	30	326	51	39	395	39	49	140	37	49	114	11	1,280
	8:00 AM	37	271	44	42	345	30	52	131	22	27	109	9	1,119
	8:15 AM	29	239	27	41	344	27	54	130	43	30	88	33	1,085
	8:30 AM	24	194	19	28	415	27	43	109	56	25	102	18	1,060
	8:45 AM	19	186	17	38	398	26	34	110	43	33	84	21	1,009
	VOLUMES	208	2,119	248	260	3,209	228	387	947	280	320	833	124	9,163
	APPROACH %	8%	82%	10%	7%	87%	6%	24%	59%	17%	25%	65%	10%	
APP/DEPART	2,575	/	2,684	3,697	/	3,826	1,614	/	1,401	1,277	/	1,252	0	
BEGIN PEAK HR	7:15 AM													
VOLUMES	116	1,243	166	136	1,659	120	212	501	115	186	480	38	4,972	
APPROACH %	8%	82%	11%	7%	87%	6%	26%	61%	14%	26%	68%	5%		
PEAK HR FACTOR	0.937			0.900			0.916			0.826			0.950	
APP/DEPART	1,525	/	1,516	1,915	/	1,971	828	/	780	704	/	705	0	
PM	4:00 PM	32	372	34	36	235	43	46	153	21	30	117	32	1,151
	4:15 PM	42	388	35	34	236	38	40	116	37	30	134	21	1,151
	4:30 PM	35	369	35	35	277	54	37	146	27	29	133	24	1,201
	4:45 PM	32	367	38	37	284	46	53	152	29	31	124	16	1,209
	5:00 PM	48	338	29	35	314	49	53	158	31	38	125	37	1,255
	5:15 PM	26	346	25	30	300	51	55	141	46	39	150	34	1,243
	5:30 PM	36	361	41	36	293	48	59	165	39	35	118	28	1,259
	5:45 PM	42	359	27	47	300	40	67	169	40	39	130	29	1,289
	VOLUMES	293	2,900	264	290	2,239	369	410	1,200	270	271	1,031	221	9,758
	APPROACH %	8%	84%	8%	10%	77%	13%	22%	64%	14%	18%	68%	15%	
APP/DEPART	3,457	/	3,569	2,898	/	2,783	1,880	/	1,716	1,523	/	1,690	0	
BEGIN PEAK HR	5:00 PM													
VOLUMES	152	1,404	122	148	1,207	188	234	633	156	151	523	128	5,046	
APPROACH %	9%	84%	7%	10%	78%	12%	23%	62%	15%	19%	65%	16%		
PEAK HR FACTOR	0.958			0.969			0.927			0.899			0.979	
APP/DEPART	1,678	/	1,787	1,543	/	1,516	1,023	/	882	802	/	861	0	

0	3	0	0	3
4	3	0	0	7
4	6	0	0	10
0	4	0	0	4
3	10	0	0	13
2	13	0	0	15
1	8	0	0	9
3	7	0	0	10
17	54	0	0	71
0	9	0	0	9
1	3	0	0	4
0	4	0	0	4
0	1	0	0	1
0	4	0	0	4
1	5	0	0	6
0	9	0	0	9
1	3	0	0	4
3	38	0	0	41

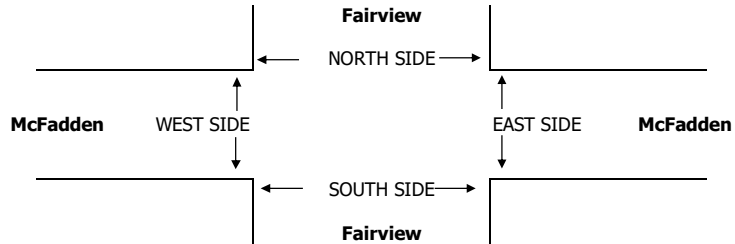

	PEDESTRIAN + BIKE CROSSINGS				
	N SIDE	S SIDE	E SIDE	W SIDE	TOTAL

AM	7:00 AM	18	15	27	25	85
	7:15 AM	26	46	46	34	152
	7:30 AM	120	117	87	110	434
	7:45 AM	83	96	44	81	304
	8:00 AM	33	27	28	22	110
	8:15 AM	8	39	29	5	81
	8:30 AM	12	11	11	13	47
	8:45 AM	8	5	9	9	31
	TOTAL	308	356	281	299	1,244
	PM	4:00 PM	7	25	33	4
4:15 PM		52	4	15	13	84
4:30 PM		12	7	18	9	46
4:45 PM		48	18	18	7	91
5:00 PM		4	6	18	4	32
5:15 PM		18	8	21	13	60
5:30 PM		17	10	24	14	65
5:45 PM		17	16	30	13	76
TOTAL	175	94	177	77	523	

	PEDESTRIAN CROSSINGS				
	N SIDE	S SIDE	E SIDE	W SIDE	TOTAL

	BICYCLE CROSSINGS				
	NS	SS	ES	WS	TOTAL

INTERSECTION TURNING MOVEMENT COUNTS

PREPARED BY: AimTD LLC. tel: 714 253 7888 pacific@aimtd.com

DATE: Tue, Feb 9, 16	LOCATION: NORTH & SOUTH: EAST & WEST:	Santa Ana Fairview Warner	PROJECT #: LOCATION #: CONTROL:	SC0846 42 SIGNAL
--------------------------------	--	---------------------------------	--	------------------------

NOTES:	AM PM MD OTHER OTHER	▲ N ▼ S	◀ W E ▶	
---------------	----------------------------------	------------------	------------	--

Add U-Turns to Left Turns

LANES:	NORTHBOUND			SOUTHBOUND			EASTBOUND			WESTBOUND			TOTAL
	NL	NT	NR	SL	ST	SR	EL	ET	ER	WL	WT	WR	

U-TURNS				
NB	SB	EB	WB	TTL

AM	7:00 AM	30	152	19	57	397	21	18	173	43	48	131	41	1,130
	7:15 AM	49	211	34	35	427	28	11	272	78	56	193	49	1,443
	7:30 AM	40	240	38	64	381	26	15	287	84	95	236	87	1,593
	7:45 AM	65	236	21	51	351	25	16	183	59	89	247	93	1,436
	8:00 AM	52	227	27	47	405	35	24	228	68	55	213	59	1,440
	8:15 AM	42	172	29	56	381	32	31	270	72	56	150	38	1,329
	8:30 AM	42	136	30	47	419	24	24	277	77	47	184	17	1,324
	8:45 AM	28	174	24	42	410	24	32	193	46	49	171	24	1,217
	VOLUMES	348	1,548	222	399	3,171	215	171	1,883	527	495	1,525	408	10,912
	APPROACH %	16%	73%	10%	11%	84%	6%	7%	73%	20%	20%	63%	17%	
APP/DEPART	2,118	/	2,132	3,785	/	4,171	2,581	/	2,542	2,428	/	2,067	0	
BEGIN PEAK HR	7:15 AM													
VOLUMES	206	914	120	197	1,564	114	66	970	289	295	889	288	5,912	
APPROACH %	17%	74%	10%	11%	83%	6%	5%	73%	22%	20%	60%	20%		
PEAK HR FACTOR	0.963			0.957			0.858			0.858			0.928	
APP/DEPART	1,240	/	1,268	1,875	/	2,134	1,325	/	1,311	1,472	/	1,199	0	
PM	4:00 PM	51	414	39	54	212	23	56	210	35	31	197	26	1,348
	4:15 PM	53	396	42	42	202	25	39	205	42	41	225	37	1,349
	4:30 PM	43	395	37	46	201	27	47	228	43	46	241	37	1,391
	4:45 PM	34	415	38	37	209	25	49	231	45	41	230	53	1,407
	5:00 PM	49	393	41	40	259	23	65	254	47	41	249	50	1,511
	5:15 PM	47	432	37	51	202	32	44	240	36	38	278	49	1,486
	5:30 PM	49	419	43	38	233	24	44	217	30	48	283	65	1,493
	5:45 PM	63	416	33	51	219	13	36	206	29	53	254	66	1,439
	VOLUMES	389	3,280	310	359	1,737	192	380	1,791	307	339	1,957	383	11,424
	APPROACH %	10%	82%	8%	16%	76%	8%	15%	72%	12%	13%	73%	14%	
APP/DEPART	3,979	/	4,054	2,288	/	2,340	2,478	/	2,512	2,679	/	2,518	0	
BEGIN PEAK HR	5:00 PM													
VOLUMES	208	1,660	154	180	913	92	189	917	142	180	1,064	230	5,929	
APPROACH %	10%	82%	8%	15%	77%	8%	15%	73%	11%	12%	72%	16%		
PEAK HR FACTOR	0.980			0.920			0.852			0.931			0.981	
APP/DEPART	2,022	/	2,080	1,185	/	1,207	1,248	/	1,287	1,474	/	1,355	0	

4	3	0	6	13
1	0	0	8	9
2	0	0	9	11
3	1	0	5	9
5	0	1	3	9
3	2	0	6	11
1	1	0	3	5
4	0	1	5	10
23	7	2	45	77
3	2	0	5	10
4	3	1	7	15
4	3	0	7	14
1	3	0	8	12
5	0	2	12	19
3	2	2	6	13
4	0	1	12	17
2	4	0	12	18
26	17	6	69	118

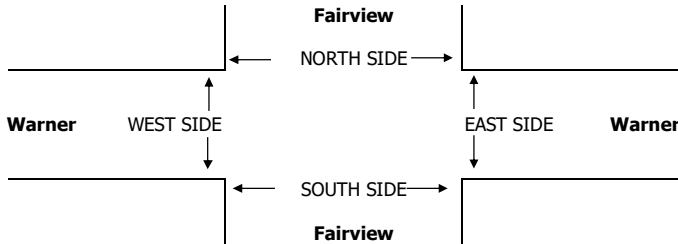

	PEDESTRIAN + BIKE CROSSINGS				
	N SIDE	S SIDE	E SIDE	W SIDE	TOTAL

AM	7:00 AM	1	1	4	0	6
	7:15 AM	2	8	6	4	20
	7:30 AM	1	3	3	4	11
	7:45 AM	2	3	2	4	11
	8:00 AM	7	9	6	8	30
	8:15 AM	3	5	7	9	24
	8:30 AM	1	3	5	2	11
	8:45 AM	1	2	4	2	9
	TOTAL	18	34	37	33	122
	PM	4:00 PM	5	16	15	9
4:15 PM		6	5	13	2	26
4:30 PM		5	8	7	2	22
4:45 PM		3	6	19	2	30
5:00 PM		1	7	20	3	31
5:15 PM		7	5	9	14	35
5:30 PM		5	0	5	5	15
5:45 PM		1	5	6	3	15
TOTAL	33	52	94	40	219	

	PEDESTRIAN CROSSINGS				
	N SIDE	S SIDE	E SIDE	W SIDE	TOTAL

	BICYCLE CROSSINGS				
	NS	SS	ES	WS	TOTAL

INTERSECTION TURNING MOVEMENT COUNTS

PREPARED BY: AimTD LLC. tel: 714 253 7888 cs@aimtd.com

DATE: Thu, May 16, 19

LOCATION: Santa Ana Fairview MacArthur

PROJECT #: SC2183 LOCATION #: 11 CONTROL: SIGNAL

NOTES: Diagram showing AM, PM, MD, OTHER, and signal phases (N, S, W, E).

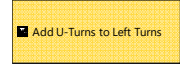

Table with columns for Northbound, Southbound, Eastbound, Westbound, and Total, including lane counts (NL, NT, NR, SL, ST, SR, EL, ET, ER, WL, WT, WR).

U-TURNS table with columns NB, SB, EB, WB, TTL.

Main data table with time intervals (7:00 AM to 5:45 PM) and summary rows for VOLUMES, APPROACH %, APP/DEPART, BEGIN PEAK HR, and PEAK HR FACTOR.

U-TURNS table for AM period.

U-TURNS table for PM period.

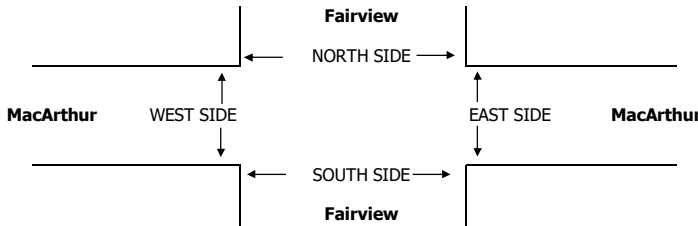

Summary table for AM and PM peak hours.

PEDESTRIAN + BIKE CROSSINGS table with columns N SIDE, S SIDE, E SIDE, W SIDE, TOTAL.

PEDESTRIAN CROSSINGS table with columns N SIDE, S SIDE, E SIDE, W SIDE, TOTAL.

BICYCLE CROSSINGS table with columns NS, SS, ES, WS, TOTAL.

INTERSECTION TURNING MOVEMENT COUNTS

PREPARED BY: AimTD LLC. tel: 714 253 7888 pacific@aimtd.com

DATE: Tue, Mar 1, 16	LOCATION: NORTH & SOUTH: EAST & WEST:	Santa Ana Fairview Sunflower	PROJECT #: SC0846 LOCATION #: 12 CONTROL: SIGNAL
--------------------------------	--	------------------------------------	---

NOTES:	AM PM MD OTHER OTHER	◀ W S ▼	▲ N E ▶	
---------------	----------------------------------	---------------	------------	--

Add U-Turns to Left Turns

	NORTHBOUND			SOUTHBOUND			EASTBOUND			WESTBOUND			TOTAL	
	Fairview			Fairview			Sunflower			Sunflower				
LANES:	NL 2	NT 3	NR 1	SL 2	ST 3	SR 0	EL 2	ET 2	ER 0	WL 2	WT 3	WR 1		
AM														
7:00 AM	27	152	19	17	322	12	10	45	17	47	22	14	704	
7:15 AM	30	254	31	40	416	23	4	64	10	61	22	18	973	
7:30 AM	47	294	36	38	411	13	12	76	14	88	58	35	1,122	
7:45 AM	52	255	32	55	419	31	14	91	14	73	102	46	1,184	
8:00 AM	48	226	57	63	424	39	17	78	24	72	64	27	1,139	
8:15 AM	32	224	41	56	376	38	6	59	16	61	34	16	959	
8:30 AM	29	182	33	37	395	39	11	46	9	40	25	10	856	
8:45 AM	33	210	22	51	379	32	10	48	9	60	34	9	897	
VOLUMES	298	1,797	271	357	3,142	227	84	507	113	502	361	175	7,834	
APPROACH %	13%	76%	11%	10%	84%	6%	12%	72%	16%	48%	35%	17%		
APP/DEPART	2,366	/	2,059	3,726	/	3,760	704	/	1,109	1,038	/	906	0	
BEGIN PEAK HR	7:15 AM													
VOLUMES	177	1,029	156	196	1,670	106	47	309	62	294	246	126	4,418	
APPROACH %	13%	76%	11%	10%	85%	5%	11%	74%	15%	44%	37%	19%		
PEAK HR FACTOR	0.903			0.937			0.878			0.753			0.933	
APP/DEPART	1,362	/	1,198	1,972	/	2,027	418	/	647	666	/	546	0	
PM														
4:00 PM	29	400	51	31	238	7	24	61	14	53	112	34	1,054	
4:15 PM	35	472	74	26	257	15	13	60	11	58	137	43	1,201	
4:30 PM	32	413	80	24	321	22	37	84	21	71	150	40	1,295	
4:45 PM	32	436	63	30	277	11	51	83	17	69	169	47	1,285	
5:00 PM	40	448	67	27	305	27	60	106	26	57	150	46	1,359	
5:15 PM	46	444	98	31	287	12	52	124	23	60	162	36	1,375	
5:30 PM	58	450	100	39	308	22	44	90	26	55	153	42	1,387	
5:45 PM	49	393	112	41	249	18	39	93	16	82	173	42	1,307	
VOLUMES	321	3,456	645	249	2,242	134	320	701	154	505	1,206	330	10,263	
APPROACH %	7%	78%	15%	9%	85%	5%	27%	60%	13%	25%	59%	16%		
APP/DEPART	4,422	/	4,115	2,625	/	2,903	1,175	/	1,561	2,041	/	1,684	0	
BEGIN PEAK HR	5:00 PM													
VOLUMES	193	1,735	377	138	1,149	79	195	413	91	254	638	166	5,428	
APPROACH %	8%	75%	16%	10%	84%	6%	28%	59%	13%	24%	60%	16%		
PEAK HR FACTOR	0.948			0.925			0.878			0.891			0.978	
APP/DEPART	2,305	/	2,103	1,366	/	1,497	699	/	909	1,058	/	919	0	

U-TURNS				
NB	SB	EB	WB	TTL
0	0	0	0	0
0	2	0	0	2
0	5	0	0	5
0	1	2	0	3
1	4	10	0	15
0	4	6	0	10
0	5	1	0	6
0	3	3	0	6
2	2	1	0	5
3	26	23	0	52
0	7	1	0	8
1	4	3	1	9
0	2	6	0	8
0	4	5	1	10
0	3	1	0	4
1	5	3	0	9
0	5	4	0	9
2	6	4	0	12
4	36	27	2	69

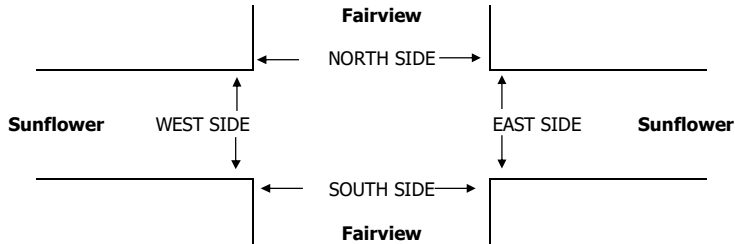

	N SIDE	S SIDE	E SIDE	W SIDE	TOTAL
AM					
7:00 AM	3	1	1	3	8
7:15 AM	2	1	1	1	5
7:30 AM	2	3	2	3	10
7:45 AM	3	3	1	3	10
8:00 AM	2	2	2	3	9
8:15 AM	2	7	0	3	12
8:30 AM	2	0	1	5	8
8:45 AM	5	1	0	3	9
TOTAL	21	18	8	24	71
PM					
4:00 PM	2	2	1	0	5
4:15 PM	1	1	1	2	5
4:30 PM	3	3	4	1	11
4:45 PM	6	4	1	0	11
5:00 PM	5	13	2	0	20
5:15 PM	6	2	2	3	13
5:30 PM	6	5	3	1	15
5:45 PM	3	8	0	3	14
TOTAL	32	38	14	10	94

PEDESTRIAN + BIKE CROSSINGS				
N SIDE	S SIDE	E SIDE	W SIDE	TOTAL
0	1	1	2	4
0	0	1	1	2
0	1	1	2	4
1	1	1	3	6
0	0	2	2	4
0	4	0	2	6
0	0	1	4	5
2	0	0	3	5
3	7	7	19	36
0	0	1	0	1
0	1	1	1	3
0	2	3	1	6
3	3	0	0	6
0	3	1	0	4
4	0	0	2	6
2	2	2	0	6
1	3	0	3	7
10	14	8	7	39

PEDESTRIAN CROSSINGS				
N SIDE	S SIDE	E SIDE	W SIDE	TOTAL
3	0	0	1	4
2	1	0	0	3
2	2	1	1	6
2	2	0	0	4
2	2	0	1	5
2	3	0	1	6
2	0	0	1	3
3	1	0	0	4
5	10	1	0	16
2	2	2	1	7
4	3	1	1	9
2	5	0	0	7
22	24	6	3	55

BICYCLE CROSSINGS				
NS	SS	ES	WS	TOTAL
3	0	0	1	4
2	1	0	0	3
2	2	1	1	6
2	2	0	0	4
2	2	0	1	5
2	3	0	1	6
2	0	0	1	3
3	1	0	0	4
2	2	0	0	4
1	0	0	1	2
3	1	1	0	5
3	1	1	0	5
5	10	1	0	16
2	2	2	1	7
4	3	1	1	9
2	5	0	0	7
22	24	6	3	55

City: SANTA ANA
 N-S Direction: GREENVILLE STREET
 E-W Direction: EDINGER AVENUE

File Name : H1702003
 Site Code : 00000000
 Start Date : 2/7/2017
 Page No : 1

Groups Printed- Turning Movements

Start Time	DEAD END Southbound			EDINGER AVENUE Westbound			GREENVILLE AVENUE Northbound			EDINGER AVENUE Eastbound			Int. Total
	Right	Thru	Left	Right	Thru	Left	Right	Thru	Left	Right	Thru	Left	
07:00	0	0	0	0	183	30	48	0	32	40	220	0	553
07:15	0	0	0	0	234	36	46	0	38	64	268	0	686
07:30	0	0	0	0	234	59	64	0	48	61	232	0	698
07:45	0	0	0	0	237	41	85	0	62	62	211	0	698
Total	0	0	0	0	888	166	243	0	180	227	931	0	2635
08:00	0	0	0	0	217	22	49	0	31	37	189	0	545
08:15	0	0	0	0	197	8	20	0	20	28	210	0	483
08:30	0	0	0	0	173	11	33	0	24	23	239	0	503
08:45	0	0	0	0	179	21	29	0	23	16	151	0	419
Total	0	0	0	0	766	62	131	0	98	104	789	0	1950
*** BREAK ***													
16:00	0	0	0	0	244	31	51	0	61	50	232	0	669
16:15	0	0	0	0	264	29	54	0	66	44	265	0	722
16:30	0	0	0	0	276	25	52	0	67	41	231	0	692
16:45	0	0	0	0	280	19	55	0	78	49	236	0	717
Total	0	0	0	0	1064	104	212	0	272	184	964	0	2800
17:00	0	0	0	0	270	30	49	0	78	54	245	0	726
17:15	0	0	0	0	274	24	53	0	85	52	208	0	696
17:30	0	0	0	0	270	19	54	0	76	39	264	0	722
17:45	0	0	0	0	275	31	40	0	69	45	199	0	659
Total	0	0	0	0	1089	104	196	0	308	190	916	0	2803
Grand Total	0	0	0	0	3807	436	782	0	858	705	3600	0	10188
Apprch %	0	0	0	0	89.7	10.3	47.7	0	52.3	16.4	83.6	0	
Total %	0	0	0	0	37.4	4.3	7.7	0	8.4	6.9	35.3	0	

City: SANTA ANA
 N-S Direction: GREENVILLE STREET
 E-W Direction: EDINGER AVENUE

File Name : H1702003
 Site Code : 00000000
 Start Date : 2/7/2017
 Page No : 2

Start Time	DEAD END Southbound				EDINGER AVENUE Westbound				GREENVILLE AVENUE Northbound				EDINGER AVENUE Eastbound				Int. Total
	Right	Thru	Left	App. Total	Right	Thru	Left	App. Total	Right	Thru	Left	App. Total	Right	Thru	Left	App. Total	
Peak Hour Analysis From 07:00 to 08:45 - Peak 1 of 1																	
Peak Hour for Entire Intersection Begins at 07:00																	
07:00	0	0	0	0	0	183	30	213	48	0	32	80	40	220	0	260	553
07:15	0	0	0	0	0	234	36	270	46	0	38	84	64	268	0	332	686
07:30	0	0	0	0	0	234	59	293	64	0	48	112	61	232	0	293	698
07:45	0	0	0	0	0	237	41	278	85	0	62	147	62	211	0	273	698
Total Volume	0	0	0	0	0	888	166	1054	243	0	180	423	227	931	0	1158	2635
% App. Total	0	0	0	0	0	84.3	15.7		57.4	0	42.6		19.6	80.4	0		
PHF	.000	.000	.000	.000	.000	.937	.703	.899	.715	.000	.726	.719	.887	.868	.000	.872	.944

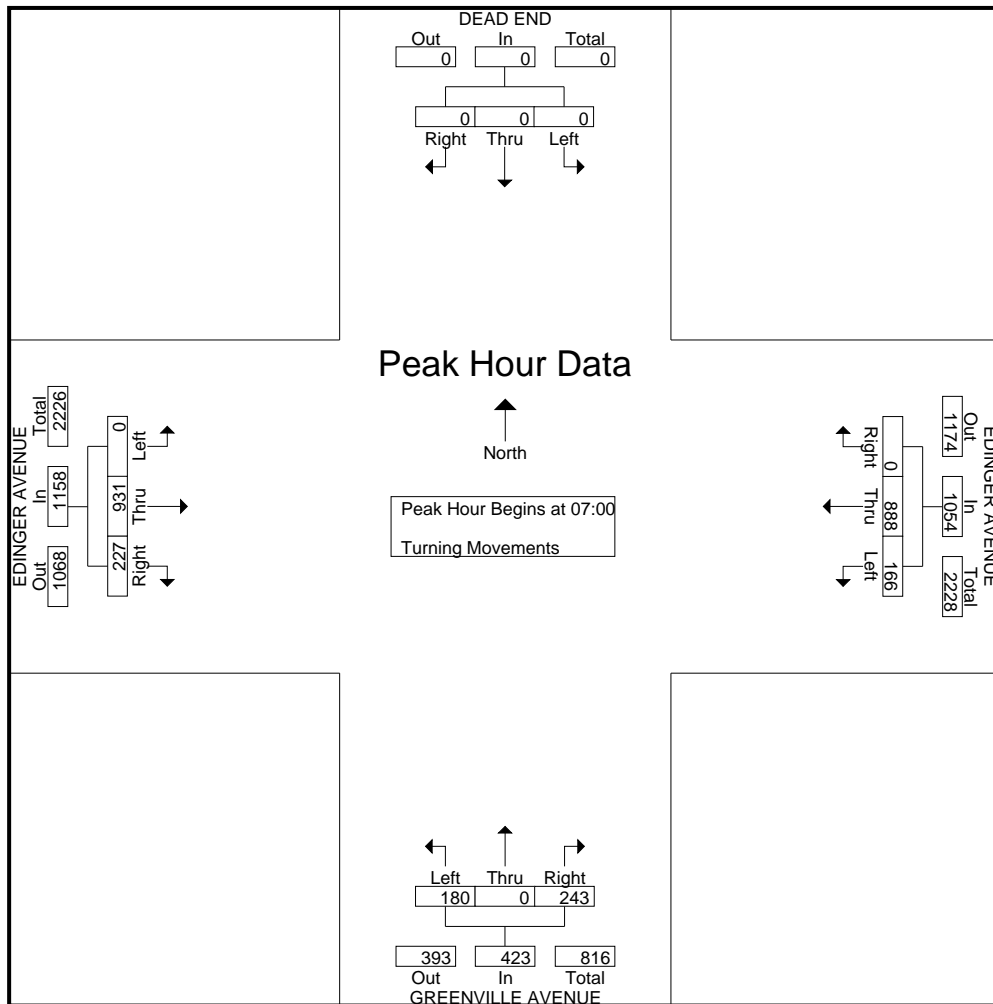

City: SANTA ANA
 N-S Direction: GREENVILLE STREET
 E-W Direction: EDINGER AVENUE

File Name : H1702003
 Site Code : 00000000
 Start Date : 2/7/2017
 Page No : 3

Start Time	DEAD END Southbound				EDINGER AVENUE Westbound				GREENVILLE AVENUE Northbound				EDINGER AVENUE Eastbound				Int. Total
	Right	Thru	Left	App. Total	Right	Thru	Left	App. Total	Right	Thru	Left	App. Total	Right	Thru	Left	App. Total	
Peak Hour Analysis From 16:00 to 17:45 - Peak 1 of 1																	
Peak Hour for Entire Intersection Begins at 16:45																	
16:45	0	0	0	0	0	280	19	299	55	0	78	133	49	236	0	285	717
17:00	0	0	0	0	0	270	30	300	49	0	78	127	54	245	0	299	726
17:15	0	0	0	0	0	274	24	298	53	0	85	138	52	208	0	260	696
17:30	0	0	0	0	0	270	19	289	54	0	76	130	39	264	0	303	722
Total Volume	0	0	0	0	0	1094	92	1186	211	0	317	528	194	953	0	1147	2861
% App. Total	0	0	0	0	0	92.2	7.8		40	0	60		16.9	83.1	0		
PHF	.000	.000	.000	.000	.000	.977	.767	.988	.959	.000	.932	.957	.898	.902	.000	.946	.985

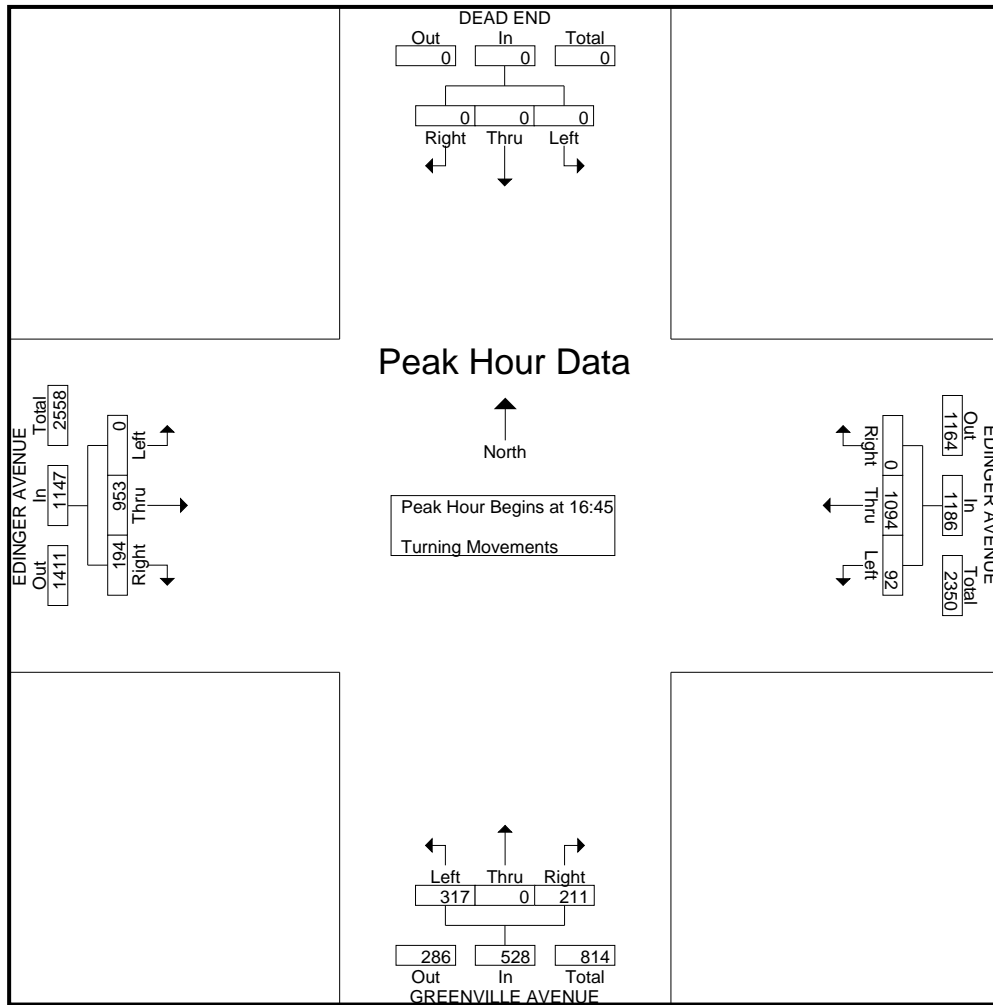

City: SANTA ANA
 N-S Direction: GREENVILLE STREET
 E-W Direction: SEGERSTROM AVENUE

File Name : H1702004
 Site Code : 00000000
 Start Date : 2/7/2017
 Page No : 1

Groups Printed- Turning Movements

Start Time	GREENVILLE STREET Southbound			SEGERSTROM AVENUE Westbound			GREENVILLE STREET Northbound			SEGERSTROM AVENUE Eastbound			Int. Total
	Right	Thru	Left	Right	Thru	Left	Right	Thru	Left	Right	Thru	Left	
07:00	18	44	21	11	97	9	10	9	6	11	119	5	360
07:15	23	88	27	12	114	24	8	41	6	26	175	10	554
07:30	44	139	49	12	161	40	17	37	9	31	193	10	742
07:45	53	138	45	29	189	57	27	62	12	29	191	5	837
Total	138	409	142	64	561	130	62	149	33	97	678	30	2493
08:00	35	93	28	20	178	38	23	47	18	28	158	7	673
08:15	17	59	32	8	98	6	6	31	10	7	176	9	459
08:30	15	50	14	7	99	1	7	10	5	9	185	7	409
08:45	11	28	8	4	97	6	6	11	3	5	130	6	315
Total	78	230	82	39	472	51	42	99	36	49	649	29	1856
*** BREAK ***													
16:00	8	36	8	25	215	7	4	69	13	7	167	32	591
16:15	12	38	12	25	254	8	4	112	15	12	147	24	663
16:30	14	45	14	27	229	5	6	101	11	5	174	37	668
16:45	6	35	6	24	252	8	9	111	21	8	166	25	671
Total	40	154	40	101	950	28	23	393	60	32	654	118	2593
17:00	13	38	13	35	223	4	7	121	17	12	207	30	720
17:15	14	52	14	37	280	6	12	128	15	10	207	31	806
17:30	15	58	15	38	246	6	5	105	8	11	213	28	748
17:45	17	46	17	33	257	10	10	108	15	12	171	15	711
Total	59	194	59	143	1006	26	34	462	55	45	798	104	2985
Grand Total	315	987	323	347	2989	235	161	1103	184	223	2779	281	9927
Apprch %	19.4	60.7	19.9	9.7	83.7	6.6	11.1	76.2	12.7	6.8	84.6	8.6	
Total %	3.2	9.9	3.3	3.5	30.1	2.4	1.6	11.1	1.9	2.2	28	2.8	

City: SANTA ANA
 N-S Direction: GREENVILLE STREET
 E-W Direction: SEGERSTROM AVENUE

File Name : H1702004
 Site Code : 00000000
 Start Date : 2/7/2017
 Page No : 2

Start Time	GREENVILLE STREET Southbound				SEGERSTROM AVENUE Westbound				GREENVILLE STREET Northbound				SEGERSTROM AVENUE Eastbound				Int. Total
	Right	Thru	Left	App. Total	Right	Thru	Left	App. Total	Right	Thru	Left	App. Total	Right	Thru	Left	App. Total	
Peak Hour Analysis From 07:00 to 08:45 - Peak 1 of 1																	
Peak Hour for Entire Intersection Begins at 07:15																	
07:15	23	88	27	138	12	114	24	150	8	41	6	55	26	175	10	211	554
07:30	44	139	49	232	12	161	40	213	17	37	9	63	31	193	10	234	742
07:45	53	138	45	236	29	189	57	275	27	62	12	101	29	191	5	225	837
08:00	35	93	28	156	20	178	38	236	23	47	18	88	28	158	7	193	673
Total Volume	155	458	149	762	73	642	159	874	75	187	45	307	114	717	32	863	2806
% App. Total	20.3	60.1	19.6		8.4	73.5	18.2		24.4	60.9	14.7		13.2	83.1	3.7		
PHF	.731	.824	.760	.807	.629	.849	.697	.795	.694	.754	.625	.760	.919	.929	.800	.922	.838

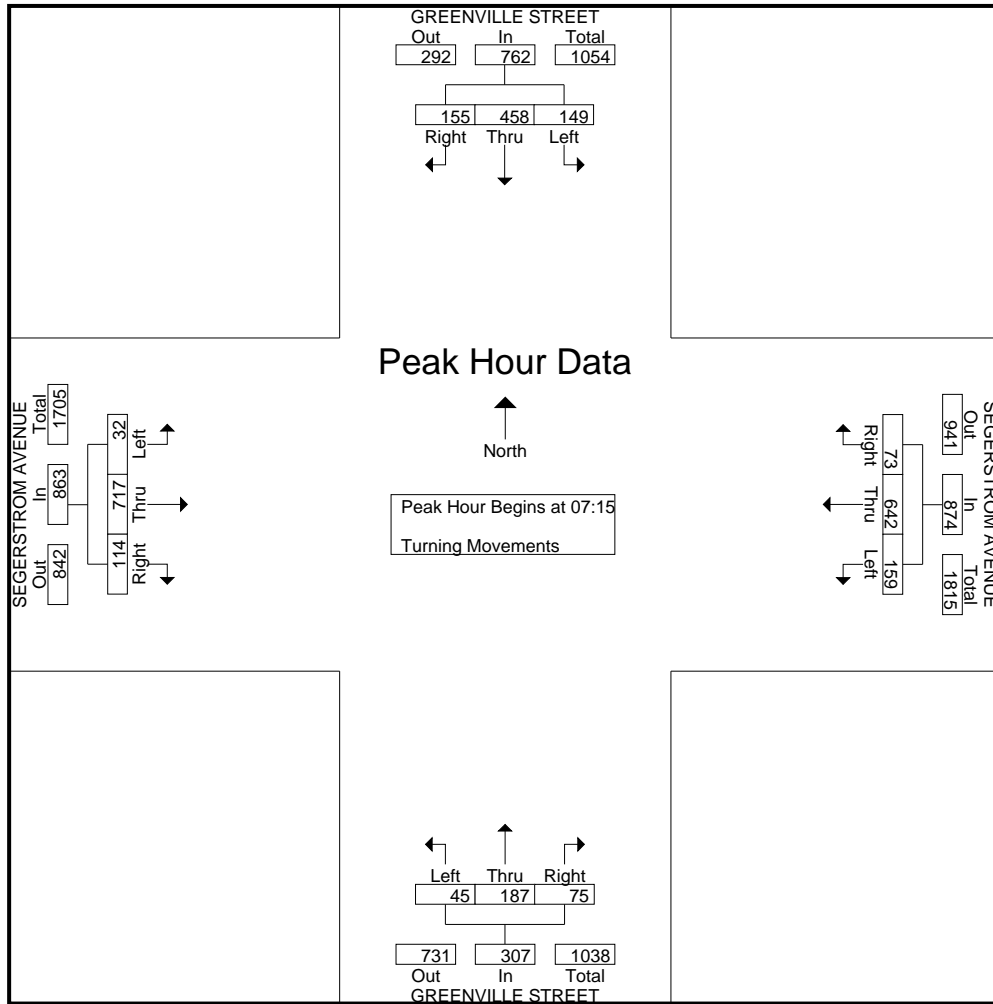

City: SANTA ANA
 N-S Direction: GREENVILLE STREET
 E-W Direction: SEGERSTROM AVENUE

File Name : H1702004
 Site Code : 00000000
 Start Date : 2/7/2017
 Page No : 3

Start Time	GREENVILLE STREET Southbound				SEGERSTROM AVENUE Westbound				GREENVILLE STREET Northbound				SEGERSTROM AVENUE Eastbound				Int. Total
	Right	Thru	Left	App. Total	Right	Thru	Left	App. Total	Right	Thru	Left	App. Total	Right	Thru	Left	App. Total	
Peak Hour Analysis From 16:00 to 17:45 - Peak 1 of 1																	
Peak Hour for Entire Intersection Begins at 17:00																	
17:00	13	38	13	64	35	223	4	262	7	121	17	145	12	207	30	249	720
17:15	14	52	14	80	37	280	6	323	12	128	15	155	10	207	31	248	806
17:30	15	58	15	88	38	246	6	290	5	105	8	118	11	213	28	252	748
17:45	17	46	17	80	33	257	10	300	10	108	15	133	12	171	15	198	711
Total Volume	59	194	59	312	143	1006	26	1175	34	462	55	551	45	798	104	947	2985
% App. Total	18.9	62.2	18.9		12.2	85.6	2.2		6.2	83.8	10		4.8	84.3	11		
PHF	.868	.836	.868	.886	.941	.898	.650	.909	.708	.902	.809	.889	.938	.937	.839	.939	.926

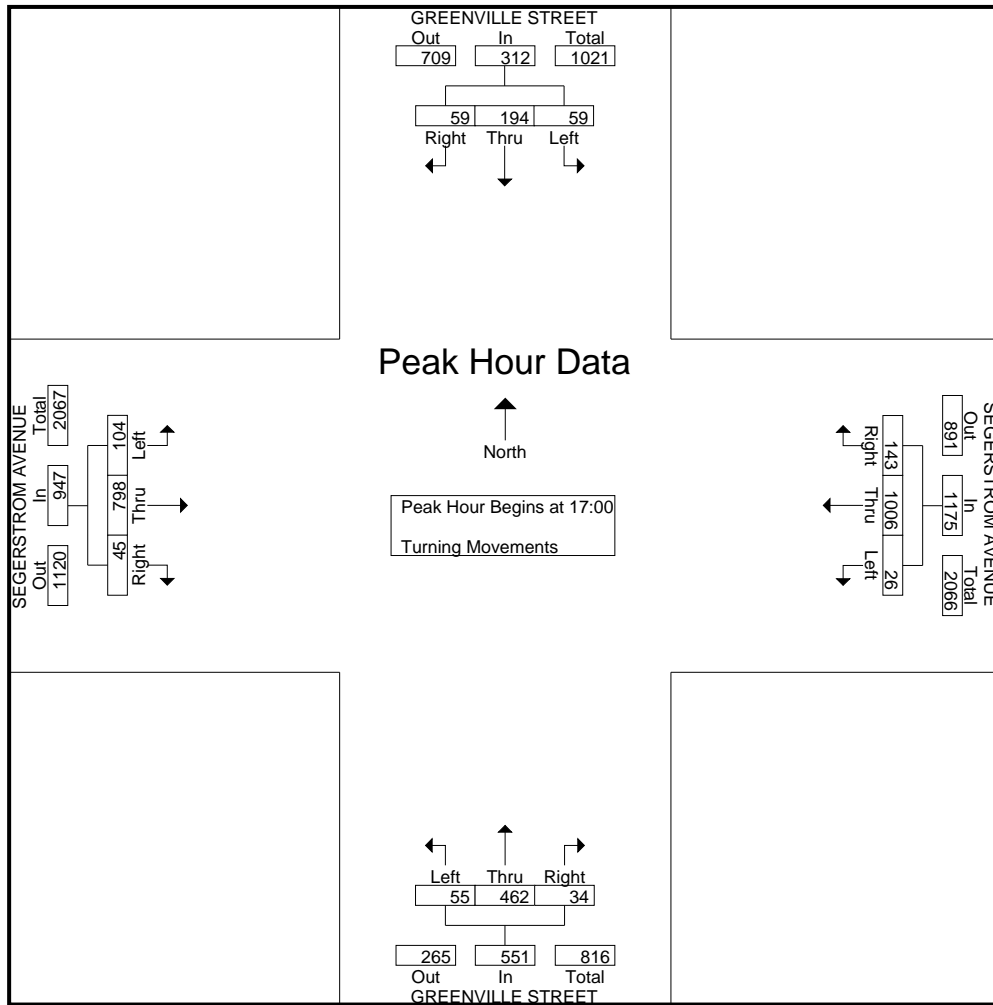

INTERSECTION TURNING MOVEMENT COUNTS

PREPARED BY: AimTD LLC. tel: 714 253 7888 pacific@aimtd.com

DATE: Tue, Feb 9, 16	LOCATION: NORTH & SOUTH: EAST & WEST:	Santa Ana Raitt McFadden	PROJECT #: SC0846 LOCATION #: 34 CONTROL: SIGNAL
--------------------------------	--	--------------------------------	---

NOTES:	AM PM MD OTHER OTHER	▲ N ▼ S	◀ W E ▶	
---------------	----------------------------------	------------------	------------	--

Add U-Turns to Left Turns

	NORTHBOUND			SOUTHBOUND			EASTBOUND			WESTBOUND			TOTAL
	Raitt			Raitt			McFadden			McFadden			
LANES:	NL	NT	NR	SL	ST	SR	EL	ET	ER	WL	WT	WR	
AM													
7:00 AM	6	75	22	9	149	13	12	142	21	24	87	10	570
7:15 AM	8	109	20	20	231	25	24	130	25	39	124	18	773
7:30 AM	8	153	21	27	213	25	24	175	22	54	155	26	903
7:45 AM	20	137	18	28	183	27	23	190	25	47	133	22	853
8:00 AM	23	148	27	21	105	22	40	181	14	25	108	27	741
8:15 AM	9	88	15	20	95	14	24	137	18	13	105	10	548
8:30 AM	11	62	16	10	82	14	18	132	11	10	120	14	500
8:45 AM	7	63	13	11	58	15	16	123	2	12	109	13	442
VOLUMES	92	835	152	146	1,116	155	181	1,210	138	224	941	140	5,330
APPROACH %	9%	77%	14%	10%	79%	11%	12%	79%	9%	17%	72%	11%	
APP/DEPART	1,079	/	1,156	1,417	/	1,478	1,529	/	1,508	1,305	/	1,188	0
BEGIN PEAK HR	7:15 AM												
VOLUMES	59	547	86	96	732	99	111	676	86	165	520	93	3,270
APPROACH %	9%	79%	12%	10%	79%	11%	13%	77%	10%	21%	67%	12%	
PEAK HR FACTOR	0.874			0.840			0.917			0.828			0.905
APP/DEPART	692	/	751	927	/	983	873	/	858	778	/	678	0
PM													
4:00 PM	12	184	34	11	91	12	23	157	8	18	114	17	681
4:15 PM	13	171	32	8	93	17	15	160	6	31	174	21	741
4:30 PM	16	191	29	11	92	17	28	151	11	21	158	22	747
4:45 PM	12	198	17	11	109	13	19	160	11	19	184	25	778
5:00 PM	18	181	39	10	98	12	24	180	14	24	158	29	787
5:15 PM	11	209	31	9	114	21	30	172	10	12	193	29	841
5:30 PM	17	210	30	11	121	18	37	190	18	21	166	22	861
5:45 PM	9	202	24	13	122	22	30	175	20	27	196	18	858
VOLUMES	108	1,546	236	84	840	132	206	1,345	98	173	1,343	183	6,294
APPROACH %	6%	82%	12%	8%	80%	13%	12%	82%	6%	10%	79%	11%	
APP/DEPART	1,890	/	1,935	1,056	/	1,111	1,649	/	1,665	1,699	/	1,583	0
BEGIN PEAK HR	5:00 PM												
VOLUMES	55	802	124	43	455	73	121	717	62	84	713	98	3,347
APPROACH %	6%	82%	13%	8%	80%	13%	13%	80%	7%	9%	80%	11%	
PEAK HR FACTOR	0.954			0.909			0.918			0.928			0.972
APP/DEPART	981	/	1,021	571	/	601	900	/	884	895	/	841	0

U-TURNS				
NB	SB	EB	WB	TTL
0	0	0	0	0
0	0	0	0	0
0	0	0	0	0
0	0	0	0	0
0	0	0	0	0
0	0	0	0	0
0	0	0	0	0
0	0	0	0	0
0	0	0	0	0
0	0	0	0	0
0	0	0	0	0
0	0	0	0	0
0	0	0	0	0
0	0	0	0	0
0	0	0	0	0

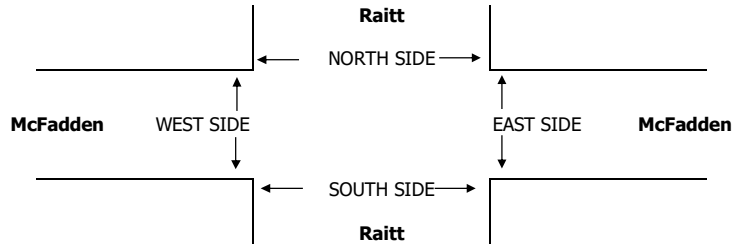

	N SIDE	S SIDE	E SIDE	W SIDE	TOTAL
AM					
7:00 AM	19	8	1	16	44
7:15 AM	12	8	6	24	50
7:30 AM	23	30	12	36	101
7:45 AM	62	19	13	44	138
8:00 AM	16	15	5	27	63
8:15 AM	6	19	2	12	39
8:30 AM	11	14	0	10	35
8:45 AM	5	8	4	3	20
TOTAL	154	121	43	172	490
PM					
4:00 PM	13	14	7	17	51
4:15 PM	9	17	4	14	44
4:30 PM	12	5	7	6	30
4:45 PM	7	11	4	12	34
5:00 PM	7	9	3	15	34
5:15 PM	13	16	14	15	58
5:30 PM	6	12	1	20	39
5:45 PM	12	17	5	13	47
TOTAL	79	101	45	112	337

PEDESTRIAN + BIKE CROSSINGS				
N SIDE	S SIDE	E SIDE	W SIDE	TOTAL
17	6	1	14	38
9	6	3	22	40
23	28	10	35	96
60	18	11	42	131
13	12	1	25	51
4	18	1	12	35
10	12	0	10	32
4	7	4	3	18
140	107	31	163	441
11	13	5	17	46
6	11	3	12	32
9	2	7	6	24
5	7	2	12	26
3	7	2	15	27
12	15	13	15	55
5	7	0	19	31
7	14	5	12	38
58	76	37	108	279

PEDESTRIAN CROSSINGS				
N SIDE	S SIDE	E SIDE	W SIDE	TOTAL
2	2	0	2	6
3	2	3	2	10
0	2	2	1	5
2	1	2	2	7
3	3	4	2	12
2	1	1	0	4
1	2	0	0	3
1	1	0	0	2
14	14	12	9	49
2	1	2	0	5
3	6	1	2	12
3	3	0	0	6
2	4	2	0	8
4	2	1	0	7
1	1	1	0	3
1	5	1	1	8
5	3	0	1	9
21	25	8	4	58

BICYCLE CROSSINGS				
NS	SS	ES	WS	TOTAL
2	2	0	2	6
3	2	3	2	10
0	2	2	1	5
2	1	2	2	7
3	3	4	2	12
2	1	1	0	4
1	2	0	0	3
1	1	0	0	2
14	14	12	9	49
2	1	2	0	5
3	6	1	2	12
3	3	0	0	6
2	4	2	0	8
4	2	1	0	7
1	1	1	0	3
1	5	1	1	8
5	3	0	1	9
21	25	8	4	58

INTERSECTION TURNING MOVEMENT COUNTS

PREPARED BY: AimTD LLC. tel: 714 253 7888 pacific@aimtd.com

DATE: Tue, Feb 9, 16	LOCATION: NORTH & SOUTH: EAST & WEST:	Santa Ana Raitt Edinger	PROJECT #: LOCATION #: CONTROL:	SC0846 40 SIGNAL
--------------------------------	---	-------------------------------	---------------------------------------	------------------------

NOTES:	AM PM MD OTHER OTHER	▲ N ▼ S	◀ W E ▶	
--------	----------------------------------	------------------	------------	--

Add U-Turns to Left Turns

	NORTHBOUND			SOUTHBOUND			EASTBOUND			WESTBOUND			TOTAL
	Raitt			Raitt			Edinger			Edinger			
LANES:	NL	NT	NR	SL	ST	SR	EL	ET	ER	WL	WT	WR	
AM													
7:00 AM	20	71	19	25	121	29	22	198	28	22	198	7	760
7:15 AM	33	93	33	25	173	32	45	240	42	24	250	13	1,003
7:30 AM	55	125	42	48	193	14	38	222	37	36	223	11	1,044
7:45 AM	45	123	45	36	178	15	41	254	24	32	215	11	1,019
8:00 AM	47	140	53	37	144	20	34	252	36	20	192	16	991
8:15 AM	28	82	28	32	71	15	11	249	33	14	160	16	739
8:30 AM	10	56	22	35	57	8	8	205	9	17	171	11	609
8:45 AM	19	44	19	24	61	11	13	205	8	15	151	11	581
VOLUMES	257	734	261	262	998	144	212	1,825	217	180	1,560	96	6,746
APPROACH %	21%	59%	21%	19%	71%	10%	9%	81%	10%	10%	85%	5%	
APP/DEPART	1,252	/	1,042	1,404	/	1,395	2,254	/	2,348	1,836	/	1,961	0
BEGIN PEAK HR	7:15 AM												
VOLUMES	180	481	173	146	688	81	158	968	139	112	880	51	4,057
APPROACH %	22%	58%	21%	16%	75%	9%	12%	77%	11%	11%	84%	5%	
PEAK HR FACTOR	0.869			0.897			0.967			0.909			0.972
APP/DEPART	834	/	690	915	/	939	1,265	/	1,287	1,043	/	1,141	0
PM													
4:00 PM	32	190	58	16	71	20	24	244	25	14	245	19	958
4:15 PM	35	173	61	22	81	21	30	210	30	16	240	28	947
4:30 PM	51	169	32	32	64	26	29	222	18	23	231	28	925
4:45 PM	50	203	56	24	93	26	34	214	28	17	235	26	1,006
5:00 PM	50	198	47	29	76	18	31	227	34	19	257	16	1,002
5:15 PM	37	193	63	32	90	25	34	216	31	20	244	20	1,005
5:30 PM	36	193	55	17	107	21	30	255	26	21	238	27	1,026
5:45 PM	59	200	55	28	96	28	38	225	40	22	195	20	1,006
VOLUMES	350	1,519	427	200	678	185	250	1,813	232	152	1,885	184	7,875
APPROACH %	15%	66%	19%	19%	64%	17%	11%	79%	10%	7%	85%	8%	
APP/DEPART	2,296	/	1,953	1,063	/	1,062	2,295	/	2,440	2,221	/	2,420	0
BEGIN PEAK HR	5:00 PM												
VOLUMES	182	784	220	106	369	92	133	923	131	82	934	83	4,039
APPROACH %	15%	66%	19%	19%	65%	16%	11%	78%	11%	7%	85%	8%	
PEAK HR FACTOR	0.944			0.933			0.954			0.941			0.984
APP/DEPART	1,186	/	1,000	567	/	582	1,187	/	1,249	1,099	/	1,208	0

U-TURNS				
NB	SB	EB	WB	TTL
0	0	0	0	0
0	0	0	0	0
0	0	0	0	0
0	0	0	0	0
0	0	0	0	0
0	0	0	0	0
0	0	0	0	0
0	0	0	0	0
0	0	0	0	0
0	0	0	0	0
0	0	0	0	0
0	0	0	0	0
0	0	0	0	0
0	0	0	0	0
0	0	0	0	0

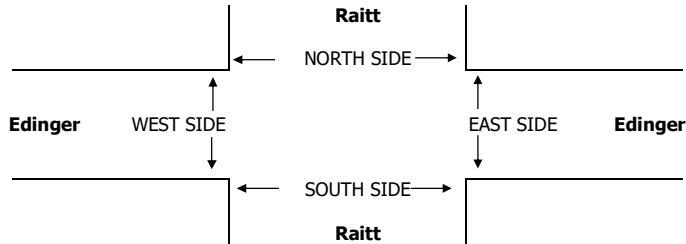

	AM	PM
7:00 AM		
7:15 AM		
7:30 AM		
7:45 AM		
8:00 AM		
8:15 AM		
8:30 AM		
8:45 AM		
TOTAL		
4:00 PM		
4:15 PM		
4:30 PM		
4:45 PM		
5:00 PM		
5:15 PM		
5:30 PM		
5:45 PM		
TOTAL		

PEDESTRIAN + BIKE CROSSINGS				
N SIDE	S SIDE	E SIDE	W SIDE	TOTAL
12	32	8	17	69
48	33	7	27	115
86	52	24	78	240
91	65	41	70	267
51	57	29	55	192
11	29	8	15	63
7	4	2	2	15
8	3	2	5	18
314	275	121	269	979
27	27	14	16	84
12	13	7	3	35
17	22	5	11	55
27	31	22	22	102
11	24	9	21	65
21	25	8	17	71
25	16	12	12	65
7	12	3	11	33
147	170	80	113	510

PEDESTRIAN CROSSINGS				
N SIDE	S SIDE	E SIDE	W SIDE	TOTAL
10	26	6	16	58
46	27	7	26	106
81	47	24	75	227
87	60	39	68	254
48	53	28	52	181
10	28	7	15	60
6	2	2	2	12
8	2	2	5	17
296	245	115	259	915
19	23	13	13	68
7	11	5	3	26
7	14	4	6	31
20	29	19	18	86
10	17	9	20	56
15	18	4	15	52
21	9	7	12	49
6	3	3	6	18
105	124	64	93	386

BICYCLE CROSSINGS				
NS	SS	ES	WS	TOTAL
2	6	2	1	11
2	6	0	1	9
5	5	0	3	13
4	5	2	2	13
3	4	1	3	11
1	1	1	0	3
1	2	0	0	3
0	1	0	0	1
18	30	6	10	64
8	4	1	3	16
5	2	2	0	9
10	8	1	5	24
7	2	3	4	16
1	7	0	1	9
6	7	4	2	19
4	7	5	0	16
1	9	0	5	15
42	46	16	20	124

City: SANTA ANA
 N-S Direction: BEAR STREET
 E-W Direction: MACARTHUR BOULEVARD

File Name : H1702005
 Site Code : 00000000
 Start Date : 2/7/2017
 Page No : 1

Groups Printed- Turning Movements

Start Time	BEAR STREET Southbound			MACARTHUR BOULEVARD Westbound			BEAR STREET Northbound			MACARTHUR BOULEVARD Eastbound			Int. Total
	Right	Thru	Left	Right	Thru	Left	Right	Thru	Left	Right	Thru	Left	
07:00	22	100	28	11	160	5	26	63	9	17	271	9	721
07:15	56	154	42	19	294	16	27	66	21	23	382	11	1111
07:30	77	198	53	30	380	13	25	49	24	26	434	19	1328
07:45	111	199	45	31	342	17	30	72	20	36	392	34	1329
Total	266	651	168	91	1176	51	108	250	74	102	1479	73	4489
08:00	47	182	53	17	129	21	33	84	13	25	406	30	1040
08:15	26	155	43	13	136	14	36	85	5	27	346	14	900
08:30	18	127	37	6	109	11	36	69	10	53	386	7	869
08:45	19	95	23	14	110	16	34	46	10	30	276	10	683
Total	110	559	156	50	484	62	139	284	38	135	1414	61	3492
*** BREAK ***													
16:00	16	43	18	53	395	17	67	196	39	25	210	14	1093
16:15	13	74	19	66	388	16	59	210	59	18	214	16	1152
16:30	14	60	27	62	417	25	62	214	46	24	223	15	1189
16:45	17	62	24	65	396	25	59	227	51	20	213	21	1180
Total	60	239	88	246	1596	83	247	847	195	87	860	66	4614
17:00	17	63	25	69	386	18	58	242	46	20	240	29	1213
17:15	21	75	36	66	399	20	68	244	56	20	206	18	1229
17:30	24	63	23	58	442	27	58	220	41	31	224	26	1237
17:45	32	66	28	59	416	29	56	204	48	18	198	22	1176
Total	94	267	112	252	1643	94	240	910	191	89	868	95	4855
Grand Total	530	1716	524	639	4899	290	734	2291	498	413	4621	295	17450
Apprch %	19.1	61.9	18.9	11	84.1	5	20.8	65	14.1	7.8	86.7	5.5	
Total %	3	9.8	3	3.7	28.1	1.7	4.2	13.1	2.9	2.4	26.5	1.7	

City: SANTA ANA
 N-S Direction: BEAR STREET
 E-W Direction: MACARTHUR BOULEVARD

File Name : H1702005
 Site Code : 00000000
 Start Date : 2/7/2017
 Page No : 2

Start Time	BEAR STREET Southbound				MACARTHUR BOULEVARD Westbound				BEAR STREET Northbound				MACARTHUR BOULEVARD Eastbound				Int. Total
	Right	Thru	Left	App. Total	Right	Thru	Left	App. Total	Right	Thru	Left	App. Total	Right	Thru	Left	App. Total	
Peak Hour Analysis From 07:00 to 08:45 - Peak 1 of 1																	
Peak Hour for Entire Intersection Begins at 07:15																	
07:15	56	154	42	252	19	294	16	329	27	66	21	114	23	382	11	416	1111
07:30	77	198	53	328	30	380	13	423	25	49	24	98	26	434	19	479	1328
07:45	111	199	45	355	31	342	17	390	30	72	20	122	36	392	34	462	1329
08:00	47	182	53	282	17	129	21	167	33	84	13	130	25	406	30	461	1040
Total Volume	291	733	193	1217	97	1145	67	1309	115	271	78	464	110	1614	94	1818	4808
% App. Total	23.9	60.2	15.9		7.4	87.5	5.1		24.8	58.4	16.8		6.1	88.8	5.2		
PHF	.655	.921	.910	.857	.782	.753	.798	.774	.871	.807	.813	.892	.764	.930	.691	.949	.904

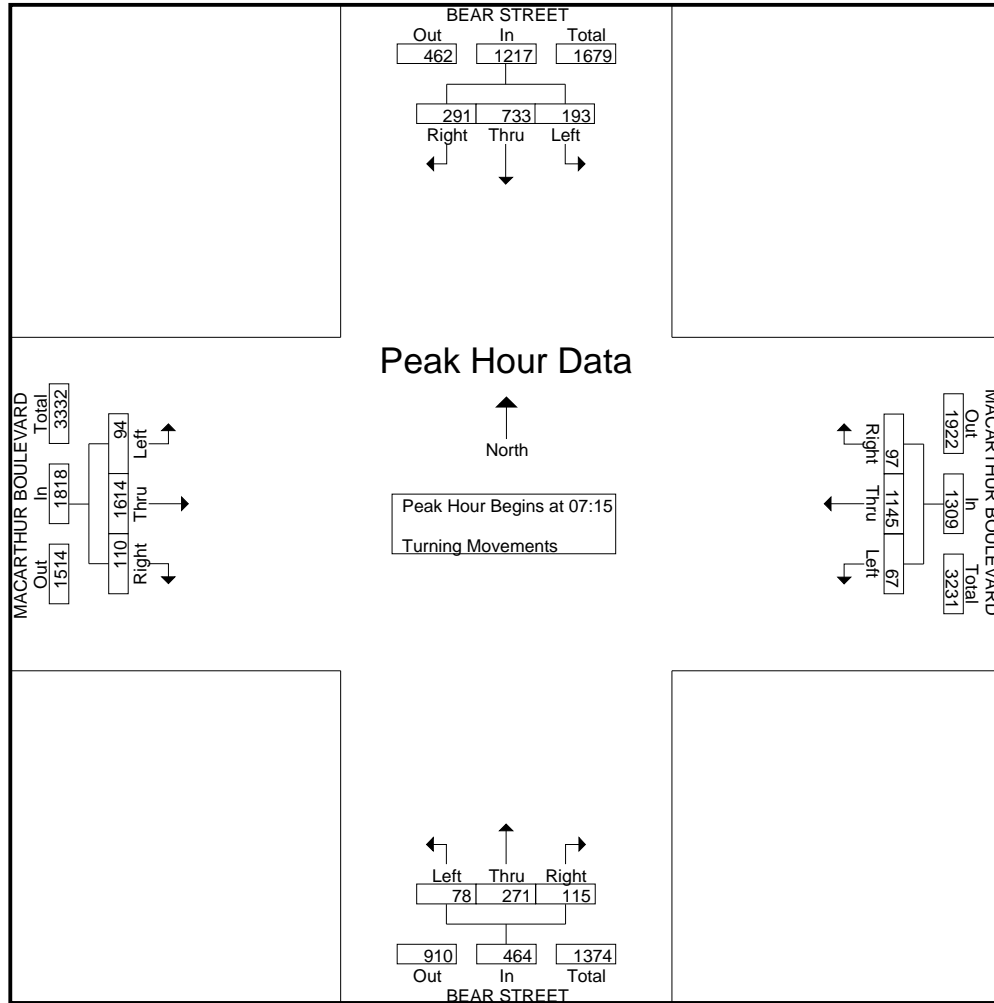

City: SANTA ANA
 N-S Direction: BEAR STREET
 E-W Direction: MACARTHUR BOULEVARD

File Name : H1702005
 Site Code : 00000000
 Start Date : 2/7/2017
 Page No : 3

Start Time	BEAR STREET Southbound				MACARTHUR BOULEVARD Westbound				BEAR STREET Northbound				MACARTHUR BOULEVARD Eastbound				Int. Total
	Right	Thru	Left	App. Total	Right	Thru	Left	App. Total	Right	Thru	Left	App. Total	Right	Thru	Left	App. Total	
Peak Hour Analysis From 16:00 to 17:45 - Peak 1 of 1																	
Peak Hour for Entire Intersection Begins at 16:45																	
16:45	17	62	24	103	65	396	25	486	59	227	51	337	20	213	21	254	1180
17:00	17	63	25	105	69	386	18	473	58	242	46	346	20	240	29	289	1213
17:15	21	75	36	132	66	399	20	485	68	244	56	368	20	206	18	244	1229
17:30	24	63	23	110	58	442	27	527	58	220	41	319	31	224	26	281	1237
Total Volume	79	263	108	450	258	1623	90	1971	243	933	194	1370	91	883	94	1068	4859
% App. Total	17.6	58.4	24		13.1	82.3	4.6		17.7	68.1	14.2		8.5	82.7	8.8		
PHF	.823	.877	.750	.852	.935	.918	.833	.935	.893	.956	.866	.931	.734	.920	.810	.924	.982

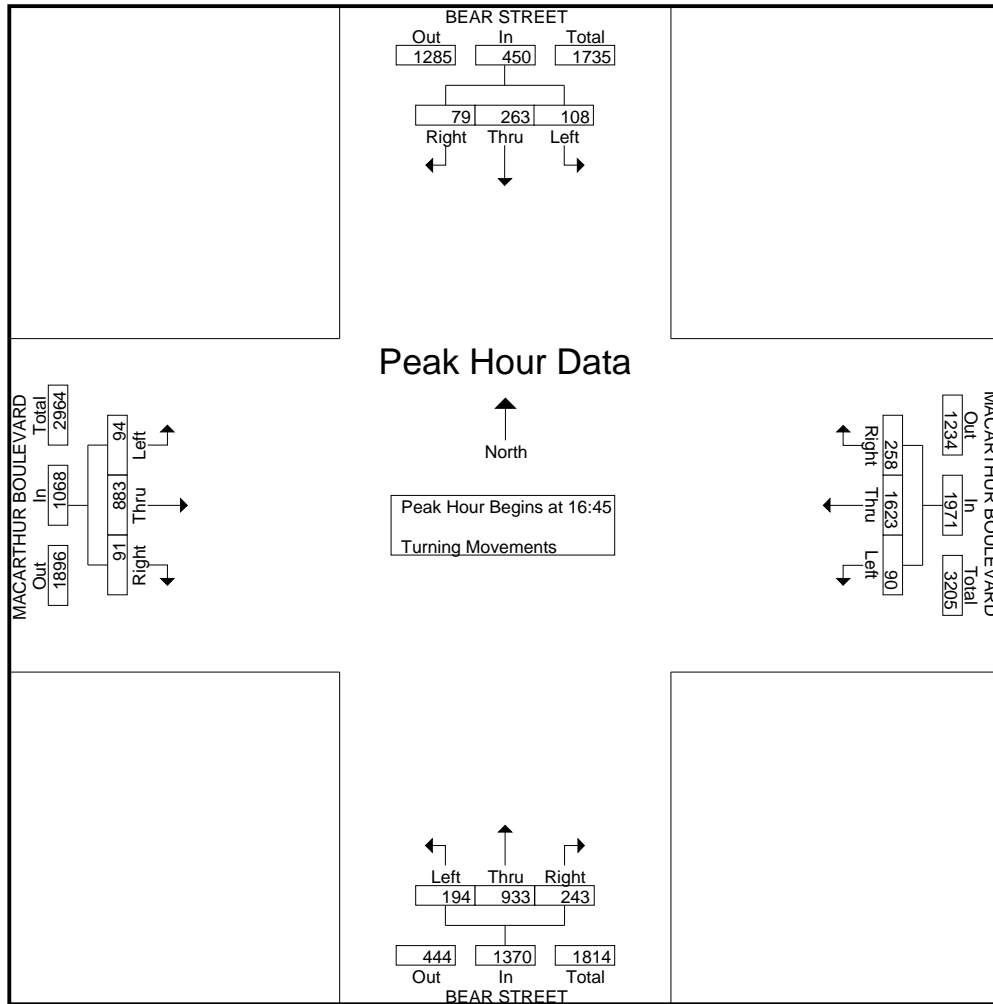

INTERSECTION TURNING MOVEMENT COUNTS

PREPARED BY: AimTD LLC. tel: 714 253 7888 cs@aimtd.com

T218

DATE: Tue, May 14, 19	LOCATION:	Santa Ana	PROJECT #:	SC2183
	NORTH & SOUTH:	Bristol	LOCATION #:	12
	EAST & WEST:	17th	CONTROL:	SIGNAL

NOTES:

	NORTHBOUND			SOUTHBOUND			EASTBOUND			WESTBOUND			TOTAL
	Bristol			Bristol			17th			17th			
LANES:	NL	NT	NR	SL	ST	SR	EL	ET	ER	WL	WT	WR	

U-TURNS				
NB	SB	EB	WB	TTL

AM	7:00 AM	23	254	42	59	328	28	47	230	34	46	116	51	1,258
	7:15 AM	32	285	28	83	324	26	67	258	35	48	141	69	1,396
	7:30 AM	45	270	41	102	342	21	78	281	38	76	202	92	1,588
	7:45 AM	59	234	49	94	311	40	86	250	33	87	225	73	1,541
	8:00 AM	39	248	39	83	368	46	71	183	42	91	184	51	1,445
	8:15 AM	47	226	36	52	341	72	85	239	41	101	204	54	1,498
	8:30 AM	39	256	43	53	361	61	63	203	26	51	129	22	1,307
	8:45 AM	37	246	38	65	280	63	55	174	37	51	93	31	1,170
	VOLUMES	321	2,019	316	591	2,655	357	552	1,818	286	551	1,294	443	11,203
APPROACH %	12%	76%	12%	16%	74%	10%	21%	68%	11%	24%	57%	19%		
APP/DEPART	2,656	/	3,013	3,603	/	3,480	2,656	/	2,768	2,288	/	1,942	0	
BEGIN PEAK HR	7:30 AM													
VOLUMES	190	978	165	331	1,362	179	320	953	154	355	815	270	6,072	
APPROACH %	14%	73%	12%	18%	73%	10%	22%	67%	11%	25%	57%	19%		
PEAK HR FACTOR	0.936			0.942			0.899			0.935			0.956	
APP/DEPART	1,333	/	1,567	1,872	/	1,858	1,427	/	1,477	1,440	/	1,170	0	
PM	4:00 PM	43	282	37	68	272	60	85	168	25	48	260	76	1,424
	4:15 PM	45	282	37	66	295	50	61	178	33	63	234	67	1,411
	4:30 PM	40	277	26	53	286	48	69	193	34	55	308	71	1,460
	4:45 PM	36	281	40	68	308	45	74	177	28	70	255	87	1,469
	5:00 PM	61	284	58	50	311	56	85	192	40	57	286	107	1,587
	5:15 PM	53	264	41	62	317	54	97	223	30	71	247	81	1,540
	5:30 PM	55	304	42	75	322	57	71	163	37	77	265	93	1,561
	5:45 PM	64	284	48	53	330	50	79	164	27	76	260	77	1,512
	VOLUMES	397	2,258	329	495	2,441	420	621	1,458	254	517	2,115	659	11,964
APPROACH %	13%	76%	11%	15%	73%	13%	27%	62%	11%	16%	64%	20%		
APP/DEPART	2,984	/	3,534	3,356	/	3,174	2,333	/	2,344	3,291	/	2,912	0	
BEGIN PEAK HR	5:00 PM													
VOLUMES	233	1,136	189	240	1,280	217	332	742	134	281	1,058	358	6,200	
APPROACH %	15%	73%	12%	14%	74%	12%	27%	61%	11%	17%	62%	21%		
PEAK HR FACTOR	0.967			0.956			0.863			0.943			0.977	
APP/DEPART	1,558	/	1,822	1,737	/	1,678	1,208	/	1,205	1,697	/	1,495	0	

4	0	0	2	6
3	0	0	3	6
3	0	0	8	11
2	1	1	8	12
4	0	0	11	15
7	0	1	2	10
5	0	0	5	10
5	1	1	6	13
33	2	3	45	83

2	2	2	7	13
4	1	0	12	17
2	1	0	7	10
3	0	2	6	11
5	0	1	7	13
2	0	2	8	12
2	0	1	8	11
8	0	0	11	19
28	4	8	66	106

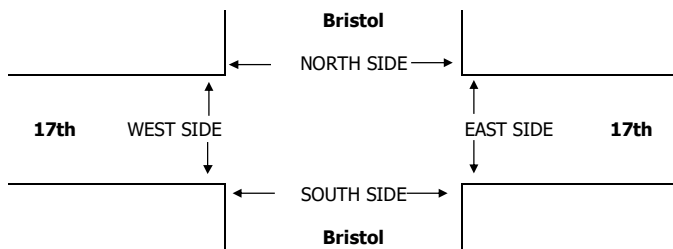

	PEDESTRIAN + BIKE CROSSINGS				
	N SIDE	S SIDE	E SIDE	W SIDE	TOTAL
AM					
7:00 AM	0	0	0	0	0
7:15 AM	0	0	0	0	0
7:30 AM	0	0	0	0	0
7:45 AM	0	0	0	0	0
8:00 AM	0	0	0	0	0
8:15 AM	0	0	0	0	0
8:30 AM	0	0	0	0	0
8:45 AM	0	0	0	0	0
TOTAL	0	0	0	0	0
AM BEGIN PEAK HR					
PM					
4:00 PM	0	0	0	0	0
4:15 PM	0	0	0	0	0
4:30 PM	0	0	0	0	0
4:45 PM	0	0	0	0	0
5:00 PM	0	0	0	0	0
5:15 PM	0	0	0	0	0
5:30 PM	0	0	0	0	0
5:45 PM	0	0	0	0	0
TOTAL	0	0	0	0	0
PM BEGIN PEAK HR					

	PEDESTRIAN CROSSINGS				
	N SIDE	S SIDE	E SIDE	W SIDE	TOTAL
AM					
7:00 AM	0	0	0	0	0
7:15 AM	0	0	0	0	0
7:30 AM	0	0	0	0	0
7:45 AM	0	0	0	0	0
8:00 AM	0	0	0	0	0
8:15 AM	0	0	0	0	0
8:30 AM	0	0	0	0	0
8:45 AM	0	0	0	0	0
TOTAL	0	0	0	0	0
AM BEGIN PEAK HR					
PM					
4:00 PM	0	0	0	0	0
4:15 PM	0	0	0	0	0
4:30 PM	0	0	0	0	0
4:45 PM	0	0	0	0	0
5:00 PM	0	0	0	0	0
5:15 PM	0	0	0	0	0
5:30 PM	0	0	0	0	0
5:45 PM	0	0	0	0	0
TOTAL	0	0	0	0	0
PM BEGIN PEAK HR					

	BICYCLE CROSSINGS				
	NS	SS	ES	WS	TOTAL
AM					
7:00 AM	0	0	0	0	0
7:15 AM	0	0	0	0	0
7:30 AM	0	0	0	0	0
7:45 AM	0	0	0	0	0
8:00 AM	0	0	0	0	0
8:15 AM	0	0	0	0	0
8:30 AM	0	0	0	0	0
8:45 AM	0	0	0	0	0
TOTAL	0	0	0	0	0
AM BEGIN PEAK HR					
PM					
4:00 PM	0	0	0	0	0
4:15 PM	0	0	0	0	0
4:30 PM	0	0	0	0	0
4:45 PM	0	0	0	0	0
5:00 PM	0	0	0	0	0
5:15 PM	0	0	0	0	0
5:30 PM	0	0	0	0	0
5:45 PM	0	0	0	0	0
TOTAL	0	0	0	0	0
PM BEGIN PEAK HR					

INTERSECTION TURNING MOVEMENT COUNTS

PREPARED BY: AimTD LLC. tel: 714 253 7888 pacific@aimtd.com

DATE:
Wed, Feb 10, 16

LOCATION:
NORTH & SOUTH: Santa Ana
EAST & WEST: Bristol
Civic Center

PROJECT #: SC0846
LOCATION #: 13
CONTROL: SIGNAL

NOTES:

AM	▲	N	
PM		▼	S
MD	◀	W	E ▶
OTHER			

Add U-Turns to Left Turns

LANES:	NORTHBOUND			SOUTHBOUND			EASTBOUND			WESTBOUND			TOTAL
	NL	NT	NR	SL	ST	SR	EL	ET	ER	WL	WT	WR	

U-TURNS				
NB	SB	EB	WB	TTL

7:00 AM	15	257	12	66	336	19	35	100	24	26	44	8	942
7:15 AM	31	265	11	104	263	15	44	153	27	22	61	6	1,002
7:30 AM	28	256	15	83	297	22	49	195	28	25	77	14	1,089
7:45 AM	39	306	21	87	291	16	37	217	18	21	103	17	1,173
8:00 AM	37	240	17	72	288	27	29	182	28	45	136	25	1,126
8:15 AM	14	242	39	63	357	11	28	131	15	25	69	23	1,017
8:30 AM	18	267	27	70	357	14	24	101	14	15	63	14	984
8:45 AM	13	259	19	57	326	17	21	94	20	23	53	13	915
VOLUMES	195	2,092	161	602	2,515	141	267	1,173	174	202	606	120	8,248
APPROACH %	8%	85%	7%	18%	77%	4%	17%	73%	11%	22%	65%	13%	
APP/DEPART	2,448	/	2,500	3,258	/	2,900	1,614	/	1,921	928	/	927	0
BEGIN PEAK HR	7:30 AM												
VOLUMES	118	1,044	92	305	1,233	76	143	725	89	116	385	79	4,405
APPROACH %	9%	83%	7%	19%	76%	5%	15%	76%	9%	20%	66%	14%	
PEAK HR FACTOR	0.857			0.936			0.880			0.704			0.939
APP/DEPART	1,254	/	1,281	1,614	/	1,436	957	/	1,113	580	/	575	0
4:00 PM	28	247	15	25	206	20	35	108	16	28	93	32	853
4:15 PM	44	335	16	37	311	29	37	101	12	21	86	33	1,062
4:30 PM	36	314	26	32	330	28	25	60	13	38	134	31	1,067
4:45 PM	41	314	20	30	296	30	56	80	17	41	133	52	1,110
5:00 PM	42	341	23	30	280	28	45	92	14	38	178	34	1,145
5:15 PM	55	371	21	38	311	30	32	153	13	38	212	17	1,291
5:30 PM	43	334	18	33	310	29	44	119	12	37	160	17	1,156
5:45 PM	52	298	8	29	300	36	61	149	21	49	144	10	1,157
VOLUMES	341	2,554	147	254	2,344	230	335	862	118	290	1,140	226	8,841
APPROACH %	11%	84%	5%	9%	83%	8%	25%	66%	9%	18%	69%	14%	
APP/DEPART	3,042	/	3,146	2,828	/	2,797	1,315	/	1,228	1,656	/	1,670	0
BEGIN PEAK HR	5:00 PM												
VOLUMES	192	1,344	70	130	1,201	123	182	513	60	162	694	78	4,749
APPROACH %	12%	84%	4%	9%	83%	8%	24%	68%	8%	17%	74%	8%	
PEAK HR FACTOR	0.898			0.959			0.817			0.875			0.920
APP/DEPART	1,606	/	1,618	1,454	/	1,442	755	/	699	934	/	990	0

2	1	0	0	3
2	0	0	0	2
1	1	0	0	2
0	4	0	0	4
3	5	0	0	8
0	5	0	6	11
3	3	0	0	6
4	2	0	0	6
15	21	0	6	42

8	7	0	0	15
9	5	0	0	14
5	6	0	0	11
4	3	4	0	11
1	1	0	0	2
6	3	0	0	9
7	7	0	0	14
5	3	0	0	8
45	35	4	0	84

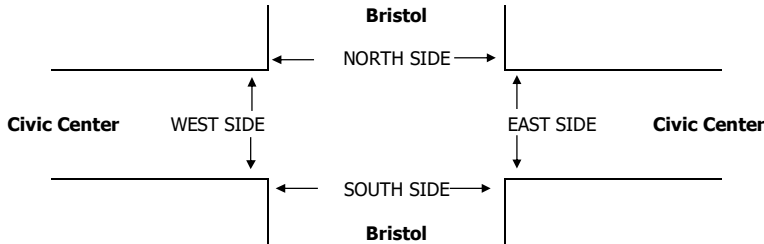

	PEDESTRIAN + BIKE CROSSINGS				
	N SIDE	S SIDE	E SIDE	W SIDE	TOTAL
7:00 AM	2	7	10	5	24
7:15 AM	10	4	8	11	33
7:30 AM	9	12	3	10	34
7:45 AM	10	10	5	12	37
8:00 AM	7	6	2	6	21
8:15 AM	7	9	2	2	20
8:30 AM	1	9	3	5	18
8:45 AM	3	6	2	12	23
TOTAL	49	63	35	63	210
4:00 PM	1	6	2	6	15
4:15 PM	1	11	0	5	17
4:30 PM	1	11	1	9	22
4:45 PM	0	11	0	5	16
5:00 PM	1	11	3	9	24
5:15 PM	5	8	2	11	26
5:30 PM	5	11	4	7	27
5:45 PM	7	18	0	7	32
TOTAL	21	87	12	59	179

	PEDESTRIAN CROSSINGS				
	N SIDE	S SIDE	E SIDE	W SIDE	TOTAL
7:00 AM	2	7	8	5	22
7:15 AM	8	3	8	7	26
7:30 AM	7	10	3	6	26
7:45 AM	10	9	2	12	33
8:00 AM	5	6	2	5	18
8:15 AM	7	8	0	2	17
8:30 AM	1	6	3	2	12
8:45 AM	2	6	1	10	19
TOTAL	42	55	27	49	173
4:00 PM	1	4	1	5	11
4:15 PM	1	8	0	4	13
4:30 PM	0	11	1	6	18
4:45 PM	0	10	0	3	13
5:00 PM	0	7	3	7	17
5:15 PM	4	8	2	9	23
5:30 PM	5	9	4	6	24
5:45 PM	7	17	0	5	29
TOTAL	18	74	11	45	148

	BICYCLE CROSSINGS				
	NS	SS	ES	WS	TOTAL
7:00 AM	0	0	2	0	2
7:15 AM	2	1	0	4	7
7:30 AM	2	2	0	4	8
7:45 AM	0	1	3	0	4
8:00 AM	2	0	0	1	3
8:15 AM	0	1	2	0	3
8:30 AM	0	3	0	3	6
8:45 AM	1	0	1	2	4
TOTAL	7	8	8	14	37
4:00 PM	0	2	1	1	4
4:15 PM	0	3	0	1	4
4:30 PM	1	0	0	3	4
4:45 PM	0	1	0	2	3
5:00 PM	1	4	0	2	7
5:15 PM	1	0	0	2	3
5:30 PM	0	2	0	1	3
5:45 PM	0	1	0	2	3
TOTAL	3	13	1	14	31

INTERSECTION TURNING MOVEMENT COUNTS

PREPARED BY: AimTD LLC. tel: 714 253 7888 pacific@aimtd.com

DATE: Tue, Feb 9, 16	LOCATION: NORTH & SOUTH: EAST & WEST:	Santa Ana Bristol Santa Ana	PROJECT #: SC0846 LOCATION #: 21 CONTROL: SIGNAL
--------------------------------	---	-----------------------------------	--

NOTES:	AM PM MD OTHER OTHER	▲ N ▼ S	◀ W E ▶
--------	----------------------------------	------------------	------------

Add U-Turns to Left Turns

LANES:	NORTHBOUND			SOUTHBOUND			EASTBOUND			WESTBOUND			TOTAL
	NL	NT	NR	SL	ST	SR	EL	ET	ER	WL	WT	WR	

U-TURNS				
NB	SB	EB	WB	TTL

AM	7:00 AM	12	299	16	24	375	3	21	53	17	25	26	9	880
	7:15 AM	16	341	36	33	399	9	13	72	8	24	54	4	1,009
	7:30 AM	16	360	52	26	369	7	29	110	9	30	64	13	1,085
	7:45 AM	23	352	55	39	309	12	19	136	12	21	79	8	1,065
	8:00 AM	7	310	46	33	371	11	18	69	4	17	33	14	933
	8:15 AM	12	274	25	36	369	7	9	29	3	20	23	12	819
	8:30 AM	11	237	21	23	307	8	13	25	7	21	15	12	700
	8:45 AM	5	292	14	31	345	4	8	26	2	10	18	11	766
	VOLUMES	102	2,465	265	245	2,844	61	130	520	62	168	312	83	7,257
	APPROACH %	4%	87%	9%	8%	90%	2%	18%	73%	9%	30%	55%	15%	
APP/DEPART	2,832	/	2,704	3,150	/	3,080	712	/	1,004	563	/	469	0	
BEGIN PEAK HR	7:15 AM													
VOLUMES	62	1,363	189	131	1,448	39	79	387	33	92	230	39	4,092	
APPROACH %	4%	84%	12%	8%	89%	2%	16%	78%	7%	25%	64%	11%		
PEAK HR FACTOR	0.938			0.917			0.747			0.836			0.943	
APP/DEPART	1,614	/	1,497	1,618	/	1,575	499	/	691	361	/	329	0	
PM	4:00 PM	5	338	23	30	351	12	19	30	7	43	59	11	928
	4:15 PM	6	345	21	25	387	13	9	35	4	31	57	18	951
	4:30 PM	13	345	26	29	353	18	12	42	7	38	64	23	970
	4:45 PM	10	361	15	18	352	7	11	34	5	42	76	23	954
	5:00 PM	19	333	16	20	289	14	9	32	9	64	88	29	922
	5:15 PM	21	386	19	27	357	14	11	41	6	61	96	27	1,066
	5:30 PM	13	399	21	22	353	14	15	39	14	50	85	22	1,047
	5:45 PM	19	346	27	31	348	8	21	44	7	48	87	18	1,004
	VOLUMES	106	2,853	168	202	2,790	100	107	297	59	377	612	171	7,842
	APPROACH %	3%	91%	5%	7%	90%	3%	23%	64%	13%	33%	53%	15%	
APP/DEPART	3,127	/	3,178	3,092	/	3,239	463	/	620	1,160	/	805	0	
BEGIN PEAK HR	5:00 PM													
VOLUMES	72	1,464	83	100	1,347	50	56	156	36	223	356	96	4,039	
APPROACH %	4%	90%	5%	7%	90%	3%	23%	63%	15%	33%	53%	14%		
PEAK HR FACTOR	0.935			0.940			0.861			0.917			0.947	
APP/DEPART	1,619	/	1,639	1,497	/	1,615	248	/	316	675	/	469	0	

0	0	0	0	0
0	3	0	0	3
0	1	0	0	1
2	6	0	0	8
0	6	0	0	6
3	2	0	0	5
1	3	0	0	4
0	5	0	0	5
6	26	0	0	32
0	5	0	0	5
0	8	0	0	8
3	3	0	0	6
1	8	0	0	9
3	6	0	0	9
2	5	0	0	7
1	5	0	0	6
3	7	0	0	10
13	47	0	0	60

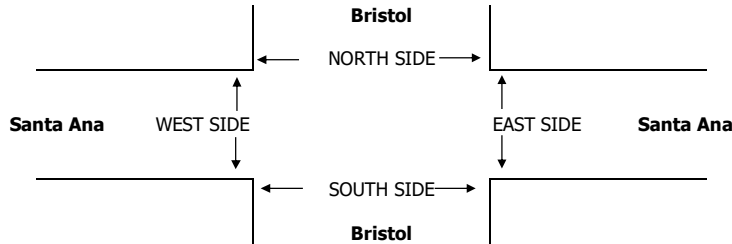

AM	7:00 AM	13	6	9	9	37
	7:15 AM	42	16	13	11	82
	7:30 AM	40	26	14	26	106
	7:45 AM	43	21	5	17	86
	8:00 AM	32	7	10	12	61
	8:15 AM	5	3	5	7	20
	8:30 AM	16	10	5	6	37
	8:45 AM	7	13	8	4	32
	TOTAL	198	102	69	92	461
PM	4:00 PM	5	10	7	9	31
	4:15 PM	8	13	13	10	44
	4:30 PM	12	3	6	10	31
	4:45 PM	1	3	4	10	18
	5:00 PM	6	15	11	10	42
	5:15 PM	21	7	18	17	63
	5:30 PM	36	18	12	30	96
	5:45 PM	26	11	28	11	76
	TOTAL	115	80	99	107	401

PEDESTRIAN + BIKE CROSSINGS				
N SIDE	S SIDE	E SIDE	W SIDE	TOTAL

PEDESTRIAN CROSSINGS				
N SIDE	S SIDE	E SIDE	W SIDE	TOTAL

BICYCLE CROSSINGS				
NS	SS	ES	WS	TOTAL

INTERSECTION TURNING MOVEMENT COUNTS

PREPARED BY: AimTD LLC. tel: 714 253 7888 cs@aimtd.com

DATE: Tue, May 14, 19	LOCATION: NORTH & SOUTH: EAST & WEST:	Santa Ana Bristol 1st	PROJECT #: LOCATION #: CONTROL:	SC2183 13 SIGNAL
--------------------------	---	-----------------------------	---------------------------------------	------------------------

NOTES:					AM PM MD OTHER OTHER	← W E →	▲ N S ▼
--------	--	--	--	--	----------------------------------	------------	------------------

Add U-Turns to Left Turns

LANES:	NORTHBOUND			SOUTHBOUND			EASTBOUND			WESTBOUND			TOTAL
	NL	NT	NR	SL	ST	SR	EL	ET	ER	WL	WT	WR	
7:00 AM	36	259	34	58	271	47	43	290	22	28	124	17	1,229
7:15 AM	39	329	43	65	316	34	36	318	32	23	145	23	1,403
7:30 AM	46	328	36	88	284	51	53	332	28	30	204	28	1,508
7:45 AM	57	346	48	74	259	37	62	314	30	25	258	36	1,546
8:00 AM	39	262	33	45	262	36	52	291	36	28	197	30	1,311
8:15 AM	35	266	40	56	275	32	44	293	29	29	179	23	1,301
8:30 AM	23	240	58	63	248	34	55	299	24	22	143	41	1,250
8:45 AM	24	202	37	57	229	31	36	285	26	17	137	24	1,105
VOLUMES	299	2,232	329	506	2,144	302	381	2,422	227	202	1,387	222	10,653
APPROACH %	10%	78%	12%	17%	73%	10%	13%	80%	7%	11%	77%	12%	
APP/DEPART	2,860	/	2,849	2,952	/	2,588	3,030	/	3,244	1,811	/	1,972	0
BEGIN PEAK HR	7:15 AM												
VOLUMES	181	1,265	160	272	1,121	158	203	1,255	126	106	804	117	5,768
APPROACH %	11%	79%	10%	18%	72%	10%	13%	79%	8%	10%	78%	11%	
PEAK HR FACTOR	0.890												
APP/DEPART	1,606	/	1,594	1,551	/	1,361	1,584	/	1,679	1,027	/	1,134	0
4:00 PM	72	301	45	37	155	34	49	244	38	47	256	28	1,306
4:15 PM	66	288	50	39	176	39	43	279	36	41	293	38	1,388
4:30 PM	63	284	54	51	260	54	58	283	39	58	328	27	1,559
4:45 PM	70	290	40	64	266	72	42	255	42	45	339	25	1,550
5:00 PM	87	338	47	42	275	59	46	231	32	50	304	33	1,544
5:15 PM	63	310	39	46	302	64	41	282	21	61	345	39	1,613
5:30 PM	66	317	46	50	279	59	57	261	20	47	307	34	1,543
5:45 PM	63	335	53	54	246	63	48	253	33	39	287	30	1,504
VOLUMES	550	2,463	374	383	1,959	444	384	2,088	261	388	2,459	254	12,007
APPROACH %	16%	73%	11%	14%	70%	16%	14%	76%	10%	13%	79%	8%	
APP/DEPART	3,387	/	3,118	2,786	/	2,635	2,733	/	2,838	3,101	/	3,416	0
BEGIN PEAK HR	4:30 PM												
VOLUMES	283	1,222	180	203	1,103	249	187	1,051	134	214	1,316	124	6,266
APPROACH %	17%	73%	11%	13%	71%	16%	14%	77%	10%	13%	80%	7%	
PEAK HR FACTOR	0.892												
APP/DEPART	1,685	/	1,543	1,555	/	1,471	1,372	/	1,427	1,654	/	1,825	0

U-TURNS				
NB	SB	EB	WB	TTL
0	0	0	0	0
2	2	0	0	4
2	1	0	1	4
3	3	0	0	6
2	2	0	0	4
2	3	0	0	5
1	3	0	0	4
3	0	0	0	3
1	0	0	0	1
16	14	0	1	31

5	3	0	2	10
5	3	0	1	9
4	5	1	2	12
7	3	1	1	12
10	1	0	2	13
4	3	0	0	7
2	1	1	3	7
3	1	0	2	6
40	20	3	13	76

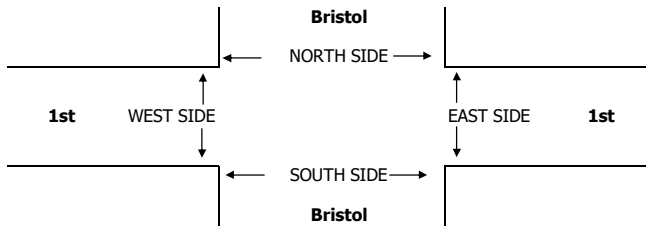

	PEDESTRIAN + BIKE CROSSINGS				
	N SIDE	S SIDE	E SIDE	W SIDE	TOTAL
7:00 AM	0	0	0	0	0
7:15 AM	0	0	0	0	0
7:30 AM	0	0	0	0	0
7:45 AM	0	0	0	0	0
8:00 AM	0	0	0	0	0
8:15 AM	0	0	0	0	0
8:30 AM	0	0	0	0	0
8:45 AM	0	0	0	0	0
TOTAL	0	0	0	0	0
AM BEGIN PEAK HR	7:15 AM				
4:00 PM	0	0	0	0	0
4:15 PM	0	0	0	0	0
4:30 PM	0	0	0	0	0
4:45 PM	0	0	0	0	0
5:00 PM	0	0	0	0	0
5:15 PM	0	0	0	0	0
5:30 PM	0	0	0	0	0
5:45 PM	0	0	0	0	0
TOTAL	0	0	0	0	0
PM BEGIN PEAK HR	4:30 PM				

PEDESTRIAN CROSSINGS				
N SIDE	S SIDE	E SIDE	W SIDE	TOTAL
0	0	0	0	0
0	0	0	0	0
0	0	0	0	0
0	0	0	0	0
0	0	0	0	0
0	0	0	0	0
0	0	0	0	0
0	0	0	0	0
0	0	0	0	0
0	0	0	0	0
0	0	0	0	0
0	0	0	0	0
0	0	0	0	0
0	0	0	0	0
0	0	0	0	0
0	0	0	0	0
0	0	0	0	0
0	0	0	0	0
0	0	0	0	0
0	0	0	0	0
0	0	0	0	0
0	0	0	0	0
0	0	0	0	0
0	0	0	0	0

BICYCLE CROSSINGS				
NS	SS	ES	WS	TOTAL
0	0	0	0	0
0	0	0	0	0
0	0	0	0	0
0	0	0	0	0
0	0	0	0	0
0	0	0	0	0
0	0	0	0	0
0	0	0	0	0
0	0	0	0	0
0	0	0	0	0
0	0	0	0	0
0	0	0	0	0
0	0	0	0	0
0	0	0	0	0
0	0	0	0	0
0	0	0	0	0
0	0	0	0	0
0	0	0	0	0
0	0	0	0	0
0	0	0	0	0
0	0	0	0	0
0	0	0	0	0

City: SANTA ANA
 N-S Direction: BRISTOL STREET
 E-W Direction: MCFADDEN AVENUE

File Name : H1702008
 Site Code : 00000000
 Start Date : 2/7/2017
 Page No : 1

Groups Printed- Turning Movements

Start Time	BRISTOL STREET Southbound				MCFADDEN AVENUE Westbound			BRISTOL STREET Northbound				MCFADDEN AVENUE Eastbound			Int. Total
	Right	Thru	Left	U-Turn	Right	Thru	Left	Right	Thru	Left	U-Turn	Right	Thru	Left	
07:00	41	347	20	6	18	80	43	9	170	18	0	53	94	41	940
07:15	49	378	27	6	12	103	43	11	246	26	1	53	119	72	1146
07:30	28	388	30	8	9	110	34	18	264	35	0	53	115	80	1172
07:45	52	391	34	11	12	111	33	12	255	35	2	62	110	46	1166
Total	170	1504	111	31	51	404	153	50	935	114	3	221	438	239	4424
08:00	28	367	27	13	15	95	40	10	258	18	0	57	114	68	1110
08:15	25	350	28	5	14	66	23	14	174	19	2	33	76	48	877
08:30	24	323	16	6	10	74	24	10	218	19	0	32	81	47	884
08:45	25	320	23	7	11	54	26	11	193	24	1	22	78	47	842
Total	102	1360	94	31	50	289	113	45	843	80	3	144	349	210	3713
*** BREAK ***															
16:00	47	257	17	15	26	100	34	18	382	48	5	23	111	67	1150
16:15	61	258	27	6	22	102	31	17	368	41	2	24	98	71	1128
16:30	64	246	23	14	14	118	40	24	363	49	5	25	114	68	1167
16:45	62	268	21	14	19	116	32	19	384	46	3	30	122	57	1193
Total	234	1029	88	49	81	436	137	78	1497	184	15	102	445	263	4638
17:00	66	296	19	16	15	127	19	15	376	57	4	23	118	67	1218
17:15	65	298	25	8	12	122	22	30	382	43	2	23	136	63	1231
17:30	69	274	16	8	11	124	21	18	377	60	3	23	120	67	1191
17:45	56	286	19	16	11	121	28	22	320	64	1	28	113	71	1156
Total	256	1154	79	48	49	494	90	85	1455	224	10	97	487	268	4796
Grand Total	762	5047	372	159	231	1623	493	258	4730	602	31	564	1719	980	17571
Apprch %	12	79.6	5.9	2.5	9.8	69.2	21	4.6	84.1	10.7	0.6	17.3	52.7	30	
Total %	4.3	28.7	2.1	0.9	1.3	9.2	2.8	1.5	26.9	3.4	0.2	3.2	9.8	5.6	

City: SANTA ANA
 N-S Direction: BRISTOL STREET
 E-W Direction: MCFADDEN AVENUE

File Name : H1702008
 Site Code : 00000000
 Start Date : 2/7/2017
 Page No : 2

Start Time	BRISTOL STREET Southbound					MCFADDEN AVENUE Westbound				BRISTOL STREET Northbound					MCFADDEN AVENUE Eastbound				Int. Total
	Right	Thru	Left	U-Turn	App. Total	Right	Thru	Left	App. Total	Right	Thru	Left	U-Turn	App. Total	Right	Thru	Left	App. Total	
Peak Hour Analysis From 07:00 to 08:45 - Peak 1 of 1																			
Peak Hour for Entire Intersection Begins at 07:15																			
07:15	49	378	27	6	460	12	103	43	158	11	246	26	1	284	53	119			
07:30	28	388	30	8	454	9	110	34	153	18	264	35	0	317	53	115	80	248	1172
07:45	52	391	34	11	488	12	111	33	156	12	255	35	2	304	62	110	46	218	1166
08:00	28	367	27	13	435	15													
Total Volume	157	1524	118	38	1837	48	419	150	617	51	1023	114	3	1191	225	458	266	949	4594
% App. Total	8.5	83	6.4	2.1		7.8	67.9	24.3		4.3	85.9	9.6	0.3		23.7	48.3	28		
PHF	.755	.974	.868	.731	.941	.800	.944	.872	.976	.708	.969	.814	.375	.939	.907	.962	.831	.957	.980

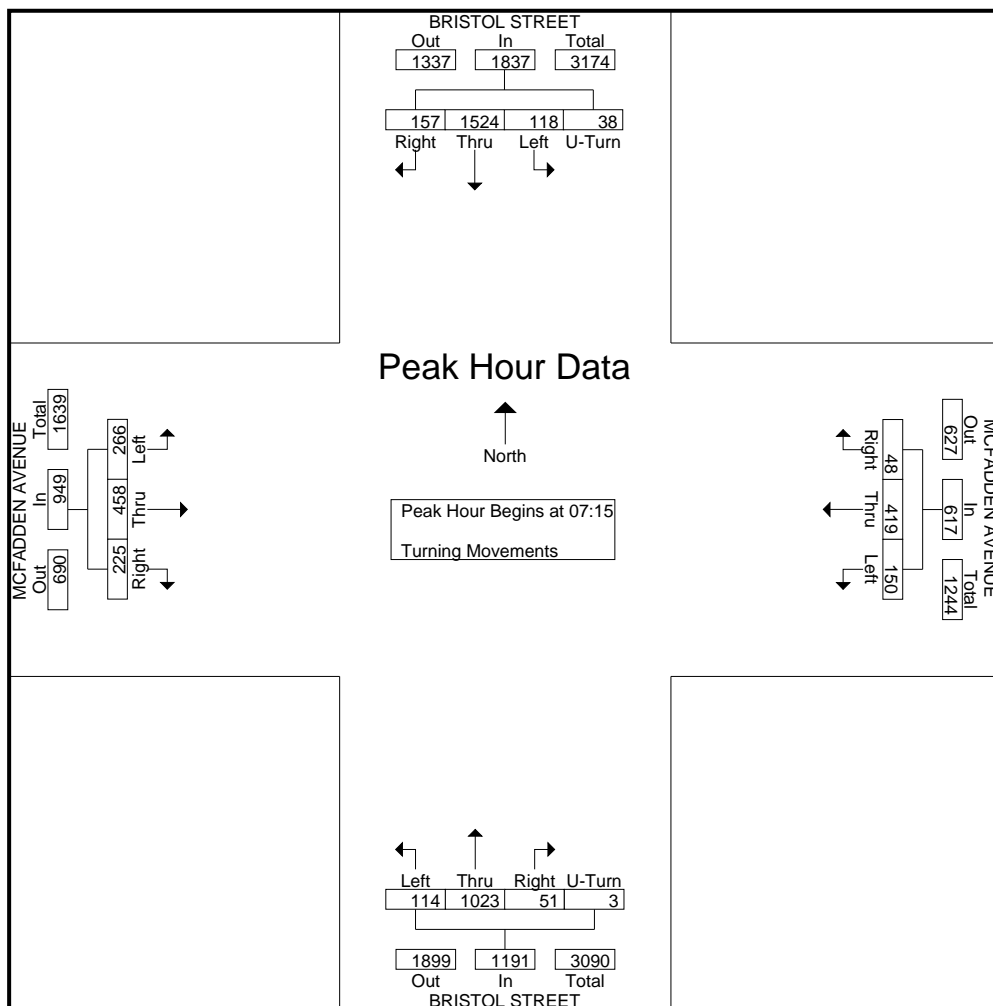

City: SANTA ANA
 N-S Direction: BRISTOL STREET
 E-W Direction: MCFADDEN AVENUE

File Name : H1702008
 Site Code : 00000000
 Start Date : 2/7/2017
 Page No : 3

Start Time	BRISTOL STREET Southbound					MCFADDEN AVENUE Westbound				BRISTOL STREET Northbound					MCFADDEN AVENUE Eastbound				Int. Total
	Right	Thru	Left	U-Turn	App. Total	Right	Thru	Left	App. Total	Right	Thru	Left	U-Turn	App. Total	Right	Thru	Left	App. Total	
Peak Hour Analysis From 16:00 to 17:45 - Peak 1 of 1 Peak Hour for Entire Intersection Begins at 16:45																			
16:45	62	268	21	14	365	19	116	32	167	19	384	57	4	452	30	23	118	67	208
17:00	66	296	19	16	397	15	127	19	161	15	376	57	4	452	23	118	67	208	1218
17:15	65	298	25	8	396	12	122	22	156	30	382	43	2	457	23	136	63	222	1231
17:30	69	274	16	8	367	11	124	21	156	18	377	60	3	458	23	120	67	210	1191
Total Volume	262	1136	81	46	1525	57	489	94	640	82	1519	206	12	1819	99	496	254	849	4833
% App. Total	17.2	74.5	5.3	3		8.9	76.4	14.7		4.5	83.5	11.3	0.7		11.7	58.4	29.9		
PHF	.949	.953	.810	.719	.960	.750	.963	.734	.958	.683	.989	.858	.750	.993	.825	.912	.948	.956	.982

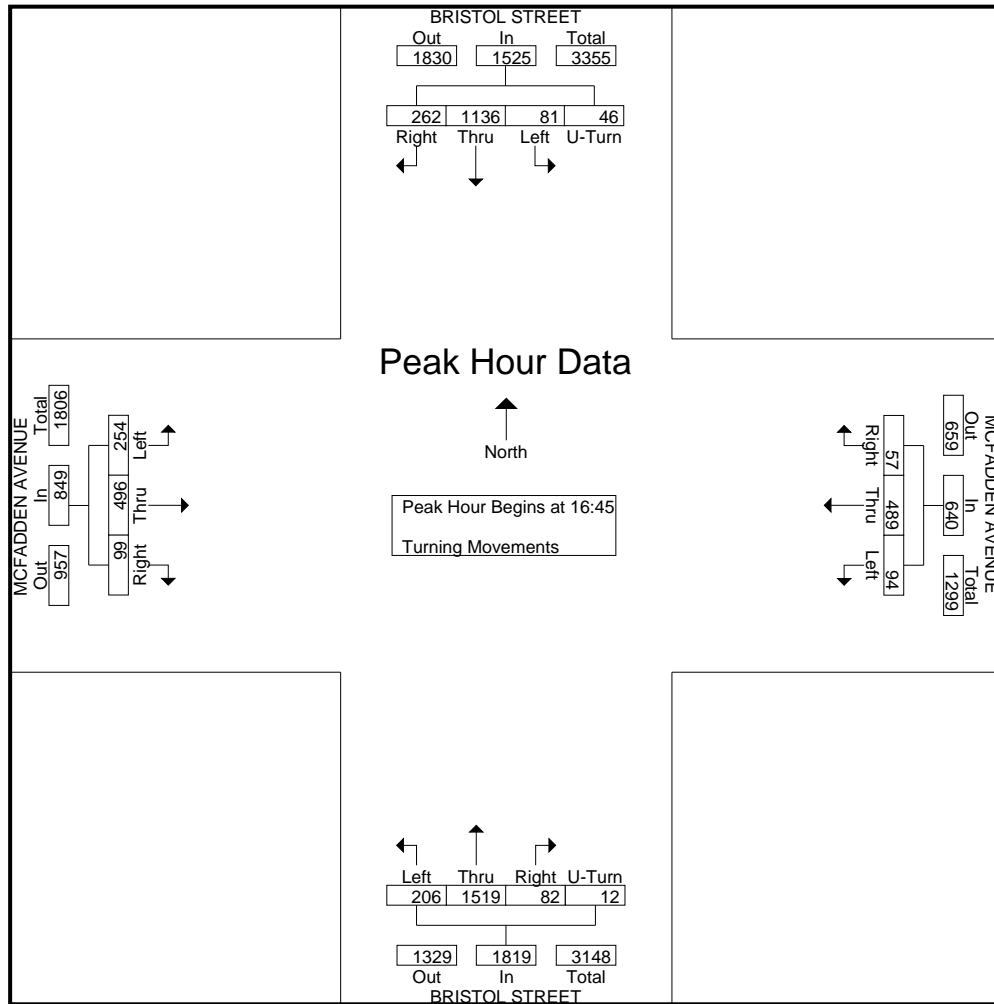

INTERSECTION TURNING MOVEMENT COUNTS

PREPARED BY: AimTD LLC. tel: 714 253 7888 cs@aimtd.com

DATE:
Thu, May 16, 19

LOCATION:
NORTH & SOUTH:
EAST & WEST:

Santa Ana
Bristol
Warner

PROJECT #: SC2183
LOCATION #: 15
CONTROL: SIGNAL

NOTES:

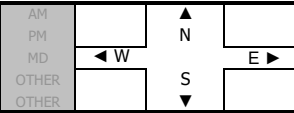

Add U-Turns to Left Turns

LANES:	NORTHBOUND			SOUTHBOUND			EASTBOUND			WESTBOUND			TOTAL
	Bristol			Bristol			Warner			Warner			
	NL	NT	NR	SL	ST	SR	EL	ET	ER	WL	WT	WR	
7:00 AM	40	125	29	104	291	34	30	297	55	36	143	25	1,209
7:15 AM	43	163	24	110	327	37	48	304	71	35	199	25	1,386
7:30 AM	49	182	42	79	336	33	52	292	64	54	230	35	1,448
7:45 AM	53	250	34	90	316	36	50	266	72	49	243	37	1,496
8:00 AM	45	258	57	103	315	40	53	275	76	48	179	47	1,496
8:15 AM	36	272	81	84	324	40	53	217	72	35	126	41	1,381
8:30 AM	26	205	62	74	322	36	48	221	65	49	127	29	1,264
8:45 AM	36	127	35	72	310	35	33	197	72	52	110	30	1,109
VOLUMES	328	1,582	364	716	2,541	291	367	2,069	547	358	1,357	269	10,789
APPROACH %	14%	70%	16%	20%	72%	8%	12%	69%	18%	18%	68%	14%	
APP/DEPART	2,274	/	2,225	3,548	/	3,445	2,983	/	3,147	1,984	/	1,972	0
BEGIN PEAK HR	7:15 AM												
VOLUMES	190	853	157	382	1,294	146	203	1,137	283	186	851	144	5,826
APPROACH %	16%	71%	13%	21%	71%	8%	13%	70%	17%	16%	72%	12%	
PEAK HR FACTOR	0.833												
APP/DEPART	1,200	/	1,203	1,822	/	1,763	1,623	/	1,676	1,181	/	1,184	0
4:00 PM	68	304	50	84	211	30	53	206	36	32	219	93	1,386
4:15 PM	80	289	54	72	192	43	43	227	36	35	247	79	1,397
4:30 PM	73	295	54	44	205	35	44	208	44	45	243	77	1,367
4:45 PM	80	284	44	77	195	36	51	193	36	38	255	72	1,361
5:00 PM	72	277	56	55	237	47	53	231	35	53	265	68	1,449
5:15 PM	59	254	50	81	202	42	51	210	46	36	257	69	1,357
5:30 PM	70	291	63	66	176	36	54	207	49	40	260	72	1,384
5:45 PM	72	282	50	70	192	47	54	207	30	42	260	67	1,373
VOLUMES	574	2,276	421	549	1,610	316	403	1,689	312	321	2,006	597	11,074
APPROACH %	18%	70%	13%	22%	65%	13%	17%	70%	13%	11%	69%	20%	
APP/DEPART	3,271	/	3,274	2,475	/	2,247	2,404	/	2,660	2,924	/	2,893	0
BEGIN PEAK HR	4:15 PM												
VOLUMES	305	1,145	208	248	829	161	191	859	151	171	1,010	296	5,574
APPROACH %	18%	69%	13%	20%	67%	13%	16%	72%	13%	12%	68%	20%	
PEAK HR FACTOR	0.980												
APP/DEPART	1,658	/	1,631	1,238	/	1,154	1,201	/	1,319	1,477	/	1,470	0

U-TURNS				
NB	SB	EB	WB	TTL
0	0	0	0	2
2	0	0	1	3
1	1	0	1	3
0	1	0	1	2
0	1	0	0	1
0	0	0	0	0
1	0	0	2	3
0	2	0	0	2
4	7	0	5	16

0	0	1	0	1
1	0	1	1	3
2	0	0	2	4
2	0	0	0	2
2	0	0	1	3
0	2	1	0	3
1	0	2	0	3
0	1	0	0	1
8	3	5	4	20

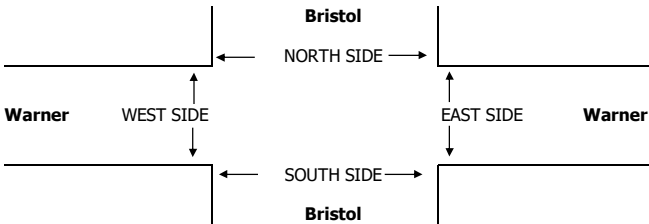

	PEDESTRIAN + BIKE CROSSINGS			
	N SIDE	S SIDE	E SIDE	W SIDE
7:00 AM	0	0	0	0
7:15 AM	0	0	0	0
7:30 AM	0	0	0	0
7:45 AM	0	0	0	0
8:00 AM	0	0	0	0
8:15 AM	0	0	0	0
8:30 AM	0	0	0	0
8:45 AM	0	0	0	0
TOTAL	0	0	0	0
AM BEGIN PEAK HR	7:15 AM			
4:00 PM	0	0	0	0
4:15 PM	0	0	0	0
4:30 PM	0	0	0	0
4:45 PM	0	0	0	0
5:00 PM	0	0	0	0
5:15 PM	0	0	0	0
5:30 PM	0	0	0	0
5:45 PM	0	0	0	0
TOTAL	0	0	0	0
PM BEGIN PEAK HR	4:15 PM			

	PEDESTRIAN CROSSINGS				
	N SIDE	S SIDE	E SIDE	W SIDE	TOTAL
7:00 AM	0	0	0	0	0
7:15 AM	0	0	0	0	0
7:30 AM	0	0	0	0	0
7:45 AM	0	0	0	0	0
8:00 AM	0	0	0	0	0
8:15 AM	0	0	0	0	0
8:30 AM	0	0	0	0	0
8:45 AM	0	0	0	0	0
TOTAL	0	0	0	0	0
AM BEGIN PEAK HR	7:15 AM				
4:00 PM	0	0	0	0	0
4:15 PM	0	0	0	0	0
4:30 PM	0	0	0	0	0
4:45 PM	0	0	0	0	0
5:00 PM	0	0	0	0	0
5:15 PM	0	0	0	0	0
5:30 PM	0	0	0	0	0
5:45 PM	0	0	0	0	0
TOTAL	0	0	0	0	0
PM BEGIN PEAK HR	4:15 PM				

	BICYCLE CROSSINGS				
	NS	SS	ES	WS	TOTAL
7:00 AM	0	0	0	0	0
7:15 AM	0	0	0	0	0
7:30 AM	0	0	0	0	0
7:45 AM	0	0	0	0	0
8:00 AM	0	0	0	0	0
8:15 AM	0	0	0	0	0
8:30 AM	0	0	0	0	0
8:45 AM	0	0	0	0	0
TOTAL	0	0	0	0	0
AM BEGIN PEAK HR	7:15 AM				
4:00 PM	0	0	0	0	0
4:15 PM	0	0	0	0	0
4:30 PM	0	0	0	0	0
4:45 PM	0	0	0	0	0
5:00 PM	0	0	0	0	0
5:15 PM	0	0	0	0	0
5:30 PM	0	0	0	0	0
5:45 PM	0	0	0	0	0
TOTAL	0	0	0	0	0
PM BEGIN PEAK HR	4:15 PM				

INTERSECTION TURNING MOVEMENT COUNTS

PREPARED BY: AimTD LLC. tel: 714 253 7888 pacific@aimtd.com

DATE: Tue, Feb 9, 16

LOCATION: Santa Ana
NORTH & SOUTH: Bristol
EAST & WEST: Segerstrom

PROJECT #: SC0846
LOCATION #: 46
CONTROL: SIGNAL

NOTES:

AM		▲	
PM		N	
MD	◀ W		E ▶
OTHER		S	
OTHER		▼	

Add U-Turns to Left Turns

	NORTHBOUND			SOUTHBOUND			EASTBOUND			WESTBOUND			TOTAL
	NL	NT	NR	SL	ST	SR	EL	ET	ER	WL	WT	WR	
LANES:	1	3	0	1	3	0	1	2	0	1	2	0	
AM													
7:00 AM	6	92	12	45	252	33	14	166	16	19	100	11	766
7:15 AM	12	143	29	62	244	39	41	232	10	23	122	11	968
7:30 AM	17	188	30	80	249	25	26	232	24	25	171	18	1,085
7:45 AM	22	176	32	76	234	21	64	220	20	44	151	24	1,084
8:00 AM	11	189	39	53	244	29	50	193	26	25	88	15	962
8:15 AM	12	179	23	38	250	25	49	166	21	26	62	12	863
8:30 AM	4	236	21	27	259	36	56	164	20	18	51	12	904
8:45 AM	9	223	13	33	265	36	55	143	18	16	77	22	910
VOLUMES	93	1,426	199	414	1,997	244	355	1,516	155	196	822	125	7,542
APPROACH %	5%	83%	12%	16%	75%	9%	18%	75%	8%	17%	72%	11%	
APP/DEPART	1,718	/	1,906	2,655	/	2,349	2,026	/	2,129	1,143	/	1,158	0
BEGIN PEAK HR	7:15 AM												
VOLUMES	62	696	130	271	971	114	181	877	80	117	532	68	4,099
APPROACH %	7%	78%	15%	20%	72%	8%	16%	77%	7%	16%	74%	9%	
PEAK HR FACTOR	0.929			0.958			0.936			0.818			0.944
APP/DEPART	888	/	945	1,356	/	1,168	1,138	/	1,278	717	/	708	0
PM													
4:00 PM	33	218	38	20	165	31	43	135	11	32	248	24	998
4:15 PM	17	229	32	20	179	43	48	141	15	30	259	16	1,029
4:30 PM	21	269	29	21	188	27	53	152	11	26	249	13	1,059
4:45 PM	30	328	43	25	183	35	45	139	6	37	243	20	1,134
5:00 PM	38	320	50	26	195	39	47	154	11	34	272	10	1,196
5:15 PM	38	319	69	26	185	40	47	191	13	29	258	15	1,230
5:30 PM	46	321	49	16	200	48	46	189	13	19	250	18	1,215
5:45 PM	50	310	55	20	230	42	52	154	17	32	252	8	1,222
VOLUMES	273	2,314	365	174	1,525	305	381	1,255	97	239	2,031	124	9,083
APPROACH %	9%	78%	12%	9%	76%	15%	22%	72%	6%	10%	85%	5%	
APP/DEPART	2,952	/	2,820	2,004	/	1,863	1,733	/	1,793	2,394	/	2,607	0
BEGIN PEAK HR	5:00 PM												
VOLUMES	172	1,270	223	88	810	169	192	688	54	114	1,032	51	4,863
APPROACH %	10%	76%	13%	8%	76%	16%	21%	74%	6%	10%	86%	4%	
PEAK HR FACTOR	0.977			0.914			0.930			0.947			0.988
APP/DEPART	1,665	/	1,513	1,067	/	980	934	/	999	1,197	/	1,371	0

U-TURNS				
NB	SB	EB	WB	TTL
0	0	0	0	0
0	0	0	0	0
0	0	0	0	0
0	0	0	0	0
0	0	0	0	0
1	0	0	0	1
0	0	0	0	0
0	0	0	0	0
1	0	0	0	1
2	1	0	0	3

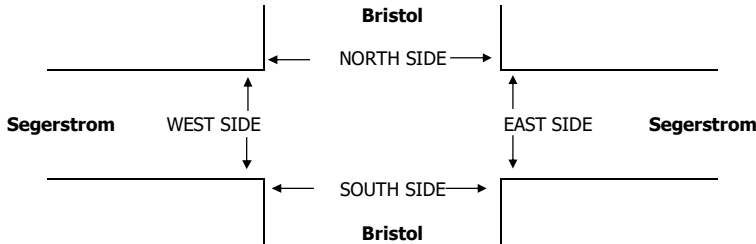

	AM	PM
7:00 AM		
7:15 AM		
7:30 AM		
7:45 AM		
8:00 AM		
8:15 AM		
8:30 AM		
8:45 AM		
TOTAL		
4:00 PM		
4:15 PM		
4:30 PM		
4:45 PM		
5:00 PM		
5:15 PM		
5:30 PM		
5:45 PM		
TOTAL		

PEDESTRIAN + BIKE CROSSINGS				
N SIDE	S SIDE	E SIDE	W SIDE	TOTAL
8	6	4	3	21
3	16	0	3	22
11	7	8	6	32
4	7	2	4	17
1	2	5	3	11
2	0	3	2	7
4	3	1	2	10
2	2	5	3	12
35	43	28	26	132
16	3	10	8	37
10	6	3	5	24
16	5	8	7	36
6	5	6	6	23
9	2	6	6	23
13	1	4	7	25
8	3	17	2	30
6	0	3	4	13
84	25	57	45	211

PEDESTRIAN CROSSINGS				
N SIDE	S SIDE	E SIDE	W SIDE	TOTAL
1	3	4	1	9
2	7	0	1	10
1	2	7	5	15
0	0	2	3	5
0	0	5	2	7
1	0	3	1	5
2	0	0	1	3
2	1	4	3	10
9	13	25	17	64
3	1	6	4	14
0	1	2	1	4
1	3	4	3	11
1	0	4	3	8
0	2	5	4	11
1	1	3	6	11
3	1	16	1	21
1	0	1	3	5
10	9	41	25	85

BICYCLE CROSSINGS				
NS	SS	ES	WS	TOTAL
7	3	0	2	12
1	9	0	2	12
10	5	1	1	17
4	7	0	1	12
1	2	0	1	4
1	0	0	1	2
2	3	1	1	7
0	1	1	0	2
26	30	3	9	68
13	2	4	4	23
10	5	1	4	20
15	2	4	4	25
5	5	2	3	15
9	0	1	2	12
12	0	1	1	14
5	2	1	1	9
5	0	2	1	8
74	16	16	20	126

City: SANTA ANA
N-S Direction: BRISTOL STREET
E-W Direction: ALTON AVENUE

File Name : H1702006
Site Code : 00000000
Start Date : 2/15/2017
Page No : 1

Groups Printed- Turning Movements

Start Time	BRISTOL STREET Southbound				ALTON AVENUE Westbound			BRISTOL STREET Northbound				ALTON AVENUE Eastbound				Int. Total
	Right	Thru	Left	U-Turn	Right	Thru	Left	Right	Thru	Left	U-Turn	Right	Thru	Left	Peds	
07:00	30	305	9	0	7	6	2	2	122	7	1	31	9	28	0	559
07:15	47	369	4	0	7	10	11	3	137	15	0	34	19	36	0	692
07:30	82	373	8	0	14	31	6	1	166	12	0	55	42	50	0	840
07:45	64	388	11	0	9	33	6	1	148	10	2	52	28	74	0	826
Total	223	1435	32	0	37	80	25	7	573	44	3	172	98	188	0	2917
08:00	27	394	11	0	9	10	7	1	158	8	0	43	24	76	0	768
08:15	21	343	7	0	10	11	4	2	143	6	0	35	15	75	0	672
08:30	19	312	6	0	11	7	3	0	142	6	2	20	16	36	0	580
08:45	18	306	13	1	4	12	4	3	126	7	0	13	12	18	0	537
Total	85	1355	37	1	34	40	18	6	569	27	2	111	67	205	0	2557
*** BREAK ***																
16:00	21	204	10	0	28	17	7	8	448	37	1	12	19	41	0	853
16:15	24	200	11	2	15	23	8	3	381	33	4	17	17	39	0	777
16:30	24	214	12	0	27	20	10	5	406	30	7	14	26	43	0	838
16:45	28	219	16	1	21	34	7	8	417	36	4	12	29	48	0	880
Total	97	837	49	3	91	94	32	24	1652	136	16	55	91	171	0	3348
17:00	31	204	9	1	26	26	7	5	383	35	3	13	26	45	0	814
17:15	27	212	17	1	25	51	7	5	405	48	6	23	22	46	0	895
17:30	25	234	12	1	16	34	7	7	426	34	3	24	24	50	0	897
17:45	25	220	19	0	29	34	7	9	381	37	3	22	23	35	0	844
Total	108	870	57	3	96	145	28	26	1595	154	15	82	95	176	0	3450
Grand Total	513	4497	175	7	258	359	103	63	4389	361	36	420	351	740	0	12272
Apprch %	9.9	86.6	3.4	0.1	35.8	49.9	14.3	1.3	90.5	7.4	0.7	27.8	23.2	49	0	
Total %	4.2	36.6	1.4	0.1	2.1	2.9	0.8	0.5	35.8	2.9	0.3	3.4	2.9	6	0	

City: SANTA ANA
 N-S Direction: BRISTOL STREET
 E-W Direction: MACARTHUR BOULEVARD

File Name : H1702007
 Site Code : 00000000
 Start Date : 2/7/2017
 Page No : 1

Groups Printed- Turning Movements

Start Time	BRISTOL STREET Southbound				MACARTHUR BOULEVARD Westbound				BRISTOL STREET Northbound				MACARTHUR BOULEVARD Eastbound				Int. Total
	Right	Thru	Left	U-Turn	Right	Thru	Left	U-Turn	Right	Thru	Left	U-Turn	Right	Thru	Left	U-Turn	
07:00	20	276	34	0	26	139	44	0	21	78	15	4	23	172	23	0	875
07:15	37	323	48	1	30	241	41	4	16	86	10	2	19	291	37	1	1187
07:30	45	328	70	0	39	360	38	1	24	98	22	3	66	384	35	0	1513
07:45	34	336	83	1	33	292	49	2	28	121	30	5	69	324	51	1	1459
Total	136	1263	235	2	128	1032	172	7	89	383	77	14	177	1171	146	2	5034
08:00	32	379	86	1	31	122	39	4	26	119	11	2	64	351	50	1	1318
08:15	32	334	75	0	25	109	46	6	38	125	13	3	75	294	47	1	1223
08:30	20	274	44	0	32	92	51	8	34	107	11	1	70	332	62	0	1138
08:45	27	262	35	3	14	113	59	8	25	113	17	7	55	258	37	0	1033
Total	111	1249	240	4	102	436	195	26	123	464	52	13	264	1235	196	2	4712
*** BREAK ***																	
16:00	23	170	42	8	55	344	68	2	61	313	73	4	27	176	87	1	1454
16:15	30	174	39	6	59	370	83	0	56	350	62	11	31	166	92	1	1530
16:30	30	198	48	6	57	378	70	0	58	340	59	14	32	197	82	0	1569
16:45	27	183	57	5	74	355	61	0	72	346	67	13	46	195	87	0	1588
Total	110	725	186	25	245	1447	282	2	247	1349	261	42	136	734	348	2	6141
17:00	26	191	39	8	59	366	76	0	73	353	56	8	39	209	89	1	1593
17:15	31	210	45	11	74	385	63	0	58	350	67	13	45	190	80	2	1624
17:30	41	212	44	7	74	384	57	0	49	337	86	15	34	178	86	1	1605
17:45	34	213	57	7	92	339	61	0	51	295	91	16	45	183	89	1	1574
Total	132	826	185	33	299	1474	257	0	231	1335	300	52	163	760	344	5	6396
Grand Total	489	4063	846	64	774	4389	906	35	690	3531	690	121	740	3900	1034	11	22283
Apprch %	9	74.4	15.5	1.2	12.7	71.9	14.8	0.6	13.7	70.2	13.7	2.4	13	68.6	18.2	0.2	
Total %	2.2	18.2	3.8	0.3	3.5	19.7	4.1	0.2	3.1	15.8	3.1	0.5	3.3	17.5	4.6	0	

City: SANTA ANA
 N-S Direction: BRISTOL STREET
 E-W Direction: MACARTHUR BOULEVARD

File Name : H1702007
 Site Code : 00000000
 Start Date : 2/7/2017
 Page No : 2

Start Time	BRISTOL STREET Southbound					MACARTHUR BOULEVARD Westbound					BRISTOL STREET Northbound					MACARTHUR BOULEVARD Eastbound					Int. Total
	Right	Thru	Left	U-Turn	App. Total	Right	Thru	Left	U-Turn	App. Total	Right	Thru	Left	U-Turn	App. Total	Right	Thru	Left	U-Turn	App. Total	
Peak Hour Analysis From 07:00 to 08:45 - Peak 1 of 1																					
Peak Hour for Entire Intersection Begins at 07:30																					
07:30	45	328	70	0	443	39	360	38	1	438	24	98	22	3	147	66	384	35	0	485	1513
07:45	34	336	83	1	454	33	292	49	2	376	28	121	30	5	184	69	324	51	1	445	1459
08:00	32	379	86		498	31	122	39	4	196	26	119	11	2	158	64	351	50	1	466	1318
08:15	32	334	75	0	441	25	109	46	6	186	38	125	13	3	179	75	294	47	1	417	1223
Total Volume	143	1377	314	2	1836	128	883	172	13	1196	116	463	76	13	668	274	1353	183	3	1813	5513
% App. Total																					
PHF	.794	.908	.913	.500	.922	.821	.613	.878	.542	.683	.763	.926	.633	.650	.908	.913	.881	.897	.750	.935	.911

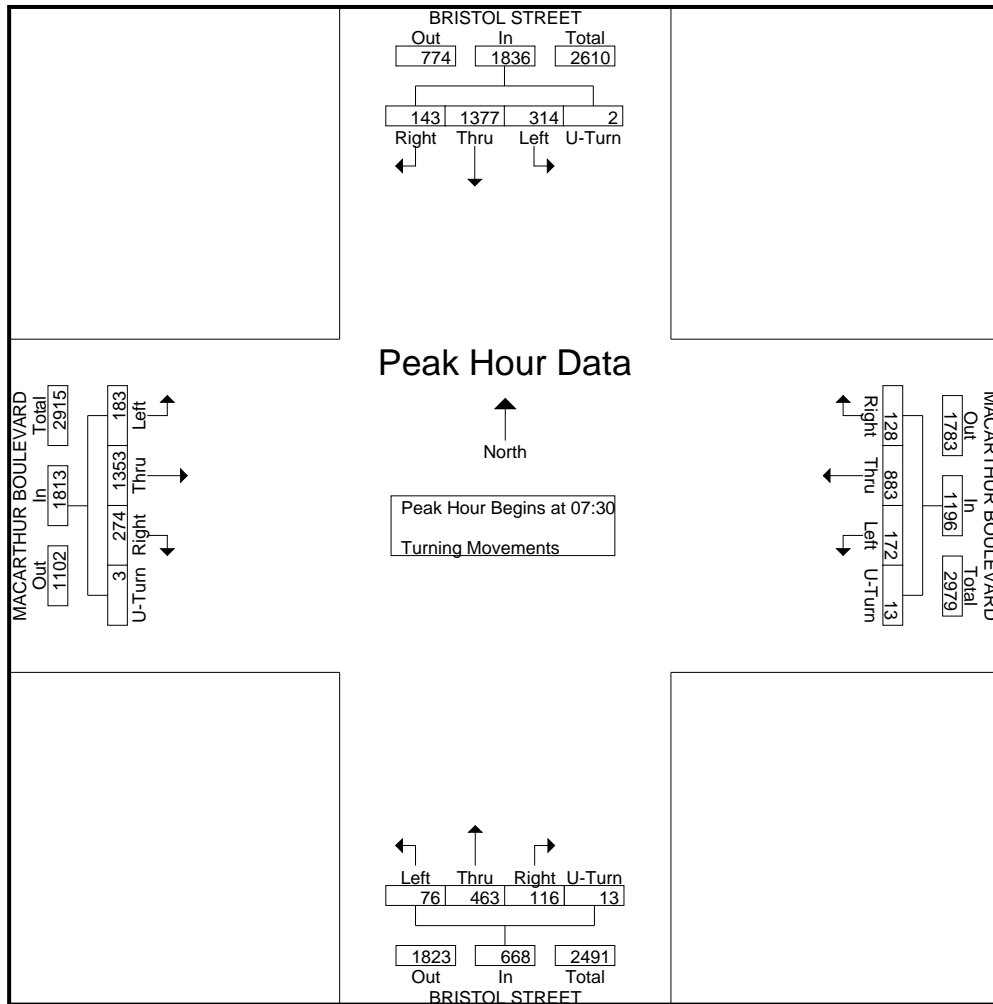

City: SANTA ANA
 N-S Direction: BRISTOL STREET
 E-W Direction: MACARTHUR BOULEVARD

File Name : H1702007
 Site Code : 00000000
 Start Date : 2/7/2017
 Page No : 3

Start Time	BRISTOL STREET Southbound					MACARTHUR BOULEVARD Westbound					BRISTOL STREET Northbound					MACARTHUR BOULEVARD Eastbound					Int. Total
	Right	Thru	Left	U-Turn	App. Total	Right	Thru	Left	U-Turn	App. Total	Right	Thru	Left	U-Turn	App. Total	Right	Thru	Left	U-Turn	App. Total	
Peak Hour Analysis From 16:00 to 17:45 - Peak 1 of 1																					
Peak Hour for Entire Intersection Begins at 16:45																					
16:45	27	183	57	5	272	74	366	76	0	515	73	353	56	8	490	46	209	89	1	338	
17:00	26	191	39	8	264	59	366	76	0	501	73	353	56	8	490	39	209	89	1	338	
17:15	31	210	45	11	297	74	385	63	0	522	58	350	67	13	488	45	190	80	2	317	1624
17:30	41	212	44	7	304	74	384	57	0	515	49	337	86	15	487	34	178	86	1	299	1605
Total Volume	125	796	185	31	1137	281	1490	257	0	2028	252	1386	276	49	1963	164	772	342	4	1282	6410
% App. Total	11	70	16.3	2.7		13.9	73.5	12.7	0		12.8	70.6	14.1	2.5		12.8	60.2	26.7	0.3		
PHF	.762	.939	.811	.705	.935	.949	.968	.845	.000	.971	.863	.982	.802	.817	.985	.891	.923	.961	.500	.948	.987

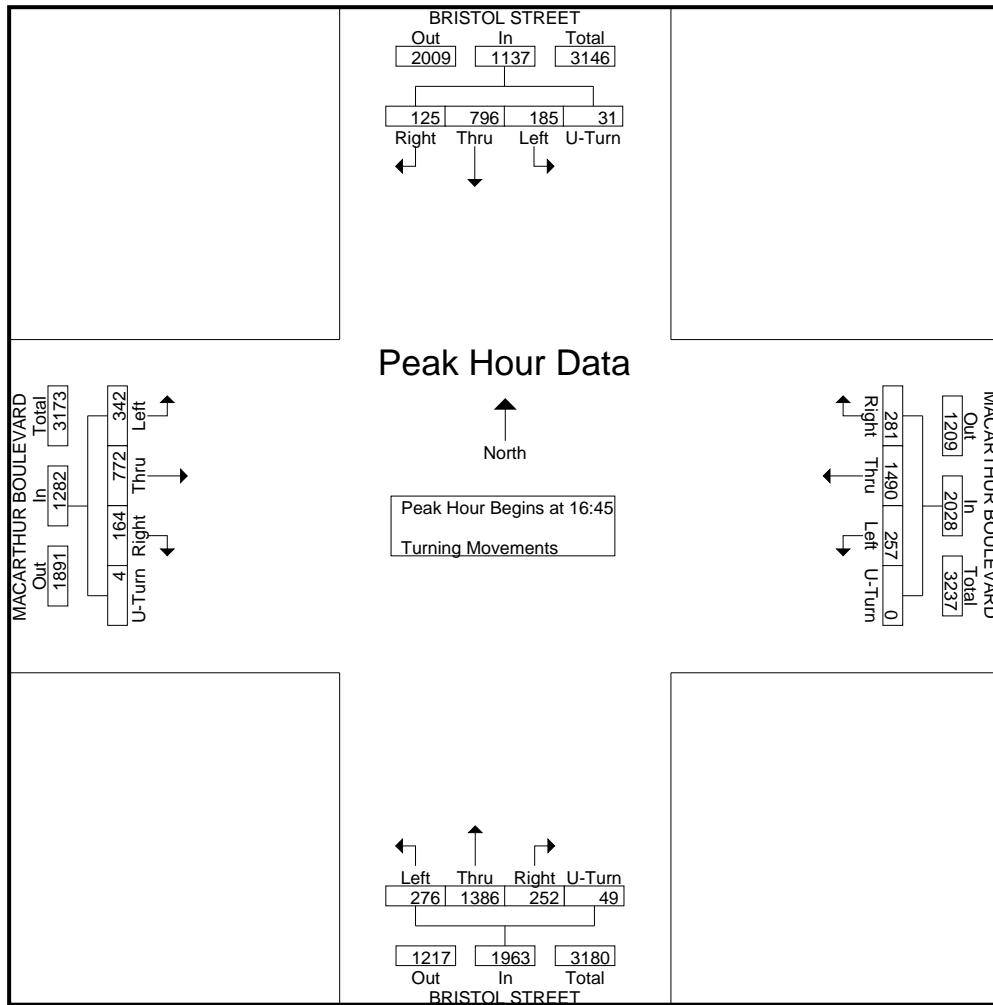

INTERSECTION TURNING MOVEMENT COUNTS

PREPARED BY: AimTD LLC. tel: 714 253 7888 pacific@aimtd.com

DATE: Tue, Mar 1, 16	LOCATION: NORTH & SOUTH: EAST & WEST:	Santa Ana Bristol Sunflower	PROJECT #: LOCATION #: CONTROL:	SC0846 14 SIGNAL
--------------------------------	--	-----------------------------------	--	------------------------

NOTES:	AM PM MD OTHER OTHER	◀ W	▲ N S ▼	E ▶
---------------	----------------------------------	-----	------------	-----

Add U-Turns to Left Turns

	NORTHBOUND			SOUTHBOUND			EASTBOUND			WESTBOUND			TOTAL	U-TURNS				
	NL	NT	NR	SL	ST	SR	EL	ET	ER	WL	WT	WR		NB	SB	EB	WB	TTL
LANES:	2	2.5	1.5	2	3	1	2	2.5	1.5	2	3	1	0	0	0	0	0	
AM																		
7:00 AM	20	112	12	30	301	14	15	94	61	59	55	32	805	0	2	0	4	6
7:15 AM	16	121	19	41	356	9	16	115	79	54	68	25	919	0	0	0	2	2
7:30 AM	20	97	26	43	351	18	34	205	85	74	108	34	1,095	0	2	0	3	5
7:45 AM	32	104	35	84	339	29	15	265	111	49	140	34	1,237	2	0	0	0	2
8:00 AM	23	103	26	47	284	29	27	259	101	55	76	35	1,065	2	0	0	4	6
8:15 AM	15	139	43	61	359	23	33	176	69	58	60	29	1,065	3	1	0	5	9
8:30 AM	17	117	28	47	254	27	23	134	69	69	51	38	874	1	1	0	7	9
8:45 AM	20	114	28	56	285	26	22	98	63	49	82	33	876	0	1	0	7	8
VOLUMES	163	907	217	409	2,529	175	185	1,346	638	467	640	260	7,936	8	7	0	32	47
APPROACH %	13%	70%	17%	13%	81%	6%	9%	62%	29%	34%	47%	19%						
APP/DEPART	1,287	/	1,359	3,113	/	3,610	2,169	/	1,997	1,367	/	970	0					
BEGIN PEAK HR	7:30 AM																	
VOLUMES	90	443	130	235	1,333	99	109	905	366	236	384	132	4,462					
APPROACH %	14%	67%	20%	14%	80%	6%	8%	66%	27%	31%	51%	18%						
PEAK HR FACTOR	0.841																	
APP/DEPART	663	/	687	1,667	/	1,930	1,380	/	1,279	752	/	566	0					
PM																		
4:00 PM	139	353	49	33	143	36	63	104	49	42	162	65	1,238	3	1	4	3	11
4:15 PM	152	356	47	28	158	46	81	125	47	52	168	63	1,323	5	2	6	4	17
4:30 PM	148	341	54	44	185	41	64	102	39	56	218	83	1,375	6	5	3	7	21
4:45 PM	150	347	44	43	152	38	67	111	53	65	253	70	1,393	4	2	7	8	21
5:00 PM	138	339	67	48	167	44	68	122	47	52	228	80	1,400	6	2	3	5	16
5:15 PM	165	318	46	40	173	50	68	131	53	62	246	87	1,439	4	4	3	6	17
5:30 PM	155	331	48	57	188	54	73	149	54	53	259	64	1,485	0	4	5	6	15
5:45 PM	161	321	50	48	192	58	72	148	59	85	239	78	1,511	2	2	4	6	14
VOLUMES	1,208	2,706	405	341	1,358	367	556	992	401	467	1,773	590	11,164	30	22	35	45	132
APPROACH %	28%	63%	9%	17%	66%	18%	29%	51%	21%	17%	63%	21%						
APP/DEPART	4,319	/	3,839	2,066	/	2,211	1,949	/	1,761	2,830	/	3,353	0					
BEGIN PEAK HR	5:00 PM																	
VOLUMES	619	1,309	211	193	720	206	281	550	213	252	972	309	5,835					
APPROACH %	29%	61%	10%	17%	64%	18%	27%	53%	20%	16%	63%	20%						
PEAK HR FACTOR	0.983																	
APP/DEPART	2,139	/	1,896	1,119	/	1,174	1,044	/	965	1,533	/	1,800	0					

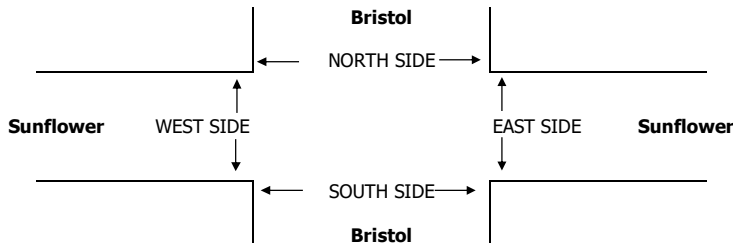

	PEDESTRIAN + BIKE CROSSINGS				
	N SIDE	S SIDE	E SIDE	W SIDE	TOTAL
AM					
7:00 AM	13	5	4	4	26
7:15 AM	3	1	5	0	9
7:30 AM	3	3	1	5	12
7:45 AM	3	4	0	2	9
8:00 AM	5	3	0	2	10
8:15 AM	5	2	2	3	12
8:30 AM	13	6	6	1	26
8:45 AM	6	3	2	6	17
TOTAL	51	27	20	23	121
PM					
4:00 PM	13	4	7	8	32
4:15 PM	9	5	5	1	20
4:30 PM	21	13	5	11	50
4:45 PM	18	9	3	11	41
5:00 PM	11	4	13	10	38
5:15 PM	8	4	7	6	25
5:30 PM	13	5	5	6	29
5:45 PM	16	5	7	5	33
TOTAL	109	49	52	58	268

	PEDESTRIAN CROSSINGS				
	N SIDE	S SIDE	E SIDE	W SIDE	TOTAL
AM					
7:00 AM	13	2	4	4	23
7:15 AM	3	0	3	0	6
7:30 AM	3	3	1	4	11
7:45 AM	3	2	0	2	7
8:00 AM	4	3	0	2	9
8:15 AM	5	1	1	2	9
8:30 AM	11	5	6	1	23
8:45 AM	5	3	2	5	15
TOTAL	47	19	17	20	103
PM					
4:00 PM	12	4	6	8	30
4:15 PM	7	5	5	1	18
4:30 PM	17	11	5	9	42
4:45 PM	15	8	3	11	37
5:00 PM	11	3	9	10	33
5:15 PM	8	4	6	6	24
5:30 PM	12	4	4	5	25
5:45 PM	16	4	6	5	31
TOTAL	98	43	44	55	240

	BICYCLE CROSSINGS				
	NS	SS	ES	WS	TOTAL
AM					
7:00 AM	0	3	0	0	3
7:15 AM	0	1	2	0	3
7:30 AM	0	0	0	1	1
7:45 AM	0	2	0	0	2
8:00 AM	1	0	0	0	1
8:15 AM	0	1	1	1	3
8:30 AM	2	1	0	0	3
8:45 AM	1	0	0	1	2
TOTAL	4	8	3	3	18
PM					
4:00 PM	1	0	1	0	2
4:15 PM	2	0	0	0	2
4:30 PM	4	2	0	2	8
4:45 PM	3	1	0	0	4
5:00 PM	0	1	4	0	5
5:15 PM	0	0	1	0	1
5:30 PM	1	1	1	1	4
5:45 PM	0	1	1	0	2
TOTAL	11	6	8	3	28

Bristol St & I-405 NB Ramps

Peak Hour Turning Movement Count

ID: Historical
City: Costa Mesa

Day: Thursday
Date: 10/11/2018

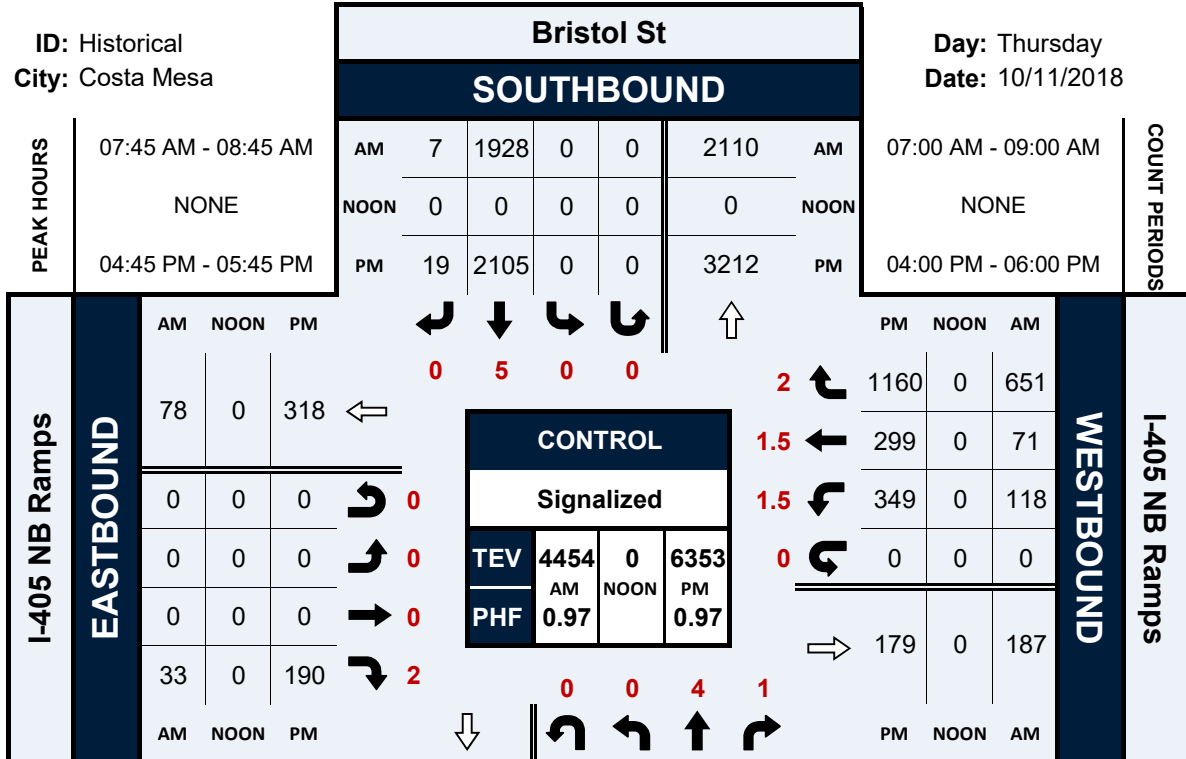

Total Vehicles (AM)

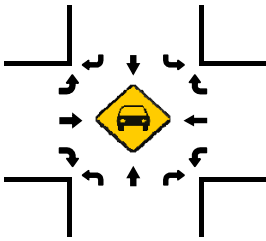

Total Vehicles (NOON)

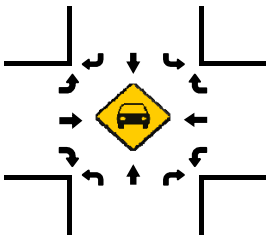

Total Vehicles (PM)

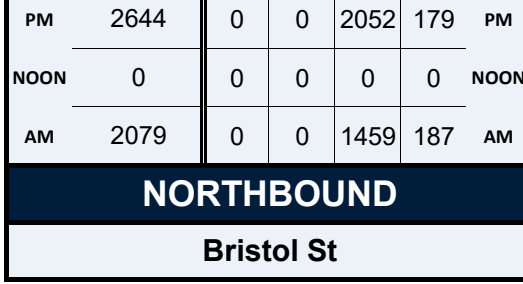
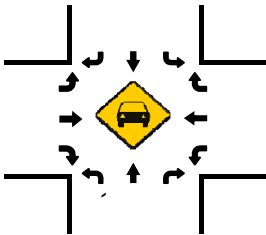

Total Vehicles (AM)

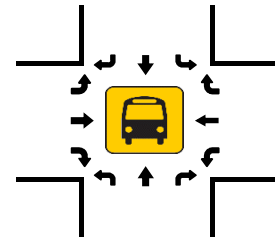

Total Vehicles (NOON)

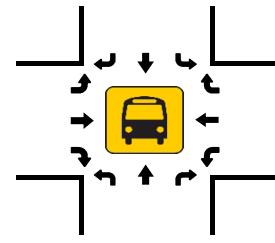

Total Vehicles (PM)

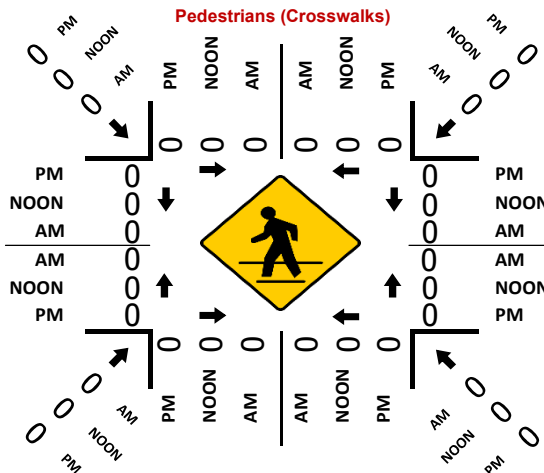
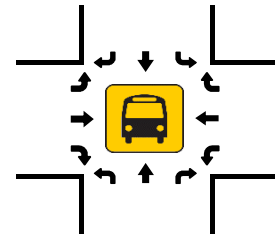

Bristol St & I-405 SB Ramps

Peak Hour Turning Movement Count

ID: Historical
City: Costa Mesa

Day: Thursday
Date: 10/11/2018

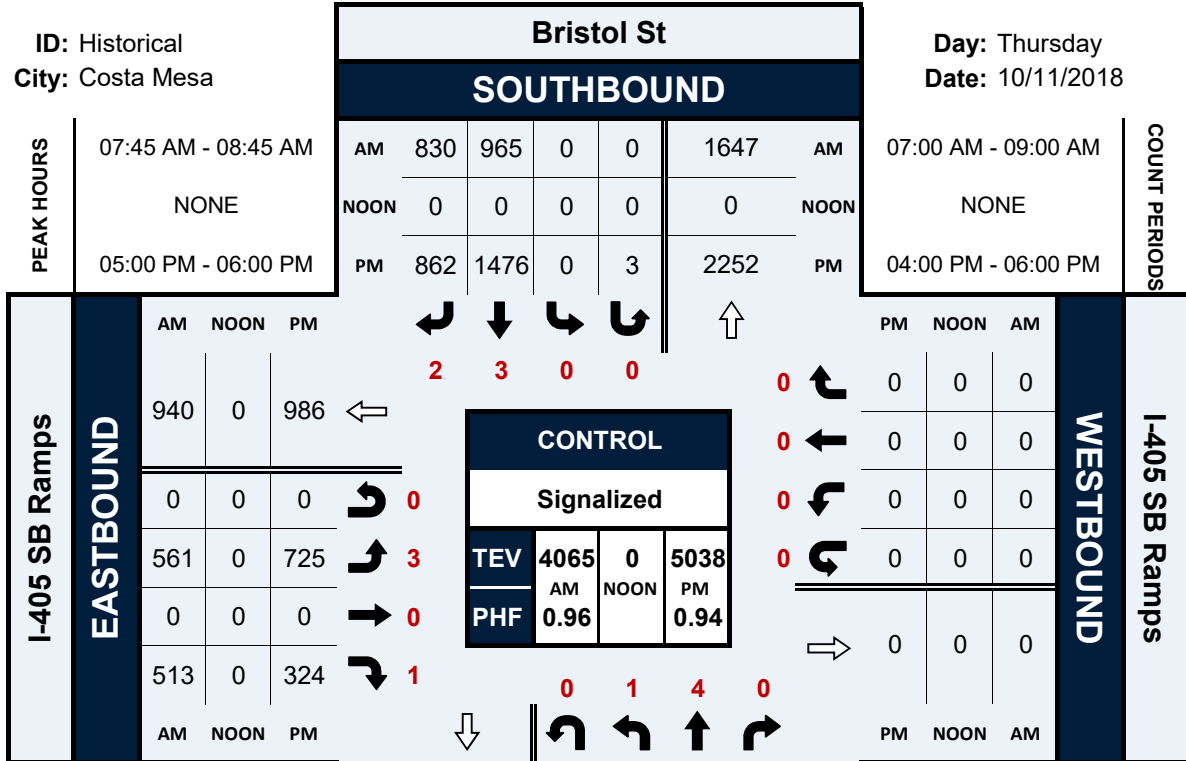

Total Vehicles (AM)

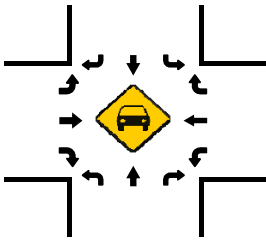

Total Vehicles (NOON)

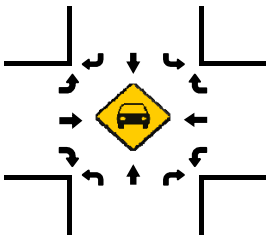

Total Vehicles (PM)

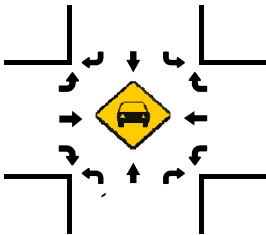

Total Vehicles (AM)

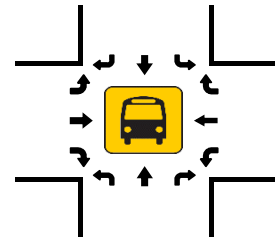

Total Vehicles (NOON)

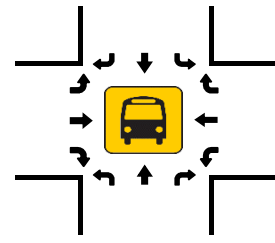

Total Vehicles (PM)

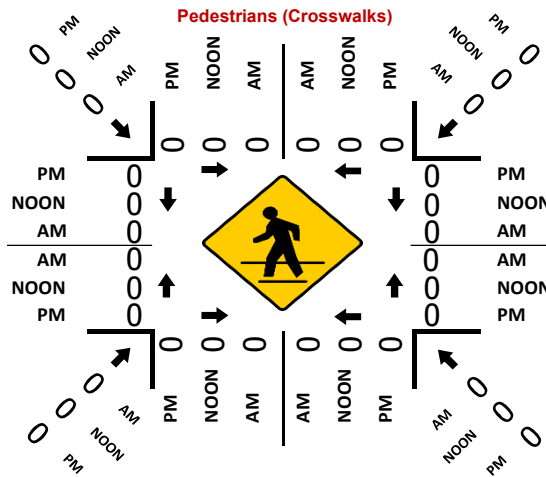
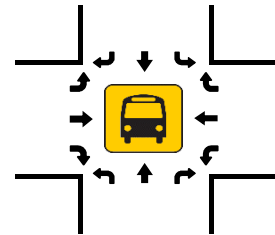

INTERSECTION TURNING MOVEMENT COUNTS

PREPARED BY: AimTD LLC. tel: 714 253 7888 pacific@aimtd.com

DATE: Thu, Feb 11, 16	LOCATION: NORTH & SOUTH: EAST & WEST:	Santa Ana Flower Santa Ana	PROJECT #: LOCATION #: CONTROL:	SC0846 23 SIGNAL
---------------------------------	--	----------------------------------	--	------------------------

NOTES:	AM		▲	
	PM		N	
	MD	◀ W		E ▶
	OTHER		S	
	OTHER		▼	



LANES:	NORTHBOUND			SOUTHBOUND			EASTBOUND			WESTBOUND			TOTAL
	Flower			Flower			Santa Ana			Santa Ana			
	NL	NT	NR	SL	ST	SR	EL	ET	ER	WL	WT	WR	
	1	2	1	1	2	1	1	3	1	1	2	1	
AM													
7:00 AM	11	120	17	30	104	24	11	85	18	16	63	26	525
7:15 AM	14	199	19	36	131	20	24	146	24	22	78	25	738
7:30 AM	17	234	36	38	156	17	26	202	20	35	92	33	906
7:45 AM	26	194	35	50	156	25	33	193	23	18	73	22	848
8:00 AM	26	152	23	37	102	11	26	141	10	22	67	49	666
8:15 AM	10	95	28	47	85	20	20	104	14	10	51	35	519
8:30 AM	13	128	19	26	86	9	6	50	11	14	42	25	429
8:45 AM	20	105	13	24	63	4	15	52	8	18	36	26	384
VOLUMES	137	1,227	190	288	883	130	161	973	128	155	502	241	5,015
APPROACH %	9%	79%	12%	22%	68%	10%	13%	77%	10%	17%	56%	27%	
APP/DEPART	1,554	/	1,629	1,301	/	1,170	1,262	/	1,451	898	/	765	0
BEGIN PEAK HR	7:15 AM												
VOLUMES	83	779	113	161	545	73	109	682	77	97	310	129	3,158
APPROACH %	9%	80%	12%	21%	70%	9%	13%	79%	9%	18%	58%	24%	
PEAK HR FACTOR	0.849			0.843			0.871			0.838			0.871
APP/DEPART	975	/	1,017	779	/	720	868	/	956	536	/	465	0
PM													
4:00 PM	19	161	17	28	111	14	19	84	11	26	82	20	592
4:15 PM	25	148	23	23	94	7	13	105	17	37	71	30	593
4:30 PM	18	152	13	30	123	11	42	123	13	34	98	33	690
4:45 PM	31	171	18	39	133	10	26	82	20	25	97	25	677
5:00 PM	26	152	16	24	125	9	47	103	15	43	149	56	765
5:15 PM	33	210	12	19	120	14	22	90	13	46	125	29	733
5:30 PM	29	191	13	17	131	13	33	95	12	26	119	35	714
5:45 PM	24	206	14	9	90	7	15	69	11	30	98	28	601
VOLUMES	205	1,391	126	189	927	85	217	751	112	267	839	256	5,365
APPROACH %	12%	81%	7%	16%	77%	7%	20%	70%	10%	20%	62%	19%	
APP/DEPART	1,722	/	1,864	1,201	/	1,308	1,080	/	1,066	1,362	/	1,127	0
BEGIN PEAK HR	4:45 PM												
VOLUMES	119	724	59	99	509	46	128	370	60	140	490	145	2,889
APPROACH %	13%	80%	7%	15%	78%	7%	23%	66%	11%	18%	63%	19%	
PEAK HR FACTOR	0.884			0.898			0.845			0.781			0.944
APP/DEPART	902	/	997	654	/	711	558	/	528	775	/	653	0

U-TURNS				
NB	SB	EB	WB	TTL
0	0	0	0	0
0	0	0	0	0
0	0	0	0	0
0	0	0	0	0
1	0	0	0	1
0	0	0	0	0
1	0	0	0	1
2	0	0	0	2
4	0	0	0	4
0	0	0	0	0
0	0	0	0	0
0	0	0	0	0
0	0	0	0	0
1	0	0	0	1
0	0	0	0	0
1	0	0	0	1
0	0	0	0	0
2	0	0	0	2

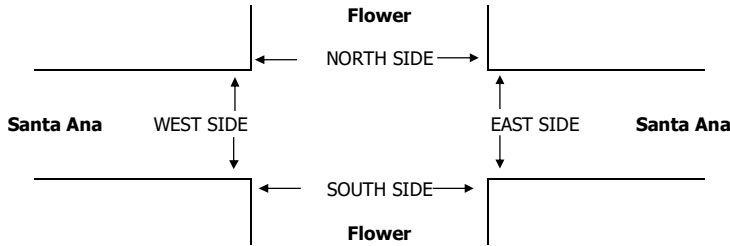

Time	N Side	S Side	E Side	W Side	Total
7:00 AM	7	10	13	18	48
7:15 AM	7	9	27	23	66
7:30 AM	6	8	23	20	57
7:45 AM	2	4	55	25	86
8:00 AM	3	8	17	12	40
8:15 AM	5	9	17	6	37
8:30 AM	10	15	15	9	49
8:45 AM	11	24	9	26	70
TOTAL	51	87	176	139	453

PEDESTRIAN + BIKE CROSSINGS					
N Side	S Side	E Side	W Side	Total	
2	7	7	22	38	
8	14	9	26	57	
10	5	8	10	33	
2	3	10	13	28	
1	9	6	12	28	
5	5	6	4	20	
1	3	5	8	17	
4	3	5	10	22	
TOTAL	33	49	56	105	243

PEDESTRIAN CROSSINGS					
N Side	S Side	E Side	W Side	Total	
1	1	9	14	25	
3	0	26	16	45	
1	1	16	17	35	
0	0	53	22	75	
2	0	17	9	28	
0	4	16	3	23	
0	0	11	9	20	
4	1	8	26	39	
11	7	156	116	290	
0	2	5	17	24	
4	0	8	24	36	
1	1	6	9	17	
0	1	8	9	18	
0	1	5	12	18	
1	3	3	3	10	
1	2	4	8	15	
1	0	2	9	12	
TOTAL	8	10	41	91	150

BICYCLE CROSSINGS					
NS	SS	ES	WS	Total	
6	9	4	4	23	
4	9	1	7	21	
5	7	7	3	22	
2	4	2	3	11	
1	8	0	3	12	
5	5	1	3	14	
10	15	4	0	29	
7	23	1	0	31	
40	80	20	23	163	
2	5	2	5	14	
4	14	1	2	21	
9	4	2	1	16	
2	2	2	4	10	
1	8	1	0	10	
4	2	3	1	10	
0	1	1	0	2	
3	3	3	1	10	
TOTAL	25	39	15	14	93

City: SANTA ANA
N-S Direction: FLOWER STREET
E-W Direction: 1ST STREET

File Name : H1702009
Site Code : 00000000
Start Date : 2/9/2017
Page No : 1

Groups Printed- Turning Movements

Start Time	FLOWER STREET Southbound			1ST STREET Westbound				FLOWER STREET Northbound				1ST STREET Eastbound			Int. Total
	Right	Thru	Left	Right	Thru	Left	U-Turn	Right	Thru	Left	U-Turn	Right	Thru	Left	
07:00	13	106	37	21	158	32	2	37	110	22	1	18	324	25	906
07:15	12	113	35	35	201	42	10	44	143	39	0	15	383	39	1111
07:30	16	132	55	21	205	39	18	32	155	32	1	18	364	35	1123
07:45	13	162	46	40	235	45	12	41	175	40	0	16	363	39	1227
Total	54	513	173	117	799	158	42	154	583	133	2	67	1434	138	4367
08:00	15	130	33	23	194	29	7	37	111	22	0	9	359	47	1016
08:15	17	58	32	23	168	39	6	32	78	21	1	15	329	37	856
08:30	15	61	35	20	145	28	0	28	69	16	2	9	319	33	780
08:45	24	60	39	16	139	17	1	29	61	18	0	17	293	25	739
Total	71	309	139	82	646	113	14	126	319	77	3	50	1300	142	3391
*** BREAK ***															
16:00	30	82	49	28	305	52	3	28	97	34	0	21	288	35	1052
16:15	34	94	46	29	358	41	2	28	142	35	2	16	271	44	1142
16:30	22	140	37	20	336	40	8	29	122	35	0	16	264	31	1100
16:45	26	114	51	31	360	53	3	33	143	25	0	25	291	34	1189
Total	112	430	183	108	1359	186	16	118	504	129	2	78	1114	144	4483
17:00	37	115	47	36	327	53	3	39	159	34	3	18	312	35	1218
17:15	34	110	40	34	364	45	2	35	150	35	0	25	293	29	1196
17:30	34	113	27	41	322	39	5	37	154	29	2	30	285	36	1154
17:45	25	118	36	47	317	43	8	27	141	34	1	23	303	32	1155
Total	130	456	150	158	1330	180	18	138	604	132	6	96	1193	132	4723
Grand Total	367	1708	645	465	4134	637	90	536	2010	471	13	291	5041	556	16964
Apprch %	13.5	62.8	23.7	8.7	77.6	12	1.7	17.7	66.3	15.5	0.4	4.9	85.6	9.4	
Total %	2.2	10.1	3.8	2.7	24.4	3.8	0.5	3.2	11.8	2.8	0.1	1.7	29.7	3.3	

City: SANTA ANA
 N-S Direction: FLOWER STREET
 E-W Direction: 1ST STREET

File Name : H1702009
 Site Code : 00000000
 Start Date : 2/9/2017
 Page No : 2

Start Time	FLOWER STREET Southbound				1ST STREET Westbound					FLOWER STREET Northbound					1ST STREET Eastbound				Int. Total
	Right	Thru	Left	App. Total	Right	Thru	Left	U-Turn	App. Total	Right	Thru	Left	U-Turn	App. Total	Right	Thru	Left	App. Total	
Peak Hour Analysis From 07:00 to 08:45 - Peak 1 of 1																			
Peak Hour for Entire Intersection Begins at 07:15																			
07:15	12	113	35	160	35	201	42	10	288	44							383	437	1111
07:30	16	132	55	203	21	205	39	18					1	220	18	364	35	417	1123
07:45	13	162	46	221	40	235	45	12	332		175	40	0	256	16	363	39	418	1227
08:00	15	130	33	178	23	194	29	7	253	37	111	22	0	170	9	359	47	415	1016
Total Volume	56	537	169	762	119	835	155	47	1156	154	584	133	1	872	58	1469	160	1687	4477
% App. Total	7.3	70.5	22.2		10.3	72.2	13.4	4.1		17.7	67	15.3	0.1		3.4	87.1	9.5		
PHF	.875	.829	.768	.862	.744	.888	.861	.653	.870	.875	.834	.831	.250	.852	.806	.959	.851	.965	.912

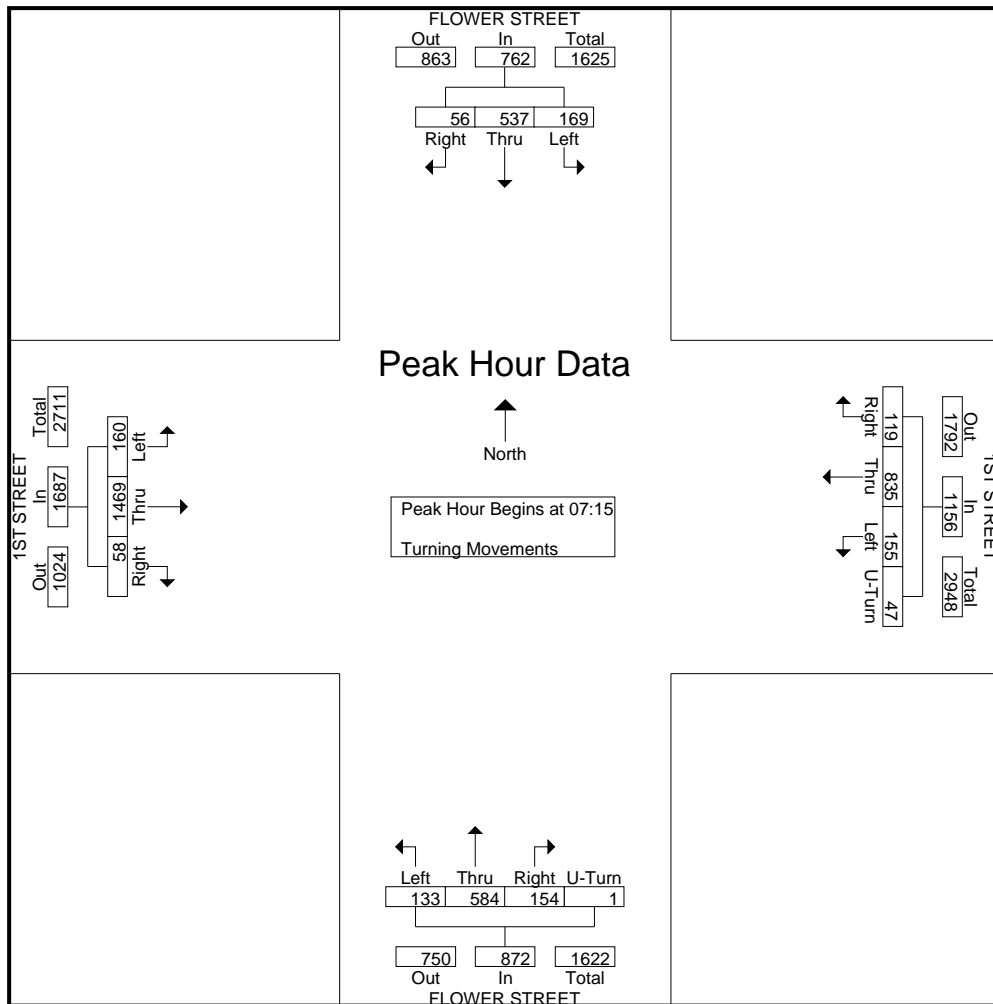

City: SANTA ANA
 N-S Direction: FLOWER STREET
 E-W Direction: 1ST STREET

File Name : H1702009
 Site Code : 00000000
 Start Date : 2/9/2017
 Page No : 3

Start Time	FLOWER STREET Southbound				1ST STREET Westbound					FLOWER STREET Northbound					1ST STREET Eastbound				Int. Total	
	Right	Thru	Left	App. Total	Right	Thru	Left	U-Turn	App. Total	Right	Thru	Left	U-Turn	App. Total	Right	Thru	Left	App. Total		
Peak Hour Analysis From 16:00 to 17:45 - Peak 1 of 1																				
Peak Hour for Entire Intersection Begins at 16:45																				
16:45	26	114	51	199	53					447	33	143	25	0	201	25	291	34	350	1189
17:00	37	115	47	199	34	364	45	2	445	39	159	34	3	220	25	293	29	347	1196	
17:30	34	113	27	174	41	322	39	5	407	30	285	36	0	351	25	293	29	347	1154	
Total Volume	131	452	165	748	142	1373	190	13	1718	144	606	123	5	878	98	1181	134	1413	4757	
% App. Total	17.5	60.4	22.1		8.3	79.9	11.1	0.8		16.4	69	14	0.6		6.9	83.6	9.5			
PHF	.885	.983	.809	.940	.866	.943	.896	.650	.961	.923	.953	.879	.417	.934	.817	.946	.931	.968	.976	

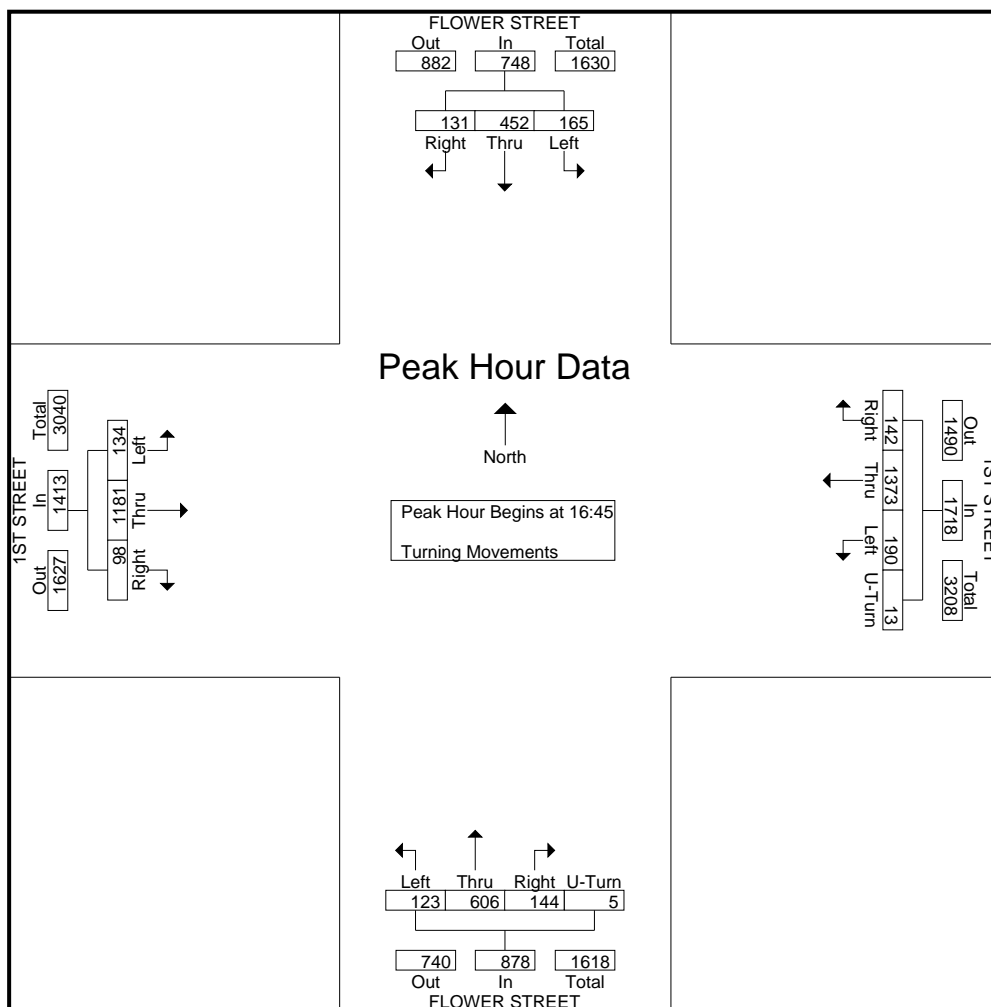

INTERSECTION TURNING MOVEMENT COUNTS

PREPARED BY: AimTD LLC. tel: 714 253 7888 pacific@aimtd.com

DATE: Thu, Feb 11, 16 LOCATION: Santa Ana Flower McFadden PROJECT #: SC0846
 NORTH & SOUTH: Flower LOCATION #: 36
 EAST & WEST: McFadden CONTROL: SIGNAL

NOTES:

AM	▲	N
PM	▼	S
MD	◀	W
OTHER	▶	E

Add U-Turns to Left Turns

	NORTHBOUND			SOUTHBOUND			EASTBOUND			WESTBOUND			TOTAL	U-TURNS				
	NL	NT	NR	SL	ST	SR	EL	ET	ER	WL	WT	WR		NB	SB	EB	WB	TTL
LANES:	1	1	0	1	1	0	1	1	0	1	1	0	0	0	0	0	0	
AM																		
7:00 AM	8	75	5	14	75	8	12	86	10	8	79	5	0	0	0	0	0	
7:15 AM	8	102	8	10	89	10	13	134	12	12	92	15	0	0	0	0	0	
7:30 AM	13	105	10	14	85	13	13	139	19	16	120	15	0	0	0	0	0	
7:45 AM	15	111	8	18	90	15	11	145	5	22	112	13	0	0	0	0	0	
8:00 AM	21	102	10	21	88	12	12	140	6	11	91	12	0	0	0	0	0	
8:15 AM	9	82	8	15	66	7	13	89	6	13	66	4	0	0	0	0	0	
8:30 AM	5	64	10	10	79	8	10	81	4	9	59	8	0	0	0	0	0	
8:45 AM	7	63	6	9	54	10	9	90	4	11	76	3	0	0	0	0	0	
VOLUMES	86	704	65	111	626	83	93	904	66	102	695	75	0	0	0	0	0	
APPROACH %	10%	82%	8%	14%	76%	10%	9%	85%	6%	12%	80%	9%	0	0	0	0	0	
APP/DEPART	855	/	872	820	/	794	1,063	/	1,080	872	/	864	0	0	0	0	0	
BEGIN PEAK HR	7:15 AM																	
VOLUMES	57	420	36	63	352	50	49	558	42	61	415	55	0	0	0	0	0	
APPROACH %	11%	82%	7%	14%	76%	11%	8%	86%	6%	11%	78%	10%	0	0	0	0	0	
PEAK HR FACTOR	0.957																	
APP/DEPART	513	/	524	465	/	455	649	/	657	531	/	522	0	0	0	0	0	
PM																		
4:00 PM	11	106	6	6	65	9	9	121	9	9	126	18	0	0	0	0	0	
4:15 PM	10	137	5	8	93	13	8	106	4	12	136	15	0	0	0	0	0	
4:30 PM	12	119	5	14	64	18	12	100	2	15	126	13	0	0	0	0	0	
4:45 PM	8	135	7	8	75	17	10	110	4	9	148	7	0	0	0	0	0	
5:00 PM	10	135	9	14	60	9	15	109	4	6	131	17	0	0	0	0	0	
5:15 PM	9	143	10	10	95	16	15	100	3	13	145	21	0	0	0	0	0	
5:30 PM	10	139	7	10	105	10	15	127	5	10	142	21	0	0	0	0	0	
5:45 PM	11	127	7	10	78	19	16	123	6	17	153	22	0	0	0	0	0	
VOLUMES	81	1,041	56	80	635	111	100	896	37	91	1,107	134	0	0	0	0	0	
APPROACH %	7%	88%	5%	10%	77%	13%	10%	87%	4%	7%	83%	10%	0	0	0	0	0	
APP/DEPART	1,178	/	1,275	826	/	763	1,033	/	1,032	1,332	/	1,299	0	0	0	0	0	
BEGIN PEAK HR	5:00 PM																	
VOLUMES	40	544	33	44	338	54	61	459	18	46	571	81	0	0	0	0	0	
APPROACH %	6%	88%	5%	10%	78%	12%	11%	85%	3%	7%	82%	12%	0	0	0	0	0	
PEAK HR FACTOR	0.952																	
APP/DEPART	617	/	686	436	/	402	538	/	536	698	/	665	0	0	0	0	0	

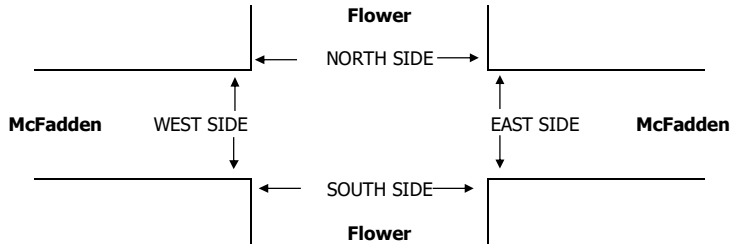

		PEDESTRIAN + BIKE CROSSINGS				
		N SIDE	S SIDE	E SIDE	W SIDE	TOTAL
AM	7:00 AM	8	9	9	5	31
	7:15 AM	7	2	3	4	16
	7:30 AM	15	9	7	14	45
	7:45 AM	8	19	9	15	51
	8:00 AM	4	5	3	9	21
	8:15 AM	3	7	5	11	26
	8:30 AM	2	2	2	6	12
	8:45 AM	2	2	0	4	8
TOTAL		49	55	38	68	210
PM	4:00 PM	10	7	13	10	40
	4:15 PM	7	8	7	5	27
	4:30 PM	4	3	3	3	13
	4:45 PM	3	7	6	6	22
	5:00 PM	8	3	0	8	19
	5:15 PM	4	6	7	7	24
	5:30 PM	11	8	8	7	34
	5:45 PM	6	11	4	4	25
TOTAL		53	53	48	50	204

		PEDESTRIAN CROSSINGS					
		N SIDE	S SIDE	E SIDE	W SIDE	TOTAL	
	7:00 AM	2	1	7	5	15	
	7:15 AM	1	0	2	4	7	
	7:30 AM	1	0	7	12	20	
	7:45 AM	3	0	8	15	26	
	8:00 AM	2	0	3	9	14	
	8:15 AM	3	2	4	9	18	
	8:30 AM	1	1	1	4	7	
	8:45 AM	0	0	0	4	4	
	TOTAL		13	4	32	62	111
		4:00 PM	3	0	11	9	23
		4:15 PM	0	1	7	5	13
4:30 PM		3	0	2	2	7	
4:45 PM		2	0	6	6	14	
5:00 PM		2	0	0	6	8	
5:15 PM		1	1	6	6	14	
5:30 PM		1	0	8	7	16	
5:45 PM		1	4	4	2	11	
TOTAL		13	6	44	43	106	

		BICYCLE CROSSINGS					
		NS	SS	ES	WS	TOTAL	
	7:00 AM	6	8	2	0	16	
	7:15 AM	6	2	1	0	9	
	7:30 AM	14	9	0	2	25	
	7:45 AM	5	19	1	0	25	
	8:00 AM	2	5	0	0	7	
	8:15 AM	0	5	1	2	8	
	8:30 AM	1	1	1	2	5	
	8:45 AM	2	2	0	0	4	
	TOTAL		36	51	6	6	99
		4:00 PM	7	7	2	1	17
		4:15 PM	7	7	0	0	14
4:30 PM		1	3	1	1	6	
4:45 PM		1	7	0	0	8	
5:00 PM		6	3	0	2	11	
5:15 PM		3	5	1	1	10	
5:30 PM		10	8	0	0	18	
5:45 PM		5	7	0	2	14	
TOTAL		40	47	4	7	98	

INTERSECTION TURNING MOVEMENT COUNTS

PREPARED BY: AimTD LLC. tel: 714 253 7888 pacific@aimtd.com

DATE:
Tue, Feb 9, 16

LOCATION:
NORTH & SOUTH: Santa Ana
Flower
EAST & WEST: Segerstrom

PROJECT #: SC0846
LOCATION #: 47
CONTROL: SIGNAL

NOTES:	AM		▲	
	PM		N	
	MD	◀ W	S	E ▶
	OTHER		▼	

Add U-Turns to Left Turns

LANES:	NORTHBOUND			SOUTHBOUND			EASTBOUND			WESTBOUND			TOTAL
	Flower			Flower			Segerstrom			Segerstrom			
	NL	NT	NR	SL	ST	SR	EL	ET	ER	WL	WT	WR	
	1	2	0	1	2	0	1	2	0	1	2	0	

U-TURNS				
NB	SB	EB	WB	TTL
0	0	0	0	0

	NORTHBOUND			SOUTHBOUND			EASTBOUND			WESTBOUND			TOTAL
	NL	NT	NR	SL	ST	SR	EL	ET	ER	WL	WT	WR	
AM													
7:00 AM	16	50	12	28	108	31	33	200	68	18	96	10	670
7:15 AM	16	84	14	25	149	16	24	252	65	18	114	11	788
7:30 AM	14	96	27	21	155	27	37	272	91	20	181	17	958
7:45 AM	14	88	17	20	110	41	54	299	61	15	133	19	871
8:00 AM	10	52	9	32	95	18	29	287	44	9	77	5	667
8:15 AM	11	42	10	26	99	9	10	204	16	8	82	6	523
8:30 AM	14	51	9	40	82	5	4	190	20	7	63	2	487
8:45 AM	10	32	11	24	80	5	5	179	21	2	83	9	461
VOLUMES	105	495	109	216	878	152	196	1,883	386	97	829	79	5,425
APPROACH %	15%	70%	15%	17%	70%	12%	8%	76%	16%	10%	82%	8%	
APP/DEPART	709	/	770	1,246	/	1,361	2,465	/	2,208	1,005	/	1,086	0
BEGIN PEAK HR	7:00 AM												
VOLUMES	60	318	70	94	522	115	148	1,023	285	71	524	57	3,287
APPROACH %	13%	71%	16%	13%	71%	16%	10%	70%	20%	11%	80%	9%	
PEAK HR FACTOR	0.818			0.900			0.879			0.748			0.858
APP/DEPART	448	/	523	731	/	878	1,456	/	1,187	652	/	699	0
PM													
4:00 PM	35	162	18	21	71	15	38	138	19	16	281	32	846
4:15 PM	26	157	17	13	69	18	28	156	13	13	277	23	810
4:30 PM	43	185	23	13	83	10	29	152	29	20	287	18	892
4:45 PM	26	194	22	20	72	21	31	153	19	20	296	30	904
5:00 PM	29	201	24	15	81	28	52	170	13	20	274	19	926
5:15 PM	31	219	20	17	80	22	44	211	23	16	317	19	1,019
5:30 PM	30	208	16	15	97	22	33	199	23	19	315	17	994
5:45 PM	25	182	16	16	96	29	22	175	20	17	302	22	922
VOLUMES	245	1,508	156	130	649	165	277	1,354	159	141	2,349	180	7,313
APPROACH %	13%	79%	8%	14%	69%	17%	15%	76%	9%	5%	88%	7%	
APP/DEPART	1,909	/	1,965	944	/	949	1,790	/	1,640	2,670	/	2,759	0
BEGIN PEAK HR	5:00 PM												
VOLUMES	115	810	76	63	354	101	151	755	79	72	1,208	77	3,861
APPROACH %	11%	81%	8%	12%	68%	19%	15%	77%	8%	5%	89%	6%	
PEAK HR FACTOR	0.927			0.918			0.886			0.964			0.947
APP/DEPART	1,001	/	1,038	518	/	505	985	/	894	1,357	/	1,424	0

0	0	0	0	0
0	0	0	0	0
0	0	0	0	0
0	0	0	0	0
0	0	0	0	0
0	0	0	0	0
0	0	0	0	0
0	0	0	0	0
0	0	0	0	0
0	0	0	0	0
0	0	0	0	0
0	0	0	0	0
0	0	0	0	0
0	0	0	0	0
0	0	0	0	0
0	0	0	0	0
0	0	0	0	0

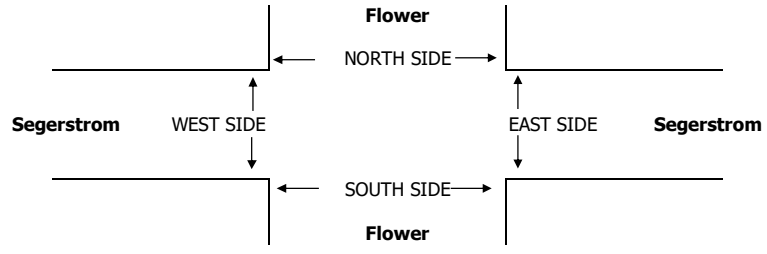

	PEDESTRIAN + BIKE CROSSINGS				
	N SIDE	S SIDE	E SIDE	W SIDE	TOTAL
AM					
7:00 AM	5	5	1	8	19
7:15 AM	8	17	6	28	59
7:30 AM	27	34	9	54	124
7:45 AM	27	56	20	132	235
8:00 AM	1	2	0	11	14
8:15 AM	2	2	2	8	14
8:30 AM	1	1	2	2	6
8:45 AM	1	1	0	1	3
TOTAL	72	118	40	244	474
PM					
4:00 PM	1	11	3	11	26
4:15 PM	2	9	4	2	17
4:30 PM	3	7	2	8	20
4:45 PM	5	7	1	12	25
5:00 PM	3	5	4	14	26
5:15 PM	1	5	8	5	19
5:30 PM	4	6	1	4	15
5:45 PM	6	7	0	4	17
TOTAL	25	57	23	60	165

PEDESTRIAN CROSSINGS				
N SIDE	S SIDE	E SIDE	W SIDE	TOTAL
3	4	1	8	16
5	14	5	26	50
26	32	9	53	120
27	55	19	132	233
1	2	0	11	14
2	2	0	6	10
0	1	1	1	3
0	0	0	1	1
64	110	35	238	447
0	11	3	11	25
1	6	2	2	11
1	6	2	6	15
4	5	1	11	21
1	4	1	10	16
0	2	7	5	14
2	6	1	4	13
3	7	0	2	12
12	47	17	51	127

BICYCLE CROSSINGS				
NS	SS	ES	WS	TOTAL
2	1	0	0	3
3	3	1	2	9
1	2	0	1	4
0	1	1	0	2
0	0	0	0	0
0	0	2	2	4
1	0	1	1	3
1	1	0	0	2
8	8	5	6	27
1	0	0	0	1
1	3	2	0	6
2	1	0	2	5
1	2	0	1	4
2	1	3	4	10
1	3	1	0	5
2	0	0	0	2
3	0	0	2	5
13	10	6	9	38

INTERSECTION TURNING MOVEMENT COUNTS

PREPARED BY: AimTD LLC. tel: 714 253 7888 pacific@aimtd.com

DATE:
Tue, Feb 9, 16

LOCATION:
NORTH & SOUTH: Santa Ana
EAST & WEST: Flower
MacArthur

PROJECT #: SC0846
LOCATION #: 53
CONTROL: MAC

NOTES:

AM		▲	
PM		N	
MD	◀ W		E ▶
OTHER		S	
OTHER		▼	

Add U-Turns to Left Turns

LANES:	NORTHBOUND			SOUTHBOUND			EASTBOUND			WESTBOUND			TOTAL
	Flower			Flower			MacArthur			MacArthur			
	NL	NT	NR	SL	ST	SR	EL	ET	ER	WL	WT	WR	
	1	2	0	1	2	0	1	3	0	1	3	0	

U-TURNS				
NB	SB	EB	WB	TTL
0	0	0	0	0

7:00 AM	9	26	20	36	60	51	28	315	14	6	142	9	716
7:15 AM	5	32	17	40	70	54	54	424	15	11	218	17	957
7:30 AM	6	44	25	35	88	100	45	478	16	16	297	16	1,166
7:45 AM	4	35	13	45	104	67	30	460	27	12	197	15	1,009
8:00 AM	6	25	15	36	76	32	29	443	18	12	161	7	860
8:15 AM	9	32	15	47	82	21	24	438	33	10	171	13	895
8:30 AM	10	27	16	36	47	20	23	368	21	17	148	17	750
8:45 AM	10	21	12	30	65	24	13	329	16	8	128	11	667

0	0	0	0	0
0	0	0	1	1
0	0	1	0	1
0	0	1	1	2
0	0	1	0	1
0	0	0	1	1
0	0	0	0	0
0	0	0	0	0
0	0	3	3	6

VOLUMES	59	242	133	305	592	369	246	3,255	160	92	1,462	105	7,020
APPROACH %	14%	56%	31%	24%	47%	29%	7%	89%	4%	6%	88%	6%	
APP/DEPART	434	/	590	1,266	/	841	3,661	/	3,696	1,659	/	1,893	0
BEGIN PEAK HR	7:15 AM												
VOLUMES	21	136	70	156	338	253	158	1,805	76	51	873	55	3,992
APPROACH %	9%	60%	31%	21%	45%	34%	8%	89%	4%	5%	89%	6%	
PEAK HR FACTOR	0.757			0.837			0.946			0.744			0.856
APP/DEPART	227	/	346	747	/	463	2,039	/	2,033	979	/	1,150	0

0	0	0	0	0
0	0	1	1	2
0	0	0	3	3
0	0	1	0	1
0	0	0	0	0
0	0	1	0	1
0	0	0	0	0
0	0	0	0	0
0	0	0	0	0
0	0	3	4	7

4:00 PM	17	121	16	25	44	36	46	240	14	10	454	35	1,058
4:15 PM	22	134	7	18	39	31	45	217	10	15	476	38	1,052
4:30 PM	23	124	15	15	51	49	45	249	11	15	477	33	1,107
4:45 PM	22	144	17	15	39	39	56	244	10	8	451	38	1,083
5:00 PM	35	167	13	19	44	45	49	242	15	12	504	44	1,189
5:15 PM	33	190	17	17	52	41	49	221	21	16	464	45	1,166
5:30 PM	38	140	28	24	49	54	47	245	10	15	463	35	1,148
5:45 PM	21	112	13	21	52	49	55	247	14	16	480	46	1,126

VOLUMES	211	1,132	126	154	370	344	392	1,905	105	107	3,769	314	8,929
APPROACH %	14%	77%	9%	18%	43%	40%	16%	79%	4%	3%	90%	7%	
APP/DEPART	1,469	/	1,835	868	/	578	2,402	/	2,189	4,190	/	4,327	0
BEGIN PEAK HR	5:00 PM												
VOLUMES	127	609	71	81	197	189	200	955	60	59	1,911	170	4,629
APPROACH %	16%	75%	9%	17%	42%	40%	16%	79%	5%	3%	89%	8%	
PEAK HR FACTOR	0.841			0.919			0.961			0.955			0.973
APP/DEPART	807	/	978	467	/	316	1,215	/	1,107	2,140	/	2,228	0

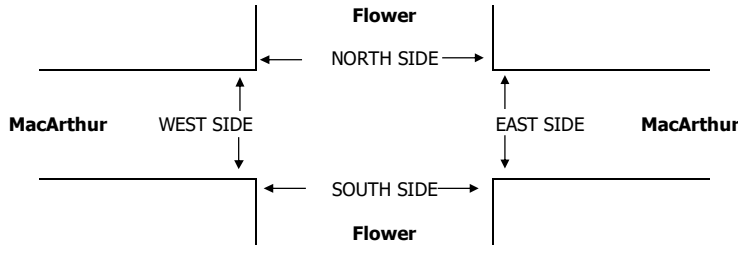

7:00 AM	1	3	5	4	13
7:15 AM	2	6	3	14	25
7:30 AM	4	6	8	3	21
7:45 AM	2	12	5	6	25
8:00 AM	1	8	3	1	13
8:15 AM	0	20	3	7	30
8:30 AM	1	11	7	3	22
8:45 AM	1	2	3	1	7
TOTAL	12	68	37	39	156

PEDESTRIAN + BIKE CROSSINGS					
N SIDE	S SIDE	E SIDE	W SIDE	TOTAL	
1	3	5	4	13	
2	6	3	14	25	
4	6	8	3	21	
2	12	5	6	25	
1	8	3	1	13	
0	20	3	7	30	
1	11	7	3	22	
1	2	3	1	7	
TOTAL	12	68	37	39	156

PEDESTRIAN CROSSINGS					
N SIDE	S SIDE	E SIDE	W SIDE	TOTAL	
1	3	4	3	11	
2	6	3	14	25	
3	6	8	3	20	
2	12	5	6	25	
1	8	3	1	13	
0	20	2	5	27	
0	10	5	2	17	
1	2	2	1	6	
TOTAL	10	67	32	35	144

BICYCLE CROSSINGS					
NS	SS	ES	WS	TOTAL	
0	0	1	1	2	
0	0	0	0	0	
1	0	0	0	1	
0	0	0	0	0	
0	0	0	0	0	
0	0	1	2	3	
1	1	2	1	5	
0	0	1	0	1	
TOTAL	2	1	5	4	12

Main St & La Veta Ave

Peak Hour Turning Movement Count

ID: Historical
City: Orange

Day: Tuesday
Date: 08/28/2018

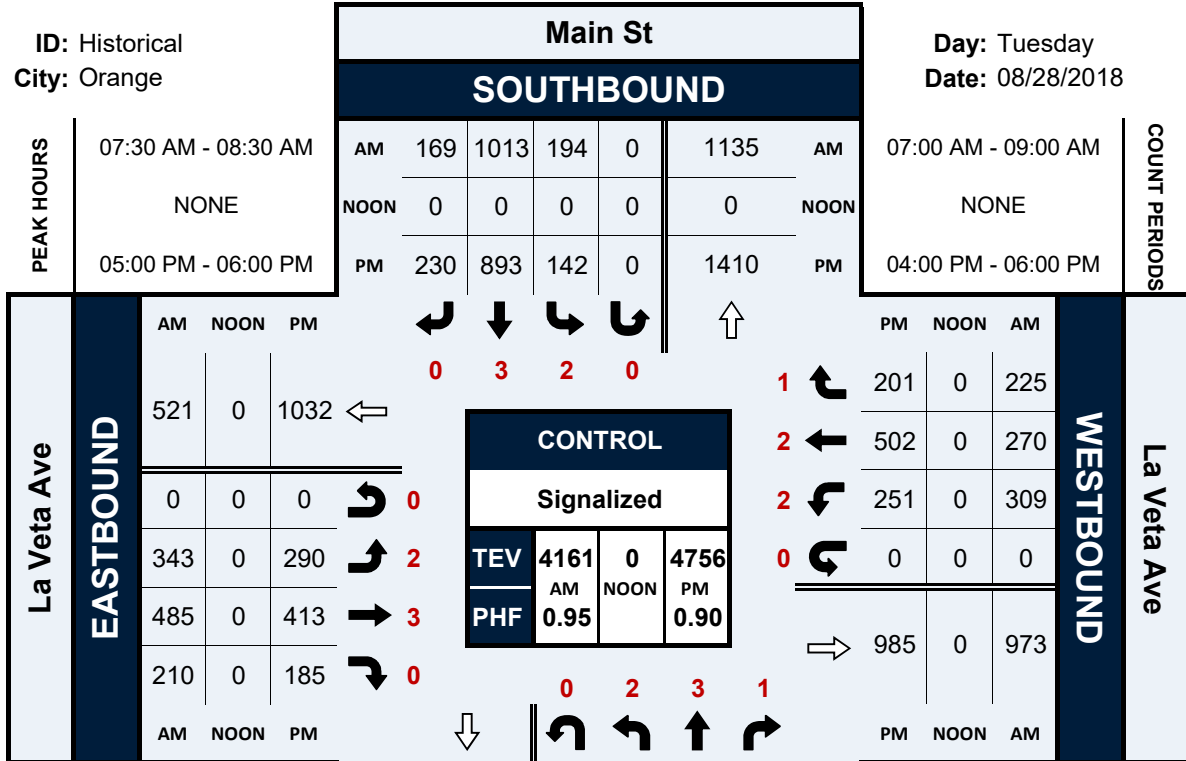

Total Vehicles (AM)

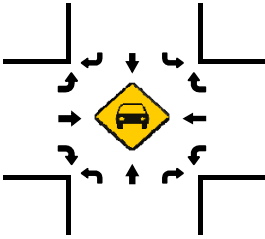

Total Vehicles (NOON)

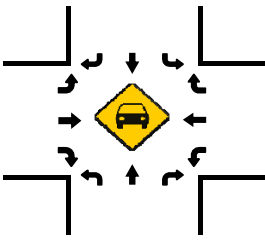

Total Vehicles (PM)

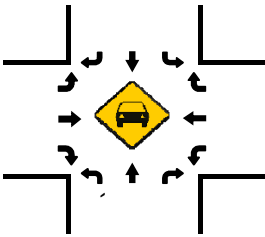

Total Vehicles (AM)

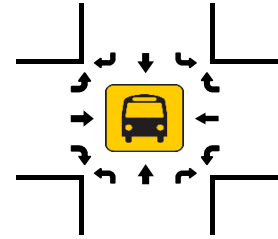

Total Vehicles (NOON)

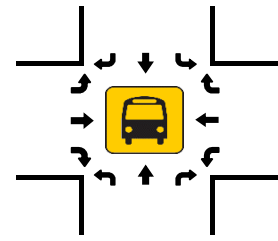

Total Vehicles (PM)

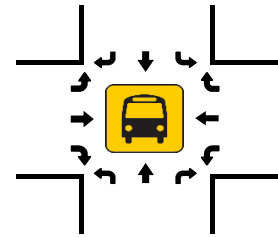

INTERSECTION TURNING MOVEMENT COUNTS

PREPARED BY: AimTD LLC. tel: 714 253 7888 cs@aimtd.com

DATE: Tue, May 14, 19

LOCATION: Santa Ana
NORTH & SOUTH: Main
EAST & WEST: Mainplace

PROJECT #: SC2183
LOCATION #: 16
CONTROL: SIGNAL

NOTES:

	AM PM MD OTHER OTHER	◀ W	▲ N ▼ S	E ▶
--	----------------------------------	-----	------------	-----

Add U-Turns to Left Turns

LANES:	NORTHBOUND Main			SOUTHBOUND Main			EASTBOUND Mainplace			WESTBOUND Mainplace			TOTAL	U-TURNS				
	NL	NT	NR	SL	ST	SR	EL	ET	ER	WL	WT	WR		NB	SB	EB	WB	TTL
		2	3	0	2	3	0	2	2.5	0.5	2	2		1	0	0	0	0

AM

7:00 AM	3	121	34	5	255	43	16	23	5	27	46	1	579
7:15 AM	8	140	43	4	355	62	31	31	7	31	37	6	755
7:30 AM	0	165	72	9	328	66	39	67	3	62	58	2	871
7:45 AM	8	237	70	10	306	60	35	65	5	50	73	3	922
8:00 AM	6	177	52	8	307	53	38	63	4	51	47	4	810
8:15 AM	13	177	53	4	290	78	34	35	3	33	45	5	770
8:30 AM	6	165	38	6	219	61	36	37	12	35	36	5	656
8:45 AM	12	160	46	9	233	46	20	19	10	29	36	4	624
VOLUMES	56	1,342	408	55	2,293	469	249	340	49	318	378	30	5,987
APPROACH %	3%	74%	23%	2%	81%	17%	39%	53%	8%	44%	52%	4%	
APP/DEPART	1,806	/	1,632	2,817	/	2,662	638	/	795	726	/	898	0
BEGIN PEAK HR	7:30 AM												
VOLUMES	27	756	247	31	1,231	257	146	230	15	196	223	14	3,373
APPROACH %	3%	73%	24%	2%	81%	17%	37%	59%	4%	45%	52%	3%	
PEAK HR FACTOR	0.817			0.942									
APP/DEPART	1,030	/	921	1,519	/	1,443	391	/	505	433	/	504	0

1	2	0	0	3
0	0	0	0	0
0	2	0	0	2
1	1	0	1	3
1	1	0	1	3
1	1	0	0	2
0	0	0	0	0
1	4	0	1	6
5	11	0	3	19

PM

4:00 PM	9	201	37	15	241	40	46	54	28	27	39	14	751
4:15 PM	17	194	35	16	277	41	53	65	21	48	29	8	804
4:30 PM	21	218	26	9	267	36	60	61	33	36	41	8	816
4:45 PM	23	213	37	12	257	27	66	80	13	46	42	16	832
5:00 PM	22	247	57	19	243	43	69	79	25	51	34	24	913
5:15 PM	25	246	43	8	282	33	83	92	26	50	42	18	948
5:30 PM	19	229	40	11	262	34	72	70	22	36	31	14	840
5:45 PM	28	208	39	12	187	30	61	62	15	28	29	12	711
VOLUMES	164	1,756	314	102	2,016	284	510	563	183	322	287	114	6,615
APPROACH %	7%	79%	14%	4%	84%	12%	41%	45%	15%	45%	40%	16%	
APP/DEPART	2,234	/	2,417	2,402	/	2,521	1,256	/	949	723	/	728	0
BEGIN PEAK HR	4:45 PM												
VOLUMES	89	935	177	50	1,044	137	290	321	86	183	149	72	3,533
APPROACH %	7%	78%	15%	4%	85%	11%	42%	46%	12%	45%	37%	18%	
PEAK HR FACTOR	0.921			0.953									
APP/DEPART	1,201	/	1,317	1,231	/	1,316	697	/	529	404	/	371	0

0	6	0	0	6
1	2	0	2	5
2	3	0	1	6
1	5	0	0	6
2	6	0	0	8
1	5	0	0	6
0	4	0	1	5
0	6	0	3	9
7	37	0	7	51

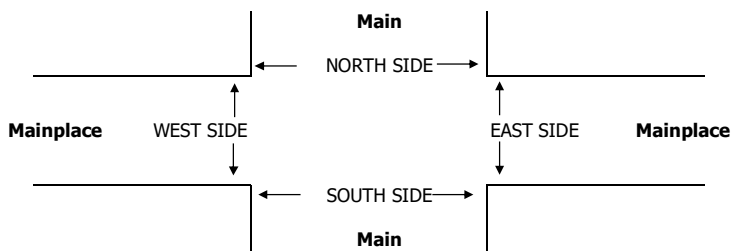

AM	7:00 AM	
	7:15 AM	
	7:30 AM	
	7:45 AM	
	8:00 AM	
	8:15 AM	
	8:30 AM	
	8:45 AM	
	TOTAL	
	AM BEGIN PEAK HR	
PM	4:00 PM	
	4:15 PM	
	4:30 PM	
	4:45 PM	
	5:00 PM	
	5:15 PM	
	5:30 PM	
	5:45 PM	
	TOTAL	
	PM BEGIN PEAK HR	

PEDESTRIAN + BIKE CROSSINGS					
	N SIDE	S SIDE	E SIDE	W SIDE	TOTAL
7:00 AM	0	0	0	0	0
7:15 AM	0	0	0	0	0
7:30 AM	0	0	0	0	0
7:45 AM	0	0	0	0	0
8:00 AM	0	0	0	0	0
8:15 AM	0	0	0	0	0
8:30 AM	0	0	0	0	0
8:45 AM	0	0	0	0	0
TOTAL	0	0	0	0	0
AM BEGIN PEAK HR	7:30 AM				
4:00 PM	0	0	0	0	0
4:15 PM	0	0	0	0	0
4:30 PM	0	0	0	0	0
4:45 PM	0	0	0	0	0
5:00 PM	0	0	0	0	0
5:15 PM	0	0	0	0	0
5:30 PM	0	0	0	0	0
5:45 PM	0	0	0	0	0
TOTAL	0	0	0	0	0
PM BEGIN PEAK HR	4:45 PM				

PEDESTRIAN CROSSINGS					
	N SIDE	S SIDE	E SIDE	W SIDE	TOTAL
7:00 AM	0	0	0	0	0
7:15 AM	0	0	0	0	0
7:30 AM	0	0	0	0	0
7:45 AM	0	0	0	0	0
8:00 AM	0	0	0	0	0
8:15 AM	0	0	0	0	0
8:30 AM	0	0	0	0	0
8:45 AM	0	0	0	0	0
TOTAL	0	0	0	0	0
AM BEGIN PEAK HR	7:30 AM				
4:00 PM	0	0	0	0	0
4:15 PM	0	0	0	0	0
4:30 PM	0	0	0	0	0
4:45 PM	0	0	0	0	0
5:00 PM	0	0	0	0	0
5:15 PM	0	0	0	0	0
5:30 PM	0	0	0	0	0
5:45 PM	0	0	0	0	0
TOTAL	0	0	0	0	0
PM BEGIN PEAK HR	4:45 PM				

BICYCLE CROSSINGS					
	NS	SS	ES	WS	TOTAL
7:00 AM	0	0	0	0	0
7:15 AM	0	0	0	0	0
7:30 AM	0	0	0	0	0
7:45 AM	0	0	0	0	0
8:00 AM	0	0	0	0	0
8:15 AM	0	0	0	0	0
8:30 AM	0	0	0	0	0
8:45 AM	0	0	0	0	0
TOTAL	0	0	0	0	0
AM BEGIN PEAK HR	7:30 AM				
4:00 PM	0	0	0	0	0
4:15 PM	0	0	0	0	0
4:30 PM	0	0	0	0	0
4:45 PM	0	0	0	0	0
5:00 PM	0	0	0	0	0
5:15 PM	0	0	0	0	0
5:30 PM	0	0	0	0	0
5:45 PM	0	0	0	0	0
TOTAL	0	0	0	0	0
PM BEGIN PEAK HR	4:45 PM				

INTERSECTION TURNING MOVEMENT COUNTS

PREPARED BY: AimTD LLC. tel: 714 253 7888 cs@aimtd.com

T218

DATE:
Tue, May 14, 19

LOCATION: Santa Ana
NORTH & SOUTH: Main
EAST & WEST: 17th

PROJECT #: SC2183
LOCATION #: 17
CONTROL: SIGNAL

NOTES:

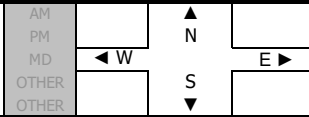

Add U-Turns to Left Turns

	NORTHBOUND			SOUTHBOUND			EASTBOUND			WESTBOUND			TOTAL
	Main			Main			17th			17th			
LANES:	NL	NT	NR	SL	ST	SR	EL	ET	ER	WL	WT	WR	
7:00 AM	19	107	16	23	233	12	27	300	16	64	222	6	1,045
7:15 AM	27	164	20	37	287	13	26	301	22	64	294	5	1,260
7:30 AM	33	190	37	48	288	14	20	302	14	88	337	4	1,375
7:45 AM	36	218	62	61	268	23	29	304	14	100	347	4	1,466
8:00 AM	30	180	42	47	232	19	39	305	10	69	309	5	1,287
8:15 AM	29	130	15	43	220	13	30	287	23	48	255	15	1,108
8:30 AM	16	125	35	34	201	17	26	265	24	39	220	11	1,013
8:45 AM	22	138	14	30	195	15	29	218	17	32	192	18	920
VOLUMES	212	1,252	241	323	1,924	126	226	2,282	140	504	2,176	68	9,474
APPROACH %	12%	73%	14%	14%	81%	5%	9%	86%	5%	18%	79%	2%	
APP/DEPART	1,705	/	1,539	2,373	/	2,551	2,648	/	2,863	2,748	/	2,521	0
BEGIN PEAK HR	7:15 AM												
VOLUMES	126	752	161	193	1,075	69	114	1,212	60	321	1,287	18	5,388
APPROACH %	12%	72%	15%	14%	80%	5%	8%	87%	4%	20%	79%	1%	
PEAK HR FACTOR	0.822			0.950			0.979			0.901			0.919
APP/DEPART	1,039	/	882	1,337	/	1,449	1,386	/	1,573	1,626	/	1,484	0
4:00 PM	39	236	54	33	164	28	43	273	20	47	263	17	1,217
4:15 PM	56	253	49	40	188	30	48	300	26	37	259	20	1,306
4:30 PM	47	243	49	44	196	26	47	283	15	50	279	24	1,303
4:45 PM	45	255	63	42	193	22	56	313	18	55	291	16	1,369
5:00 PM	47	257	58	45	172	37	67	328	13	34	249	11	1,318
5:15 PM	52	254	36	46	175	41	49	325	22	32	228	16	1,276
5:30 PM	46	242	41	51	176	31	46	291	18	37	299	13	1,291
5:45 PM	38	263	40	50	158	19	59	276	22	41	280	7	1,253
VOLUMES	370	2,003	390	351	1,422	234	415	2,389	154	333	2,148	124	10,333
APPROACH %	13%	72%	14%	17%	71%	12%	14%	81%	5%	13%	82%	5%	
APP/DEPART	2,763	/	2,522	2,007	/	1,898	2,958	/	3,139	2,605	/	2,774	0
BEGIN PEAK HR	4:15 PM												
VOLUMES	195	1,008	219	171	749	115	218	1,224	72	176	1,078	71	5,296
APPROACH %	14%	71%	15%	17%	72%	11%	14%	81%	5%	13%	81%	5%	
PEAK HR FACTOR	0.979			0.973			0.928			0.915			0.967
APP/DEPART	1,422	/	1,285	1,035	/	992	1,514	/	1,618	1,325	/	1,401	0

U-TURNS				
NB	SB	EB	WB	TTL
0	0	1	3	4
0	0	0	1	1
0	0	0	2	2
0	0	1	1	2
0	0	1	3	4
0	0	2	2	4
0	0	1	3	4
0	0	1	2	3
0	0	7	17	24

0	1	2	3	6
0	0	2	1	3
0	1	2	2	5
0	0	1	2	3
0	0	8	0	8
0	0	2	1	3
0	0	2	0	2
0	0	3	2	5
0	2	22	11	35

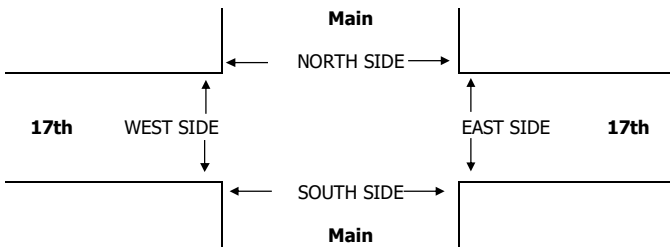

	PEDESTRIAN + BIKE CROSSINGS				
	N SIDE	S SIDE	E SIDE	W SIDE	TOTAL
7:00 AM	0	0	0	0	0
7:15 AM	0	0	0	0	0
7:30 AM	0	0	0	0	0
7:45 AM	0	0	0	0	0
8:00 AM	0	0	0	0	0
8:15 AM	0	0	0	0	0
8:30 AM	0	0	0	0	0
8:45 AM	0	0	0	0	0
TOTAL	0	0	0	0	0
AM BEGIN PEAK HR	7:15 AM				
4:00 PM	0	0	0	0	0
4:15 PM	0	0	0	0	0
4:30 PM	0	0	0	0	0
4:45 PM	0	0	0	0	0
5:00 PM	0	0	0	0	0
5:15 PM	0	0	0	0	0
5:30 PM	0	0	0	0	0
5:45 PM	0	0	0	0	0
TOTAL	0	0	0	0	0
PM BEGIN PEAK HR	4:15 PM				

	PEDESTRIAN CROSSINGS				
	N SIDE	S SIDE	E SIDE	W SIDE	TOTAL
7:00 AM	0	0	0	0	0
7:15 AM	0	0	0	0	0
7:30 AM	0	0	0	0	0
7:45 AM	0	0	0	0	0
8:00 AM	0	0	0	0	0
8:15 AM	0	0	0	0	0
8:30 AM	0	0	0	0	0
8:45 AM	0	0	0	0	0
TOTAL	0	0	0	0	0
AM BEGIN PEAK HR	7:15 AM				
4:00 PM	0	0	0	0	0
4:15 PM	0	0	0	0	0
4:30 PM	0	0	0	0	0
4:45 PM	0	0	0	0	0
5:00 PM	0	0	0	0	0
5:15 PM	0	0	0	0	0
5:30 PM	0	0	0	0	0
5:45 PM	0	0	0	0	0
TOTAL	0	0	0	0	0
PM BEGIN PEAK HR	4:15 PM				

	BICYCLE CROSSINGS				
	NS	SS	ES	WS	TOTAL
7:00 AM	0	0	0	0	0
7:15 AM	0	0	0	0	0
7:30 AM	0	0	0	0	0
7:45 AM	0	0	0	0	0
8:00 AM	0	0	0	0	0
8:15 AM	0	0	0	0	0
8:30 AM	0	0	0	0	0
8:45 AM	0	0	0	0	0
TOTAL	0	0	0	0	0
AM BEGIN PEAK HR	7:15 AM				
4:00 PM	0	0	0	0	0
4:15 PM	0	0	0	0	0
4:30 PM	0	0	0	0	0
4:45 PM	0	0	0	0	0
5:00 PM	0	0	0	0	0
5:15 PM	0	0	0	0	0
5:30 PM	0	0	0	0	0
5:45 PM	0	0	0	0	0
TOTAL	0	0	0	0	0
PM BEGIN PEAK HR	4:15 PM				

INTERSECTION TURNING MOVEMENT COUNTS

PREPARED BY: AimTD LLC. tel: 714 253 7888 pacific@aimtd.com

DATE: Thu, Feb 11, 16	LOCATION: NORTH & SOUTH: Santa Ana EAST & WEST: Main Civic Center	PROJECT #: SC0846 LOCATION #: 14 CONTROL: SIGNAL
---------------------------------	--	---

NOTES:	AM PM MD OTHER OTHER	▲ N ▼ S	◀ W E ▶
---------------	----------------------------------	------------------	------------

Add U-Turns to Left Turns

LANES:	NORTHBOUND			SOUTHBOUND			EASTBOUND			WESTBOUND			TOTAL
	NL	NT	NR	SL	ST	SR	EL	ET	ER	WL	WT	WR	
	1	2	0	1	2	0	1	2	0	1	2	0	

U-TURNS				
NB	SB	EB	WB	TTL
0	0	0	0	0

AM	7:00 AM	19	158	9	12	248	29	8	80	16	6	65	3	653
	7:15 AM	35	205	12	13	242	21	19	106	27	8	125	12	825
	7:30 AM	35	219	13	15	251	47	20	112	16	9	137	5	879
	7:45 AM	30	234	25	16	257	47	20	159	25	14	166	10	1,003
	8:00 AM	32	207	25	12	251	37	27	146	27	10	115	5	894
	8:15 AM	32	188	17	17	254	42	19	64	24	6	80	14	757
	8:30 AM	31	189	10	13	251	22	15	63	39	9	68	5	715
	8:45 AM	20	175	8	8	203	22	17	53	32	3	49	5	595
	VOLUMES	234	1,575	119	106	1,957	267	145	783	206	65	805	59	6,321
	APPROACH %	12%	82%	6%	5%	84%	11%	13%	69%	18%	7%	87%	6%	
APP/DEPART	1,928	/	1,779	2,330	/	2,228	1,134	/	1,008	929	/	1,306	0	
BEGIN PEAK HR	7:15 AM													
VOLUMES	132	865	75	56	1,001	152	86	523	95	41	543	32	3,601	
APPROACH %	12%	81%	7%	5%	83%	13%	12%	74%	13%	7%	88%	5%		
PEAK HR FACTOR	0.927													
APP/DEPART	1,072	/	983	1,209	/	1,137	704	/	654	616	/	827	0	
PM	4:00 PM	17	275	24	10	199	10	30	126	29	14	59	5	798
	4:15 PM	17	238	13	9	201	19	34	118	22	7	57	12	747
	4:30 PM	27	291	12	6	227	10	39	187	24	6	77	14	920
	4:45 PM	17	278	25	18	240	21	51	228	22	6	87	9	1,002
	5:00 PM	18	245	24	23	248	18	42	241	36	16	119	4	1,034
	5:15 PM	23	268	29	11	241	11	20	190	18	8	86	10	915
	5:30 PM	24	258	16	8	210	21	14	120	30	17	76	17	811
	5:45 PM	23	271	16	13	226	15	11	97	15	9	76	9	781
	VOLUMES	166	2,124	159	98	1,792	125	241	1,307	196	83	637	80	7,008
	APPROACH %	7%	87%	6%	5%	89%	6%	14%	75%	11%	10%	80%	10%	
APP/DEPART	2,449	/	2,445	2,015	/	2,072	1,744	/	1,564	800	/	927	0	
BEGIN PEAK HR	4:30 PM													
VOLUMES	85	1,082	90	58	956	60	152	846	100	36	369	37	3,871	
APPROACH %	7%	86%	7%	5%	89%	6%	14%	77%	9%	8%	83%	8%		
PEAK HR FACTOR	0.952													
APP/DEPART	1,257	/	1,271	1,074	/	1,093	1,098	/	994	442	/	513	0	

0	0	0	0	0
0	0	0	0	0
1	0	0	0	1
0	0	0	0	0
0	0	0	0	0
0	0	0	0	0
0	0	0	0	0
0	0	0	0	0
1	0	0	0	1

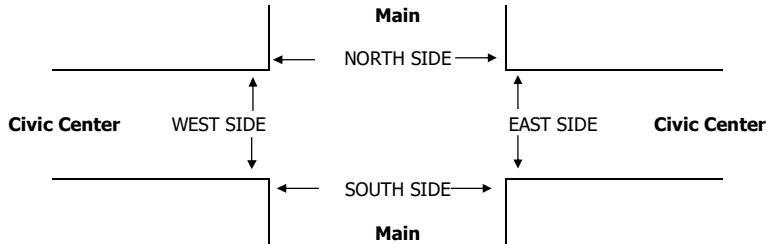

AM	7:00 AM	9	1	2	3	15
	7:15 AM	1	1	15	3	20
	7:30 AM	1	7	6	2	16
	7:45 AM	0	6	6	6	18
	8:00 AM	8	5	8	1	22
	8:15 AM	18	1	8	8	35
	8:30 AM	13	6	7	7	33
	8:45 AM	12	0	10	5	27
	TOTAL	62	27	62	35	186
	PM	4:00 PM	6	6	8	7
4:15 PM		7	4	7	19	37
4:30 PM		10	7	15	6	38
4:45 PM		6	4	11	3	24
5:00 PM		48	9	16	1	74
5:15 PM		5	5	7	1	18
5:30 PM		8	3	6	2	19
5:45 PM		6	3	15	1	25
TOTAL	96	41	85	40	262	

PEDESTRIAN + BIKE CROSSINGS				
N SIDE	S SIDE	E SIDE	W SIDE	TOTAL
9	1	2	3	15
1	1	15	3	20
1	7	6	2	16
0	6	6	6	18
8	5	8	1	22
18	1	8	8	35
13	6	7	7	33
12	0	10	5	27
62	27	62	35	186
6	6	8	7	27
7	4	7	19	37
10	7	15	6	38
6	4	11	3	24
48	9	16	1	74
5	5	7	1	18
8	3	6	2	19
6	3	15	1	25
96	41	85	40	262

PEDESTRIAN CROSSINGS				
N SIDE	S SIDE	E SIDE	W SIDE	TOTAL
9	0	2	3	14
1	1	14	3	19
0	6	4	2	12
0	4	6	4	14
8	2	8	1	19
17	1	6	7	31
13	6	5	7	31
12	0	7	4	23
60	20	52	31	163
6	5	5	7	23
7	4	6	15	32
10	6	14	5	35
6	3	9	3	21
48	5	14	1	68
4	2	7	1	14
8	3	6	2	19
6	0	11	1	18
95	28	72	35	230

BICYCLE CROSSINGS				
NS	SS	ES	WS	TOTAL
0	1	0	0	1
0	0	1	0	1
1	1	2	0	4
0	2	0	2	4
0	3	0	0	3
1	0	2	1	4
0	0	2	0	2
0	0	3	1	4
2	7	10	4	23
0	1	3	0	4
0	0	1	4	5
0	1	1	1	3
0	1	2	0	3
0	4	2	0	6
1	3	0	0	4
0	0	0	0	0
0	3	4	0	7
1	13	13	5	32

INTERSECTION TURNING MOVEMENT COUNTS

PREPARED BY: AimTD LLC. tel: 714 253 7888 pacific@aimtd.com

DATE: Thu, Feb 11, 16	LOCATION: NORTH & SOUTH: EAST & WEST:	Santa Ana Main Santa Ana	PROJECT #: SC0846 LOCATION #: 26 CONTROL: SIGNAL
---------------------------------	---	--------------------------------	--

NOTES:	AM PM MD OTHER OTHER	▲ N ◀ W S ▼	E ▶
--------	----------------------------------	-------------------------	-----

Add U-Turns to Left Turns

	NORTHBOUND			SOUTHBOUND			EASTBOUND			WESTBOUND			TOTAL
	Main	Main	Main	Main	Main	Main	Santa Ana	Santa Ana	Santa Ana	Santa Ana	Santa Ana		
LANES:	NL	NT	NR	SL	ST	SR	EL	ET	ER	WL	WT	WR	
	1	2	X	X	2	0	X	X	X	0.5	2	0.5	
AM													
7:00 AM	10	149	0	0	240	25	0	0	0	14	152	6	596
7:15 AM	16	220	0	0	273	22	0	0	0	19	153	14	717
7:30 AM	16	241	0	0	270	26	0	0	0	15	233	15	816
7:45 AM	15	334	0	0	258	17	0	0	0	8	203	15	850
8:00 AM	18	245	0	0	262	29	0	0	0	16	225	18	813
8:15 AM	11	207	0	0	235	42	0	0	0	17	148	15	675
8:30 AM	15	217	0	0	288	28	0	0	0	15	144	9	716
8:45 AM	15	167	0	0	203	26	0	0	0	13	116	14	554
VOLUMES	116	1,780	0	0	2,029	215	0	0	0	117	1,374	106	5,737
APPROACH %	6%	94%	0%	0%	90%	10%	0%	0%	0%	7%	86%	7%	
APP/DEPART	1,896	/	1,886	2,244	/	2,146	0	/	0	1,597	/	1,705	0
BEGIN PEAK HR	7:15 AM												
VOLUMES	65	1,040	0	0	1,063	94	0	0	0	58	814	62	3,196
APPROACH %	6%	94%	0%	0%	92%	8%	0%	0%	0%	6%	87%	7%	
PEAK HR FACTOR	0.792												
APP/DEPART	1,105	/	1,102	1,157	/	1,121	0	/	0	934	/	973	0
PM													
4:00 PM	12	261	0	0	219	9	0	0	0	17	146	18	682
4:15 PM	10	251	0	0	218	12	0	0	0	2	113	13	619
4:30 PM	12	302	0	0	217	7	0	0	0	15	122	17	692
4:45 PM	10	330	0	0	247	12	0	0	0	15	157	19	790
5:00 PM	16	250	0	0	300	15	0	0	0	18	127	25	751
5:15 PM	14	319	0	0	263	12	0	0	0	15	177	20	820
5:30 PM	11	282	0	0	230	11	0	0	0	14	169	17	734
5:45 PM	6	254	0	0	252	10	0	0	0	15	147	20	704
VOLUMES	91	2,249	0	0	1,946	88	0	0	0	111	1,158	149	5,792
APPROACH %	4%	96%	0%	0%	96%	4%	0%	0%	0%	8%	82%	11%	
APP/DEPART	2,340	/	2,398	2,034	/	2,057	0	/	0	1,418	/	1,337	0
BEGIN PEAK HR	4:45 PM												
VOLUMES	51	1,181	0	0	1,040	50	0	0	0	62	630	81	3,095
APPROACH %	4%	96%	0%	0%	95%	5%	0%	0%	0%	8%	82%	10%	
PEAK HR FACTOR	0.906												
APP/DEPART	1,232	/	1,262	1,090	/	1,102	0	/	0	773	/	731	0

U-TURNS				
NB	SB	EB	WB	TTL
0	0	0	0	0
0	0	0	0	0
0	0	0	0	0
0	0	0	0	0
0	0	0	0	0
0	0	0	0	0
0	0	0	0	0
0	0	0	0	0
0	0	0	0	0
0	0	0	0	0
0	0	0	0	0
0	0	0	0	0
0	0	0	0	0
0	0	0	0	0
0	0	0	0	0
0	0	0	0	0
0	0	0	0	0

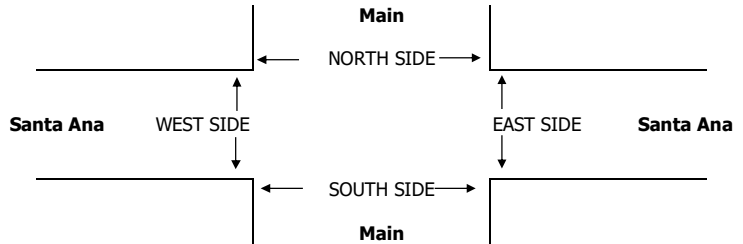

	N SIDE	S SIDE	E SIDE	W SIDE	TOTAL
AM					
7:00 AM	7	7	2	4	20
7:15 AM	11	13	17	7	48
7:30 AM	7	20	22	6	55
7:45 AM	6	5	6	6	23
8:00 AM	8	5	8	4	25
8:15 AM	4	3	5	6	18
8:30 AM	4	2	7	8	21
8:45 AM	1	0	6	2	9
TOTAL	48	55	73	43	219
PM					
4:00 PM	7	5	6	8	26
4:15 PM	4	4	7	14	29
4:30 PM	11	8	10	15	44
4:45 PM	12	2	11	9	34
5:00 PM	9	8	6	21	44
5:15 PM	8	18	6	21	53
5:30 PM	12	2	10	9	33
5:45 PM	3	3	10	11	27
TOTAL	66	50	66	108	290

PEDESTRIAN + BIKE CROSSINGS				
N SIDE	S SIDE	E SIDE	W SIDE	TOTAL
4	5	2	4	15
11	11	14	7	43
6	18	21	6	51
6	5	6	5	22
6	4	7	3	20
3	2	5	4	14
2	2	6	7	17
1	0	3	2	6
39	47	64	38	188
5	4	5	6	20
4	4	7	14	29
8	7	9	13	37
11	2	10	6	29
8	6	5	20	39
8	18	6	21	53
10	1	9	7	27
3	2	8	9	22
57	44	59	96	256

PEDESTRIAN CROSSINGS				
N SIDE	S SIDE	E SIDE	W SIDE	TOTAL
3	2	0	0	5
0	2	3	0	5
1	2	1	0	4
0	0	0	1	1
2	1	1	1	5
1	1	0	2	4
2	0	1	1	4
0	0	3	0	3
9	8	9	5	31
2	1	1	2	6
0	0	0	0	0
3	1	1	2	7
1	0	1	3	5
1	2	1	1	5
0	0	0	0	0
2	1	1	2	6
0	1	2	2	5
9	6	7	12	34

BICYCLE CROSSINGS				
NS	SS	ES	WS	TOTAL
3	2	0	0	5
0	2	3	0	5
1	2	1	0	4
0	0	0	1	1
2	1	1	1	5
1	1	0	2	4
2	0	1	1	4
0	0	3	0	3
9	8	9	5	31
2	1	1	2	6
0	0	0	0	0
3	1	1	2	7
1	0	1	3	5
1	2	1	1	5
0	0	0	0	0
2	1	1	2	6
0	1	2	2	5
9	6	7	12	34

INTERSECTION TURNING MOVEMENT COUNTS

PREPARED BY: AimTD LLC. tel: 714 253 7888 cs@aimtd.com

DATE:
Tue, May 14, 19

LOCATION: Santa Ana
NORTH & SOUTH: Main
EAST & WEST: 1st

PROJECT #: SC2183
LOCATION #: 18
CONTROL: SIGNAL

NOTES:

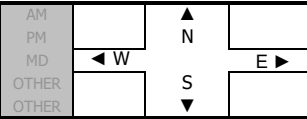

Add U-Turns to Left Turns

LANES:	NORTHBOUND			SOUTHBOUND			EASTBOUND			WESTBOUND			TOTAL
	Main	Main	Main	Main	1st	1st	1st	1st	1st	1st	1st		
	NL	NT	NR	SL	ST	SR	EL	ET	ER	WL	WT	WR	
	1	2	0	1	2	1	1	3	0	1	3	0	

U-TURNS				
NB	SB	EB	WB	TTL
0	0	0	0	0
0	0	0	2	2
0	0	0	0	0
0	0	0	0	0
0	0	0	0	0
0	0	0	0	0
0	0	0	0	0
0	0	0	0	0
0	0	0	2	2

	NORTHBOUND			SOUTHBOUND			EASTBOUND			WESTBOUND			TOTAL
	Main	Main	Main	Main	1st	1st	1st	1st	1st	1st	1st		
AM													
7:00 AM	21	110	8	17	205	15	24	398	30	14	167	9	1,018
7:15 AM	23	143	14	23	226	13	26	298	29	25	251	9	1,080
7:30 AM	37	166	8	23	213	23	28	362	44	21	285	13	1,223
7:45 AM	27	168	13	23	232	17	30	362	42	21	311	22	1,268
8:00 AM	27	113	24	18	202	11	33	357	30	20	239	16	1,090
8:15 AM	35	119	15	24	198	12	21	326	40	15	240	19	1,064
8:30 AM	34	132	20	18	225	12	31	318	36	26	214	14	1,080
8:45 AM	14	128	16	22	193	16	35	276	45	23	197	19	984
VOLUMES	218	1,079	118	168	1,694	119	228	2,697	296	165	1,904	121	8,807
APPROACH %	15%	76%	8%	8%	86%	6%	7%	84%	9%	8%	87%	6%	
APP/DEPART	1,415	/	1,428	1,981	/	2,153	3,221	/	2,985	2,190	/	2,241	0
BEGIN PEAK HR	7:15 AM												
VOLUMES	114	590	59	87	873	64	117	1,379	145	87	1,086	60	4,661
APPROACH %	15%	77%	8%	8%	85%	6%	7%	84%	9%	7%	88%	5%	
PEAK HR FACTOR	0.904			0.941			0.945			0.871			0.919
APP/DEPART	763	/	767	1,024	/	1,103	1,641	/	1,527	1,233	/	1,264	0
PM													
4:00 PM	34	204	15	34	135	30	34	233	26	32	287	17	1,081
4:15 PM	38	219	24	35	171	34	37	272	19	26	306	10	1,191
4:30 PM	33	214	20	35	160	32	35	285	25	26	294	19	1,178
4:45 PM	43	191	20	48	150	32	39	312	18	18	306	24	1,201
5:00 PM	40	206	15	40	173	30	21	272	26	31	316	20	1,190
5:15 PM	43	197	21	43	169	38	30	315	18	32	316	23	1,245
5:30 PM	41	223	15	42	172	41	28	302	27	31	324	21	1,267
5:45 PM	39	194	17	43	160	41	22	291	25	26	302	30	1,190
VOLUMES	311	1,648	147	320	1,290	278	246	2,282	184	222	2,451	164	9,543
APPROACH %	15%	78%	7%	17%	68%	15%	9%	84%	7%	8%	86%	6%	
APP/DEPART	2,106	/	2,056	1,888	/	1,692	2,712	/	2,753	2,837	/	3,042	0
BEGIN PEAK HR	4:45 PM												
VOLUMES	167	817	71	173	664	141	118	1,201	89	112	1,262	88	4,903
APPROACH %	16%	77%	7%	18%	68%	14%	8%	85%	6%	8%	86%	6%	
PEAK HR FACTOR	0.945			0.959			0.954			0.972			0.967
APP/DEPART	1,055	/	1,022	978	/	865	1,408	/	1,445	1,462	/	1,571	0

NB	SB	EB	WB	TTL
0	0	0	0	0
0	0	0	2	2
0	0	0	0	0
0	0	0	0	0
0	0	0	0	0
0	0	0	0	0
0	0	0	0	0
0	0	0	0	0
0	0	0	0	0
0	0	0	0	0
0	0	0	2	2
0	0	1	1	2
0	0	0	2	2
0	0	0	1	1
0	0	0	0	0
0	0	0	0	0
0	0	1	0	1
0	0	0	0	0
0	0	0	0	0
0	0	2	4	6

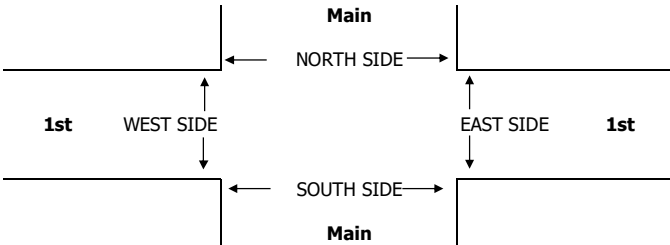

	PEDESTRIAN + BIKE CROSSINGS				
	N SIDE	S SIDE	E SIDE	W SIDE	TOTAL
AM					
7:00 AM	0	0	0	0	0
7:15 AM	0	0	0	0	0
7:30 AM	0	0	0	0	0
7:45 AM	0	0	0	0	0
8:00 AM	0	0	0	0	0
8:15 AM	0	0	0	0	0
8:30 AM	0	0	0	0	0
8:45 AM	0	0	0	0	0
TOTAL	0	0	0	0	0
AM BEGIN PEAK HR	7:15 AM				
4:00 PM	0	0	0	0	0
4:15 PM	0	0	0	0	0
4:30 PM	0	0	0	0	0
4:45 PM	0	0	0	0	0
5:00 PM	0	0	0	0	0
5:15 PM	0	0	0	0	0
5:30 PM	0	0	0	0	0
5:45 PM	0	0	0	0	0
TOTAL	0	0	0	0	0
PM BEGIN PEAK HR	4:45 PM				

	PEDESTRIAN CROSSINGS				
	N SIDE	S SIDE	E SIDE	W SIDE	TOTAL
AM					
7:00 AM	0	0	0	0	0
7:15 AM	0	0	0	0	0
7:30 AM	0	0	0	0	0
7:45 AM	0	0	0	0	0
8:00 AM	0	0	0	0	0
8:15 AM	0	0	0	0	0
8:30 AM	0	0	0	0	0
8:45 AM	0	0	0	0	0
TOTAL	0	0	0	0	0
AM BEGIN PEAK HR	7:15 AM				
4:00 PM	0	0	0	0	0
4:15 PM	0	0	0	0	0
4:30 PM	0	0	0	0	0
4:45 PM	0	0	0	0	0
5:00 PM	0	0	0	0	0
5:15 PM	0	0	0	0	0
5:30 PM	0	0	0	0	0
5:45 PM	0	0	0	0	0
TOTAL	0	0	0	0	0
PM BEGIN PEAK HR	4:45 PM				

	BICYCLE CROSSINGS				
	NS	SS	ES	WS	TOTAL
AM					
7:00 AM	0	0	0	0	0
7:15 AM	0	0	0	0	0
7:30 AM	0	0	0	0	0
7:45 AM	0	0	0	0	0
8:00 AM	0	0	0	0	0
8:15 AM	0	0	0	0	0
8:30 AM	0	0	0	0	0
8:45 AM	0	0	0	0	0
TOTAL	0	0	0	0	0
AM BEGIN PEAK HR	7:15 AM				
4:00 PM	0	0	0	0	0
4:15 PM	0	0	0	0	0
4:30 PM	0	0	0	0	0
4:45 PM	0	0	0	0	0
5:00 PM	0	0	0	0	0
5:15 PM	0	0	0	0	0
5:30 PM	0	0	0	0	0
5:45 PM	0	0	0	0	0
TOTAL	0	0	0	0	0
PM BEGIN PEAK HR	4:45 PM				

INTERSECTION TURNING MOVEMENT COUNTS

PREPARED BY: AimTD LLC. tel: 714 253 7888 cs@aimtd.com

DATE:
Thu, May 16, 19

LOCATION:
NORTH & SOUTH:
EAST & WEST:

Santa Ana
Main
Edinger

PROJECT #: SC2183
LOCATION #: 19
CONTROL: SIGNAL

NOTES:

AM		▲	N
PM			
MD	◀	W	E ▶
OTHER			
		▼	S

Add U-Turns to Left Turns

LANES:	NORTHBOUND			SOUTHBOUND			EASTBOUND			WESTBOUND			TOTAL
	NL	NT	NR	SL	ST	SR	EL	ET	ER	WL	WT	WR	

U-TURNS				
NB	SB	EB	WB	TTL

7:00 AM	18	115	19	34	247	18	14	241	38	20	149	15	928		
7:15 AM	21	158	17	47	248	14	15	243	35	28	184	26	1,036		
7:30 AM	27	171	18	61	265	17	9	246	38	31	159	21	1,063		
7:45 AM	28	128	13	59	244	12	23	250	28	38	165	24	1,012		
8:00 AM	31	153	18	58	284	11	27	222	28	23	193	15	1,063		
8:15 AM	23	126	19	47	265	9	19	212	21	17	194	22	974		
8:30 AM	21	102	21	34	233	13	32	220	37	24	141	16	894		
8:45 AM	10	104	21	22	272	18	18	183	25	27	100	20	820		
VOLUMES	179	1,057	146	362	2,058	112	157	1,817	250	208	1,285	159	7,790		
APPROACH %	13%	76%	11%	14%	81%	4%	7%	82%	11%	13%	78%	10%			
APP/DEPART	1,382	/	1,369	2,532	/	2,502	2,224	/	2,339	1,652	/	1,580	0		
BEGIN PEAK HR	7:15 AM			7:15 AM			7:15 AM			7:15 AM			7:15 AM		
VOLUMES	107	610	66	225	1,041	54	74	961	129	120	701	86	4,174		
APPROACH %	14%	78%	8%	17%	79%	4%	6%	83%	11%	13%	77%	9%			
PEAK HR FACTOR	0.906			0.935			0.967			0.953			0.982		
APP/DEPART	783	/	767	1,320	/	1,282	1,164	/	1,260	907	/	865	0		
4:00 PM	21	237	17	32	121	22	41	171	26	20	297	39	1,044		
4:15 PM	27	226	11	34	133	34	38	180	26	28	316	31	1,084		
4:30 PM	23	253	14	21	139	9	21	195	17	18	328	27	1,065		
4:45 PM	14	272	13	20	146	30	29	160	15	13	297	30	1,039		
5:00 PM	29	250	12	39	137	13	34	164	23	23	330	29	1,083		
5:15 PM	33	243	15	33	148	20	36	203	23	27	325	32	1,138		
5:30 PM	18	259	9	28	180	26	22	194	24	23	320	33	1,136		
5:45 PM	18	287	11	20	137	23	33	183	13	23	308	38	1,094		
VOLUMES	183	2,027	102	227	1,141	177	254	1,450	167	175	2,521	259	8,683		
APPROACH %	8%	88%	4%	15%	74%	11%	14%	77%	9%	6%	85%	9%			
APP/DEPART	2,312	/	2,535	1,545	/	1,473	1,871	/	1,789	2,955	/	2,886	0		
BEGIN PEAK HR	5:00 PM			5:00 PM			5:00 PM			5:00 PM			5:00 PM		
VOLUMES	98	1,039	47	120	602	82	125	744	83	96	1,283	132	4,451		
APPROACH %	8%	88%	4%	15%	75%	10%	13%	78%	9%	6%	85%	9%			
PEAK HR FACTOR	0.937			0.859			0.908			0.984			0.978		
APP/DEPART	1,184	/	1,293	804	/	774	952	/	918	1,511	/	1,466	0		

0	0	0	0	0
0	0	2	3	5
0	0	0	2	2
0	0	1	2	3
0	0	0	1	1
0	0	0	1	1
0	0	0	3	3
0	0	1	2	3
0	0	4	14	18

0	0	0	0	0
0	0	1	1	2
0	0	1	2	3
0	0	0	0	0
0	0	2	2	4
0	0	0	2	2
0	0	1	1	2
0	0	0	2	2
0	0	5	10	15

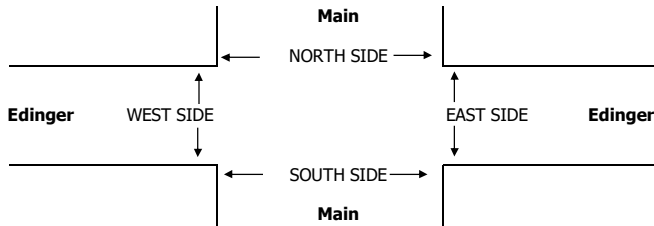

Time	NL	NT	NR	SL	ST	SR	EL	ET	ER	WL	WT	WR	TOTAL		
7:00 AM	18	115	19	34	247	18	14	241	38	20	149	15	928		
7:15 AM	21	158	17	47	248	14	15	243	35	28	184	26	1,036		
7:30 AM	27	171	18	61	265	17	9	246	38	31	159	21	1,063		
7:45 AM	28	128	13	59	244	12	23	250	28	38	165	24	1,012		
8:00 AM	31	153	18	58	284	11	27	222	28	23	193	15	1,063		
8:15 AM	23	126	19	47	265	9	19	212	21	17	194	22	974		
8:30 AM	21	102	21	34	233	13	32	220	37	24	141	16	894		
8:45 AM	10	104	21	22	272	18	18	183	25	27	100	20	820		
TOTAL	179	1,057	146	362	2,058	112	157	1,817	250	208	1,285	159	7,790		
AM BEGIN PEAK HR	7:15 AM			7:15 AM			7:15 AM			7:15 AM			7:15 AM		
4:00 PM	21	237	17	32	121	22	41	171	26	20	297	39	1,044		
4:15 PM	27	226	11	34	133	34	38	180	26	28	316	31	1,084		
4:30 PM	23	253	14	21	139	9	21	195	17	18	328	27	1,065		
4:45 PM	14	272	13	20	146	30	29	160	15	13	297	30	1,039		
5:00 PM	29	250	12	39	137	13	34	164	23	23	330	29	1,083		
5:15 PM	33	243	15	33	148	20	36	203	23	27	325	32	1,138		
5:30 PM	18	259	9	28	180	26	22	194	24	23	320	33	1,136		
5:45 PM	18	287	11	20	137	23	33	183	13	23	308	38	1,094		
TOTAL	183	2,027	102	227	1,141	177	254	1,450	167	175	2,521	259	8,683		
PM BEGIN PEAK HR	5:00 PM			5:00 PM			5:00 PM			5:00 PM			5:00 PM		

Time	PEDESTRIAN + BIKE CROSSINGS				TOTAL
	N SIDE	S SIDE	E SIDE	W SIDE	
7:00 AM	0	0	0	0	0
7:15 AM	0	0	0	0	0
7:30 AM	0	0	0	0	0
7:45 AM	0	0	0	0	0
8:00 AM	0	0	0	0	0
8:15 AM	0	0	0	0	0
8:30 AM	0	0	0	0	0
8:45 AM	0	0	0	0	0
TOTAL	0	0	0	0	0
AM BEGIN PEAK HR	7:15 AM				
4:00 PM	0	0	0	0	0
4:15 PM	0	0	0	0	0
4:30 PM	0	0	0	0	0
4:45 PM	0	0	0	0	0
5:00 PM	0	0	0	0	0
5:15 PM	0	0	0	0	0
5:30 PM	0	0	0	0	0
5:45 PM	0	0	0	0	0
TOTAL	0	0	0	0	0
PM BEGIN PEAK HR	5:00 PM				

Time	PEDESTRIAN CROSSINGS				TOTAL
	N SIDE	S SIDE	E SIDE	W SIDE	
7:00 AM	0	0	0	0	0
7:15 AM	0	0	0	0	0
7:30 AM	0	0	0	0	0
7:45 AM	0	0	0	0	0
8:00 AM	0	0	0	0	0
8:15 AM	0	0	0	0	0
8:30 AM	0	0	0	0	0
8:45 AM	0	0	0	0	0
TOTAL	0	0	0	0	0
AM BEGIN PEAK HR	7:15 AM				
4:00 PM	0	0	0	0	0
4:15 PM	0	0	0	0	0
4:30 PM	0	0	0	0	0
4:45 PM	0	0	0	0	0
5:00 PM	0	0	0	0	0
5:15 PM	0	0	0	0	0
5:30 PM	0	0	0	0	0
5:45 PM	0	0	0	0	0
TOTAL	0	0	0	0	0
PM BEGIN PEAK HR	5:00 PM				

Time	BICYCLE CROSSINGS				TOTAL
	NS	SS	ES	WS	
7:00 AM	0	0	0	0	0
7:15 AM	0	0	0	0	0
7:30 AM	0	0	0	0	0
7:45 AM	0	0	0	0	0
8:00 AM	0	0	0	0	0
8:15 AM	0	0	0	0	0
8:30 AM	0	0	0	0	0
8:45 AM	0	0	0	0	0
TOTAL	0	0	0	0	0
AM BEGIN PEAK HR	7:15 AM				
4:00 PM	0	0	0	0	0
4:15 PM	0	0	0	0	0
4:30 PM	0	0	0	0	0
4:45 PM	0	0	0	0	0
5:00 PM	0	0	0	0	0
5:15 PM	0	0	0	0	0
5:30 PM	0	0	0	0	0
5:45 PM	0	0	0	0	0
TOTAL	0	0	0	0	0
PM BEGIN PEAK HR	5:00 PM				

INTERSECTION TURNING MOVEMENT COUNTS

PREPARED BY: AimTD LLC. tel: 714 253 7888 cs@aimtd.com

DATE:
Tue, May 14, 19

LOCATION: Santa Ana
NORTH & SOUTH: Main
EAST & WEST: MacArthur

PROJECT #: SC2183
LOCATION #: 20
CONTROL: SIGNAL

NOTES:

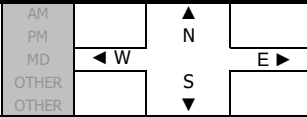

Add U-Turns to Left Turns

	NORTHBOUND			SOUTHBOUND			EASTBOUND			WESTBOUND			TOTAL
	Main			Main			MacArthur			MacArthur			
LANES:	NL	NT	NR	SL	ST	SR	EL	ET	ER	WL	WT	WR	
7:00 AM	11	59	34	159	178	36	35	308	35	43	109	54	1,061
7:15 AM	15	53	64	156	193	54	32	358	58	31	106	66	1,186
7:30 AM	12	84	67	188	221	66	60	372	61	42	123	40	1,336
7:45 AM	13	88	72	157	233	40	84	349	72	36	109	46	1,299
8:00 AM	13	82	58	137	192	30	61	300	58	35	92	63	1,121
8:15 AM	12	63	43	146	217	43	50	304	73	41	95	47	1,134
8:30 AM	13	53	63	131	216	31	53	339	72	36	92	42	1,141
8:45 AM	13	49	65	129	198	37	44	301	75	40	88	40	1,079
VOLUMES	102	531	466	1,203	1,648	337	419	2,631	504	304	814	398	9,357
APPROACH %	9%	48%	42%	38%	52%	11%	12%	74%	14%	20%	54%	26%	
APP/DEPART	1,099	/	1,386	3,188	/	2,469	3,554	/	4,252	1,516	/	1,250	0
BEGIN PEAK HR	7:15 AM												
VOLUMES	53	307	261	638	839	190	237	1,379	249	144	430	215	4,942
APPROACH %	9%	49%	42%	38%	50%	11%	13%	74%	13%	18%	54%	27%	
PEAK HR FACTOR	0.897			0.877			0.923			0.962			0.925
APP/DEPART	621	/	789	1,667	/	1,241	1,865	/	2,245	789	/	667	0
4:00 PM	97	244	95	68	71	61	51	132	18	34	362	125	1,358
4:15 PM	88	277	79	69	85	55	49	145	17	36	405	118	1,423
4:30 PM	113	256	78	67	85	67	65	131	14	43	373	107	1,399
4:45 PM	109	215	85	75	87	52	72	150	16	43	384	133	1,421
5:00 PM	118	285	75	58	81	65	66	153	10	43	408	97	1,459
5:15 PM	123	333	89	76	82	80	70	180	15	51	397	107	1,603
5:30 PM	125	272	77	72	98	63	79	143	16	49	381	123	1,498
5:45 PM	117	267	76	74	103	67	80	130	17	53	368	124	1,476
VOLUMES	890	2,149	654	559	692	510	532	1,164	123	352	3,078	934	11,637
APPROACH %	24%	58%	18%	32%	39%	29%	29%	64%	7%	8%	71%	21%	
APP/DEPART	3,693	/	3,628	1,761	/	1,192	1,819	/	2,348	4,364	/	4,469	0
BEGIN PEAK HR	5:00 PM												
VOLUMES	483	1,157	317	280	364	275	295	606	58	196	1,554	451	6,036
APPROACH %	25%	59%	16%	30%	40%	30%	31%	63%	6%	9%	71%	20%	
PEAK HR FACTOR	0.898			0.942			0.905			0.991			0.941
APP/DEPART	1,957	/	1,915	919	/	631	959	/	1,183	2,201	/	2,307	0

U-TURNS				
NB	SB	EB	WB	TTL
0	0	0	0	
3	8	7	0	18
3	5	1	0	9
2	16	2	1	21
4	8	2	1	15
3	7	1	1	12
1	6	4	1	12
4	3	2	4	13
4	6	2	3	15
24	59	21	11	115

5	2	0	3	10
3	6	3	2	14
7	2	3	2	14
6	8	11	2	27
8	4	3	2	17
3	8	4	1	16
6	10	4	3	23
4	6	5	2	17
42	46	33	17	138

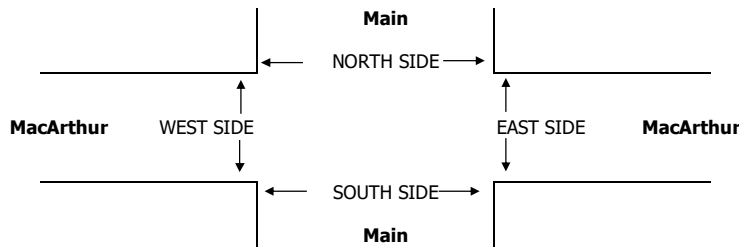

PEDESTRIAN + BIKE CROSSINGS					
	N SIDE	S SIDE	E SIDE	W SIDE	TOTAL
7:00 AM	0	0	0	0	0
7:15 AM	0	0	0	0	0
7:30 AM	0	0	0	0	0
7:45 AM	0	0	0	0	0
8:00 AM	0	0	0	0	0
8:15 AM	0	0	0	0	0
8:30 AM	0	0	0	0	0
8:45 AM	0	0	0	0	0
TOTAL	0	0	0	0	0
AM BEGIN PEAK HR	7:15 AM				
4:00 PM	0	0	0	0	0
4:15 PM	0	0	0	0	0
4:30 PM	0	0	0	0	0
4:45 PM	0	0	0	0	0
5:00 PM	0	0	0	0	0
5:15 PM	0	0	0	0	0
5:30 PM	0	0	0	0	0
5:45 PM	0	0	0	0	0
TOTAL	0	0	0	0	0
PM BEGIN PEAK HR	5:00 PM				

PEDESTRIAN CROSSINGS					
	N SIDE	S SIDE	E SIDE	W SIDE	TOTAL
7:00 AM	0	0	0	0	0
7:15 AM	0	0	0	0	0
7:30 AM	0	0	0	0	0
7:45 AM	0	0	0	0	0
8:00 AM	0	0	0	0	0
8:15 AM	0	0	0	0	0
8:30 AM	0	0	0	0	0
8:45 AM	0	0	0	0	0
TOTAL	0	0	0	0	0
AM BEGIN PEAK HR	7:15 AM				
4:00 PM	0	0	0	0	0
4:15 PM	0	0	0	0	0
4:30 PM	0	0	0	0	0
4:45 PM	0	0	0	0	0
5:00 PM	0	0	0	0	0
5:15 PM	0	0	0	0	0
5:30 PM	0	0	0	0	0
5:45 PM	0	0	0	0	0
TOTAL	0	0	0	0	0
PM BEGIN PEAK HR	5:00 PM				

BICYCLE CROSSINGS					
	NS	SS	ES	WS	TOTAL
7:00 AM	0	0	0	0	0
7:15 AM	0	0	0	0	0
7:30 AM	0	0	0	0	0
7:45 AM	0	0	0	0	0
8:00 AM	0	0	0	0	0
8:15 AM	0	0	0	0	0
8:30 AM	0	0	0	0	0
8:45 AM	0	0	0	0	0
TOTAL	0	0	0	0	0
AM BEGIN PEAK HR	7:15 AM				
4:00 PM	0	0	0	0	0
4:15 PM	0	0	0	0	0
4:30 PM	0	0	0	0	0
4:45 PM	0	0	0	0	0
5:00 PM	0	0	0	0	0
5:15 PM	0	0	0	0	0
5:30 PM	0	0	0	0	0
5:45 PM	0	0	0	0	0
TOTAL	0	0	0	0	0
PM BEGIN PEAK HR	5:00 PM				

City: SANTA ANA
N-S Direction: PENN WAY
E-W Direction: 17TH STREET

File Name : H1702011
Site Code : 00000000
Start Date : 2/9/2017
Page No : 1

Groups Printed- Turning Movements

Start Time	DEAD END Southbound			17TH STREET Westbound				PENN WAY Northbound				17TH STREET Eastbound			Int. Total
	Right	Thru	Left	Right	Thru	Left	Peds	Right	Thru	Left	Peds	Right	Thru	Left	
07:00	0	0	0	0	298	46	0	44	0	7	0	164	280	0	839
07:15	0	0	0	0	394	55	0	70	0	10	0	163	260	0	952
07:30	0	0	0	0	471	47	0	53	0	6	0	165	321	0	1063
07:45	0	0	0	0	461	68	1	50	0	14	0	162	288	0	1044
Total	0	0	0	0	1624	216	1	217	0	37	0	654	1149	0	3898
08:00	0	0	0	0	345	37	0	37	0	11	0	122	332	0	884
08:15	0	0	0	0	280	37	0	38	0	7	0	137	280	0	779
08:30	0	0	0	0	299	32	0	41	0	7	1	116	255	0	751
08:45	0	0	0	0	307	25	0	52	0	14	0	99	231	0	728
Total	0	0	0	0	1231	131	0	168	0	39	1	474	1098	0	3142
*** BREAK ***															
16:00	0	0	0	0	327	28	1	98	0	23	1	102	326	0	906
16:15	0	0	0	0	405	26	0	78	0	21	0	106	304	0	940
16:30	0	0	0	0	350	40	1	89	0	18	0	111	335	0	944
16:45	0	0	0	0	360	30	0	98	0	19	1	113	329	0	950
Total	0	0	0	0	1442	124	2	363	0	81	2	432	1294	0	3740
17:00	0	0	0	0	335	30	1	108	0	24	0	149	413	0	1060
17:15	0	0	0	0	394	27	0	99	0	27	0	118	388	0	1053
17:30	0	0	0	0	337	35	1	110	0	15	1	122	339	0	960
17:45	0	0	0	0	331	27	0	84	0	17	1	108	403	0	971
Total	0	0	0	0	1397	119	2	401	0	83	2	497	1543	0	4044
Grand Total	0	0	0	0	5694	590	5	1149	0	240	5	2057	5084	0	14824
Apprch %	0	0	0	0	90.5	9.4	0.1	82.4	0	17.2	0.4	28.8	71.2	0	
Total %	0	0	0	0	38.4	4	0	7.8	0	1.6	0	13.9	34.3	0	

City: SANTA ANA
 N-S Direction: PENN WAY
 E-W Direction: 17TH STREET

File Name : H1702011
 Site Code : 00000000
 Start Date : 2/9/2017
 Page No : 2

Start Time	DEAD END Southbound				17TH STREET Westbound					PENN WAY Northbound					17TH STREET Eastbound				Int. Total
	Right	Thru	Left	App. Total	Right	Thru	Left	Peds	App. Total	Right	Thru	Left	Peds	App. Total	Right	Thru	Left	App. Total	
Peak Hour Analysis From 07:00 to 08:45 - Peak 1 of 1																			
Peak Hour for Entire Intersection Begins at 07:15																			
07:15	0	0	0	0	0	394	55	0	449	76	0	6	0	80					
07:30	0	0	0	0	0	471	47	0	518	53	0	6	0	59	165	321	0	486	1063
07:45	0	0	0	0	0	461	68	1	530	50	0	14	0	64	162	288	0	450	1044
08:00	0	0	0	0	0	345	37	0	382	37	0	11	0	48	122	332	0	454	884
Total Volume	0	0	0	0	0	1671	207	1	1879	210	0	41	0	251	612	1201	0	1813	3943
% App. Total	0	0	0	0	0	88.9	11	0.1		83.7	0	16.3	0		33.8	66.2	0		
PHF	.000	.000	.000	.000	.000	.887	.761	.250	.886	.750	.000	.732	.000	.784	.927	.904	.000	.933	.927

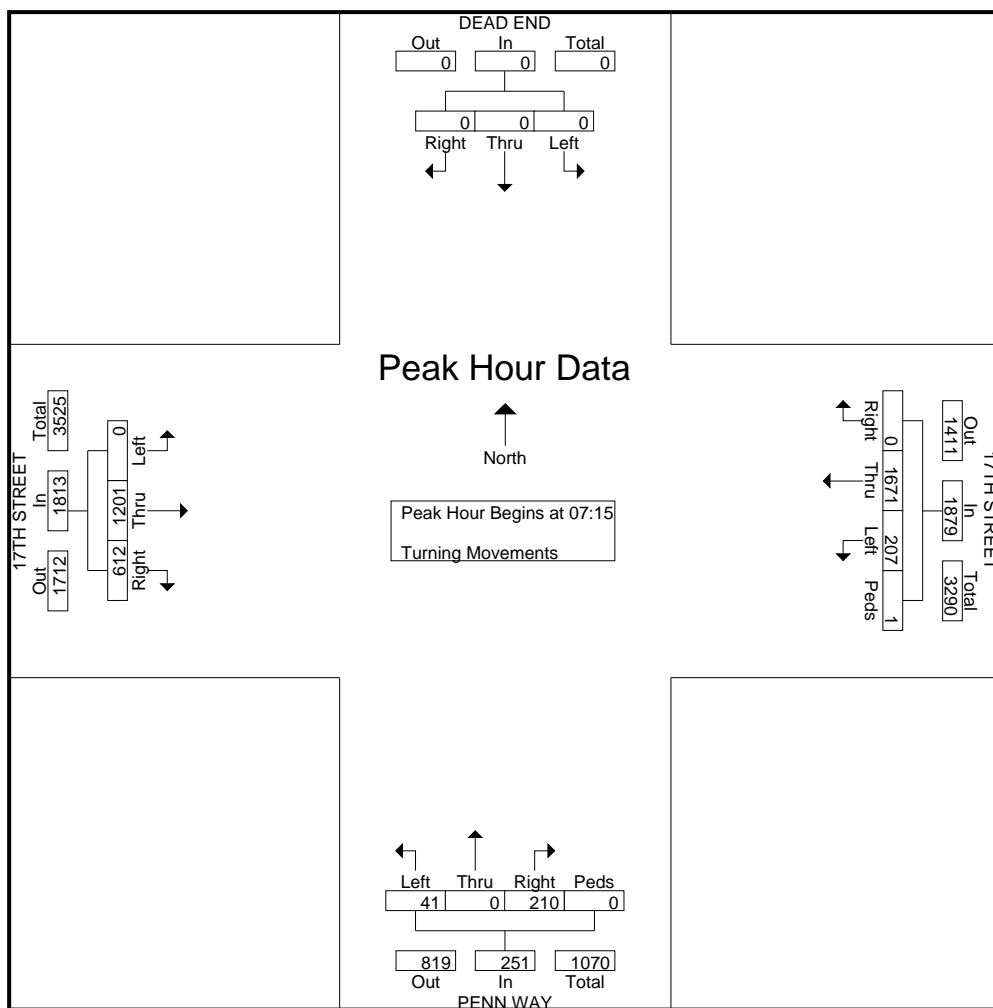

City: SANTA ANA
 N-S Direction: PENN WAY
 E-W Direction: 17TH STREET

File Name : H1702011
 Site Code : 00000000
 Start Date : 2/9/2017
 Page No : 3

Start Time	DEAD END Southbound				17TH STREET Westbound					PENN WAY Northbound					17TH STREET Eastbound				Int. Total
	Right	Thru	Left	App. Total	Right	Thru	Left	Peds	App. Total	Right	Thru	Left	Peds	App. Total	Right	Thru	Left	App. Total	
Peak Hour Analysis From 16:00 to 17:45 - Peak 1 of 1																			
Peak Hour for Entire Intersection Begins at 17:00																			
17:00	0	0	0	0	0	335	30	1	366	108	0	24	0	132	149	413	0	562	1060
17:15	0	0	0	0	0	394	27	0	421	99	0	27	0	126	118	388	0	506	1053
17:30	0	0	0	0	0	337	35	1	373	110	0	15	1	126	122	339	0	461	960
17:45	0	0	0	0	0	331	27	0	358	84	0	17	1	102	108	403	0	511	971
Total Volume	0	0	0	0	0	1397	119	2	1518	401	0	83	2	486	497	1543	0	2040	4044
% App. Total	0	0	0	0	0	92	7.8	0.1		82.5	0	17.1	0.4		24.4	75.6	0		
PHF	.000	.000	.000	.000	.000	.886	.850	.500	.901	.911	.000	.769	.500	.920	.834	.934	.000	.907	.954

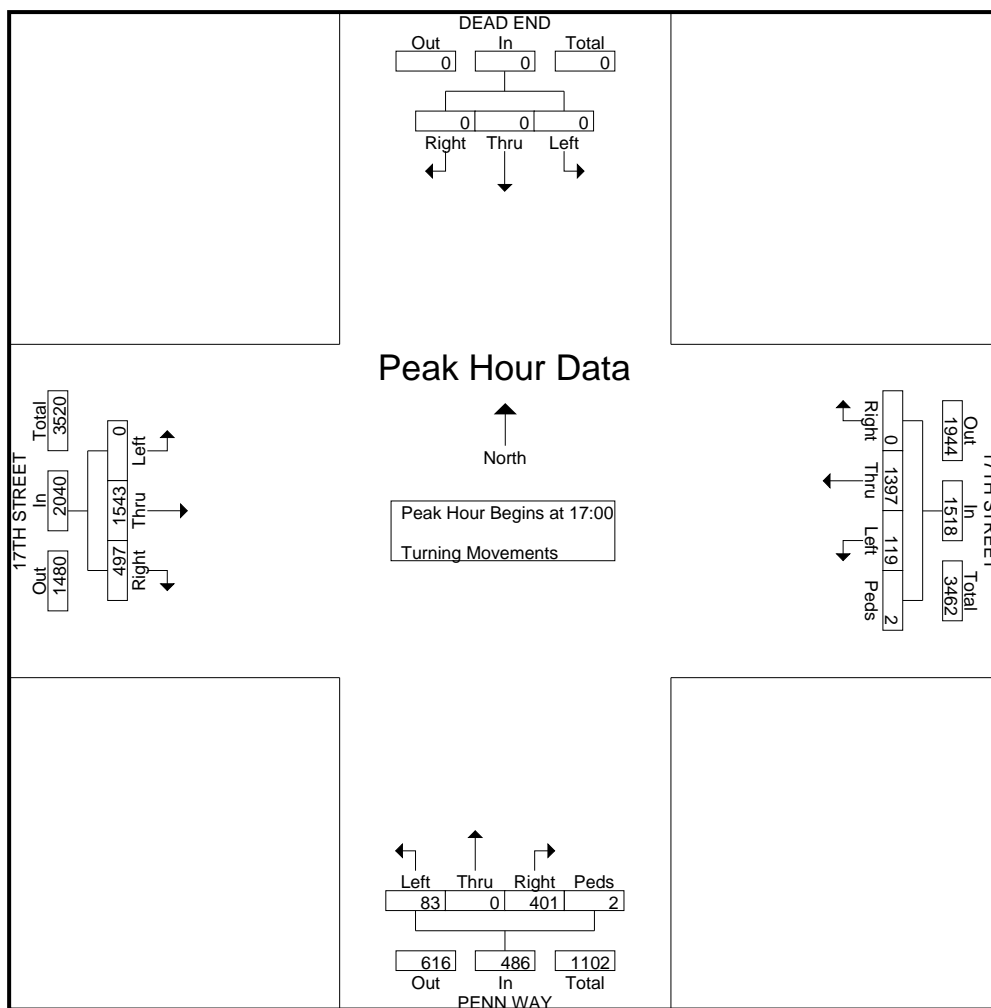

INTERSECTION TURNING MOVEMENT COUNTS

PREPARED BY: AimTD LLC. tel: 714 253 7888 cs@aimtd.com

T218

DATE:
Tue, May 14, 19

LOCATION: Santa Ana
NORTH & SOUTH: I-5 NB Ramps
EAST & WEST: 17th

PROJECT #: SC2183
LOCATION #: 30
CONTROL: SIGNAL

NOTES:

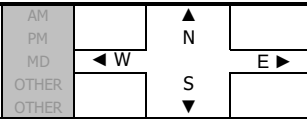

Add U-Turns to Left Turns

	NORTHBOUND			SOUTHBOUND			EASTBOUND			WESTBOUND			TOTAL
	I-5 NB Ramps			I-5 NB Ramps			17th			17th			
LANES:	NL 1.5	NT 0.5	NR 1	SL 1	ST X	SR 1	EL 1	ET 3	ER 1	WL X	WT 3	WR 0	
AM													
7:00 AM	129	11	9	7	0	51	21	188	65	0	200	1	682
7:15 AM	180	16	1	15	0	54	15	255	65	0	259	4	864
7:30 AM	220	5	10	14	0	69	21	266	91	0	304	7	1,007
7:45 AM	201	8	6	15	0	100	29	276	108	0	365	4	1,112
8:00 AM	159	5	4	12	0	69	33	232	108	0	304	4	930
8:15 AM	151	5	11	9	0	48	20	227	52	0	206	6	735
8:30 AM	130	12	11	5	0	45	23	223	60	0	201	8	718
8:45 AM	110	8	3	12	0	35	16	192	67	0	202	9	654
VOLUMES	1,280	70	55	89	0	471	178	1,859	616	0	2,041	43	6,702
APPROACH %	91%	5%	4%	16%	0%	84%	7%	70%	23%	0%	98%	2%	
APP/DEPART	1,405	/	250	560	/	616	2,653	/	2,003	2,084	/	3,833	0
BEGIN PEAK HR	7:15 AM												
VOLUMES	760	34	21	56	0	292	98	1,029	372	0	1,232	19	3,913
APPROACH %	93%	4%	3%	16%	0%	84%	7%	69%	25%	0%	98%	2%	
PEAK HR FACTOR	0.867				0.757		0.907			0.848			0.880
APP/DEPART	815	/	124	348	/	372	1,499	/	1,106	1,251	/	2,311	0
PM													
4:00 PM	81	9	5	5	0	24	26	240	157	0	353	10	910
4:15 PM	88	14	4	15	0	33	28	251	128	0	374	9	944
4:30 PM	86	8	3	6	0	33	27	228	202	0	367	13	973
4:45 PM	83	12	6	9	0	32	29	286	176	0	377	7	1,017
5:00 PM	84	11	4	20	0	33	34	323	208	0	391	11	1,119
5:15 PM	80	23	4	9	0	42	29	262	141	0	303	9	902
5:30 PM	71	14	6	11	0	39	31	241	113	0	361	14	901
5:45 PM	94	12	7	17	0	34	29	273	93	0	341	5	905
VOLUMES	667	103	39	92	0	270	233	2,104	1,218	0	2,867	78	7,671
APPROACH %	82%	13%	5%	25%	0%	75%	7%	59%	34%	0%	97%	3%	
APP/DEPART	809	/	366	362	/	1,218	3,555	/	2,235	2,945	/	3,852	0
BEGIN PEAK HR	4:15 PM												
VOLUMES	341	45	17	50	0	131	118	1,088	714	0	1,509	40	4,053
APPROACH %	85%	11%	4%	28%	0%	72%	6%	57%	37%	0%	97%	3%	
PEAK HR FACTOR	0.950			0.854			0.850			0.963			0.905
APP/DEPART	403	/	181	181	/	714	1,920	/	1,155	1,549	/	2,003	0

U-TURNS				
NB	SB	EB	WB	TTL
0	0	3	0	3
0	0	5	0	5
0	0	4	0	4
0	0	7	0	7
0	0	11	0	11
0	0	2	0	2
0	0	4	0	4
0	0	5	0	5
0	0	41	0	41

0	0	8	0	8
0	0	5	0	5
0	0	3	0	3
0	0	8	0	8
0	0	6	0	6
0	0	4	0	4
0	0	4	0	4
0	0	10	0	10
0	0	48	0	48

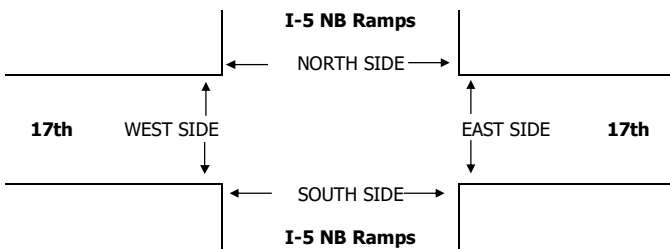

	PEDESTRIAN + BIKE CROSSINGS				
	N SIDE	S SIDE	E SIDE	W SIDE	TOTAL
AM					
7:00 AM	0	0	0	0	0
7:15 AM	0	0	0	0	0
7:30 AM	0	0	0	0	0
7:45 AM	0	0	0	0	0
8:00 AM	0	0	0	0	0
8:15 AM	0	0	0	0	0
8:30 AM	0	0	0	0	0
8:45 AM	0	0	0	0	0
TOTAL	0	0	0	0	0
AM BEGIN PEAK HR	7:15 AM				
4:00 PM	0	0	0	0	0
4:15 PM	0	0	0	0	0
4:30 PM	0	0	0	0	0
4:45 PM	0	0	0	0	0
5:00 PM	0	0	0	0	0
5:15 PM	0	0	0	0	0
5:30 PM	0	0	0	0	0
5:45 PM	0	0	0	0	0
TOTAL	0	0	0	0	0
PM BEGIN PEAK HR	4:15 PM				

	PEDESTRIAN CROSSINGS				
	N SIDE	S SIDE	E SIDE	W SIDE	TOTAL
AM					
7:00 AM	0	0	0	0	0
7:15 AM	0	0	0	0	0
7:30 AM	0	0	0	0	0
7:45 AM	0	0	0	0	0
8:00 AM	0	0	0	0	0
8:15 AM	0	0	0	0	0
8:30 AM	0	0	0	0	0
8:45 AM	0	0	0	0	0
TOTAL	0	0	0	0	0
AM BEGIN PEAK HR	7:15 AM				
4:00 PM	0	0	0	0	0
4:15 PM	0	0	0	0	0
4:30 PM	0	0	0	0	0
4:45 PM	0	0	0	0	0
5:00 PM	0	0	0	0	0
5:15 PM	0	0	0	0	0
5:30 PM	0	0	0	0	0
5:45 PM	0	0	0	0	0
TOTAL	0	0	0	0	0
PM BEGIN PEAK HR	4:15 PM				

	BICYCLE CROSSINGS				
	NS	SS	ES	WS	TOTAL
AM					
7:00 AM	0	0	0	0	0
7:15 AM	0	0	0	0	0
7:30 AM	0	0	0	0	0
7:45 AM	0	0	0	0	0
8:00 AM	0	0	0	0	0
8:15 AM	0	0	0	0	0
8:30 AM	0	0	0	0	0
8:45 AM	0	0	0	0	0
TOTAL	0	0	0	0	0
AM BEGIN PEAK HR	7:15 AM				
4:00 PM	0	0	0	0	0
4:15 PM	0	0	0	0	0
4:30 PM	0	0	0	0	0
4:45 PM	0	0	0	0	0
5:00 PM	0	0	0	0	0
5:15 PM	0	0	0	0	0
5:30 PM	0	0	0	0	0
5:45 PM	0	0	0	0	0
TOTAL	0	0	0	0	0
PM BEGIN PEAK HR	4:15 PM				

City: SANTA ANA
 N-S Direction: PENN WAY
 E-W Direction: I-5 SB RAMPS

File Name : H1702012
 Site Code : 00000000
 Start Date : 2/9/2017
 Page No : 1

Groups Printed- Turning Movements

Start Time	PENN WAY Southbound			I-5 SB RAMPS Westbound			PENN WAY Northbound			DEAD END Eastbound			Int. Total
	Right	Thru	Left	Right	Thru	Left	Right	Thru	Left	Right	Thru	Left	
07:00	0	31	198	22	0	44	18	29	0	0	0	0	342
07:15	0	32	196	36	0	39	32	41	0	0	0	0	376
07:30	0	37	191	19	0	38	35	40	0	0	0	0	360
07:45	0	60	190	20	0	52	50	43	0	0	0	0	415
Total	0	160	775	97	0	173	135	153	0	0	0	0	1493
08:00	0	30	144	21	0	48	37	27	0	0	0	0	307
08:15	0	28	153	20	0	17	32	28	0	0	0	0	278
08:30	0	20	139	34	0	21	19	17	0	0	0	0	250
08:45	0	18	113	31	0	23	18	33	0	0	0	0	236
Total	0	96	549	106	0	109	106	105	0	0	0	0	1071
*** BREAK ***													
16:00	0	25	111	57	0	40	44	64	0	0	0	0	341
16:15	0	22	114	45	0	51	37	59	0	0	0	0	328
16:30	0	33	105	31	0	46	69	74	0	0	0	0	358
16:45	0	30	130	43	0	52	51	70	0	0	0	0	376
Total	0	110	460	176	0	189	201	267	0	0	0	0	1403
17:00	0	32	152	40	0	41	77	94	0	0	0	0	436
17:15	0	30	119	34	0	37	63	92	0	0	0	0	375
17:30	0	31	132	28	0	39	40	96	0	0	0	0	366
17:45	0	39	112	27	0	29	22	74	0	0	0	0	303
Total	0	132	515	129	0	146	202	356	0	0	0	0	1480
Grand Total	0	498	2299	508	0	617	644	881	0	0	0	0	5447
Apprch %	0	17.8	82.2	45.2	0	54.8	42.2	57.8	0	0	0	0	
Total %	0	9.1	42.2	9.3	0	11.3	11.8	16.2	0	0	0	0	

City: SANTA ANA
 N-S Direction: PENN WAY
 E-W Direction: I-5 SB RAMPS

File Name : H1702012
 Site Code : 00000000
 Start Date : 2/9/2017
 Page No : 2

Start Time	PENN WAY Southbound				I-5 SB RAMPS Westbound				PENN WAY Northbound				DEAD END Eastbound				Int. Total
	Right	Thru	Left	App. Total	Right	Thru	Left	App. Total	Right	Thru	Left	App. Total	Right	Thru	Left	App. Total	
Peak Hour Analysis From 07:00 to 08:45 - Peak 1 of 1																	
Peak Hour for Entire Intersection Begins at 07:00																	
07:00	0	31	198	229	22	0	44	66	18	29	0	47	0	0	0	0	342
07:15	0	32	196	228	36	0	39	75	32	41	0	73	0	0	0	0	376
07:30	0	37	191	228	19	0	38	57	35	40	0	75	0	0	0	0	360
07:45	0	60	190	250	20	0	52	72	50	43	0	93	0	0	0	0	415
Total Volume	0	160	775	935	97	0	173	270	135	153	0	288	0	0	0	0	1493
% App. Total	0	17.1	82.9		35.9	0	64.1		46.9	53.1	0		0	0	0		
PHF	.000	.667	.979	.935	.674	.000	.832	.900	.675	.890	.000	.774	.000	.000	.000	.000	.899

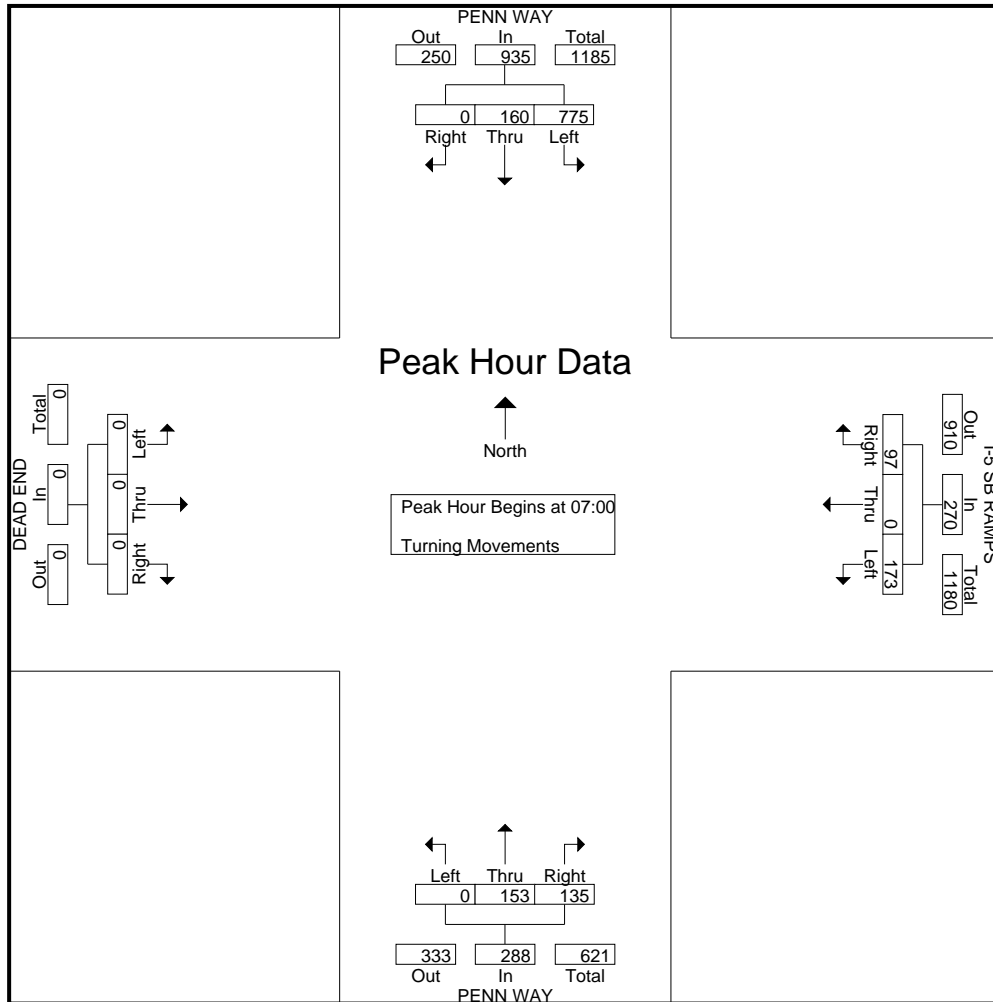

City: SANTA ANA
 N-S Direction: PENN WAY
 E-W Direction: I-5 SB RAMPS

File Name : H1702012
 Site Code : 00000000
 Start Date : 2/9/2017
 Page No : 3

Start Time	PENN WAY Southbound				I-5 SB RAMPS Westbound				PENN WAY Northbound				DEAD END Eastbound				Int. Total
	Right	Thru	Left	App. Total	Right	Thru	Left	App. Total	Right	Thru	Left	App. Total	Right	Thru	Left	App. Total	
Peak Hour Analysis From 16:00 to 17:45 - Peak 1 of 1																	
Peak Hour for Entire Intersection Begins at 16:45																	
16:45	0	30	130	160	43	0	52	95	51	70	0	121	0	0	0	0	376
17:00	0	32	152	184	40	0	41	81	77	94	0	171	0	0	0	0	436
17:15	0	30	119	149	34	0	37	71	63	92	0	155	0	0	0	0	375
17:30	0	31	132	163	28	0	39	67	40	96	0	136	0	0	0	0	366
Total Volume	0	123	533	656	145	0	169	314	231	352	0	583	0	0	0	0	1553
% App. Total	0	18.8	81.2		46.2	0	53.8		39.6	60.4	0		0	0	0		
PHF	.000	.961	.877	.891	.843	.000	.813	.826	.750	.917	.000	.852	.000	.000	.000	.000	.890

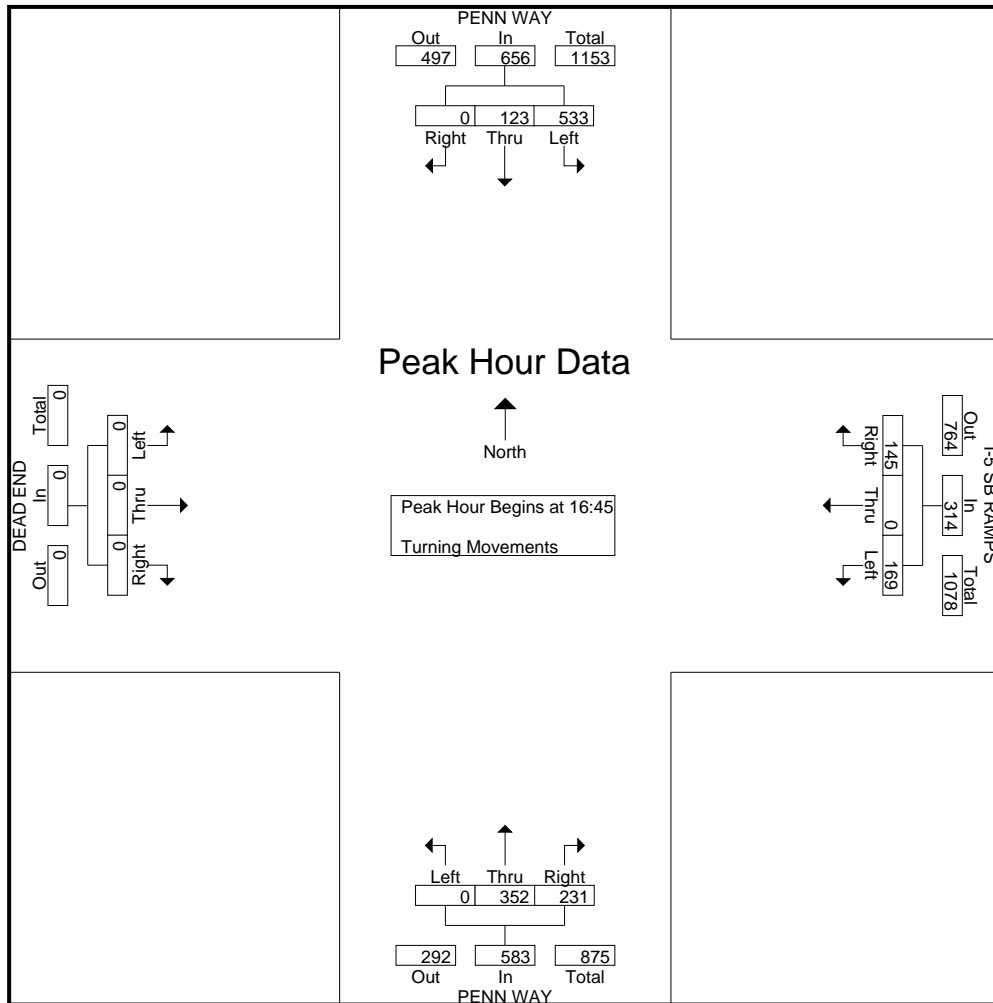

City: SANTA ANA
 N-S Direction: SANTIAGO STREET
 E-W Direction: CIVIC CENTER DRIVE

File Name : H1702013
 Site Code : 00000000
 Start Date : 2/9/2017
 Page No : 1

Groups Printed- Turning Movements

Start Time	SANTIAGO STREET Southbound			CIVIC CENTER DRIVE Westbound			SANTIAGO STREET Northbound			CIVIC CENTER DRIVE Eastbound			Int. Total
	Right	Thru	Left	Right	Thru	Left	Right	Thru	Left	Right	Thru	Left	
07:00	12	60	0	1	6	8	1	22	15	33	4	16	178
07:15	15	73	0	3	12	14	1	20	37	47	9	30	261
07:30	22	82	0	4	14	14	6	41	55	67	11	31	347
07:45	16	70	3	2	23	25	6	44	69	63	13	29	363
Total	65	285	3	10	55	61	14	127	176	210	37	106	1149
08:00	18	69	1	3	15	16	6	33	38	61	11	27	298
08:15	9	35	1	1	1	7	5	19	29	27	8	12	154
08:30	5	44	1	3	1	6	3	8	18	26	9	9	133
08:45	5	43	0	0	1	4	3	18	25	20	6	15	140
Total	37	191	3	7	18	33	17	78	110	134	34	63	725
*** BREAK ***													
16:00	5	52	0	1	4	3	3	46	18	45	6	37	220
16:15	10	41	2	2	3	4	4	59	15	32	8	33	213
16:30	7	48	1	2	3	1	2	48	26	44	12	64	258
16:45	14	47	2	5	3	3	12	59	27	68	20	67	327
Total	36	188	5	10	13	11	21	212	86	189	46	201	1018
17:00	16	38	3	6	8	2	8	70	25	90	20	77	363
17:15	6	47	3	4	4	2	5	76	24	54	16	66	307
17:30	10	49	4	2	3	6	4	85	18	49	17	48	295
17:45	10	51	1	1	6	3	6	65	22	37	11	50	263
Total	42	185	11	13	21	13	23	296	89	230	64	241	1228
Grand Total	180	849	22	40	107	118	75	713	461	763	181	611	4120
Apprch %	17.1	80.8	2.1	15.1	40.4	44.5	6	57.1	36.9	49.1	11.6	39.3	
Total %	4.4	20.6	0.5	1	2.6	2.9	1.8	17.3	11.2	18.5	4.4	14.8	

City: SANTA ANA
 N-S Direction: SANTIAGO STREET
 E-W Direction: CIVIC CENTER DRIVE

File Name : H1702013
 Site Code : 00000000
 Start Date : 2/9/2017
 Page No : 2

Start Time	SANTIAGO STREET Southbound				CIVIC CENTER DRIVE Westbound				SANTIAGO STREET Northbound				CIVIC CENTER DRIVE Eastbound				Int. Total
	Right	Thru	Left	App. Total	Right	Thru	Left	App. Total	Right	Thru	Left	App. Total	Right	Thru	Left	App. Total	
Peak Hour Analysis From 07:00 to 08:45 - Peak 1 of 1																	
Peak Hour for Entire Intersection Begins at 07:15																	
07:15	15	73	0	88	3	12	14	29	1	20	37	58	47	9	30	86	261
07:30	22	82	0	104	4	14	14	32	6	41	55	102	67	11	31	109	347
07:45	16	70	3	89	2	23	25	50	6	44	69	119	63	13	29	105	363
08:00	18	69	1	88	3	15	16	34	6	33	38	77	61	11	27	99	298
Total Volume	71	294	4	369	12	64	69	145	19	138	199	356	238	44	117	399	1269
% App. Total	19.2	79.7	1.1		8.3	44.1	47.6		5.3	38.8	55.9		59.6	11	29.3		
PHF	.807	.896	.333	.887	.750	.696	.690	.725	.792	.784	.721	.748	.888	.846	.944	.915	.874

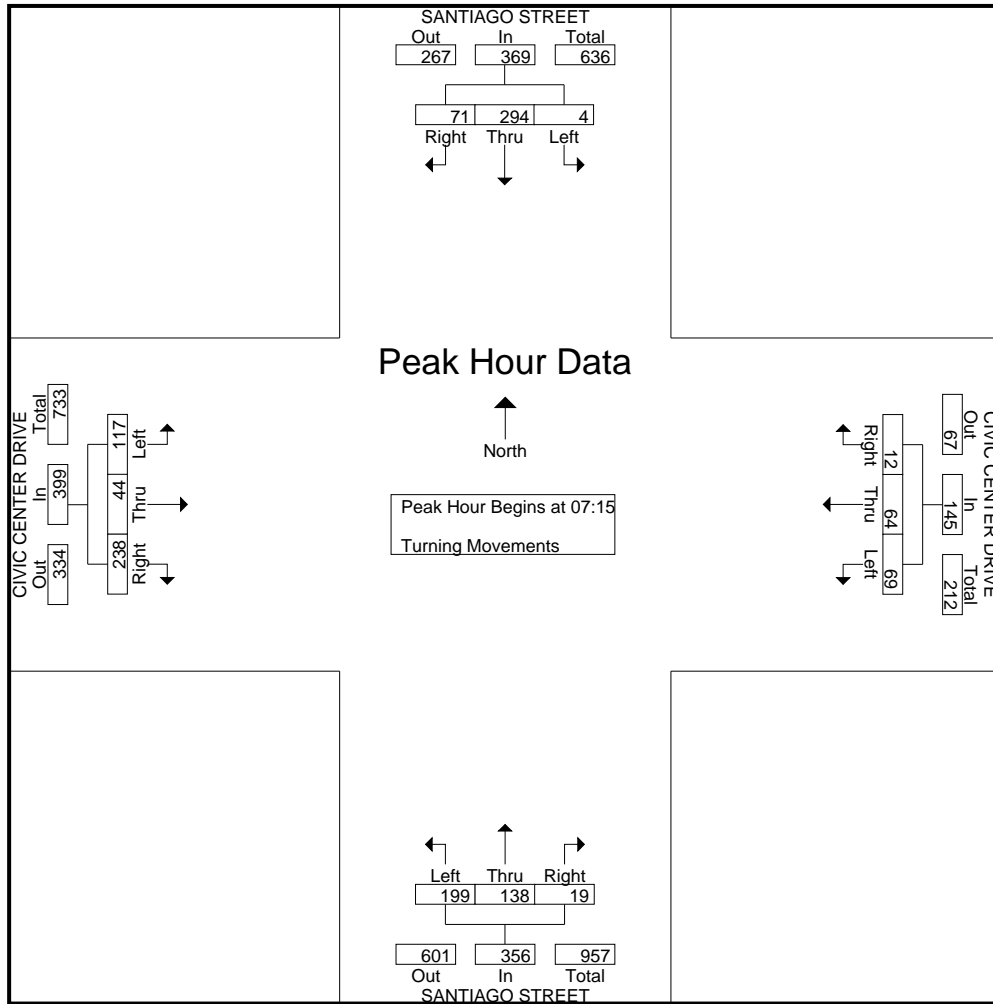

City: SANTA ANA
 N-S Direction: SANTIAGO STREET
 E-W Direction: CIVIC CENTER DRIVE

File Name : H1702013
 Site Code : 00000000
 Start Date : 2/9/2017
 Page No : 3

Start Time	SANTIAGO STREET Southbound				CIVIC CENTER DRIVE Westbound				SANTIAGO STREET Northbound				CIVIC CENTER DRIVE Eastbound				Int. Total
	Right	Thru	Left	App. Total	Right	Thru	Left	App. Total	Right	Thru	Left	App. Total	Right	Thru	Left	App. Total	
Peak Hour Analysis From 16:00 to 17:45 - Peak 1 of 1																	
Peak Hour for Entire Intersection Begins at 16:45																	
16:45	14	47	2	63	5	3	3	11	12	59	27	98	68	20	67	155	327
17:00	16	38	3	57	6	8	2	16	8	70	25	103	90	20	77	187	363
17:15	6	47	3	56	4	4	2	10	5	76	24	105	54	16	66	136	307
17:30	10	49	4	63	2	3	6	11	4	85	18	107	49	17	48	114	295
Total Volume	46	181	12	239	17	18	13	48	29	290	94	413	261	73	258	592	1292
% App. Total	19.2	75.7	5		35.4	37.5	27.1		7	70.2	22.8		44.1	12.3	43.6		
PHF	.719	.923	.750	.948	.708	.563	.542	.750	.604	.853	.870	.965	.725	.913	.838	.791	.890

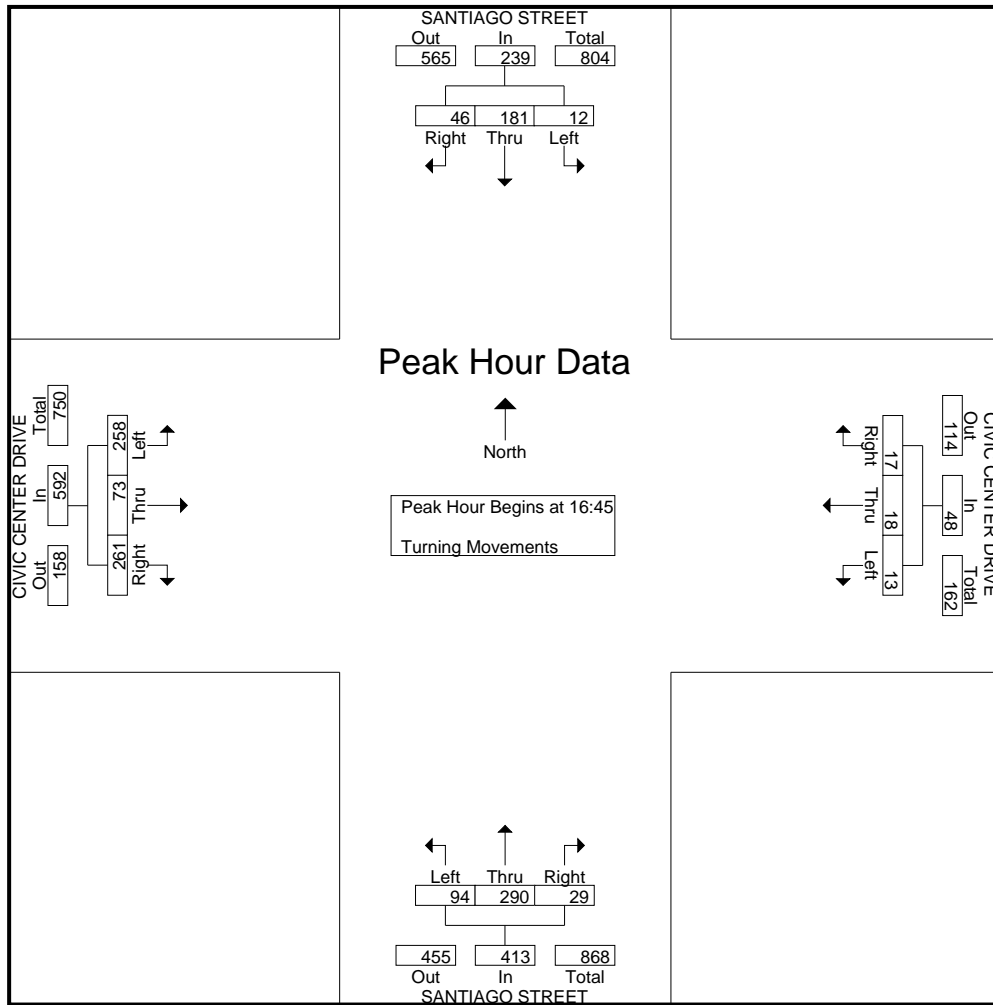

INTERSECTION TURNING MOVEMENT COUNTS

PREPARED BY: AimTD LLC. tel: 714 253 7888 pacific@aimtd.com

DATE:
Thu, Feb 11, 16

LOCATION:
NORTH & SOUTH: Santa Ana
EAST & WEST: Santiago

PROJECT #: SC0846
LOCATION #: 15
CONTROL: SIGNAL

NOTES:	AM PM MD OTHER OTHER	▲ N ▼	◀ W E ▶	
--------	----------------------------------	-------------	------------	--

Add U-Turns to Left Turns

LANES:	NORTHBOUND			SOUTHBOUND			EASTBOUND			WESTBOUND			TOTAL
	Santiago			Santiago			Santa Ana			Santa Ana			
	NL	NT	NR	SL	ST	SR	EL	ET	ER	WL	WT	WR	

U-TURNS				
NB	SB	EB	WB	TTL

AM	7:00 AM	6	12	16	52	27	20	6	77	5	32	137	34	424
	7:15 AM	7	11	18	69	31	24	3	128	1	17	162	41	512
	7:30 AM	5	17	9	85	31	36	11	139	4	31	212	67	647
	7:45 AM	2	16	11	62	62	32	24	104	1	33	250	102	699
	8:00 AM	9	24	15	82	30	35	8	84	7	22	151	50	517
	8:15 AM	4	14	19	46	21	16	9	68	4	16	148	35	400
	8:30 AM	2	12	17	39	15	18	1	69	2	20	139	27	361
	8:45 AM	2	7	19	40	22	15	1	48	9	17	123	25	328
	VOLUMES	37	113	124	475	239	196	63	717	33	188	1,322	381	3,888
	APPROACH %	14%	41%	45%	52%	26%	22%	8%	88%	4%	10%	70%	20%	
APP/DEPART	274	/	557	910	/	417	813	/	1,359	1,891	/	1,555	0	
BEGIN PEAK HR	7:15 AM													
VOLUMES	23	68	53	298	154	127	46	455	13	103	775	260	2,375	
APPROACH %	16%	47%	37%	51%	27%	22%	9%	89%	3%	9%	68%	23%		
PEAK HR FACTOR	0.750			0.928			0.834			0.739			0.849	
APP/DEPART	144	/	374	579	/	241	514	/	835	1,138	/	925	0	
PM	4:00 PM	3	28	16	60	21	15	7	109	12	22	90	32	415
	4:15 PM	3	21	14	45	24	25	6	127	1	17	77	29	389
	4:30 PM	8	20	16	61	23	15	21	147	2	21	123	55	512
	4:45 PM	5	30	14	77	29	14	17	159	8	16	132	46	547
	5:00 PM	8	38	24	70	28	10	16	175	4	17	102	34	526
	5:15 PM	13	39	26	77	35	19	14	142	5	16	115	44	545
	5:30 PM	6	22	19	55	31	22	13	93	6	18	111	26	422
	5:45 PM	11	42	17	62	29	24	9	90	3	23	101	51	462
	VOLUMES	57	240	146	507	220	144	103	1,042	41	150	851	317	3,818
	APPROACH %	13%	54%	33%	58%	25%	17%	9%	88%	3%	11%	65%	24%	
APP/DEPART	443	/	660	871	/	365	1,186	/	1,741	1,318	/	1,052	0	
BEGIN PEAK HR	4:30 PM													
VOLUMES	34	127	80	285	115	58	68	623	19	70	472	179	2,130	
APPROACH %	14%	53%	33%	62%	25%	13%	10%	88%	3%	10%	65%	25%		
PEAK HR FACTOR	0.772			0.874			0.910			0.906			0.973	
APP/DEPART	241	/	374	458	/	186	710	/	1,006	721	/	564	0	

0	0	0	9	9
0	0	0	6	6
0	0	0	12	12
0	0	0	5	5
0	0	0	6	6
0	0	0	1	1
0	0	0	2	2
0	0	0	2	2
0	0	0	43	43
0	0	0	6	6
0	0	0	4	4
0	0	0	3	3
0	0	0	5	5
0	0	0	8	8
0	0	0	2	2
0	0	0	8	8
0	0	0	10	10
0	0	0	46	46

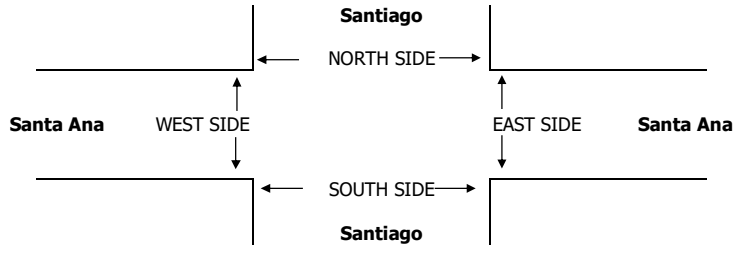

	PEDESTRIAN + BIKE CROSSINGS				
	N SIDE	S SIDE	E SIDE	W SIDE	TOTAL

AM	7:00 AM	9	18	12	8	47
	7:15 AM	14	6	8	6	34
	7:30 AM	9	4	8	7	28
	7:45 AM	1	4	5	2	12
	8:00 AM	1	1	6	1	9
	8:15 AM	0	1	2	1	4
	8:30 AM	2	1	2	2	7
	8:45 AM	0	6	3	3	12
	TOTAL	36	41	46	30	153
	PM	4:00 PM	4	6	5	5
4:15 PM		0	4	4	1	9
4:30 PM		4	2	5	1	12
4:45 PM		2	2	5	0	9
5:00 PM		3	15	8	4	30
5:15 PM		3	10	7	10	30
5:30 PM		2	8	9	7	26
5:45 PM		1	0	1	6	8
TOTAL	19	47	44	34	144	

PEDESTRIAN CROSSINGS				
N SIDE	S SIDE	E SIDE	W SIDE	TOTAL

BICYCLE CROSSINGS				
NS	SS	ES	WS	TOTAL

City: SANTA ANA
 N-S Direction: STANDARD AVENUE
 E-W Direction: 1ST STREET

File Name : H1702014
 Site Code : 00000000
 Start Date : 2/9/2017
 Page No : 1

Groups Printed- Turning Movements

Start Time	STANDARD AVENUE Southbound			1ST STREET Westbound			STANDARD AVENUE Northbound			1ST STREET Eastbound				Int. Total
	Right	Thru	Left	Right	Thru	Left	Right	Thru	Left	Right	Thru	Left	U-Turn	
07:00	0	41	6	1	179	10	28	43	17	50	282	10	2	669
07:15	3	49	7	1	228	10	19	42	23	39	376	21	2	820
07:30	4	61	3	5	255	14	43	55	28	60	324	20	2	874
07:45	3	65	8	2	282	19	27	47	36	70	291	19	3	872
Total	10	216	24	9	944	53	117	187	104	219	1273	70	9	3235
08:00	1	49	6	3	217	19	26	41	17	38	287	15	1	720
08:15	4	47	3	4	204	13	19	41	20	52	333	8	4	752
08:30	7	19	4	2	177	5	14	32	21	37	284	8	1	611
08:45	2	29	2	5	171	19	22	31	17	22	304	9	3	636
Total	14	144	15	14	769	56	81	145	75	149	1208	40	9	2719
*** BREAK ***														
16:00	5	41	5	3	251	17	19	78	53	31	272	22	2	799
16:15	4	39	2	4	251	23	34	98	43	36	294	19	2	849
16:30	2	37	5	4	243	17	30	79	44	28	311	20	2	822
16:45	2	33	1	6	265	29	23	79	45	26	297	26	4	836
Total	13	150	13	17	1010	86	106	334	185	121	1174	87	10	3306
17:00	8	45	9	6	246	24	51	93	35	30	311	24	6	888
17:15	2	48	2	4	297	21	23	81	39	34	300	37	2	890
17:30	5	50	3	7	281	24	13	98	49	37	290	42	15	914
17:45	7	40	4	3	290	19	28	84	56	24	281	33	12	881
Total	22	183	18	20	1114	88	115	356	179	125	1182	136	35	3573
Grand Total	59	693	70	60	3837	283	419	1022	543	614	4837	333	63	12833
Apprch %	7.2	84.3	8.5	1.4	91.8	6.8	21.1	51.5	27.4	10.5	82.7	5.7	1.1	
Total %	0.5	5.4	0.5	0.5	29.9	2.2	3.3	8	4.2	4.8	37.7	2.6	0.5	

City: SANTA ANA
 N-S Direction: STANDARD AVENUE
 E-W Direction: 1ST STREET

File Name : H1702014
 Site Code : 00000000
 Start Date : 2/9/2017
 Page No : 2

Start Time	STANDARD AVENUE Southbound				1ST STREET Westbound				STANDARD AVENUE Northbound				1ST STREET Eastbound					
	Right	Thru	Left	App. Total	Right	Thru	Left	App. Total	Right	Thru	Left	App. Total	Right	Thru	Left	U-Turn	App. Total	Int. Total
Peak Hour Analysis From 07:00 to 08:45 - Peak 1 of 1																		
Peak Hour for Entire Intersection Begins at 07:15																		
07:15	3	49	7	59	1	228	10	239	19	42	23	84	39	376	21	2	438	820
07:30	4	61	3	68	5	255	14	274	43	55	28	126	60	324	20	2	406	874
07:45	3	65	8	76	2	282	19	303	27	47	36	110	70	291	19	3	383	872
08:00	1	49	6	56	3	217	19	239	26	41	17	84	38	287	15	1	341	720
Total Volume	11	224	24	259	11	982	62	1055	115	185	104	404	207	1278	75	8	1568	3286
% App. Total	4.2	86.5	9.3		1	93.1	5.9		28.5	45.8	25.7		13.2	81.5	4.8	0.5		
PHF	.688	.862	.750	.852	.550	.871	.816	.870	.669	.841	.722	.802	.739	.850	.893	.667	.895	.940

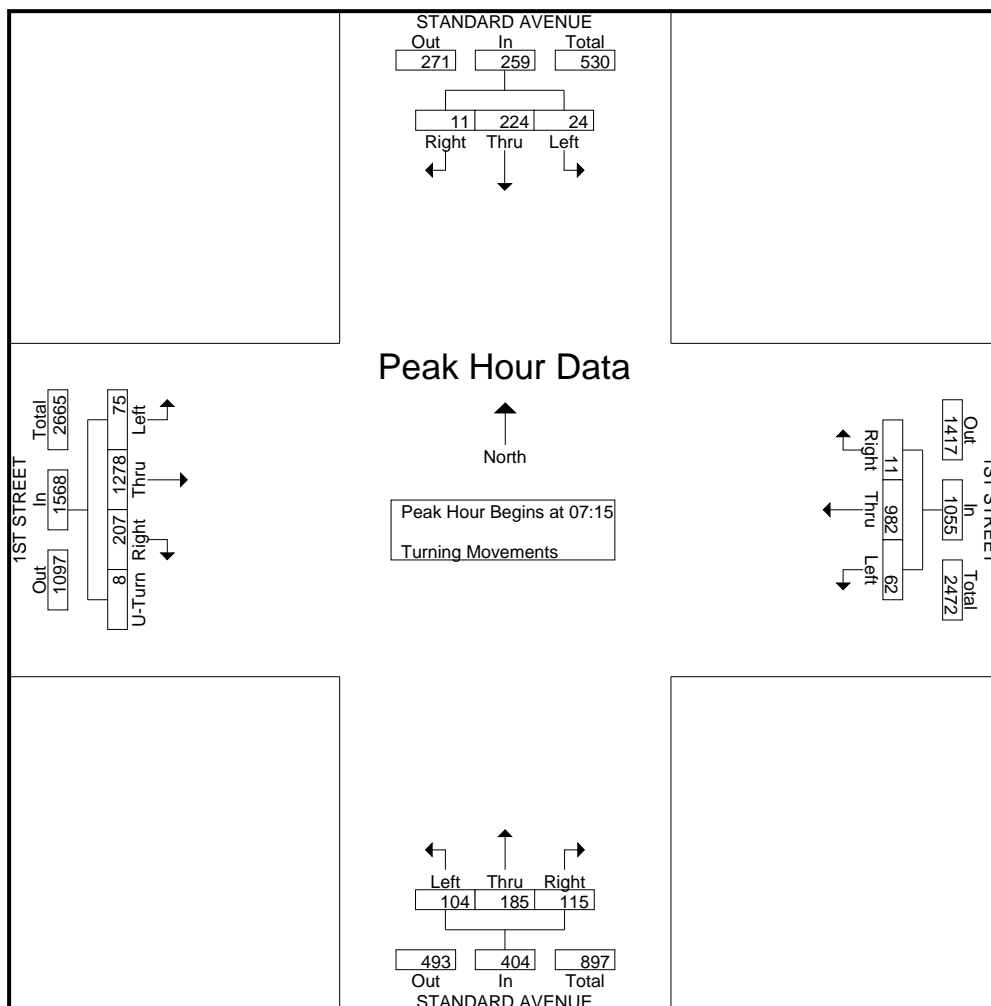

City: SANTA ANA
 N-S Direction: STANDARD AVENUE
 E-W Direction: 1ST STREET

File Name : H1702014
 Site Code : 00000000
 Start Date : 2/9/2017
 Page No : 3

Start Time	STANDARD AVENUE Southbound				1ST STREET Westbound				STANDARD AVENUE Northbound				1ST STREET Eastbound					
	Right	Thru	Left	App. Total	Right	Thru	Left	App. Total	Right	Thru	Left	App. Total	Right	Thru	Left	U-Turn	App. Total	Int. Total
17:00	8	45	9	62	6	246	24	276	51	93	35	179	30	311	24	6	371	888
17:15	2	48	2	52	4	297	21	322	13	98	49	160	37	290	42	15	384	914
17:30	5	50	3	58	7	281	24	312	28	84	56	168	24	281	33	12	350	881
17:45	7	40	4	51	3	290	19	312	28	84	56	168	24	281	33	12	350	881
Total Volume	22	183	18	223	20	1114	88	1222	115	356	179	650	125	1182	136	35	1478	3573
% App. Total	9.9	82.1	8.1		1.6	91.2	7.2		17.7	54.8	27.5		8.5	80	9.2	2.4		
PHF	.688	.915	.500	.899	.714	.938	.917	.949	.564	.908	.799	.908	.845	.950	.810	.583	.962	.977

Peak Hour Analysis From 16:00 to 17:45 - Peak 1 of 1
 Peak Hour for Entire Intersection Begins at 17:00

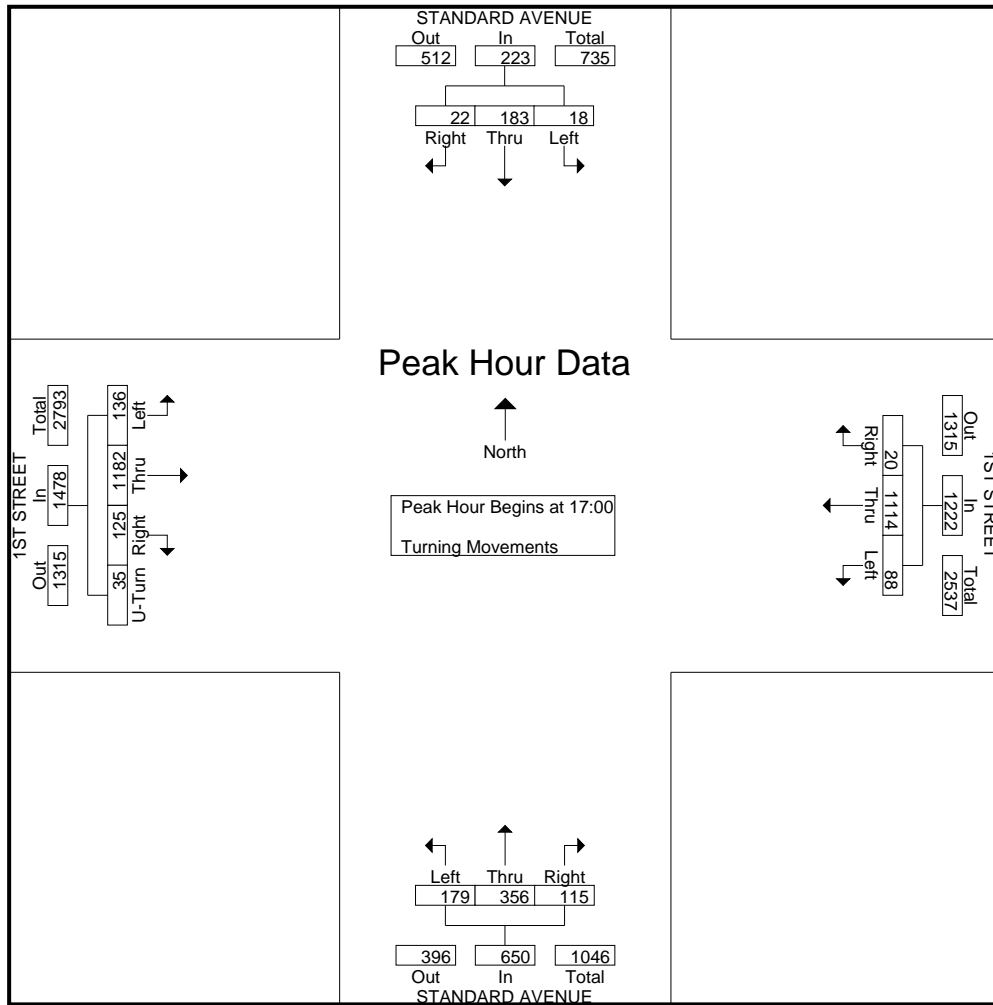

INTERSECTION TURNING MOVEMENT COUNTS

PREPARED BY: AimTD LLC. tel: 714 253 7888 cs@aimtd.com

DATE:
Tue, May 15, 18

LOCATION: Santa Ana Zed
NORTH & SOUTH: Standard
EAST & WEST: McFadden

PROJECT #: SC1791
LOCATION #: 63
CONTROL: SIGNAL

NOTES:

AM		▲	
PM		N	
MD	◀ W		E ▶
OTHER		S	
OTHER		▼	

Add U-Turns to Left Turns

LANES:	NORTHBOUND			SOUTHBOUND			EASTBOUND			WESTBOUND			TOTAL
	Standard	Standard	Standard	Standard	Standard	Standard	McFadden	McFadden	McFadden	McFadden	McFadden		
	NL	NT	NR	SL	ST	SR	EL	ET	ER	WL	WT	WR	

U-TURNS				
NB	SB	EB	WB	TTL

7:00 AM	9	50	30	49	91	6	5	131	15	18	62	9	475
7:15 AM	16	62	34	45	84	13	5	146	17	27	76	12	537
7:30 AM	18	88	35	58	153	10	3	162	21	25	80	19	672
7:45 AM	16	68	27	67	161	7	5	140	15	47	102	23	678
8:00 AM	22	60	29	45	122	6	3	129	16	36	100	26	594
8:15 AM	17	53	25	26	75	5	11	135	10	23	75	7	462
8:30 AM	16	48	18	23	57	3	7	84	12	16	51	2	337
8:45 AM	14	44	20	25	58	1	4	91	12	11	59	6	345
VOLUMES	128	473	218	338	801	51	43	1,018	118	203	605	104	4,100
APPROACH %	16%	58%	27%	28%	67%	4%	4%	86%	10%	22%	66%	11%	
APP/DEPART	819	/	620	1,190	/	1,122	1,179	/	1,574	912	/	784	0
BEGIN PEAK HR	7:15 AM												
VOLUMES	72	278	125	215	520	36	16	577	69	135	358	80	2,481
APPROACH %	15%	59%	26%	28%	67%	5%	2%	87%	10%	24%	62%	14%	
PEAK HR FACTOR	0.842			0.820			0.890			0.833			0.915
APP/DEPART	475	/	374	771	/	724	662	/	917	573	/	466	0

0	0	0	0	0
0	0	0	0	0
0	0	0	0	0
0	0	0	0	0
0	0	0	0	0
0	0	0	0	0
0	0	0	0	0
0	0	0	0	0
0	0	0	0	0
0	0	0	0	0

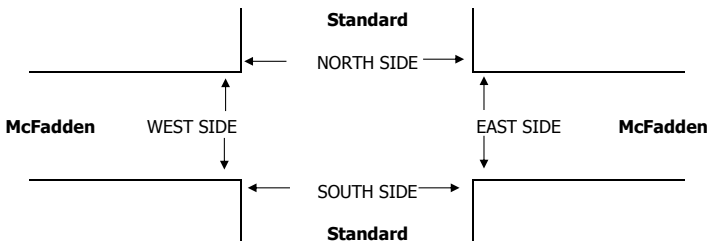

7:00 AM	
7:15 AM	
7:30 AM	
7:45 AM	
8:00 AM	
8:15 AM	
8:30 AM	
8:45 AM	
TOTAL	
AM BEGIN PEAK HR	

PEDESTRIAN + BIKE CROSSINGS				
N SIDE	S SIDE	E SIDE	W SIDE	TOTAL
9	22	18	13	62
20	26	39	10	95
19	32	25	27	103
12	43	55	29	139
8	27	24	19	78
17	19	16	13	65
7	20	13	13	53
6	13	4	8	31
98	202	194	132	626
7:15 AM				

PEDESTRIAN CROSSINGS				
N SIDE	S SIDE	E SIDE	W SIDE	TOTAL
9	19	17	9	54
19	24	37	8	88
16	31	21	23	91
10	42	51	28	131
7	26	21	19	73
16	19	15	10	60
6	19	12	11	48
5	12	3	8	28
88	192	177	116	573
52	123	130	78	383

BICYCLE CROSSINGS				
NS	SS	ES	WS	TOTAL
0	3	1	4	8
1	2	2	2	7
3	1	4	4	12
2	1	4	1	8
1	1	3	0	5
1	0	1	3	5
1	1	1	2	5
1	1	1	0	3
10	10	17	16	53

AimTD LLC
TURNING MOVEMENT COUNTS

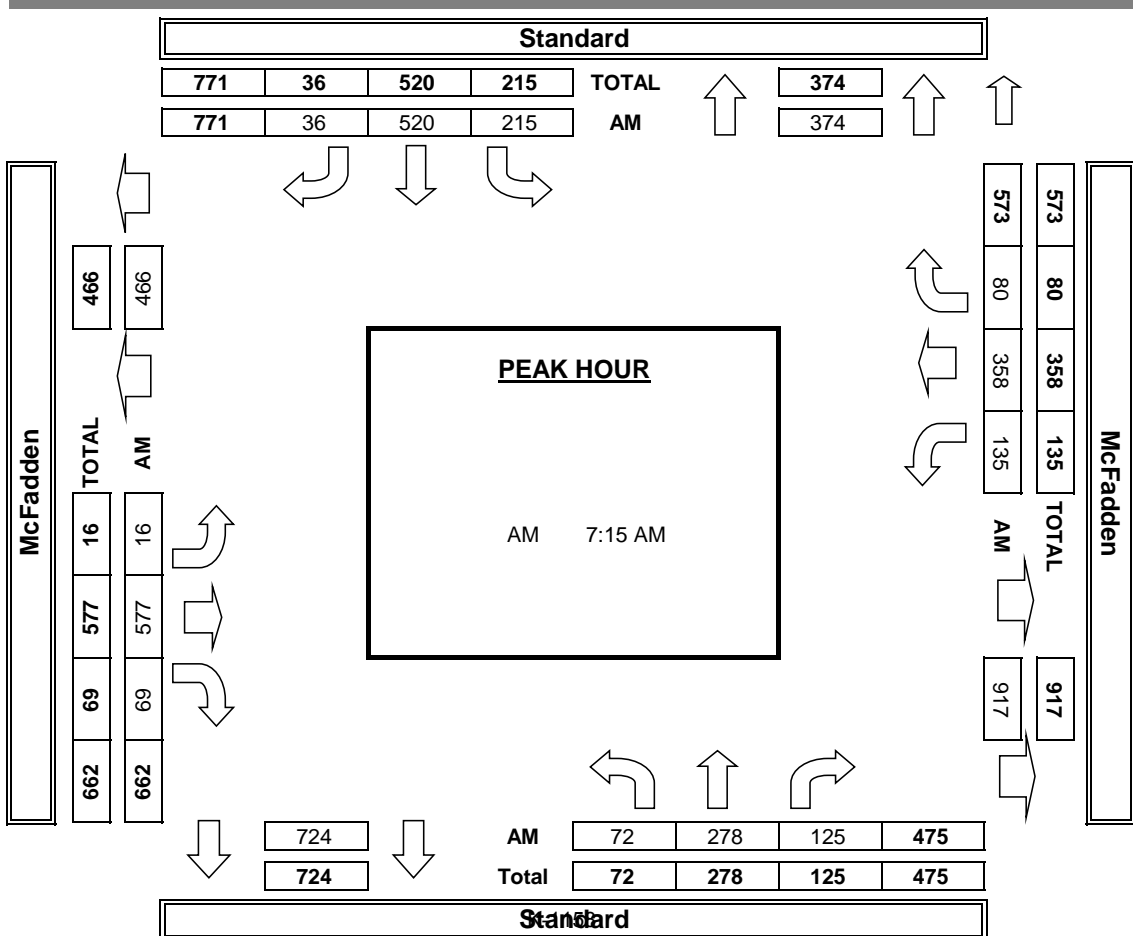
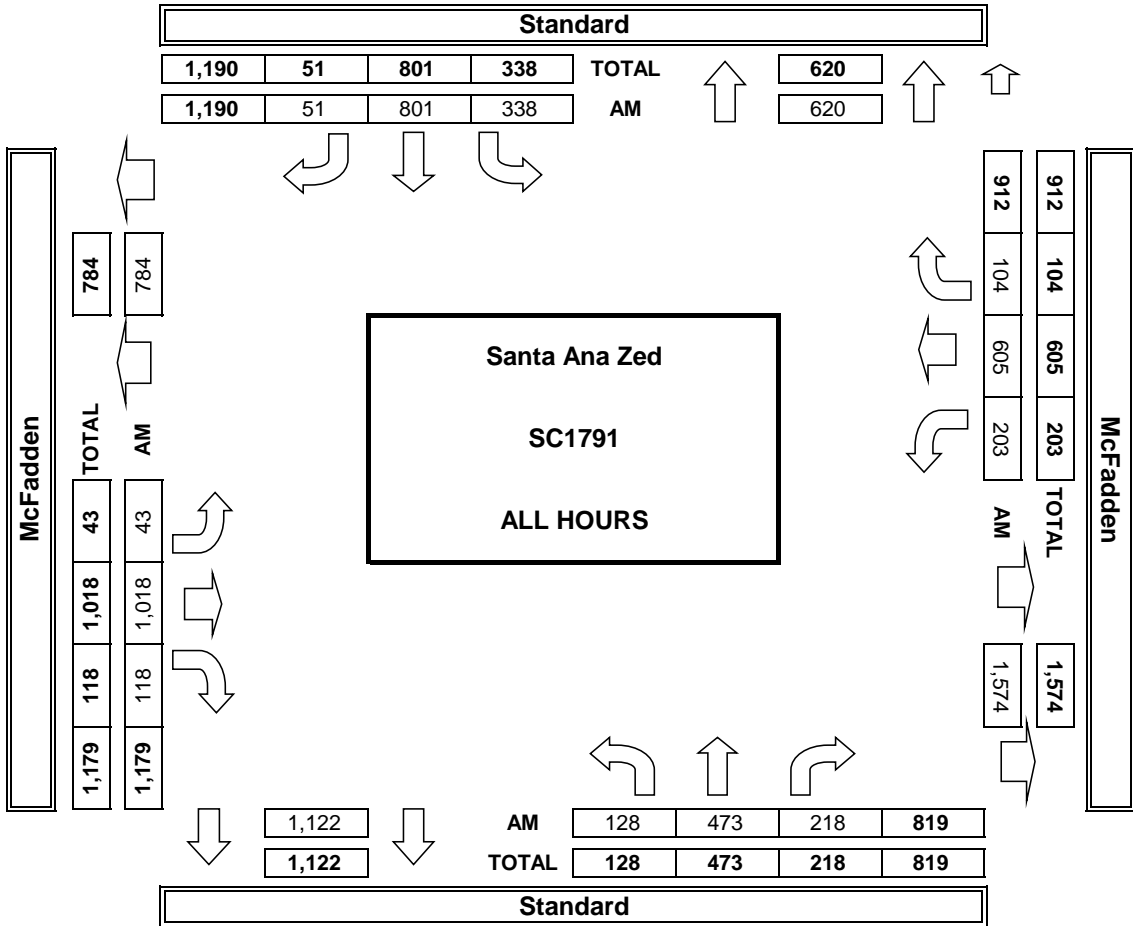

INTERSECTION TURNING MOVEMENT COUNTS

PREPARED BY: AimTD LLC. tel: 714 253 7888 cs@aimtd.com

DATE:
Tue, May 15, 18

LOCATION:
NORTH & SOUTH:
EAST & WEST: Santa Ana Zed
Standard
McFadden

PROJECT #: SC1791
LOCATION #: 63
CONTROL: SIGNAL

NOTES:

AM	▲	N	▶
PM			
MD	◀	W	▶
OTHER			
OTHER	▼	S	▶
OTHER			

Add U-Turns to Left Turns

LANES:	NORTHBOUND			SOUTHBOUND			EASTBOUND			WESTBOUND			TOTAL
	Standard	Standard	Standard	Standard	Standard	Standard	McFadden	McFadden	McFadden	McFadden	McFadden		
	NL 1	NT 2	NR 0	SL 1	ST 2	SR 0	EL 1	ET 2	ER 0	WL 1	WT 2	WR 0	

U-TURNS				
NB 0	SB 0	EB 0	WB 0	TTL

PM	NORTHBOUND			SOUTHBOUND			EASTBOUND			WESTBOUND			TOTAL
	Standard	Standard	Standard	Standard	Standard	Standard	McFadden	McFadden	McFadden	McFadden	McFadden		
2:00 PM	28	66	29	29	42	11	6	71	13	17	110	21	443
2:15 PM	19	79	21	28	57	12	9	102	16	26	100	19	488
2:30 PM	39	86	34	23	66	9	12	89	10	33	147	26	574
2:45 PM	42	111	27	33	65	12	10	99	10	43	146	31	629
3:00 PM	35	131	33	31	63	7	16	94	15	46	149	55	675
3:15 PM	38	125	28	28	53	7	5	96	14	34	124	34	586
3:30 PM	29	136	23	36	89	6	11	82	13	36	167	40	668
3:45 PM	43	146	24	38	76	6	11	83	6	36	176	46	691
VOLUMES	273	880	219	246	511	70	80	716	97	271	1,119	272	4,754
APPROACH %	20%	64%	16%	30%	62%	8%	9%	80%	11%	16%	67%	16%	
APP/DEPART	1,372	/	1,232	827	/	879	893	/	1,181	1,662	/	1,462	0
BEGIN PEAK HR	3:00 PM												
VOLUMES	145	538	108	133	281	26	43	355	48	152	616	175	2,620
APPROACH %	18%	68%	14%	30%	64%	6%	10%	80%	11%	16%	65%	19%	
PEAK HR FACTOR	0.928			0.840			0.892			0.914			0.948
APP/DEPART	791	/	756	440	/	481	446	/	596	943	/	787	0

0	0	0	0	0
0	0	0	0	0
0	0	0	0	0
0	0	0	0	0
0	0	0	0	0
0	0	0	0	0
0	0	0	0	0
0	0	0	0	0
0	0	0	0	0
0	0	0	0	0
0	0	0	0	0
0	0	0	0	0

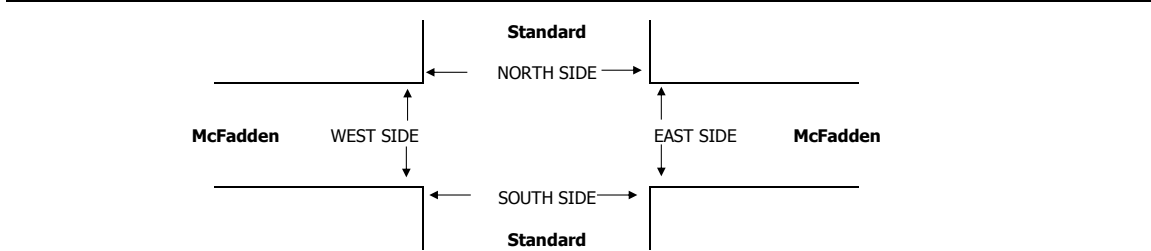

0	0	0	0	0
0	0	0	0	0
0	0	0	0	0
0	0	0	0	0
0	0	0	0	0
0	0	0	0	0
0	0	0	0	0
0	0	0	0	0
0	0	0	0	0
0	0	0	0	0
0	0	0	0	0

PM	PEDESTRIAN + BIKE CROSSINGS				
	N SIDE	S SIDE	E SIDE	W SIDE	TOTAL
2:00 PM	17	16	28	14	75
2:15 PM	26	20	29	16	91
2:30 PM	29	25	34	28	116
2:45 PM	31	47	45	21	144
3:00 PM	62	47	47	39	195
3:15 PM	43	46	49	28	166
3:30 PM	23	29	41	23	116
3:45 PM	19	17	28	8	72
TOTAL	250	247	301	177	975
AM BEGIN PEAK HR	3:00 PM				
4:00 PM	10	27	24	21	82
4:15 PM	20	30	18	22	90
4:30 PM	12	30	15	21	78
4:45 PM	21	14	18	23	76
5:00 PM	15	19	22	18	74
5:15 PM	33	23	33	26	115
5:30 PM	17	21	16	28	82
5:45 PM	17	24	21	32	94
TOTAL	145	188	167	191	691
PM BEGIN PEAK HR	5:00 PM				

PM	PEDESTRIAN CROSSINGS				
	N SIDE	S SIDE	E SIDE	W SIDE	TOTAL
2:00 PM	12	15	27	14	68
2:15 PM	26	20	29	16	91
2:30 PM	25	24	31	25	105
2:45 PM	27	45	42	19	133
3:00 PM	54	45	44	38	181
3:15 PM	40	46	49	28	163
3:30 PM	17	29	38	22	106
3:45 PM	15	15	27	7	64
TOTAL	216	239	287	169	911
AM BEGIN PEAK HR	3:00 PM				
4:00 PM	10	26	24	19	79
4:15 PM	15	29	17	18	79
4:30 PM	10	29	15	18	72
4:45 PM	16	14	13	20	63
5:00 PM	12	18	22	17	69
5:15 PM	29	22	30	23	104
5:30 PM	15	16	15	21	67
5:45 PM	15	16	20	29	80
TOTAL	122	170	156	165	613
PM BEGIN PEAK HR	5:00 PM				
4:00 PM	71	72	87	90	320

PM	BICYCLE CROSSINGS				
	NS	SS	ES	WS	TOTAL
2:00 PM	5	1	1	0	7
2:15 PM	0	0	0	0	0
2:30 PM	4	1	3	3	11
2:45 PM	4	2	3	2	11
3:00 PM	8	2	3	1	14
3:15 PM	3	0	0	0	3
3:30 PM	6	0	3	1	10
3:45 PM	4	2	1	1	8
TOTAL	34	8	14	8	64
AM BEGIN PEAK HR	3:00 PM				
4:00 PM	0	1	0	2	3
4:15 PM	5	1	1	4	11
4:30 PM	2	1	0	3	6
4:45 PM	5	0	5	3	13
5:00 PM	3	1	0	1	5
5:15 PM	4	1	3	3	11
5:30 PM	2	5	1	7	15
5:45 PM	2	8	1	3	14
TOTAL	23	18	11	26	78
PM BEGIN PEAK HR	5:00 PM				
4:00 PM	71	72	87	90	320

AimTD LLC
TURNING MOVEMENT COUNTS

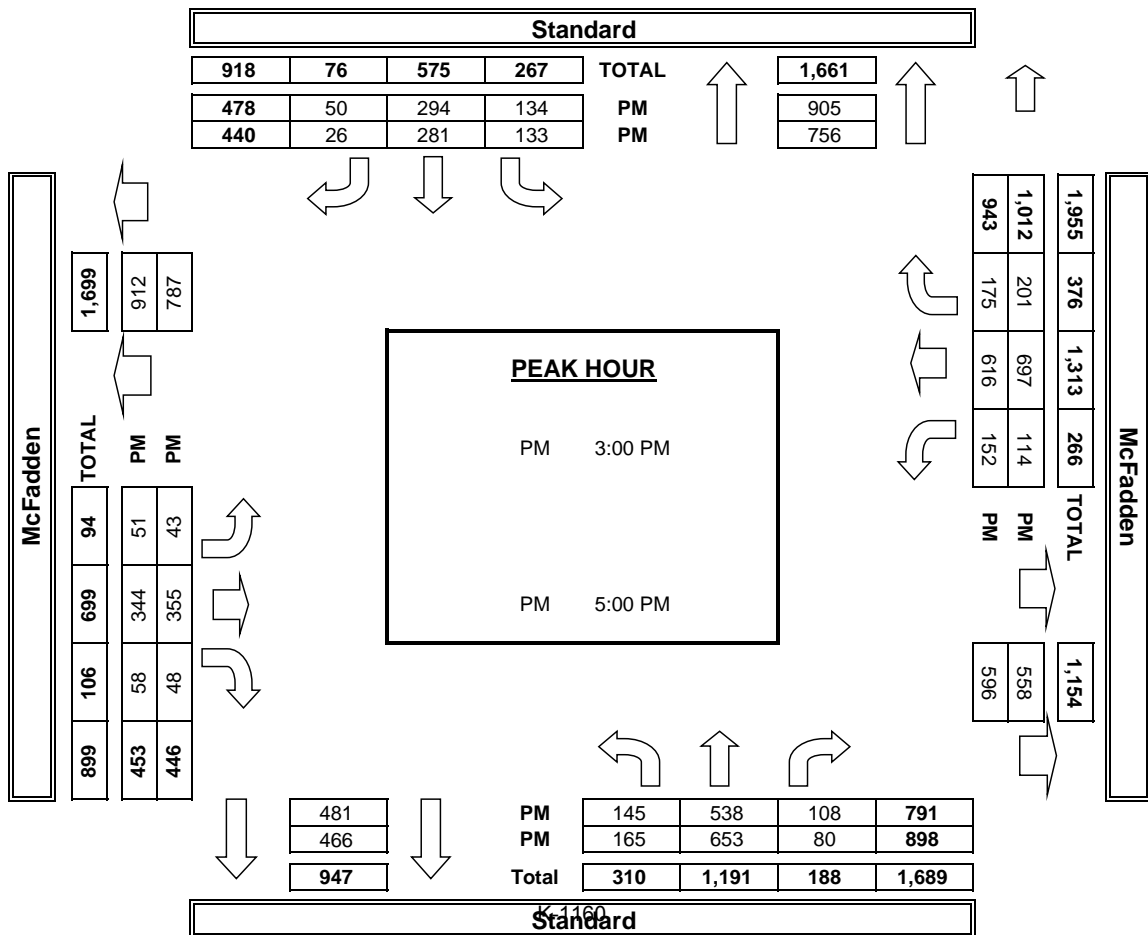
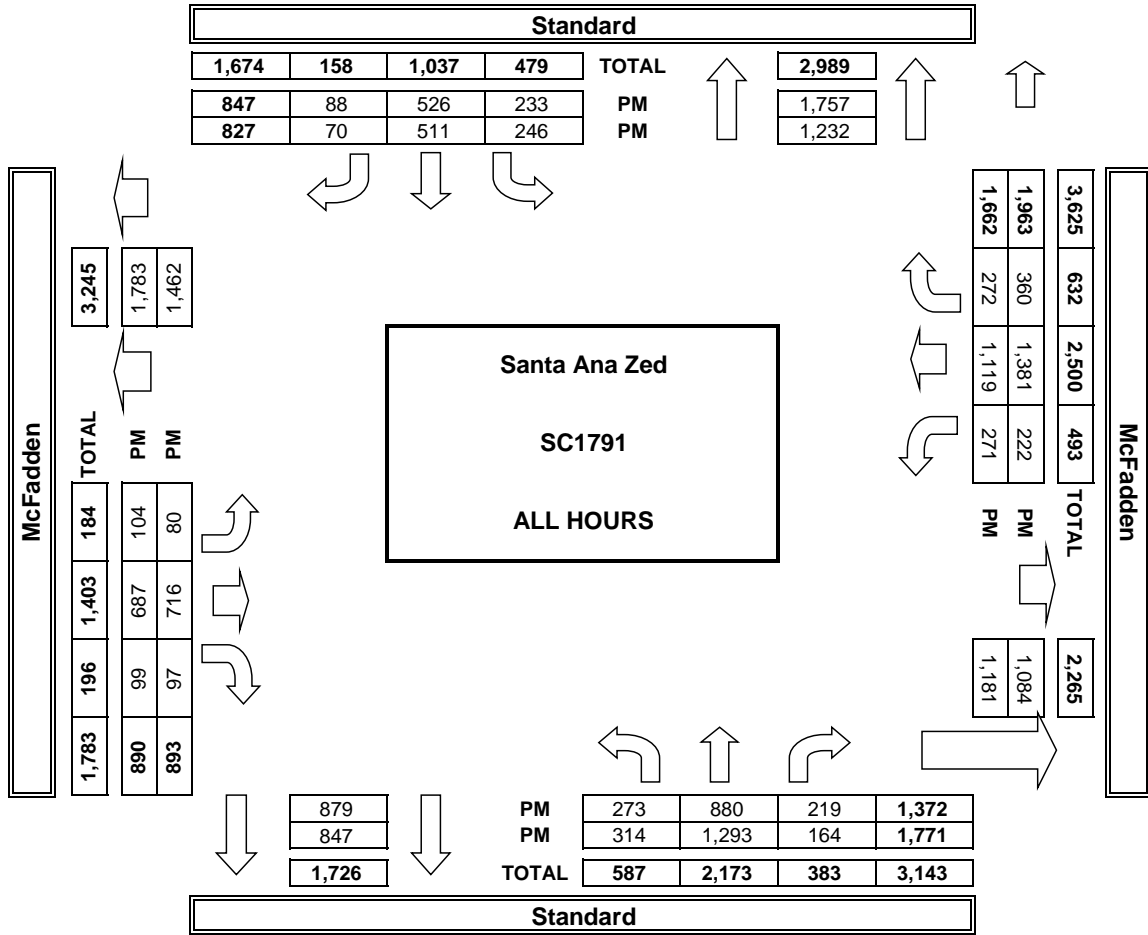

INTERSECTION TURNING MOVEMENT COUNTS

PREPARED BY: AimTD LLC. tel: 714 253 7888 pacific@aimtd.com

DATE:
Tue, Feb 9, 16

LOCATION: Santa Ana
NORTH & SOUTH: Halladay
EAST & WEST: Warner

PROJECT #: SC0846
LOCATION #: 44
CONTROL: SIGNAL

NOTES:	AM	PM	MD	OTHER	OTHER	▲ N ▼	◀ W E ▶
--------	----	----	----	-------	-------	-------------	------------

Add U-Turns to Left Turns

LANES:	NORTHBOUND			SOUTHBOUND			EASTBOUND			WESTBOUND			TOTAL
	NL	NT	NR	SL	ST	SR	EL	ET	ER	WL	WT	WR	
	1	X	1	X	X	X	X	2	0	0	2	X	

U-TURNS				
NB	SB	EB	WB	TTL
0	0	0	0	0

AM	7:00 AM	13	0	6	0	0	0	0	247	29	18	151	0	464
	7:15 AM	10	0	24	0	0	0	0	293	28	36	139	0	530
	7:30 AM	14	0	24	0	0	0	0	308	46	39	181	0	612
	7:45 AM	10	0	22	0	0	0	0	323	42	45	146	0	588
	8:00 AM	7	0	26	0	0	0	0	308	23	33	117	0	514
	8:15 AM	7	0	21	0	0	0	0	298	17	24	114	0	481
	8:30 AM	12	0	24	0	0	0	0	245	22	16	134	0	453
	8:45 AM	14	0	26	0	0	0	0	188	14	24	132	0	398

0	0	0	0	0
0	0	0	0	0
0	0	0	0	0
0	0	0	0	0
0	0	0	0	0
0	0	0	0	0
0	0	0	0	0
0	0	0	0	0

VOLUMES	87	0	173	0	0	0	0	2,210	221	235	1,114	0	4,040
APPROACH %	33%	0%	67%	0%	0%	0%	0%	91%	9%	17%	83%	0%	
APP/DEPART	260	/	0	0	/	456	2,431	/	2,383	1,349	/	1,201	0
BEGIN PEAK HR	7:15 AM												
VOLUMES	41	0	96	0	0	0	0	1,232	139	153	583	0	2,244
APPROACH %	30%	0%	70%	0%	0%	0%	0%	90%	10%	21%	79%	0%	
PEAK HR FACTOR	0.901			0.000			0.939			0.836			0.917
APP/DEPART	137	/	0	0	/	292	1,371	/	1,328	736	/	624	0

0	0	0	0	0
0	0	0	0	0
0	0	0	0	0
0	0	0	0	0
0	0	1	0	1
0	0	0	0	0
0	0	0	0	0
0	0	0	0	0
0	0	0	0	0
0	0	1	0	1

PM	4:00 PM	39	0	75	0	0	0	0	197	12	26	236	0	585
	4:15 PM	29	0	80	0	0	0	0	204	17	22	211	0	563
	4:30 PM	35	0	81	0	0	0	0	219	22	26	270	0	653
	4:45 PM	32	0	70	0	0	0	1	205	11	32	244	0	595
	5:00 PM	44	0	84	0	0	0	0	210	20	30	295	0	683
	5:15 PM	51	0	103	0	0	0	0	255	36	47	268	0	760
	5:30 PM	38	0	83	0	0	0	0	204	25	41	231	0	622
	5:45 PM	30	0	85	0	0	0	0	202	24	37	217	0	595
VOLUMES	298	0	661	0	0	0	1	1,696	167	261	1,972	0	5,056	
APPROACH %	31%	0%	69%	0%	0%	0%	0%	91%	9%	12%	88%	0%		
APP/DEPART	959	/	0	0	/	428	1,864	/	2,357	2,233	/	2,271	0	
BEGIN PEAK HR	4:30 PM													
VOLUMES	162	0	338	0	0	0	1	889	89	135	1,077	0	2,691	
APPROACH %	32%	0%	68%	0%	0%	0%	0%	91%	9%	11%	89%	0%		
PEAK HR FACTOR	0.812			0.000			0.841			0.932			0.885	
APP/DEPART	500	/	0	0	/	224	979	/	1,227	1,212	/	1,240	0	

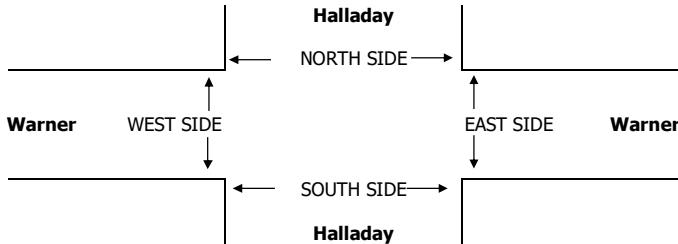

AM	7:00 AM	0	0	0	8	8
	7:15 AM	0	1	0	2	3
	7:30 AM	1	1	0	1	3
	7:45 AM	0	0	0	2	2
	8:00 AM	0	3	0	2	5
	8:15 AM	0	0	0	5	5
	8:30 AM	0	1	0	1	2
	8:45 AM	0	0	0	7	7
TOTAL	1	6	0	28	35	
PM	4:00 PM	0	1	0	5	6
	4:15 PM	0	1	0	4	5
	4:30 PM	0	0	0	7	7
	4:45 PM	1	0	0	6	7
	5:00 PM	0	2	0	9	11
	5:15 PM	0	1	0	16	17
	5:30 PM	0	0	0	5	5
	5:45 PM	0	2	0	2	4
TOTAL	1	7	0	54	62	

PEDESTRIAN + BIKE CROSSINGS				
N SIDE	S SIDE	E SIDE	W SIDE	TOTAL
0	0	0	8	8
0	1	0	2	3
1	1	0	1	3
0	0	0	2	2
0	3	0	2	5
0	0	0	5	5
0	1	0	1	2
0	0	0	7	7
1	6	0	28	35
0	1	0	5	6
0	1	0	4	5
0	0	0	7	7
1	0	0	6	7
0	2	0	9	11
0	1	0	16	17
0	0	0	5	5
0	2	0	2	4
1	7	0	54	62

PEDESTRIAN CROSSINGS				
N SIDE	S SIDE	E SIDE	W SIDE	TOTAL
0	0	0	8	8
0	1	0	2	3
0	1	0	1	2
0	0	0	2	2
0	2	0	2	4
0	0	0	4	4
0	0	0	1	1
0	0	0	7	7
0	4	0	27	31
0	0	0	5	5
0	1	0	3	4
0	0	0	6	6
0	0	0	2	2
0	2	0	8	10
0	0	0	15	15
0	0	0	4	4
0	1	0	2	3
0	4	0	45	49

BICYCLE CROSSINGS				
NS	SS	ES	WS	TOTAL
0	0	0	0	0
0	0	0	0	0
1	0	0	0	1
0	0	0	0	0
0	1	0	0	1
0	0	0	1	1
0	1	0	0	1
0	0	0	1	1
0	1	0	1	2
0	0	0	1	1
0	1	0	0	1
1	2	0	1	4
0	1	0	0	1
0	0	0	1	1
0	0	0	1	1
0	0	0	1	1
0	1	0	0	1
1	3	0	9	13

INTERSECTION TURNING MOVEMENT COUNTS

PREPARED BY: AimTD LLC. tel: 714 253 7888 cs@aimtd.com

T218

DATE:
Tue, May 14, 19

LOCATION: Santa Ana
NORTH & SOUTH: Halladay
EAST & WEST: Dyer

PROJECT #: SC2183
LOCATION #: 21
CONTROL: SIGNAL

NOTES:

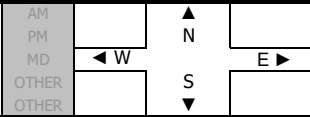

	NORTHBOUND			SOUTHBOUND			EASTBOUND			WESTBOUND			TOTAL
	Halladay			Halladay			Dyer			Dyer			
LANES:	NL	NT	NR	SL	ST	SR	EL	ET	ER	WL	WT	WR	
AM													
7:00 AM	1	4	14	37	8	9	2	266	1	25	152	33	552
7:15 AM	1	3	14	44	5	8	9	334	5	33	147	33	636
7:30 AM	1	4	8	51	8	13	11	363	0	20	175	26	680
7:45 AM	4	5	10	43	9	7	9	358	2	20	161	21	649
8:00 AM	4	5	16	43	14	10	11	306	2	40	136	20	607
8:15 AM	2	6	12	52	14	8	5	290	3	41	149	19	601
8:30 AM	3	5	8	46	8	6	4	288	7	34	140	18	567
8:45 AM	0	3	12	35	14	9	6	235	6	27	148	18	513
VOLUMES	16	35	94	351	80	70	57	2,440	26	240	1,208	188	4,805
APPROACH %	11%	24%	65%	70%	16%	14%	2%	97%	1%	15%	74%	11%	
APP/DEPART	145	/	280	501	/	344	2,523	/	2,887	1,636	/	1,294	0
BEGIN PEAK HR	7:15 AM												
VOLUMES	10	17	48	181	36	38	40	1,361	9	113	619	100	2,572
APPROACH %	13%	23%	64%	71%	14%	15%	3%	97%	1%	14%	74%	12%	
PEAK HR FACTOR	0.750			0.885			0.943			0.941			0.946
APP/DEPART	75	/	157	255	/	158	1,410	/	1,590	832	/	667	0
PM													
4:00 PM	5	43	50	37	3	12	21	287	0	14	280	21	773
4:15 PM	7	37	56	33	6	10	31	281	4	19	312	25	821
4:30 PM	15	36	56	35	3	10	43	335	1	12	362	26	934
4:45 PM	8	32	51	26	3	4	30	308	1	11	331	34	839
5:00 PM	15	61	56	28	5	11	34	338	4	14	333	30	929
5:15 PM	2	49	42	23	3	6	41	304	2	7	410	24	913
5:30 PM	7	44	46	27	8	3	37	337	2	15	345	40	911
5:45 PM	3	48	45	20	9	10	35	320	1	15	298	32	836
VOLUMES	62	350	402	229	40	66	272	2,510	15	107	2,671	232	6,956
APPROACH %	8%	43%	49%	68%	12%	20%	10%	90%	1%	4%	89%	8%	
APP/DEPART	814	/	854	335	/	158	2,797	/	3,145	3,010	/	2,799	0
BEGIN PEAK HR	4:30 PM												
VOLUMES	40	178	205	112	14	31	148	1,285	8	44	1,436	114	3,615
APPROACH %	9%	42%	48%	71%	9%	20%	10%	89%	1%	3%	90%	7%	
PEAK HR FACTOR	0.801			0.818			0.951			0.904			0.968
APP/DEPART	423	/	440	157	/	65	1,441	/	1,603	1,594	/	1,507	0

U-TURNS				
NB	SB	EB	WB	TTL
0	0	0	0	0
0	0	0	0	0
0	0	0	0	0
0	0	0	0	0
0	0	0	0	0
0	0	0	1	1
0	0	0	1	1
0	0	0	0	0
0	0	0	2	2

0	0	0	1	1
0	0	0	1	1
0	0	0	0	0
0	0	0	0	0
0	0	0	1	1
0	0	0	0	0
0	0	0	0	0
0	0	0	1	1
0	0	0	4	4

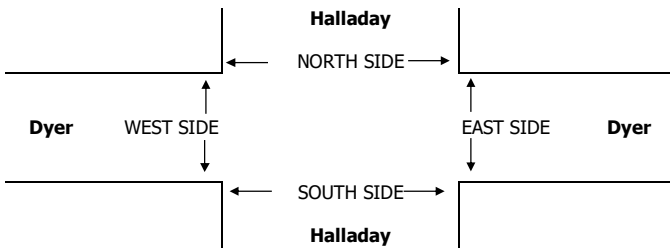

	PEDESTRIAN + BIKE CROSSINGS				
	N SIDE	S SIDE	E SIDE	W SIDE	TOTAL
AM					
7:00 AM	0	0	0	0	0
7:15 AM	0	0	0	0	0
7:30 AM	0	0	0	0	0
7:45 AM	0	0	0	0	0
8:00 AM	0	0	0	0	0
8:15 AM	0	0	0	0	0
8:30 AM	0	0	0	0	0
8:45 AM	0	0	0	0	0
TOTAL	0	0	0	0	0
AM BEGIN PEAK HR	7:15 AM				
4:00 PM	0	0	0	0	0
4:15 PM	0	0	0	0	0
4:30 PM	0	0	0	0	0
4:45 PM	0	0	0	0	0
5:00 PM	0	0	0	0	0
5:15 PM	0	0	0	0	0
5:30 PM	0	0	0	0	0
5:45 PM	0	0	0	0	0
TOTAL	0	0	0	0	0
PM BEGIN PEAK HR	4:30 PM				

	PEDESTRIAN CROSSINGS				
	N SIDE	S SIDE	E SIDE	W SIDE	TOTAL
AM					
7:00 AM	0	0	0	0	0
7:15 AM	0	0	0	0	0
7:30 AM	0	0	0	0	0
7:45 AM	0	0	0	0	0
8:00 AM	0	0	0	0	0
8:15 AM	0	0	0	0	0
8:30 AM	0	0	0	0	0
8:45 AM	0	0	0	0	0
TOTAL	0	0	0	0	0
AM BEGIN PEAK HR	7:15 AM				
4:00 PM	0	0	0	0	0
4:15 PM	0	0	0	0	0
4:30 PM	0	0	0	0	0
4:45 PM	0	0	0	0	0
5:00 PM	0	0	0	0	0
5:15 PM	0	0	0	0	0
5:30 PM	0	0	0	0	0
5:45 PM	0	0	0	0	0
TOTAL	0	0	0	0	0
PM BEGIN PEAK HR	4:30 PM				

	BICYCLE CROSSINGS				
	NS	SS	ES	WS	TOTAL
AM					
7:00 AM	0	0	0	0	0
7:15 AM	0	0	0	0	0
7:30 AM	0	0	0	0	0
7:45 AM	0	0	0	0	0
8:00 AM	0	0	0	0	0
8:15 AM	0	0	0	0	0
8:30 AM	0	0	0	0	0
8:45 AM	0	0	0	0	0
TOTAL	0	0	0	0	0
AM BEGIN PEAK HR	7:15 AM				
4:00 PM	0	0	0	0	0
4:15 PM	0	0	0	0	0
4:30 PM	0	0	0	0	0
4:45 PM	0	0	0	0	0
5:00 PM	0	0	0	0	0
5:15 PM	0	0	0	0	0
5:30 PM	0	0	0	0	0
5:45 PM	0	0	0	0	0
TOTAL	0	0	0	0	0
PM BEGIN PEAK HR	4:30 PM				

INTERSECTION TURNING MOVEMENT COUNTS

PREPARED BY: AimTD LLC. tel: 714 253 7888 cs@aimtd.com

DATE:
Tue, May 14, 19

LOCATION: Santa Ana
NORTH & SOUTH: SR-55 SB Ramps
EAST & WEST: MacArthur

PROJECT #: SC2183
LOCATION #: 23
CONTROL: SIGNAL

NOTES:

PM WB queue

AM		▲	
PM		N	
MD	← W		E →
OTHER		S	
OTHER		▼	

Add U-Turns to Left Turns

	NORTHBOUND			SOUTHBOUND			EASTBOUND			WESTBOUND			TOTAL
	SR-55 SB Ramps			SR-55 SB Ramps			MacArthur			MacArthur			
LANES:	NL	NT	NR	SL	ST	SR	EL	ET	ER	WL	WT	WR	
	X	X	X	2	X	2	X	3	2	X	3	1	
AM													
7:00 AM	0	0	0	236	0	222	0	299	232	0	239	22	1,250
7:15 AM	0	0	0	233	0	229	0	324	267	0	246	33	1,332
7:30 AM	0	0	0	208	0	215	0	397	280	0	305	31	1,436
7:45 AM	0	0	0	256	0	229	0	378	246	0	318	38	1,465
8:00 AM	0	0	0	242	0	209	0	342	238	0	314	39	1,384
8:15 AM	0	0	0	245	0	208	0	309	252	0	325	35	1,374
8:30 AM	0	0	0	204	0	144	0	339	250	0	277	55	1,269
8:45 AM	0	0	0	237	0	165	0	287	197	0	248	64	1,198
VOLUMES	0	0	0	1,861	0	1,621	0	2,675	1,962	0	2,272	317	10,708
APPROACH %	0%	0%	0%	53%	0%	47%	0%	58%	42%	0%	88%	12%	
APP/DEPART	0	/	317	3,482	/	1,962	4,637	/	4,536	2,589	/	3,893	0
BEGIN PEAK HR	7:30 AM												
VOLUMES	0	0	0	951	0	861	0	1,426	1,016	0	1,262	143	5,659
APPROACH %	0%	0%	0%	52%	0%	48%	0%	58%	42%	0%	90%	10%	
PEAK HR FACTOR	0.000			0.934									
APP/DEPART	0	/	143	1,812	/	1,016	2,442	/	2,377	1,405	/	2,123	0
PM													
4:00 PM	0	0	0	62	0	132	0	326	263	0	389	160	1,332
4:15 PM	0	0	0	71	0	187	0	275	234	0	357	148	1,272
4:30 PM	0	0	0	74	0	170	0	277	269	0	415	153	1,358
4:45 PM	0	0	0	69	0	176	0	274	239	0	366	133	1,257
5:00 PM	0	0	0	63	0	166	0	319	282	0	370	178	1,378
5:15 PM	0	0	0	79	0	178	0	285	239	0	365	132	1,278
5:30 PM	0	0	0	61	0	180	0	291	206	0	370	125	1,233
5:45 PM	0	0	0	93	0	171	0	245	187	0	350	105	1,151
VOLUMES	0	0	0	572	0	1,360	0	2,292	1,919	0	2,982	1,134	10,259
APPROACH %	0%	0%	0%	30%	0%	70%	0%	54%	46%	0%	72%	28%	
APP/DEPART	0	/	1,134	1,932	/	1,919	4,211	/	2,864	4,116	/	4,342	0
BEGIN PEAK HR	4:30 PM												
VOLUMES	0	0	0	285	0	690	0	1,155	1,029	0	1,516	596	5,271
APPROACH %	0%	0%	0%	29%	0%	71%	0%	53%	47%	0%	72%	28%	
PEAK HR FACTOR	0.000			0.948									
APP/DEPART	0	/	596	975	/	1,029	2,184	/	1,440	2,112	/	2,206	0

U-TURNS				
NB	SB	EB	WB	TTL
0	0	0	0	0
0	0	0	0	0
0	0	0	0	0
0	0	0	0	0
0	0	0	0	0
0	0	0	0	0
0	0	0	0	0
0	0	0	0	0
0	0	0	0	0
0	0	0	0	0
0	0	0	0	0

0	0	0	0	0
0	0	0	0	0
0	0	0	0	0
0	0	0	0	0
0	0	0	0	0
0	0	0	0	0
0	0	0	0	0
0	0	0	0	0
0	0	0	0	0
0	0	0	0	0
0	0	0	0	0
0	0	0	0	0

0	0	0	0	0
0	0	0	0	0
0	0	0	0	0
0	0	0	0	0
0	0	0	0	0
0	0	0	0	0
0	0	0	0	0
0	0	0	0	0
0	0	0	0	0
0	0	0	0	0
0	0	0	0	0
0	0	0	0	0

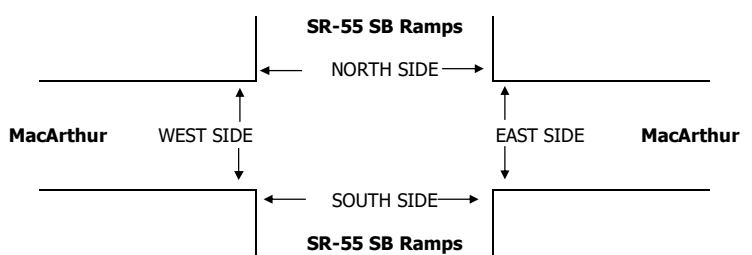

		PEDESTRIAN + BIKE CROSSINGS				
		N SIDE	S SIDE	E SIDE	W SIDE	TOTAL
AM	7:00 AM	0	0	0	0	0
	7:15 AM	0	0	0	0	0
	7:30 AM	0	0	0	0	0
	7:45 AM	0	0	0	0	0
	8:00 AM	0	0	0	0	0
	8:15 AM	0	0	0	0	0
	8:30 AM	0	0	0	0	0
	8:45 AM	0	0	0	0	0
	TOTAL		0	0	0	0
AM BEGIN PEAK HR		7:30 AM				
PM	4:00 PM	0	0	0	0	0
	4:15 PM	0	0	0	0	0
	4:30 PM	0	0	0	0	0
	4:45 PM	0	0	0	0	0
	5:00 PM	0	0	0	0	0
	5:15 PM	0	0	0	0	0
	5:30 PM	0	0	0	0	0
	5:45 PM	0	0	0	0	0
	TOTAL		0	0	0	0
PM BEGIN PEAK HR		4:30 PM				

		PEDESTRIAN CROSSINGS				
		N SIDE	S SIDE	E SIDE	W SIDE	TOTAL
AM	7:00 AM	0	0	0	0	0
	7:15 AM	0	0	0	0	0
	7:30 AM	0	0	0	0	0
	7:45 AM	0	0	0	0	0
	8:00 AM	0	0	0	0	0
	8:15 AM	0	0	0	0	0
	8:30 AM	0	0	0	0	0
	8:45 AM	0	0	0	0	0
	TOTAL		0	0	0	0
AM BEGIN PEAK HR		7:30 AM				
PM	4:00 PM	0	0	0	0	0
	4:15 PM	0	0	0	0	0
	4:30 PM	0	0	0	0	0
	4:45 PM	0	0	0	0	0
	5:00 PM	0	0	0	0	0
	5:15 PM	0	0	0	0	0
	5:30 PM	0	0	0	0	0
	5:45 PM	0	0	0	0	0
	TOTAL		0	0	0	0
PM BEGIN PEAK HR		4:30 PM				

		BICYCLE CROSSINGS				
		NS	SS	ES	WS	TOTAL
AM	7:00 AM	0	0	0	0	0
	7:15 AM	0	0	0	0	0
	7:30 AM	0	0	0	0	0
	7:45 AM	0	0	0	0	0
	8:00 AM	0	0	0	0	0
	8:15 AM	0	0	0	0	0
	8:30 AM	0	0	0	0	0
	8:45 AM	0	0	0	0	0
	TOTAL		0	0	0	0
AM BEGIN PEAK HR		7:30 AM				
PM	4:00 PM	0	0	0	0	0
	4:15 PM	0	0	0	0	0
	4:30 PM	0	0	0	0	0
	4:45 PM	0	0	0	0	0
	5:00 PM	0	0	0	0	0
	5:15 PM	0	0	0	0	0
	5:30 PM	0	0	0	0	0
	5:45 PM	0	0	0	0	0
	TOTAL		0	0	0	0
PM BEGIN PEAK HR		4:30 PM				

INTERSECTION TURNING MOVEMENT COUNTS

PREPARED BY: AimTD LLC. tel: 714 253 7888 cs@aimtd.com

DATE:
Tue, May 14, 19

LOCATION:
NORTH & SOUTH: Santa Ana
EAST & WEST: SR-55 NB Ramps
MacArthur

PROJECT #: SC2183
LOCATION #: 22
CONTROL: SIGNAL

NOTES:

PM WB queue

AM
PM
MD
OTHER
OTHER

▲
N

← W E →

▼
S

Add U-Turns to Left Turns

	NORTHBOUND <small>SR-55 NB Ramps</small>			SOUTHBOUND <small>SR-55 NB Ramps</small>			EASTBOUND <small>MacArthur</small>			WESTBOUND <small>MacArthur</small>			TOTAL
	NL	NT	NR	SL	ST	SR	EL	ET	ER	WL	WT	WR	
LANES:	2	X	1	X	X	X	X	2	2	X	3	1	
7:00 AM	183	0	210	0	0	0	0	388	146	0	75	55	1,057
7:15 AM	188	0	207	0	0	0	0	365	193	0	88	48	1,089
7:30 AM	232	0	201	0	0	0	0	374	237	0	106	48	1,198
7:45 AM	215	0	264	0	0	0	0	423	219	0	142	62	1,325
8:00 AM	233	0	239	0	0	0	0	399	183	0	118	68	1,240
8:15 AM	219	0	262	0	0	0	0	397	149	0	145	63	1,235
8:30 AM	209	0	203	0	0	0	0	366	182	0	130	66	1,156
8:45 AM	176	0	247	0	0	0	0	374	146	0	134	74	1,151
VOLUMES	1,655	0	1,833	0	0	0	0	3,086	1,455	0	938	484	9,451
APPROACH %	47%	0%	53%	0%	0%	0%	0%	68%	32%	0%	66%	34%	
APP/DEPART	3,488	/	484	0	/	1,455	4,541	/	4,919	1,422	/	2,593	0
BEGIN PEAK HR	7:30 AM												
VOLUMES	899	0	966	0	0	0	0	1,593	788	0	511	241	4,998
APPROACH %	48%	0%	52%	0%	0%	0%	0%	67%	33%	0%	68%	32%	
PEAK HR FACTOR	0.969			0.000			0.927			0.904			0.943
APP/DEPART	1,865	/	241	0	/	788	2,381	/	2,559	752	/	1,410	0
4:00 PM	164	0	132	0	0	0	0	178	215	0	391	248	1,328
4:15 PM	144	0	122	0	0	0	0	183	160	0	355	271	1,235
4:30 PM	167	0	77	0	0	0	0	178	171	0	404	267	1,264
4:45 PM	159	0	90	0	0	0	0	164	177	0	336	284	1,210
5:00 PM	131	0	67	0	0	0	0	211	175	0	419	273	1,276
5:15 PM	160	0	70	0	0	0	0	206	160	0	336	227	1,159
5:30 PM	158	0	110	0	0	0	0	235	121	0	338	214	1,176
5:45 PM	152	0	93	0	0	0	0	181	151	0	297	218	1,092
VOLUMES	1,235	0	761	0	0	0	0	1,536	1,330	0	2,876	2,002	9,741
APPROACH %	62%	0%	38%	0%	0%	0%	0%	54%	46%	0%	59%	41%	
APP/DEPART	1,996	/	2,002	0	/	1,330	2,867	/	2,297	4,878	/	4,112	0
BEGIN PEAK HR	4:00 PM												
VOLUMES	634	0	421	0	0	0	0	703	723	0	1,486	1,070	5,038
APPROACH %	60%	0%	40%	0%	0%	0%	0%	49%	51%	0%	58%	42%	
PEAK HR FACTOR	0.891			0.000			0.908			0.952			0.948
APP/DEPART	1,055	/	1,070	0	/	723	1,427	/	1,124	2,556	/	2,121	0

U-TURNS				
NB	SB	EB	WB	TTL
0	0	0	0	0
0	0	0	0	0
0	0	0	0	0
0	0	0	0	0
0	0	0	0	0
0	0	0	0	0
0	0	0	0	0
0	0	0	0	0
0	0	0	0	0
0	0	0	0	0
0	0	0	0	0
0	0	0	0	0
0	0	0	0	0

0	0	0	0	0
0	0	1	0	1
0	0	0	0	0
0	0	0	0	0
0	0	0	0	0
0	0	0	0	0
0	0	0	0	0
0	0	0	0	0
0	0	0	0	0
0	0	0	0	0
0	0	1	0	1

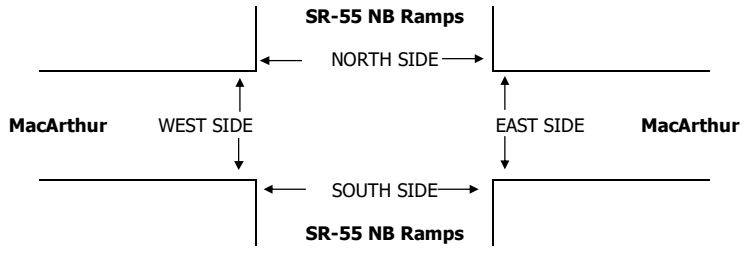

	PEDESTRIAN + BIKE CROSSINGS				
	N SIDE	S SIDE	E SIDE	W SIDE	TOTAL
7:00 AM	0	0	0	0	0
7:15 AM	0	0	0	0	0
7:30 AM	0	0	0	0	0
7:45 AM	0	0	0	0	0
8:00 AM	0	0	0	0	0
8:15 AM	0	0	0	0	0
8:30 AM	0	0	0	0	0
8:45 AM	0	0	0	0	0
TOTAL	0	0	0	0	0
AM BEGIN PEAK HR	7:30 AM				
4:00 PM	0	0	0	0	0
4:15 PM	0	0	0	0	0
4:30 PM	0	0	0	0	0
4:45 PM	0	0	0	0	0
5:00 PM	0	0	0	0	0
5:15 PM	0	0	0	0	0
5:30 PM	0	0	0	0	0
5:45 PM	0	0	0	0	0
TOTAL	0	0	0	0	0
PM BEGIN PEAK HR	4:00 PM				

	PEDESTRIAN CROSSINGS				
	N SIDE	S SIDE	E SIDE	W SIDE	TOTAL
7:00 AM	0	0	0	0	0
7:15 AM	0	0	0	0	0
7:30 AM	0	0	0	0	0
7:45 AM	0	0	0	0	0
8:00 AM	0	0	0	0	0
8:15 AM	0	0	0	0	0
8:30 AM	0	0	0	0	0
8:45 AM	0	0	0	0	0
TOTAL	0	0	0	0	0
AM BEGIN PEAK HR	7:30 AM				
4:00 PM	0	0	0	0	0
4:15 PM	0	0	0	0	0
4:30 PM	0	0	0	0	0
4:45 PM	0	0	0	0	0
5:00 PM	0	0	0	0	0
5:15 PM	0	0	0	0	0
5:30 PM	0	0	0	0	0
5:45 PM	0	0	0	0	0
TOTAL	0	0	0	0	0
PM BEGIN PEAK HR	4:00 PM				

	BICYCLE CROSSINGS				
	NS	SS	ES	WS	TOTAL
7:00 AM	0	0	0	0	0
7:15 AM	0	0	0	0	0
7:30 AM	0	0	0	0	0
7:45 AM	0	0	0	0	0
8:00 AM	0	0	0	0	0
8:15 AM	0	0	0	0	0
8:30 AM	0	0	0	0	0
8:45 AM	0	0	0	0	0
TOTAL	0	0	0	0	0
AM BEGIN PEAK HR	7:30 AM				
4:00 PM	0	0	0	0	0
4:15 PM	0	0	0	0	0
4:30 PM	0	0	0	0	0
4:45 PM	0	0	0	0	0
5:00 PM	0	0	0	0	0
5:15 PM	0	0	0	0	0
5:30 PM	0	0	0	0	0
5:45 PM	0	0	0	0	0
TOTAL	0	0	0	0	0
PM BEGIN PEAK HR	4:00 PM				

INTERSECTION TURNING MOVEMENT COUNTS

PREPARED BY: AimTD LLC. tel: 714 253 7888 cs@aimtd.com

T218

DATE:
Thu, May 16, 19

LOCATION: Santa Ana
NORTH & SOUTH: SR-55 SB Ramps
EAST & WEST: Dyer

PROJECT #: SC2183
LOCATION #: 28
CONTROL: SIGNAL

NOTES:

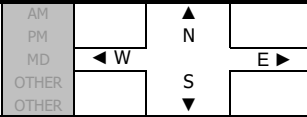

Add U-Turns to Left Turns

	NORTHBOUND			SOUTHBOUND			EASTBOUND			WESTBOUND			TOTAL
	SR-55 SB Ramps			SR-55 SB Ramps			Dyer			Dyer			
LANES:	NL	NT	NR	SL	ST	SR	EL	ET	ER	WL	WT	WR	
7:00 AM	73	5	119	7	46	12	3	254	66	76	129	23	813
7:15 AM	56	2	140	5	53	16	7	320	68	79	161	18	925
7:30 AM	64	7	127	12	72	16	2	344	81	95	153	21	994
7:45 AM	51	6	125	5	68	16	14	331	64	101	166	38	985
8:00 AM	65	6	120	14	47	11	6	314	76	90	167	27	943
8:15 AM	38	6	128	18	52	16	12	335	61	117	154	20	957
8:30 AM	45	3	88	18	41	18	7	243	70	131	137	18	819
8:45 AM	46	0	73	18	37	12	12	235	61	92	170	19	775
VOLUMES	438	35	920	97	416	117	63	2,376	547	781	1,237	184	7,211
APPROACH %	31%	3%	66%	15%	66%	19%	2%	80%	18%	35%	56%	8%	
APP/DEPART	1,393	/	282	630	/	1,742	2,986	/	3,395	2,202	/	1,792	0
BEGIN PEAK HR	7:30 AM												
VOLUMES	218	25	500	49	239	59	34	1,324	282	403	640	106	3,879
APPROACH %	29%	3%	67%	14%	69%	17%	2%	81%	17%	35%	56%	9%	
PEAK HR FACTOR	0.938			0.868			0.960			0.942			0.976
APP/DEPART	743	/	165	347	/	923	1,640	/	1,874	1,149	/	917	0
4:00 PM	74	1	43	30	57	19	18	308	62	113	219	14	958
4:15 PM	74	0	56	21	34	14	16	336	42	107	258	11	969
4:30 PM	64	2	55	26	55	24	11	383	51	138	238	9	1,056
4:45 PM	84	2	63	15	39	22	15	370	48	127	233	23	1,041
5:00 PM	74	4	49	40	61	36	19	372	57	138	257	15	1,122
5:15 PM	93	1	70	20	68	26	19	382	48	147	253	16	1,143
5:30 PM	59	1	56	23	40	16	23	341	32	97	243	18	949
5:45 PM	83	2	68	17	47	22	31	346	40	95	196	15	962
VOLUMES	605	13	460	192	401	179	152	2,838	380	962	1,897	121	8,200
APPROACH %	56%	1%	43%	25%	52%	23%	5%	84%	11%	32%	64%	4%	
APP/DEPART	1,078	/	285	772	/	1,741	3,370	/	3,491	2,980	/	2,683	0
BEGIN PEAK HR	4:30 PM												
VOLUMES	315	9	237	101	223	108	64	1,507	204	550	981	63	4,362
APPROACH %	56%	2%	42%	23%	52%	25%	4%	85%	11%	35%	62%	4%	
PEAK HR FACTOR	0.855			0.788			0.988			0.958			0.954
APP/DEPART	561	/	136	432	/	975	1,775	/	1,846	1,594	/	1,405	0

U-TURNS				
NB	SB	EB	WB	TTL
0	0	0	0	0
0	0	0	1	1
0	0	0	0	0
0	0	0	0	0
0	0	0	1	1
0	0	0	0	0
0	0	0	0	0
0	0	0	0	0
0	0	0	2	2

0	0	0	0	0
0	0	0	0	0
0	1	0	1	2
0	0	1	0	1
0	0	0	0	0
0	0	0	1	1
0	0	1	0	1
0	0	0	0	0
0	1	2	2	5

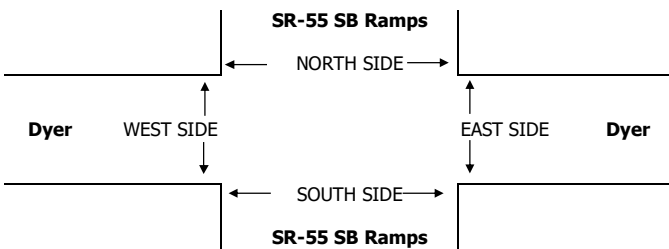

	PEDESTRIAN + BIKE CROSSINGS				
	N SIDE	S SIDE	E SIDE	W SIDE	TOTAL
7:00 AM	0	0	0	0	0
7:15 AM	0	0	0	0	0
7:30 AM	0	0	0	0	0
7:45 AM	0	0	0	0	0
8:00 AM	0	0	0	0	0
8:15 AM	0	0	0	0	0
8:30 AM	0	0	0	0	0
8:45 AM	0	0	0	0	0
TOTAL	0	0	0	0	0
AM BEGIN PEAK HR	7:30 AM				
4:00 PM	0	0	0	0	0
4:15 PM	0	0	0	0	0
4:30 PM	0	0	0	0	0
4:45 PM	0	0	0	0	0
5:00 PM	0	0	0	0	0
5:15 PM	0	0	0	0	0
5:30 PM	0	0	0	0	0
5:45 PM	0	0	0	0	0
TOTAL	0	0	0	0	0
PM BEGIN PEAK HR	4:30 PM				

	PEDESTRIAN CROSSINGS				
	N SIDE	S SIDE	E SIDE	W SIDE	TOTAL
7:00 AM	0	0	0	0	0
7:15 AM	0	0	0	0	0
7:30 AM	0	0	0	0	0
7:45 AM	0	0	0	0	0
8:00 AM	0	0	0	0	0
8:15 AM	0	0	0	0	0
8:30 AM	0	0	0	0	0
8:45 AM	0	0	0	0	0
TOTAL	0	0	0	0	0
AM BEGIN PEAK HR	7:30 AM				
4:00 PM	0	0	0	0	0
4:15 PM	0	0	0	0	0
4:30 PM	0	0	0	0	0
4:45 PM	0	0	0	0	0
5:00 PM	0	0	0	0	0
5:15 PM	0	0	0	0	0
5:30 PM	0	0	0	0	0
5:45 PM	0	0	0	0	0
TOTAL	0	0	0	0	0
PM BEGIN PEAK HR	4:30 PM				

	BICYCLE CROSSINGS				
	NS	SS	ES	WS	TOTAL
7:00 AM	0	0	0	0	0
7:15 AM	0	0	0	0	0
7:30 AM	0	0	0	0	0
7:45 AM	0	0	0	0	0
8:00 AM	0	0	0	0	0
8:15 AM	0	0	0	0	0
8:30 AM	0	0	0	0	0
8:45 AM	0	0	0	0	0
TOTAL	0	0	0	0	0
AM BEGIN PEAK HR	7:30 AM				
4:00 PM	0	0	0	0	0
4:15 PM	0	0	0	0	0
4:30 PM	0	0	0	0	0
4:45 PM	0	0	0	0	0
5:00 PM	0	0	0	0	0
5:15 PM	0	0	0	0	0
5:30 PM	0	0	0	0	0
5:45 PM	0	0	0	0	0
TOTAL	0	0	0	0	0
PM BEGIN PEAK HR	4:30 PM				

INTERSECTION TURNING MOVEMENT COUNTS

PREPARED BY: AimTD LLC. tel: 714 253 7888 pacific@aimtd.com

DATE: Tue, Mar 1, 16	LOCATION: NORTH & SOUTH: EAST & WEST:	Santa Ana Glassell La Veta	PROJECT #: SC0846 LOCATION #: 5 CONTROL: SIGNAL
--------------------------------	---	----------------------------------	---

NOTES:	AM PM MD OTHER OTHER	▲ N ▼ S	◀ W E ▶	
---------------	----------------------------------	------------------	------------	--

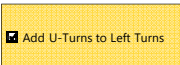

	NORTHBOUND			SOUTHBOUND			EASTBOUND			WESTBOUND			U-TURNS					
	Glassell			Glassell			La Veta			La Veta			TOTAL	NB	SB	EB	WB	TTL
	NL	NT	NR	SL	ST	SR	EL	ET	ER	WL	WT	WR		0	0	0	0	
LANES:	2	1	1	1	2	0	1	1	1	1	2	0						
AM																		
7:00 AM	23	68	11	1	70	14	8	28	80	44	33	1	381	0	0	0	0	0
7:15 AM	61	73	17	3	94	16	8	37	85	57	39	1	491	0	0	0	0	0
7:30 AM	58	85	22	1	104	17	6	54	100	65	58	0	570	0	0	0	0	0
7:45 AM	70	93	27	3	72	17	15	61	107	53	65	1	584	0	0	0	0	0
8:00 AM	76	121	43	9	74	19	10	45	82	52	61	1	593	0	0	0	0	0
8:15 AM	48	96	28	3	94	22	5	27	71	56	55	3	508	0	0	0	0	0
8:30 AM	47	94	16	1	47	9	6	36	82	35	30	0	403	0	0	0	0	0
8:45 AM	44	112	29	0	30	12	14	34	67	32	43	0	417	0	0	0	0	0
VOLUMES	427	742	193	21	585	126	72	322	674	394	384	7	3,947	0	0	0	0	0
APPROACH %	31%	54%	14%	3%	80%	17%	7%	30%	63%	50%	49%	1%						
APP/DEPART	1,362	/	821	732	/	1,653	1,068	/	536	785	/	937	0					
BEGIN PEAK HR	7:30 AM																	
VOLUMES	252	395	120	16	344	75	36	187	360	226	239	5	2,255					
APPROACH %	33%	51%	16%	4%	79%	17%	6%	32%	62%	48%	51%	1%						
PEAK HR FACTOR	0.799			0.891			0.796			0.955			0.951					
APP/DEPART	767	/	436	435	/	930	583	/	323	470	/	566	0					
PM																		
4:00 PM	62	122	38	2	107	5	19	69	92	35	54	3	608	0	0	0	0	0
4:15 PM	72	111	60	5	103	11	16	53	100	31	33	2	597	0	0	0	0	0
4:30 PM	89	104	42	3	114	9	16	34	79	29	36	1	556	0	0	0	0	0
4:45 PM	91	114	40	1	118	14	12	45	79	23	38	2	577	0	0	0	0	0
5:00 PM	106	131	45	3	105	7	20	58	128	33	49	2	687	0	0	0	0	0
5:15 PM	109	132	38	5	125	11	24	82	112	33	61	3	735	0	0	0	0	0
5:30 PM	122	117	36	3	120	8	13	61	95	40	58	2	675	0	0	0	0	0
5:45 PM	116	90	34	3	129	9	21	56	108	42	101	3	712	0	0	0	0	0
VOLUMES	767	921	333	25	921	74	141	458	793	266	430	18	5,147	0	0	0	0	0
APPROACH %	38%	46%	16%	2%	90%	7%	10%	33%	57%	37%	60%	3%						
APP/DEPART	2,021	/	1,080	1,020	/	1,980	1,392	/	816	714	/	1,271	0					
BEGIN PEAK HR	5:00 PM																	
VOLUMES	453	470	153	14	479	35	78	257	443	148	269	10	2,809					
APPROACH %	42%	44%	14%	3%	91%	7%	10%	33%	57%	35%	63%	2%						
PEAK HR FACTOR	0.954			0.936			0.892			0.731			0.955					
APP/DEPART	1,076	/	558	528	/	1,070	778	/	424	427	/	757	0					

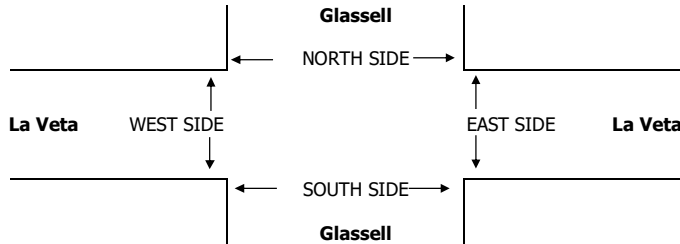

AM	7:00 AM	
	7:15 AM	
	7:30 AM	
	7:45 AM	
	8:00 AM	
	8:15 AM	
	8:30 AM	
	8:45 AM	
	TOTAL	
PM	4:00 PM	
	4:15 PM	
	4:30 PM	
	4:45 PM	
	5:00 PM	
	5:15 PM	
	5:30 PM	
	5:45 PM	
TOTAL		

PEDESTRIAN + BIKE CROSSINGS				
N SIDE	S SIDE	E SIDE	W SIDE	TOTAL
1	3	0	1	5
2	0	2	2	6
3	1	1	1	6
2	3	3	0	8
0	2	2	2	6
2	2	2	1	7
6	1	0	3	10
4	0	3	3	10
20	12	13	13	58
1	5	2	2	10
2	3	1	5	11
2	1	0	5	8
5	2	0	5	12
8	0	6	2	16
5	1	3	2	11
5	3	3	0	11
4	0	3	5	12
32	15	18	26	91

PEDESTRIAN CROSSINGS				
N SIDE	S SIDE	E SIDE	W SIDE	TOTAL
0	2	0	1	3
2	0	1	2	5
3	1	1	0	5
1	3	2	0	6
0	2	1	2	5
1	2	1	0	4
6	1	0	2	9
4	0	2	2	8
17	11	8	9	45
1	5	2	0	8
2	3	1	2	8
2	1	0	3	6
4	1	0	3	8
7	0	6	1	14
4	1	3	2	10
4	3	3	0	10
4	0	1	5	10
28	14	16	16	74

BICYCLE CROSSINGS				
NS	SS	ES	WS	TOTAL
1	1	0	0	2
0	0	1	0	1
0	0	0	1	1
1	0	1	0	2
0	0	1	0	1
1	0	1	1	3
0	0	0	1	1
0	0	1	1	2
3	1	5	4	13
0	0	0	2	2
0	0	0	3	3
0	0	0	2	2
1	1	0	2	4
1	0	0	1	2
1	0	0	0	1
1	0	0	0	1
0	0	2	0	2
4	1	2	10	17

INTERSECTION TURNING MOVEMENT COUNTS

PREPARED BY: AimTD LLC. tel: 714 253 7888 pacific@aimtd.com

DATE: Tue, Mar 1, 16	LOCATION: NORTH & SOUTH: Santa Ana EAST & WEST: Glassell SR-22 WB Off-Ramps	PROJECT #: SC0846 LOCATION #: 1 CONTROL: SIGNAL
--------------------------------	---	--

NOTES:	AM PM MD OTHER OTHER	▲ N ▼	◀ W E ▶
---------------	----------------------------------	-------------	------------

☑ Add U-Turns to Left Turns

LANES:	NORTHBOUND			SOUTHBOUND			EASTBOUND			WESTBOUND			TOTAL
	Glassell			Glassell			SR-22 WB Off-Ramps			SR-22 WB Off-Ramps			
	NL	NT	NR	SL	ST	SR	EL	ET	ER	WL	WT	WR	

U-TURNS				
NB	SB	EB	WB	TTL

AM	7:00 AM	62	71	0	0	133	56	0	0	0	61	0	44	427	0	0	0	0	0
	7:15 AM	107	93	0	0	177	63	0	0	0	79	4	89	612	0	0	0	0	0
	7:30 AM	109	124	0	0	174	76	0	0	0	67	0	101	651	0	0	0	0	0
	7:45 AM	139	164	0	0	207	102	0	0	0	60	0	113	785	0	0	0	0	0
	8:00 AM	125	158	0	0	156	91	0	0	0	67	0	106	703	0	0	0	0	0
	8:15 AM	103	127	0	0	166	67	0	0	0	67	0	70	600	0	0	0	0	0
	8:30 AM	99	98	0	0	142	44	0	0	0	92	0	70	545	0	0	0	0	0
	8:45 AM	94	129	0	0	103	50	0	0	0	69	0	76	521	0	0	0	0	0
	VOLUMES	838	964	0	0	1,258	549	0	0	0	562	4	669	4,844	0	0	0	0	0
	APPROACH %	47%	53%	0%	0%	70%	30%	0%	0%	0%	46%	0%	54%						
APP/DEPART	1,802	/	1,633	1,807	/	1,820	0	/	0	1,235	/	1,391	0						
BEGIN PEAK HR	7:15 AM																		
VOLUMES	480	539	0	0	714	332	0	0	0	273	4	409	2,751						
APPROACH %	47%	53%	0%	0%	68%	32%	0%	0%	0%	40%	1%	60%							
PEAK HR FACTOR	0.841			0.846			0.000			0.991			0.876						
APP/DEPART	1,019	/	948	1,046	/	987	0	/	0	686	/	816	0						
PM	4:00 PM	99	134	0	0	171	45	0	0	0	31	1	52	533	0	0	0	0	0
	4:15 PM	126	219	0	0	221	53	0	0	0	54	0	58	731	0	0	0	0	0
	4:30 PM	123	188	0	0	182	55	0	0	0	53	0	62	663	0	0	0	0	0
	4:45 PM	129	207	0	0	198	40	0	0	0	51	0	72	697	0	0	0	0	0
	5:00 PM	138	239	0	0	198	68	0	0	0	39	1	88	771	0	0	0	0	0
	5:15 PM	113	210	0	0	230	69	0	0	0	43	1	86	752	0	0	0	0	0
	5:30 PM	144	225	0	0	200	47	0	0	0	55	2	66	739	0	0	0	0	0
	5:45 PM	140	200	0	0	215	61	0	0	0	56	2	103	777	1	0	0	0	1
	VOLUMES	1,012	1,622	0	0	1,615	438	0	0	0	382	7	587	5,663	1	0	0	0	1
	APPROACH %	38%	62%	0%	0%	79%	21%	0%	0%	0%	39%	1%	60%						
APP/DEPART	2,634	/	2,209	2,053	/	1,998	0	/	0	976	/	1,456	0						
BEGIN PEAK HR	5:00 PM																		
VOLUMES	535	874	0	0	843	245	0	0	0	193	6	343	3,039						
APPROACH %	38%	62%	0%	0%	77%	23%	0%	0%	0%	36%	1%	63%							
PEAK HR FACTOR	0.934			0.910			0.000			0.842			0.978						
APP/DEPART	1,409	/	1,217	1,088	/	1,037	0	/	0	542	/	785	0						

0	0	0	0	0
0	0	0	0	0
0	0	0	0	0
0	0	0	0	0
0	0	0	0	0
0	0	0	0	0
0	0	0	0	0
0	0	0	0	0
0	0	0	0	0
1	0	0	0	1

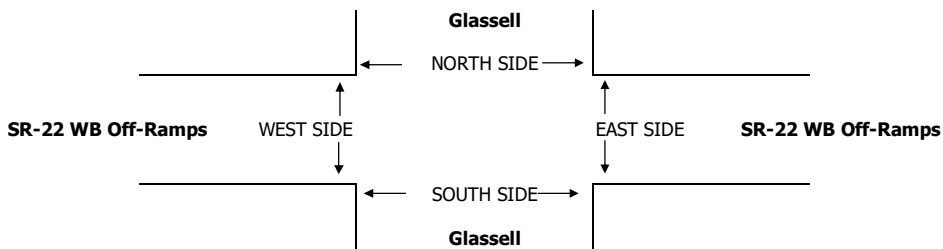

	PEDESTRIAN + BIKE CROSSINGS				
	N SIDE	S SIDE	E SIDE	W SIDE	TOTAL

AM	7:00 AM	0	0	3	1	4
	7:15 AM	0	0	3	1	4
	7:30 AM	0	0	3	1	4
	7:45 AM	0	0	1	1	2
	8:00 AM	0	0	4	3	7
	8:15 AM	0	0	3	1	4
	8:30 AM	0	0	2	3	5
	8:45 AM	0	0	2	1	3
	TOTAL	0	0	21	12	33
	PM	4:00 PM	0	0	4	5
4:15 PM		0	0	8	1	9
4:30 PM		0	0	3	2	5
4:45 PM		0	0	5	6	11
5:00 PM		0	0	6	2	8
5:15 PM		0	0	5	0	5
5:30 PM		0	0	6	0	6
5:45 PM		0	0	6	2	8
TOTAL	0	0	43	18	61	

	PEDESTRIAN CROSSINGS				
	N SIDE	S SIDE	E SIDE	W SIDE	TOTAL

	BICYCLE CROSSINGS				
	NS	SS	ES	WS	TOTAL

INTERSECTION TURNING MOVEMENT COUNTS

PREPARED BY: AimTD LLC. tel: 714 253 7888 pacific@aimtd.com

DATE: Tue, Mar 1, 16	LOCATION: NORTH & SOUTH: EAST & WEST:	Santa Ana Glassell SR-22 EB On-Ramps	PROJECT #: SC0846 LOCATION #: 2 CONTROL: SIGNAL
--------------------------------	--	--	--

NOTES:	AM PM MD OTHER	◀ W S ▼	▲ N E ▶	
---------------	-------------------------	---------------	------------	--

Add U-Turns to Left Turns

	NORTHBOUND			SOUTHBOUND			EASTBOUND			WESTBOUND			TOTAL	U-TURNS					
	Glassell			Glassell			SR-22 EB On-Ramps			SR-22 EB On-Ramps				NB	SB	EB	WB	TTL	
	NL	NT	NR	SL	ST	SR	EL	ET	ER	WL	WT	WR							
LANES:	X	2	1	1	2	X	1.3	0.3	1.3	X	X	X							
AM	7:00 AM	0	113	51	79	158	0	35	0	209	0	0	0	645	0	0	0	0	0
	7:15 AM	0	167	51	58	192	0	46	0	239	0	0	0	753	0	0	0	0	0
	7:30 AM	0	185	66	81	159	0	57	0	236	0	0	0	784	0	0	0	0	0
	7:45 AM	0	222	50	71	182	0	84	0	241	0	0	0	850	0	0	0	0	0
	8:00 AM	0	212	42	59	171	0	60	0	256	0	0	0	800	0	0	0	0	0
	8:15 AM	0	147	40	70	162	0	53	1	271	0	0	0	744	0	0	0	0	0
	8:30 AM	0	157	41	43	159	0	60	1	233	0	0	0	694	0	0	0	0	0
	8:45 AM	0	145	36	53	128	0	71	0	208	0	0	0	641	0	0	0	0	0
	VOLUMES	0	1,348	377	514	1,311	0	466	2	1,893	0	0	0	5,911	0	0	0	0	0
	APPROACH %	0%	78%	22%	28%	72%	0%	20%	0%	80%	0%	0%	0%		0%	0%	0%		
APP/DEPART	1,725	/	1,814	1,825	/	3,204	2,361	/	893	0	/	0	0						
BEGIN PEAK HR	7:15 AM																		
VOLUMES	0	786	209	269	704	0	247	0	972	0	0	0	3,187						
APPROACH %	0%	79%	21%	28%	72%	0%	20%	0%	80%	0%	0%	0%							
PEAK HR FACTOR	0.915			0.961			0.938			0.000			0.937						
APP/DEPART	995	/	1,033	973	/	1,676	1,219	/	478	0	/	0	0						
PM	4:00 PM	0	237	78	85	155	0	64	0	116	0	0	0	735	0	0	0	0	0
	4:15 PM	0	226	64	92	164	0	86	0	126	0	0	0	758	0	1	0	0	1
	4:30 PM	0	253	63	77	146	0	59	0	121	0	0	0	719	0	0	0	0	0
	4:45 PM	0	265	58	91	138	0	77	0	129	0	0	0	758	0	0	0	0	0
	5:00 PM	0	276	69	100	160	0	67	0	147	0	0	0	819	0	0	0	0	0
	5:15 PM	0	277	85	87	157	0	53	2	119	0	0	0	780	0	0	0	0	0
	5:30 PM	0	310	71	87	165	0	44	0	111	0	0	0	788	0	0	0	0	0
	5:45 PM	0	292	70	92	172	0	56	1	106	0	0	0	789	0	0	0	0	0
	VOLUMES	0	2,136	558	711	1,257	0	506	3	975	0	0	0	6,146	0	1	0	0	1
	APPROACH %	0%	79%	21%	36%	64%	0%	34%	0%	66%	0%	0%	0%		0%	0%	0%		
APP/DEPART	2,694	/	2,643	1,968	/	2,232	1,484	/	1,271	0	/	0	0						
BEGIN PEAK HR	5:00 PM																		
VOLUMES	0	1,155	295	366	654	0	220	3	483	0	0	0	3,176						
APPROACH %	0%	80%	20%	36%	64%	0%	31%	0%	68%	0%	0%	0%		0%	0%	0%			
PEAK HR FACTOR	0.951			0.966			0.825			0.000			0.969						
APP/DEPART	1,450	/	1,375	1,020	/	1,137	706	/	664	0	/	0	0						

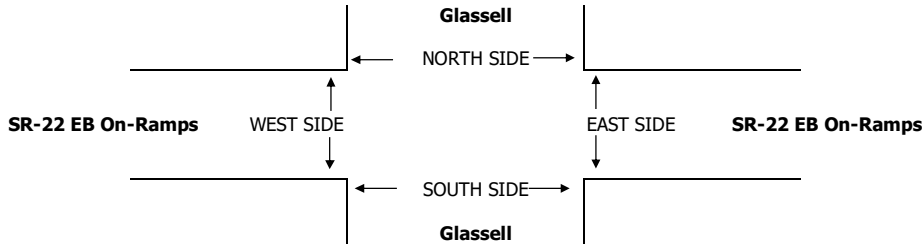

AM	7:00 AM	0	0	3	1	4
	7:15 AM	0	0	4	1	5
	7:30 AM	0	0	1	1	2
	7:45 AM	0	0	3	1	4
	8:00 AM	0	0	4	2	6
	8:15 AM	0	0	2	1	3
	8:30 AM	0	0	2	4	6
	8:45 AM	0	1	2	0	3
	TOTAL	0	1	21	11	33

PEDESTRIAN + BIKE CROSSINGS					
	N SIDE	S SIDE	E SIDE	W SIDE	TOTAL
7:00 AM	0	0	3	1	4
7:15 AM	0	0	4	1	5
7:30 AM	0	0	1	1	2
7:45 AM	0	0	3	1	4
8:00 AM	0	0	4	2	6
8:15 AM	0	0	2	1	3
8:30 AM	0	0	2	4	6
8:45 AM	0	1	2	0	3
TOTAL	0	1	21	11	33

PEDESTRIAN CROSSINGS					
	N SIDE	S SIDE	E SIDE	W SIDE	TOTAL
7:00 AM	0	0	1	0	1
7:15 AM	0	0	2	0	2
7:30 AM	0	0	1	0	1
7:45 AM	0	0	2	1	3
8:00 AM	0	0	2	2	4
8:15 AM	0	0	1	0	1
8:30 AM	0	0	1	2	3
8:45 AM	0	1	1	0	2
TOTAL	0	1	11	5	17

BICYCLE CROSSINGS					
	NS	SS	ES	WS	TOTAL
7:00 AM	0	0	2	1	3
7:15 AM	0	0	2	1	3
7:30 AM	0	0	0	1	1
7:45 AM	0	0	1	0	1
8:00 AM	0	0	2	0	2
8:15 AM	0	0	1	1	2
8:30 AM	0	0	1	2	3
8:45 AM	0	0	1	0	1
TOTAL	0	0	10	6	16

INTERSECTION TURNING MOVEMENT COUNTS

PREPARED BY: AimTD LLC. tel: 714 253 7888 pacific@aimtd.com

DATE: Thu, Feb 11, 16	LOCATION: NORTH & SOUTH: EAST & WEST:	Santa Ana Grand Fairhaven	PROJECT #: LOCATION #: CONTROL:	SC0846 2 SIGNAL
---------------------------------	--	---------------------------------	--	-----------------------

NOTES:	AM PM MD OTHER OTHER	▲ N ▼ S	◀ W E ▶	
---------------	----------------------------------	------------------	------------	--

Add U-Turns to Left Turns

	NORTHBOUND			SOUTHBOUND			EASTBOUND			WESTBOUND			TOTAL
	Grand	Grand	Grand	Grand	Fairhaven	Fairhaven	EL	ET	ER	WL	WT	WR	
LANES:	NL	NT	NR	SL	ST	SR	1	2	0	1	1	1	
AM													
7:00 AM	4	146	15	32	350	6	19	6	11	38	3	30	660
7:15 AM	3	169	23	27	367	7	18	15	13	55	3	55	755
7:30 AM	6	198	30	45	341	12	26	13	20	56	2	57	806
7:45 AM	3	183	31	50	333	8	29	22	13	63	9	52	796
8:00 AM	5	158	17	45	346	3	22	7	10	70	12	56	751
8:15 AM	9	152	27	28	387	3	19	5	11	66	5	35	747
8:30 AM	6	154	7	36	342	16	26	6	8	62	4	42	709
8:45 AM	2	164	22	31	335	11	15	6	9	47	1	41	684
VOLUMES	38	1,324	172	294	2,801	66	174	80	95	457	39	368	5,908
APPROACH %	2%	86%	11%	9%	89%	2%	50%	23%	27%	53%	5%	43%	
APP/DEPART	1,534	/	1,868	3,161	/	3,366	349	/	544	864	/	130	0
BEGIN PEAK HR	7:15 AM												
VOLUMES	17	708	101	167	1,387	30	95	57	56	244	26	220	3,108
APPROACH %	2%	86%	12%	11%	88%	2%	46%	27%	27%	50%	5%	45%	
PEAK HR FACTOR	0.882			0.988			0.813			0.888			0.964
APP/DEPART	826	/	1,024	1,584	/	1,694	208	/	324	490	/	66	0
PM													
4:00 PM	11	271	36	31	181	12	14	11	3	40	6	31	647
4:15 PM	17	254	36	36	206	18	21	6	4	44	7	29	678
4:30 PM	15	306	34	45	187	14	12	4	4	44	9	24	698
4:45 PM	9	313	47	45	203	21	13	7	7	44	7	36	752
5:00 PM	9	303	53	54	164	23	25	12	7	54	4	38	746
5:15 PM	11	293	62	58	238	16	12	7	4	56	9	47	813
5:30 PM	14	297	60	58	218	17	23	13	11	61	18	45	835
5:45 PM	10	273	58	43	239	22	15	11	9	74	15	43	812
VOLUMES	96	2,310	386	370	1,636	143	135	71	49	417	75	293	5,981
APPROACH %	3%	83%	14%	17%	76%	7%	53%	28%	19%	53%	10%	37%	
APP/DEPART	2,792	/	2,754	2,149	/	2,125	255	/	811	785	/	291	0
BEGIN PEAK HR	5:00 PM												
VOLUMES	44	1,166	233	213	859	78	75	43	31	245	46	173	3,206
APPROACH %	3%	81%	16%	19%	75%	7%	50%	29%	21%	53%	10%	37%	
PEAK HR FACTOR	0.972			0.921			0.793			0.879			0.960
APP/DEPART	1,443	/	1,424	1,150	/	1,143	149	/	479	464	/	160	0

U-TURNS				
NB	SB	EB	WB	TTL
0	0	0	0	0
1	0	0	0	1
3	0	0	0	3
1	0	0	0	1
1	1	0	0	2
2	0	0	0	2
2	1	0	0	3
2	0	0	0	2
1	0	0	0	1
13	2	0	0	15

4	2	0	0	6
3	0	0	0	3
5	3	0	0	8
3	1	0	0	4
3	4	0	0	7
1	4	0	0	5
3	1	0	0	4
1	1	0	0	2
23	16	0	0	39

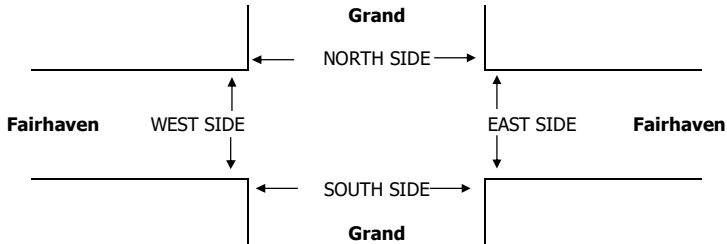

	N SIDE	S SIDE	E SIDE	W SIDE	TOTAL
AM					
7:00 AM	0	6	3	1	10
7:15 AM	0	2	2	0	4
7:30 AM	2	18	9	3	32
7:45 AM	18	22	18	8	66
8:00 AM	6	13	1	3	23
8:15 AM	1	3	1	1	6
8:30 AM	2	3	3	2	10
8:45 AM	2	1	4	0	7
TOTAL	31	68	41	18	158
PM					
4:00 PM	3	4	1	1	9
4:15 PM	4	2	1	1	8
4:30 PM	2	3	4	2	11
4:45 PM	1	6	2	3	12
5:00 PM	6	8	4	0	18
5:15 PM	3	4	9	3	19
5:30 PM	8	6	2	5	21
5:45 PM	0	10	14	1	25
TOTAL	27	43	37	16	123

PEDESTRIAN + BIKE CROSSINGS				
N SIDE	S SIDE	E SIDE	W SIDE	TOTAL
0	6	3	1	10
0	2	2	0	4
2	18	9	3	32
18	22	18	8	66
6	13	1	3	23
1	3	1	1	6
2	3	3	2	10
2	1	4	0	7
31	68	41	18	158
3	4	1	1	9
4	2	1	1	8
2	3	4	2	11
1	6	2	3	12
6	8	4	0	18
3	4	9	3	19
8	6	2	5	21
0	10	14	1	25
27	43	37	16	123

PEDESTRIAN CROSSINGS				
N SIDE	S SIDE	E SIDE	W SIDE	TOTAL
0	6	1	1	8
0	2	2	0	4
2	18	9	1	30
18	22	16	8	64
6	13	1	2	22
1	3	1	1	6
2	3	1	1	7
2	0	3	0	5
31	67	34	14	146
3	4	1	0	8
4	1	1	1	7
2	2	3	0	7
1	6	2	3	12
5	8	3	0	16
2	3	5	0	10
8	6	2	2	18
0	10	8	1	19
25	40	25	7	97

BICYCLE CROSSINGS				
NS	SS	ES	WS	TOTAL
0	0	2	0	2
0	0	0	0	0
0	0	0	2	2
0	0	2	0	2
0	0	0	1	1
0	0	0	0	0
0	0	2	1	3
0	1	1	0	2
0	1	7	4	12
0	0	0	1	1
0	1	0	0	1
0	1	1	2	4
0	0	0	0	0
1	0	1	0	2
1	1	4	3	9
0	0	0	3	3
0	0	6	0	6
2	3	12	9	26

City: SANTA ANA
 N-S Direction: GRAND AVENUE
 E-W Direction: SANTA CLARA AVENUE

File Name : H1702015
 Site Code :
 Start Date : 2/9/2017
 Page No : 1

Groups Printed- Turning Movements

Start Time	GRAND AVENUE Southbound				SANTA CLARA AVENUE Westbound			GRAND AVENUE Northbound			SANTA CLARA AVENUE Eastbound			Int. Total
	Right	Thru	Left	Peds	Right	Thru	Left	Right	Thru	Left	Right	Thru	Left	
07:00	47	415	37	1	39	31	17	17	88	7	10	31	26	766
07:15	78	364	64	0	47	54	19	28	83	13	11	56	35	852
07:30	84	333	80	1	67	58	33	31	131	15	13	65	26	937
07:45	76	317	83	0	52	51	36	37	133	29	16	58	32	920
Total	285	1429	264	2	205	194	105	113	435	64	50	210	119	3475
08:00	71	362	54	0	38	61	28	19	102	7	6	47	45	840
08:15	70	442	35	0	32	47	30	24	91	5	6	32	26	840
08:30	46	429	54	0	29	18	22	19	118	10	15	20	20	800
08:45	45	338	48	0	30	17	25	20	104	11	12	25	21	696
Total	232	1571	191	0	129	143	105	82	415	33	39	124	112	3176
*** BREAK ***														
16:00	45	163	42	1	44	56	35	42	249	22	5	32	33	769
16:15	47	168	38	1	25	46	38	62	268	18	10	31	37	789
16:30	26	195	31	0	43	45	36	55	280	18	11	36	36	812
16:45	43	170	48	1	49	57	25	47	276	17	14	34	36	817
Total	161	696	159	3	161	204	134	206	1073	75	40	133	142	3187
17:00	61	201	40	2	87	68	32	64	297	16	7	56	43	974
17:15	60	234	60	2	52	63	29	59	286	28	7	39	46	965
17:30	48	179	56	0	59	55	37	50	287	26	8	43	27	875
17:45	44	228	57	1	54	50	34	65	280	15	12	50	38	928
Total	213	842	213	5	252	236	132	238	1150	85	34	188	154	3742
Grand Total	891	4538	827	10	747	777	476	639	3073	257	163	655	527	13580
Apprch %	14.2	72.4	13.2	0.2	37.3	38.8	23.8	16.1	77.4	6.5	12.1	48.7	39.2	
Total %	6.6	33.4	6.1	0.1	5.5	5.7	3.5	4.7	22.6	1.9	1.2	4.8	3.9	

City: SANTA ANA
 N-S Direction: GRAND AVENUE
 E-W Direction: SANTA CLARA AVENUE

File Name : H1702015
 Site Code :
 Start Date : 2/9/2017
 Page No : 2

Start Time	GRAND AVENUE Southbound					SANTA CLARA AVENUE Westbound				GRAND AVENUE Northbound				SANTA CLARA AVENUE Eastbound				Int. Total
	Right	Thru	Left	Peds	App. Total	Right	Thru	Left	App. Total	Right	Thru	Left	App. Total	Right	Thru	Left	App. Total	
Peak Hour Analysis From 07:00 to 08:45 - Peak 1 of 1																		
Peak Hour for Entire Intersection Begins at 07:15																		
07:15	78	364	64	0	506	47	54	19	120	28	83	13	124	11	56	35	102	852
07:30	84	333	80	1	498	67	58	33	158	31	131	15	177	13	65	26	104	937
07:45	76	317	83	0	476	52	51	36	139	37	133	29	199	16	58	32	106	920
08:00	71	362	54	0	487	38	61	28	127	19	102	7	128	6	47	45	98	840
Total Volume	309	1376	281	1	1967	204	224	116	544	115	449	64	628	46	226	138	410	3549
% App. Total	15.7	70	14.3	0.1		37.5	41.2	21.3		18.3	71.5	10.2		11.2	55.1	33.7		
PHF	.920	.945	.846	.250	.972	.761	.918	.806	.861	.777	.844	.552	.789	.719	.869	.767	.967	.947

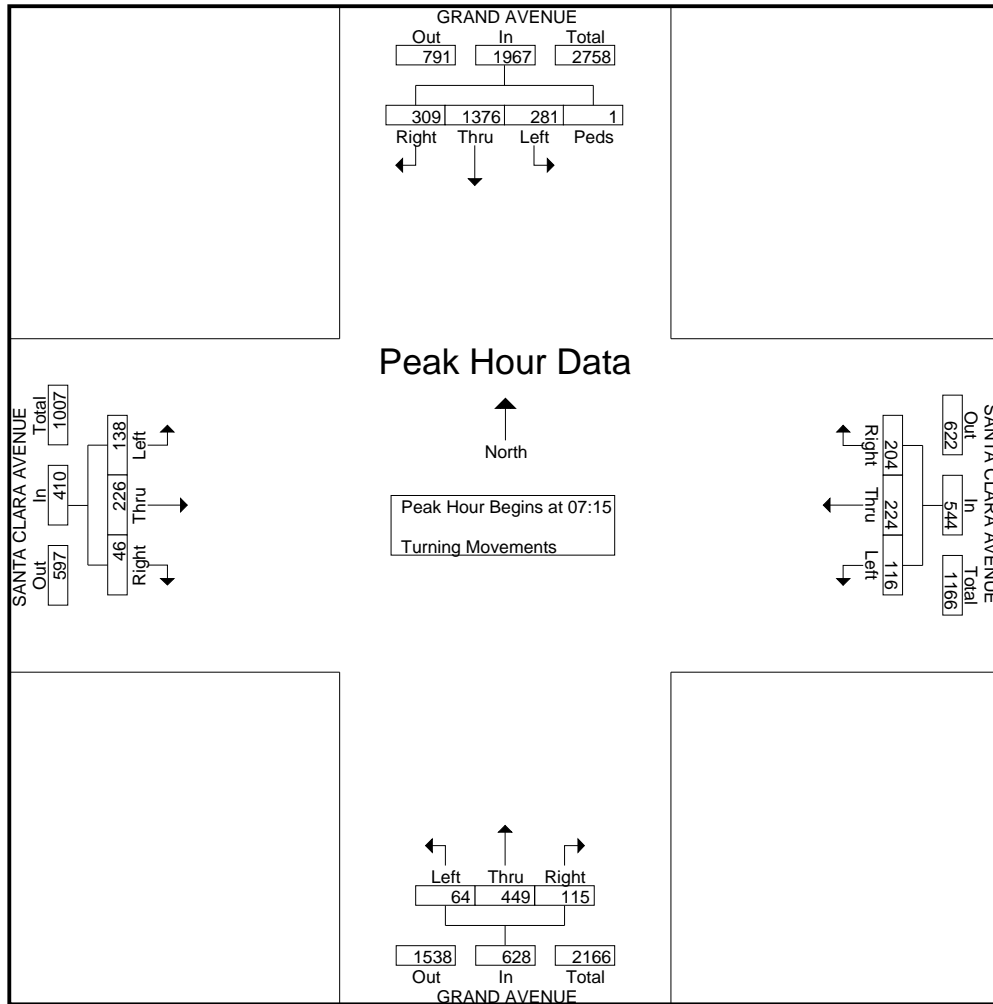

City: SANTA ANA
 N-S Direction: GRAND AVENUE
 E-W Direction: SANTA CLARA AVENUE

File Name : H1702015
 Site Code :
 Start Date : 2/9/2017
 Page No : 3

Start Time	GRAND AVENUE Southbound					SANTA CLARA AVENUE Westbound				GRAND AVENUE Northbound				SANTA CLARA AVENUE Eastbound				Int. Total
	Right	Thru	Left	Peds	App. Total	Right	Thru	Left	App. Total	Right	Thru	Left	App. Total	Right	Thru	Left	App. Total	
Peak Hour Analysis From 16:00 to 17:45 - Peak 1 of 1																		
Peak Hour for Entire Intersection Begins at 17:00																		
17:00	61	201	40	2	304	87	68	32	187	64	297	16	377	7	56	43	106	974
17:15	60	234	60	2	356	52	63	29	144	59	286	28	373	7	39	46	92	965
17:30	48	179	56	0	283	59	55	37	151	50	287	26	363	8	43	27	78	875
17:45	44	228	57	1	330	54	50	34	138	65	280	15	360	12	50	38	100	928
Total Volume	213	842	213	5	1273	252	236	132	620	238	1150	85	1473	34	188	154	376	3742
% App. Total	16.7	66.1	16.7	0.4		40.6	38.1	21.3		16.2	78.1	5.8		9	50	41		
PHF	.873	.900	.888	.625	.894	.724	.868	.892	.829	.915	.968	.759	.977	.708	.839	.837	.887	.960

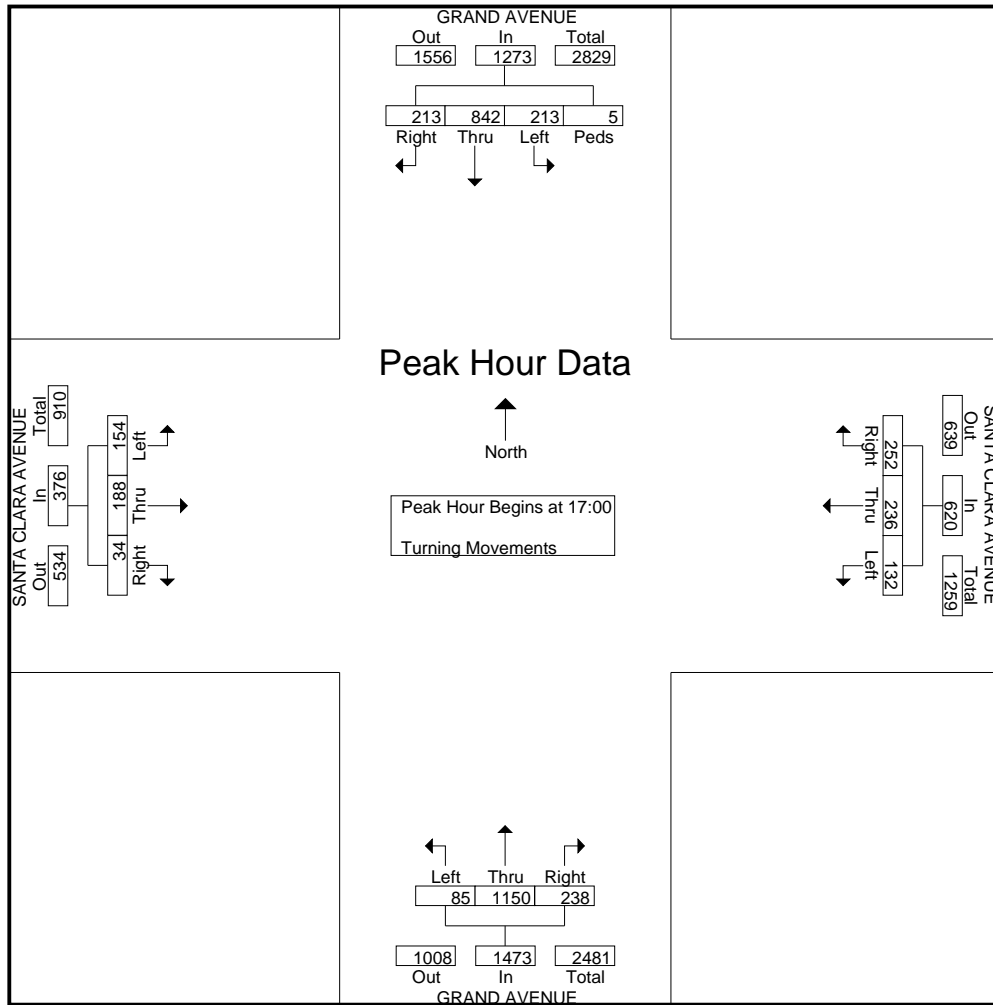

INTERSECTION TURNING MOVEMENT COUNTS

PREPARED BY: AimTD LLC. tel: 714 253 7888 cs@aimtd.com

DATE: Thu, Feb 16, 17	LOCATION: NORTH & SOUTH: EAST & WEST:	Santa Ana Grand I-5 NB Ramps	PROJECT #: LOCATION #: CONTROL:	SC1220 3 SIGNAL
---------------------------------	---	------------------------------------	---------------------------------------	-----------------------

NOTES:	AM	PM	MD	OTHER	OTHER	▲ N ▼	◀ W ▶	E ▶
						S		



LANES:	NORTHBOUND			SOUTHBOUND			EASTBOUND			WESTBOUND			TOTAL
	Grand			Grand			I-5 NB Ramps			I-5 NB Ramps			
	NL X	NT 2	NR 1	SL 1	ST 3	SR X	EL X	ET X	ER X	WL 2	WT X	WR 1	

U-TURNS				
NB 0	SB 0	EB 0	WB 0	TTL 0

AM	7:00 AM	0	123	106	19	411	0	0	0	0	104	0	31	794
	7:15 AM	0	184	108	8	495	0	0	0	0	97	0	15	907
	7:30 AM	0	226	137	12	482	0	0	0	0	94	0	31	982
	7:45 AM	0	229	117	20	425	0	0	0	0	131	0	43	965
	8:00 AM	0	167	103	16	412	0	0	0	0	120	0	33	851
	8:15 AM	0	147	103	12	389	0	0	0	0	97	0	41	789
	8:30 AM	0	153	104	9	380	0	0	0	0	93	0	33	772
	8:45 AM	0	151	96	6	354	0	0	0	0	115	0	37	759

0	3	0	0	3
0	3	0	0	3
0	1	0	0	1
0	7	0	0	7
0	6	0	0	6
0	5	0	0	5
0	4	0	0	4
0	0	0	0	0

VOLUMES	0	1,380	874	102	3,348	0	0	0	0	851	0	264	6,819
APPROACH %	0%	61%	39%	3%	97%	0%	0%	0%	0%	76%	0%	24%	
APP/DEPART	2,254	/	1,673	3,450	/	4,199	0	/	947	1,115	/	0	0
BEGIN PEAK HR	7:15 AM												
VOLUMES	0	806	465	56	1,814	0	0	0	442	0	122	3,705	
APPROACH %	0%	63%	37%	3%	97%	0%	0%	0%	78%	0%	22%		
PEAK HR FACTOR		0.875			0.929		0.000			0.810		0.943	
APP/DEPART	1,271	/	945	1,870	/	2,256	0	/	504	564	/	0	0

0	29	0	0	29
---	----	---	---	----

PM	4:00 PM	0	292	260	12	217	0	0	0	0	38	0	38	857
	4:15 PM	0	286	262	14	210	0	0	0	43	0	46	861	
	4:30 PM	0	313	244	14	223	0	0	0	50	0	46	890	
	4:45 PM	0	337	221	8	262	0	0	0	37	0	36	901	
	5:00 PM	0	307	246	12	280	0	0	0	22	0	42	909	
	5:15 PM	0	335	273	12	273	0	0	0	42	0	28	963	
	5:30 PM	0	286	233	12	285	0	0	0	30	0	51	897	
	5:45 PM	0	330	219	10	291	0	0	0	44	0	45	939	

0	8	0	0	8
0	7	0	0	7
0	7	0	0	7
0	7	0	0	7
0	6	0	0	6
0	6	0	0	6
0	6	0	0	6
0	5	0	0	5

VOLUMES	0	2,486	1,958	94	2,041	0	0	0	0	306	0	332	7,217
APPROACH %	0%	56%	44%	4%	96%	0%	0%	0%	0%	48%	0%	52%	
APP/DEPART	4,444	/	2,870	2,135	/	2,347	0	/	2,000	638	/	0	0
BEGIN PEAK HR	5:00 PM												
VOLUMES	0	1,258	971	46	1,129	0	0	0	138	0	166	3,708	
APPROACH %	0%	56%	44%	4%	96%	0%	0%	0%	45%	0%	55%		
PEAK HR FACTOR		0.917			0.976		0.000			0.854		0.963	
APP/DEPART	2,229	/	1,447	1,175	/	1,267	0	/	994	304	/	0	0

0	52	0	0	52
---	----	---	---	----

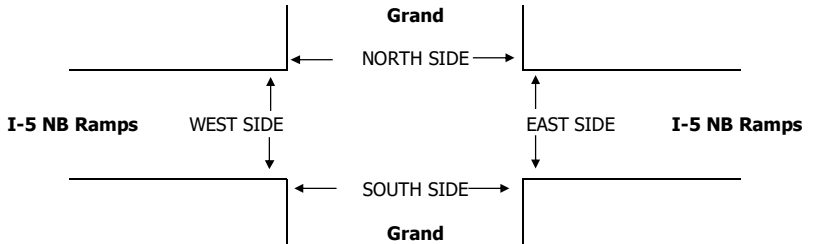

AM	7:00 AM	0	0	0	0	0
	7:15 AM	0	0	0	0	0
	7:30 AM	0	0	0	0	0
	7:45 AM	0	0	0	0	0
	8:00 AM	0	0	0	0	0
	8:15 AM	0	0	0	0	0
	8:30 AM	0	0	0	0	0
	8:45 AM	0	0	0	0	0
TOTAL	0	0	0	0	0	

PEDESTRIAN + BIKE CROSSINGS					
N SIDE	S SIDE	E SIDE	W SIDE	TOTAL	
0	0	0	0	0	0
0	0	0	0	0	0
0	0	0	0	0	0
0	0	0	0	0	0
0	0	0	0	0	0
0	0	0	0	0	0
0	0	0	0	0	0
0	0	0	0	0	0
0	0	0	0	0	0

PEDESTRIAN CROSSINGS					
N SIDE	S SIDE	E SIDE	W SIDE	TOTAL	
0	0	0	0	0	0
0	0	0	0	0	0
0	0	0	0	0	0
0	0	0	0	0	0
0	0	0	0	0	0
0	0	0	0	0	0
0	0	0	0	0	0
0	0	0	0	0	0
0	0	0	0	0	0

BICYCLE CROSSINGS					
NS	SS	ES	WS	TOTAL	
0	0	0	0	0	0
0	0	0	0	0	0
0	0	0	0	0	0
0	0	0	0	0	0
0	0	0	0	0	0
0	0	0	0	0	0
0	0	0	0	0	0
0	0	0	0	0	0
0	0	0	0	0	0

INTERSECTION TURNING MOVEMENT COUNTS

PREPARED BY: AimTD LLC. tel: 714 253 7888 cs@aimtd.com

DATE:
Thu, Feb 16, 17

LOCATION: Santa Ana
NORTH & SOUTH: Grand
EAST & WEST: Santa Ana

PROJECT #: SC1220
LOCATION #: 2
CONTROL: SIGNAL

NOTES:	AM PM MD OTHER OTHER	◀ W E ▶	▲ N S ▼	
--------	----------------------------------	------------	------------	--

☑ Add U-Turns to Left Turns

LANES:	NORTHBOUND			SOUTHBOUND			EASTBOUND			WESTBOUND			TOTAL
	Grand			Grand			Santa Ana			Santa Ana			
	NL	NT	NR	SL	ST	SR	EL	ET	ER	WL	WT	WR	
	1	2.5	0.5	1	2	2	2	1	2	0.5	1	0.5	

U-TURNS				
NB	SB	EB	WB	TTL
0	0	0	0	0

	NORTHBOUND			SOUTHBOUND			EASTBOUND			WESTBOUND			TOTAL
	NL	NT	NR	SL	ST	SR	EL	ET	ER	WL	WT	WR	
AM													
7:00 AM	14	210	14	25	256	235	30	35	126	2	25	8	980
7:15 AM	12	194	11	49	263	241	62	49	90	1	51	8	1,031
7:30 AM	18	292	18	37	308	253	60	61	99	2	123	9	1,280
7:45 AM	18	273	13	22	307	239	75	51	97	0	141	9	1,245
8:00 AM	20	214	7	28	253	265	58	49	129	1	47	7	1,078
8:15 AM	19	214	9	10	271	219	45	33	98	3	27	3	951
8:30 AM	22	198	10	15	275	186	46	25	99	3	32	3	914
8:45 AM	17	186	5	13	286	181	49	22	95	5	24	11	894
VOLUMES	140	1,781	87	199	2,219	1,819	425	325	833	17	470	58	8,373
APPROACH %	7%	89%	4%	5%	52%	43%	27%	21%	53%	3%	86%	11%	
APP/DEPART	2,008	/	2,265	4,237	/	3,079	1,583	/	610	545	/	2,419	0
BEGIN PEAK HR	7:15 AM												
VOLUMES	68	973	49	136	1,131	998	255	210	415	4	362	33	4,634
APPROACH %	6%	89%	4%	6%	50%	44%	29%	24%	47%	1%	91%	8%	
PEAK HR FACTOR	0.831												
APP/DEPART	1,090	/	1,262	2,265	/	1,553	880	/	394	399	/	1,425	0
PM													
4:00 PM	31	435	3	5	131	103	63	18	68	4	19	12	892
4:15 PM	33	417	3	12	160	98	87	22	91	4	26	23	976
4:30 PM	50	461	3	5	126	122	95	24	88	6	45	21	1,046
4:45 PM	40	441	4	9	167	118	87	23	105	3	41	18	1,056
5:00 PM	48	427	5	5	190	120	85	91	77	3	34	22	1,107
5:15 PM	47	483	5	8	177	126	80	47	69	7	40	20	1,109
5:30 PM	38	457	13	12	177	137	73	37	84	5	33	23	1,089
5:45 PM	29	465	7	8	183	133	80	19	76	4	23	29	1,056
VOLUMES	316	3,586	43	64	1,311	957	650	281	658	36	261	168	8,331
APPROACH %	8%	91%	1%	3%	56%	41%	41%	18%	41%	8%	56%	36%	
APP/DEPART	3,945	/	4,408	2,332	/	2,016	1,589	/	384	465	/	1,523	0
BEGIN PEAK HR	5:00 PM												
VOLUMES	162	1,832	30	33	727	516	318	194	306	19	130	94	4,361
APPROACH %	8%	91%	1%	3%	57%	40%	39%	24%	37%	8%	53%	39%	
PEAK HR FACTOR	0.946												
APP/DEPART	2,024	/	2,245	1,276	/	1,060	818	/	256	243	/	800	0

NB	SB	EB	WB	TTL
0	0	0	0	0
1	0	0	0	1
2	0	0	0	2
0	0	0	0	0
0	1	0	0	1
4	0	0	0	4
2	0	0	0	2
1	0	0	0	1
10	1	0	0	11
0	1	0	0	1
2	1	0	0	3
1	1	0	0	2
0	0	0	0	0
0	0	0	0	0
5	1	0	0	6
1	0	0	0	1
2	0	0	0	2
11	4	0	0	15

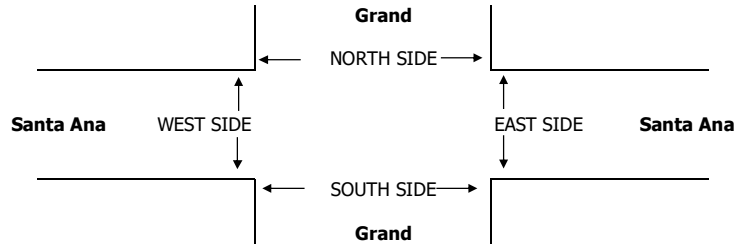

	PEDESTRIAN + BIKE CROSSINGS				
	N SIDE	S SIDE	E SIDE	W SIDE	TOTAL
AM					
7:00 AM	0	0	0	0	0
7:15 AM	0	0	0	0	0
7:30 AM	0	0	0	0	0
7:45 AM	0	0	0	0	0
8:00 AM	0	0	0	0	0
8:15 AM	0	0	0	0	0
8:30 AM	0	0	0	0	0
8:45 AM	0	0	0	0	0
TOTAL	0	0	0	0	0
PM					
4:00 PM	0	0	0	0	0
4:15 PM	0	0	0	0	0
4:30 PM	0	0	0	0	0
4:45 PM	0	0	0	0	0
5:00 PM	0	0	0	0	0
5:15 PM	0	0	0	0	0
5:30 PM	0	0	0	0	0
5:45 PM	0	0	0	0	0
TOTAL	0	0	0	0	0

	PEDESTRIAN CROSSINGS				
	N SIDE	S SIDE	E SIDE	W SIDE	TOTAL
AM					
7:00 AM	0	0	0	0	0
7:15 AM	0	0	0	0	0
7:30 AM	0	0	0	0	0
7:45 AM	0	0	0	0	0
8:00 AM	0	0	0	0	0
8:15 AM	0	0	0	0	0
8:30 AM	0	0	0	0	0
8:45 AM	0	0	0	0	0
TOTAL	0	0	0	0	0
PM					
4:00 PM	0	0	0	0	0
4:15 PM	0	0	0	0	0
4:30 PM	0	0	0	0	0
4:45 PM	0	0	0	0	0
5:00 PM	0	0	0	0	0
5:15 PM	0	0	0	0	0
5:30 PM	0	0	0	0	0
5:45 PM	0	0	0	0	0
TOTAL	0	0	0	0	0

	BICYCLE CROSSINGS				
	NS	SS	ES	WS	TOTAL
AM					
7:00 AM	0	0	0	0	0
7:15 AM	0	0	0	0	0
7:30 AM	0	0	0	0	0
7:45 AM	0	0	0	0	0
8:00 AM	0	0	0	0	0
8:15 AM	0	0	0	0	0
8:30 AM	0	0	0	0	0
8:45 AM	0	0	0	0	0
TOTAL	0	0	0	0	0
PM					
4:00 PM	0	0	0	0	0
4:15 PM	0	0	0	0	0
4:30 PM	0	0	0	0	0
4:45 PM	0	0	0	0	0
5:00 PM	0	0	0	0	0
5:15 PM	0	0	0	0	0
5:30 PM	0	0	0	0	0
5:45 PM	0	0	0	0	0
TOTAL	0	0	0	0	0

INTERSECTION TURNING MOVEMENT COUNTS

PREPARED BY: AimTD LLC. tel: 714 253 7888 cs@aimtd.com

T218

DATE:
Thu, May 16, 19

LOCATION: Santa Ana
NORTH & SOUTH: Grand
EAST & WEST: 1st

PROJECT #: SC2183
LOCATION #: 25
CONTROL: SIGNAL

NOTES:

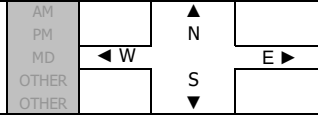

Add U-Turns to Left Turns

	NORTHBOUND			SOUTHBOUND			EASTBOUND			WESTBOUND			TOTAL
	Grand			Grand			1st			1st			
LANES:	NL	NT	NR	SL	ST	SR	EL	ET	ER	WL	WT	WR	
AM													
7:00 AM	14	109	12	23	348	25	48	241	26	50	192	18	1,106
7:15 AM	42	163	8	25	357	47	64	246	37	50	212	23	1,274
7:30 AM	63	223	10	25	379	36	91	169	70	76	233	28	1,403
7:45 AM	69	197	9	18	351	38	94	177	62	71	233	24	1,343
8:00 AM	36	160	7	30	330	51	79	193	53	47	180	23	1,189
8:15 AM	35	136	11	22	381	35	67	249	34	47	182	25	1,224
8:30 AM	42	146	6	24	342	39	63	250	43	44	191	30	1,220
8:45 AM	35	138	7	19	346	35	48	257	56	53	180	27	1,201
VOLUMES	336	1,272	70	186	2,834	306	554	1,782	381	438	1,603	198	9,960
APPROACH %	20%	76%	4%	6%	85%	9%	20%	66%	14%	20%	72%	9%	
APP/DEPART	1,678	/	2,020	3,326	/	3,641	2,717	/	2,046	2,239	/	2,253	0
BEGIN PEAK HR	7:15 AM												
VOLUMES	210	743	34	98	1,417	172	328	785	222	244	858	98	5,209
APPROACH %	21%	75%	3%	6%	84%	10%	25%	59%	17%	20%	72%	8%	
PEAK HR FACTOR	0.834			0.959			0.962			0.890			0.928
APP/DEPART	987	/	1,168	1,687	/	1,879	1,335	/	918	1,200	/	1,244	0
PM													
4:00 PM	42	338	10	27	149	75	67	224	26	31	238	34	1,261
4:15 PM	31	300	12	35	181	63	69	201	23	33	213	57	1,218
4:30 PM	47	299	7	34	191	75	63	240	20	39	232	44	1,291
4:45 PM	43	311	8	22	178	66	75	243	21	46	248	36	1,297
5:00 PM	37	279	10	27	149	61	88	265	21	36	239	45	1,257
5:15 PM	37	279	7	22	190	47	71	216	28	30	231	49	1,207
5:30 PM	37	250	8	21	168	69	85	204	26	26	223	40	1,157
5:45 PM	43	269	11	18	166	66	93	225	18	34	221	55	1,219
VOLUMES	317	2,325	73	206	1,372	522	611	1,818	183	275	1,845	360	9,907
APPROACH %	12%	86%	3%	10%	65%	25%	23%	70%	7%	11%	74%	15%	
APP/DEPART	2,715	/	3,296	2,100	/	1,815	2,612	/	2,098	2,480	/	2,698	0
BEGIN PEAK HR	4:00 PM												
VOLUMES	163	1,248	37	118	699	279	274	908	90	149	931	171	5,067
APPROACH %	11%	86%	3%	11%	64%	25%	22%	71%	7%	12%	74%	14%	
PEAK HR FACTOR	0.928			0.913			0.938			0.948			0.977
APP/DEPART	1,448	/	1,689	1,096	/	927	1,272	/	1,071	1,251	/	1,380	0

U-TURNS				
NB	SB	EB	WB	TTL
0	0	0	1	1
0	0	1	0	1
0	2	2	0	4
0	1	0	2	3
0	0	1	2	3
0	0	2	1	3
0	1	2	2	5
0	0	0	4	4
0	4	8	12	24

0	2	3	1	6
0	1	2	4	7
2	2	0	3	7
0	0	4	5	9
0	4	3	2	9
0	3	1	0	4
0	2	3	0	5
0	2	0	2	4
2	16	16	17	51

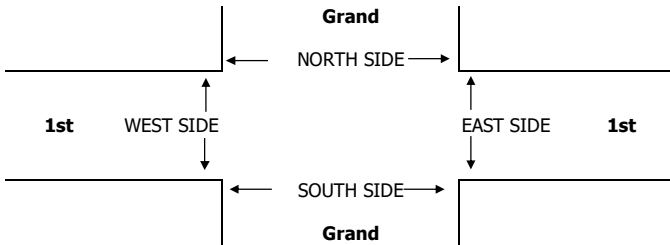

		PEDESTRIAN + BIKE CROSSINGS				
		N SIDE	S SIDE	E SIDE	W SIDE	TOTAL
AM	7:00 AM	0	0	0	0	0
	7:15 AM	0	0	0	0	0
	7:30 AM	0	0	0	0	0
	7:45 AM	0	0	0	0	0
	8:00 AM	0	0	0	0	0
	8:15 AM	0	0	0	0	0
	8:30 AM	0	0	0	0	0
	8:45 AM	0	0	0	0	0
TOTAL		0	0	0	0	0
AM BEGIN PEAK HR		7:15 AM				
PM	4:00 PM	0	0	0	0	0
	4:15 PM	0	0	0	0	0
	4:30 PM	0	0	0	0	0
	4:45 PM	0	0	0	0	0
	5:00 PM	0	0	0	0	0
	5:15 PM	0	0	0	0	0
	5:30 PM	0	0	0	0	0
	5:45 PM	0	0	0	0	0
TOTAL		0	0	0	0	0
PM BEGIN PEAK HR		4:00 PM				

		PEDESTRIAN CROSSINGS				
		N SIDE	S SIDE	E SIDE	W SIDE	TOTAL
AM	7:00 AM	0	0	0	0	0
	7:15 AM	0	0	0	0	0
	7:30 AM	0	0	0	0	0
	7:45 AM	0	0	0	0	0
	8:00 AM	0	0	0	0	0
	8:15 AM	0	0	0	0	0
	8:30 AM	0	0	0	0	0
	8:45 AM	0	0	0	0	0
TOTAL		0	0	0	0	0
AM BEGIN PEAK HR		7:15 AM				
PM	4:00 PM	0	0	0	0	0
	4:15 PM	0	0	0	0	0
	4:30 PM	0	0	0	0	0
	4:45 PM	0	0	0	0	0
	5:00 PM	0	0	0	0	0
	5:15 PM	0	0	0	0	0
	5:30 PM	0	0	0	0	0
	5:45 PM	0	0	0	0	0
TOTAL		0	0	0	0	0
PM BEGIN PEAK HR		4:00 PM				

		BICYCLE CROSSINGS				
		NS	SS	ES	WS	TOTAL
AM	7:00 AM	0	0	0	0	0
	7:15 AM	0	0	0	0	0
	7:30 AM	0	0	0	0	0
	7:45 AM	0	0	0	0	0
	8:00 AM	0	0	0	0	0
	8:15 AM	0	0	0	0	0
	8:30 AM	0	0	0	0	0
	8:45 AM	0	0	0	0	0
TOTAL		0	0	0	0	0
AM BEGIN PEAK HR		7:15 AM				
PM	4:00 PM	0	0	0	0	0
	4:15 PM	0	0	0	0	0
	4:30 PM	0	0	0	0	0
	4:45 PM	0	0	0	0	0
	5:00 PM	0	0	0	0	0
	5:15 PM	0	0	0	0	0
	5:30 PM	0	0	0	0	0
	5:45 PM	0	0	0	0	0
TOTAL		0	0	0	0	0
PM BEGIN PEAK HR		4:00 PM				

INTERSECTION TURNING MOVEMENT COUNTS

PREPARED BY: AimTD LLC. tel: 714 253 7888 pacific@aimtd.com

DATE:
Thu, Feb 11, 16

LOCATION:
NORTH & SOUTH: Santa Ana
EAST & WEST: Grand
Chestnut

PROJECT #: SC0846
LOCATION #: 29
CONTROL: SIGNAL

NOTES:

AM

PM

MD

OTHER

OTHER

N

W

S

E

Add U-Turns to Left Turns

	NORTHBOUND			SOUTHBOUND			EASTBOUND			WESTBOUND			TOTAL	
	Grand			Grand			Chestnut			Chestnut				
	NL	NT	NR	SL	ST	SR	EL	ET	ER	WL	WT	WR		
LANES:	1	3	0	1	3	0	1	2	0	1	2	0		
AM	7:00 AM	10	136	30	31	363	21	15	77	22	23	28	41	797
	7:15 AM	9	152	44	39	406	14	21	114	35	21	82	53	990
	7:30 AM	15	186	48	41	443	9	13	135	34	21	109	54	1,108
	7:45 AM	16	184	47	31	473	10	12	89	19	40	105	66	1,092
	8:00 AM	10	186	17	32	396	14	11	64	17	31	37	34	849
	8:15 AM	4	138	26	32	403	14	18	70	21	17	27	32	802
	8:30 AM	5	157	20	30	360	9	15	54	21	16	38	35	760
	8:45 AM	13	133	21	24	346	22	18	39	11	15	39	21	702
	VOLUMES	82	1,272	253	260	3,190	113	123	642	180	184	465	336	7,100
	APPROACH %	5%	79%	16%	7%	90%	3%	13%	68%	19%	19%	47%	34%	
	APP/DEPART	1,607	/	1,732	3,563	/	3,554	945	/	1,154	985	/	660	0
	BEGIN PEAK HR	7:15 AM												
VOLUMES	50	708	156	143	1,718	47	57	402	105	113	333	207	4,039	
APPROACH %	5%	77%	17%	7%	90%	2%	10%	71%	19%	17%	51%	32%		
PEAK HR FACTOR	0.918			0.928			0.775			0.774			0.911	
APP/DEPART	914	/	973	1,908	/	1,936	564	/	700	653	/	430	0	
PM	4:00 PM	40	279	50	37	166	21	15	82	14	29	69	58	860
	4:15 PM	25	246	42	35	152	22	22	58	11	32	97	45	787
	4:30 PM	42	243	41	32	162	34	26	69	21	21	76	46	813
	4:45 PM	27	241	41	39	158	30	26	64	13	20	78	37	774
	5:00 PM	28	182	20	24	176	35	23	59	13	26	96	43	725
	5:15 PM	35	232	42	36	192	19	25	81	13	18	74	26	793
	5:30 PM	30	222	61	31	184	21	16	86	16	26	84	62	839
	5:45 PM	18	278	42	28	163	22	25	66	14	33	84	45	818
	VOLUMES	245	1,923	339	262	1,353	204	178	565	115	205	658	362	6,409
	APPROACH %	10%	77%	14%	14%	74%	11%	21%	66%	13%	17%	54%	30%	
	APP/DEPART	2,507	/	2,467	1,819	/	1,672	858	/	1,163	1,225	/	1,107	0
	BEGIN PEAK HR	4:00 PM												
VOLUMES	134	1,009	174	143	638	107	89	273	59	102	320	186	3,234	
APPROACH %	10%	77%	13%	16%	72%	12%	21%	65%	14%	17%	53%	31%		
PEAK HR FACTOR	0.892			0.974			0.907			0.874			0.940	
APP/DEPART	1,317	/	1,286	888	/	799	421	/	588	608	/	561	0	

U-TURNS				
NB	SB	EB	WB	TTL
0	0	0	0	0
0	0	0	0	0
0	1	0	0	1
0	0	0	0	0
0	0	0	0	0
0	0	0	0	0
0	0	0	0	0
0	0	0	0	0
0	0	0	0	0
0	1	0	0	1

0	0	0	0	0
0	0	0	0	0
0	1	0	0	1
0	1	0	0	1
0	0	0	0	0
0	0	0	1	1
0	0	0	0	0
0	2	0	0	2
0	4	0	1	5

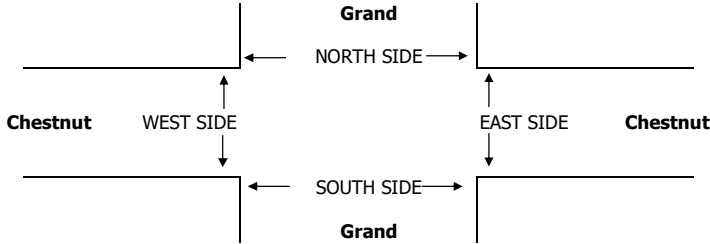

	PEDESTRIAN + BIKE CROSSINGS					
	N SIDE	S SIDE	E SIDE	W SIDE	TOTAL	
AM	7:00 AM	18	9	10	2	39
	7:15 AM	59	25	29	13	126
	7:30 AM	178	35	63	42	318
	7:45 AM	122	11	20	21	174
	8:00 AM	4	3	2	2	11
	8:15 AM	2	6	7	0	15
	8:30 AM	5	2	3	2	12
	8:45 AM	0	1	2	1	4
	TOTAL	388	92	136	83	699
PM	4:00 PM	69	11	4	17	101
	4:15 PM	29	9	4	7	49
	4:30 PM	28	6	9	7	50
	4:45 PM	9	4	6	8	27
	5:00 PM	10	8	7	4	29
	5:15 PM	6	1	3	2	12
	5:30 PM	6	7	6	6	25
	5:45 PM	5	4	3	6	18
TOTAL	162	50	42	57	311	

	PEDESTRIAN CROSSINGS						
	N SIDE	S SIDE	E SIDE	W SIDE	TOTAL		
AM	7:00 AM	17	8	7	2	34	
	7:15 AM	57	20	29	12	118	
	7:30 AM	175	33	62	39	309	
	7:45 AM	119	10	19	18	166	
	8:00 AM	3	1	1	2	7	
	8:15 AM	2	5	5	0	12	
	8:30 AM	4	1	2	2	9	
	8:45 AM	0	0	2	1	3	
	TOTAL	377	78	127	76	658	
	PM	4:00 PM	68	9	3	16	96
		4:15 PM	27	7	2	6	42
4:30 PM		23	4	5	5	37	
4:45 PM		6	1	2	5	14	
5:00 PM		10	4	5	2	21	
5:15 PM		4	1	2	1	8	
5:30 PM		1	7	2	4	14	
5:45 PM		4	4	2	5	15	
TOTAL	143	37	23	44	247		

	BICYCLE CROSSINGS						
	NS	SS	ES	WS	TOTAL		
AM	7:00 AM	1	1	3	0	5	
	7:15 AM	2	5	0	1	8	
	7:30 AM	3	2	1	3	9	
	7:45 AM	3	1	1	3	8	
	8:00 AM	1	2	1	0	4	
	8:15 AM	0	1	2	0	3	
	8:30 AM	1	1	1	0	3	
	8:45 AM	0	1	0	0	1	
	TOTAL	11	14	9	7	41	
	PM	4:00 PM	1	2	1	1	5
		4:15 PM	2	2	2	1	7
4:30 PM		5	2	4	2	13	
4:45 PM		3	3	4	3	13	
5:00 PM		0	4	2	2	8	
5:15 PM		2	0	1	1	4	
5:30 PM		5	0	4	2	11	
5:45 PM		1	0	1	1	3	
TOTAL	19	13	19	13	64		

INTERSECTION TURNING MOVEMENT COUNTS

PREPARED BY: AimTD LLC. tel: 714 253 7888 pacific@aimtd.com

DATE: Tue, Feb 9, 16	LOCATION: NORTH & SOUTH: EAST & WEST:	Santa Ana Grand McFadden	PROJECT #: SC0846 LOCATION #: 38 CONTROL: SIGNAL
--------------------------------	--	--------------------------------	---

NOTES:	AM PM MD OTHER OTHER	▲ N ▼	◀ W E ▶	
---------------	----------------------------------	-------------	------------	--

Add U-Turns to Left Turns

	NORTHBOUND			SOUTHBOUND			EASTBOUND			WESTBOUND			TOTAL
	Grand			Grand			McFadden			McFadden			
LANES:	NL	NT	NR	SL	ST	SR	EL	ET	ER	WL	WT	WR	
AM													
7:00 AM	22	137	16	40	320	28	37	136	31	22	90	20	899
7:15 AM	28	144	22	54	321	35	46	156	48	25	93	14	986
7:30 AM	37	180	29	44	439	41	48	127	52	20	81	26	1,124
7:45 AM	50	192	24	68	362	43	43	135	43	28	133	29	1,150
8:00 AM	49	177	28	61	405	29	41	159	31	39	96	32	1,147
8:15 AM	19	130	28	45	317	29	28	143	20	29	78	29	895
8:30 AM	16	125	18	35	329	21	31	106	21	25	57	9	793
8:45 AM	13	114	18	47	270	27	25	87	17	18	70	30	736
VOLUMES	234	1,199	183	394	2,763	253	299	1,049	263	206	698	189	7,730
APPROACH %	14%	74%	11%	12%	81%	7%	19%	65%	16%	19%	64%	17%	
APP/DEPART	1,616	/	1,687	3,410	/	3,232	1,611	/	1,626	1,093	/	1,185	0
BEGIN PEAK HR	7:15 AM												
VOLUMES	164	693	103	227	1,527	148	178	577	174	112	403	101	4,407
APPROACH %	17%	72%	11%	12%	80%	8%	19%	62%	19%	18%	65%	16%	
PEAK HR FACTOR	0.902			0.907			0.929			0.811			0.958
APP/DEPART	960	/	972	1,902	/	1,813	929	/	907	616	/	715	0
PM													
4:00 PM	39	278	39	28	135	53	33	96	19	24	138	35	917
4:15 PM	42	244	50	41	143	56	28	93	19	21	169	26	932
4:30 PM	52	280	47	40	161	33	30	99	25	17	163	34	981
4:45 PM	52	285	47	30	118	56	25	96	16	16	143	36	920
5:00 PM	42	264	41	34	172	36	38	127	24	27	178	39	1,022
5:15 PM	48	276	55	28	150	36	30	135	14	22	175	36	1,005
5:30 PM	39	291	61	35	123	49	20	96	20	22	176	26	958
5:45 PM	27	275	50	22	130	45	21	121	14	15	160	37	917
VOLUMES	341	2,193	390	258	1,132	364	225	863	151	164	1,302	269	7,652
APPROACH %	12%	75%	13%	15%	65%	21%	18%	70%	12%	9%	75%	16%	
APP/DEPART	2,924	/	2,687	1,754	/	1,447	1,239	/	1,511	1,735	/	2,007	0
BEGIN PEAK HR	4:30 PM												
VOLUMES	194	1,105	190	132	601	161	123	457	79	82	659	145	3,928
APPROACH %	13%	74%	13%	15%	67%	18%	19%	69%	12%	9%	74%	16%	
PEAK HR FACTOR	0.969			0.924			0.872			0.908			0.961
APP/DEPART	1,489	/	1,373	894	/	762	659	/	779	886	/	1,014	0

U-TURNS				
NB	SB	EB	WB	TTL
0	0	0	0	0
0	0	0	0	0
0	0	0	0	0
0	0	0	0	0
0	0	0	0	0
0	0	0	0	0
0	0	0	0	0
0	0	0	0	0
0	0	0	0	0
0	0	0	0	0
0	0	0	0	0
0	0	0	0	0
0	0	0	0	0
0	0	0	0	0

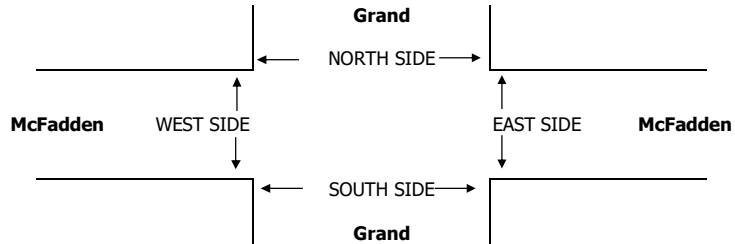

	PEDESTRIAN + BIKE CROSSINGS				
	N SIDE	S SIDE	E SIDE	W SIDE	TOTAL
AM					
7:00 AM	14	11	8	7	40
7:15 AM	23	31	13	23	90
7:30 AM	23	51	22	21	117
7:45 AM	52	105	38	55	250
8:00 AM	17	26	5	8	56
8:15 AM	11	7	6	5	29
8:30 AM	13	8	9	6	36
8:45 AM	5	2	2	3	12
TOTAL	158	241	103	128	630
PM					
4:00 PM	21	18	14	7	60
4:15 PM	16	11	8	8	43
4:30 PM	12	19	14	21	66
4:45 PM	10	9	7	3	29
5:00 PM	16	11	12	7	46
5:15 PM	18	15	6	4	43
5:30 PM	7	13	2	5	27
5:45 PM	15	13	3	3	34
TOTAL	115	109	66	58	348

PEDESTRIAN CROSSINGS				
N SIDE	S SIDE	E SIDE	W SIDE	TOTAL
10	8	7	4	29
19	30	12	20	81
21	49	22	18	110
50	104	38	49	241
16	24	4	6	50
9	7	5	5	26
9	8	7	6	30
3	2	2	3	10
137	232	97	111	577
16	12	12	7	47
13	10	5	7	35
6	15	11	16	48
7	4	5	2	18
13	10	12	6	41
14	11	6	4	35
4	9	2	2	17
11	8	1	1	21
84	79	54	45	262

BICYCLE CROSSINGS				
NS	SS	ES	WS	TOTAL
4	3	1	3	11
4	1	1	3	9
2	2	0	3	7
2	1	0	6	9
1	2	1	2	6
2	0	1	0	3
4	0	2	0	6
2	0	0	0	2
21	9	6	17	53
5	6	2	0	13
3	1	3	1	8
6	4	3	5	18
3	5	2	1	11
3	1	0	1	5
4	4	0	0	8
3	4	0	3	10
4	5	2	2	13
31	30	12	13	86

INTERSECTION TURNING MOVEMENT COUNTS

PREPARED BY: AimTD LLC. tel: 714 253 7888 cs@aimtd.com

DATE:
Thu, May 16, 19

LOCATION:
NORTH & SOUTH: Santa Ana
EAST & WEST: Grand
Edinger

PROJECT #: SC2183
LOCATION #: 26
CONTROL: SIGNAL

NOTES:

AM	← W	▲ N	E ►
PM			
MD			
OTHER			
OTHER	▼ S		

Add U-Turns to Left Turns

	NORTHBOUND			SOUTHBOUND			EASTBOUND			WESTBOUND			TOTAL
	Grand			Grand			Edinger			Edinger			
	LANES:	NL	NT	NR	SL	ST	SR	EL	ET	ER	WL	WT	
7:00 AM	11	97	25	61	253	50	63	309	35	18	141	30	1,093
7:15 AM	4	119	20	58	263	55	82	333	19	30	125	27	1,135
7:30 AM	15	143	26	54	288	49	88	328	33	46	144	34	1,248
7:45 AM	9	120	28	51	274	68	90	320	34	45	160	35	1,234
8:00 AM	18	85	17	58	309	49	55	337	40	28	144	28	1,168
8:15 AM	25	94	31	58	249	43	48	306	28	22	191	33	1,128
8:30 AM	11	94	25	52	237	39	50	239	34	29	125	33	968
8:45 AM	15	105	25	46	236	37	44	245	39	24	109	32	957
VOLUMES	108	857	197	438	2,109	390	520	2,417	262	242	1,139	252	8,931
APPROACH %	9%	74%	17%	15%	72%	13%	16%	76%	8%	15%	70%	15%	
APP/DEPART	1,162	/	1,619	2,937	/	2,595	3,199	/	3,070	1,633	/	1,647	0
BEGIN PEAK HR	7:15 AM												
VOLUMES	46	467	91	221	1,134	221	315	1,318	126	149	573	124	4,785
APPROACH %	8%	77%	15%	14%	72%	14%	18%	75%	7%	18%	68%	15%	
PEAK HR FACTOR	0.821			0.947			0.979			0.881			0.959
APP/DEPART	604	/	904	1,576	/	1,402	1,759	/	1,637	846	/	842	0
4:00 PM	70	317	45	41	88	52	57	193	14	23	299	43	1,242
4:15 PM	59	317	35	36	92	62	32	190	13	21	332	54	1,243
4:30 PM	68	323	23	44	111	73	52	186	16	26	321	39	1,282
4:45 PM	54	334	35	38	111	54	46	190	24	20	331	45	1,282
5:00 PM	65	356	28	48	122	75	53	211	17	17	328	38	1,358
5:15 PM	65	348	28	29	87	49	44	229	15	19	335	49	1,297
5:30 PM	55	345	28	48	83	48	56	229	13	17	325	39	1,286
5:45 PM	41	300	22	36	66	64	55	181	11	14	336	45	1,171
VOLUMES	477	2,640	244	320	760	477	395	1,609	123	157	2,607	352	10,161
APPROACH %	14%	79%	7%	21%	49%	31%	19%	76%	6%	5%	84%	11%	
APP/DEPART	3,361	/	3,370	1,557	/	1,030	2,127	/	2,183	3,116	/	3,578	0
BEGIN PEAK HR	4:45 PM												
VOLUMES	239	1,383	119	163	403	226	199	859	69	73	1,319	171	5,223
APPROACH %	14%	79%	7%	21%	51%	29%	18%	76%	6%	5%	84%	11%	
PEAK HR FACTOR	0.969			0.808			0.945			0.970			0.962
APP/DEPART	1,741	/	1,744	792	/	540	1,127	/	1,146	1,563	/	1,793	0

U-TURNS				
NB	SB	EB	WB	TTL
0	0	0	0	0
0	0	0	1	1
0	0	1	3	4
0	0	1	2	3
0	0	0	1	1
0	0	3	2	5
0	0	3	4	7
0	0	2	5	7
0	0	10	18	28

0	0	2	1	3
0	0	1	3	4
0	0	4	1	5
0	0	2	0	2
0	0	5	2	7
0	0	2	3	5
0	0	0	0	0
0	0	1	0	1
0	0	17	10	27

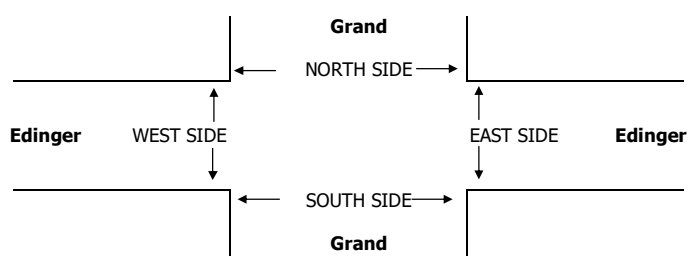

	PEDESTRIAN + BIKE CROSSINGS				
	N SIDE	S SIDE	E SIDE	W SIDE	TOTAL
7:00 AM	0	0	0	0	0
7:15 AM	0	0	0	0	0
7:30 AM	0	0	0	0	0
7:45 AM	0	0	0	0	0
8:00 AM	0	0	0	0	0
8:15 AM	0	0	0	0	0
8:30 AM	0	0	0	0	0
8:45 AM	0	0	0	0	0
TOTAL	0	0	0	0	0
AM BEGIN PEAK HR	7:15 AM				
4:00 PM	0	0	0	0	0
4:15 PM	0	0	0	0	0
4:30 PM	0	0	0	0	0
4:45 PM	0	0	0	0	0
5:00 PM	0	0	0	0	0
5:15 PM	0	0	0	0	0
5:30 PM	0	0	0	0	0
5:45 PM	0	0	0	0	0
TOTAL	0	0	0	0	0
PM BEGIN PEAK HR	4:45 PM				

	PEDESTRIAN CROSSINGS				
	N SIDE	S SIDE	E SIDE	W SIDE	TOTAL
7:00 AM	0	0	0	0	0
7:15 AM	0	0	0	0	0
7:30 AM	0	0	0	0	0
7:45 AM	0	0	0	0	0
8:00 AM	0	0	0	0	0
8:15 AM	0	0	0	0	0
8:30 AM	0	0	0	0	0
8:45 AM	0	0	0	0	0
TOTAL	0	0	0	0	0
AM BEGIN PEAK HR	7:15 AM				
4:00 PM	0	0	0	0	0
4:15 PM	0	0	0	0	0
4:30 PM	0	0	0	0	0
4:45 PM	0	0	0	0	0
5:00 PM	0	0	0	0	0
5:15 PM	0	0	0	0	0
5:30 PM	0	0	0	0	0
5:45 PM	0	0	0	0	0
TOTAL	0	0	0	0	0
PM BEGIN PEAK HR	4:45 PM				

	BICYCLE CROSSINGS				
	NS	SS	ES	WS	TOTAL
7:00 AM	0	0	0	0	0
7:15 AM	0	0	0	0	0
7:30 AM	0	0	0	0	0
7:45 AM	0	0	0	0	0
8:00 AM	0	0	0	0	0
8:15 AM	0	0	0	0	0
8:30 AM	0	0	0	0	0
8:45 AM	0	0	0	0	0
TOTAL	0	0	0	0	0
AM BEGIN PEAK HR	7:15 AM				
4:00 PM	0	0	0	0	0
4:15 PM	0	0	0	0	0
4:30 PM	0	0	0	0	0
4:45 PM	0	0	0	0	0
5:00 PM	0	0	0	0	0
5:15 PM	0	0	0	0	0
5:30 PM	0	0	0	0	0
5:45 PM	0	0	0	0	0
TOTAL	0	0	0	0	0
PM BEGIN PEAK HR	4:45 PM				

INTERSECTION TURNING MOVEMENT COUNTS

PREPARED BY: AimTD LLC. tel: 714 253 7888 cs@aimtd.com

DATE:
Thu, May 16, 19

LOCATION: Santa Ana
NORTH & SOUTH: Grand
EAST & WEST: Warner

PROJECT #: SC2183
LOCATION #: 27
CONTROL: SIGNAL

NOTES:

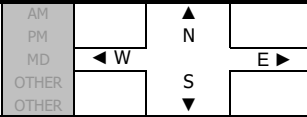

Add U-Turns to Left Turns

	NORTHBOUND			SOUTHBOUND			EASTBOUND			WESTBOUND			TOTAL
	Grand			Grand			Warner			Warner			
LANES:	NL 1	NT 3	NR 0	SL 1	ST 3	SR 0	EL 2	ET 3	ER 1	WL 2	WT 2	WR 1	
AM													
7:00 AM	41	102	39	31	90	48	46	182	77	10	73	14	753
7:15 AM	50	116	50	42	124	53	67	206	82	26	74	24	914
7:30 AM	46	125	49	47	158	44	62	207	108	19	114	23	1,002
7:45 AM	36	133	51	60	146	50	57	286	89	21	107	39	1,075
8:00 AM	35	130	65	48	140	45	67	205	76	21	89	43	964
8:15 AM	26	98	56	52	128	52	75	188	56	23	113	27	894
8:30 AM	32	87	40	57	142	51	49	188	49	26	84	13	818
8:45 AM	30	87	32	58	125	30	66	169	55	19	91	37	799
VOLUMES	296	878	382	395	1,053	373	489	1,631	592	165	745	220	7,219
APPROACH %	19%	56%	25%	22%	58%	20%	18%	60%	22%	15%	66%	19%	
APP/DEPART	1,556	/	1,587	1,821	/	1,811	2,712	/	2,407	1,130	/	1,414	0
BEGIN PEAK HR	7:15 AM												
VOLUMES	167	504	215	197	568	192	253	904	355	87	384	129	3,955
APPROACH %	19%	57%	24%	21%	59%	20%	17%	60%	23%	15%	64%	22%	
PEAK HR FACTOR	0.963			0.935			0.875			0.898			0.920
APP/DEPART	886	/	886	957	/	1,010	1,512	/	1,315	600	/	744	0
PM													
4:00 PM	45	159	48	29	68	61	108	146	35	28	242	82	1,051
4:15 PM	51	222	40	26	73	56	93	125	36	36	204	76	1,038
4:30 PM	56	211	32	32	106	57	86	120	42	45	211	71	1,069
4:45 PM	65	249	45	29	132	54	77	163	36	40	248	65	1,203
5:00 PM	60	188	43	38	131	62	84	164	36	49	220	81	1,156
5:15 PM	56	218	46	31	104	60	86	161	39	29	254	91	1,175
5:30 PM	58	209	57	46	99	38	91	161	29	31	232	75	1,126
5:45 PM	53	233	40	24	75	58	75	159	15	23	208	79	1,042
VOLUMES	444	1,689	351	255	788	446	700	1,199	268	281	1,819	620	8,860
APPROACH %	18%	68%	14%	17%	53%	30%	32%	55%	12%	10%	67%	23%	
APP/DEPART	2,484	/	3,011	1,489	/	1,334	2,167	/	1,806	2,720	/	2,709	0
BEGIN PEAK HR	4:45 PM												
VOLUMES	239	864	191	144	466	214	338	649	140	149	954	312	4,660
APPROACH %	18%	67%	15%	17%	57%	26%	30%	58%	12%	11%	67%	22%	
PEAK HR FACTOR	0.901			0.892			0.985			0.946			0.968
APP/DEPART	1,294	/	1,515	824	/	754	1,127	/	984	1,415	/	1,407	0

U-TURNS				
NB	SB	EB	WB	TTL
0	0	0	0	0
0	0	0	0	0
0	0	1	0	1
0	0	0	0	0
0	1	0	0	1
1	0	0	0	1
0	0	0	0	0
0	0	0	0	0
1	1	1	0	3

0	0	0	0	0
0	0	0	2	2
0	1	0	0	1
0	0	0	0	0
0	0	0	0	0
0	1	0	0	1
0	0	0	1	1
0	0	0	0	0
0	2	0	3	5

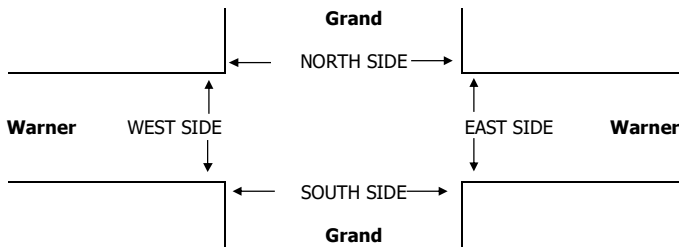

		PEDESTRIAN + BIKE CROSSINGS				
		N SIDE	S SIDE	E SIDE	W SIDE	TOTAL
AM	7:00 AM	0	0	0	0	0
	7:15 AM	0	0	0	0	0
	7:30 AM	0	0	0	0	0
	7:45 AM	0	0	0	0	0
	8:00 AM	0	0	0	0	0
	8:15 AM	0	0	0	0	0
	8:30 AM	0	0	0	0	0
	8:45 AM	0	0	0	0	0
TOTAL		0	0	0	0	0
AM BEGIN PEAK HR		7:15 AM				
PM	4:00 PM	0	0	0	0	0
	4:15 PM	0	0	0	0	0
	4:30 PM	0	0	0	0	0
	4:45 PM	0	0	0	0	0
	5:00 PM	0	0	0	0	0
	5:15 PM	0	0	0	0	0
	5:30 PM	0	0	0	0	0
	5:45 PM	0	0	0	0	0
TOTAL		0	0	0	0	0
PM BEGIN PEAK HR		4:45 PM				

		PEDESTRIAN CROSSINGS				
		N SIDE	S SIDE	E SIDE	W SIDE	TOTAL
AM	7:00 AM	0	0	0	0	0
	7:15 AM	0	0	0	0	0
	7:30 AM	0	0	0	0	0
	7:45 AM	0	0	0	0	0
	8:00 AM	0	0	0	0	0
	8:15 AM	0	0	0	0	0
	8:30 AM	0	0	0	0	0
	8:45 AM	0	0	0	0	0
TOTAL		0	0	0	0	0
AM BEGIN PEAK HR		7:15 AM				
PM	4:00 PM	0	0	0	0	0
	4:15 PM	0	0	0	0	0
	4:30 PM	0	0	0	0	0
	4:45 PM	0	0	0	0	0
	5:00 PM	0	0	0	0	0
	5:15 PM	0	0	0	0	0
	5:30 PM	0	0	0	0	0
	5:45 PM	0	0	0	0	0
TOTAL		0	0	0	0	0
PM BEGIN PEAK HR		4:45 PM				

		BICYCLE CROSSINGS				
		NS	SS	ES	WS	TOTAL
AM	7:00 AM	0	0	0	0	0
	7:15 AM	0	0	0	0	0
	7:30 AM	0	0	0	0	0
	7:45 AM	0	0	0	0	0
	8:00 AM	0	0	0	0	0
	8:15 AM	0	0	0	0	0
	8:30 AM	0	0	0	0	0
	8:45 AM	0	0	0	0	0
TOTAL		0	0	0	0	0
AM BEGIN PEAK HR		7:15 AM				
PM	4:00 PM	0	0	0	0	0
	4:15 PM	0	0	0	0	0
	4:30 PM	0	0	0	0	0
	4:45 PM	0	0	0	0	0
	5:00 PM	0	0	0	0	0
	5:15 PM	0	0	0	0	0
	5:30 PM	0	0	0	0	0
	5:45 PM	0	0	0	0	0
TOTAL		0	0	0	0	0
PM BEGIN PEAK HR		4:45 PM				

INTERSECTION TURNING MOVEMENT COUNTS

PREPARED BY: AimTD LLC. tel: 714 253 7888 cs@aimtd.com

T218

DATE:
Thu, May 16, 19

LOCATION: Santa Ana
NORTH & SOUTH: SR-55 NB Ramps
EAST & WEST: Dyer

PROJECT #: SC2183
LOCATION #: 29
CONTROL: SIGNAL

NOTES:

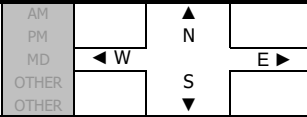

Add U-Turns to Left Turns

	NORTHBOUND <small>SR-55 NB Ramps</small>			SOUTHBOUND <small>SR-55 NB Ramps</small>			EASTBOUND <small>Dyer</small>			WESTBOUND <small>Dyer</small>			TOTAL
	NL 1.5	NT X	NR 1.5	SL X	ST X	SR X	EL X	ET 3	ER 1	WL X	WT 3	WR 1	
LANES:													
7:00 AM	171	0	88	0	0	0	0	333	152	0	120	84	948
7:15 AM	167	0	116	0	0	0	0	357	172	0	152	69	1,033
7:30 AM	142	0	114	0	0	0	0	390	139	0	157	95	1,037
7:45 AM	169	0	121	0	0	0	0	385	158	0	179	82	1,094
8:00 AM	128	0	99	0	0	0	0	366	142	0	168	110	1,013
8:15 AM	112	0	117	0	0	0	0	376	167	0	207	141	1,120
8:30 AM	110	0	107	0	0	0	0	300	146	0	195	97	955
8:45 AM	140	0	99	0	0	0	0	276	139	0	200	89	943
VOLUMES	1,139	0	861	0	0	0	0	2,783	1,215	0	1,378	767	8,144
APPROACH %	57%	0%	43%	0%	0%	0%	0%	70%	30%	0%	64%	36%	
APP/DEPART	2,000	/	767	0	/	1,215	3,999	/	3,644	2,145	/	2,518	0
BEGIN PEAK HR	7:30 AM												
VOLUMES	551	0	451	0	0	0	0	1,517	606	0	711	428	4,265
APPROACH %	55%	0%	45%	0%	0%	0%	0%	71%	29%	0%	62%	38%	
PEAK HR FACTOR	0.864			0.000			0.978			0.818			0.952
APP/DEPART	1,002	/	428	0	/	606	2,124	/	1,968	1,139	/	1,263	0
4:00 PM	56	0	16	0	0	0	0	241	175	0	342	249	1,079
4:15 PM	37	0	16	0	0	0	0	279	169	0	370	258	1,129
4:30 PM	42	0	8	0	0	0	0	278	170	0	366	248	1,112
4:45 PM	48	0	14	0	0	0	0	312	155	0	360	241	1,130
5:00 PM	40	0	11	0	0	0	0	320	177	0	399	241	1,188
5:15 PM	42	0	14	0	0	0	0	351	176	0	395	242	1,220
5:30 PM	56	0	11	0	0	0	0	342	166	0	375	231	1,181
5:45 PM	38	0	24	0	0	0	0	278	138	0	318	197	993
VOLUMES	359	0	114	0	0	0	0	2,401	1,326	0	2,925	1,907	9,032
APPROACH %	76%	0%	24%	0%	0%	0%	0%	64%	36%	0%	61%	39%	
APP/DEPART	473	/	1,907	0	/	1,326	3,727	/	2,515	4,832	/	3,284	0
BEGIN PEAK HR	4:45 PM												
VOLUMES	186	0	50	0	0	0	0	1,325	674	0	1,529	955	4,719
APPROACH %	79%	0%	21%	0%	0%	0%	0%	66%	34%	0%	62%	38%	
PEAK HR FACTOR	0.881			0.000			0.948			0.970			0.967
APP/DEPART	236	/	955	0	/	674	1,999	/	1,375	2,484	/	1,715	0

U-TURNS				
NB	SB	EB	WB	TTL
0	0	0	0	0
0	0	0	0	0
0	0	0	0	0
0	0	0	0	0
0	0	1	0	1
0	0	0	0	0
0	0	0	0	0
0	0	0	0	0
0	0	0	0	0
0	0	1	0	1

0	0	0	0	0
0	0	0	0	0
0	0	0	0	0
0	0	0	0	0
0	0	0	0	0
0	0	0	0	0
0	0	0	0	0
0	0	0	0	0
0	0	0	0	0
0	0	0	0	0

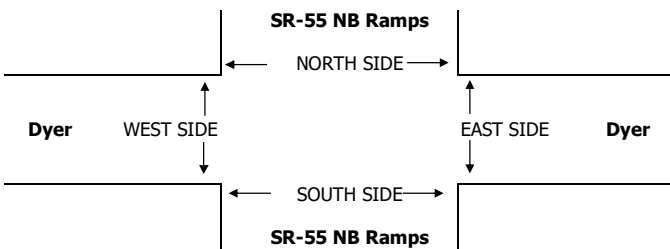

		PEDESTRIAN + BIKE CROSSINGS				
		N SIDE	S SIDE	E SIDE	W SIDE	TOTAL
AM	7:00 AM	0	0	0	0	0
AM	7:15 AM	0	0	0	0	0
AM	7:30 AM	0	0	0	0	0
AM	7:45 AM	0	0	0	0	0
AM	8:00 AM	0	0	0	0	0
AM	8:15 AM	0	0	0	0	0
AM	8:30 AM	0	0	0	0	0
AM	8:45 AM	0	0	0	0	0
AM	TOTAL	0	0	0	0	0
AM	AM BEGIN PEAK HR	7:30 AM				
PM	4:00 PM	0	0	0	0	0
PM	4:15 PM	0	0	0	0	0
PM	4:30 PM	0	0	0	0	0
PM	4:45 PM	0	0	0	0	0
PM	5:00 PM	0	0	0	0	0
PM	5:15 PM	0	0	0	0	0
PM	5:30 PM	0	0	0	0	0
PM	5:45 PM	0	0	0	0	0
PM	TOTAL	0	0	0	0	0
PM	PM BEGIN PEAK HR	4:45 PM				

		PEDESTRIAN CROSSINGS				
		N SIDE	S SIDE	E SIDE	W SIDE	TOTAL
AM	7:00 AM	0	0	0	0	0
AM	7:15 AM	0	0	0	0	0
AM	7:30 AM	0	0	0	0	0
AM	7:45 AM	0	0	0	0	0
AM	8:00 AM	0	0	0	0	0
AM	8:15 AM	0	0	0	0	0
AM	8:30 AM	0	0	0	0	0
AM	8:45 AM	0	0	0	0	0
AM	TOTAL	0	0	0	0	0
AM	AM BEGIN PEAK HR	7:30 AM				
PM	4:00 PM	0	0	0	0	0
PM	4:15 PM	0	0	0	0	0
PM	4:30 PM	0	0	0	0	0
PM	4:45 PM	0	0	0	0	0
PM	5:00 PM	0	0	0	0	0
PM	5:15 PM	0	0	0	0	0
PM	5:30 PM	0	0	0	0	0
PM	5:45 PM	0	0	0	0	0
PM	TOTAL	0	0	0	0	0
PM	PM BEGIN PEAK HR	4:45 PM				

		BICYCLE CROSSINGS				
		NS	SS	ES	WS	TOTAL
AM	7:00 AM	0	0	0	0	0
AM	7:15 AM	0	0	0	0	0
AM	7:30 AM	0	0	0	0	0
AM	7:45 AM	0	0	0	0	0
AM	8:00 AM	0	0	0	0	0
AM	8:15 AM	0	0	0	0	0
AM	8:30 AM	0	0	0	0	0
AM	8:45 AM	0	0	0	0	0
AM	TOTAL	0	0	0	0	0
AM	AM BEGIN PEAK HR	7:30 AM				
PM	4:00 PM	0	0	0	0	0
PM	4:15 PM	0	0	0	0	0
PM	4:30 PM	0	0	0	0	0
PM	4:45 PM	0	0	0	0	0
PM	5:00 PM	0	0	0	0	0
PM	5:15 PM	0	0	0	0	0
PM	5:30 PM	0	0	0	0	0
PM	5:45 PM	0	0	0	0	0
PM	TOTAL	0	0	0	0	0
PM	PM BEGIN PEAK HR	4:45 PM				

INTERSECTION TURNING MOVEMENT COUNTS

PREPARED BY: AimTD LLC. tel: 714 253 7888 pacific@aimtd.com

DATE: Tue, Mar 1, 16	LOCATION: NORTH & SOUTH: Santa Ana EAST & WEST: Cambridge La Veta	PROJECT #: SC0846 LOCATION #: 6 CONTROL: STOP ALL
--------------------------------	---	--

NOTES:	AM PM MD OTHER OTHER	◀ W S ▼	▲ N E ▶
--------	----------------------------------	---------------	------------

Add U-Turns to Left Turns

	NORTHBOUND			SOUTHBOUND			EASTBOUND			WESTBOUND			TOTAL
	Cambridge			Cambridge			La Veta			La Veta			
	NL	NT	NR	SL	ST	SR	EL	ET	ER	WL	WT	WR	
LANES:	1	1	X	X	1	1	1	X	1	X	X	X	
AM													
7:00 AM	19	21	0	0	76	37	16	0	20	0	0	0	189
7:15 AM	22	34	0	0	114	47	18	0	40	0	0	0	275
7:30 AM	35	46	0	0	113	62	33	0	46	0	0	0	335
7:45 AM	51	68	0	0	106	68	43	0	50	0	0	0	386
8:00 AM	45	48	0	0	128	58	18	0	43	0	0	0	340
8:15 AM	27	32	0	0	112	55	23	0	24	0	0	0	273
8:30 AM	16	27	0	0	63	36	15	0	14	0	0	0	171
8:45 AM	12	36	0	0	65	48	23	0	18	0	0	0	202
VOLUMES	227	312	0	0	777	411	189	0	255	0	0	0	2,171
APPROACH %	42%	58%	0%	0%	65%	35%	43%	0%	57%	0%	0%	0%	
APP/DEPART	539	/	501	1,188	/	1,032	444	/	0	0	/	638	0
BEGIN PEAK HR	7:15 AM												
VOLUMES	153	196	0	0	461	235	112	0	179	0	0	0	1,336
APPROACH %	44%	56%	0%	0%	66%	34%	38%	0%	62%	0%	0%	0%	
PEAK HR FACTOR	0.733			0.935									
APP/DEPART	349	/	308	696	/	640	291	/	0	0	/	388	0
PM													
4:00 PM	22	37	0	0	49	27	59	0	28	0	0	0	222
4:15 PM	25	47	0	0	30	33	59	0	30	0	0	0	224
4:30 PM	29	49	0	0	49	23	49	0	22	0	0	0	221
4:45 PM	34	60	0	0	43	30	53	0	33	0	0	0	253
5:00 PM	36	62	0	0	40	33	40	0	31	0	0	0	242
5:15 PM	41	60	0	0	47	48	67	0	35	0	0	0	298
5:30 PM	45	63	0	0	59	52	55	0	42	0	0	0	316
5:45 PM	61	70	0	0	42	40	48	0	30	0	0	0	291
VOLUMES	293	448	0	0	359	286	430	0	251	0	0	0	2,067
APPROACH %	40%	60%	0%	0%	56%	44%	63%	0%	37%	0%	0%	0%	
APP/DEPART	741	/	878	645	/	612	681	/	0	0	/	577	0
BEGIN PEAK HR	5:00 PM												
VOLUMES	183	255	0	0	188	173	210	0	138	0	0	0	1,147
APPROACH %	42%	58%	0%	0%	52%	48%	60%	0%	40%	0%	0%	0%	
PEAK HR FACTOR	0.836			0.813									
APP/DEPART	438	/	465	361	/	327	348	/	0	0	/	355	0

U-TURNS				
NB	SB	EB	WB	TTL
0	0	0	0	0
0	0	0	0	0
0	0	0	0	0
0	0	0	0	0
0	0	0	0	0
0	0	0	0	0
0	0	0	0	0
0	0	0	0	0
0	0	0	0	0
0	0	0	0	0
0	0	0	0	0
0	0	0	0	0
0	0	0	0	0

0	0	0	0	0
0	0	0	0	0
0	0	0	0	0
0	0	0	0	0
1	0	0	0	1
0	0	0	0	0
1	0	0	0	1
0	0	0	0	0
0	0	0	0	0
2	0	0	0	2

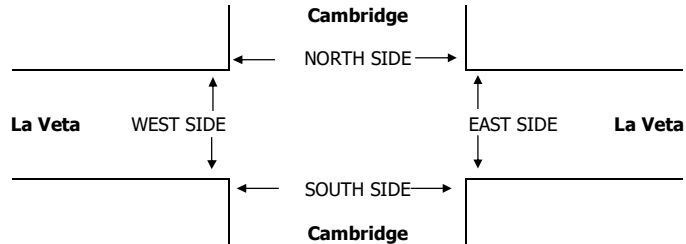

	PEDESTRIAN + BIKE CROSSINGS				
	N SIDE	S SIDE	E SIDE	W SIDE	TOTAL
AM					
7:00 AM	0	1	1	3	5
7:15 AM	1	2	1	1	5
7:30 AM	4	1	0	5	10
7:45 AM	0	4	0	3	7
8:00 AM	0	0	0	0	0
8:15 AM	0	0	0	0	0
8:30 AM	0	1	1	0	2
8:45 AM	0	0	1	4	5
TOTAL	5	9	4	16	34
PM					
4:00 PM	0	1	2	3	6
4:15 PM	1	0	0	1	2
4:30 PM	0	1	0	2	3
4:45 PM	0	1	0	0	1
5:00 PM	0	0	0	2	2
5:15 PM	1	1	0	2	4
5:30 PM	0	0	3	4	7
5:45 PM	0	0	0	0	0
TOTAL	2	4	5	14	25

	PEDESTRIAN CROSSINGS				
	N SIDE	S SIDE	E SIDE	W SIDE	TOTAL
AM					
7:00 AM	0	0	0	2	2
7:15 AM	0	2	0	0	2
7:30 AM	4	1	0	1	6
7:45 AM	0	4	0	1	5
8:00 AM	0	0	0	0	0
8:15 AM	0	0	0	0	0
8:30 AM	0	1	0	0	1
8:45 AM	0	0	0	2	2
TOTAL	4	8	0	6	18
PM					
4:00 PM	0	0	0	0	0
4:15 PM	1	0	0	1	2
4:30 PM	0	1	0	0	1
4:45 PM	0	1	0	0	1
5:00 PM	0	0	0	0	0
5:15 PM	1	1	0	1	3
5:30 PM	0	0	1	2	3
5:45 PM	0	0	0	0	0
TOTAL	2	3	1	4	10

	BICYCLE CROSSINGS				
	NS	SS	ES	WS	TOTAL
AM					
7:00 AM	0	1	1	1	3
7:15 AM	1	0	1	1	3
7:30 AM	0	0	0	4	4
7:45 AM	0	0	0	2	2
8:00 AM	0	0	0	0	0
8:15 AM	0	0	0	0	0
8:30 AM	0	0	1	0	1
8:45 AM	0	0	1	2	3
TOTAL	1	1	4	10	16
PM					
4:00 PM	0	1	2	3	6
4:15 PM	0	0	0	0	0
4:30 PM	0	0	0	2	2
4:45 PM	0	0	0	0	0
5:00 PM	0	0	0	2	2
5:15 PM	0	0	0	1	1
5:30 PM	0	0	2	2	4
5:45 PM	0	0	0	0	0
TOTAL	0	1	4	10	15

City of Santa Ana
 N/S: Cambridge Street
 E/W: Fairhaven Avenue
 Weather: Clear

File Name : 86_SNA_Cambridge_Fairhaven AM
 Site Code : 20220171
 Start Date : 3/12/2020
 Page No : 1

Groups Printed- Total Volume

Start Time	Cambridge Street Southbound			Fairhaven Avenue Westbound			Fairhaven Avenue Eastbound			Int. Total
	Left	Right	App. Total	Thru	Right	App. Total	Left	Thru	App. Total	
07:00 AM	74	26	100	16	15	31	5	36	41	172
07:15 AM	97	37	134	45	23	68	12	27	39	241
07:30 AM	117	58	175	59	42	101	16	50	66	342
07:45 AM	131	62	193	71	45	116	24	67	91	400
Total	419	183	602	191	125	316	57	180	237	1155
08:00 AM	122	56	178	62	57	119	13	69	82	379
08:15 AM	103	33	136	44	40	84	16	59	75	295
08:30 AM	73	34	107	37	26	63	9	41	50	220
08:45 AM	64	35	99	27	27	54	14	35	49	202
Total	362	158	520	170	150	320	52	204	256	1096
Grand Total	781	341	1122	361	275	636	109	384	493	2251
Apprch %	69.6	30.4		56.8	43.2		22.1	77.9		
Total %	34.7	15.1	49.8	16	12.2	28.3	4.8	17.1	21.9	

Start Time	Cambridge Street Southbound			Fairhaven Avenue Westbound			Fairhaven Avenue Eastbound			Int. Total
	Left	Right	App. Total	Thru	Right	App. Total	Left	Thru	App. Total	
07:30 AM	117	58	175	59	42	101	16	50	66	342
07:45 AM	131	62	193	71	45	116	24	67	91	400
08:00 AM	122	56	178	62	57	119	13	69	82	379
08:15 AM	103	33	136	44	40	84	16	59	75	295
Total Volume	473	209	682	236	184	420	69	245	314	1416
% App. Total	69.4	30.6		56.2	43.8		22	78		
PHF	.903	.843	.883	.831	.807	.882	.719	.888	.863	.885

Peak Hour Analysis From 07:00 AM to 08:45 AM - Peak 1 of 1
 Peak Hour for Entire Intersection Begins at 07:30 AM

City of Santa Ana
 N/S: Cambridge Street
 E/W: Fairhaven Avenue
 Weather: Clear

File Name : 86_SNA_Cambridge_Fairhaven AM
 Site Code : 20220171
 Start Date : 3/12/2020
 Page No : 2

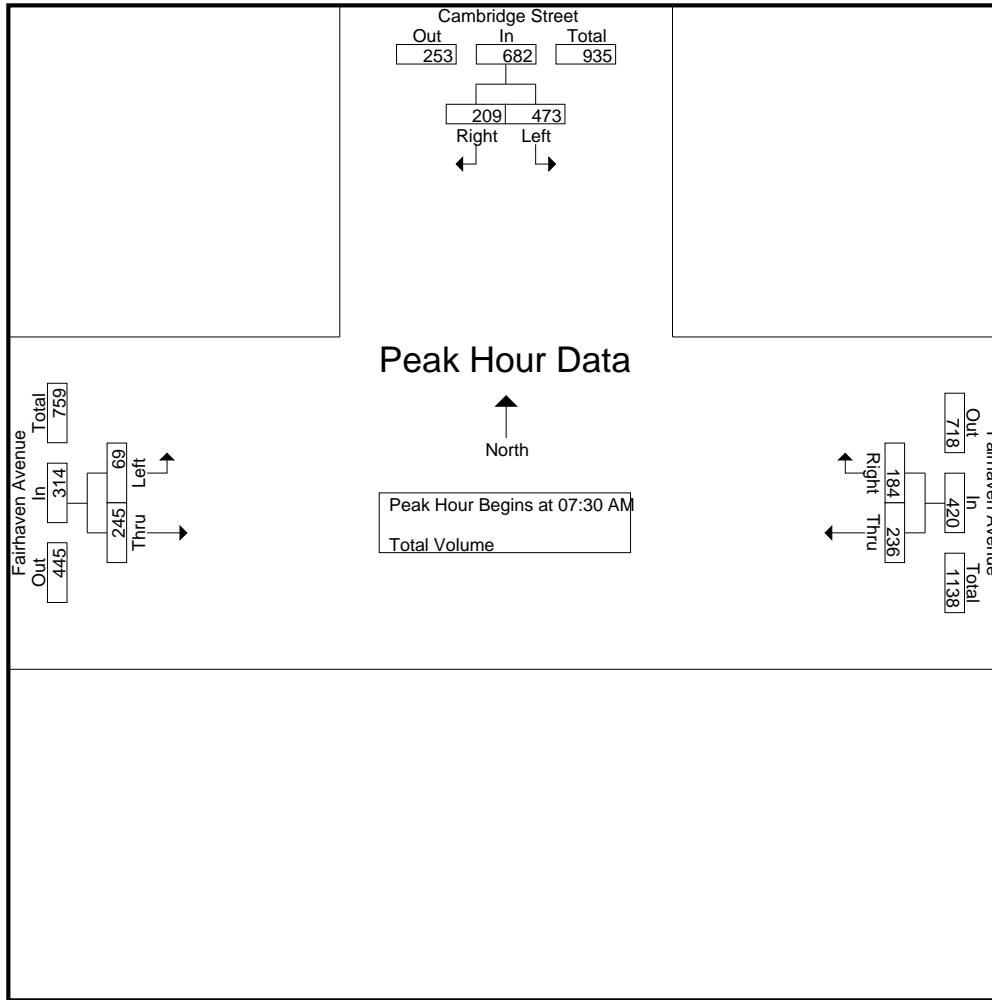

Peak Hour Analysis From 07:00 AM to 08:45 AM - Peak 1 of 1

Peak Hour for Each Approach Begins at:

	07:30 AM			07:30 AM			07:30 AM		
+0 mins.	117	58	175	59	42	101	16	50	66
+15 mins.	131	62	193	71	45	116	24	67	91
+30 mins.	122	56	178	62	57	119	13	69	82
+45 mins.	103	33	136	44	40	84	16	59	75
Total Volume	473	209	682	236	184	420	69	245	314
% App. Total	69.4	30.6		56.2	43.8		22	78	
PHF	.903	.843	.883	.831	.807	.882	.719	.888	.863

City of Santa Ana
 N/S: Cambridge Street
 E/W: Fairhaven Avenue
 Weather: Clear

File Name : 86_SNA_Cambridge_Fairhaven PM
 Site Code : 20220171
 Start Date : 3/12/2020
 Page No : 1

Groups Printed- Total Volume

Start Time	Cambridge Street Southbound			Fairhaven Avenue Westbound			Fairhaven Avenue Eastbound			Int. Total
	Left	Right	App. Total	Thru	Right	App. Total	Left	Thru	App. Total	
04:00 PM	41	19	60	39	46	85	15	40	55	200
04:15 PM	47	14	61	53	57	110	37	47	84	255
04:30 PM	40	20	60	45	52	97	31	63	94	251
04:45 PM	41	19	60	49	71	120	31	48	79	259
Total	169	72	241	186	226	412	114	198	312	965
05:00 PM	51	20	71	76	58	134	22	53	75	280
05:15 PM	38	20	58	47	59	106	42	79	121	285
05:30 PM	42	22	64	49	54	103	30	56	86	253
05:45 PM	39	20	59	52	62	114	33	62	95	268
Total	170	82	252	224	233	457	127	250	377	1086
Grand Total	339	154	493	410	459	869	241	448	689	2051
Apprch %	68.8	31.2		47.2	52.8		35	65		
Total %	16.5	7.5	24	20	22.4	42.4	11.8	21.8	33.6	

Start Time	Cambridge Street Southbound			Fairhaven Avenue Westbound			Fairhaven Avenue Eastbound			Int. Total
	Left	Right	App. Total	Thru	Right	App. Total	Left	Thru	App. Total	
Peak Hour Analysis From 04:00 PM to 05:45 PM - Peak 1 of 1										
Peak Hour for Entire Intersection Begins at 05:00 PM										
05:00 PM	51	20	71	76	58	134	22	53	75	280
05:15 PM	38	20	58	47	59	106	42	79	121	285
05:30 PM	42	22	64	49	54	103	30	56	86	253
05:45 PM	39	20	59	52	62	114	33	62	95	268
Total Volume	170	82	252	224	233	457	127	250	377	1086
% App. Total	67.5	32.5		49	51		33.7	66.3		
PHF	.833	.932	.887	.737	.940	.853	.756	.791	.779	.953

City of Santa Ana
 N/S: Cambridge Street
 E/W: Fairhaven Avenue
 Weather: Clear

File Name : 86_SNA_Cambridge_Fairhaven PM
 Site Code : 20220171
 Start Date : 3/12/2020
 Page No : 2

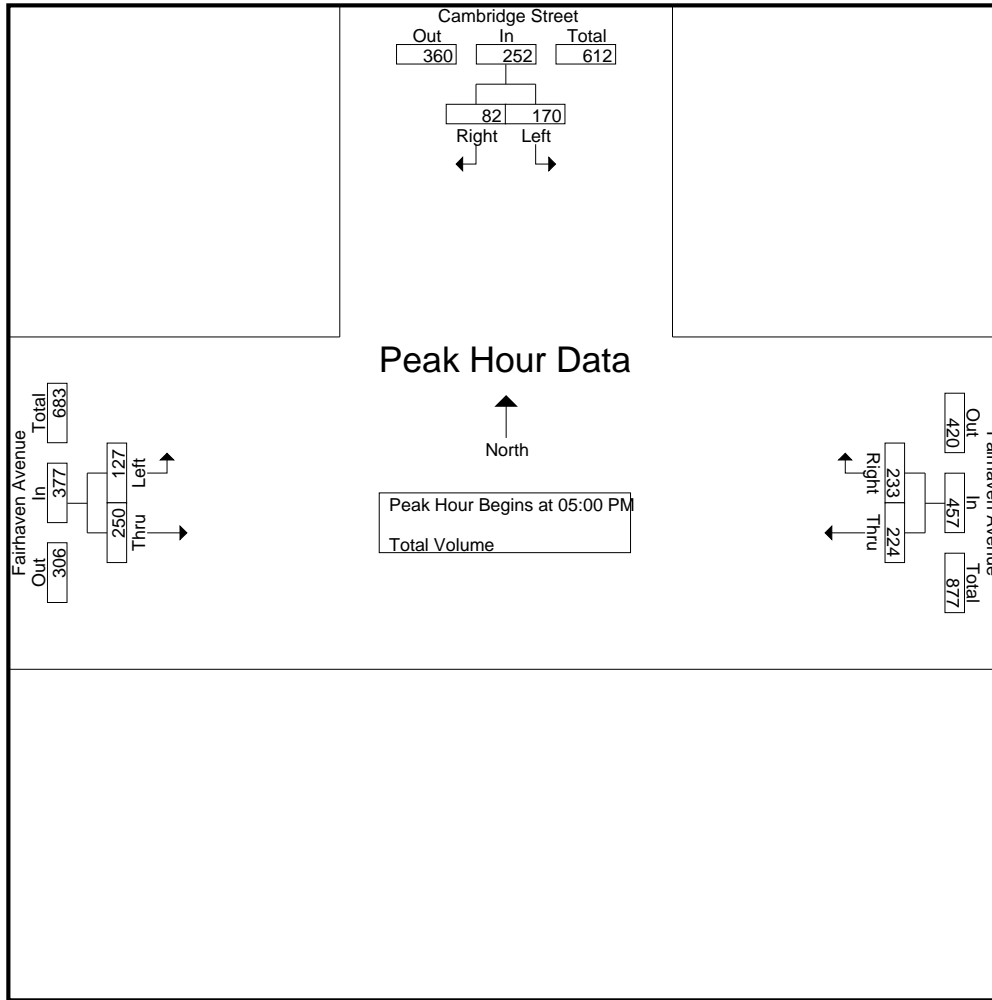

Peak Hour Analysis From 04:00 PM to 05:45 PM - Peak 1 of 1
 Peak Hour for Each Approach Begins at:

	04:45 PM			04:45 PM			05:00 PM		
+0 mins.	41	19	60	49	71	120	22	53	75
+15 mins.	51	20	71	76	58	134	42	79	121
+30 mins.	38	20	58	47	59	106	30	56	86
+45 mins.	42	22	64	49	54	103	33	62	95
Total Volume	172	81	253	221	242	463	127	250	377
% App. Total	68	32		47.7	52.3		33.7	66.3	
PHF	.843	.920	.891	.727	.852	.864	.756	.791	.779

City of Santa Ana
 N/S: Mabury St/Elk Lane
 E/W: E First Street
 Weather: Clear

File Name : 87_SNA_Mabury_1st AM
 Site Code : 20220171
 Start Date : 3/12/2020
 Page No : 1

Groups Printed- Total Volume

Start Time	Mabury Street Southbound				E First Street Westbound				Elk Lane Northbound				E First Street Eastbound				Int. Total
	Left	Thru	Right	App. Total	Left	Thru	Right	App. Total	Left	Thru	Right	App. Total	Left	Thru	Right	App. Total	
07:00 AM	57	32	132	221	6	91	0	97	2	0	52	54	0	262	8	270	642
07:15 AM	50	30	157	237	6	144	0	150	3	0	58	61	0	264	2	266	714
07:30 AM	53	37	134	224	12	191	0	203	3	0	75	78	0	265	2	267	772
07:45 AM	67	35	139	241	13	190	0	203	3	0	67	70	0	256	3	259	773
Total	227	134	562	923	37	616	0	653	11	0	252	263	0	1047	15	1062	2901
08:00 AM	58	38	114	210	8	171	0	179	2	0	52	54	0	277	2	279	722
08:15 AM	60	31	146	237	13	149	0	162	2	0	50	52	0	264	4	268	719
08:30 AM	61	31	122	214	13	131	0	144	3	0	46	49	0	291	3	294	701
08:45 AM	56	35	130	221	3	127	0	130	1	0	48	49	0	282	4	286	686
Total	235	135	512	882	37	578	0	615	8	0	196	204	0	1114	13	1127	2828
Grand Total	462	269	1074	1805	74	1194	0	1268	19	0	448	467	0	2161	28	2189	5729
Apprch %	25.6	14.9	59.5		5.8	94.2	0		4.1	0	95.9		0	98.7	1.3		
Total %	8.1	4.7	18.7	31.5	1.3	20.8	0	22.1	0.3	0	7.8	8.2	0	37.7	0.5	38.2	

Start Time	Mabury Street Southbound				E First Street Westbound				Elk Lane Northbound				E First Street Eastbound				Int. Total
	Left	Thru	Right	App. Total	Left	Thru	Right	App. Total	Left	Thru	Right	App. Total	Left	Thru	Right	App. Total	
Peak Hour Analysis From 07:00 AM to 08:45 AM - Peak 1 of 1																	
Peak Hour for Entire Intersection Begins at 07:30 AM																	
07:30 AM	53	37	134	224	12	191	0	203	3	0	75	78	0	265	2	267	772
07:45 AM	67	35	139	241	13	190	0	203	3	0	67	70	0	256	3	259	773
08:00 AM	58	38	114	210	8	171	0	179	2	0	52	54	0	277	2	279	722
08:15 AM	60	31	146	237	13	149	0	162	2	0	50	52	0	264	4	268	719
Total Volume	238	141	533	912	46	701	0	747	10	0	244	254	0	1062	11	1073	2986
% App. Total	26.1	15.5	58.4		6.2	93.8	0		3.9	0	96.1		0	99	1		
PHF	.888	.928	.913	.946	.885	.918	.000	.920	.833	.000	.813	.814	.000	.958	.688	.961	.966

City of Santa Ana
 N/S: Mabury St/Elk Lane
 E/W: E First Street
 Weather: Clear

File Name : 87_SNA_Mabury_1st AM
 Site Code : 20220171
 Start Date : 3/12/2020
 Page No : 2

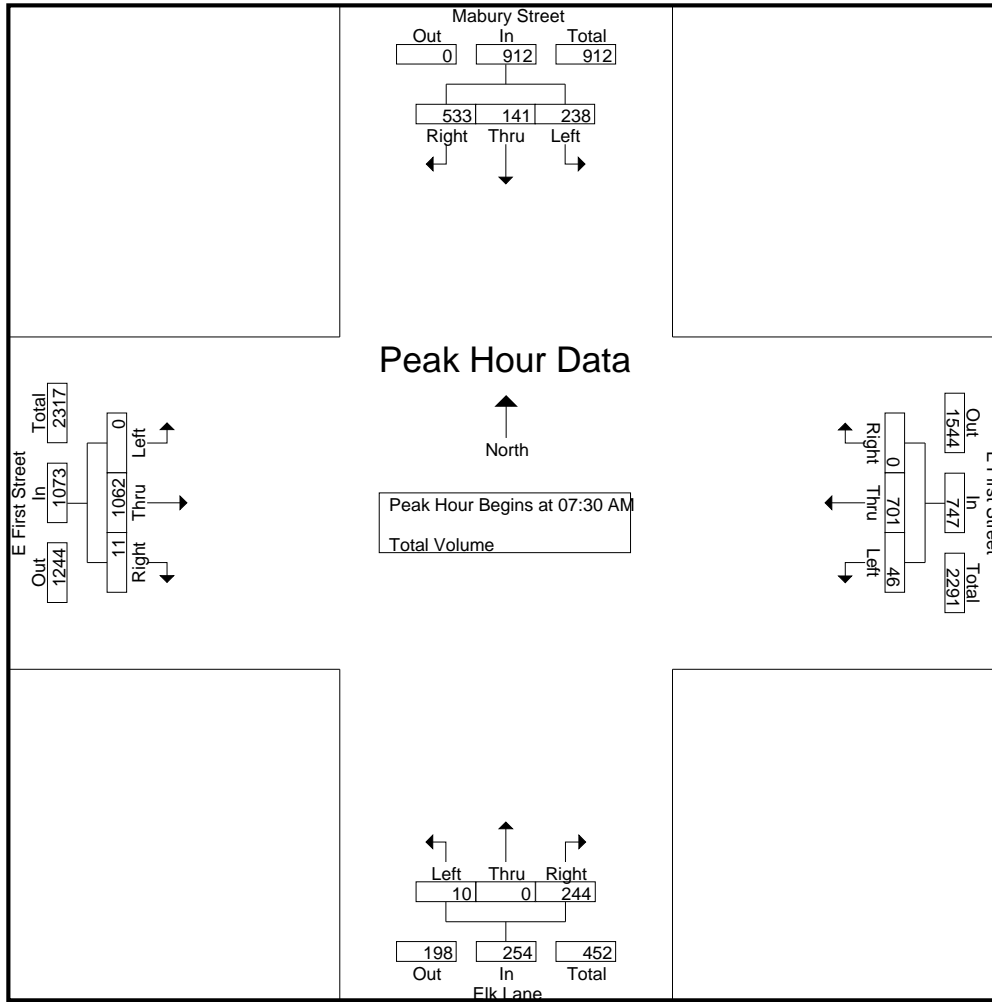

Peak Hour Analysis From 07:00 AM to 08:45 AM - Peak 1 of 1
 Peak Hour for Each Approach Begins at:

	07:00 AM				07:30 AM				07:00 AM				08:00 AM			
+0 mins.	57	32	132	221	12	191	0	203	2	0	52	54	0	277	2	279
+15 mins.	50	30	157	237	13	190	0	203	3	0	58	61	0	264	4	268
+30 mins.	53	37	134	224	8	171	0	179	3	0	75	78	0	291	3	294
+45 mins.	67	35	139	241	13	149	0	162	3	0	67	70	0	282	4	286
Total Volume	227	134	562	923	46	701	0	747	11	0	252	263	0	1114	13	1127
% App. Total	24.6	14.5	60.9		6.2	93.8	0		4.2	0	95.8		0	98.8	1.2	
PHF	.847	.905	.895	.957	.885	.918	.000	.920	.917	.000	.840	.843	.000	.957	.813	.958

City of Santa Ana
 N/S: Mabury St/Elk Lane
 E/W: E First Street
 Weather: Clear

File Name : 87_SNA_Mabury_1st PM
 Site Code : 20220171
 Start Date : 3/12/2020
 Page No : 1

Groups Printed- Total Volume

Start Time	Mabury Street Southbound				E First Street Westbound				Elk Lane Northbound				E First Street Eastbound				Int. Total
	Left	Thru	Right	App. Total	Left	Thru	Right	App. Total	Left	Thru	Right	App. Total	Left	Thru	Right	App. Total	
04:00 PM	64	29	90	183	10	151	0	161	10	0	75	85	0	332	2	334	763
04:15 PM	39	15	97	151	15	153	0	168	4	0	55	59	0	314	4	318	696
04:30 PM	58	31	98	187	5	141	0	146	6	0	89	95	0	295	4	299	727
04:45 PM	37	23	100	160	12	126	0	138	5	0	70	75	0	379	4	383	756
Total	198	98	385	681	42	571	0	613	25	0	289	314	0	1320	14	1334	2942
05:00 PM	59	21	109	189	8	151	0	159	3	0	49	52	0	374	6	380	780
05:15 PM	64	25	96	185	13	166	0	179	9	0	75	84	0	351	8	359	807
05:30 PM	47	19	85	151	7	106	0	113	8	0	62	70	0	408	6	414	748
05:45 PM	54	28	106	188	15	99	0	114	5	0	72	77	0	327	7	334	713
Total	224	93	396	713	43	522	0	565	25	0	258	283	0	1460	27	1487	3048
Grand Total	422	191	781	1394	85	1093	0	1178	50	0	547	597	0	2780	41	2821	5990
Apprch %	30.3	13.7	56		7.2	92.8	0		8.4	0	91.6		0	98.5	1.5		
Total %	7	3.2	13	23.3	1.4	18.2	0	19.7	0.8	0	9.1	10	0	46.4	0.7	47.1	

Start Time	Mabury Street Southbound				E First Street Westbound				Elk Lane Northbound				E First Street Eastbound				Int. Total
	Left	Thru	Right	App. Total	Left	Thru	Right	App. Total	Left	Thru	Right	App. Total	Left	Thru	Right	App. Total	
Peak Hour Analysis From 04:00 PM to 05:45 PM - Peak 1 of 1																	
Peak Hour for Entire Intersection Begins at 04:45 PM																	
04:45 PM	37	23	100	160	12	126	0	138	5	0	70	75	0	379	4	383	756
05:00 PM	59	21	109	189	8	151	0	159	3	0	49	52	0	374	6	380	780
05:15 PM	64	25	96	185	13	166	0	179	9	0	75	84	0	351	8	359	807
05:30 PM	47	19	85	151	7	106	0	113	8	0	62	70	0	408	6	414	748
Total Volume	207	88	390	685	40	549	0	589	25	0	256	281	0	1512	24	1536	3091
% App. Total	30.2	12.8	56.9		6.8	93.2	0		8.9	0	91.1		0	98.4	1.6		
PHF	.809	.880	.894	.906	.769	.827	.000	.823	.694	.000	.853	.836	.000	.926	.750	.928	.958

City of Santa Ana
 N/S: Mabury St/Elk Lane
 E/W: E First Street
 Weather: Clear

File Name : 87_SNA_Mabury_1st PM
 Site Code : 20220171
 Start Date : 3/12/2020
 Page No : 2

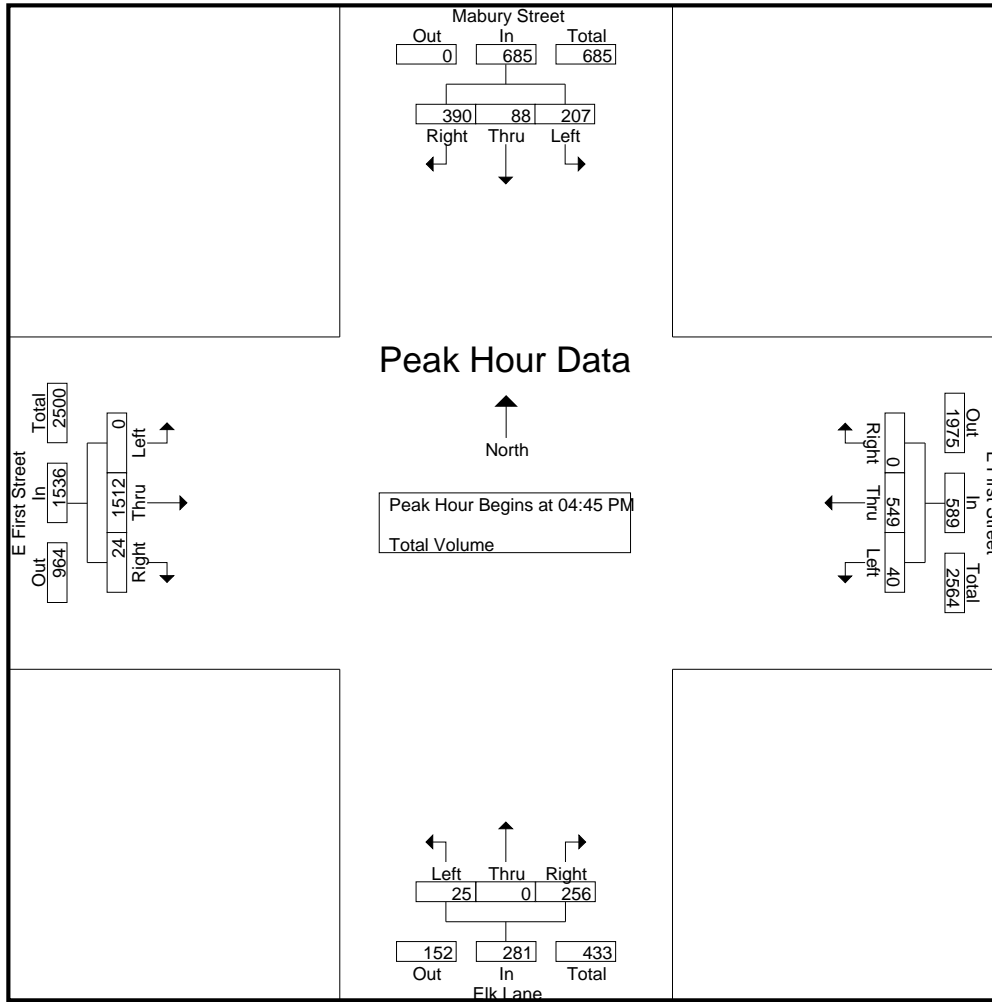

Peak Hour Analysis From 04:00 PM to 05:45 PM - Peak 1 of 1
 Peak Hour for Each Approach Begins at:

	04:30 PM				04:30 PM				04:00 PM				04:45 PM			
+0 mins.	58	31	98	187	5	141	0	146	10	0	75	85	0	379	4	383
+15 mins.	37	23	100	160	12	126	0	138	4	0	55	59	0	374	6	380
+30 mins.	59	21	109	189	8	151	0	159	6	0	89	95	0	351	8	359
+45 mins.	64	25	96	185	13	166	0	179	5	0	70	75	0	408	6	414
Total Volume	218	100	403	721	38	584	0	622	25	0	289	314	0	1512	24	1536
% App. Total	30.2	13.9	55.9		6.1	93.9	0		8	0	92		0	98.4	1.6	
PHF	.852	.806	.924	.954	.731	.880	.000	.869	.625	.000	.812	.826	.000	.926	.750	.928

City of Orange
 N/S: Tustin Street
 E/W: Rock Creek Drive/La Veta Avenue
 Weather: Clear

Groups Printed- Total Volume

Start Time	Tustin Street Southbound				La Veta Avenue Westbound				Tustin Street Northbound				Rock Creek Drive Eastbound				Int. Total
	Left	Thru	Right	App. Total	Left	Thru	Right	App. Total	Left	Thru	Right	App. Total	Left	Thru	Right	App. Total	
07:00 AM	6	346	1	353	84	2	10	96	5	72	22	99	1	1	7	9	557
07:15 AM	19	385	0	404	114	2	11	127	2	79	28	109	1	3	9	13	653
07:30 AM	21	367	0	388	144	0	14	158	0	70	17	87	3	1	9	13	646
07:45 AM	20	378	2	400	95	0	24	119	5	94	21	120	2	6	9	17	656
Total	66	1476	3	1545	437	4	59	500	12	315	88	415	7	11	34	52	2512
08:00 AM	14	322	2	338	94	0	20	114	1	90	30	121	3	1	8	12	585
08:15 AM	14	314	0	328	92	1	24	117	7	89	31	127	0	3	10	13	585
08:30 AM	16	323	0	339	69	0	19	88	4	108	26	138	5	1	9	15	580
08:45 AM	25	295	0	320	60	6	21	87	3	122	25	150	5	0	3	8	565
Total	69	1254	2	1325	315	7	84	406	15	409	112	536	13	5	30	48	2315
Grand Total	135	2730	5	2870	752	11	143	906	27	724	200	951	20	16	64	100	4827
Apprch %	4.7	95.1	0.2		83	1.2	15.8		2.8	76.1	21		20	16	64		
Total %	2.8	56.6	0.1	59.5	15.6	0.2	3	18.8	0.6	15	4.1	19.7	0.4	0.3	1.3	2.1	

Start Time	Tustin Street Southbound				La Veta Avenue Westbound				Tustin Street Northbound				Rock Creek Drive Eastbound				Int. Total
	Left	Thru	Right	App. Total	Left	Thru	Right	App. Total	Left	Thru	Right	App. Total	Left	Thru	Right	App. Total	
Peak Hour Analysis From 07:00 AM to 08:45 AM - Peak 1 of 1																	
Peak Hour for Entire Intersection Begins at 07:15 AM																	
07:15 AM	19	385	0	404	114	2	11	127	2	79	28	109	1	3	9	13	653
07:30 AM	21	367	0	388	144	0	14	158	0	70	17	87	3	1	9	13	646
07:45 AM	20	378	2	400	95	0	24	119	5	94	21	120	2	6	9	17	656
08:00 AM	14	322	2	338	94	0	20	114	1	90	30	121	3	1	8	12	585
Total Volume	74	1452	4	1530	447	2	69	518	8	333	96	437	9	11	35	55	2540
% App. Total	4.8	94.9	0.3		86.3	0.4	13.3		1.8	76.2	22		16.4	20	63.6		
PHF	.881	.943	.500	.947	.776	.250	.719	.820	.400	.886	.800	.903	.750	.458	.972	.809	.968

City of Orange
 N/S: Tustin Street
 E/W: Rock Creek Drive/La Veta Avenue
 Weather: Clear

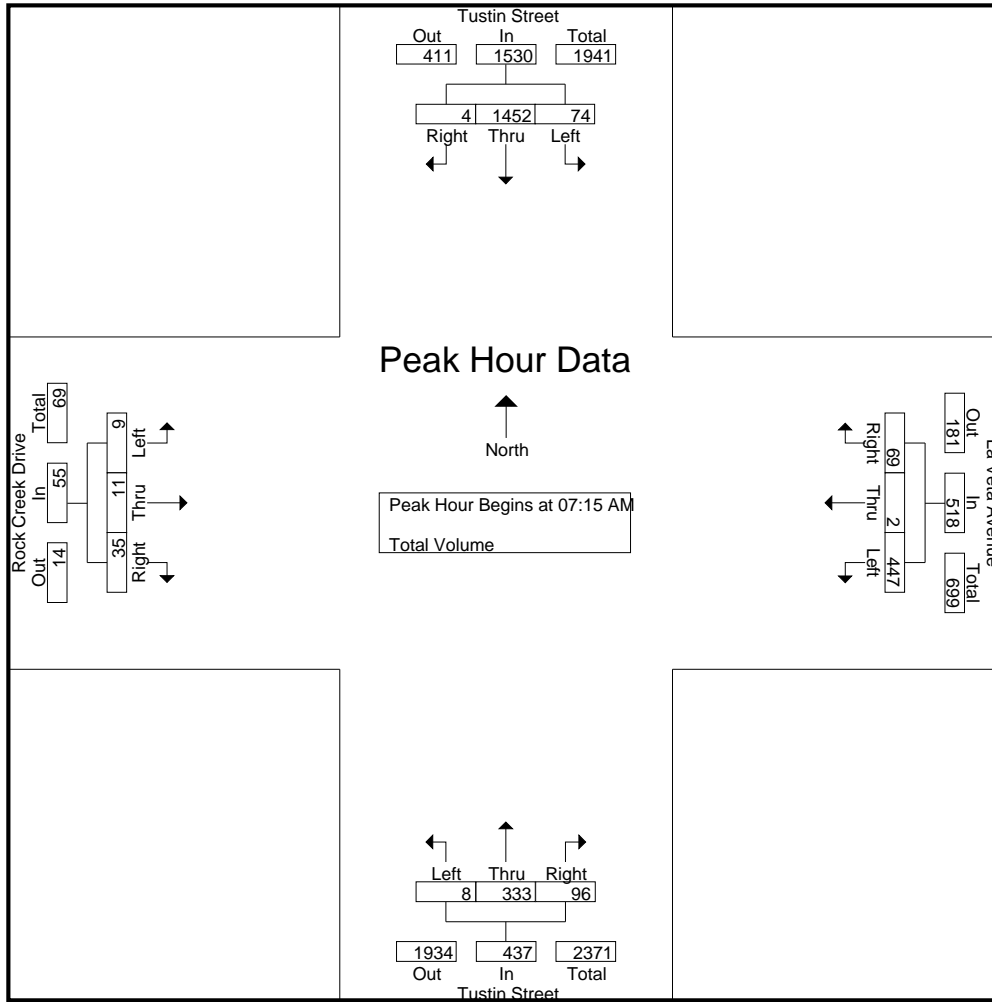

Peak Hour Analysis From 07:00 AM to 08:45 AM - Peak 1 of 1
 Peak Hour for Each Approach Begins at:

	07:00 AM				07:15 AM				08:00 AM				07:45 AM			
+0 mins.	6	346	1	353	114	2	11	127	1	90	30	121	2	6	9	17
+15 mins.	19	385	0	404	144	0	14	158	7	89	31	127	3	1	8	12
+30 mins.	21	367	0	388	95	0	24	119	4	108	26	138	0	3	10	13
+45 mins.	20	378	2	400	94	0	20	114	3	122	25	150	5	1	9	15
Total Volume	66	1476	3	1545	447	2	69	518	15	409	112	536	10	11	36	57
% App. Total	4.3	95.5	0.2		86.3	0.4	13.3		2.8	76.3	20.9		17.5	19.3	63.2	
PHF	.786	.958	.375	.956	.776	.250	.719	.820	.536	.838	.903	.893	.500	.458	.900	.838

City of Orange
 N/S: Tustin Street
 E/W: Rock Creek Drive/La Veta Avenue
 Weather: Clear

Groups Printed- Total Volume

Start Time	Tustin Street Southbound				La Veta Avenue Westbound				Tustin Street Northbound				Rock Creek Drive Eastbound				Int. Total
	Left	Thru	Right	App. Total	Left	Thru	Right	App. Total	Left	Thru	Right	App. Total	Left	Thru	Right	App. Total	
04:00 PM	26	208	1	235	59	3	32	94	5	285	56	346	4	1	2	7	682
04:15 PM	16	163	1	180	32	0	33	65	12	253	51	316	3	2	4	9	570
04:30 PM	18	191	5	214	55	0	24	79	9	272	52	333	2	1	5	8	634
04:45 PM	19	195	2	216	50	4	24	78	12	232	76	320	2	1	1	4	618
Total	79	757	9	845	196	7	113	316	38	1042	235	1315	11	5	12	28	2504
05:00 PM	28	224	6	258	33	1	35	69	15	278	63	356	6	1	10	17	700
05:15 PM	25	191	2	218	45	0	29	74	10	251	54	315	3	2	4	9	616
05:30 PM	34	168	4	206	51	3	23	77	19	231	49	299	5	4	2	11	593
05:45 PM	16	195	1	212	37	4	32	73	10	255	67	332	4	9	3	16	633
Total	103	778	13	894	166	8	119	293	54	1015	233	1302	18	16	19	53	2542
Grand Total	182	1535	22	1739	362	15	232	609	92	2057	468	2617	29	21	31	81	5046
Apprch %	10.5	88.3	1.3		59.4	2.5	38.1		3.5	78.6	17.9		35.8	25.9	38.3		
Total %	3.6	30.4	0.4	34.5	7.2	0.3	4.6	12.1	1.8	40.8	9.3	51.9	0.6	0.4	0.6	1.6	

Start Time	Tustin Street Southbound				La Veta Avenue Westbound				Tustin Street Northbound				Rock Creek Drive Eastbound				Int. Total
	Left	Thru	Right	App. Total	Left	Thru	Right	App. Total	Left	Thru	Right	App. Total	Left	Thru	Right	App. Total	
Peak Hour Analysis From 04:00 PM to 05:45 PM - Peak 1 of 1																	
Peak Hour for Entire Intersection Begins at 04:30 PM																	
04:30 PM	18	191	5	214	55	0	24	79	9	272	52	333	2	1	5	8	634
04:45 PM	19	195	2	216	50	4	24	78	12	232	76	320	2	1	1	4	618
05:00 PM	28	224	6	258	33	1	35	69	15	278	63	356	6	1	10	17	700
05:15 PM	25	191	2	218	45	0	29	74	10	251	54	315	3	2	4	9	616
Total Volume	90	801	15	906	183	5	112	300	46	1033	245	1324	13	5	20	38	2568
% App. Total	9.9	88.4	1.7		61	1.7	37.3		3.5	78	18.5		34.2	13.2	52.6		
PHF	.804	.894	.625	.878	.832	.313	.800	.949	.767	.929	.806	.930	.542	.625	.500	.559	.917

City of Orange
 N/S: Tustin Street
 E/W: Rock Creek Drive/La Veta Avenue
 Weather: Clear

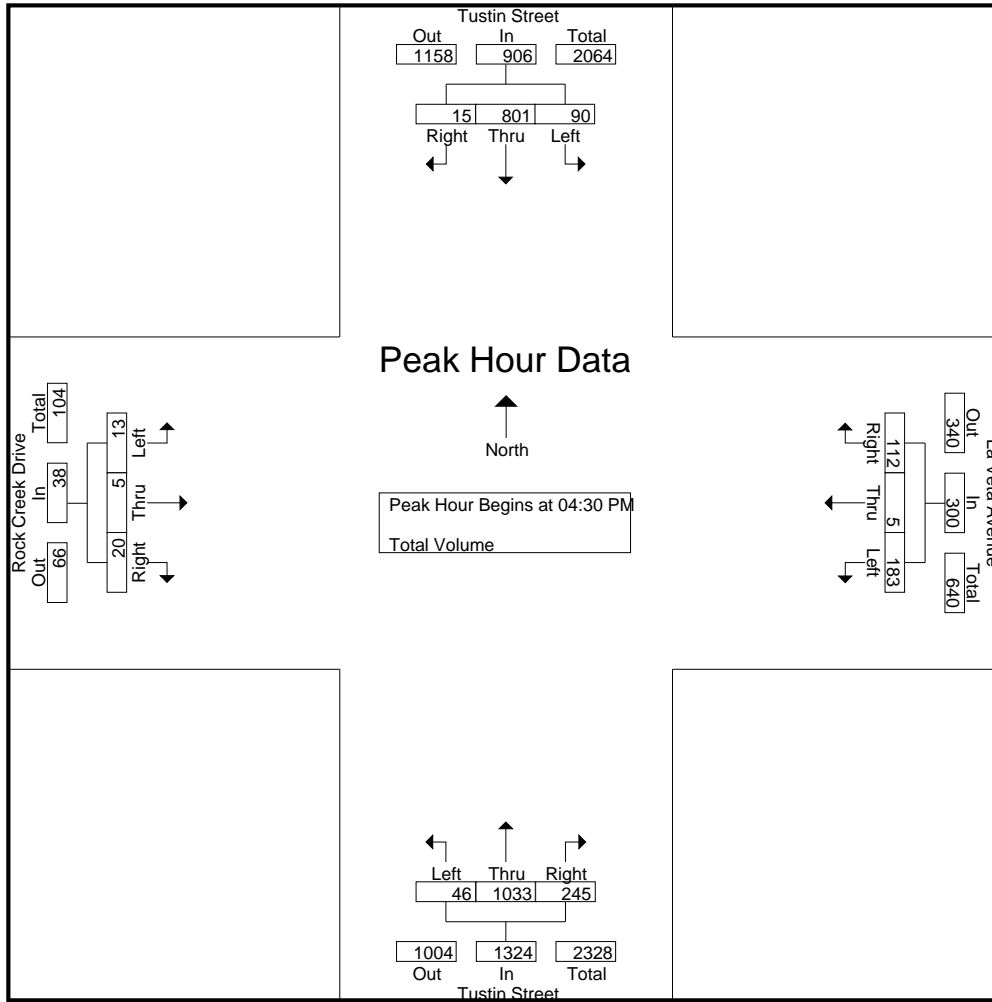

Peak Hour Analysis From 04:00 PM to 05:45 PM - Peak 1 of 1
 Peak Hour for Each Approach Begins at:

	04:30 PM				04:00 PM				04:15 PM				05:00 PM			
+0 mins.	18	191	5	214	59	3	32	94	12	253	51	316	6	1	10	17
+15 mins.	19	195	2	216	32	0	33	65	9	272	52	333	3	2	4	9
+30 mins.	28	224	6	258	55	0	24	79	12	232	76	320	5	4	2	11
+45 mins.	25	191	2	218	50	4	24	78	15	278	63	356	4	9	3	16
Total Volume	90	801	15	906	196	7	113	316	48	1035	242	1325	18	16	19	53
% App. Total	9.9	88.4	1.7		62	2.2	35.8		3.6	78.1	18.3		34	30.2	35.8	
PHF	.804	.894	.625	.878	.831	.438	.856	.840	.800	.931	.796	.930	.750	.444	.475	.779

City of Orange
 N/S: Tustin Street
 E/W: SR-22 Westbound On Ramp
 Weather: Clear

File Name : 89_ORN_Tustin_22W AM
 Site Code : 20220171
 Start Date : 3/12/2020
 Page No : 1

Groups Printed- Total Volume

Start Time	Tustin Street Southbound				Orange Tustin Inn Driveway Westbound				Tustin Street Northbound				SR-22 Westbound On Ramp Eastbound				Int. Total
	Left	Thru	Right	App. Total	Left	Thru	Right	App. Total	Left	Thru	Right	App. Total	Left	Thru	Right	App. Total	
07:00 AM	0	301	193	494	0	0	0	0	102	115	0	217	0	0	0	0	711
07:15 AM	0	389	195	584	0	0	0	0	127	115	0	242	0	0	0	0	826
07:30 AM	0	355	210	565	0	0	0	0	170	154	0	324	0	0	0	0	889
07:45 AM	0	329	233	562	0	0	0	0	216	161	0	377	0	0	0	0	939
Total	0	1374	831	2205	0	0	0	0	615	545	0	1160	0	0	0	0	3365
08:00 AM	0	322	195	517	0	0	0	0	143	180	0	323	0	0	0	0	840
08:15 AM	0	300	186	486	0	0	0	0	151	168	0	319	0	0	0	0	805
08:30 AM	0	269	151	420	0	0	0	0	121	156	0	277	0	0	0	0	697
08:45 AM	0	231	148	379	0	0	0	0	94	170	0	264	0	0	0	0	643
Total	0	1122	680	1802	0	0	0	0	509	674	0	1183	0	0	0	0	2985
Grand Total	0	2496	1511	4007	0	0	0	0	1124	1219	0	2343	0	0	0	0	6350
Apprch %	0	62.3	37.7		0	0	0		48	52	0		0	0	0		
Total %	0	39.3	23.8	63.1	0	0	0	0	17.7	19.2	0	36.9	0	0	0	0	

Start Time	Tustin Street Southbound				Orange Tustin Inn Driveway Westbound				Tustin Street Northbound				SR-22 Westbound On Ramp Eastbound				Int. Total
	Left	Thru	Right	App. Total	Left	Thru	Right	App. Total	Left	Thru	Right	App. Total	Left	Thru	Right	App. Total	
Peak Hour Analysis From 07:00 AM to 08:45 AM - Peak 1 of 1																	
Peak Hour for Entire Intersection Begins at 07:15 AM																	
07:15 AM	0	389	195	584	0	0	0	0	127	115	0	242	0	0	0	0	826
07:30 AM	0	355	210	565	0	0	0	0	170	154	0	324	0	0	0	0	889
07:45 AM	0	329	233	562	0	0	0	0	216	161	0	377	0	0	0	0	939
08:00 AM	0	322	195	517	0	0	0	0	143	180	0	323	0	0	0	0	840
Total Volume	0	1395	833	2228	0	0	0	0	656	610	0	1266	0	0	0	0	3494
% App. Total	0	62.6	37.4		0	0	0		51.8	48.2	0		0	0	0		
PHF	.000	.897	.894	.954	.000	.000	.000	.000	.759	.847	.000	.840	.000	.000	.000	.000	.930

City of Orange
 N/S: Tustin Street
 E/W: SR-22 Westbound On Ramp
 Weather: Clear

File Name : 89_ORN_Tustin_22W AM
 Site Code : 20220171
 Start Date : 3/12/2020
 Page No : 2

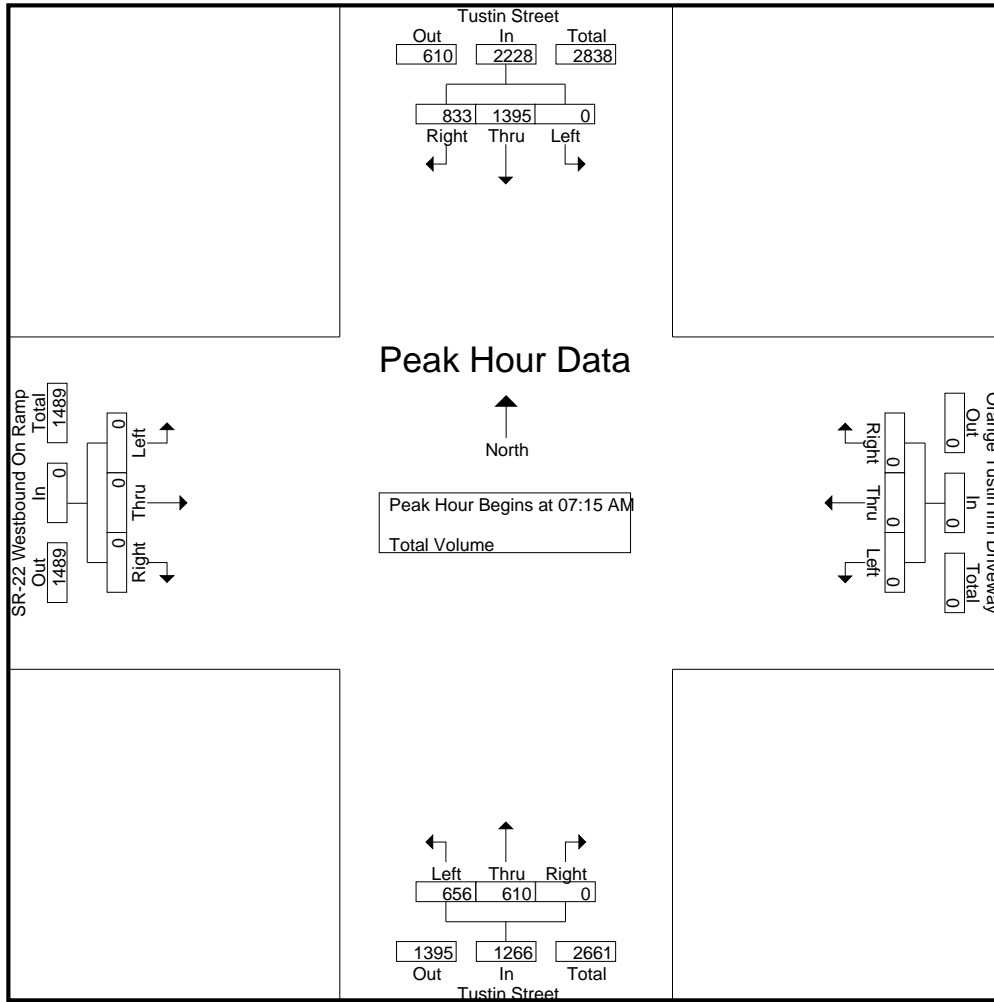

Peak Hour Analysis From 07:00 AM to 08:45 AM - Peak 1 of 1
 Peak Hour for Each Approach Begins at:

	07:15 AM				07:00 AM				07:30 AM				07:00 AM			
+0 mins.	0	389	195	584	0	0	0	0	170	154	0	324	0	0	0	0
+15 mins.	0	355	210	565	0	0	0	0	216	161	0	377	0	0	0	0
+30 mins.	0	329	233	562	0	0	0	0	143	180	0	323	0	0	0	0
+45 mins.	0	322	195	517	0	0	0	0	151	168	0	319	0	0	0	0
Total Volume	0	1395	833	2228	0	0	0	0	680	663	0	1343	0	0	0	0
% App. Total	0	62.6	37.4		0	0	0	0	50.6	49.4	0		0	0	0	0
PHF	.000	.897	.894	.954	.000	.000	.000	.000	.787	.921	.000	.891	.000	.000	.000	.000

City of Orange
 N/S: Tustin Street
 E/W: SR-22 Westbound On Ramp
 Weather: Clear

File Name : 89_ORN_Tustin_22W PM
 Site Code : 20220171
 Start Date : 3/12/2020
 Page No : 1

Groups Printed- Total Volume

Start Time	Tustin Street Southbound				Orange Tustin Inn Driveway Westbound				Tustin Street Northbound				SR-22 Westbound On Ramp Eastbound				Int. Total
	Left	Thru	Right	App. Total	Left	Thru	Right	App. Total	Left	Thru	Right	App. Total	Left	Thru	Right	App. Total	
04:00 PM	0	161	113	274	0	0	0	0	148	374	0	522	0	0	0	0	796
04:15 PM	0	146	88	234	0	0	0	0	142	377	0	519	0	0	0	0	753
04:30 PM	0	148	102	250	0	0	0	0	142	376	0	518	0	0	0	0	768
04:45 PM	0	166	100	266	0	0	0	0	111	373	0	484	0	0	0	0	750
Total	0	621	403	1024	0	0	0	0	543	1500	0	2043	0	0	0	0	3067
05:00 PM	0	173	99	272	0	0	0	0	149	379	0	528	0	0	0	0	800
05:15 PM	0	182	98	280	0	0	0	0	130	391	0	521	0	0	0	0	801
05:30 PM	0	190	68	258	0	0	0	0	142	386	0	528	0	0	0	0	786
05:45 PM	0	169	81	250	0	0	0	0	105	391	0	496	0	0	0	0	746
Total	0	714	346	1060	0	0	0	0	526	1547	0	2073	0	0	0	0	3133
Grand Total	0	1335	749	2084	0	0	0	0	1069	3047	0	4116	0	0	0	0	6200
Apprch %	0	64.1	35.9		0	0	0		26	74	0		0	0	0		
Total %	0	21.5	12.1	33.6	0	0	0	0	17.2	49.1	0	66.4	0	0	0	0	

Start Time	Tustin Street Southbound				Orange Tustin Inn Driveway Westbound				Tustin Street Northbound				SR-22 Westbound On Ramp Eastbound				Int. Total
	Left	Thru	Right	App. Total	Left	Thru	Right	App. Total	Left	Thru	Right	App. Total	Left	Thru	Right	App. Total	
Peak Hour Analysis From 04:00 PM to 05:45 PM - Peak 1 of 1																	
Peak Hour for Entire Intersection Begins at 04:45 PM																	
04:45 PM	0	166	100	266	0	0	0	0	111	373	0	484	0	0	0	0	750
05:00 PM	0	173	99	272	0	0	0	0	149	379	0	528	0	0	0	0	800
05:15 PM	0	182	98	280	0	0	0	0	130	391	0	521	0	0	0	0	801
05:30 PM	0	190	68	258	0	0	0	0	142	386	0	528	0	0	0	0	786
Total Volume	0	711	365	1076	0	0	0	0	532	1529	0	2061	0	0	0	0	3137
% App. Total	0	66.1	33.9		0	0	0		25.8	74.2	0		0	0	0		
PHF	.000	.936	.913	.961	.000	.000	.000	.000	.893	.978	.000	.976	.000	.000	.000	.000	.979

City of Orange
 N/S: Tustin Street
 E/W: SR-22 Westbound On Ramp
 Weather: Clear

File Name : 89_ORN_Tustin_22W PM
 Site Code : 20220171
 Start Date : 3/12/2020
 Page No : 2

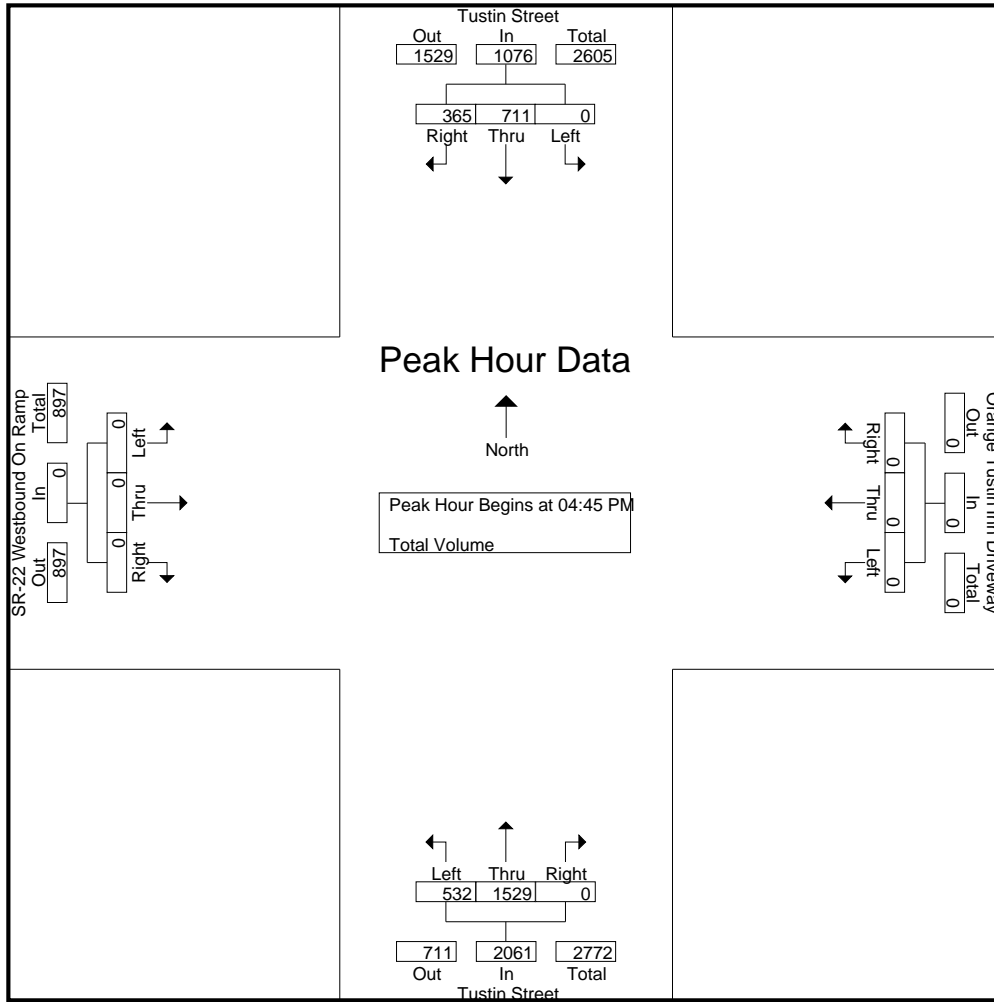

Peak Hour Analysis From 04:00 PM to 05:45 PM - Peak 1 of 1
 Peak Hour for Each Approach Begins at:

	04:45 PM				04:00 PM				05:00 PM				04:00 PM			
+0 mins.	0	166	100	266	0	0	0	0	149	379	0	528	0	0	0	0
+15 mins.	0	173	99	272	0	0	0	0	130	391	0	521	0	0	0	0
+30 mins.	0	182	98	280	0	0	0	0	142	386	0	528	0	0	0	0
+45 mins.	0	190	68	258	0	0	0	0	105	391	0	496	0	0	0	0
Total Volume	0	711	365	1076	0	0	0	0	526	1547	0	2073	0	0	0	0
% App. Total	0	66.1	33.9		0	0	0	0	25.4	74.6	0		0	0	0	0
PHF	.000	.936	.913	.961	.000	.000	.000	.000	.883	.989	.000	.982	.000	.000	.000	.000

City of Orange
 N/S: Tustin Street
 E/W: SR-22 EB Off Ramp/Seba Avenue
 Weather: Clear

File Name : 90_ORN_Tustin_22E AM
 Site Code : 20220171
 Start Date : 3/12/2020
 Page No : 1

Groups Printed- Total Volume

Start Time	Tustin Street Southbound				Seba Avenue Westbound				Tustin Street Northbound				SR-22 Eastbound Off Ramp Eastbound				Int. Total
	Left	Thru	Right	App. Total	Left	Thru	Right	App. Total	Left	Thru	Right	App. Total	Left	Thru	Right	App. Total	
07:00 AM	2	299	0	301	3	0	4	7	0	170	0	170	49	2	208	259	737
07:15 AM	2	370	0	372	1	0	6	7	0	200	0	200	59	4	288	351	930
07:30 AM	2	316	0	318	0	0	10	10	0	263	1	264	62	9	269	340	932
07:45 AM	5	321	0	326	3	0	15	18	0	291	1	292	51	2	250	303	939
Total	11	1306	0	1317	7	0	35	42	0	924	2	926	221	17	1015	1253	3538
08:00 AM	13	342	0	355	2	0	12	14	0	242	3	245	72	9	244	325	939
08:15 AM	13	294	0	307	4	0	13	17	0	231	0	231	76	8	251	335	890
08:30 AM	6	261	0	267	6	0	9	15	0	217	2	219	63	8	184	255	756
08:45 AM	7	221	0	228	1	0	7	8	0	192	2	194	79	3	227	309	739
Total	39	1118	0	1157	13	0	41	54	0	882	7	889	290	28	906	1224	3324
Grand Total	50	2424	0	2474	20	0	76	96	0	1806	9	1815	511	45	1921	2477	6862
Apprch %	2	98	0		20.8	0	79.2		0	99.5	0.5		20.6	1.8	77.6		
Total %	0.7	35.3	0	36.1	0.3	0	1.1	1.4	0	26.3	0.1	26.5	7.4	0.7	28	36.1	

Start Time	Tustin Street Southbound				Seba Avenue Westbound				Tustin Street Northbound				SR-22 Eastbound Off Ramp Eastbound				Int. Total
	Left	Thru	Right	App. Total	Left	Thru	Right	App. Total	Left	Thru	Right	App. Total	Left	Thru	Right	App. Total	
Peak Hour Analysis From 07:00 AM to 08:45 AM - Peak 1 of 1																	
Peak Hour for Entire Intersection Begins at 07:15 AM																	
07:15 AM	2	370	0	372	1	0	6	7	0	200	0	200	59	4	288	351	930
07:30 AM	2	316	0	318	0	0	10	10	0	263	1	264	62	9	269	340	932
07:45 AM	5	321	0	326	3	0	15	18	0	291	1	292	51	2	250	303	939
08:00 AM	13	342	0	355	2	0	12	14	0	242	3	245	72	9	244	325	939
Total Volume	22	1349	0	1371	6	0	43	49	0	996	5	1001	244	24	1051	1319	3740
% App. Total	1.6	98.4	0		12.2	0	87.8		0	99.5	0.5		18.5	1.8	79.7		
PHF	.423	.911	.000	.921	.500	.000	.717	.681	.000	.856	.417	.857	.847	.667	.912	.939	.996

City of Orange
 N/S: Tustin Street
 E/W: SR-22 EB Off Ramp/Seba Avenue
 Weather: Clear

File Name : 90_ORN_Tustin_22E AM
 Site Code : 20220171
 Start Date : 3/12/2020
 Page No : 2

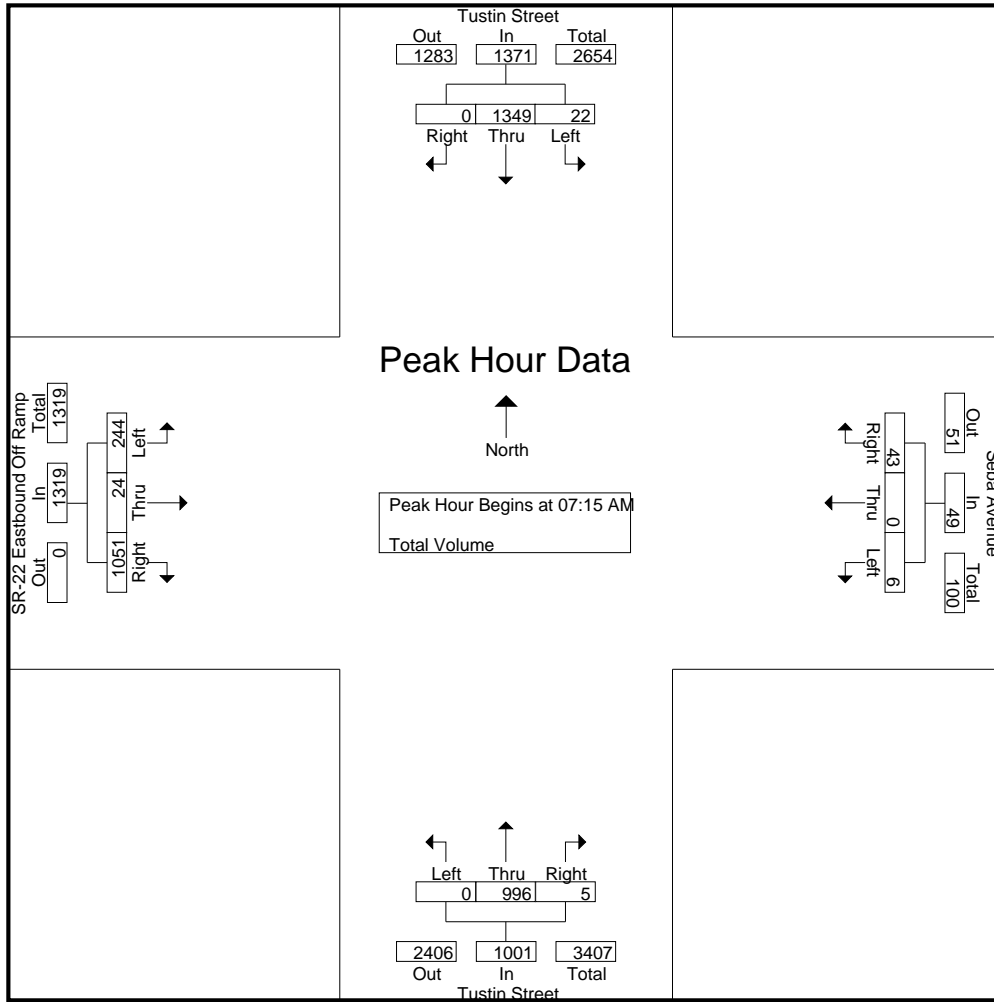

Peak Hour Analysis From 07:00 AM to 08:45 AM - Peak 1 of 1
 Peak Hour for Each Approach Begins at:

	07:15 AM				07:45 AM				07:30 AM				07:15 AM			
+0 mins.	2	370	0	372	3	0	15	18	0	263	1	264	59	4	288	351
+15 mins.	2	316	0	318	2	0	12	14	0	291	1	292	62	9	269	340
+30 mins.	5	321	0	326	4	0	13	17	0	242	3	245	51	2	250	303
+45 mins.	13	342	0	355	6	0	9	15	0	231	0	231	72	9	244	325
Total Volume	22	1349	0	1371	15	0	49	64	0	1027	5	1032	244	24	1051	1319
% App. Total	1.6	98.4	0		23.4	0	76.6		0	99.5	0.5		18.5	1.8	79.7	
PHF	.423	.911	.000	.921	.625	.000	.817	.889	.000	.882	.417	.884	.847	.667	.912	.939

City of Orange
 N/S: Tustin Street
 E/W: SR-22 EB Off Ramp/Seba Avenue
 Weather: Clear

File Name : 90_ORN_Tustin_22E PM
 Site Code : 20220171
 Start Date : 3/12/2020
 Page No : 1

Groups Printed- Total Volume

Start Time	Tustin Street Southbound				Seba Avenue Westbound				Tustin Street Northbound				SR-22 Eastbound Off Ramp Eastbound				Int. Total
	Left	Thru	Right	App. Total	Left	Thru	Right	App. Total	Left	Thru	Right	App. Total	Left	Thru	Right	App. Total	
04:00 PM	7	144	0	151	8	0	10	18	0	359	1	360	164	11	142	317	846
04:15 PM	10	155	0	165	7	0	16	23	0	350	2	352	153	16	146	315	855
04:30 PM	17	142	0	159	6	0	18	24	0	359	2	361	144	7	142	293	837
04:45 PM	14	167	0	181	5	0	11	16	0	380	0	380	114	7	123	244	821
Total	48	608	0	656	26	0	55	81	0	1448	5	1453	575	41	553	1169	3359
05:00 PM	12	177	0	189	8	0	21	29	0	382	1	383	108	10	138	256	857
05:15 PM	10	155	0	165	9	0	18	27	0	372	3	375	120	11	162	293	860
05:30 PM	16	208	0	224	6	0	17	23	0	413	0	413	116	13	158	287	947
05:45 PM	14	144	0	158	5	0	24	29	0	344	2	346	123	7	142	272	805
Total	52	684	0	736	28	0	80	108	0	1511	6	1517	467	41	600	1108	3469
Grand Total	100	1292	0	1392	54	0	135	189	0	2959	11	2970	1042	82	1153	2277	6828
Apprch %	7.2	92.8	0		28.6	0	71.4		0	99.6	0.4		45.8	3.6	50.6		
Total %	1.5	18.9	0	20.4	0.8	0	2	2.8	0	43.3	0.2	43.5	15.3	1.2	16.9	33.3	

Start Time	Tustin Street Southbound				Seba Avenue Westbound				Tustin Street Northbound				SR-22 Eastbound Off Ramp Eastbound				Int. Total
	Left	Thru	Right	App. Total	Left	Thru	Right	App. Total	Left	Thru	Right	App. Total	Left	Thru	Right	App. Total	
Peak Hour Analysis From 04:00 PM to 05:45 PM - Peak 1 of 1																	
Peak Hour for Entire Intersection Begins at 04:45 PM																	
04:45 PM	14	167	0	181	5	0	11	16	0	380	0	380	114	7	123	244	821
05:00 PM	12	177	0	189	8	0	21	29	0	382	1	383	108	10	138	256	857
05:15 PM	10	155	0	165	9	0	18	27	0	372	3	375	120	11	162	293	860
05:30 PM	16	208	0	224	6	0	17	23	0	413	0	413	116	13	158	287	947
Total Volume	52	707	0	759	28	0	67	95	0	1547	4	1551	458	41	581	1080	3485
% App. Total	6.9	93.1	0		29.5	0	70.5		0	99.7	0.3		42.4	3.8	53.8		
PHF	.813	.850	.000	.847	.778	.000	.798	.819	.000	.936	.333	.939	.954	.788	.897	.922	.920

City of Orange
 N/S: Tustin Street
 E/W: SR-22 EB Off Ramp/Seba Avenue
 Weather: Clear

File Name : 90_ORN_Tustin_22E PM
 Site Code : 20220171
 Start Date : 3/12/2020
 Page No : 2

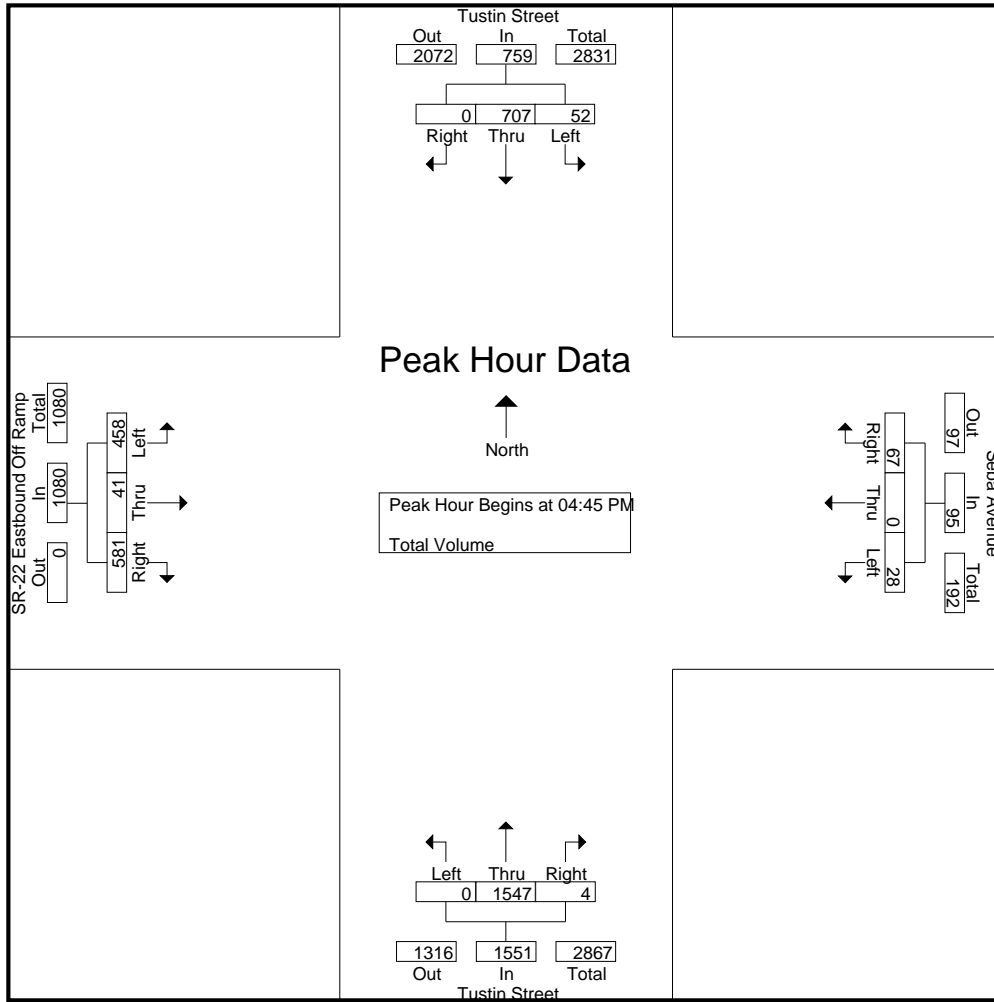

Peak Hour Analysis From 04:00 PM to 05:45 PM - Peak 1 of 1
 Peak Hour for Each Approach Begins at:

	04:45 PM				05:00 PM				04:45 PM				04:00 PM			
+0 mins.	14	167	0	181	8	0	21	29	0	380	0	380	164	11	142	317
+15 mins.	12	177	0	189	9	0	18	27	0	382	1	383	153	16	146	315
+30 mins.	10	155	0	165	6	0	17	23	0	372	3	375	144	7	142	293
+45 mins.	16	208	0	224	5	0	24	29	0	413	0	413	114	7	123	244
Total Volume	52	707	0	759	28	0	80	108	0	1547	4	1551	575	41	553	1169
% App. Total	6.9	93.1	0		25.9	0	74.1		0	99.7	0.3		49.2	3.5	47.3	
PHF	.813	.850	.000	.847	.778	.000	.833	.931	.000	.936	.333	.939	.877	.641	.947	.922

City of Santa Ana
 N/S: Tustin Street/Tustin Avenue
 E/W: Fairhaven Avenue
 Weather: Clear

File Name : 91_SNA_Tustin_Fairhaven AM
 Site Code : 20220171
 Start Date : 3/12/2020
 Page No : 1

Groups Printed- Total Volume

Start Time	Tustin Street Southbound				Fairhaven Avenue Westbound				Tustin Avenue Northbound				Fairhaven Avenue Eastbound				Int. Total
	Left	Thru	Right	App. Total	Left	Thru	Right	App. Total	Left	Thru	Right	App. Total	Left	Thru	Right	App. Total	
07:00 AM	39	455	3	497	44	20	70	134	8	93	12	113	11	27	66	104	848
07:15 AM	59	554	8	621	51	45	85	181	14	108	19	141	14	45	85	144	1087
07:30 AM	61	526	4	591	77	71	112	260	21	123	30	174	17	72	119	208	1233
07:45 AM	67	501	13	581	80	92	139	311	28	138	17	183	16	73	101	190	1265
Total	226	2036	28	2290	252	228	406	886	71	462	78	611	58	217	371	646	4433
08:00 AM	53	520	11	584	81	106	102	289	24	125	23	172	19	57	126	202	1247
08:15 AM	54	479	12	545	68	69	89	226	16	128	20	164	16	56	98	170	1105
08:30 AM	53	399	6	458	54	39	82	175	16	136	19	171	21	50	71	142	946
08:45 AM	49	387	5	441	48	32	61	141	13	109	15	137	17	25	68	110	829
Total	209	1785	34	2028	251	246	334	831	69	498	77	644	73	188	363	624	4127
Grand Total	435	3821	62	4318	503	474	740	1717	140	960	155	1255	131	405	734	1270	8560
Apprch %	10.1	88.5	1.4		29.3	27.6	43.1		11.2	76.5	12.4		10.3	31.9	57.8		
Total %	5.1	44.6	0.7	50.4	5.9	5.5	8.6	20.1	1.6	11.2	1.8	14.7	1.5	4.7	8.6	14.8	

Start Time	Tustin Street Southbound				Fairhaven Avenue Westbound				Tustin Avenue Northbound				Fairhaven Avenue Eastbound				Int. Total
	Left	Thru	Right	App. Total	Left	Thru	Right	App. Total	Left	Thru	Right	App. Total	Left	Thru	Right	App. Total	
Peak Hour Analysis From 07:00 AM to 08:45 AM - Peak 1 of 1																	
Peak Hour for Entire Intersection Begins at 07:30 AM																	
07:30 AM	61	526	4	591	77	71	112	260	21	123	30	174	17	72	119	208	1233
07:45 AM	67	501	13	581	80	92	139	311	28	138	17	183	16	73	101	190	1265
08:00 AM	53	520	11	584	81	106	102	289	24	125	23	172	19	57	126	202	1247
08:15 AM	54	479	12	545	68	69	89	226	16	128	20	164	16	56	98	170	1105
Total Volume	235	2026	40	2301	306	338	442	1086	89	514	90	693	68	258	444	770	4850
% App. Total	10.2	88	1.7		28.2	31.1	40.7		12.8	74.2	13		8.8	33.5	57.7		
PHF	.877	.963	.769	.973	.944	.797	.795	.873	.795	.931	.750	.947	.895	.884	.881	.925	.958

City of Santa Ana
 N/S: Tustin Street/Tustin Avenue
 E/W: Fairhaven Avenue
 Weather: Clear

File Name : 91_SNA_Tustin_Fairhaven AM
 Site Code : 20220171
 Start Date : 3/12/2020
 Page No : 2

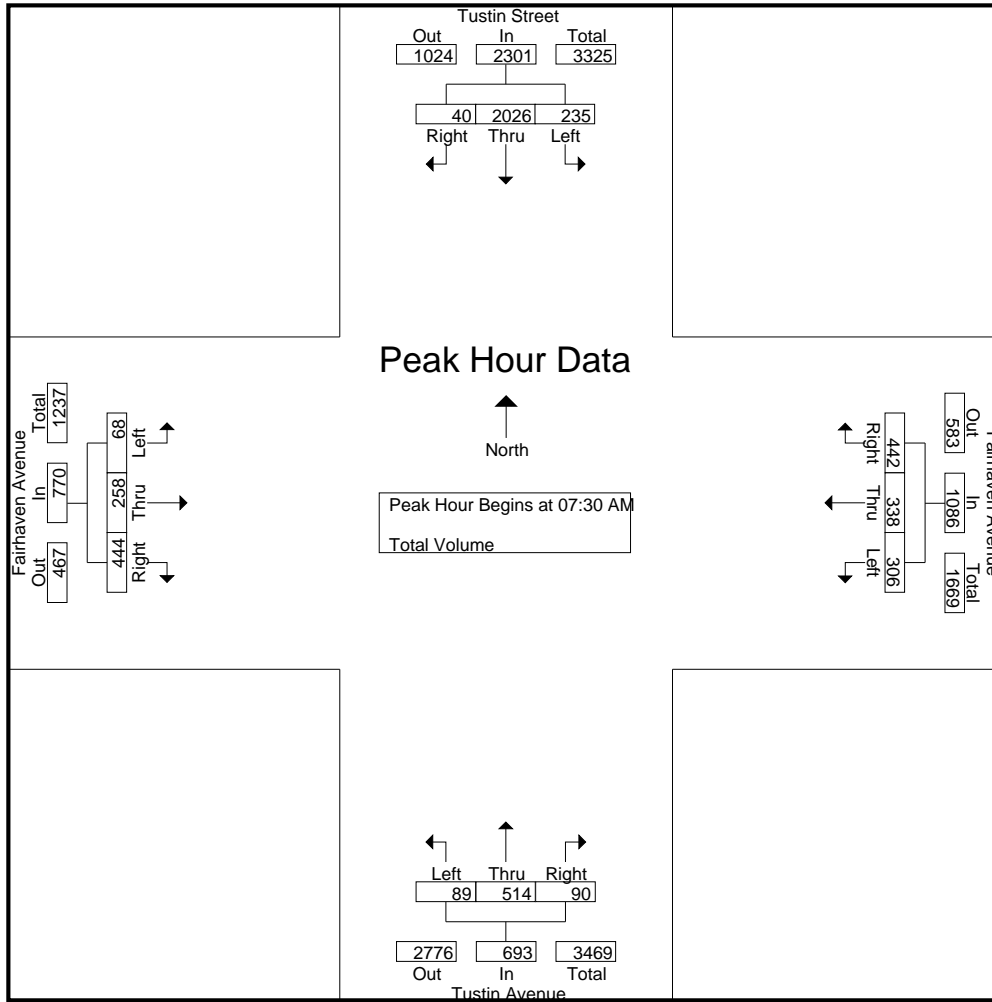

Peak Hour Analysis From 07:00 AM to 08:45 AM - Peak 1 of 1
 Peak Hour for Each Approach Begins at:

	07:15 AM				07:30 AM				07:30 AM				07:30 AM			
+0 mins.	59	554	8	621	77	71	112	260	21	123	30	174	17	72	119	208
+15 mins.	61	526	4	591	80	92	139	311	28	138	17	183	16	73	101	190
+30 mins.	67	501	13	581	81	106	102	289	24	125	23	172	19	57	126	202
+45 mins.	53	520	11	584	68	69	89	226	16	128	20	164	16	56	98	170
Total Volume	240	2101	36	2377	306	338	442	1086	89	514	90	693	68	258	444	770
% App. Total	10.1	88.4	1.5		28.2	31.1	40.7		12.8	74.2	13		8.8	33.5	57.7	
PHF	.896	.948	.692	.957	.944	.797	.795	.873	.795	.931	.750	.947	.895	.884	.881	.925

City of Santa Ana
 N/S: Tustin Street/Tustin Avenue
 E/W: Fairhaven Avenue
 Weather: Clear

File Name : 91_SNA_Tustin_Fairhaven PM
 Site Code : 20220171
 Start Date : 3/12/2020
 Page No : 1

Groups Printed- Total Volume

Start Time	Tustin Street Southbound				Fairhaven Avenue Westbound				Tustin Avenue Northbound				Fairhaven Avenue Eastbound				Int. Total
	Left	Thru	Right	App. Total	Left	Thru	Right	App. Total	Left	Thru	Right	App. Total	Left	Thru	Right	App. Total	
04:00 PM	80	189	19	288	46	39	63	148	48	270	27	345	21	44	32	97	878
04:15 PM	84	210	14	308	25	47	50	122	50	277	35	362	18	40	35	93	885
04:30 PM	68	182	21	271	22	55	51	128	48	289	42	379	19	43	37	99	877
04:45 PM	71	205	18	294	20	47	42	109	66	311	33	410	20	32	38	90	903
Total	303	786	72	1161	113	188	206	507	212	1147	137	1496	78	159	142	379	3543
05:00 PM	72	205	32	309	19	56	51	126	61	324	32	417	23	56	37	116	968
05:15 PM	92	198	28	318	30	46	45	121	57	329	21	407	20	52	39	111	957
05:30 PM	92	254	21	367	25	59	58	142	55	311	27	393	17	40	33	90	992
05:45 PM	70	195	14	279	29	54	47	130	58	273	27	358	17	35	46	98	865
Total	326	852	95	1273	103	215	201	519	231	1237	107	1575	77	183	155	415	3782
Grand Total	629	1638	167	2434	216	403	407	1026	443	2384	244	3071	155	342	297	794	7325
Apprch %	25.8	67.3	6.9		21.1	39.3	39.7		14.4	77.6	7.9		19.5	43.1	37.4		
Total %	8.6	22.4	2.3	33.2	2.9	5.5	5.6	14	6	32.5	3.3	41.9	2.1	4.7	4.1	10.8	

Start Time	Tustin Street Southbound				Fairhaven Avenue Westbound				Tustin Avenue Northbound				Fairhaven Avenue Eastbound				Int. Total
	Left	Thru	Right	App. Total	Left	Thru	Right	App. Total	Left	Thru	Right	App. Total	Left	Thru	Right	App. Total	
Peak Hour Analysis From 04:00 PM to 05:45 PM - Peak 1 of 1																	
Peak Hour for Entire Intersection Begins at 04:45 PM																	
04:45 PM	71	205	18	294	20	47	42	109	66	311	33	410	20	32	38	90	903
05:00 PM	72	205	32	309	19	56	51	126	61	324	32	417	23	56	37	116	968
05:15 PM	92	198	28	318	30	46	45	121	57	329	21	407	20	52	39	111	957
05:30 PM	92	254	21	367	25	59	58	142	55	311	27	393	17	40	33	90	992
Total Volume	327	862	99	1288	94	208	196	498	239	1275	113	1627	80	180	147	407	3820
% App. Total	25.4	66.9	7.7		18.9	41.8	39.4		14.7	78.4	6.9		19.7	44.2	36.1		
PHF	.889	.848	.773	.877	.783	.881	.845	.877	.905	.969	.856	.975	.870	.804	.942	.877	.963

City of Santa Ana
 N/S: Tustin Street/Tustin Avenue
 E/W: Fairhaven Avenue
 Weather: Clear

File Name : 91_SNA_Tustin_Fairhaven PM
 Site Code : 20220171
 Start Date : 3/12/2020
 Page No : 2

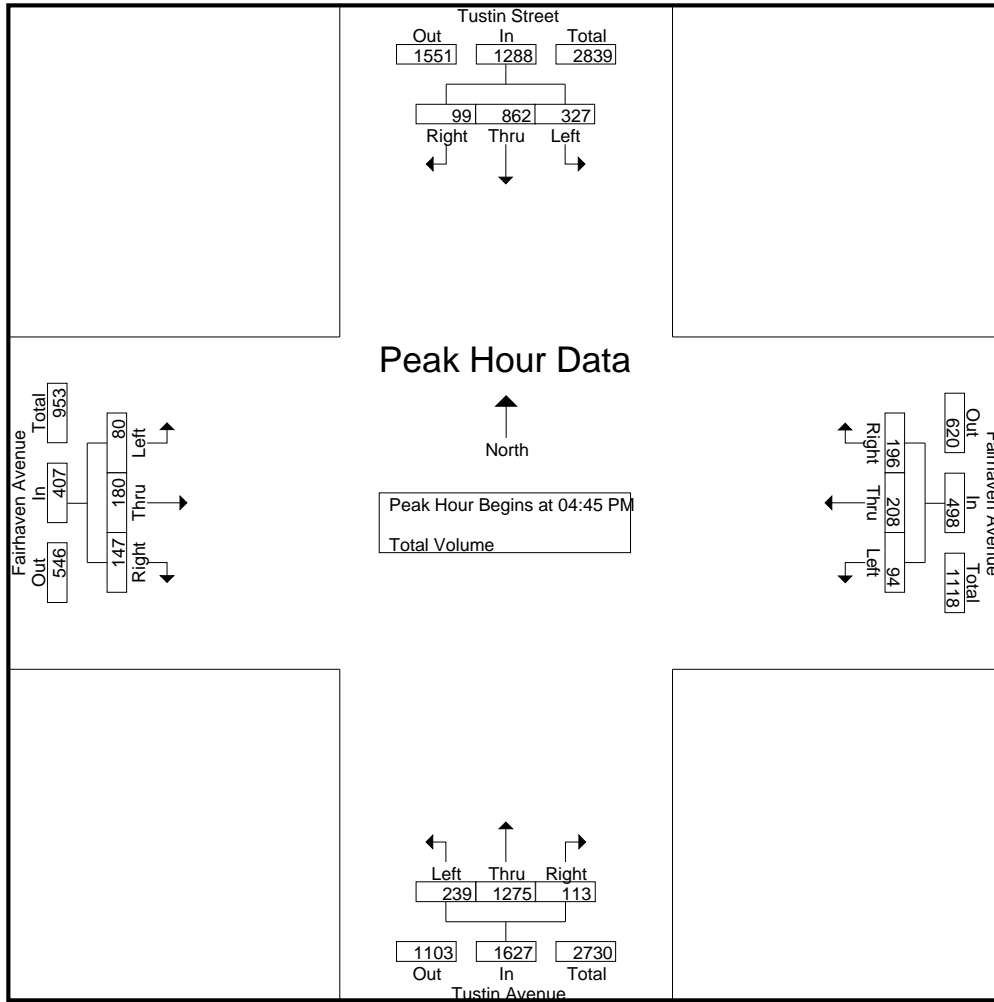

Peak Hour Analysis From 04:00 PM to 05:45 PM - Peak 1 of 1
 Peak Hour for Each Approach Begins at:

	04:45 PM				05:00 PM				04:45 PM				04:30 PM			
+0 mins.	71	205	18	294	19	56	51	126	66	311	33	410	19	43	37	99
+15 mins.	72	205	32	309	30	46	45	121	61	324	32	417	20	32	38	90
+30 mins.	92	198	28	318	25	59	58	142	57	329	21	407	23	56	37	116
+45 mins.	92	254	21	367	29	54	47	130	55	311	27	393	20	52	39	111
Total Volume	327	862	99	1288	103	215	201	519	239	1275	113	1627	82	183	151	416
% App. Total	25.4	66.9	7.7		19.8	41.4	38.7		14.7	78.4	6.9		19.7	44	36.3	
PHF	.889	.848	.773	.877	.858	.911	.866	.914	.905	.969	.856	.975	.891	.817	.968	.897

City of Santa Ana
 N/S: Tustin Avenue
 E/W: Santa Clara Avenue
 Weather: Clear

File Name : 92_SNA_Tustin_Santa Clara AM
 Site Code : 20220171
 Start Date : 3/12/2020
 Page No : 1

Groups Printed- Total Volume

Start Time	Tustin Avenue Southbound				Santa Clara Avenue Westbound				Tustin Avenue Northbound				Santa Clara Avenue Eastbound				Int. Total
	Left	Thru	Right	App. Total	Left	Thru	Right	App. Total	Left	Thru	Right	App. Total	Left	Thru	Right	App. Total	
07:00 AM	19	509	22	550	18	20	21	59	15	65	13	93	23	34	35	92	794
07:15 AM	31	655	24	710	20	29	32	81	9	78	24	111	16	86	40	142	1044
07:30 AM	24	633	22	679	31	67	32	130	17	92	20	129	33	82	54	169	1107
07:45 AM	26	654	15	695	23	59	29	111	22	101	16	139	19	73	32	124	1069
Total	100	2451	83	2634	92	175	114	381	63	336	73	472	91	275	161	527	4014
08:00 AM	33	661	28	722	30	63	37	130	17	101	20	138	32	61	56	149	1139
08:15 AM	44	652	17	713	34	55	24	113	17	103	18	138	17	39	44	100	1064
08:30 AM	23	473	17	513	19	33	23	75	20	94	13	127	25	31	37	93	808
08:45 AM	25	465	18	508	28	28	19	75	14	91	8	113	29	34	54	117	813
Total	125	2251	80	2456	111	179	103	393	68	389	59	516	103	165	191	459	3824
Grand Total	225	4702	163	5090	203	354	217	774	131	725	132	988	194	440	352	986	7838
Apprch %	4.4	92.4	3.2		26.2	45.7	28		13.3	73.4	13.4		19.7	44.6	35.7		
Total %	2.9	60	2.1	64.9	2.6	4.5	2.8	9.9	1.7	9.2	1.7	12.6	2.5	5.6	4.5	12.6	

Start Time	Tustin Avenue Southbound				Santa Clara Avenue Westbound				Tustin Avenue Northbound				Santa Clara Avenue Eastbound				Int. Total
	Left	Thru	Right	App. Total	Left	Thru	Right	App. Total	Left	Thru	Right	App. Total	Left	Thru	Right	App. Total	
Peak Hour Analysis From 07:00 AM to 08:45 AM - Peak 1 of 1																	
Peak Hour for Entire Intersection Begins at 07:30 AM																	
07:30 AM	24	633	22	679	31	67	32	130	17	92	20	129	33	82	54	169	1107
07:45 AM	26	654	15	695	23	59	29	111	22	101	16	139	19	73	32	124	1069
08:00 AM	33	661	28	722	30	63	37	130	17	101	20	138	32	61	56	149	1139
08:15 AM	44	652	17	713	34	55	24	113	17	103	18	138	17	39	44	100	1064
Total Volume	127	2600	82	2809	118	244	122	484	73	397	74	544	101	255	186	542	4379
% App. Total	4.5	92.6	2.9		24.4	50.4	25.2		13.4	73	13.6		18.6	47	34.3		
PHF	.722	.983	.732	.973	.868	.910	.824	.931	.830	.964	.925	.978	.765	.777	.830	.802	.961

City of Santa Ana
 N/S: Tustin Avenue
 E/W: Santa Clara Avenue
 Weather: Clear

File Name : 92_SNA_Tustin_Santa Clara AM
 Site Code : 20220171
 Start Date : 3/12/2020
 Page No : 2

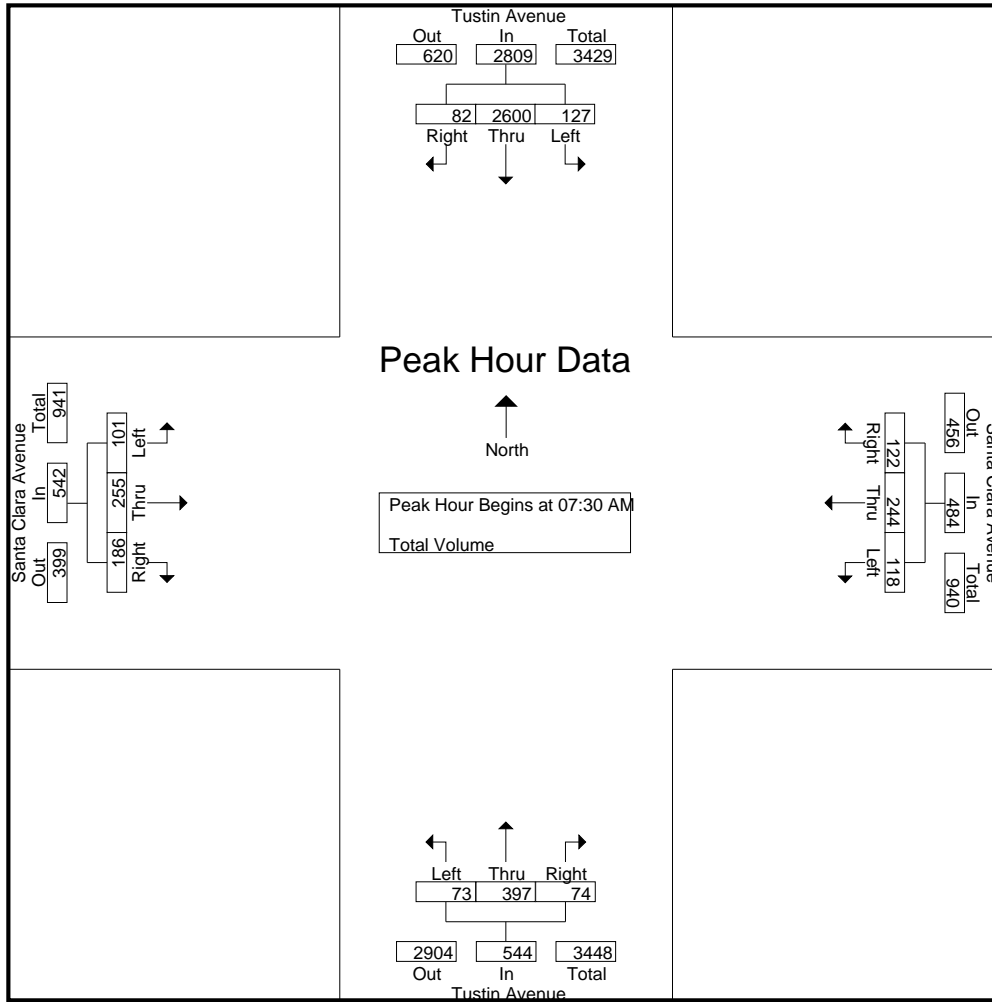

Peak Hour Analysis From 07:00 AM to 08:45 AM - Peak 1 of 1
 Peak Hour for Each Approach Begins at:

	07:30 AM				07:30 AM				07:30 AM				07:15 AM			
+0 mins.	24	633	22	679	31	67	32	130	17	92	20	129	16	86	40	142
+15 mins.	26	654	15	695	23	59	29	111	22	101	16	139	33	82	54	169
+30 mins.	33	661	28	722	30	63	37	130	17	101	20	138	19	73	32	124
+45 mins.	44	652	17	713	34	55	24	113	17	103	18	138	32	61	56	149
Total Volume	127	2600	82	2809	118	244	122	484	73	397	74	544	100	302	182	584
% App. Total	4.5	92.6	2.9		24.4	50.4	25.2		13.4	73	13.6		17.1	51.7	31.2	
PHF	.722	.983	.732	.973	.868	.910	.824	.931	.830	.964	.925	.978	.758	.878	.813	.864

City of Santa Ana
 N/S: Tustin Avenue
 E/W: Santa Clara Avenue
 Weather: Clear

File Name : 92_SNA_Tustin_Santa Clara PM
 Site Code : 20220171
 Start Date : 3/12/2020
 Page No : 1

Groups Printed- Total Volume

Start Time	Tustin Avenue Southbound				Santa Clara Avenue Westbound				Tustin Avenue Northbound				Santa Clara Avenue Eastbound				Int. Total
	Left	Thru	Right	App. Total	Left	Thru	Right	App. Total	Left	Thru	Right	App. Total	Left	Thru	Right	App. Total	
04:00 PM	34	318	34	386	35	26	22	83	40	197	26	263	19	41	28	88	820
04:15 PM	53	301	29	383	29	31	28	88	32	182	30	244	14	45	30	89	804
04:30 PM	47	358	26	431	31	44	44	119	38	174	32	244	16	52	22	90	884
04:45 PM	44	349	18	411	23	40	32	95	32	197	31	260	15	47	24	86	852
Total	178	1326	107	1611	118	141	126	385	142	750	119	1011	64	185	104	353	3360
05:00 PM	37	372	30	439	28	40	30	98	37	199	29	265	17	45	40	102	904
05:15 PM	55	365	26	446	43	33	42	118	56	219	29	304	13	48	27	88	956
05:30 PM	41	344	17	402	34	50	32	116	36	203	24	263	16	52	33	101	882
05:45 PM	40	304	26	370	34	39	24	97	47	213	23	283	15	33	25	73	823
Total	173	1385	99	1657	139	162	128	429	176	834	105	1115	61	178	125	364	3565
Grand Total	351	2711	206	3268	257	303	254	814	318	1584	224	2126	125	363	229	717	6925
Apprch %	10.7	83	6.3		31.6	37.2	31.2		15	74.5	10.5		17.4	50.6	31.9		
Total %	5.1	39.1	3	47.2	3.7	4.4	3.7	11.8	4.6	22.9	3.2	30.7	1.8	5.2	3.3	10.4	

Start Time	Tustin Avenue Southbound				Santa Clara Avenue Westbound				Tustin Avenue Northbound				Santa Clara Avenue Eastbound				Int. Total
	Left	Thru	Right	App. Total	Left	Thru	Right	App. Total	Left	Thru	Right	App. Total	Left	Thru	Right	App. Total	
Peak Hour Analysis From 04:00 PM to 05:45 PM - Peak 1 of 1																	
Peak Hour for Entire Intersection Begins at 04:30 PM																	
04:30 PM	47	358	26	431	31	44	44	119	38	174	32	244	16	52	22	90	884
04:45 PM	44	349	18	411	23	40	32	95	32	197	31	260	15	47	24	86	852
05:00 PM	37	372	30	439	28	40	30	98	37	199	29	265	17	45	40	102	904
05:15 PM	55	365	26	446	43	33	42	118	56	219	29	304	13	48	27	88	956
Total Volume	183	1444	100	1727	125	157	148	430	163	789	121	1073	61	192	113	366	3596
% App. Total	10.6	83.6	5.8		29.1	36.5	34.4		15.2	73.5	11.3		16.7	52.5	30.9		
PHF	.832	.970	.833	.968	.727	.892	.841	.903	.728	.901	.945	.882	.897	.923	.706	.897	.940

City of Santa Ana
 N/S: Tustin Avenue
 E/W: Santa Clara Avenue
 Weather: Clear

File Name : 92_SNA_Tustin_Santa Clara PM
 Site Code : 20220171
 Start Date : 3/12/2020
 Page No : 2

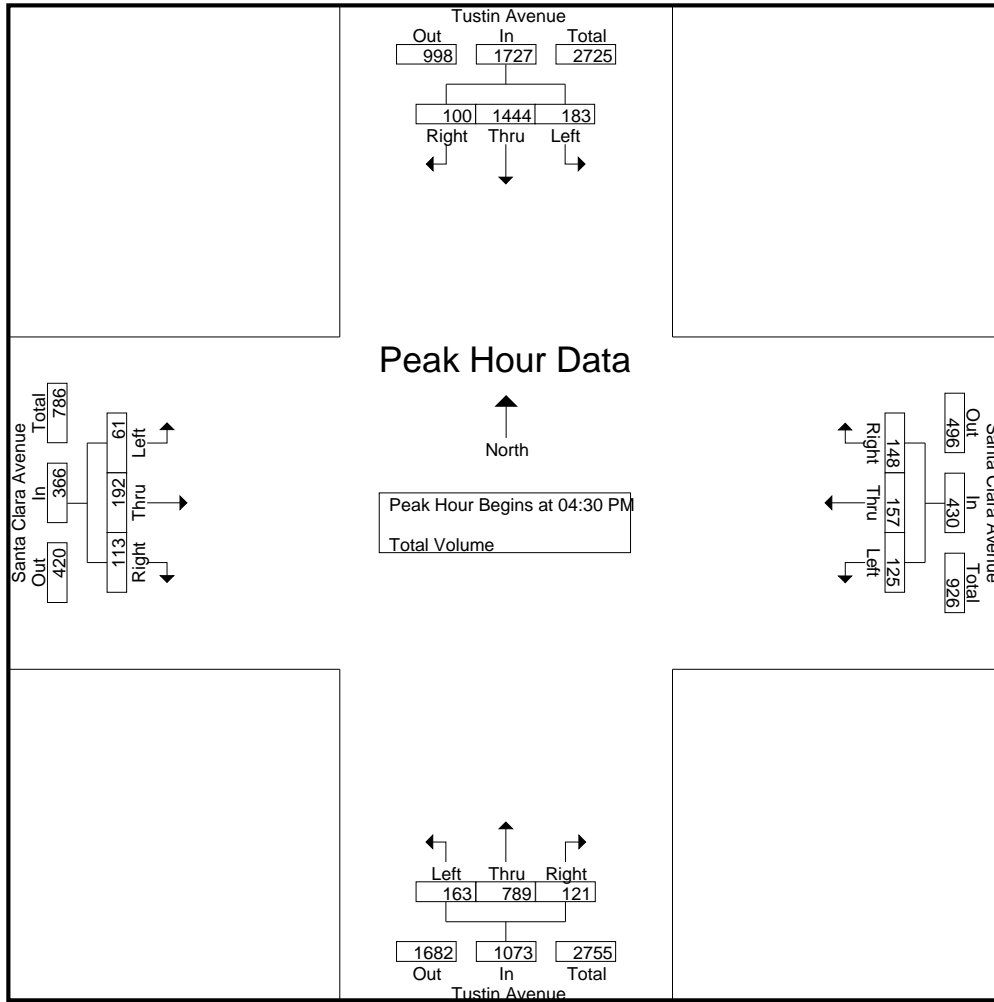

Peak Hour Analysis From 04:00 PM to 05:45 PM - Peak 1 of 1
 Peak Hour for Each Approach Begins at:

	04:30 PM				04:30 PM				05:00 PM				04:45 PM			
+0 mins.	47	358	26	431	31	44	44	119	37	199	29	265	15	47	24	86
+15 mins.	44	349	18	411	23	40	32	95	56	219	29	304	17	45	40	102
+30 mins.	37	372	30	439	28	40	30	98	36	203	24	263	13	48	27	88
+45 mins.	55	365	26	446	43	33	42	118	47	213	23	283	16	52	33	101
Total Volume	183	1444	100	1727	125	157	148	430	176	834	105	1115	61	192	124	377
% App. Total	10.6	83.6	5.8		29.1	36.5	34.4		15.8	74.8	9.4		16.2	50.9	32.9	
PHF	.832	.970	.833	.968	.727	.892	.841	.903	.786	.952	.905	.917	.897	.923	.775	.924

City of Santa Ana
 N/S: Tustin Avenue
 E/W: 17th Street
 Weather: Clear

File Name : 93_SNA_Tustin_17th St AM
 Site Code : 20220171
 Start Date : 3/12/2020
 Page No : 1

Groups Printed- Total Volume

Start Time	Tustin Avenue Southbound				17th Street Westbound				Tustin Avenue Northbound				17th Street Eastbound				Int. Total
	Left	Thru	Right	App. Total	Left	Thru	Right	App. Total	Left	Thru	Right	App. Total	Left	Thru	Right	App. Total	
07:00 AM	147	328	3	478	79	95	23	197	21	35	45	101	23	118	17	158	934
07:15 AM	133	414	1	548	77	131	33	241	20	41	55	116	32	228	22	282	1187
07:30 AM	174	475	6	655	79	147	28	254	26	41	61	128	27	216	22	265	1302
07:45 AM	123	408	1	532	139	227	51	417	25	54	58	137	46	188	26	260	1346
Total	577	1625	11	2213	374	600	135	1109	92	171	219	482	128	750	87	965	4769
08:00 AM	154	454	5	613	131	201	51	383	27	56	47	130	53	199	33	285	1411
08:15 AM	151	400	7	558	139	195	58	392	33	47	70	150	61	135	45	241	1341
08:30 AM	128	288	10	426	122	145	40	307	28	65	40	133	45	124	35	204	1070
08:45 AM	117	314	9	440	142	176	47	365	37	44	45	126	46	132	35	213	1144
Total	550	1456	31	2037	534	717	196	1447	125	212	202	539	205	590	148	943	4966
Grand Total	1127	3081	42	4250	908	1317	331	2556	217	383	421	1021	333	1340	235	1908	9735
Apprch %	26.5	72.5	1		35.5	51.5	12.9		21.3	37.5	41.2		17.5	70.2	12.3		
Total %	11.6	31.6	0.4	43.7	9.3	13.5	3.4	26.3	2.2	3.9	4.3	10.5	3.4	13.8	2.4	19.6	

Start Time	Tustin Avenue Southbound				17th Street Westbound				Tustin Avenue Northbound				17th Street Eastbound				Int. Total
	Left	Thru	Right	App. Total	Left	Thru	Right	App. Total	Left	Thru	Right	App. Total	Left	Thru	Right	App. Total	
Peak Hour Analysis From 07:00 AM to 08:45 AM - Peak 1 of 1																	
Peak Hour for Entire Intersection Begins at 07:30 AM																	
07:30 AM	174	475	6	655	79	147	28	254	26	41	61	128	27	216	22	265	1302
07:45 AM	123	408	1	532	139	227	51	417	25	54	58	137	46	188	26	260	1346
08:00 AM	154	454	5	613	131	201	51	383	27	56	47	130	53	199	33	285	1411
08:15 AM	151	400	7	558	139	195	58	392	33	47	70	150	61	135	45	241	1341
Total Volume	602	1737	19	2358	488	770	188	1446	111	198	236	545	187	738	126	1051	5400
% App. Total	25.5	73.7	0.8		33.7	53.3	13		20.4	36.3	43.3		17.8	70.2	12		
PHF	.865	.914	.679	.900	.878	.848	.810	.867	.841	.884	.843	.908	.766	.854	.700	.922	.957

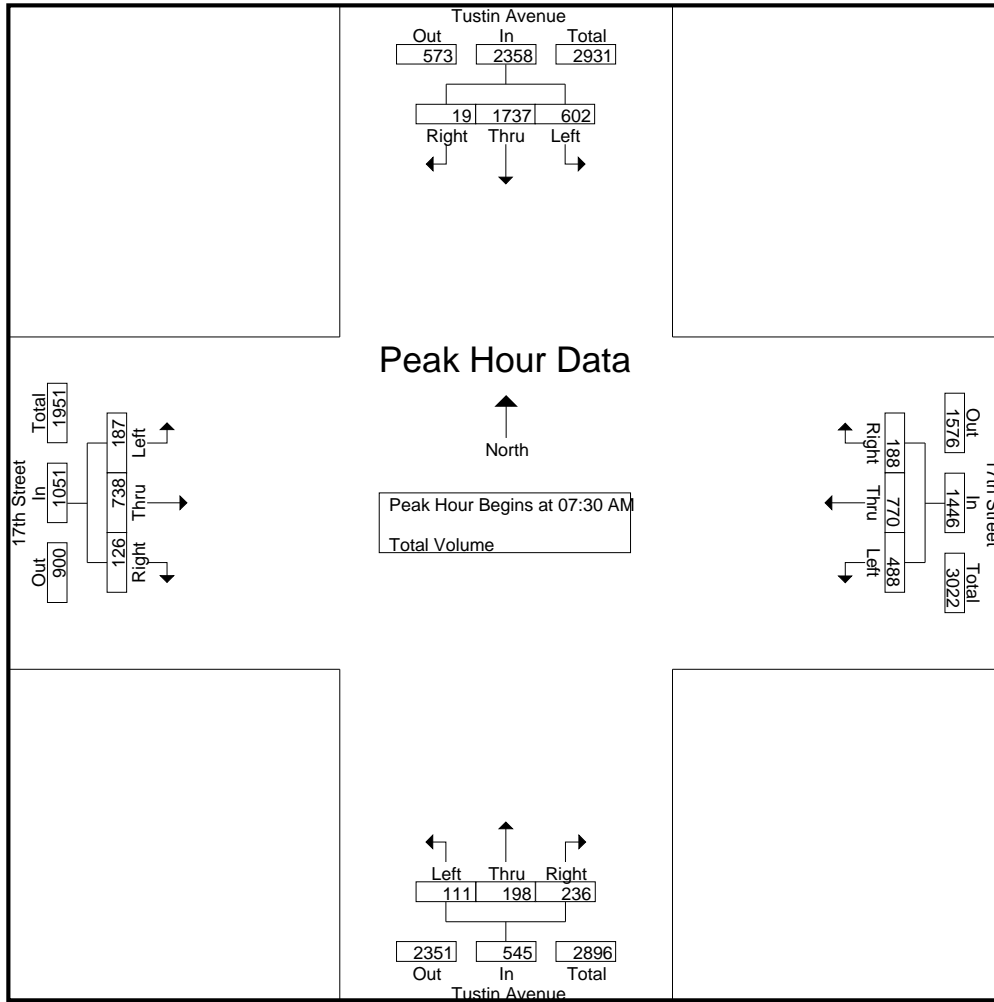

Peak Hour Analysis From 07:00 AM to 08:45 AM - Peak 1 of 1
 Peak Hour for Each Approach Begins at:

	07:30 AM				07:45 AM				07:45 AM				07:15 AM			
+0 mins.	174	475	6	655	139	227	51	417	25	54	58	137	32	228	22	282
+15 mins.	123	408	1	532	131	201	51	383	27	56	47	130	27	216	22	265
+30 mins.	154	454	5	613	139	195	58	392	33	47	70	150	46	188	26	260
+45 mins.	151	400	7	558	122	145	40	307	28	65	40	133	53	199	33	285
Total Volume	602	1737	19	2358	531	768	200	1499	113	222	215	550	158	831	103	1092
% App. Total	25.5	73.7	0.8		35.4	51.2	13.3		20.5	40.4	39.1		14.5	76.1	9.4	
PHF	.865	.914	.679	.900	.955	.846	.862	.899	.856	.854	.768	.917	.745	.911	.780	.958

City of Santa Ana
 N/S: Tustin Avenue
 E/W: 17th Street
 Weather: Clear

File Name : 93_SNA_Tustin_17th St PM
 Site Code : 20220171
 Start Date : 3/12/2020
 Page No : 1

Groups Printed- Total Volume

Start Time	Tustin Avenue Southbound				17th Street Westbound				Tustin Avenue Northbound				17th Street Eastbound				Int. Total
	Left	Thru	Right	App. Total	Left	Thru	Right	App. Total	Left	Thru	Right	App. Total	Left	Thru	Right	App. Total	
04:00 PM	73	93	7	173	47	193	90	330	58	224	106	388	103	163	29	295	1186
04:15 PM	69	73	12	154	51	229	101	381	50	177	72	299	98	166	30	294	1128
04:30 PM	89	92	10	191	58	176	109	343	68	233	110	411	125	197	32	354	1299
04:45 PM	80	76	6	162	64	237	111	412	52	189	84	325	103	211	19	333	1232
Total	311	334	35	680	220	835	411	1466	228	823	372	1423	429	737	110	1276	4845
05:00 PM	90	92	9	191	46	160	108	314	57	238	169	464	115	244	29	388	1357
05:15 PM	87	111	12	210	61	180	91	332	39	266	113	418	101	220	38	359	1319
05:30 PM	89	88	12	189	48	205	88	341	47	176	102	325	129	219	37	385	1240
05:45 PM	89	101	18	208	49	186	88	323	44	207	88	339	94	180	24	298	1168
Total	355	392	51	798	204	731	375	1310	187	887	472	1546	439	863	128	1430	5084
Grand Total	666	726	86	1478	424	1566	786	2776	415	1710	844	2969	868	1600	238	2706	9929
Apprch %	45.1	49.1	5.8		15.3	56.4	28.3		14	57.6	28.4		32.1	59.1	8.8		
Total %	6.7	7.3	0.9	14.9	4.3	15.8	7.9	28	4.2	17.2	8.5	29.9	8.7	16.1	2.4	27.3	

Start Time	Tustin Avenue Southbound				17th Street Westbound				Tustin Avenue Northbound				17th Street Eastbound				Int. Total
	Left	Thru	Right	App. Total	Left	Thru	Right	App. Total	Left	Thru	Right	App. Total	Left	Thru	Right	App. Total	
Peak Hour Analysis From 04:00 PM to 05:45 PM - Peak 1 of 1																	
Peak Hour for Entire Intersection Begins at 04:30 PM																	
04:30 PM	89	92	10	191	58	176	109	343	68	233	110	411	125	197	32	354	1299
04:45 PM	80	76	6	162	64	237	111	412	52	189	84	325	103	211	19	333	1232
05:00 PM	90	92	9	191	46	160	108	314	57	238	169	464	115	244	29	388	1357
05:15 PM	87	111	12	210	61	180	91	332	39	266	113	418	101	220	38	359	1319
Total Volume	346	371	37	754	229	753	419	1401	216	926	476	1618	444	872	118	1434	5207
% App. Total	45.9	49.2	4.9		16.3	53.7	29.9		13.3	57.2	29.4		31	60.8	8.2		
PHF	.961	.836	.771	.898	.895	.794	.944	.850	.794	.870	.704	.872	.888	.893	.776	.924	.959

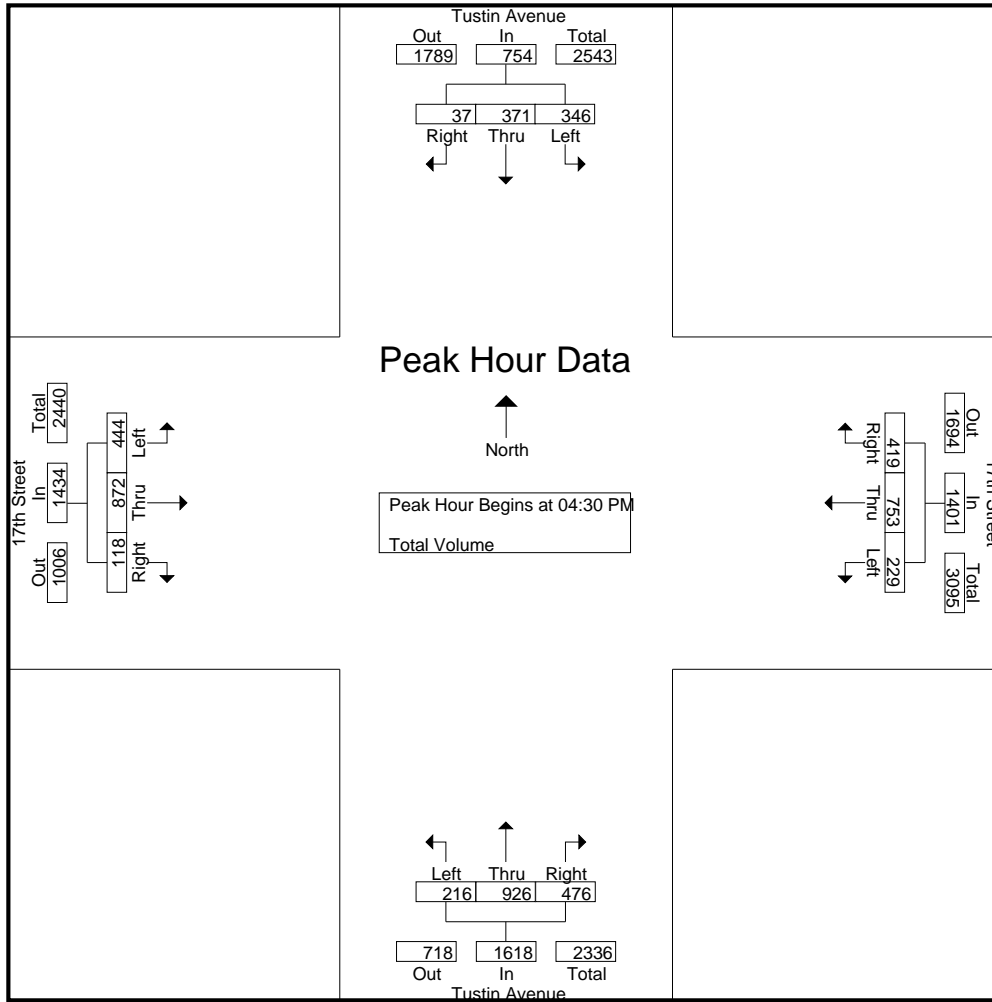

Peak Hour Analysis From 04:00 PM to 05:45 PM - Peak 1 of 1
 Peak Hour for Each Approach Begins at:

	05:00 PM				04:00 PM				04:30 PM				04:45 PM			
+0 mins.	90	92	9	191	47	193	90	330	68	233	110	411	103	211	19	333
+15 mins.	87	111	12	210	51	229	101	381	52	189	84	325	115	244	29	388
+30 mins.	89	88	12	189	58	176	109	343	57	238	169	464	101	220	38	359
+45 mins.	89	101	18	208	64	237	111	412	39	266	113	418	129	219	37	385
Total Volume	355	392	51	798	220	835	411	1466	216	926	476	1618	448	894	123	1465
% App. Total	44.5	49.1	6.4		15	57	28		13.3	57.2	29.4		30.6	61	8.4	
PHF	.986	.883	.708	.950	.859	.881	.926	.890	.794	.870	.704	.872	.868	.916	.809	.944

City of Santa Ana
 N/S: Tustin Avenue
 E/W: 4th Street
 Weather: Clear

File Name : 94_SNA_Tustin_4th St AM
 Site Code : 20220171
 Start Date : 3/12/2020
 Page No : 1

Groups Printed- Total Volume

Start Time	Tustin Avenue Southbound				4th Street Westbound				Tustin Avenue Northbound				4th Street Eastbound				Int. Total
	Left	Thru	Right	App. Total	Left	Thru	Right	App. Total	Left	Thru	Right	App. Total	Left	Thru	Right	App. Total	
07:00 AM	177	130	38	345	10	64	56	130	5	40	33	78	13	87	5	105	658
07:15 AM	185	164	39	388	23	92	63	178	9	43	32	84	31	130	12	173	823
07:30 AM	178	258	72	508	25	152	64	241	13	53	48	114	21	198	3	222	1085
07:45 AM	155	203	74	432	27	150	104	281	13	67	68	148	22	208	5	235	1096
Total	695	755	223	1673	85	458	287	830	40	203	181	424	87	623	25	735	3662
08:00 AM	156	191	63	410	20	131	96	247	10	67	57	134	38	161	12	211	1002
08:15 AM	175	193	53	421	31	146	112	289	12	58	46	116	33	109	8	150	976
08:30 AM	168	151	55	374	26	132	87	245	15	71	49	135	32	104	13	149	903
08:45 AM	131	135	64	330	17	146	85	248	10	54	25	89	38	108	13	159	826
Total	630	670	235	1535	94	555	380	1029	47	250	177	474	141	482	46	669	3707
Grand Total	1325	1425	458	3208	179	1013	667	1859	87	453	358	898	228	1105	71	1404	7369
Apprch %	41.3	44.4	14.3		9.6	54.5	35.9		9.7	50.4	39.9		16.2	78.7	5.1		
Total %	18	19.3	6.2	43.5	2.4	13.7	9.1	25.2	1.2	6.1	4.9	12.2	3.1	15	1	19.1	

Start Time	Tustin Avenue Southbound				4th Street Westbound				Tustin Avenue Northbound				4th Street Eastbound				Int. Total
	Left	Thru	Right	App. Total	Left	Thru	Right	App. Total	Left	Thru	Right	App. Total	Left	Thru	Right	App. Total	
Peak Hour Analysis From 07:00 AM to 08:45 AM - Peak 1 of 1																	
Peak Hour for Entire Intersection Begins at 07:30 AM																	
07:30 AM	178	258	72	508	25	152	64	241	13	53	48	114	21	198	3	222	1085
07:45 AM	155	203	74	432	27	150	104	281	13	67	68	148	22	208	5	235	1096
08:00 AM	156	191	63	410	20	131	96	247	10	67	57	134	38	161	12	211	1002
08:15 AM	175	193	53	421	31	146	112	289	12	58	46	116	33	109	8	150	976
Total Volume	664	845	262	1771	103	579	376	1058	48	245	219	512	114	676	28	818	4159
% App. Total	37.5	47.7	14.8		9.7	54.7	35.5		9.4	47.9	42.8		13.9	82.6	3.4		
PHF	.933	.819	.885	.872	.831	.952	.839	.915	.923	.914	.805	.865	.750	.813	.583	.870	.949

City of Santa Ana
 N/S: Tustin Avenue
 E/W: 4th Street
 Weather: Clear

File Name : 94_SNA_Tustin_4th St AM
 Site Code : 20220171
 Start Date : 3/12/2020
 Page No : 2

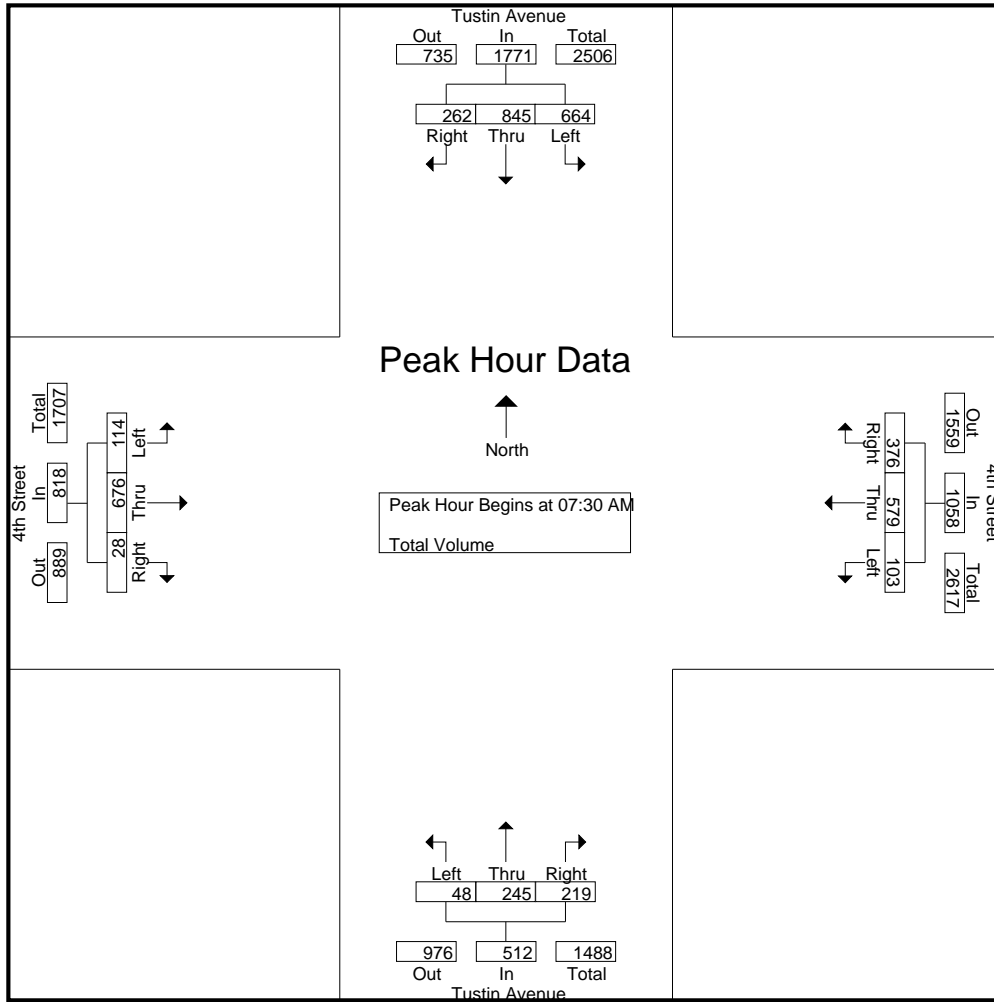

Peak Hour Analysis From 07:00 AM to 08:45 AM - Peak 1 of 1
 Peak Hour for Each Approach Begins at:

	07:30 AM				07:45 AM				07:45 AM				07:15 AM			
+0 mins.	178	258	72	508	27	150	104	281	13	67	68	148	31	130	12	173
+15 mins.	155	203	74	432	20	131	96	247	10	67	57	134	21	198	3	222
+30 mins.	156	191	63	410	31	146	112	289	12	58	46	116	22	208	5	235
+45 mins.	175	193	53	421	26	132	87	245	15	71	49	135	38	161	12	211
Total Volume	664	845	262	1771	104	559	399	1062	50	263	220	533	112	697	32	841
% App. Total	37.5	47.7	14.8		9.8	52.6	37.6		9.4	49.3	41.3		13.3	82.9	3.8	
PHF	.933	.819	.885	.872	.839	.932	.891	.919	.833	.926	.809	.900	.737	.838	.667	.895

City of Santa Ana
 N/S: Tustin Avenue
 E/W: 4th Street
 Weather: Clear

File Name : 94_SNA_Tustin_4th St PM
 Site Code : 20220171
 Start Date : 3/12/2020
 Page No : 1

Groups Printed- Total Volume

Start Time	Tustin Street Southbound				Tustin Avenue Westbound				Tustin Street Northbound				Tustin Avenue Eastbound				Int. Total
	Left	Thru	Right	App. Total	Left	Thru	Right	App. Total	Left	Thru	Right	App. Total	Left	Thru	Right	App. Total	
04:00 PM	100	89	30	219	29	160	59	248	21	145	26	192	41	152	7	200	859
04:15 PM	98	96	23	217	23	222	101	346	19	156	40	215	71	155	21	247	1025
04:30 PM	87	74	34	195	14	69	115	198	14	140	30	184	43	118	10	171	748
04:45 PM	118	79	37	234	22	180	103	305	14	137	41	192	51	164	13	228	959
Total	403	338	124	865	88	631	378	1097	68	578	137	783	206	589	51	846	3591
05:00 PM	109	86	34	229	18	124	77	219	15	166	56	237	40	163	5	208	893
05:15 PM	105	89	35	229	23	139	93	255	12	137	46	195	42	149	6	197	876
05:30 PM	127	85	18	230	25	153	94	272	14	158	51	223	47	166	9	222	947
05:45 PM	92	70	27	189	26	154	83	263	7	145	58	210	42	115	6	163	825
Total	433	330	114	877	92	570	347	1009	48	606	211	865	171	593	26	790	3541
Grand Total	836	668	238	1742	180	1201	725	2106	116	1184	348	1648	377	1182	77	1636	7132
Apprch %	48	38.3	13.7		8.5	57	34.4		7	71.8	21.1		23	72.2	4.7		
Total %	11.7	9.4	3.3	24.4	2.5	16.8	10.2	29.5	1.6	16.6	4.9	23.1	5.3	16.6	1.1	22.9	

Start Time	Tustin Street Southbound				Tustin Avenue Westbound				Tustin Street Northbound				Tustin Avenue Eastbound				Int. Total
	Left	Thru	Right	App. Total	Left	Thru	Right	App. Total	Left	Thru	Right	App. Total	Left	Thru	Right	App. Total	
Peak Hour Analysis From 04:00 PM to 05:45 PM - Peak 1 of 1																	
Peak Hour for Entire Intersection Begins at 04:45 PM																	
04:45 PM	118	79	37	234	22	180	103	305	14	137	41	192	51	164	13	228	959
05:00 PM	109	86	34	229	18	124	77	219	15	166	56	237	40	163	5	208	893
05:15 PM	105	89	35	229	23	139	93	255	12	137	46	195	42	149	6	197	876
05:30 PM	127	85	18	230	25	153	94	272	14	158	51	223	47	166	9	222	947
Total Volume	459	339	124	922	88	596	367	1051	55	598	194	847	180	642	33	855	3675
% App. Total	49.8	36.8	13.4		8.4	56.7	34.9		6.5	70.6	22.9		21.1	75.1	3.9		
PHF	.904	.952	.838	.985	.880	.828	.891	.861	.917	.901	.866	.893	.882	.967	.635	.938	.958

City of Santa Ana
 N/S: Tustin Avenue
 E/W: 4th Street
 Weather: Clear

File Name : 94_SNA_Tustin_4th St PM
 Site Code : 20220171
 Start Date : 3/12/2020
 Page No : 2

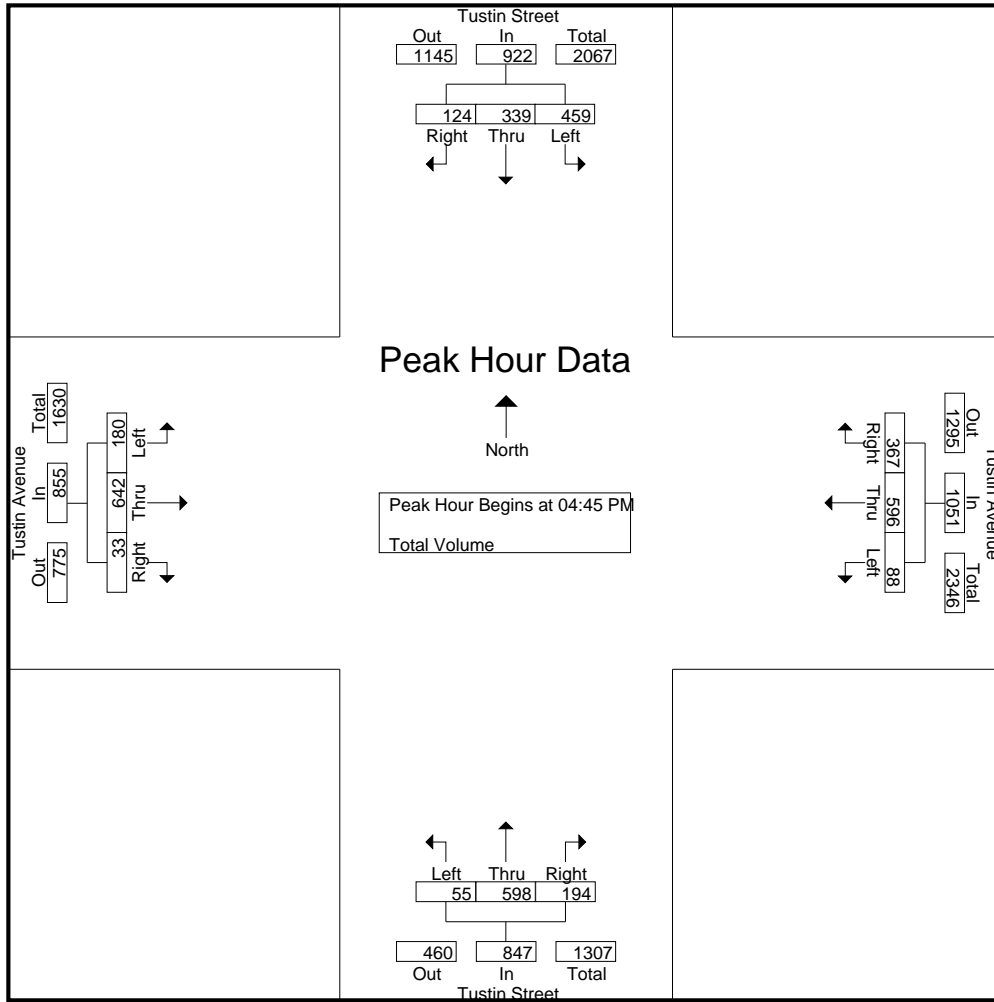

Peak Hour Analysis From 04:00 PM to 05:45 PM - Peak 1 of 1
 Peak Hour for Each Approach Begins at:

	04:45 PM				04:00 PM				05:00 PM				04:45 PM			
+0 mins.	118	79	37	234	29	160	59	248	15	166	56	237	51	164	13	228
+15 mins.	109	86	34	229	23	222	101	346	12	137	46	195	40	163	5	208
+30 mins.	105	89	35	229	14	69	115	198	14	158	51	223	42	149	6	197
+45 mins.	127	85	18	230	22	180	103	305	7	145	58	210	47	166	9	222
Total Volume	459	339	124	922	88	631	378	1097	48	606	211	865	180	642	33	855
% App. Total	49.8	36.8	13.4		8	57.5	34.5		5.5	70.1	24.4		21.1	75.1	3.9	
PHF	.904	.952	.838	.985	.759	.711	.822	.793	.800	.913	.909	.912	.882	.967	.635	.938

City of Santa Ana
 N/S: Auto Mall Dr/SR-55 Southbound Ramps
 E/W: Edinger Avenue
 Weather: Clear

File Name : 95_SNA_55S_Edinger AM
 Site Code : 20220171
 Start Date : 3/12/2020
 Page No : 1

Groups Printed- Total Volume

Start Time	Auto Mall Drive Southbound				Edinger Avenue Westbound				SR-55 Southbound Ramps Northbound				Edinger Avenue Eastbound				Int. Total
	Left	Thru	Right	App. Total	Left	Thru	Right	App. Total	Left	Thru	Right	App. Total	Left	Thru	Right	App. Total	
07:00 AM	7	0	4	11	56	126	14	196	109	24	117	250	7	261	81	349	806
07:15 AM	11	8	1	20	70	182	29	281	121	15	137	273	6	260	194	460	1034
07:30 AM	16	10	3	29	91	230	25	346	109	18	135	262	3	294	106	403	1040
07:45 AM	8	5	2	15	129	269	34	432	91	12	130	233	3	302	58	363	1043
Total	42	23	10	75	346	807	102	1255	430	69	519	1018	19	1117	439	1575	3923
08:00 AM	15	7	2	24	109	259	35	403	100	18	96	214	16	248	50	314	955
08:15 AM	23	6	2	31	93	269	32	394	86	15	90	191	4	244	62	310	926
08:30 AM	10	5	3	18	88	220	25	333	76	10	88	174	8	256	93	357	882
08:45 AM	19	12	7	38	95	226	29	350	78	23	100	201	6	225	73	304	893
Total	67	30	14	111	385	974	121	1480	340	66	374	780	34	973	278	1285	3656
Grand Total	109	53	24	186	731	1781	223	2735	770	135	893	1798	53	2090	717	2860	7579
Apprch %	58.6	28.5	12.9		26.7	65.1	8.2		42.8	7.5	49.7		1.9	73.1	25.1		
Total %	1.4	0.7	0.3	2.5	9.6	23.5	2.9	36.1	10.2	1.8	11.8	23.7	0.7	27.6	9.5	37.7	

Start Time	Auto Mall Drive Southbound				Edinger Avenue Westbound				SR-55 Southbound Ramps Northbound				Edinger Avenue Eastbound				Int. Total
	Left	Thru	Right	App. Total	Left	Thru	Right	App. Total	Left	Thru	Right	App. Total	Left	Thru	Right	App. Total	
Peak Hour Analysis From 07:00 AM to 08:45 AM - Peak 1 of 1																	
Peak Hour for Entire Intersection Begins at 07:15 AM																	
07:15 AM	11	8	1	20	70	182	29	281	121	15	137	273	6	260	194	460	1034
07:30 AM	16	10	3	29	91	230	25	346	109	18	135	262	3	294	106	403	1040
07:45 AM	8	5	2	15	129	269	34	432	91	12	130	233	3	302	58	363	1043
08:00 AM	15	7	2	24	109	259	35	403	100	18	96	214	16	248	50	314	955
Total Volume	50	30	8	88	399	940	123	1462	421	63	498	982	28	1104	408	1540	4072
% App. Total	56.8	34.1	9.1		27.3	64.3	8.4		42.9	6.4	50.7		1.8	71.7	26.5		
PHF	.781	.750	.667	.759	.773	.874	.879	.846	.870	.875	.909	.899	.438	.914	.526	.837	.976

City of Santa Ana
 N/S: Auto Mall Dr/SR-55 Southbound Ramps
 E/W: Edinger Avenue
 Weather: Clear

File Name : 95_SNA_55S_Edinger AM
 Site Code : 20220171
 Start Date : 3/12/2020
 Page No : 2

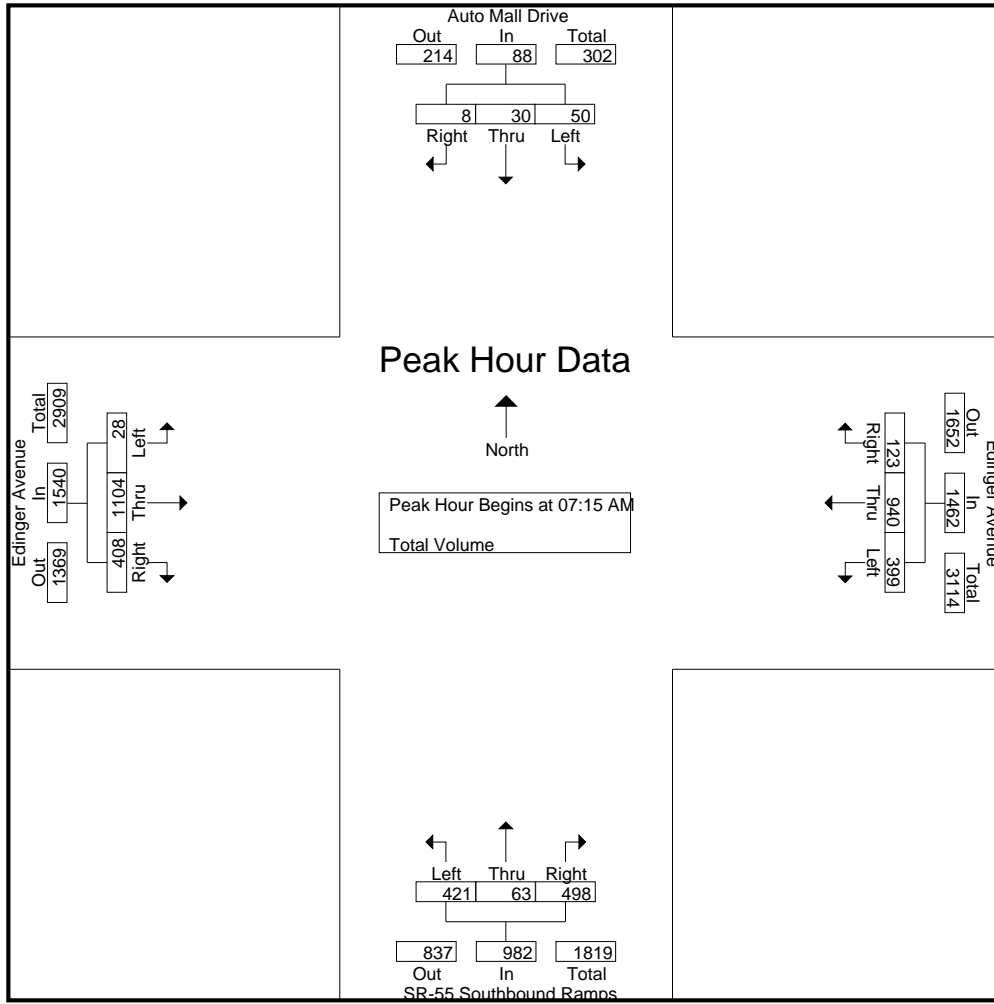

Peak Hour Analysis From 07:00 AM to 08:45 AM - Peak 1 of 1
 Peak Hour for Each Approach Begins at:

	08:00 AM				07:30 AM				07:00 AM				07:00 AM			
+0 mins.	15	7	2	24	91	230	25	346	109	24	117	250	7	261	81	349
+15 mins.	23	6	2	31	129	269	34	432	121	15	137	273	6	260	194	460
+30 mins.	10	5	3	18	109	259	35	403	109	18	135	262	3	294	106	403
+45 mins.	19	12	7	38	93	269	32	394	91	12	130	233	3	302	58	363
Total Volume	67	30	14	111	422	1027	126	1575	430	69	519	1018	19	1117	439	1575
% App. Total	60.4	27	12.6		26.8	65.2	8		42.2	6.8	51		1.2	70.9	27.9	
PHF	.728	.625	.500	.730	.818	.954	.900	.911	.888	.719	.947	.932	.679	.925	.566	.856

City of Santa Ana
 N/S: Auto Mall Dr/SR-55 Southbound Ramps
 E/W: Edinger Avenue
 Weather: Clear

File Name : 95_SNA_55S_Edinger PM
 Site Code : 20220171
 Start Date : 3/12/2020
 Page No : 1

Groups Printed- Total Volume

Start Time	Auto Mall Drive Southbound				Edinger Avenue Westbound				SR-55 Southbound Ramps Northbound				Edinger Avenue Eastbound				Int. Total
	Left	Thru	Right	App. Total	Left	Thru	Right	App. Total	Left	Thru	Right	App. Total	Left	Thru	Right	App. Total	
04:00 PM	24	15	8	47	82	265	29	376	76	7	64	147	7	290	78	375	945
04:15 PM	25	7	7	39	61	248	23	332	79	8	59	146	12	226	62	300	817
04:30 PM	14	11	6	31	85	233	22	340	97	11	72	180	7	251	80	338	889
04:45 PM	26	12	8	46	97	210	27	334	86	5	82	173	6	239	73	318	871
Total	89	45	29	163	325	956	101	1382	338	31	277	646	32	1006	293	1331	3522
05:00 PM	39	19	8	66	96	218	27	341	89	5	85	179	13	322	103	438	1024
05:15 PM	21	9	11	41	78	252	25	355	95	12	97	204	12	296	73	381	981
05:30 PM	24	10	10	44	114	323	41	478	107	8	134	249	4	401	105	510	1281
05:45 PM	14	8	5	27	34	110	12	156	49	5	67	121	4	121	43	168	472
Total	98	46	34	178	322	903	105	1330	340	30	383	753	33	1140	324	1497	3758
Grand Total	187	91	63	341	647	1859	206	2712	678	61	660	1399	65	2146	617	2828	7280
Apprch %	54.8	26.7	18.5		23.9	68.5	7.6		48.5	4.4	47.2		2.3	75.9	21.8		
Total %	2.6	1.2	0.9	4.7	8.9	25.5	2.8	37.3	9.3	0.8	9.1	19.2	0.9	29.5	8.5	38.8	

Start Time	Auto Mall Drive Southbound				Edinger Avenue Westbound				SR-55 Southbound Ramps Northbound				Edinger Avenue Eastbound				Int. Total
	Left	Thru	Right	App. Total	Left	Thru	Right	App. Total	Left	Thru	Right	App. Total	Left	Thru	Right	App. Total	
Peak Hour Analysis From 04:00 PM to 05:45 PM - Peak 1 of 1																	
Peak Hour for Entire Intersection Begins at 04:45 PM																	
04:45 PM	26	12	8	46	97	210	27	334	86	5	82	173	6	239	73	318	871
05:00 PM	39	19	8	66	96	218	27	341	89	5	85	179	13	322	103	438	1024
05:15 PM	21	9	11	41	78	252	25	355	95	12	97	204	12	296	73	381	981
05:30 PM	24	10	10	44	114	323	41	478	107	8	134	249	4	401	105	510	1281
Total Volume	110	50	37	197	385	1003	120	1508	377	30	398	805	35	1258	354	1647	4157
% App. Total	55.8	25.4	18.8		25.5	66.5	8		46.8	3.7	49.4		2.1	76.4	21.5		
PHF	.705	.658	.841	.746	.844	.776	.732	.789	.881	.625	.743	.808	.673	.784	.843	.807	.811

City of Santa Ana
 N/S: Auto Mall Dr/SR-55 Southbound Ramps
 E/W: Edinger Avenue
 Weather: Clear

File Name : 95_SNA_55S_Edinger PM
 Site Code : 20220171
 Start Date : 3/12/2020
 Page No : 2

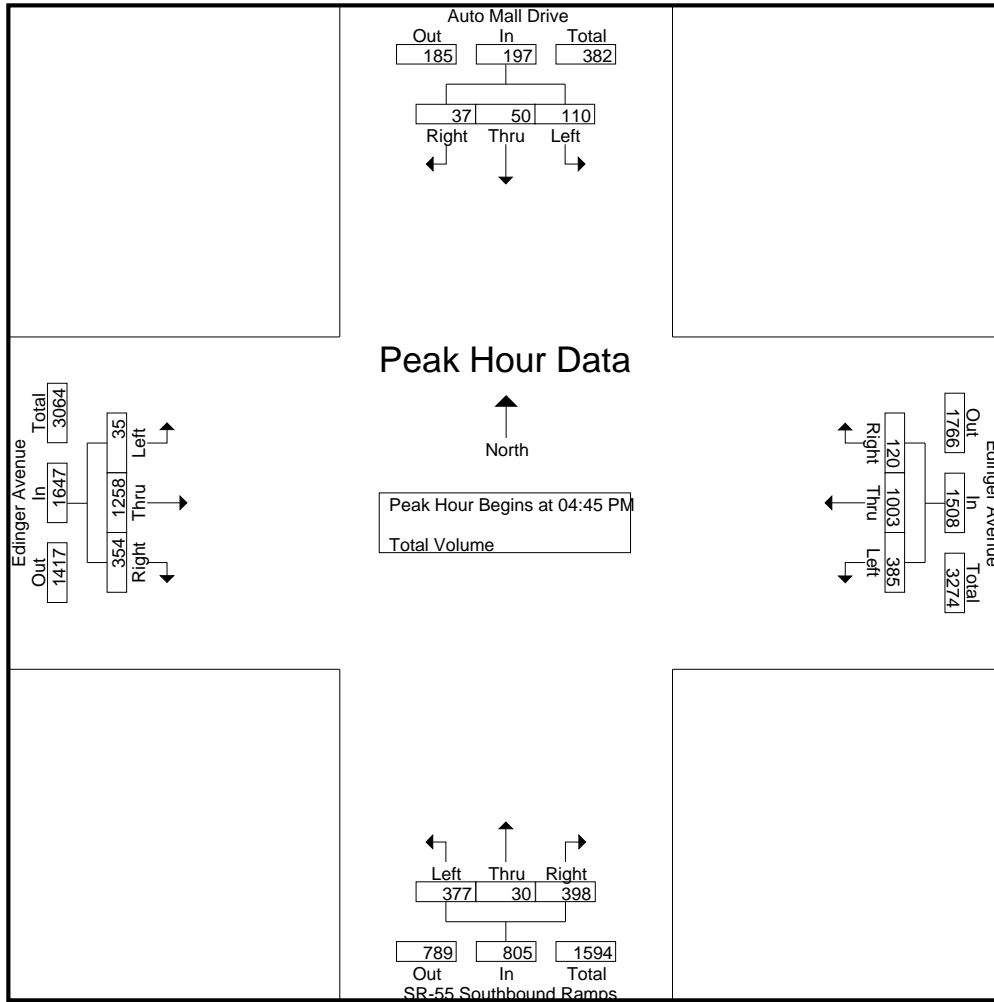

Peak Hour Analysis From 04:00 PM to 05:45 PM - Peak 1 of 1
 Peak Hour for Each Approach Begins at:

	04:45 PM				04:45 PM				04:45 PM				04:45 PM			
+0 mins.	26	12	8	46	97	210	27	334	86	5	82	173	6	239	73	318
+15 mins.	39	19	8	66	96	218	27	341	89	5	85	179	13	322	103	438
+30 mins.	21	9	11	41	78	252	25	355	95	12	97	204	12	296	73	381
+45 mins.	24	10	10	44	114	323	41	478	107	8	134	249	4	401	105	510
Total Volume	110	50	37	197	385	1003	120	1508	377	30	398	805	35	1258	354	1647
% App. Total	55.8	25.4	18.8		25.5	66.5	8		46.8	3.7	49.4		2.1	76.4	21.5	
PHF	.705	.658	.841	.746	.844	.776	.732	.789	.881	.625	.743	.808	.673	.784	.843	.807

City of Tustin
 N/S: Newport Avenue
 E/W: SR-55 NB Ramps/Del Amo Avenue
 Weather: Clear

File Name : 96_TUS_Newport_55N AM
 Site Code : 20220171
 Start Date : 3/12/2020
 Page No : 1

Groups Printed- Total Volume

Start Time	Newport Avenue Southbound				Del Amo Avenue Westbound				Newport Avenue Northbound				SR-55 Northbound Ramps Eastbound				Int. Total
	Left	Thru	Right	App. Total	Left	Thru	Right	App. Total	Left	Thru	Right	App. Total	Left	Thru	Right	App. Total	
07:00 AM	5	63	114	182	4	35	1	40	49	19	3	71	20	8	10	38	331
07:15 AM	3	87	136	226	4	43	1	48	54	11	6	71	53	22	20	95	440
07:30 AM	3	100	143	246	2	48	3	53	56	14	2	72	52	35	30	117	488
07:45 AM	2	104	116	222	4	68	1	73	63	14	2	79	66	46	48	160	534
Total	13	354	509	876	14	194	6	214	222	58	13	293	191	111	108	410	1793
08:00 AM	2	73	114	189	0	46	0	46	50	16	6	72	77	29	35	141	448
08:15 AM	7	67	131	205	2	61	0	63	58	16	28	102	58	43	33	134	504
08:30 AM	8	49	103	160	3	34	1	38	57	20	13	90	48	47	33	128	416
08:45 AM	6	44	120	170	5	42	2	49	38	15	15	68	69	55	34	158	445
Total	23	233	468	724	10	183	3	196	203	67	62	332	252	174	135	561	1813
Grand Total	36	587	977	1600	24	377	9	410	425	125	75	625	443	285	243	971	3606
Apprch %	2.2	36.7	61.1		5.9	92	2.2		68	20	12		45.6	29.4	25		
Total %	1	16.3	27.1	44.4	0.7	10.5	0.2	11.4	11.8	3.5	2.1	17.3	12.3	7.9	6.7	26.9	

Start Time	Newport Avenue Southbound				Del Amo Avenue Westbound				Newport Avenue Northbound				SR-55 Northbound Ramps Eastbound				Int. Total
	Left	Thru	Right	App. Total	Left	Thru	Right	App. Total	Left	Thru	Right	App. Total	Left	Thru	Right	App. Total	
Peak Hour Analysis From 07:00 AM to 08:45 AM - Peak 1 of 1																	
Peak Hour for Entire Intersection Begins at 07:30 AM																	
07:30 AM	3	100	143	246	2	48	3	53	56	14	2	72	52	35	30	117	488
07:45 AM	2	104	116	222	4	68	1	73	63	14	2	79	66	46	48	160	534
08:00 AM	2	73	114	189	0	46	0	46	50	16	6	72	77	29	35	141	448
08:15 AM	7	67	131	205	2	61	0	63	58	16	28	102	58	43	33	134	504
Total Volume	14	344	504	862	8	223	4	235	227	60	38	325	253	153	146	552	1974
% App. Total	1.6	39.9	58.5		3.4	94.9	1.7		69.8	18.5	11.7		45.8	27.7	26.4		
PHF	.500	.827	.881	.876	.500	.820	.333	.805	.901	.938	.339	.797	.821	.832	.760	.863	.924

City of Tustin
 N/S: Newport Avenue
 E/W: SR-55 NB Ramps/Del Amo Avenue
 Weather: Clear

File Name : 96_TUS_Newport_55N AM
 Site Code : 20220171
 Start Date : 3/12/2020
 Page No : 2

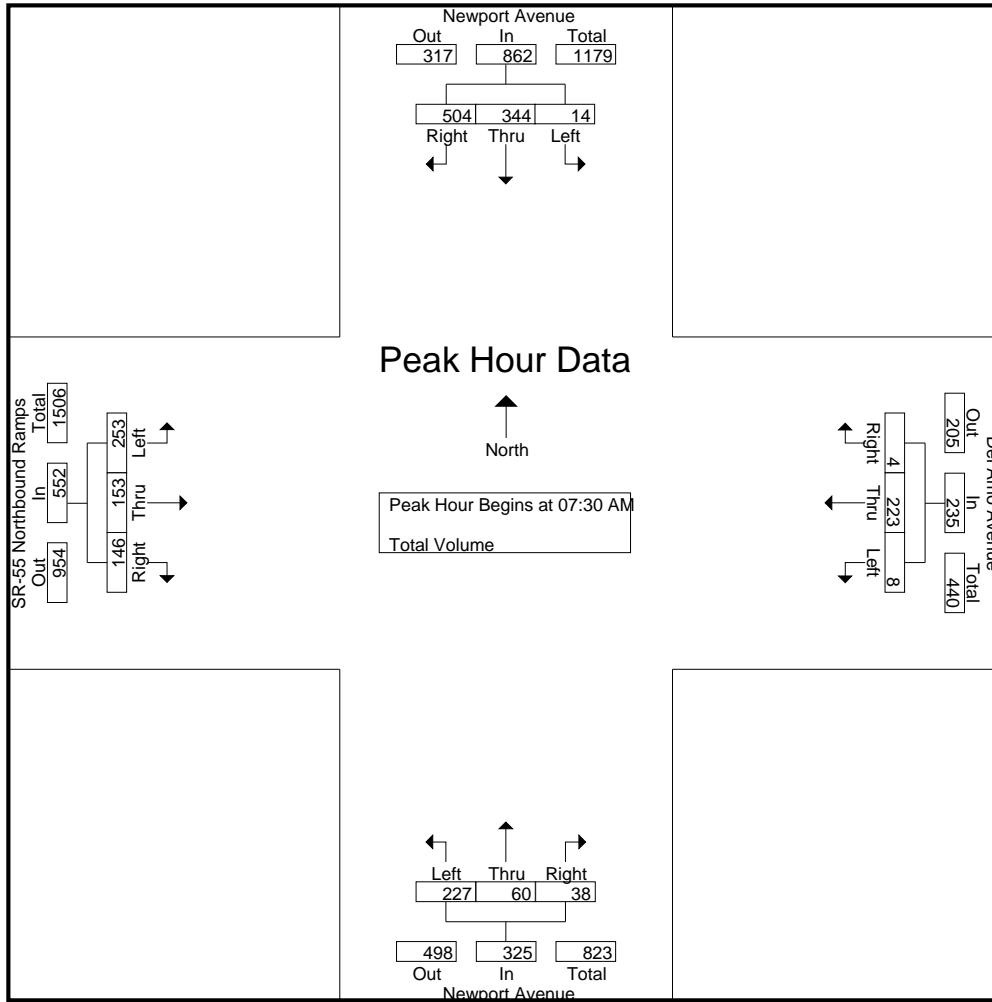

Peak Hour Analysis From 07:00 AM to 08:45 AM - Peak 1 of 1
 Peak Hour for Each Approach Begins at:

	07:15 AM				07:30 AM				07:45 AM				07:45 AM			
+0 mins.	3	87	136	226	2	48	3	53	63	14	2	79	66	46	48	160
+15 mins.	3	100	143	246	4	68	1	73	50	16	6	72	77	29	35	141
+30 mins.	2	104	116	222	0	46	0	46	58	16	28	102	58	43	33	134
+45 mins.	2	73	114	189	2	61	0	63	57	20	13	90	48	47	33	128
Total Volume	10	364	509	883	8	223	4	235	228	66	49	343	249	165	149	563
% App. Total	1.1	41.2	57.6		3.4	94.9	1.7		66.5	19.2	14.3		44.2	29.3	26.5	
PHF	.833	.875	.890	.897	.500	.820	.333	.805	.905	.825	.438	.841	.808	.878	.776	.880

City of Tustin
 N/S: Newport Avenue
 E/W: SR-55 NB Ramps/Del Amo Avenue
 Weather: Clear

File Name : 96_TUS_Newport_55N PM
 Site Code : 20220171
 Start Date : 3/12/2020
 Page No : 1

Groups Printed- Total Volume

Start Time	Newport Avenue Southbound				Del Amo Avenue Westbound				Newport Avenue Northbound				SR-55 Northbound Ramps Eastbound				Int. Total
	Left	Thru	Right	App. Total	Left	Thru	Right	App. Total	Left	Thru	Right	App. Total	Left	Thru	Right	App. Total	
04:00 PM	1	25	86	112	10	121	2	133	130	58	12	200	28	8	7	43	488
04:15 PM	4	26	94	124	6	88	2	96	164	48	11	223	19	10	6	35	478
04:30 PM	0	27	92	119	4	88	3	95	151	51	6	208	26	3	7	36	458
04:45 PM	1	23	93	117	3	74	5	82	117	30	6	153	26	10	3	39	391
Total	6	101	365	472	23	371	12	406	562	187	35	784	99	31	23	153	1815
05:00 PM	3	21	94	118	10	98	6	114	151	45	11	207	33	13	5	51	490
05:15 PM	3	18	82	103	4	87	4	95	149	46	11	206	24	15	3	42	446
05:30 PM	0	14	71	85	4	90	2	96	147	45	8	200	15	17	2	34	415
05:45 PM	3	23	74	100	2	59	3	64	129	32	2	163	26	7	6	39	366
Total	9	76	321	406	20	334	15	369	576	168	32	776	98	52	16	166	1717
Grand Total	15	177	686	878	43	705	27	775	1138	355	67	1560	197	83	39	319	3532
Apprch %	1.7	20.2	78.1		5.5	91	3.5		72.9	22.8	4.3		61.8	26	12.2		
Total %	0.4	5	19.4	24.9	1.2	20	0.8	21.9	32.2	10.1	1.9	44.2	5.6	2.3	1.1	9	

Start Time	Newport Avenue Southbound				Del Amo Avenue Westbound				Newport Avenue Northbound				SR-55 Northbound Ramps Eastbound				Int. Total
	Left	Thru	Right	App. Total	Left	Thru	Right	App. Total	Left	Thru	Right	App. Total	Left	Thru	Right	App. Total	
Peak Hour Analysis From 04:00 PM to 05:45 PM - Peak 1 of 1																	
Peak Hour for Entire Intersection Begins at 04:15 PM																	
04:15 PM	4	26	94	124	6	88	2	96	164	48	11	223	19	10	6	35	478
04:30 PM	0	27	92	119	4	88	3	95	151	51	6	208	26	3	7	36	458
04:45 PM	1	23	93	117	3	74	5	82	117	30	6	153	26	10	3	39	391
05:00 PM	3	21	94	118	10	98	6	114	151	45	11	207	33	13	5	51	490
Total Volume	8	97	373	478	23	348	16	387	583	174	34	791	104	36	21	161	1817
% App. Total	1.7	20.3	78		5.9	89.9	4.1		73.7	22	4.3		64.6	22.4	13		
PHF	.500	.898	.992	.964	.575	.888	.667	.849	.889	.853	.773	.887	.788	.692	.750	.789	.927

City of Tustin
 N/S: Newport Avenue
 E/W: SR-55 NB Ramps/Del Amo Avenue
 Weather: Clear

File Name : 96_TUS_Newport_55N PM
 Site Code : 20220171
 Start Date : 3/12/2020
 Page No : 2

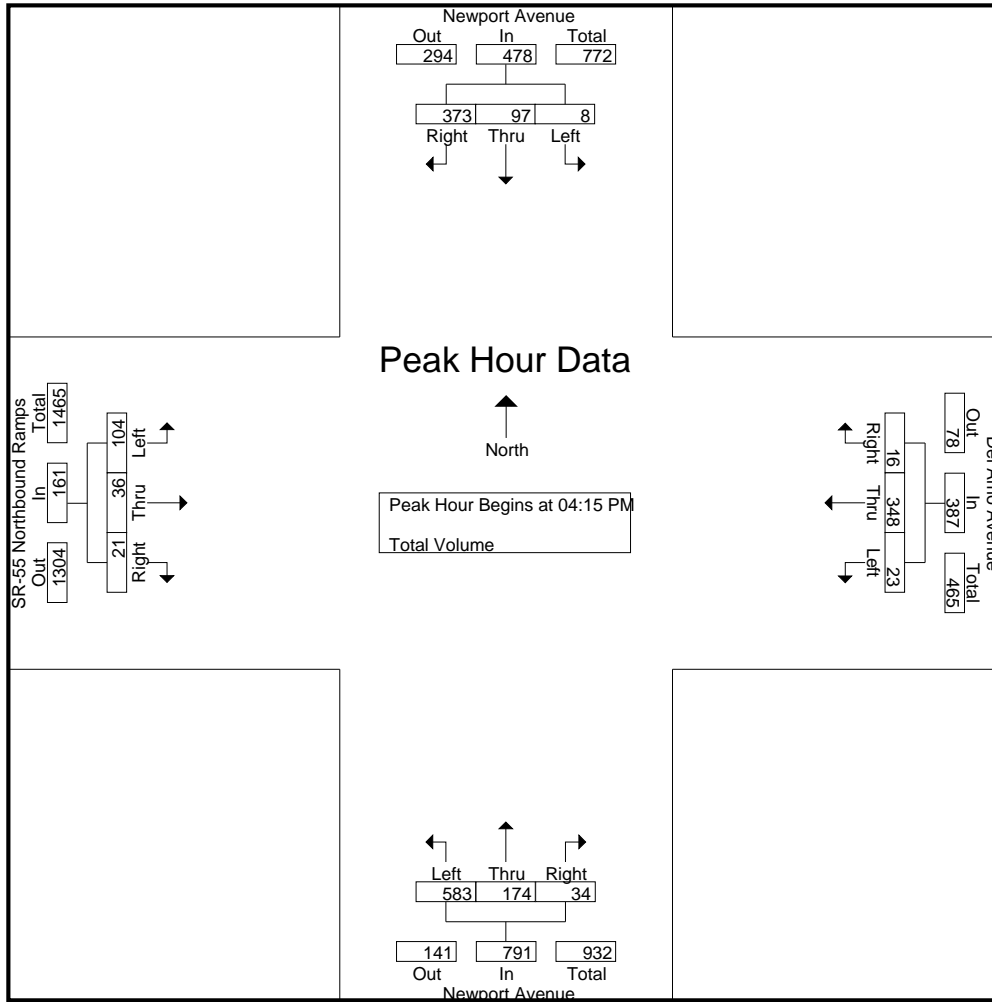

Peak Hour Analysis From 04:00 PM to 05:45 PM - Peak 1 of 1
 Peak Hour for Each Approach Begins at:

	04:15 PM				04:00 PM				04:15 PM				04:30 PM			
+0 mins.	4	26	94	124	10	121	2	133	164	48	11	223	26	3	7	36
+15 mins.	0	27	92	119	6	88	2	96	151	51	6	208	26	10	3	39
+30 mins.	1	23	93	117	4	88	3	95	117	30	6	153	33	13	5	51
+45 mins.	3	21	94	118	3	74	5	82	151	45	11	207	24	15	3	42
Total Volume	8	97	373	478	23	371	12	406	583	174	34	791	109	41	18	168
% App. Total	1.7	20.3	78		5.7	91.4	3		73.7	22	4.3		64.9	24.4	10.7	
PHF	.500	.898	.992	.964	.575	.767	.600	.763	.889	.853	.773	.887	.826	.683	.643	.824

City of Tustin
 N/S: Red Hill Avenue
 E/W: Edinger Avenue
 Weather: Clear

File Name : 97_TUS_Red Hill_Edinger AM
 Site Code : 20220171
 Start Date : 3/12/2020
 Page No : 1

Groups Printed- Total Volume

Start Time	Red Hill Avenue Southbound				Edinger Avenue Westbound				Red Hill Avenue Northbound				Edinger Avenue Eastbound				Int. Total
	Left	Thru	Right	App. Total	Left	Thru	Right	App. Total	Left	Thru	Right	App. Total	Left	Thru	Right	App. Total	
07:00 AM	40	183	74	297	15	123	19	157	32	53	15	100	44	129	38	211	765
07:15 AM	53	201	87	341	37	182	28	247	40	87	18	145	52	149	28	229	962
07:30 AM	57	243	109	409	47	233	42	322	14	80	9	103	64	174	33	271	1105
07:45 AM	68	225	116	409	60	287	35	382	20	89	37	146	49	183	30	262	1199
Total	218	852	386	1456	159	825	124	1108	106	309	79	494	209	635	129	973	4031
08:00 AM	54	264	126	444	56	292	34	382	22	69	22	113	35	117	31	183	1122
08:15 AM	47	228	99	374	61	273	41	375	25	61	17	103	42	137	36	215	1067
08:30 AM	52	200	97	349	68	258	42	368	18	68	7	93	47	133	29	209	1019
08:45 AM	61	220	107	388	45	218	34	297	20	48	15	83	32	146	34	212	980
Total	214	912	429	1555	230	1041	151	1422	85	246	61	392	156	533	130	819	4188
Grand Total	432	1764	815	3011	389	1866	275	2530	191	555	140	886	365	1168	259	1792	8219
Apprch %	14.3	58.6	27.1		15.4	73.8	10.9		21.6	62.6	15.8		20.4	65.2	14.5		
Total %	5.3	21.5	9.9	36.6	4.7	22.7	3.3	30.8	2.3	6.8	1.7	10.8	4.4	14.2	3.2	21.8	

Start Time	Red Hill Avenue Southbound				Edinger Avenue Westbound				Red Hill Avenue Northbound				Edinger Avenue Eastbound				Int. Total
	Left	Thru	Right	App. Total	Left	Thru	Right	App. Total	Left	Thru	Right	App. Total	Left	Thru	Right	App. Total	
Peak Hour Analysis From 07:00 AM to 08:45 AM - Peak 1 of 1																	
Peak Hour for Entire Intersection Begins at 07:30 AM																	
07:30 AM	57	243	109	409	47	233	42	322	14	80	9	103	64	174	33	271	1105
07:45 AM	68	225	116	409	60	287	35	382	20	89	37	146	49	183	30	262	1199
08:00 AM	54	264	126	444	56	292	34	382	22	69	22	113	35	117	31	183	1122
08:15 AM	47	228	99	374	61	273	41	375	25	61	17	103	42	137	36	215	1067
Total Volume	226	960	450	1636	224	1085	152	1461	81	299	85	465	190	611	130	931	4493
% App. Total	13.8	58.7	27.5		15.3	74.3	10.4		17.4	64.3	18.3		20.4	65.6	14		
PHF	.831	.909	.893	.921	.918	.929	.905	.956	.810	.840	.574	.796	.742	.835	.903	.859	.937

City of Tustin
 N/S: Red Hill Avenue
 E/W: Edinger Avenue
 Weather: Clear

File Name : 97_TUS_Red Hill_Edinger AM
 Site Code : 20220171
 Start Date : 3/12/2020
 Page No : 2

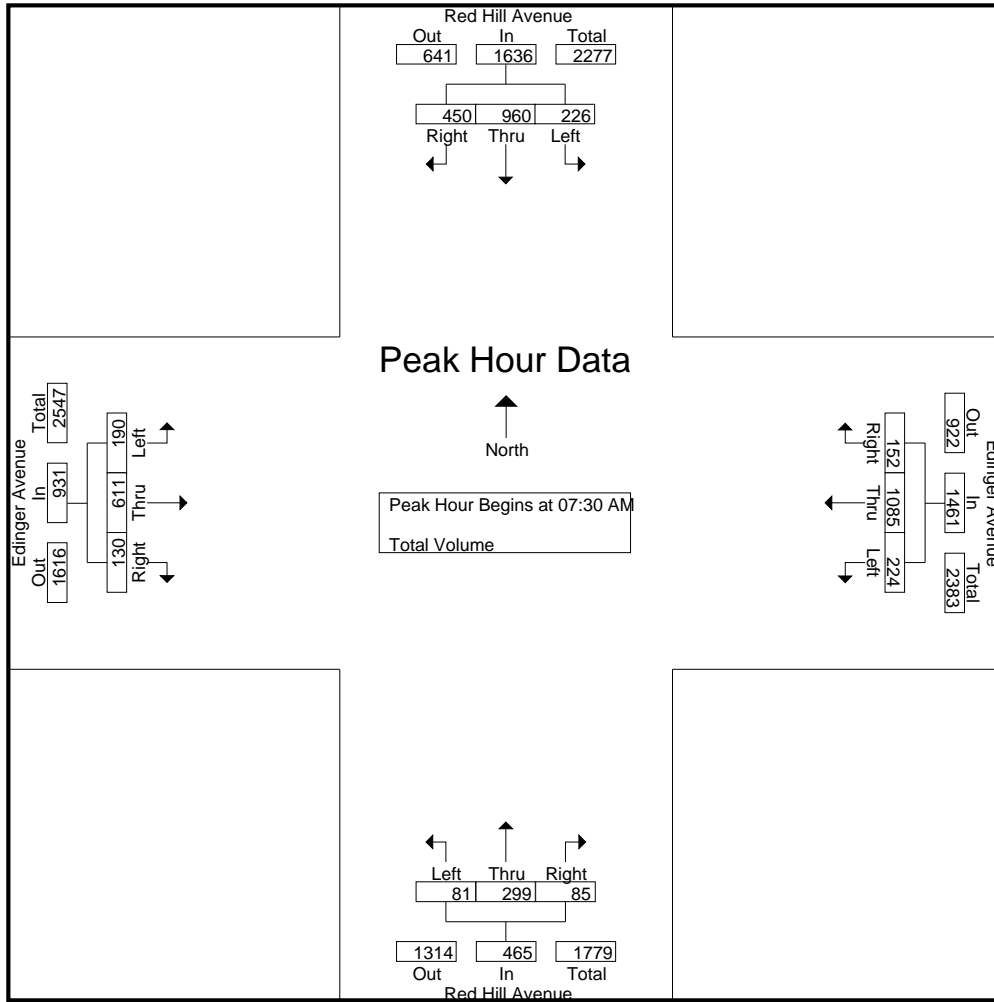

Peak Hour Analysis From 07:00 AM to 08:45 AM - Peak 1 of 1
 Peak Hour for Each Approach Begins at:

	07:30 AM				07:45 AM				07:15 AM				07:00 AM			
+0 mins.	57	243	109	409	60	287	35	382	40	87	18	145	44	129	38	211
+15 mins.	68	225	116	409	56	292	34	382	14	80	9	103	52	149	28	229
+30 mins.	54	264	126	444	61	273	41	375	20	89	37	146	64	174	33	271
+45 mins.	47	228	99	374	68	258	42	368	22	69	22	113	49	183	30	262
Total Volume	226	960	450	1636	245	1110	152	1507	96	325	86	507	209	635	129	973
% App. Total	13.8	58.7	27.5		16.3	73.7	10.1		18.9	64.1	17		21.5	65.3	13.3	
PHF	.831	.909	.893	.921	.901	.950	.905	.986	.600	.913	.581	.868	.816	.867	.849	.898

City of Tustin
 N/S: Red Hill Avenue
 E/W: Edinger Avenue
 Weather: Clear

File Name : 97_TUS_Red Hill_Edinger PM
 Site Code : 20220171
 Start Date : 3/12/2020
 Page No : 1

Groups Printed- Total Volume

Start Time	Red Hill Avenue Southbound				Edinger Avenue Westbound				Red Hill Avenue Northbound				Edinger Avenue Eastbound				Int. Total
	Left	Thru	Right	App. Total	Left	Thru	Right	App. Total	Left	Thru	Right	App. Total	Left	Thru	Right	App. Total	
04:00 PM	36	69	60	165	13	210	108	331	31	237	42	310	67	153	30	250	1056
04:15 PM	28	73	55	156	17	231	105	353	34	260	41	335	66	145	26	237	1081
04:30 PM	36	72	50	158	14	219	95	328	37	282	34	353	70	145	25	240	1079
04:45 PM	39	76	58	173	15	172	85	272	48	251	46	345	80	147	26	253	1043
Total	139	290	223	652	59	832	393	1284	150	1030	163	1343	283	590	107	980	4259
05:00 PM	30	72	58	160	15	225	93	333	34	281	47	362	80	210	27	317	1172
05:15 PM	40	74	59	173	15	195	119	329	29	276	49	354	95	218	22	335	1191
05:30 PM	36	67	59	162	17	211	95	323	48	338	40	426	72	263	27	362	1273
05:45 PM	40	74	42	156	17	161	93	271	33	249	40	322	58	153	27	238	987
Total	146	287	218	651	64	792	400	1256	144	1144	176	1464	305	844	103	1252	4623
Grand Total	285	577	441	1303	123	1624	793	2540	294	2174	339	2807	588	1434	210	2232	8882
Apprch %	21.9	44.3	33.8		4.8	63.9	31.2		10.5	77.4	12.1		26.3	64.2	9.4		
Total %	3.2	6.5	5	14.7	1.4	18.3	8.9	28.6	3.3	24.5	3.8	31.6	6.6	16.1	2.4	25.1	

Start Time	Red Hill Avenue Southbound				Edinger Avenue Westbound				Red Hill Avenue Northbound				Edinger Avenue Eastbound				Int. Total
	Left	Thru	Right	App. Total	Left	Thru	Right	App. Total	Left	Thru	Right	App. Total	Left	Thru	Right	App. Total	
Peak Hour Analysis From 04:00 PM to 05:45 PM - Peak 1 of 1																	
Peak Hour for Entire Intersection Begins at 04:45 PM																	
04:45 PM	39	76	58	173	15	172	85	272	48	251	46	345	80	147	26	253	1043
05:00 PM	30	72	58	160	15	225	93	333	34	281	47	362	80	210	27	317	1172
05:15 PM	40	74	59	173	15	195	119	329	29	276	49	354	95	218	22	335	1191
05:30 PM	36	67	59	162	17	211	95	323	48	338	40	426	72	263	27	362	1273
Total Volume	145	289	234	668	62	803	392	1257	159	1146	182	1487	327	838	102	1267	4679
% App. Total	21.7	43.3	35		4.9	63.9	31.2		10.7	77.1	12.2		25.8	66.1	8.1		
PHF	.906	.951	.992	.965	.912	.892	.824	.944	.828	.848	.929	.873	.861	.797	.944	.875	.919

City of Tustin
 N/S: Red Hill Avenue
 E/W: Edinger Avenue
 Weather: Clear

File Name : 97_TUS_Red Hill_Edinger PM
 Site Code : 20220171
 Start Date : 3/12/2020
 Page No : 2

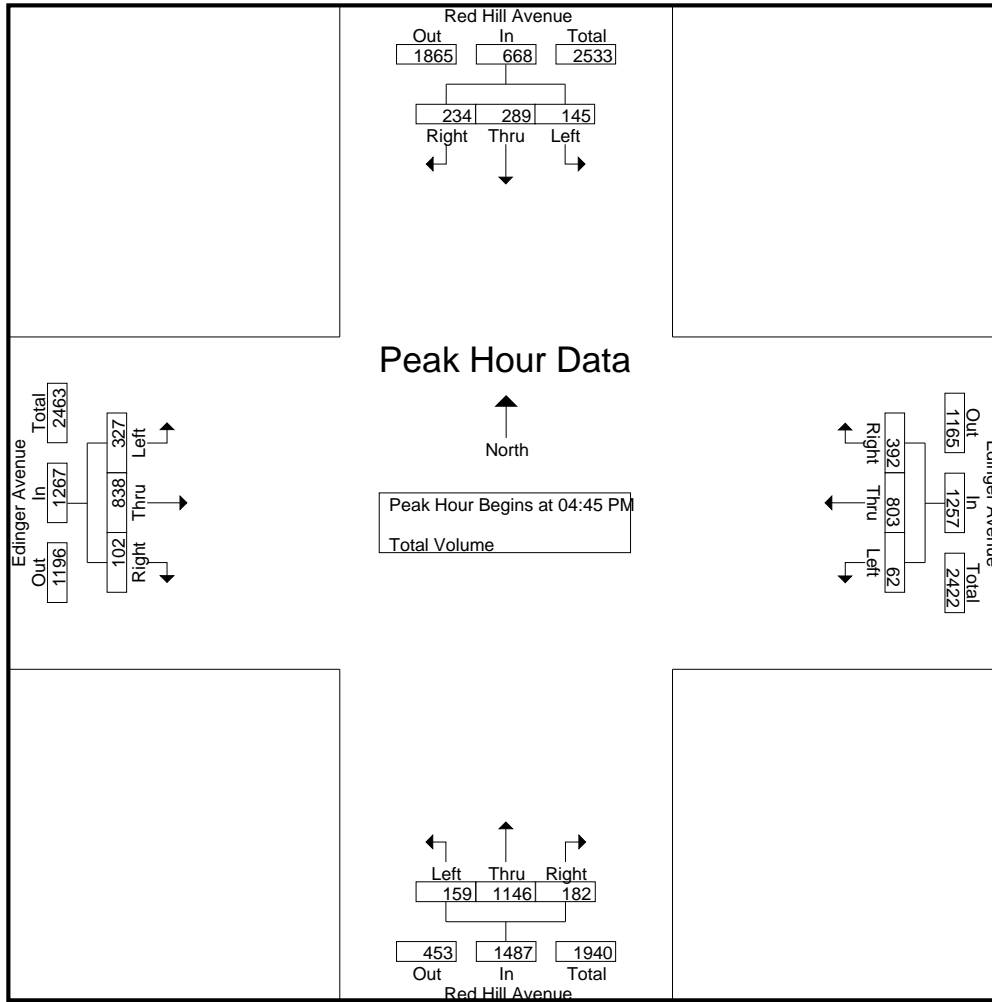

Peak Hour Analysis From 04:00 PM to 05:45 PM - Peak 1 of 1
 Peak Hour for Each Approach Begins at:

	04:45 PM				04:15 PM				04:45 PM				04:45 PM			
+0 mins.	39	76	58	173	17	231	105	353	48	251	46	345	80	147	26	253
+15 mins.	30	72	58	160	14	219	95	328	34	281	47	362	80	210	27	317
+30 mins.	40	74	59	173	15	172	85	272	29	276	49	354	95	218	22	335
+45 mins.	36	67	59	162	15	225	93	333	48	338	40	426	72	263	27	362
Total Volume	145	289	234	668	61	847	378	1286	159	1146	182	1487	327	838	102	1267
% App. Total	21.7	43.3	35		4.7	65.9	29.4		10.7	77.1	12.2		25.8	66.1	8.1	
PHF	.906	.951	.992	.965	.897	.917	.900	.911	.828	.848	.929	.873	.861	.797	.944	.875

City of Santa Ana
 N/S: Red Hill Avenue
 E/W: Warner Avenue
 Weather: Clear

File Name : 98_TUS_Red Hill_Warner_AM
 Site Code : 20220171
 Start Date : 3/12/2020
 Page No : 1

Groups Printed- Total Volume

Start Time	Red Hill Avenue Southbound				Warner Avenue Westbound				Red Hill Avenue Northbound				Warner Avenue Eastbound				Int. Total
	Left	Thru	Right	App. Total	Left	Thru	Right	App. Total	Left	Thru	Right	App. Total	Left	Thru	Right	App. Total	
07:00 AM	3	183	31	217	11	41	6	58	24	181	8	213	41	44	38	123	611
07:15 AM	1	163	50	214	17	59	14	90	19	154	11	184	41	60	62	163	651
07:30 AM	3	231	41	275	22	75	12	109	16	94	10	120	49	70	69	188	692
07:45 AM	5	214	42	261	17	75	14	106	15	92	8	115	55	99	76	230	712
Total	12	791	164	967	67	250	46	363	74	521	37	632	186	273	245	704	2666
08:00 AM	4	255	43	302	25	92	19	136	17	89	10	116	47	72	61	180	734
08:15 AM	3	228	45	276	23	90	16	129	9	74	11	94	56	86	54	196	695
08:30 AM	7	194	49	250	33	92	13	138	15	84	17	116	44	86	62	192	696
08:45 AM	13	191	54	258	22	82	16	120	9	96	16	121	32	71	53	156	655
Total	27	868	191	1086	103	356	64	523	50	343	54	447	179	315	230	724	2780
Grand Total	39	1659	355	2053	170	606	110	886	124	864	91	1079	365	588	475	1428	5446
Apprch %	1.9	80.8	17.3		19.2	68.4	12.4		11.5	80.1	8.4		25.6	41.2	33.3		
Total %	0.7	30.5	6.5	37.7	3.1	11.1	2	16.3	2.3	15.9	1.7	19.8	6.7	10.8	8.7	26.2	

Start Time	Red Hill Avenue Southbound				Warner Avenue Westbound				Red Hill Avenue Northbound				Warner Avenue Eastbound				Int. Total
	Left	Thru	Right	App. Total	Left	Thru	Right	App. Total	Left	Thru	Right	App. Total	Left	Thru	Right	App. Total	
Peak Hour Analysis From 07:00 AM to 08:45 AM - Peak 1 of 1																	
Peak Hour for Entire Intersection Begins at 07:45 AM																	
07:45 AM	5	214	42	261	17	75	14	106	15	92	8	115	55	99	76	230	712
08:00 AM	4	255	43	302	25	92	19	136	17	89	10	116	47	72	61	180	734
08:15 AM	3	228	45	276	23	90	16	129	9	74	11	94	56	86	54	196	695
08:30 AM	7	194	49	250	33	92	13	138	15	84	17	116	44	86	62	192	696
Total Volume	19	891	179	1089	98	349	62	509	56	339	46	441	202	343	253	798	2837
% App. Total	1.7	81.8	16.4		19.3	68.6	12.2		12.7	76.9	10.4		25.3	43	31.7		
PHF	.679	.874	.913	.901	.742	.948	.816	.922	.824	.921	.676	.950	.902	.866	.832	.867	.966

City of Santa Ana
 N/S: Red Hill Avenue
 E/W: Warner Avenue
 Weather: Clear

File Name : 98_TUS_Red Hill_Warner_AM
 Site Code : 20220171
 Start Date : 3/12/2020
 Page No : 2

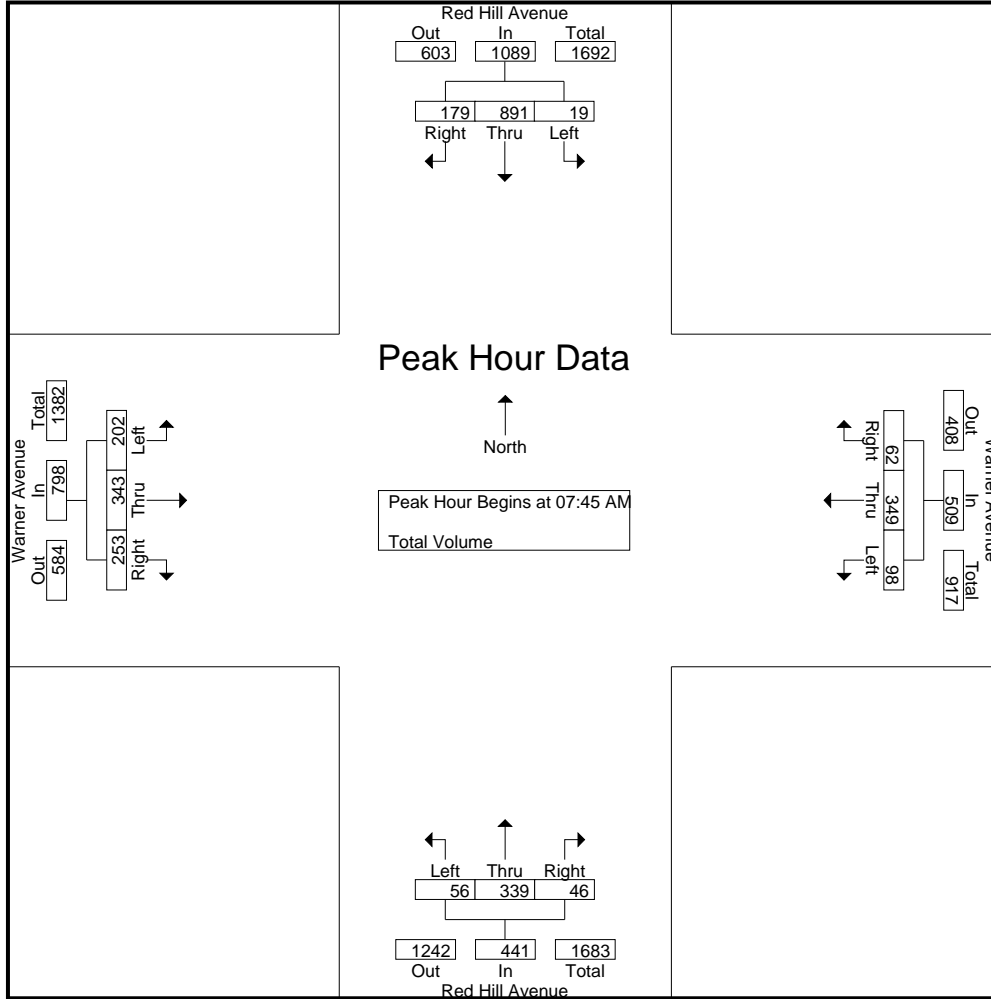

Peak Hour Analysis From 07:00 AM to 08:45 AM - Peak 1 of 1
 Peak Hour for Each Approach Begins at:

	07:30 AM				08:00 AM				07:00 AM				07:45 AM			
+0 mins.	3	231	41	275	25	92	19	136	24	181	8	213	55	99	76	230
+15 mins.	5	214	42	261	23	90	16	129	19	154	11	184	47	72	61	180
+30 mins.	4	255	43	302	33	92	13	138	16	94	10	120	56	86	54	196
+45 mins.	3	228	45	276	22	82	16	120	15	92	8	115	44	86	62	192
Total Volume	15	928	171	1114	103	356	64	523	74	521	37	632	202	343	253	798
% App. Total	1.3	83.3	15.4		19.7	68.1	12.2		11.7	82.4	5.9		25.3	43	31.7	
PHF	.750	.910	.950	.922	.780	.967	.842	.947	.771	.720	.841	.742	.902	.866	.832	.867

City of Santa Ana
 N/S: Red Hill Avenue
 E/W: Warner Avenue
 Weather: Clear

File Name : 98_TUS_Red Hill_Warner_PM
 Site Code : 20220171
 Start Date : 3/12/2020
 Page No : 1

Groups Printed- Total Volume

Start Time	Red Hill Avenue Southbound				Warner Avenue Westbound				Red Hill Avenue Northbound				Warner Avenue Eastbound				Int. Total
	Left	Thru	Right	App. Total	Left	Thru	Right	App. Total	Left	Thru	Right	App. Total	Left	Thru	Right	App. Total	
04:00 PM	12	48	60	120	4	77	11	92	69	254	32	355	41	108	36	185	752
04:15 PM	14	48	80	142	8	123	13	144	76	273	31	380	52	94	35	181	847
04:30 PM	11	35	66	112	14	124	14	152	82	264	42	388	49	125	28	202	854
04:45 PM	15	39	74	128	10	133	13	156	93	325	24	442	56	128	18	202	928
Total	52	170	280	502	36	457	51	544	320	1116	129	1565	198	455	117	770	3381
05:00 PM	14	51	73	138	3	120	20	143	85	373	39	497	61	156	24	241	1019
05:15 PM	11	71	60	142	8	169	20	197	108	254	41	403	59	155	25	239	981
05:30 PM	18	62	76	156	4	103	16	123	96	356	46	498	46	164	27	237	1014
05:45 PM	11	55	73	139	6	121	20	147	87	257	53	397	55	151	21	227	910
Total	54	239	282	575	21	513	76	610	376	1240	179	1795	221	626	97	944	3924
Grand Total	106	409	562	1077	57	970	127	1154	696	2356	308	3360	419	1081	214	1714	7305
Apprch %	9.8	38	52.2		4.9	84.1	11		20.7	70.1	9.2		24.4	63.1	12.5		
Total %	1.5	5.6	7.7	14.7	0.8	13.3	1.7	15.8	9.5	32.3	4.2	46	5.7	14.8	2.9	23.5	

Start Time	Red Hill Avenue Southbound				Warner Avenue Westbound				Red Hill Avenue Northbound				Warner Avenue Eastbound				Int. Total
	Left	Thru	Right	App. Total	Left	Thru	Right	App. Total	Left	Thru	Right	App. Total	Left	Thru	Right	App. Total	
Peak Hour Analysis From 04:00 PM to 05:45 PM - Peak 1 of 1																	
Peak Hour for Entire Intersection Begins at 04:45 PM																	
04:45 PM	15	39	74	128	10	133	13	156	93	325	24	442	56	128	18	202	928
05:00 PM	14	51	73	138	3	120	20	143	85	373	39	497	61	156	24	241	1019
05:15 PM	11	71	60	142	8	169	20	197	108	254	41	403	59	155	25	239	981
05:30 PM	18	62	76	156	4	103	16	123	96	356	46	498	46	164	27	237	1014
Total Volume	58	223	283	564	25	525	69	619	382	1308	150	1840	222	603	94	919	3942
% App. Total	10.3	39.5	50.2		4	84.8	11.1		20.8	71.1	8.2		24.2	65.6	10.2		
PHF	.806	.785	.931	.904	.625	.777	.863	.786	.884	.877	.815	.924	.910	.919	.870	.953	.967

City of Santa Ana
 N/S: Red Hill Avenue
 E/W: Warner Avenue
 Weather: Clear

File Name : 98_TUS_Red Hill_Warner_PM
 Site Code : 20220171
 Start Date : 3/12/2020
 Page No : 2

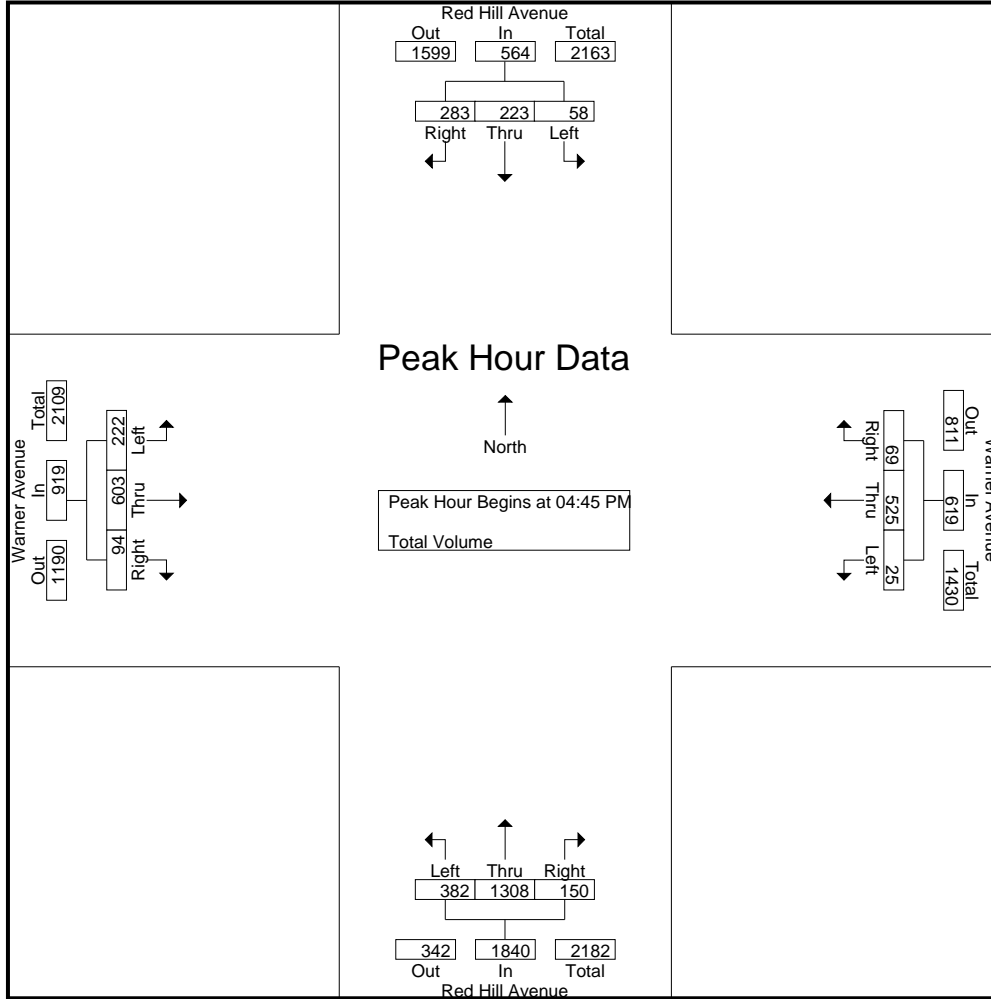

Peak Hour Analysis From 04:00 PM to 05:45 PM - Peak 1 of 1
 Peak Hour for Each Approach Begins at:

	05:00 PM				04:30 PM				04:45 PM				05:00 PM			
+0 mins.	14	51	73	138	14	124	14	152	93	325	24	442	61	156	24	241
+15 mins.	11	71	60	142	10	133	13	156	85	373	39	497	59	155	25	239
+30 mins.	18	62	76	156	3	120	20	143	108	254	41	403	46	164	27	237
+45 mins.	11	55	73	139	8	169	20	197	96	356	46	498	55	151	21	227
Total Volume	54	239	282	575	35	546	67	648	382	1308	150	1840	221	626	97	944
% App. Total	9.4	41.6	49		5.4	84.3	10.3		20.8	71.1	8.2		23.4	66.3	10.3	
PHF	.750	.842	.928	.921	.625	.808	.838	.822	.884	.877	.815	.924	.906	.954	.898	.979

City of Santa Ana
 N/S: Red Hill Avenue
 E/W: Dyer Road/Barranca Parkway
 Weather: Clear

File Name : 99_SNA_Red Hill_Barranca AM
 Site Code : 20220171
 Start Date : 3/12/2020
 Page No : 1

Groups Printed- Total Volume

Start Time	Red Hill Avenue Southbound				Barranca Parkway Westbound				Red Hill Avenue Northbound				Dyer Road Eastbound				Int. Total
	Left	Thru	Right	App. Total	Left	Thru	Right	App. Total	Left	Thru	Right	App. Total	Left	Thru	Right	App. Total	
07:00 AM	41	134	25	200	51	114	27	192	119	178	24	321	41	103	45	189	902
07:15 AM	50	127	22	199	90	136	21	247	100	153	24	277	37	154	90	281	1004
07:30 AM	37	206	30	273	105	141	25	271	48	85	27	160	23	182	52	257	961
07:45 AM	64	175	30	269	187	174	38	399	24	74	27	125	32	190	109	331	1124
Total	192	642	107	941	433	565	111	1109	291	490	102	883	133	629	296	1058	3991
08:00 AM	45	266	24	335	167	163	32	362	26	76	26	128	31	141	66	238	1063
08:15 AM	53	229	31	313	119	167	31	317	29	81	24	134	32	197	54	283	1047
08:30 AM	43	200	18	261	149	149	42	340	22	63	16	101	26	172	49	247	949
08:45 AM	46	187	27	260	148	146	37	331	25	77	16	118	25	149	90	264	973
Total	187	882	100	1169	583	625	142	1350	102	297	82	481	114	659	259	1032	4032
Grand Total	379	1524	207	2110	1016	1190	253	2459	393	787	184	1364	247	1288	555	2090	8023
Apprch %	18	72.2	9.8		41.3	48.4	10.3		28.8	57.7	13.5		11.8	61.6	26.6		
Total %	4.7	19	2.6	26.3	12.7	14.8	3.2	30.6	4.9	9.8	2.3	17	3.1	16.1	6.9	26.1	

Start Time	Red Hill Avenue Southbound				Barranca Parkway Westbound				Red Hill Avenue Northbound				Dyer Road Eastbound				Int. Total
	Left	Thru	Right	App. Total	Left	Thru	Right	App. Total	Left	Thru	Right	App. Total	Left	Thru	Right	App. Total	
Peak Hour Analysis From 07:00 AM to 08:45 AM - Peak 1 of 1																	
Peak Hour for Entire Intersection Begins at 07:30 AM																	
07:30 AM	37	206	30	273	105	141	25	271	48	85	27	160	23	182	52	257	961
07:45 AM	64	175	30	269	187	174	38	399	24	74	27	125	32	190	109	331	1124
08:00 AM	45	266	24	335	167	163	32	362	26	76	26	128	31	141	66	238	1063
08:15 AM	53	229	31	313	119	167	31	317	29	81	24	134	32	197	54	283	1047
Total Volume	199	876	115	1190	578	645	126	1349	127	316	104	547	118	710	281	1109	4195
% App. Total	16.7	73.6	9.7		42.8	47.8	9.3		23.2	57.8	19		10.6	64	25.3		
PHF	.777	.823	.927	.888	.773	.927	.829	.845	.661	.929	.963	.855	.922	.901	.644	.838	.933

City of Santa Ana
 N/S: Red Hill Avenue
 E/W: Dyer Road/Barranca Parkway
 Weather: Clear

File Name : 99_SNA_Red Hill_Barranca AM
 Site Code : 20220171
 Start Date : 3/12/2020
 Page No : 2

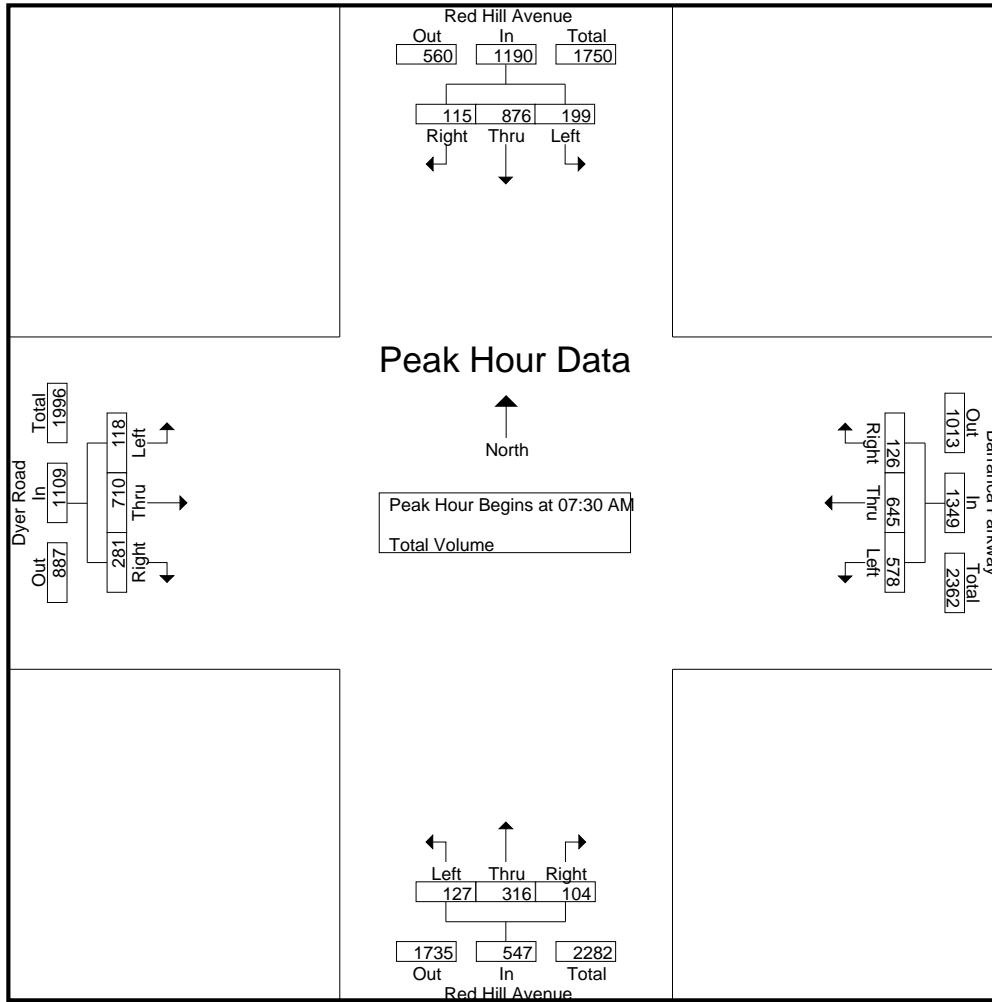

Peak Hour Analysis From 07:00 AM to 08:45 AM - Peak 1 of 1
 Peak Hour for Each Approach Begins at:

	07:30 AM				07:45 AM				07:00 AM				07:30 AM			
+0 mins.	37	206	30	273	187	174	38	399	119	178	24	321	23	182	52	257
+15 mins.	64	175	30	269	167	163	32	362	100	153	24	277	32	190	109	331
+30 mins.	45	266	24	335	119	167	31	317	48	85	27	160	31	141	66	238
+45 mins.	53	229	31	313	149	149	42	340	24	74	27	125	32	197	54	283
Total Volume	199	876	115	1190	622	653	143	1418	291	490	102	883	118	710	281	1109
% App. Total	16.7	73.6	9.7		43.9	46.1	10.1		33	55.5	11.6		10.6	64	25.3	
PHF	.777	.823	.927	.888	.832	.938	.851	.888	.611	.688	.944	.688	.922	.901	.644	.838

City of Santa Ana
 N/S: Red Hill Avenue
 E/W: Dyer Road/Barranca Parkway
 Weather: Clear

File Name : 99_SNA_Red Hill_Barranca PM
 Site Code : 20220171
 Start Date : 3/12/2020
 Page No : 1

Groups Printed- Total Volume

Start Time	Red Hill Avenue Southbound				Barranca Parkway Westbound				Red Hill Avenue Northbound				Dyer Road Eastbound				Int. Total
	Left	Thru	Right	App. Total	Left	Thru	Right	App. Total	Left	Thru	Right	App. Total	Left	Thru	Right	App. Total	
04:00 PM	33	69	32	134	36	206	71	313	59	258	84	401	35	124	27	186	1034
04:15 PM	34	76	32	142	33	169	70	272	69	292	64	425	37	128	23	188	1027
04:30 PM	27	64	26	117	26	266	80	372	55	266	82	403	51	158	27	236	1128
04:45 PM	49	86	27	162	39	164	64	267	65	350	79	494	38	148	32	218	1141
Total	143	295	117	555	134	805	285	1224	248	1166	309	1723	161	558	109	828	4330
05:00 PM	42	93	45	180	19	273	87	379	102	393	81	576	38	182	20	240	1375
05:15 PM	53	68	38	159	35	212	65	312	91	323	99	513	49	191	18	258	1242
05:30 PM	39	83	32	154	39	216	68	323	78	354	91	523	62	187	32	281	1281
05:45 PM	51	69	32	152	34	265	62	361	85	269	74	428	54	193	29	276	1217
Total	185	313	147	645	127	966	282	1375	356	1339	345	2040	203	753	99	1055	5115
Grand Total	328	608	264	1200	261	1771	567	2599	604	2505	654	3763	364	1311	208	1883	9445
Apprch %	27.3	50.7	22		10	68.1	21.8		16.1	66.6	17.4		19.3	69.6	11		
Total %	3.5	6.4	2.8	12.7	2.8	18.8	6	27.5	6.4	26.5	6.9	39.8	3.9	13.9	2.2	19.9	

Start Time	Red Hill Avenue Southbound				Barranca Parkway Westbound				Red Hill Avenue Northbound				Dyer Road Eastbound				Int. Total
	Left	Thru	Right	App. Total	Left	Thru	Right	App. Total	Left	Thru	Right	App. Total	Left	Thru	Right	App. Total	
Peak Hour Analysis From 04:00 PM to 05:45 PM - Peak 1 of 1																	
Peak Hour for Entire Intersection Begins at 05:00 PM																	
05:00 PM	42	93	45	180	19	273	87	379	102	393	81	576	38	182	20	240	1375
05:15 PM	53	68	38	159	35	212	65	312	91	323	99	513	49	191	18	258	1242
05:30 PM	39	83	32	154	39	216	68	323	78	354	91	523	62	187	32	281	1281
05:45 PM	51	69	32	152	34	265	62	361	85	269	74	428	54	193	29	276	1217
Total Volume	185	313	147	645	127	966	282	1375	356	1339	345	2040	203	753	99	1055	5115
% App. Total	28.7	48.5	22.8		9.2	70.3	20.5		17.5	65.6	16.9		19.2	71.4	9.4		
PHF	.873	.841	.817	.896	.814	.885	.810	.907	.873	.852	.871	.885	.819	.975	.773	.939	.930

City of Santa Ana
 N/S: Red Hill Avenue
 E/W: Dyer Road/Barranca Parkway
 Weather: Clear

File Name : 99_SNA_Red Hill_Barranca PM
 Site Code : 20220171
 Start Date : 3/12/2020
 Page No : 2

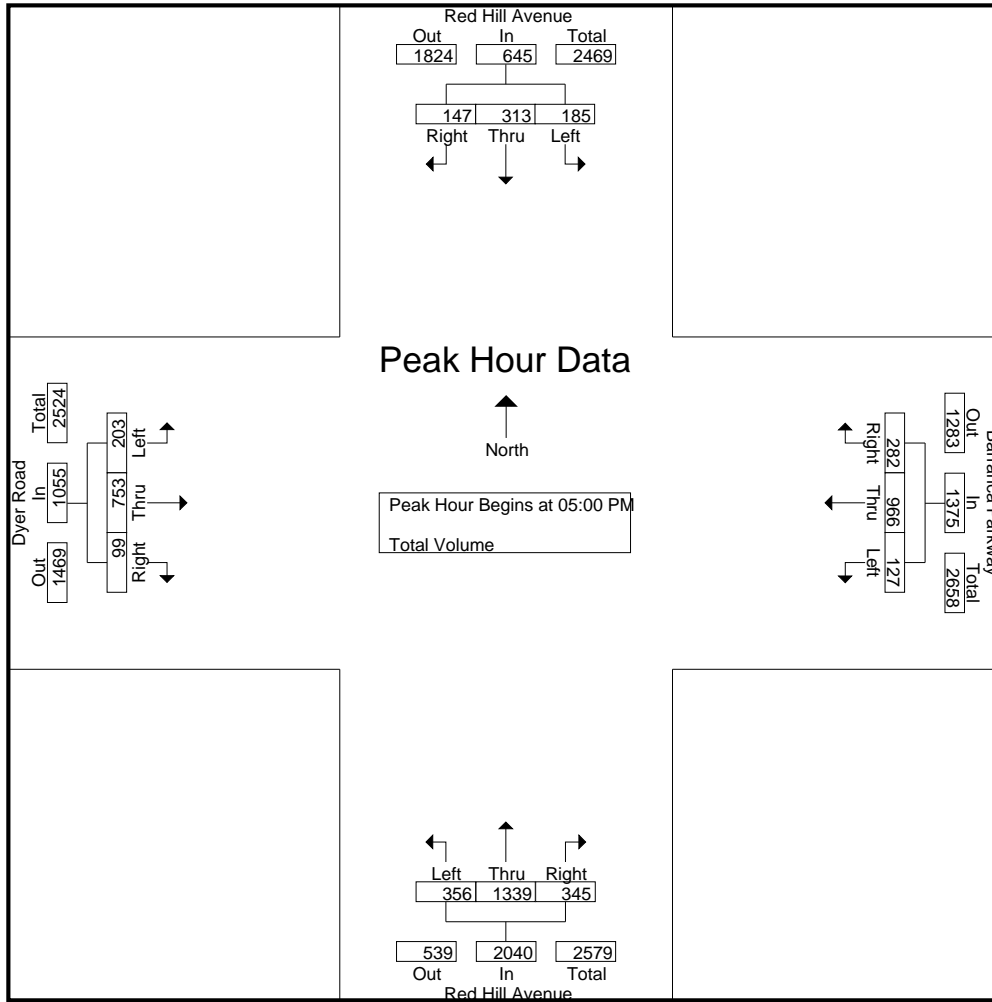

Peak Hour Analysis From 04:00 PM to 05:45 PM - Peak 1 of 1
 Peak Hour for Each Approach Begins at:

	04:45 PM				05:00 PM				04:45 PM				05:00 PM			
+0 mins.	49	86	27	162	19	273	87	379	65	350	79	494	38	182	20	240
+15 mins.	42	93	45	180	35	212	65	312	102	393	81	576	49	191	18	258
+30 mins.	53	68	38	159	39	216	68	323	91	323	99	513	62	187	32	281
+45 mins.	39	83	32	154	34	265	62	361	78	354	91	523	54	193	29	276
Total Volume	183	330	142	655	127	966	282	1375	336	1420	350	2106	203	753	99	1055
% App. Total	27.9	50.4	21.7		9.2	70.3	20.5		16	67.4	16.6		19.2	71.4	9.4	
PHF	.863	.887	.789	.910	.814	.885	.810	.907	.824	.903	.884	.914	.819	.975	.773	.939

City of Irvine
 N/S: Red Hill Avenue
 E/W: Alton Parkway
 Weather: Clear

File Name : 100_IRV_Red Hill_Alton AM
 Site Code : 20220171
 Start Date : 3/12/2020
 Page No : 1

Groups Printed- Total Volume

Start Time	Red Hill Avenue Southbound				Alton Parkway Westbound				Red Hill Avenue Northbound				Alton Parkway Eastbound				Int. Total
	Left	Thru	Right	App. Total	Left	Thru	Right	App. Total	Left	Thru	Right	App. Total	Left	Thru	Right	App. Total	
07:00 AM	47	153	15	215	24	15	15	54	31	312	62	405	2	4	4	10	684
07:15 AM	39	189	19	247	31	25	15	71	39	288	76	403	2	8	2	12	733
07:30 AM	60	241	29	330	43	27	27	97	39	153	63	255	3	8	7	18	700
07:45 AM	58	314	41	413	48	46	24	118	46	149	93	288	2	5	8	15	834
Total	204	897	104	1205	146	113	81	340	155	902	294	1351	9	25	21	55	2951
08:00 AM	83	302	55	440	53	50	27	130	53	133	76	262	3	4	9	16	848
08:15 AM	52	242	44	338	61	46	33	140	34	115	78	227	2	7	5	14	719
08:30 AM	58	283	43	384	61	47	22	130	41	115	74	230	2	12	6	20	764
08:45 AM	43	281	48	372	71	47	20	138	26	109	80	215	3	11	5	19	744
Total	236	1108	190	1534	246	190	102	538	154	472	308	934	10	34	25	69	3075
Grand Total	440	2005	294	2739	392	303	183	878	309	1374	602	2285	19	59	46	124	6026
Apprch %	16.1	73.2	10.7		44.6	34.5	20.8		13.5	60.1	26.3		15.3	47.6	37.1		
Total %	7.3	33.3	4.9	45.5	6.5	5	3	14.6	5.1	22.8	10	37.9	0.3	1	0.8	2.1	

Start Time	Red Hill Avenue Southbound				Alton Parkway Westbound				Red Hill Avenue Northbound				Alton Parkway Eastbound				Int. Total
	Left	Thru	Right	App. Total	Left	Thru	Right	App. Total	Left	Thru	Right	App. Total	Left	Thru	Right	App. Total	
Peak Hour Analysis From 07:00 AM to 08:45 AM - Peak 1 of 1																	
Peak Hour for Entire Intersection Begins at 07:45 AM																	
07:45 AM	58	314	41	413	48	46	24	118	46	149	93	288	2	5	8	15	834
08:00 AM	83	302	55	440	53	50	27	130	53	133	76	262	3	4	9	16	848
08:15 AM	52	242	44	338	61	46	33	140	34	115	78	227	2	7	5	14	719
08:30 AM	58	283	43	384	61	47	22	130	41	115	74	230	2	12	6	20	764
Total Volume	251	1141	183	1575	223	189	106	518	174	512	321	1007	9	28	28	65	3165
% App. Total	15.9	72.4	11.6		43.1	36.5	20.5		17.3	50.8	31.9		13.8	43.1	43.1		
PHF	.756	.908	.832	.895	.914	.945	.803	.925	.821	.859	.863	.874	.750	.583	.778	.813	.933

City of Irvine
 N/S: Red Hill Avenue
 E/W: Alton Parkway
 Weather: Clear

File Name : 100_IRV_Red Hill_Alton AM
 Site Code : 20220171
 Start Date : 3/12/2020
 Page No : 2

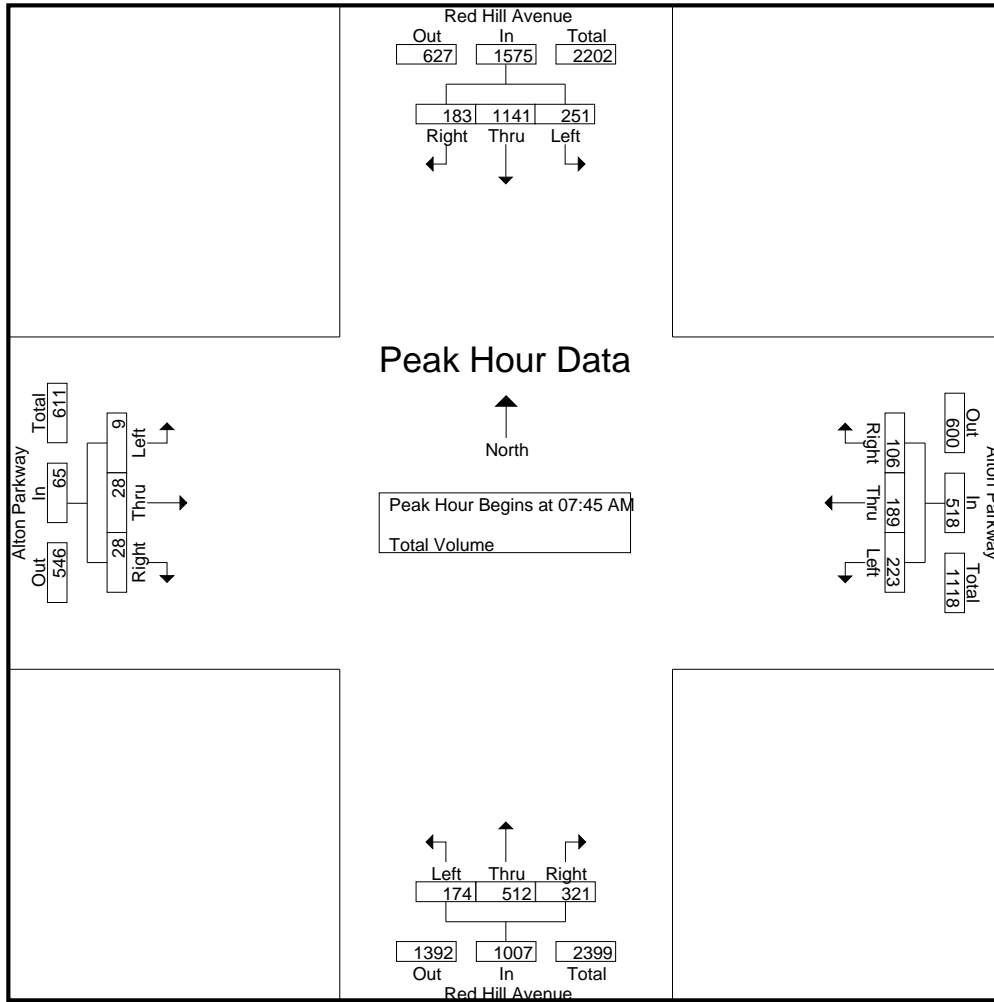

Peak Hour Analysis From 07:00 AM to 08:45 AM - Peak 1 of 1
 Peak Hour for Each Approach Begins at:

	07:45 AM				08:00 AM				07:00 AM				08:00 AM			
+0 mins.	58	314	41	413	53	50	27	130	31	312	62	405	3	4	9	16
+15 mins.	83	302	55	440	61	46	33	140	39	288	76	403	2	7	5	14
+30 mins.	52	242	44	338	61	47	22	130	39	153	63	255	2	12	6	20
+45 mins.	58	283	43	384	71	47	20	138	46	149	93	288	3	11	5	19
Total Volume	251	1141	183	1575	246	190	102	538	155	902	294	1351	10	34	25	69
% App. Total	15.9	72.4	11.6		45.7	35.3	19		11.5	66.8	21.8		14.5	49.3	36.2	
PHF	.756	.908	.832	.895	.866	.950	.773	.961	.842	.723	.790	.834	.833	.708	.694	.863

City of Irvine
 N/S: Red Hill Avenue
 E/W: Alton Parkway
 Weather: Clear

File Name : 100_IRV_Red Hill_Alton PM
 Site Code : 20220171
 Start Date : 3/12/2020
 Page No : 1

Groups Printed- Total Volume

Start Time	Red Hill Avenue Southbound				Alton Parkway Westbound				Red Hill Avenue Northbound				Alton Parkway Eastbound				Int. Total
	Left	Thru	Right	App. Total	Left	Thru	Right	App. Total	Left	Thru	Right	App. Total	Left	Thru	Right	App. Total	
04:00 PM	23	132	1	156	99	18	64	181	6	282	42	330	21	41	36	98	765
04:15 PM	34	117	5	156	72	18	40	130	7	331	44	382	19	42	41	102	770
04:30 PM	31	128	1	160	128	21	60	209	5	367	61	433	25	68	34	127	929
04:45 PM	30	138	0	168	81	22	58	161	6	358	40	404	28	73	36	137	870
Total	118	515	7	640	380	79	222	681	24	1338	187	1549	93	224	147	464	3334
05:00 PM	36	131	0	167	139	19	97	255	4	345	63	412	46	105	50	201	1035
05:15 PM	27	131	3	161	85	12	52	149	12	429	53	494	33	78	46	157	961
05:30 PM	29	123	0	152	110	20	66	196	4	406	47	457	19	60	33	112	917
05:45 PM	36	114	2	152	88	24	55	167	4	316	73	393	25	55	28	108	820
Total	128	499	5	632	422	75	270	767	24	1496	236	1756	123	298	157	578	3733
Grand Total	246	1014	12	1272	802	154	492	1448	48	2834	423	3305	216	522	304	1042	7067
Apprch %	19.3	79.7	0.9		55.4	10.6	34		1.5	85.7	12.8		20.7	50.1	29.2		
Total %	3.5	14.3	0.2	18	11.3	2.2	7	20.5	0.7	40.1	6	46.8	3.1	7.4	4.3	14.7	

Start Time	Red Hill Avenue Southbound				Alton Parkway Westbound				Red Hill Avenue Northbound				Alton Parkway Eastbound				Int. Total
	Left	Thru	Right	App. Total	Left	Thru	Right	App. Total	Left	Thru	Right	App. Total	Left	Thru	Right	App. Total	
Peak Hour Analysis From 04:00 PM to 05:45 PM - Peak 1 of 1																	
Peak Hour for Entire Intersection Begins at 04:30 PM																	
04:30 PM	31	128	1	160	128	21	60	209	5	367	61	433	25	68	34	127	929
04:45 PM	30	138	0	168	81	22	58	161	6	358	40	404	28	73	36	137	870
05:00 PM	36	131	0	167	139	19	97	255	4	345	63	412	46	105	50	201	1035
05:15 PM	27	131	3	161	85	12	52	149	12	429	53	494	33	78	46	157	961
Total Volume	124	528	4	656	433	74	267	774	27	1499	217	1743	132	324	166	622	3795
% App. Total	18.9	80.5	0.6		55.9	9.6	34.5		1.5	86	12.4		21.2	52.1	26.7		
PHF	.861	.957	.333	.976	.779	.841	.688	.759	.563	.874	.861	.882	.717	.771	.830	.774	.917

City of Irvine
 N/S: Red Hill Avenue
 E/W: Alton Parkway
 Weather: Clear

File Name : 100_IRV_Red Hill_Alton PM
 Site Code : 20220171
 Start Date : 3/12/2020
 Page No : 2

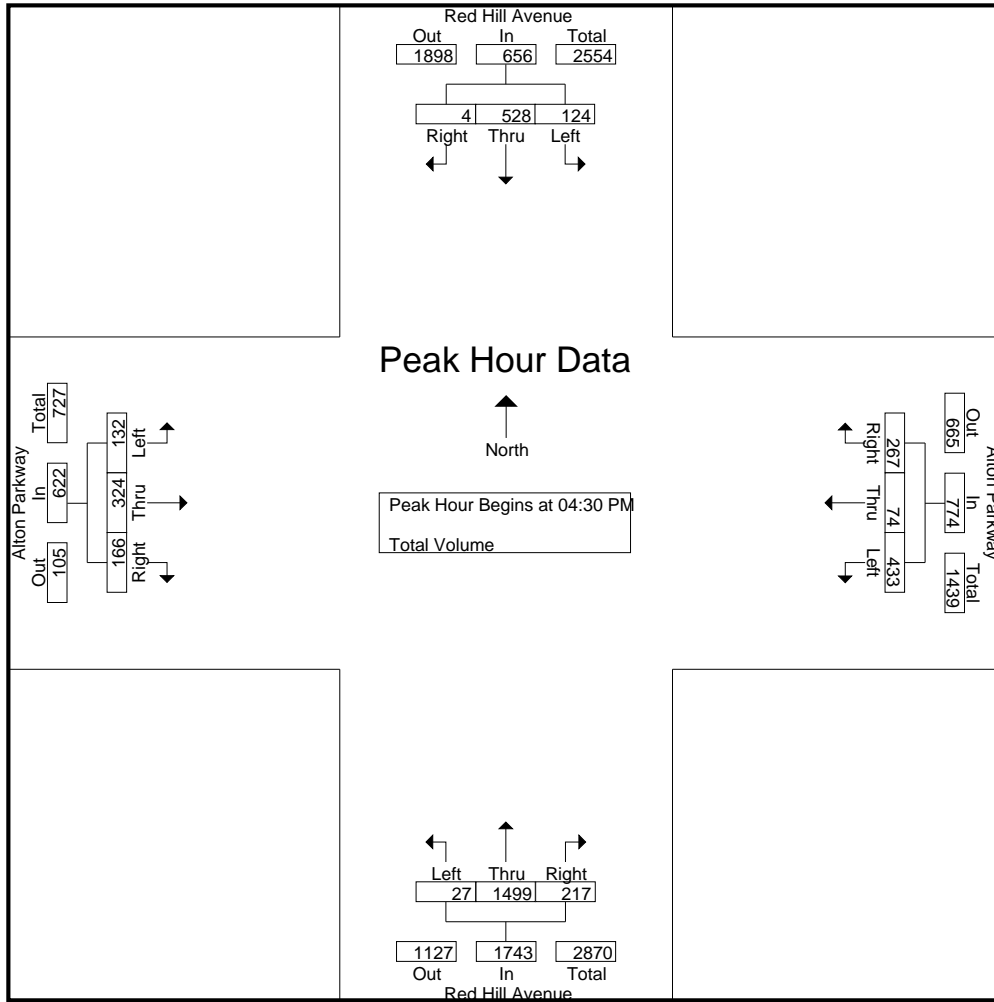

Peak Hour Analysis From 04:00 PM to 05:45 PM - Peak 1 of 1
 Peak Hour for Each Approach Begins at:

	04:30 PM				04:30 PM				04:45 PM				04:30 PM			
+0 mins.	31	128	1	160	128	21	60	209	6	358	40	404	25	68	34	127
+15 mins.	30	138	0	168	81	22	58	161	4	345	63	412	28	73	36	137
+30 mins.	36	131	0	167	139	19	97	255	12	429	53	494	46	105	50	201
+45 mins.	27	131	3	161	85	12	52	149	4	406	47	457	33	78	46	157
Total Volume	124	528	4	656	433	74	267	774	26	1538	203	1767	132	324	166	622
% App. Total	18.9	80.5	0.6		55.9	9.6	34.5		1.5	87	11.5		21.2	52.1	26.7	
PHF	.861	.957	.333	.976	.779	.841	.688	.759	.542	.896	.806	.894	.717	.771	.830	.774

City of Irvine
 N/S: Red Hill Avenue
 E/W: MacArthur Boulevard
 Weather: Clear

File Name : 101_IRV_Red Hill_MacArthur AM
 Site Code : 20220171
 Start Date : 3/12/2020
 Page No : 1

Groups Printed- Total Volume

Start Time	Red Hill Avenue Southbound				MacArthur Boulevard Westbound				Red Hill Avenue Northbound				MacArthur Boulevard Eastbound				Int. Total
	Left	Thru	Right	App. Total	Left	Thru	Right	App. Total	Left	Thru	Right	App. Total	Left	Thru	Right	App. Total	
07:00 AM	21	60	62	143	14	69	251	334	10	89	3	102	350	142	15	507	1086
07:15 AM	40	90	68	198	7	77	228	312	28	137	1	166	271	147	19	437	1113
07:30 AM	58	117	84	259	11	77	172	260	21	122	1	144	295	151	13	459	1122
07:45 AM	37	129	117	283	6	57	187	250	17	156	3	176	331	150	32	513	1222
Total	156	396	331	883	38	280	838	1156	76	504	8	588	1247	590	79	1916	4543
08:00 AM	67	158	119	344	4	52	140	196	14	174	2	190	299	159	22	480	1210
08:15 AM	51	118	127	296	7	59	109	175	16	145	2	163	300	173	22	495	1129
08:30 AM	53	132	129	314	6	55	135	196	17	94	3	114	318	163	30	511	1135
08:45 AM	67	132	133	332	3	88	102	193	16	101	3	120	282	150	24	456	1101
Total	238	540	508	1286	20	254	486	760	63	514	10	587	1199	645	98	1942	4575
Grand Total	394	936	839	2169	58	534	1324	1916	139	1018	18	1175	2446	1235	177	3858	9118
Apprch %	18.2	43.2	38.7		3	27.9	69.1		11.8	86.6	1.5		63.4	32	4.6		
Total %	4.3	10.3	9.2	23.8	0.6	5.9	14.5	21	1.5	11.2	0.2	12.9	26.8	13.5	1.9	42.3	

Start Time	Red Hill Avenue Southbound				MacArthur Boulevard Westbound				Red Hill Avenue Northbound				MacArthur Boulevard Eastbound				Int. Total
	Left	Thru	Right	App. Total	Left	Thru	Right	App. Total	Left	Thru	Right	App. Total	Left	Thru	Right	App. Total	
Peak Hour Analysis From 07:00 AM to 08:45 AM - Peak 1 of 1																	
Peak Hour for Entire Intersection Begins at 07:45 AM																	
07:45 AM	37	129	117	283	6	57	187	250	17	156	3	176	331	150	32	513	1222
08:00 AM	67	158	119	344	4	52	140	196	14	174	2	190	299	159	22	480	1210
08:15 AM	51	118	127	296	7	59	109	175	16	145	2	163	300	173	22	495	1129
08:30 AM	53	132	129	314	6	55	135	196	17	94	3	114	318	163	30	511	1135
Total Volume	208	537	492	1237	23	223	571	817	64	569	10	643	1248	645	106	1999	4696
% App. Total	16.8	43.4	39.8		2.8	27.3	69.9		10	88.5	1.6		62.4	32.3	5.3		
PHF	.776	.850	.953	.899	.821	.945	.763	.817	.941	.818	.833	.846	.943	.932	.828	.974	.961

City of Irvine
 N/S: Red Hill Avenue
 E/W: MacArthur Boulevard
 Weather: Clear

File Name : 101_IRV_Red Hill_MacArthur AM
 Site Code : 20220171
 Start Date : 3/12/2020
 Page No : 2

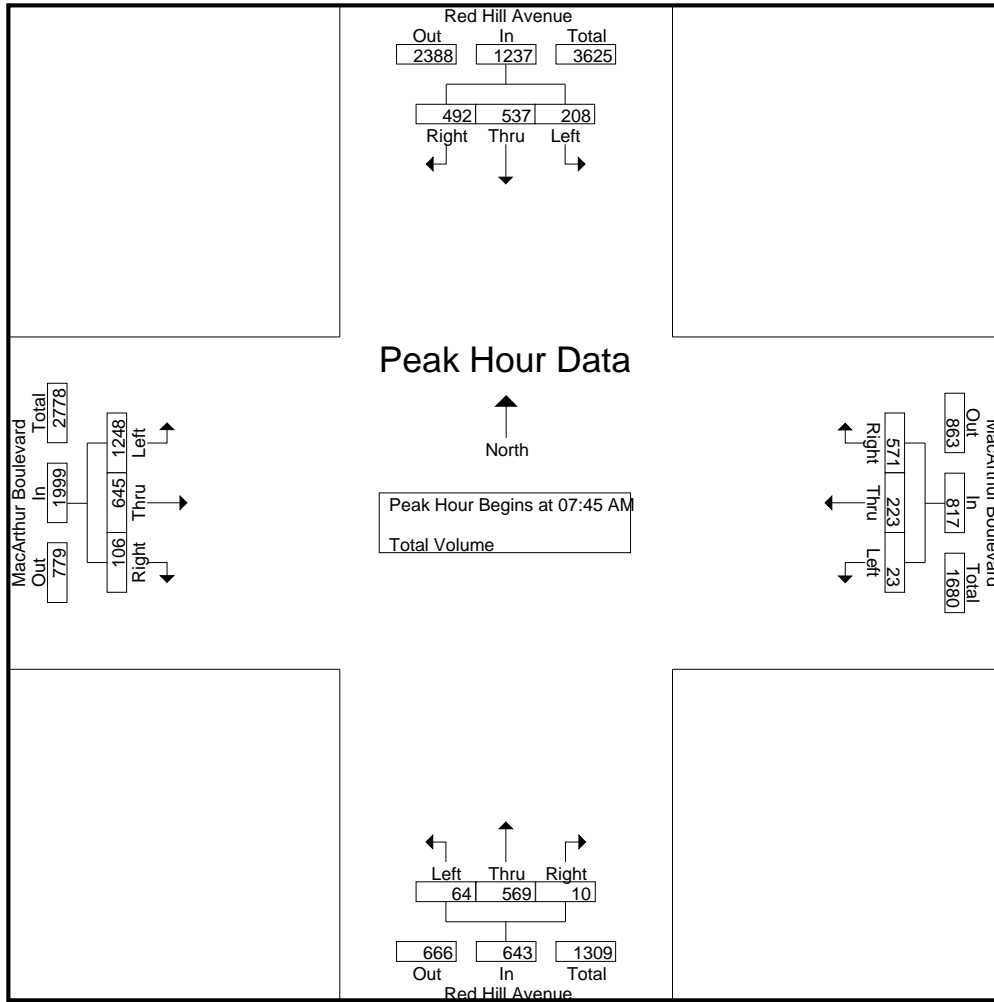

Peak Hour Analysis From 07:00 AM to 08:45 AM - Peak 1 of 1
 Peak Hour for Each Approach Begins at:

	08:00 AM				07:00 AM				07:15 AM				07:45 AM			
+0 mins.	67	158	119	344	14	69	251	334	28	137	1	166	331	150	32	513
+15 mins.	51	118	127	296	7	77	228	312	21	122	1	144	299	159	22	480
+30 mins.	53	132	129	314	11	77	172	260	17	156	3	176	300	173	22	495
+45 mins.	67	132	133	332	6	57	187	250	14	174	2	190	318	163	30	511
Total Volume	238	540	508	1286	38	280	838	1156	80	589	7	676	1248	645	106	1999
% App. Total	18.5	42	39.5		3.3	24.2	72.5		11.8	87.1	1		62.4	32.3	5.3	
PHF	.888	.854	.955	.935	.679	.909	.835	.865	.714	.846	.583	.889	.943	.932	.828	.974

City of Irvine
 N/S: Red Hill Avenue
 E/W: MacArthur Boulevard
 Weather: Clear

File Name : 101_IRV_Red Hill_MacArthur PM
 Site Code : 20220171
 Start Date : 3/12/2020
 Page No : 1

Groups Printed- Total Volume

Start Time	Red Hill Avenue Southbound				MacArthur Boulevard Westbound				Red Hill Avenue Northbound				MacArthur Boulevard Eastbound				Int. Total
	Left	Thru	Right	App. Total	Left	Thru	Right	App. Total	Left	Thru	Right	App. Total	Left	Thru	Right	App. Total	
04:00 PM	49	122	331	502	9	173	97	279	40	184	1	225	129	60	7	196	1202
04:15 PM	68	104	232	404	10	163	90	263	21	168	2	191	124	50	11	185	1043
04:30 PM	57	138	345	540	7	186	101	294	24	172	1	197	153	74	11	238	1269
04:45 PM	72	145	241	458	8	166	116	290	30	190	4	224	139	67	7	213	1185
Total	246	509	1149	1904	34	688	404	1126	115	714	8	837	545	251	36	832	4699
05:00 PM	69	166	308	543	14	231	153	398	34	208	1	243	135	76	13	224	1408
05:15 PM	78	146	254	478	11	248	163	422	27	221	2	250	117	65	12	194	1344
05:30 PM	67	137	239	443	6	173	142	321	34	190	3	227	206	67	10	283	1274
05:45 PM	39	106	193	338	4	216	118	338	22	160	4	186	181	74	10	265	1127
Total	253	555	994	1802	35	868	576	1479	117	779	10	906	639	282	45	966	5153
Grand Total	499	1064	2143	3706	69	1556	980	2605	232	1493	18	1743	1184	533	81	1798	9852
Apprch %	13.5	28.7	57.8		2.6	59.7	37.6		13.3	85.7	1		65.9	29.6	4.5		
Total %	5.1	10.8	21.8	37.6	0.7	15.8	9.9	26.4	2.4	15.2	0.2	17.7	12	5.4	0.8	18.3	

Start Time	Red Hill Avenue Southbound				MacArthur Boulevard Westbound				Red Hill Avenue Northbound				MacArthur Boulevard Eastbound				Int. Total
	Left	Thru	Right	App. Total	Left	Thru	Right	App. Total	Left	Thru	Right	App. Total	Left	Thru	Right	App. Total	
Peak Hour Analysis From 04:00 PM to 05:45 PM - Peak 1 of 1																	
Peak Hour for Entire Intersection Begins at 04:45 PM																	
04:45 PM	72	145	241	458	8	166	116	290	30	190	4	224	139	67	7	213	1185
05:00 PM	69	166	308	543	14	231	153	398	34	208	1	243	135	76	13	224	1408
05:15 PM	78	146	254	478	11	248	163	422	27	221	2	250	117	65	12	194	1344
05:30 PM	67	137	239	443	6	173	142	321	34	190	3	227	206	67	10	283	1274
Total Volume	286	594	1042	1922	39	818	574	1431	125	809	10	944	597	275	42	914	5211
% App. Total	14.9	30.9	54.2		2.7	57.2	40.1		13.2	85.7	1.1		65.3	30.1	4.6		
PHF	.917	.895	.846	.885	.696	.825	.880	.848	.919	.915	.625	.944	.725	.905	.808	.807	.925

City of Irvine
 N/S: Red Hill Avenue
 E/W: MacArthur Boulevard
 Weather: Clear

File Name : 101_IRV_Red Hill_MacArthur PM
 Site Code : 20220171
 Start Date : 3/12/2020
 Page No : 2

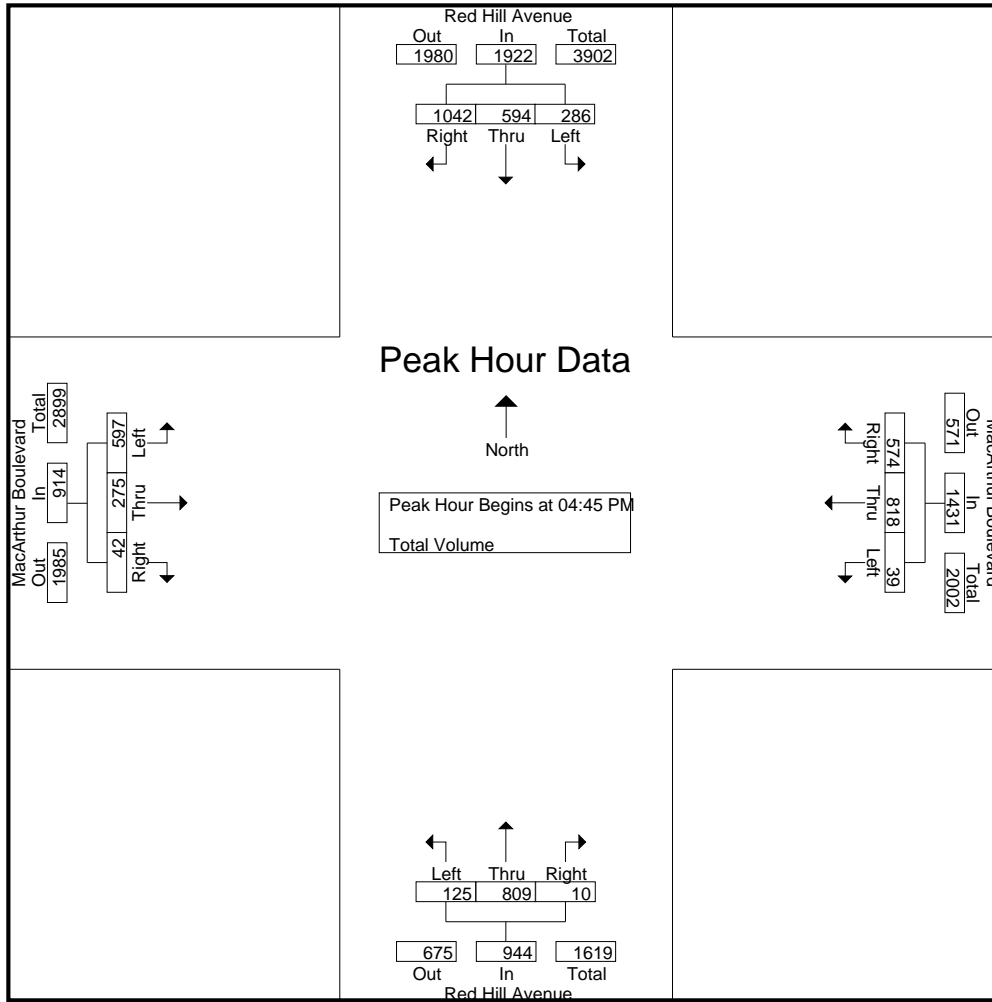

Peak Hour Analysis From 04:00 PM to 05:45 PM - Peak 1 of 1
 Peak Hour for Each Approach Begins at:

	04:30 PM				05:00 PM				04:45 PM				05:00 PM			
+0 mins.	57	138	345	540	14	231	153	398	30	190	4	224	135	76	13	224
+15 mins.	72	145	241	458	11	248	163	422	34	208	1	243	117	65	12	194
+30 mins.	69	166	308	543	6	173	142	321	27	221	2	250	206	67	10	283
+45 mins.	78	146	254	478	4	216	118	338	34	190	3	227	181	74	10	265
Total Volume	276	595	1148	2019	35	868	576	1479	125	809	10	944	639	282	45	966
% App. Total	13.7	29.5	56.9		2.4	58.7	38.9		13.2	85.7	1.1		66.1	29.2	4.7	
PHF	.885	.896	.832	.930	.625	.875	.883	.876	.919	.915	.625	.944	.775	.928	.865	.853

City of Irvine
 N/S: Red Hill Avenue
 E/W: Main Street
 Weather: Clear

File Name : 102_IRV_Red Hill_Main_AM
 Site Code : 20220171
 Start Date : 3/12/2020
 Page No : 1

Groups Printed- Total Volume

Start Time	Red Hill Avenue Southbound				Main Street Westbound				Red Hill Avenue Northbound				Main Street Eastbound				Int. Total
	Left	Thru	Right	App. Total	Left	Thru	Right	App. Total	Left	Thru	Right	App. Total	Left	Thru	Right	App. Total	
07:00 AM	15	44	4	63	18	51	12	81	12	73	46	131	13	157	38	208	483
07:15 AM	11	40	12	63	26	54	19	99	25	113	55	193	25	234	51	310	665
07:30 AM	10	53	20	83	30	60	15	105	30	140	80	250	20	325	53	398	836
07:45 AM	19	76	26	121	41	67	20	128	35	151	82	268	30	374	76	480	997
Total	55	213	62	330	115	232	66	413	102	477	263	842	88	1090	218	1396	2981
08:00 AM	16	86	25	127	37	79	24	140	37	166	97	300	49	358	56	463	1030
08:15 AM	13	71	32	116	48	74	16	138	49	120	92	261	27	306	67	400	915
08:30 AM	19	80	25	124	28	89	13	130	41	119	90	250	33	271	55	359	863
08:45 AM	14	75	37	126	29	77	14	120	38	134	82	254	27	255	61	343	843
Total	62	312	119	493	142	319	67	528	165	539	361	1065	136	1190	239	1565	3651
Grand Total	117	525	181	823	257	551	133	941	267	1016	624	1907	224	2280	457	2961	6632
Apprch %	14.2	63.8	22		27.3	58.6	14.1		14	53.3	32.7		7.6	77	15.4		
Total %	1.8	7.9	2.7	12.4	3.9	8.3	2	14.2	4	15.3	9.4	28.8	3.4	34.4	6.9	44.6	

Start Time	Red Hill Avenue Southbound				Main Street Westbound				Red Hill Avenue Northbound				Main Street Eastbound				Int. Total
	Left	Thru	Right	App. Total	Left	Thru	Right	App. Total	Left	Thru	Right	App. Total	Left	Thru	Right	App. Total	
Peak Hour Analysis From 07:00 AM to 08:45 AM - Peak 1 of 1																	
Peak Hour for Entire Intersection Begins at 07:45 AM																	
07:45 AM	19	76	26	121	41	67	20	128	35	151	82	268	30	374	76	480	997
08:00 AM	16	86	25	127	37	79	24	140	37	166	97	300	49	358	56	463	1030
08:15 AM	13	71	32	116	48	74	16	138	49	120	92	261	27	306	67	400	915
08:30 AM	19	80	25	124	28	89	13	130	41	119	90	250	33	271	55	359	863
Total Volume	67	313	108	488	154	309	73	536	162	556	361	1079	139	1309	254	1702	3805
% App. Total	13.7	64.1	22.1		28.7	57.6	13.6		15	51.5	33.5		8.2	76.9	14.9		
PHF	.882	.910	.844	.961	.802	.868	.760	.957	.827	.837	.930	.899	.709	.875	.836	.886	.924

City of Irvine
 N/S: Red Hill Avenue
 E/W: Main Street
 Weather: Clear

File Name : 102_IRV_Red Hill_Main_AM
 Site Code : 20220171
 Start Date : 3/12/2020
 Page No : 2

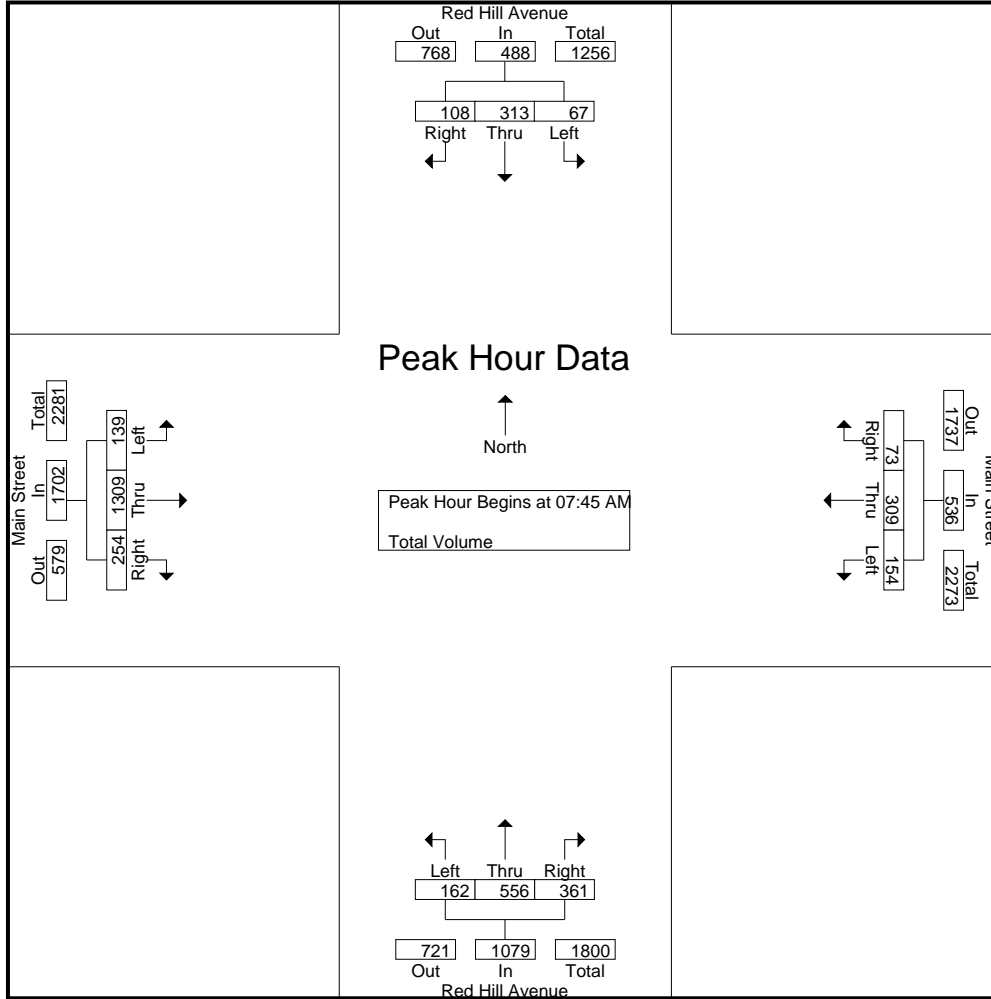

Peak Hour Analysis From 07:00 AM to 08:45 AM - Peak 1 of 1
 Peak Hour for Each Approach Begins at:

	08:00 AM				07:45 AM				07:30 AM				07:30 AM			
+0 mins.	16	86	25	127	41	67	20	128	30	140	80	250	20	325	53	398
+15 mins.	13	71	32	116	37	79	24	140	35	151	82	268	30	374	76	480
+30 mins.	19	80	25	124	48	74	16	138	37	166	97	300	49	358	56	463
+45 mins.	14	75	37	126	28	89	13	130	49	120	92	261	27	306	67	400
Total Volume	62	312	119	493	154	309	73	536	151	577	351	1079	126	1363	252	1741
% App. Total	12.6	63.3	24.1		28.7	57.6	13.6		14	53.5	32.5		7.2	78.3	14.5	
PHF	.816	.907	.804	.970	.802	.868	.760	.957	.770	.869	.905	.899	.643	.911	.829	.907

City of Irvine
 N/S: Red Hill Avenue
 E/W: Main Street
 Weather: Clear

File Name : 102_IRV_Red Hill_Main_PM
 Site Code : 20220171
 Start Date : 3/12/2020
 Page No : 1

Groups Printed- Total Volume

Start Time	Red Hill Avenue Southbound				Main Street Westbound				Red Hill Avenue Northbound				Main Street Eastbound				Int. Total
	Left	Thru	Right	App. Total	Left	Thru	Right	App. Total	Left	Thru	Right	App. Total	Left	Thru	Right	App. Total	
04:00 PM	12	88	33	133	58	294	20	372	56	164	57	277	26	141	27	194	976
04:15 PM	23	90	47	160	53	364	17	434	81	220	45	346	39	126	26	191	1131
04:30 PM	26	124	53	203	60	267	16	343	91	236	60	387	44	138	46	228	1161
04:45 PM	26	133	61	220	63	362	27	452	85	232	62	379	45	136	37	218	1269
Total	87	435	194	716	234	1287	80	1601	313	852	224	1389	154	541	136	831	4537
05:00 PM	22	135	75	232	81	382	18	481	93	238	75	406	49	145	42	236	1355
05:15 PM	24	133	86	243	74	468	22	564	109	243	63	415	55	183	53	291	1513
05:30 PM	13	142	71	226	58	377	24	459	118	223	51	392	44	206	45	295	1372
05:45 PM	15	128	60	203	66	362	25	453	96	193	53	342	50	171	51	272	1270
Total	74	538	292	904	279	1589	89	1957	416	897	242	1555	198	705	191	1094	5510
Grand Total	161	973	486	1620	513	2876	169	3558	729	1749	466	2944	352	1246	327	1925	10047
Apprch %	9.9	60.1	30		14.4	80.8	4.7		24.8	59.4	15.8		18.3	64.7	17		
Total %	1.6	9.7	4.8	16.1	5.1	28.6	1.7	35.4	7.3	17.4	4.6	29.3	3.5	12.4	3.3	19.2	

Start Time	Red Hill Avenue Southbound				Main Street Westbound				Red Hill Avenue Northbound				Main Street Eastbound				Int. Total
	Left	Thru	Right	App. Total	Left	Thru	Right	App. Total	Left	Thru	Right	App. Total	Left	Thru	Right	App. Total	
Peak Hour Analysis From 04:00 PM to 05:45 PM - Peak 1 of 1																	
Peak Hour for Entire Intersection Begins at 05:00 PM																	
05:00 PM	22	135	75	232	81	382	18	481	93	238	75	406	49	145	42	236	1355
05:15 PM	24	133	86	243	74	468	22	564	109	243	63	415	55	183	53	291	1513
05:30 PM	13	142	71	226	58	377	24	459	118	223	51	392	44	206	45	295	1372
05:45 PM	15	128	60	203	66	362	25	453	96	193	53	342	50	171	51	272	1270
Total Volume	74	538	292	904	279	1589	89	1957	416	897	242	1555	198	705	191	1094	5510
% App. Total	8.2	59.5	32.3		14.3	81.2	4.5		26.8	57.7	15.6		18.1	64.4	17.5		
PHF	.771	.947	.849	.930	.861	.849	.890	.867	.881	.923	.807	.937	.900	.856	.901	.927	.910

City of Irvine
 N/S: Red Hill Avenue
 E/W: Main Street
 Weather: Clear

File Name : 102_IRV_Red Hill_Main_PM
 Site Code : 20220171
 Start Date : 3/12/2020
 Page No : 2

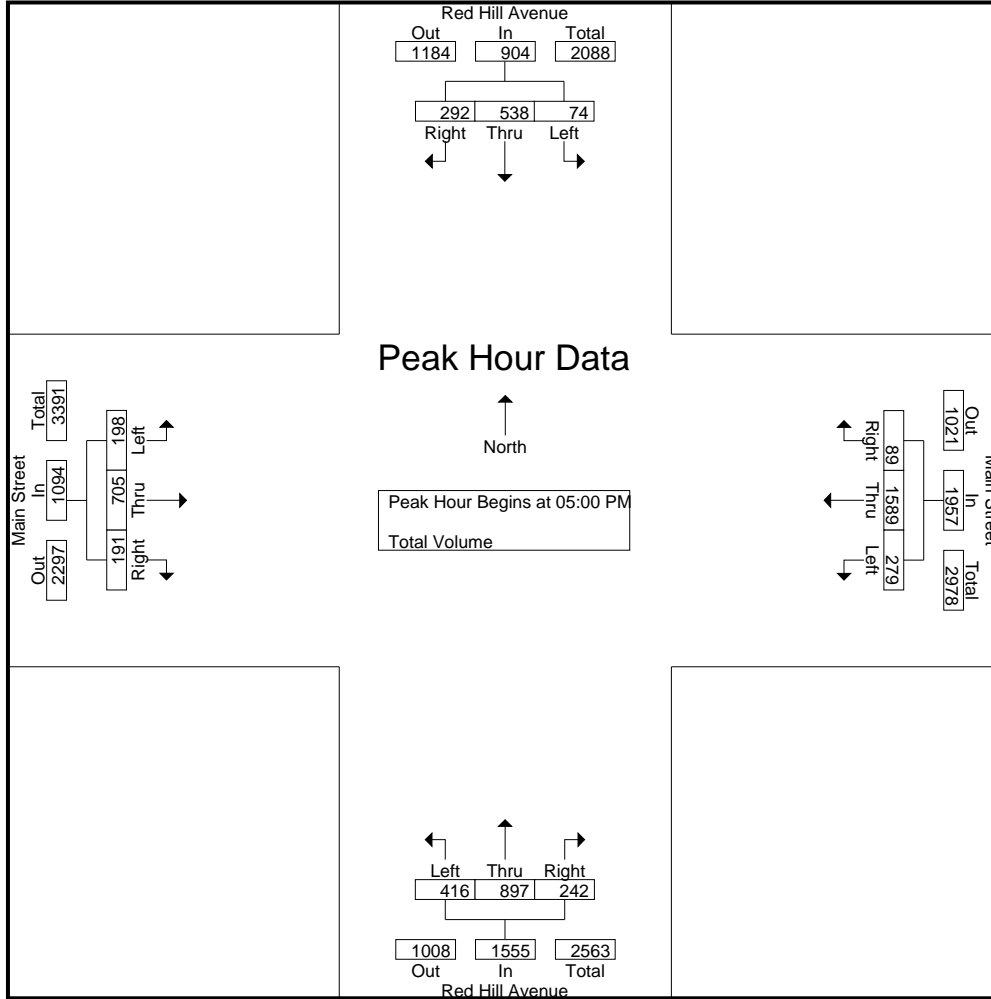

Peak Hour Analysis From 04:00 PM to 05:45 PM - Peak 1 of 1
 Peak Hour for Each Approach Begins at:

	04:45 PM				05:00 PM				04:45 PM				05:00 PM			
+0 mins.	26	133	61	220	81	382	18	481	85	232	62	379	49	145	42	236
+15 mins.	22	135	75	232	74	468	22	564	93	238	75	406	55	183	53	291
+30 mins.	24	133	86	243	58	377	24	459	109	243	63	415	44	206	45	295
+45 mins.	13	142	71	226	66	362	25	453	118	223	51	392	50	171	51	272
Total Volume	85	543	293	921	279	1589	89	1957	405	936	251	1592	198	705	191	1094
% App. Total	9.2	59	31.8		14.3	81.2	4.5		25.4	58.8	15.8		18.1	64.4	17.5	
PHF	.817	.956	.852	.948	.861	.849	.890	.867	.858	.963	.837	.959	.900	.856	.901	.927

City of Tustin
 N/S: Tustin Ranch Road
 E/W: Warner Avenue
 Weather: Clear

File Name : 104_TUS_Tustin Ranch_Warner AM
 Site Code : 20220171
 Start Date : 3/12/2020
 Page No : 1

Groups Printed- Total Volume

Start Time	Tustin Ranch Road Southbound			Tustin Ranch Road Northbound			Warner Avenue Eastbound			Int. Total
	Thru	Right	App. Total	Left	Thru	App. Total	Left	Right	App. Total	
07:00 AM	140	44	184	2	46	48	57	6	63	295
07:15 AM	285	70	355	1	43	44	59	6	65	464
07:30 AM	308	80	388	4	56	60	80	5	85	533
07:45 AM	443	116	559	2	49	51	67	12	79	689
Total	1176	310	1486	9	194	203	263	29	292	1981
08:00 AM	396	82	478	2	58	60	83	14	97	635
08:15 AM	453	106	559	9	66	75	57	1	58	692
08:30 AM	425	91	516	5	65	70	58	6	64	650
08:45 AM	389	99	488	1	74	75	52	4	56	619
Total	1663	378	2041	17	263	280	250	25	275	2596
Grand Total	2839	688	3527	26	457	483	513	54	567	4577
Apprch %	80.5	19.5		5.4	94.6		90.5	9.5		
Total %	62	15	77.1	0.6	10	10.6	11.2	1.2	12.4	

Start Time	Tustin Ranch Road Southbound			Tustin Ranch Road Northbound			Warner Avenue Eastbound			Int. Total
	Thru	Right	App. Total	Left	Thru	App. Total	Left	Right	App. Total	
07:45 AM	443	116	559	2	49	51	67	12	79	689
08:00 AM	396	82	478	2	58	60	83	14	97	635
08:15 AM	453	106	559	9	66	75	57	1	58	692
08:30 AM	425	91	516	5	65	70	58	6	64	650
Total Volume	1717	395	2112	18	238	256	265	33	298	2666
% App. Total	81.3	18.7		7	93		88.9	11.1		
PHF	.948	.851	.945	.500	.902	.853	.798	.589	.768	.963

Peak Hour Analysis From 07:00 AM to 08:45 AM - Peak 1 of 1
 Peak Hour for Entire Intersection Begins at 07:45 AM

City of Tustin
 N/S: Tustin Ranch Road
 E/W: Warner Avenue
 Weather: Clear

File Name : 104_TUS_Tustin Ranch_Warner AM
 Site Code : 20220171
 Start Date : 3/12/2020
 Page No : 2

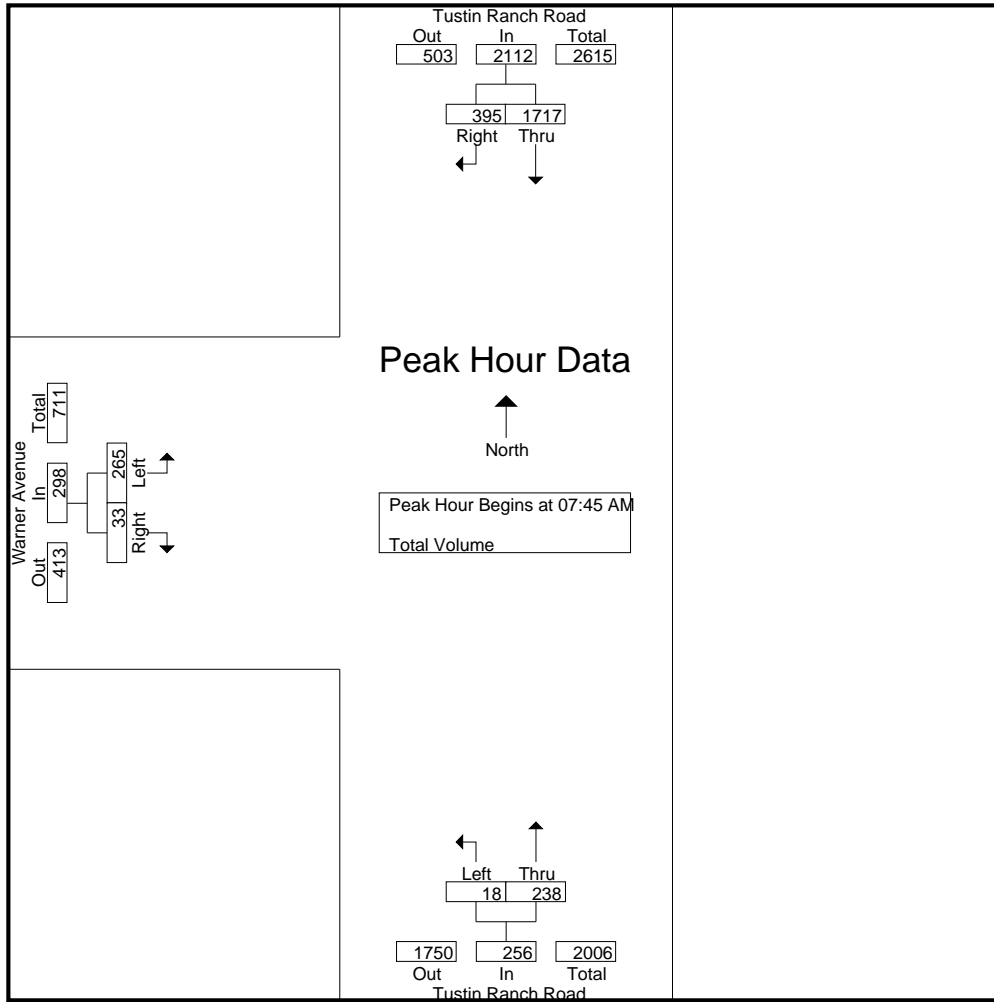

Peak Hour Analysis From 07:00 AM to 08:45 AM - Peak 1 of 1
 Peak Hour for Each Approach Begins at:

	07:45 AM			08:00 AM			07:15 AM		
+0 mins.	443	116	559	2	58	60	59	6	65
+15 mins.	396	82	478	9	66	75	80	5	85
+30 mins.	453	106	559	5	65	70	67	12	79
+45 mins.	425	91	516	1	74	75	83	14	97
Total Volume	1717	395	2112	17	263	280	289	37	326
% App. Total	81.3	18.7		6.1	93.9		88.7	11.3	
PHF	.948	.851	.945	.472	.889	.933	.870	.661	.840

City of Tustin
 N/S: Tustin Ranch Road
 E/W: Warner Avenue
 Weather: Clear

File Name : 104_TUS_Tustin Ranch_Warner PM
 Site Code : 20220171
 Start Date : 3/12/2020
 Page No : 1

Groups Printed- Total Volume

Start Time	Tustin Ranch Road Southbound			Tustin Ranch Road Northbound			Warner Avenue Eastbound			Int. Total
	Thru	Right	App. Total	Left	Thru	App. Total	Left	Right	App. Total	
04:00 PM	99	49	148	11	351	362	100	7	107	617
04:15 PM	104	52	156	10	369	379	107	10	117	652
04:30 PM	117	55	172	18	376	394	106	9	115	681
04:45 PM	121	50	171	8	401	409	135	10	145	725
Total	441	206	647	47	1497	1544	448	36	484	2675
05:00 PM	141	63	204	19	466	485	166	12	178	867
05:15 PM	145	67	212	15	450	465	178	16	194	871
05:30 PM	141	56	197	12	478	490	174	7	181	868
05:45 PM	113	49	162	11	384	395	141	11	152	709
Total	540	235	775	57	1778	1835	659	46	705	3315
Grand Total	981	441	1422	104	3275	3379	1107	82	1189	5990
Apprch %	69	31		3.1	96.9		93.1	6.9		
Total %	16.4	7.4	23.7	1.7	54.7	56.4	18.5	1.4	19.8	

Start Time	Tustin Ranch Road Southbound			Tustin Ranch Road Northbound			Warner Avenue Eastbound			Int. Total
	Thru	Right	App. Total	Left	Thru	App. Total	Left	Right	App. Total	
04:45 PM	121	50	171	8	401	409	135	10	145	725
05:00 PM	141	63	204	19	466	485	166	12	178	867
05:15 PM	145	67	212	15	450	465	178	16	194	871
05:30 PM	141	56	197	12	478	490	174	7	181	868
Total Volume	548	236	784	54	1795	1849	653	45	698	3331
% App. Total	69.9	30.1		2.9	97.1		93.6	6.4		
PHF	.945	.881	.925	.711	.939	.943	.917	.703	.899	.956

Peak Hour Analysis From 04:00 PM to 05:45 PM - Peak 1 of 1
 Peak Hour for Entire Intersection Begins at 04:45 PM

City of Tustin
 N/S: Tustin Ranch Road
 E/W: Warner Avenue
 Weather: Clear

File Name : 104_TUS_Tustin Ranch_Warner PM
 Site Code : 20220171
 Start Date : 3/12/2020
 Page No : 2

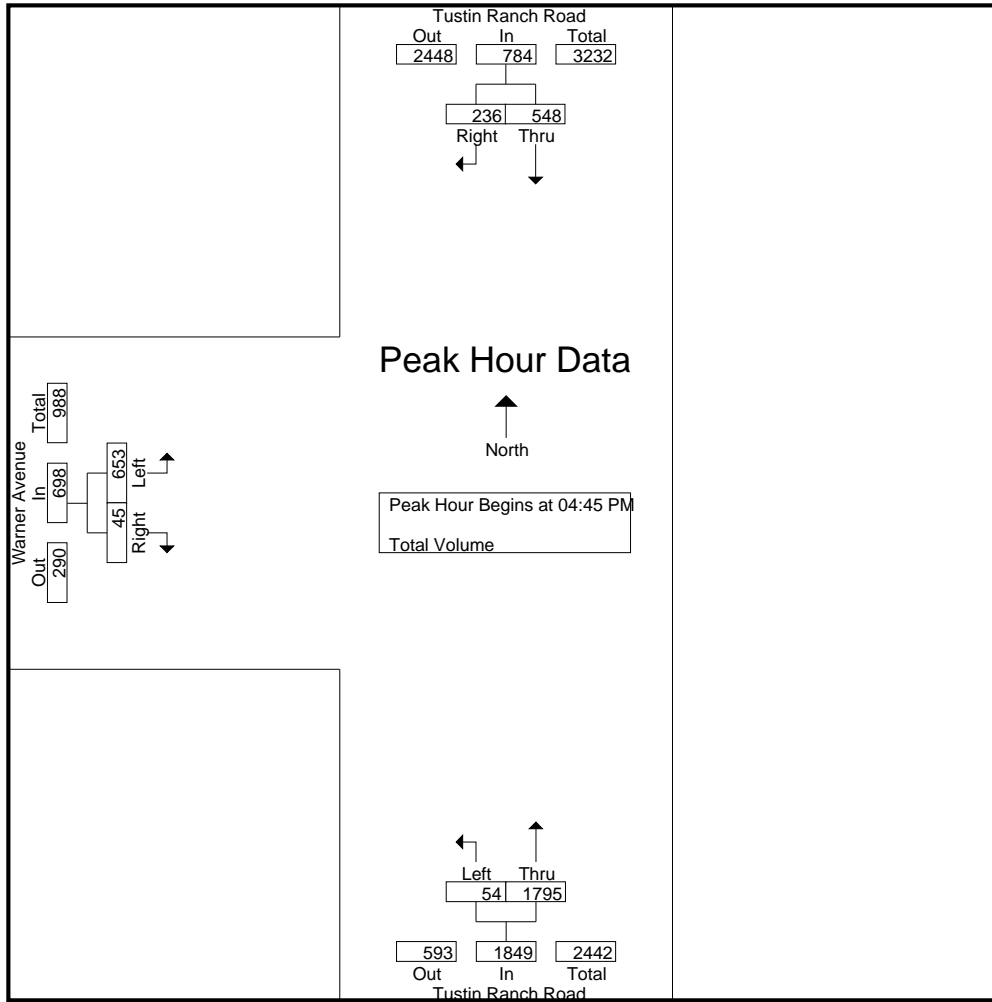

Peak Hour Analysis From 04:00 PM to 05:45 PM - Peak 1 of 1
 Peak Hour for Each Approach Begins at:

	04:45 PM			04:45 PM			05:00 PM		
+0 mins.	121	50	171	8	401	409	166	12	178
+15 mins.	141	63	204	19	466	485	178	16	194
+30 mins.	145	67	212	15	450	465	174	7	181
+45 mins.	141	56	197	12	478	490	141	11	152
Total Volume	548	236	784	54	1795	1849	659	46	705
% App. Total	69.9	30.1		2.9	97.1		93.5	6.5	
PHF	.945	.881	.925	.711	.939	.943	.926	.719	.909

City of Irvine
 N/S: Tustin Ranch Rd/Von Karman Ave
 E/W: Barranca Parkway
 Weather: Clear

File Name : 105_IRV_Von Karman_Barranca AM
 Site Code : 20220171
 Start Date : 3/12/2020
 Page No : 1

Groups Printed- Total Volume

Start Time	Tustin Ranch Road Southbound				Barranca Parkway Westbound				Von Karman Avenue Northbound				Barranca Parkway Eastbound				Int. Total
	Left	Thru	Right	App. Total	Left	Thru	Right	App. Total	Left	Thru	Right	App. Total	Left	Thru	Right	App. Total	
07:00 AM	5	117	38	160	81	170	11	262	17	26	17	60	17	103	35	155	637
07:15 AM	13	212	80	305	134	202	11	347	22	19	9	50	19	119	37	175	877
07:30 AM	38	258	99	395	140	264	13	417	26	29	18	73	25	101	45	171	1056
07:45 AM	30	280	118	428	186	361	8	555	21	29	16	66	30	120	51	201	1250
Total	86	867	335	1288	541	997	43	1581	86	103	60	249	91	443	168	702	3820
08:00 AM	23	301	119	443	175	290	12	477	24	36	28	88	38	115	31	184	1192
08:15 AM	44	294	141	479	192	312	10	514	34	36	22	92	32	127	35	194	1279
08:30 AM	22	289	131	442	216	300	9	525	28	41	19	88	30	126	46	202	1257
08:45 AM	30	269	134	433	156	291	17	464	28	44	23	95	49	90	44	183	1175
Total	119	1153	525	1797	739	1193	48	1980	114	157	92	363	149	458	156	763	4903
Grand Total	205	2020	860	3085	1280	2190	91	3561	200	260	152	612	240	901	324	1465	8723
Apprch %	6.6	65.5	27.9		35.9	61.5	2.6		32.7	42.5	24.8		16.4	61.5	22.1		
Total %	2.4	23.2	9.9	35.4	14.7	25.1	1	40.8	2.3	3	1.7	7	2.8	10.3	3.7	16.8	

Start Time	Tustin Ranch Road Southbound				Barranca Parkway Westbound				Von Karman Avenue Northbound				Barranca Parkway Eastbound				Int. Total
	Left	Thru	Right	App. Total	Left	Thru	Right	App. Total	Left	Thru	Right	App. Total	Left	Thru	Right	App. Total	
Peak Hour Analysis From 07:00 AM to 08:45 AM - Peak 1 of 1																	
Peak Hour for Entire Intersection Begins at 07:45 AM																	
07:45 AM	30	280	118	428	186	361	8	555	21	29	16	66	30	120	51	201	1250
08:00 AM	23	301	119	443	175	290	12	477	24	36	28	88	38	115	31	184	1192
08:15 AM	44	294	141	479	192	312	10	514	34	36	22	92	32	127	35	194	1279
08:30 AM	22	289	131	442	216	300	9	525	28	41	19	88	30	126	46	202	1257
Total Volume	119	1164	509	1792	769	1263	39	2071	107	142	85	334	130	488	163	781	4978
% App. Total	6.6	65	28.4		37.1	61	1.9		32	42.5	25.4		16.6	62.5	20.9		
PHF	.676	.967	.902	.935	.890	.875	.813	.933	.787	.866	.759	.908	.855	.961	.799	.967	.973

City of Irvine
 N/S: Tustin Ranch Rd/Von Karman Ave
 E/W: Barranca Parkway
 Weather: Clear

File Name : 105_IRV_Von Karman_Barranca AM
 Site Code : 20220171
 Start Date : 3/12/2020
 Page No : 2

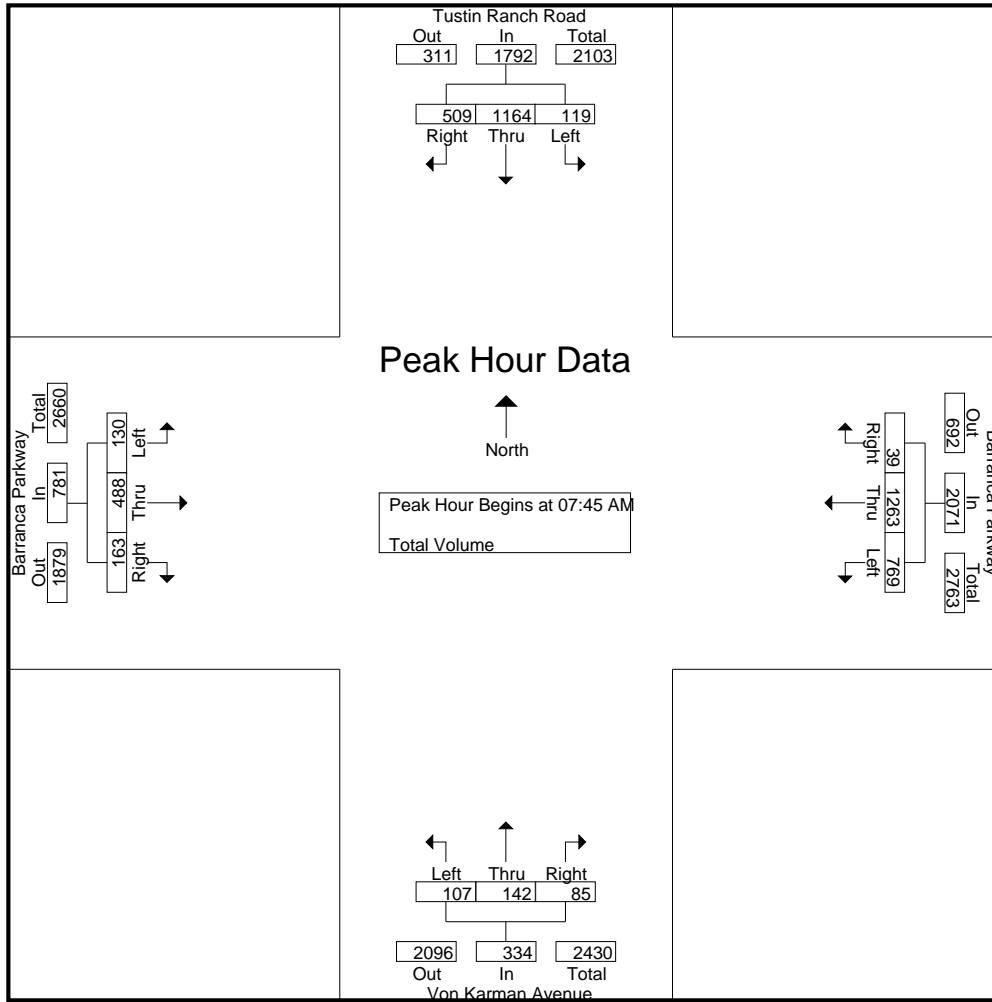

Peak Hour Analysis From 07:00 AM to 08:45 AM - Peak 1 of 1
 Peak Hour for Each Approach Begins at:

	08:00 AM				07:45 AM				08:00 AM				07:45 AM			
+0 mins.	23	301	119	443	186	361	8	555	24	36	28	88	30	120	51	201
+15 mins.	44	294	141	479	175	290	12	477	34	36	22	92	38	115	31	184
+30 mins.	22	289	131	442	192	312	10	514	28	41	19	88	32	127	35	194
+45 mins.	30	269	134	433	216	300	9	525	28	44	23	95	30	126	46	202
Total Volume	119	1153	525	1797	769	1263	39	2071	114	157	92	363	130	488	163	781
% App. Total	6.6	64.2	29.2		37.1	61	1.9		31.4	43.3	25.3		16.6	62.5	20.9	
PHF	.676	.958	.931	.938	.890	.875	.813	.933	.838	.892	.821	.955	.855	.961	.799	.967

City of Irvine
 N/S: Tustin Ranch Rd/Von Karman Ave
 E/W: Barranca Parkway
 Weather: Clear

File Name : 105_IRV_Von Karman_Barranca PM
 Site Code : 20220171
 Start Date : 3/12/2020
 Page No : 1

Groups Printed- Total Volume

Start Time	Tustin Ranch Road Southbound				Barranca Parkway Westbound				Von Karman Avenue Northbound				Barranca Parkway Eastbound				Int. Total
	Left	Thru	Right	App. Total	Left	Thru	Right	App. Total	Left	Thru	Right	App. Total	Left	Thru	Right	App. Total	
04:00 PM	13	71	53	137	67	171	56	294	71	229	53	353	85	197	19	301	1085
04:15 PM	9	77	62	148	36	125	41	202	38	277	63	378	137	214	27	378	1106
04:30 PM	14	59	48	121	53	157	59	269	83	257	68	408	99	207	23	329	1127
04:45 PM	14	88	59	161	37	149	47	233	48	328	78	454	119	221	30	370	1218
Total	50	295	222	567	193	602	203	998	240	1091	262	1593	440	839	99	1378	4536
05:00 PM	17	74	51	142	53	168	58	279	71	311	81	463	123	284	29	436	1320
05:15 PM	16	103	64	183	54	136	53	243	43	332	64	439	168	285	50	503	1368
05:30 PM	20	78	62	160	60	193	62	315	62	319	58	439	150	233	34	417	1331
05:45 PM	15	96	55	166	56	147	41	244	47	294	50	391	115	243	33	391	1192
Total	68	351	232	651	223	644	214	1081	223	1256	253	1732	556	1045	146	1747	5211
Grand Total	118	646	454	1218	416	1246	417	2079	463	2347	515	3325	996	1884	245	3125	9747
Apprch %	9.7	53	37.3		20	59.9	20.1		13.9	70.6	15.5		31.9	60.3	7.8		
Total %	1.2	6.6	4.7	12.5	4.3	12.8	4.3	21.3	4.8	24.1	5.3	34.1	10.2	19.3	2.5	32.1	

Start Time	Tustin Ranch Road Southbound				Barranca Parkway Westbound				Von Karman Avenue Northbound				Barranca Parkway Eastbound				Int. Total
	Left	Thru	Right	App. Total	Left	Thru	Right	App. Total	Left	Thru	Right	App. Total	Left	Thru	Right	App. Total	
Peak Hour Analysis From 04:00 PM to 05:45 PM - Peak 1 of 1																	
Peak Hour for Entire Intersection Begins at 04:45 PM																	
04:45 PM	14	88	59	161	37	149	47	233	48	328	78	454	119	221	30	370	1218
05:00 PM	17	74	51	142	53	168	58	279	71	311	81	463	123	284	29	436	1320
05:15 PM	16	103	64	183	54	136	53	243	43	332	64	439	168	285	50	503	1368
05:30 PM	20	78	62	160	60	193	62	315	62	319	58	439	150	233	34	417	1331
Total Volume	67	343	236	646	204	646	220	1070	224	1290	281	1795	560	1023	143	1726	5237
% App. Total	10.4	53.1	36.5		19.1	60.4	20.6		12.5	71.9	15.7		32.4	59.3	8.3		
PHF	.838	.833	.922	.883	.850	.837	.887	.849	.789	.971	.867	.969	.833	.897	.715	.858	.957

City of Irvine
 N/S: Tustin Ranch Rd/Von Karman Ave
 E/W: Barranca Parkway
 Weather: Clear

File Name : 105_IRV_Von Karman_Barranca PM
 Site Code : 20220171
 Start Date : 3/12/2020
 Page No : 2

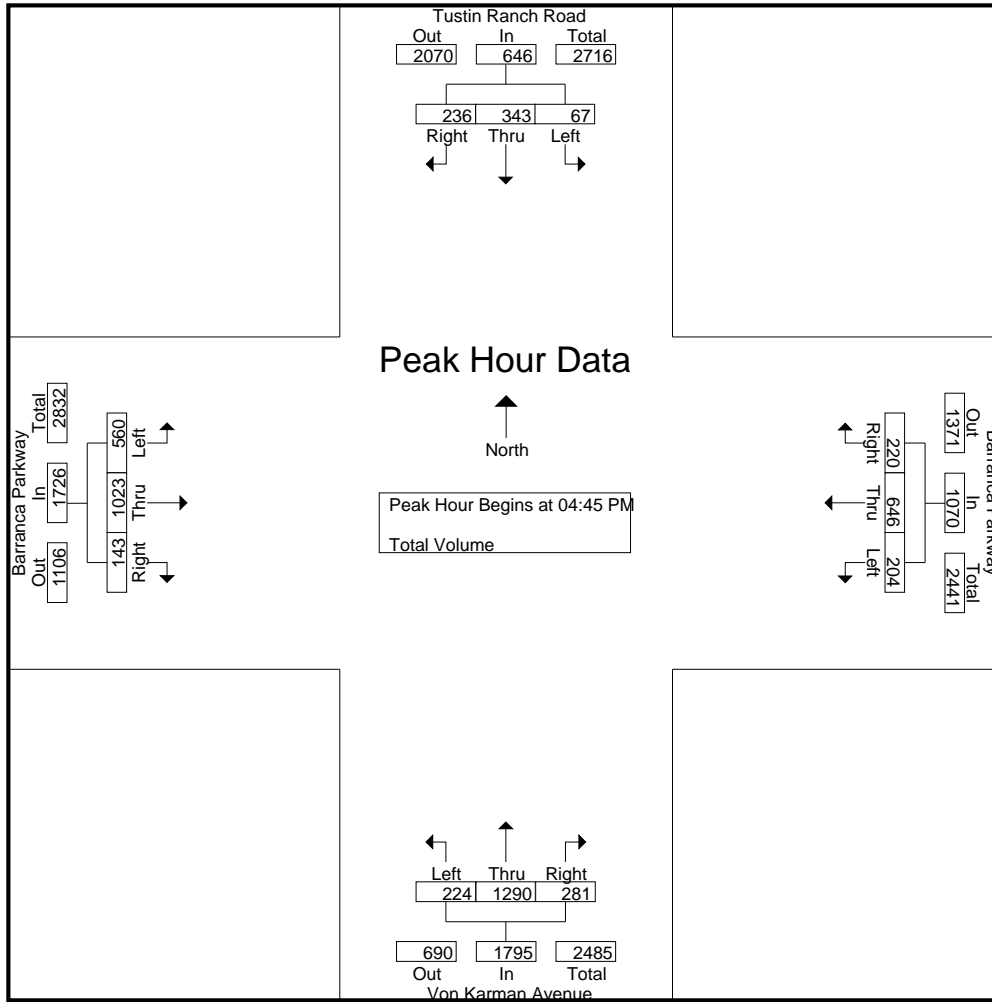

Peak Hour Analysis From 04:00 PM to 05:45 PM - Peak 1 of 1
 Peak Hour for Each Approach Begins at:

	05:00 PM				05:00 PM				04:45 PM				05:00 PM			
+0 mins.	17	74	51	142	53	168	58	279	48	328	78	454	123	284	29	436
+15 mins.	16	103	64	183	54	136	53	243	71	311	81	463	168	285	50	503
+30 mins.	20	78	62	160	60	193	62	315	43	332	64	439	150	233	34	417
+45 mins.	15	96	55	166	56	147	41	244	62	319	58	439	115	243	33	391
Total Volume	68	351	232	651	223	644	214	1081	224	1290	281	1795	556	1045	146	1747
% App. Total	10.4	53.9	35.6		20.6	59.6	19.8		12.5	71.9	15.7		31.8	59.8	8.4	
PHF	.850	.852	.906	.889	.929	.834	.863	.858	.789	.971	.867	.969	.827	.917	.730	.868

INTERSECTION TURNING MOVEMENT COUNTS

PREPARED BY: AimTD LLC. tel: 714 253 7888 cs@aimtd.com

DATE: Tue, May 21, 19 LOCATION: Tustin PROJECT #: SC2143
 NORTH & SOUTH: Red Hill LOCATION #: 7
 EAST & WEST: El Camino Real CONTROL: SIGNAL

NOTES: Queue AM SB, PM NB/SB

LANES:	NORTHBOUND			SOUTHBOUND			EASTBOUND			WESTBOUND			TOTAL
	NL	NT	NR	SL	ST	SR	EL	ET	ER	WL	WT	WR	

U-TURNS				
NB	SB	EB	WB	TTL

AM	7:00 AM	55	107	23	4	208	10	16	20	43	54	18	1	559	0	1	0	0	1
	7:15 AM	85	195	51	1	287	20	15	30	44	67	32	2	829	0	0	0	0	0
	7:30 AM	108	203	98	8	294	30	29	50	40	70	83	2	1,015	0	1	0	0	1
	7:45 AM	70	197	69	5	388	11	17	46	45	69	70	5	992	2	0	0	0	2
	8:00 AM	39	182	32	3	321	18	7	28	33	62	34	6	765	0	0	0	0	0
	8:15 AM	47	135	29	5	313	15	7	26	43	56	31	2	709	0	0	0	0	0
	8:30 AM	43	126	11	4	269	8	5	17	41	47	19	2	592	0	0	0	0	0
	8:45 AM	52	123	20	4	220	15	5	15	38	37	24	2	555	0	0	0	0	0
	VOLUMES	499	1,268	333	34	2,300	127	101	232	327	462	311	22	6,016	2	2	0	0	4
	APPROACH %	24%	60%	16%	1%	93%	5%	15%	35%	50%	58%	39%	3%						
APP/DEPART	2,100	/	1,393	2,461	/	3,091	660	/	597	795	/	935	0						
BEGIN PEAK HR	7:15 AM																		
VOLUMES	302	777	250	17	1,290	79	68	154	162	268	219	15	3,601						
APPROACH %	23%	58%	19%	1%	93%	6%	18%	40%	42%	53%	44%	3%							
PEAK HR FACTOR	0.812			0.858				0.807	0.810										
APP/DEPART	1,329	/	861	1,386	/	1,722	384	/	420	502	/	598	0	4	3	0	0	7	
PM	4:00 PM	77	251	66	2	149	29	17	37	51	71	72	10	832	0	1	0	0	1
	4:15 PM	66	277	53	7	174	22	14	26	45	57	92	2	835	0	1	0	0	1
	4:30 PM	98	281	52	5	173	34	17	31	39	40	91	10	871	1	0	0	0	1
	4:45 PM	79	292	54	4	155	28	19	23	42	50	100	7	853	0	0	0	0	0
	5:00 PM	93	299	59	8	169	14	13	37	50	46	91	12	891	1	0	0	0	1
	5:15 PM	99	327	52	5	207	29	25	34	50	56	69	7	960	1	0	0	0	1
	5:30 PM	107	337	65	2	178	17	14	45	52	45	82	10	954	0	1	0	0	1
	5:45 PM	111	338	63	4	166	35	17	35	47	50	83	8	957	1	0	0	0	1
	VOLUMES	730	2,402	464	37	1,371	208	136	268	376	415	680	66	7,153	4	3	0	0	7
	APPROACH %	20%	67%	13%	2%	85%	13%	17%	34%	48%	36%	59%	6%						
APP/DEPART	3,596	/	2,607	1,616	/	2,166	780	/	766	1,161	/	1,614	0						
BEGIN PEAK HR	5:00 PM																		
VOLUMES	410	1,301	239	19	720	95	69	151	199	197	325	37	3,762						
APPROACH %	21%	67%	12%	2%	86%	11%	16%	36%	47%	35%	58%	7%							
PEAK HR FACTOR	0.952			0.865				0.944	0.938										
APP/DEPART	1,950	/	1,408	834	/	1,119	419	/	408	559	/	827	0						

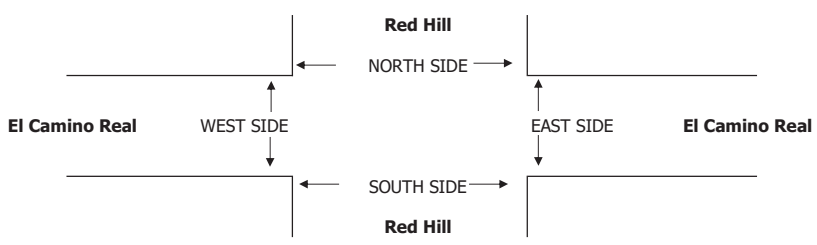

AM	7:00 AM	3	0	7	6	16
	7:15 AM	29	0	35	13	77
	7:30 AM	67	0	30	25	122
	7:45 AM	16	0	7	6	29
	8:00 AM	6	0	2	3	11
	8:15 AM	1	0	2	2	5
	8:30 AM	7	0	2	3	12
	8:45 AM	3	0	2	3	8
	TOTAL	132	0	87	61	280
	AM BEGIN PEAK HR	7:15 AM				
PM	4:00 PM	21	0	16	4	41
	4:15 PM	14	0	14	12	40
	4:30 PM	12	0	10	9	31
	4:45 PM	6	0	4	9	19
	5:00 PM	6	0	4	7	17
	5:15 PM	12	0	8	1	21
	5:30 PM	13	0	6	7	26
	5:45 PM	4	0	8	5	17
	TOTAL	88	0	70	54	212
	PM BEGIN PEAK HR	5:00 PM				

PEDESTRIAN + BIKE CROSSINGS				
N SIDE	S SIDE	E SIDE	W SIDE	TOTAL
3	0	7	6	16
29	0	35	13	77
67	0	30	25	122
16	0	7	6	29
6	0	2	3	11
1	0	2	2	5
7	0	2	3	12
3	0	2	3	8
132	0	87	61	280
21	0	16	4	41
14	0	14	12	40
12	0	10	9	31
6	0	4	9	19
6	0	4	7	17
12	0	8	1	21
13	0	6	7	26
4	0	8	5	17
88	0	70	54	212

PEDESTRIAN CROSSINGS				
N SIDE	S SIDE	E SIDE	W SIDE	TOTAL
3	0	7	4	14
29	0	34	13	76
64	0	30	24	118
16	0	7	6	29
5	0	2	2	9
1	0	1	1	3
7	0	2	3	12
2	0	1	2	5
127	0	84	55	266
114	0	73	45	232
18	0	16	4	38
14	0	13	12	39
10	0	10	8	28
4	0	4	8	16
4	0	4	5	13
10	0	8	1	19
13	0	6	7	26
1	0	5	3	9
74	0	66	48	188
28	0	23	16	67

BICYCLE CROSSINGS				
NS	SS	ES	WS	TOTAL
0	0	0	2	2
0	0	1	0	1
3	0	0	1	4
0	0	0	0	0
1	0	0	1	2
0	0	1	1	2
0	0	0	0	0
1	0	1	1	3
5	0	3	6	14
3	0	0	0	3
0	0	1	0	1
2	0	0	1	3
2	0	0	1	3
2	0	0	2	4
2	0	0	0	2
0	0	0	0	0
3	0	3	2	8
14	0	4	6	24

INTERSECTION TURNING MOVEMENT COUNTS

PREPARED BY: AimTD LLC. tel: 714 253 7888 cs@aimtd.com

T218

DATE: Tue, May 21, 19	LOCATION: NORTH & SOUTH: EAST & WEST:	Tustin Red Hill I-5 NB Ramps	PROJECT #: SC2143 LOCATION #: 6 CONTROL: SIGNAL
---------------------------------	--	---	--

NOTES: Queue AM NB, PM NB/SB	AM PM MD OTHER OTHER	◀ W S ▶	▲ N E ▶	▼
-------------------------------------	----------------------------------	---------------	------------	---

Add U-Turns to Left Turns

LANES:	NORTHBOUND Red Hill			SOUTHBOUND Red Hill			EASTBOUND I-5 NB Ramps			WESTBOUND I-5 NB Ramps			TOTAL
	NL 1	NT 3	NR X	SL X	ST 3	SR 1	EL X	ET X	ER X	WL 1.5	WT 0.5	WR 1	
7:00 AM	47	118	0	0	193	112	0	0	0	49	0	59	578
7:15 AM	71	267	0	0	266	124	0	0	0	59	0	74	861
7:30 AM	73	351	0	0	315	94	0	0	0	57	0	58	948
7:45 AM	91	273	0	0	359	144	0	0	0	66	0	64	997
8:00 AM	88	182	0	0	310	108	0	0	0	43	0	62	793
8:15 AM	63	127	0	0	290	117	0	0	0	50	0	79	726
8:30 AM	65	117	0	0	260	94	0	0	0	77	1	76	690
8:45 AM	49	104	0	0	221	86	0	0	0	83	1	94	638
VOLUMES	547	1,539	0	0	2,214	879	0	0	0	484	2	566	6,231
APPROACH %	26%	74%	0%	0%	72%	28%	0%	0%	0%	46%	0%	54%	
APP/DEPART	2,086	/	2,105	3,093	/	2,698	0	/	0	1,052	/	1,428	0
BEGIN PEAK HR	7:15 AM												
VOLUMES	323	1,073	0	0	1,250	470	0	0	0	225	0	258	3,599
APPROACH %	23%	77%	0%	0%	73%	27%	0%	0%	0%	47%	0%	53%	
PEAK HR FACTOR	0.823			0.855			0.000			0.908			0.902
APP/DEPART	1,396	/	1,331	1,720	/	1,475	0	/	0	483	/	793	0
4:00 PM	75	321	0	0	209	67	0	0	0	59	11	53	795
4:15 PM	101	329	0	0	214	64	0	0	0	42	11	58	819
4:30 PM	68	342	0	0	192	58	0	0	0	58	19	107	844
4:45 PM	85	354	0	0	198	50	0	0	0	35	25	85	832
5:00 PM	69	368	0	0	219	48	0	0	0	57	21	85	867
5:15 PM	73	378	0	0	253	48	0	0	0	65	30	98	945
5:30 PM	60	409	0	0	244	46	0	0	0	65	25	113	962
5:45 PM	67	386	0	0	213	46	0	0	0	66	19	114	911
VOLUMES	598	2,887	0	0	1,742	427	0	0	0	447	161	713	6,975
APPROACH %	17%	83%	0%	0%	80%	20%	0%	0%	0%	34%	12%	54%	
APP/DEPART	3,485	/	3,600	2,169	/	2,189	0	/	0	1,321	/	1,186	0
BEGIN PEAK HR	5:00 PM												
VOLUMES	269	1,541	0	0	929	188	0	0	0	253	95	410	3,685
APPROACH %	15%	85%	0%	0%	83%	17%	0%	0%	0%	33%	13%	54%	
PEAK HR FACTOR	0.965			0.928			0.000			0.933			0.958
APP/DEPART	1,810	/	1,951	1,117	/	1,182	0	/	0	758	/	552	0

U-TURNS				
NB	SB	EB	WB	TTL
0	0	0	0	0
0	0	0	0	0
0	0	0	0	0
0	0	0	0	0
0	0	0	0	0
0	0	0	0	0
0	0	0	0	0
0	0	0	0	0
0	0	0	0	0
0	0	0	0	0
0	0	0	0	0
0	0	0	0	0

0	0	0	0	0
0	0	0	0	0
0	0	0	0	0
0	0	0	0	0
0	0	0	0	0
0	0	0	0	0
0	0	0	0	0
0	0	0	0	0
0	0	0	0	0
0	0	0	0	0

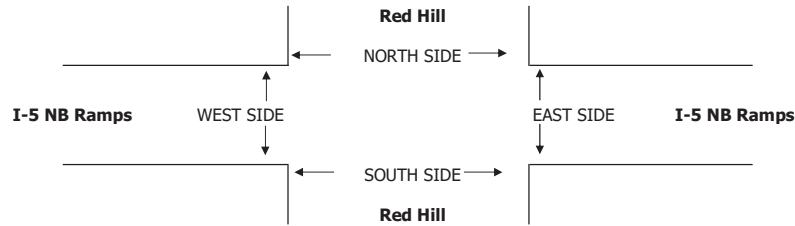

TIME	N SIDE	S SIDE	E SIDE	W SIDE	TOTAL
7:00 AM	0	0	10	4	14
7:15 AM	0	0	33	3	36
7:30 AM	0	0	29	24	53
7:45 AM	0	0	7	6	13
8:00 AM	0	0	3	5	8
8:15 AM	0	0	4	1	5
8:30 AM	0	0	5	0	5
8:45 AM	0	0	2	3	5
TOTAL	0	0	93	46	139
AM BEGIN PEAK HR	7:15 AM				
4:00 PM	0	0	16	3	19
4:15 PM	0	0	10	14	24
4:30 PM	0	0	6	1	7
4:45 PM	0	0	7	5	12
5:00 PM	0	0	5	12	17
5:15 PM	0	0	4	3	7
5:30 PM	0	0	3	4	7
5:45 PM	0	0	10	3	13
TOTAL	0	0	61	45	106
PM BEGIN PEAK HR	5:00 PM				

PEDESTRIAN + BIKE CROSSINGS				
N SIDE	S SIDE	E SIDE	W SIDE	TOTAL
0	0	10	4	14
0	0	33	3	36
0	0	29	24	53
0	0	7	6	13
0	0	3	5	8
0	0	4	1	5
0	0	5	0	5
0	0	2	3	5
0	0	93	46	139
0	0	65	35	100
0	0	15	3	18
0	0	9	14	23
0	0	6	0	6
0	0	7	3	10
0	0	5	9	14
0	0	4	3	7
0	0	3	4	7
0	0	6	1	7
0	0	55	37	92
0	0	18	17	35

PEDESTRIAN CROSSINGS				
N SIDE	S SIDE	E SIDE	W SIDE	TOTAL
0	0	10	3	13
0	0	29	3	32
0	0	26	23	49
0	0	7	6	13
0	0	3	3	6
0	0	2	0	2
0	0	4	0	4
0	0	1	2	3
0	0	82	40	122
0	0	65	35	100
0	0	15	3	18
0	0	9	14	23
0	0	6	0	6
0	0	7	3	10
0	0	5	9	14
0	0	4	3	7
0	0	3	4	7
0	0	6	1	7
0	0	55	37	92
0	0	18	17	35

BICYCLE CROSSINGS				
NS	SS	ES	WS	TOTAL
0	0	0	1	1
0	0	4	0	4
0	0	3	1	4
0	0	0	0	0
0	0	0	2	2
0	0	2	1	3
0	0	1	0	1
0	0	1	1	2
0	0	11	6	17
0	0	1	0	1
0	0	1	0	1
0	0	0	1	1
0	0	0	2	2
0	0	0	3	3
0	0	0	0	0
0	0	0	0	0
0	0	4	2	6
0	0	6	8	14

INTERSECTION TURNING MOVEMENT COUNTS

PREPARED BY: AimTD LLC. tel: 714 253 7888 cs@aimtd.com

DATE: Tue, May 21, 19	LOCATION: NORTH & SOUTH: EAST & WEST:	Tustin Red Hill I-5 SB Ramps	PROJECT #: LOCATION #: CONTROL:	SC2143 5 SIGNAL
--------------------------	---	------------------------------------	---------------------------------------	-----------------------

NOTES: Queue AM WB/EB, PM EB.

AM		▲	
PM		N	
MD	◀	W	▶
OTHER		S	
OTHER		▼	

Add U-Turns to Left Turns

LANES:	NORTHBOUND			SOUTHBOUND			EASTBOUND			WESTBOUND			TOTAL
	Red Hill			Red Hill			I-5 SB Ramps			I-5 SB Ramps			
	NL	NT	NR	SL	ST	SR	EL	ET	ER	WL	WT	WR	
7:00 AM	0	136	124	81	161	0	29	0	53	0	0	0	584
7:15 AM	0	305	137	89	236	0	33	0	59	0	0	0	859
7:30 AM	0	378	133	101	271	0	46	0	81	0	0	0	1,010
7:45 AM	0	314	154	99	326	0	50	1	90	0	0	0	1,034
8:00 AM	0	233	120	92	261	0	37	2	75	0	0	0	820
8:15 AM	0	160	105	91	249	0	31	1	57	0	0	0	694
8:30 AM	0	155	92	103	234	0	27	0	62	0	0	0	673
8:45 AM	0	127	105	87	217	0	26	0	72	0	0	0	634
VOLUMES	0	1,808	970	743	1,955	0	279	4	549	0	0	0	6,308
APPROACH %	0%	65%	35%	28%	72%	0%	34%	0%	66%	0%	0%	0%	
APP/DEPART	2,778	/	2,087	2,698	/	2,504	832	/	1,717	0	/	0	0
BEGIN PEAK HR	7:15 AM												
VOLUMES	0	1,230	544	381	1,094	0	166	3	305	0	0	0	3,723
APPROACH %	0%	69%	31%	26%	74%	0%	35%	1%	64%	0%	0%	0%	
PEAK HR FACTOR		0.868			0.868			0.840			0.000		0.900
APP/DEPART	1,774	/	1,396	1,475	/	1,399	474	/	928	0	/	0	0
4:00 PM	0	324	127	75	193	0	69	1	63	0	0	0	852
4:15 PM	0	357	105	89	167	0	73	0	66	0	0	0	857
4:30 PM	0	335	94	77	173	0	75	0	76	0	0	0	830
4:45 PM	0	372	119	72	161	0	67	0	69	0	0	0	860
5:00 PM	0	367	125	82	194	0	70	1	62	0	0	0	901
5:15 PM	0	370	113	103	218	0	81	0	69	0	0	0	954
5:30 PM	0	387	119	89	220	0	82	1	78	0	0	0	976
5:45 PM	0	381	121	74	205	0	72	0	65	0	0	0	918
VOLUMES	0	2,893	923	661	1,531	0	589	3	548	0	0	0	7,148
APPROACH %	0%	76%	24%	30%	70%	0%	52%	0%	48%	0%	0%	0%	
APP/DEPART	3,816	/	3,482	2,192	/	2,079	1,140	/	1,587	0	/	0	0
BEGIN PEAK HR	5:00 PM												
VOLUMES	0	1,505	478	348	837	0	305	2	274	0	0	0	3,749
APPROACH %	0%	76%	24%	29%	71%	0%	52%	0%	47%	0%	0%	0%	
PEAK HR FACTOR		0.980			0.923			0.902			0.000		0.960
APP/DEPART	1,983	/	1,810	1,185	/	1,111	581	/	828	0	/	0	0

U-TURNS				
NB	SB	EB	WB	TTL
0	0	0	0	0
0	0	0	0	0
0	0	0	0	0
0	0	0	0	0
0	0	0	0	0
0	0	0	0	0
0	0	0	0	0
0	0	0	0	0
0	0	0	0	0
0	0	0	0	0

0	0	0	0	0
0	0	0	0	0
0	0	0	0	0
0	0	0	0	0
0	0	0	0	0
0	0	0	0	0
0	0	0	0	0
0	0	0	0	0
0	0	0	0	0
0	0	0	0	0

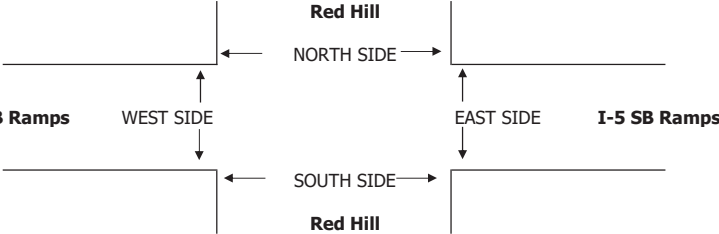

AM	PEDESTRIAN + BIKE CROSSINGS				
	N SIDE	S SIDE	E SIDE	W SIDE	TOTAL
7:00 AM	0	0	17	4	21
7:15 AM	0	0	33	3	36
7:30 AM	0	0	26	25	51
7:45 AM	0	0	7	4	11
8:00 AM	0	0	1	4	5
8:15 AM	0	0	5	2	7
8:30 AM	0	0	5	0	5
8:45 AM	0	0	2	3	5
TOTAL	0	0	96	45	141
AM BEGIN PEAK HR	7:15 AM				
4:00 PM	0	0	14	3	17
4:15 PM	0	0	6	9	15
4:30 PM	0	0	7	2	9
4:45 PM	0	0	8	6	14
5:00 PM	0	0	5	7	12
5:15 PM	0	0	6	6	12
5:30 PM	0	0	3	4	7
5:45 PM	0	0	11	3	14
TOTAL	0	0	60	40	100
PM BEGIN PEAK HR	5:00 PM				

PM	PEDESTRIAN CROSSINGS				
	N SIDE	S SIDE	E SIDE	W SIDE	TOTAL
7:00 AM	0	0	17	3	20
7:15 AM	0	0	30	3	33
7:30 AM	0	0	25	24	49
7:45 AM	0	0	7	4	11
8:00 AM	0	0	1	3	4
8:15 AM	0	0	3	0	3
8:30 AM	0	0	3	0	3
8:45 AM	0	0	0	2	2
TOTAL	0	0	86	39	125
AM BEGIN PEAK HR	7:15 AM				
4:00 PM	0	0	12	3	15
4:15 PM	0	0	5	9	14
4:30 PM	0	0	7	1	8
4:45 PM	0	0	8	4	12
5:00 PM	0	0	3	5	8
5:15 PM	0	0	5	6	11
5:30 PM	0	0	3	4	7
5:45 PM	0	0	7	0	7
TOTAL	0	0	50	32	82
PM BEGIN PEAK HR	5:00 PM				

BICYCLE CROSSINGS	PEDESTRIAN CROSSINGS				
	N SIDE	S SIDE	E SIDE	W SIDE	TOTAL
7:00 AM	0	0	0	1	1
7:15 AM	0	0	3	0	3
7:30 AM	0	0	1	1	2
7:45 AM	0	0	0	0	0
8:00 AM	0	0	0	1	1
8:15 AM	0	0	2	2	4
8:30 AM	0	0	2	0	2
8:45 AM	0	0	2	1	3
TOTAL	0	0	10	6	16
AM BEGIN PEAK HR	7:15 AM				
4:00 PM	0	0	2	0	2
4:15 PM	0	0	1	0	1
4:30 PM	0	0	0	1	1
4:45 PM	0	0	0	2	2
5:00 PM	0	0	2	2	4
5:15 PM	0	0	1	0	1
5:30 PM	0	0	0	0	0
5:45 PM	0	0	4	3	7
TOTAL	0	0	10	8	18
PM BEGIN PEAK HR	5:00 PM				

TOTAL	PEDESTRIAN CROSSINGS				
	N SIDE	S SIDE	E SIDE	W SIDE	TOTAL
7:00 AM	0	0	18	15	33

INTERSECTION TURNING MOVEMENT COUNTS

PREPARED BY: AimTD LLC. tel: 714 253 7888 cs@aimtd.com

DATE:
Tue, May 21, 19

LOCATION:
NORTH & SOUTH:
EAST & WEST:

Tustin
Red Hill
Nisson

PROJECT #: SC2143
LOCATION #: 4
CONTROL: SIGNAL

NOTES:

Queue AM/PM NB/SB

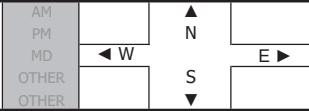

Add U-Turns to Left Turns

LANES:	NORTHBOUND Red Hill			SOUTHBOUND Red Hill			EASTBOUND Nisson			WESTBOUND Nisson			TOTAL
	NL	NT	NR	SL	ST	SR	EL	ET	ER	WL	WT	WR	

U-TURNS				
NB	SB	EB	WB	TTL

AM	7:00 AM	1	191	3	13	182	10	41	5	5	9	5	35	500	0	0	0	0	0	
	7:15 AM	2	329	4	29	250	19	61	14	11	11	6	51	787	0	0	0	0	0	
	7:30 AM	5	387	5	35	292	22	63	11	8	16	9	55	908	0	0	0	0	0	
	7:45 AM	5	334	7	55	306	53	61	23	14	9	6	54	927	1	0	0	0	1	
	8:00 AM	4	235	7	31	284	24	54	10	14	12	4	52	731	0	0	0	0	0	
	8:15 AM	0	175	1	17	272	13	48	8	4	6	8	35	587	0	0	0	0	0	0
	8:30 AM	6	190	4	21	266	16	37	5	1	9	5	25	585	0	0	0	0	0	0
	8:45 AM	0	157	5	17	253	16	48	6	9	7	2	23	543	0	1	0	0	1	
	VOLUMES	23	1,998	36	218	2,105	173	413	82	66	79	45	330	5,568	1	1	0	0	2	
	APPROACH %	1%	97%	2%	9%	84%	7%	74%	15%	12%	17%	10%	73%							
APP/DEPART	2,057	/	2,742	2,496	/	2,251	561	/	335	454	/	240	0							
BEGIN PEAK HR	7:15 AM																			
VOLUMES	16	1,285	23	150	1,132	118	239	58	47	48	25	212	3,353							
APPROACH %	1%	97%	2%	11%	81%	8%	69%	17%	14%	17%	9%	74%								
PEAK HR FACTOR	0.834			0.845			0.878			0.891			0.904							
APP/DEPART	1,324	/	1,736	1,400	/	1,228	344	/	231	285	/	158	0							
PM	4:00 PM	7	376	8	48	200	20	44	19	4	9	16	26	777	0	0	0	0	0	
	4:15 PM	5	377	6	40	162	22	51	17	4	15	23	31	753	1	2	0	0	3	
	4:30 PM	5	342	5	41	203	15	46	19	4	7	15	36	738	0	0	0	0	0	
	4:45 PM	2	396	7	32	168	16	59	20	6	19	23	28	776	0	2	0	0	2	
	5:00 PM	10	386	4	39	213	17	60	23	8	12	19	38	829	0	0	0	0	0	
	5:15 PM	7	390	11	42	223	21	55	22	4	8	19	39	841	0	0	0	0	0	
	5:30 PM	8	391	8	42	229	27	65	26	14	7	15	33	865	0	0	0	0	0	
	5:45 PM	4	400	8	43	191	21	64	18	13	20	29	29	840	0	0	0	0	0	
	VOLUMES	48	3,058	57	327	1,589	159	444	164	57	97	159	260	6,419	1	4	0	0	5	
	APPROACH %	2%	97%	2%	16%	77%	8%	67%	25%	9%	19%	31%	50%							
APP/DEPART	3,163	/	3,766	2,075	/	1,744	665	/	544	516	/	365	0							
BEGIN PEAK HR	5:00 PM																			
VOLUMES	29	1,567	31	166	856	86	244	89	39	47	82	139	3,375							
APPROACH %	2%	96%	2%	15%	77%	8%	66%	24%	10%	18%	31%	52%								
PEAK HR FACTOR	0.987			0.930			0.886			0.859			0.975							
APP/DEPART	1,627	/	1,950	1,108	/	942	372	/	286	268	/	197	0							

0	0	0	0	0
0	0	0	0	0
0	0	0	0	0
1	0	0	0	1
0	0	0	0	0
0	0	0	0	0
0	0	0	0	0
0	0	0	0	0
0	1	0	0	1
1	1	0	0	2
0	0	0	0	0
1	2	0	0	3
0	0	0	0	0
0	2	0	0	2
0	0	0	0	0
0	0	0	0	0
0	0	0	0	0
0	0	0	0	0
1	4	0	0	5

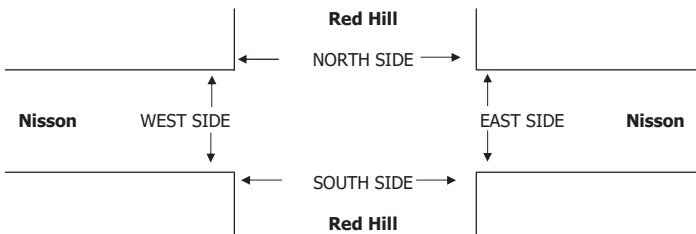

7:00 AM	0	1	6	3	10
7:15 AM	0	5	16	1	22
7:30 AM	0	3	18	1	22
7:45 AM	0	7	4	5	16
8:00 AM	0	0	0	3	3
8:15 AM	0	2	1	2	5
8:30 AM	1	5	3	1	10
8:45 AM	0	2	4	2	8
TOTAL	1	25	52	18	96
AM BEGIN PEAK HR	7:15 AM				
4:00 PM	0	11	10	2	23
4:15 PM	0	7	6	9	22
4:30 PM	0	2	4	1	7
4:45 PM	0	13	9	4	26
5:00 PM	0	3	5	8	16
5:15 PM	0	6	5	6	17
5:30 PM	0	12	2	3	17
5:45 PM	0	22	10	2	34
TOTAL	0	76	51	35	162
PM BEGIN PEAK HR	5:00 PM				

PEDESTRIAN + BIKE CROSSINGS				
N SIDE	S SIDE	E SIDE	W SIDE	TOTAL
0	1	6	3	10
0	5	16	1	22
0	3	18	1	22
0	7	4	5	16
0	0	0	3	3
0	2	1	2	5
1	5	3	1	10
0	2	4	2	8
1	25	52	18	96
7:15 AM				
0	11	10	2	23
0	7	6	9	22
0	2	4	1	7
0	13	9	4	26
0	3	5	8	16
0	6	5	6	17
0	12	2	3	17
0	22	10	2	34
0	76	51	35	162
5:00 PM				

PEDESTRIAN CROSSINGS				
N SIDE	S SIDE	E SIDE	W SIDE	TOTAL
0	1	6	2	9
0	5	13	1	19
0	3	17	1	21
0	6	2	5	13
0	0	0	2	2
0	1	1	0	2
0	4	2	1	7
0	2	4	1	7
0	22	45	13	80
0	14	32	9	55
0	11	9	2	22
0	7	5	9	21
0	2	4	0	6
0	12	9	2	23
0	3	5	5	13
0	4	5	6	15
0	12	2	3	17
0	22	6	0	28
0	73	45	27	145
0	41	18	14	73

BICYCLE CROSSINGS				
NS	SS	ES	WS	TOTAL
0	0	0	1	1
0	0	3	0	3
0	0	1	0	1
0	1	2	0	3
0	0	0	1	1
0	1	0	2	3
1	1	1	0	3
0	0	0	1	1
1	3	7	5	16
0	0	1	0	1
0	0	1	0	1
0	0	0	1	1
0	1	0	2	3
0	0	0	3	3
0	2	0	0	2
0	0	0	0	0
0	0	4	2	6
0	3	6	8	17

INTERSECTION TURNING MOVEMENT COUNTS

PREPARED BY: AimTD LLC. tel: 714 253 7888 cs@aimtd.com

DATE:
Tue, May 21, 19

LOCATION:
NORTH & SOUTH:
EAST & WEST:

Tustin
Red Hill
Walnut

PROJECT #: SC2143
LOCATION #: 2
CONTROL: SIGNAL

NOTES:	AM		▲ N	
	PM	◀ W	E ▶	▼ S
	MD	OTHER	OTHER	OTHER
	OTHER	OTHER	OTHER	OTHER

Add U-Turns to Left Turns

LANES:	NORTHBOUND			SOUTHBOUND			EASTBOUND			WESTBOUND			TOTAL
	NL	NT	NR	SL	ST	SR	EL	ET	ER	WL	WT	WR	
	1	3	0	1	3	0	1	2	0	2	2	0	

U-TURNS				
NB	SB	EB	WB	TTL
0	0	0	0	

AM	7:00 AM	8	89	27	18	159	13	23	75	50	31	38	15	546
	7:15 AM	17	112	14	24	211	22	42	92	92	38	66	30	760
	7:30 AM	27	139	35	23	303	24	44	99	113	57	59	36	959
	7:45 AM	52	156	26	30	261	38	44	127	101	48	69	33	985
	8:00 AM	37	112	23	25	260	31	28	76	82	47	57	20	798
	8:15 AM	12	69	26	25	239	26	24	89	74	43	55	24	706
	8:30 AM	17	110	25	30	236	17	21	83	59	40	46	24	708
	8:45 AM	24	89	15	19	243	13	14	76	56	34	43	24	650
	VOLUMES	194	876	191	194	1,912	184	240	717	627	338	433	206	6,112
	APPROACH %	15%	69%	15%	8%	83%	8%	15%	45%	40%	35%	44%	21%	
APP/DEPART	1,261	/	1,323	2,290	/	2,903	1,584	/	1,101	977	/	785	0	
BEGIN PEAK HR	7:15 AM													
VOLUMES	133	519	98	102	1,035	115	158	394	388	190	251	119	3,502	
APPROACH %	18%	69%	13%	8%	83%	9%	17%	42%	41%	34%	45%	21%		
PEAK HR FACTOR	0.801													
APP/DEPART	750	/	796	1,252	/	1,627	940	/	594	560	/	485	0	
PM	4:00 PM	71	342	26	30	133	24	38	50	30	53	210	33	1,040
	4:15 PM	59	305	27	25	104	27	19	76	21	54	176	38	931
	4:30 PM	82	326	19	30	94	34	32	68	20	42	152	43	942
	4:45 PM	69	338	14	31	89	29	27	74	24	51	162	47	955
	5:00 PM	55	375	20	22	97	41	24	70	30	53	164	39	990
	5:15 PM	67	311	15	39	125	37	26	68	25	53	186	59	1,011
	5:30 PM	87	361	30	37	96	50	28	62	28	55	164	44	1,042
	5:45 PM	75	334	34	36	99	46	32	66	26	41	161	34	984
	VOLUMES	565	2,692	185	250	837	288	226	534	204	402	1,375	337	7,895
	APPROACH %	16%	78%	5%	18%	61%	21%	23%	55%	21%	19%	65%	16%	
APP/DEPART	3,442	/	3,257	1,375	/	1,468	964	/	967	2,114	/	2,203	0	
BEGIN PEAK HR	5:00 PM													
VOLUMES	284	1,381	99	134	417	174	110	266	109	202	675	176	4,027	
APPROACH %	16%	78%	6%	18%	58%	24%	23%	55%	22%	19%	64%	17%		
PEAK HR FACTOR	0.923													
APP/DEPART	1,764	/	1,667	725	/	738	485	/	499	1,053	/	1,123	0	

4	0	0	0	4
2	0	0	0	2
2	0	0	0	2
4	0	0	0	4
6	0	0	0	6
2	0	0	0	2
4	0	0	0	4
2	1	0	0	3
26	1	0	0	27

3	1	0	0	4
2	1	0	0	3
5	0	0	0	5
5	0	0	0	5
3	0	0	0	3
4	0	0	0	4
0	0	0	0	0
3	0	0	0	3
25	2	0	0	27

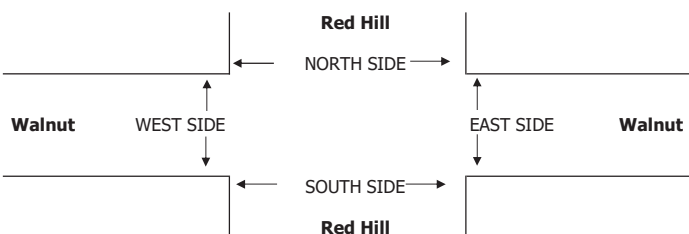

AM	7:00 AM	2	3	0	10	15
	7:15 AM	1	1	1	12	15
	7:30 AM	2	4	4	8	18
	7:45 AM	1	1	1	6	9
	8:00 AM	1	3	2	2	8
	8:15 AM	0	3	4	5	12
	8:30 AM	0	3	1	1	5
	8:45 AM	2	2	0	5	9
	TOTAL	9	20	13	49	91
AM BEGIN PEAK HR	7:15 AM					
PM	4:00 PM	0	3	1	0	4
	4:15 PM	0	4	6	3	13
	4:30 PM	1	9	1	1	12
	4:45 PM	1	4	4	8	17
	5:00 PM	0	4	2	2	8
	5:15 PM	0	2	1	10	13
	5:30 PM	0	4	5	9	18
	5:45 PM	1	5	2	9	17
	TOTAL	3	35	22	42	102
PM BEGIN PEAK HR	5:00 PM					

PEDESTRIAN + BIKE CROSSINGS				
N SIDE	S SIDE	E SIDE	W SIDE	TOTAL
2	3	0	10	15
1	1	1	12	15
2	4	4	8	18
1	1	1	6	9
1	3	2	2	8
0	3	4	5	12
0	3	1	1	5
2	2	0	5	9
9	20	13	49	91
7:15 AM				
0	3	1	0	4
0	4	6	3	13
1	9	1	1	12
1	4	4	8	17
0	4	2	2	8
0	2	1	10	13
0	4	5	9	18
1	5	2	9	17
3	35	22	42	102
5:00 PM				

PEDESTRIAN CROSSINGS				
N SIDE	S SIDE	E SIDE	W SIDE	TOTAL
0	3	0	6	9
1	1	1	11	14
2	4	4	8	18
1	1	1	6	9
1	3	0	2	6
0	1	2	4	7
0	2	0	1	3
2	2	0	3	7
7	17	8	41	73
5	9	6	27	47
0	3	0	0	3
0	3	4	2	9
0	8	1	1	10
1	3	4	7	15
0	3	1	2	6
0	2	0	7	9
0	3	4	5	12
1	4	2	7	14
2	29	16	31	78
1	12	7	21	41

BICYCLE CROSSINGS				
NS	SS	ES	WS	TOTAL
2	0	0	4	6
0	0	0	1	1
0	0	0	0	0
0	0	0	0	0
0	0	2	0	2
0	2	2	1	5
0	1	1	0	2
0	0	1	3	4
0	1	1	4	6
0	1	0	2	3
1	6	6	11	24

INTERSECTION TURNING MOVEMENT COUNTS

PREPARED BY: AimTD LLC. tel: 714 253 7888 cs@aimtd.com

T218

DATE: Tue, Apr 16, 19	LOCATION: NORTH & SOUTH: Tustin EAST & WEST: Red Hill Valencia	PROJECT #: SC2143 LOCATION #: 6 CONTROL: SIGNAL
---------------------------------	--	--

NOTES:	AM PM MD OTHER OTHER	◀ W S ▼	▲ N E ▶	
---------------	----------------------------------	---------------	------------	--

Add U-Turns to Left Turns

LANES:	NORTHBOUND			SOUTHBOUND			EASTBOUND			WESTBOUND			TOTAL
	Red Hill			Red Hill			Valencia			Valencia			
	NL	NT	NR	SL	ST	SR	EL	ET	ER	WL	WT	WR	

U-TURNS				
NB	SB	EB	WB	TTL

AM	7:00 AM	7	50	14	12	169	16	8	14	15	38	72	10	425
	7:15 AM	14	68	10	18	224	12	1	18	13	28	53	14	473
	7:30 AM	17	76	28	29	222	16	4	28	18	48	78	21	585
	7:45 AM	20	86	30	46	262	14	2	46	17	71	95	49	738
	8:00 AM	17	78	22	20	286	14	6	34	14	64	90	32	677
	8:15 AM	22	70	26	36	239	19	5	28	11	63	76	18	613
	8:30 AM	17	87	25	16	234	21	6	29	11	51	81	21	599
	8:45 AM	26	56	24	17	259	24	4	23	14	56	59	19	581
	VOLUMES	140	571	179	194	1,895	136	36	220	113	419	604	184	4,691
	APP/DEPART	890	/	793	2,225	/	2,428	369	/	593	1,207	/	877	0
BEGIN PEAK HR	7:45 AM													
VOLUMES	76	321	103	118	1,021	68	19	137	53	249	342	120	2,627	
APP/DEPART	500	/	462	1,207	/	1,323	209	/	358	711	/	484	0	
APPROACH %	16%	64%	20%	9%	85%	6%	10%	60%	31%	35%	50%	15%		
PEAK HR FACTOR	0.919			0.937			0.804			0.827			0.890	
APP/DEPART	500	/	462	1,207	/	1,323	209	/	358	711	/	484	0	
PM	4:00 PM	47	341	54	17	106	16	11	44	13	33	40	25	747
	4:15 PM	83	378	36	18	106	18	12	31	10	20	50	32	794
	4:30 PM	51	384	44	39	99	18	23	42	28	35	49	32	844
	4:45 PM	35	365	66	29	122	17	16	39	19	20	42	35	805
	5:00 PM	52	425	69	24	105	7	19	78	18	28	36	28	889
	5:15 PM	79	446	88	15	107	6	11	28	17	33	42	16	888
	5:30 PM	56	370	83	17	117	19	13	31	19	32	41	17	815
	5:45 PM	73	407	68	30	108	8	9	27	9	18	53	19	829
	VOLUMES	476	3,116	508	189	870	109	114	320	133	219	353	204	6,611
	APP/DEPART	4,100	/	3,436	1,168	/	1,225	567	/	1,015	776	/	935	0
BEGIN PEAK HR	4:30 PM													
VOLUMES	217	1,620	267	107	433	48	69	187	82	116	169	111	3,426	
APP/DEPART	2,104	/	1,802	588	/	632	338	/	559	396	/	433	0	
APPROACH %	10%	77%	13%	18%	74%	8%	20%	55%	24%	29%	43%	28%		
PEAK HR FACTOR	0.858			0.875			0.735			0.853			0.963	
APP/DEPART	2,104	/	1,802	588	/	632	338	/	559	396	/	433	0	

0	0	0	0	0
1	0	0	0	1
0	0	0	0	0
0	1	0	1	2
1	0	0	0	1
0	1	0	1	2
1	0	0	0	1
0	0	0	0	0
3	2	0	2	7

1	0	0	0	1
0	0	0	0	0
0	1	0	0	1
0	1	0	0	1
0	0	0	0	0
1	0	0	0	1
0	0	0	0	0
1	0	0	0	1
3	2	0	0	5

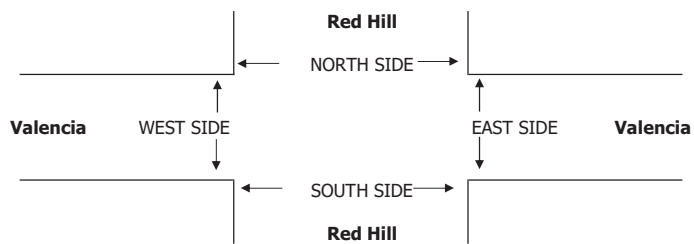

	PEDESTRIAN + BIKE CROSSINGS				
	N SIDE	S SIDE	E SIDE	W SIDE	TOTAL
7:00 AM	1	0	1	0	2
7:15 AM	0	0	0	1	1
7:30 AM	0	1	0	1	2
7:45 AM	0	1	0	1	2
8:00 AM	0	0	1	0	1
8:15 AM	1	0	0	2	3
8:30 AM	0	0	1	0	1
8:45 AM	0	2	0	2	4
TOTAL	2	4	3	7	16
AM BEGIN PEAK HR	7:45 AM				
4:00 PM	2	0	3	0	5
4:15 PM	0	0	0	2	2
4:30 PM	1	0	2	1	4
4:45 PM	0	1	0	0	1
5:00 PM	1	1	0	1	3
5:15 PM	0	0	1	1	2
5:30 PM	0	0	2	1	3
5:45 PM	0	2	0	2	4
TOTAL	4	4	8	8	24
PM BEGIN PEAK HR	4:30 PM				

PEDESTRIAN CROSSINGS				
N SIDE	S SIDE	E SIDE	W SIDE	TOTAL
1	0	0	0	1
0	0	0	1	1
0	1	0	0	1
0	0	0	1	1
0	0	1	0	1
0	0	0	2	2
0	0	1	0	1
0	1	0	2	3
1	2	2	6	11
0	0	2	3	5
1	0	0	0	1
0	0	0	2	2
0	0	0	0	0
0	0	0	0	0
0	1	0	0	1
0	0	1	0	1
0	0	2	1	3
0	0	0	1	1
1	1	3	4	9
0	1	1	0	2

BICYCLE CROSSINGS				
NS	SS	ES	WS	TOTAL
0	0	1	0	1
0	0	0	0	0
0	0	0	1	1
0	1	0	0	1
0	0	0	0	0
1	0	0	0	1
0	0	0	0	0
0	0	0	0	0
0	1	0	0	1
0	0	0	1	1
0	0	0	0	0
0	2	0	1	3
1	2	1	1	5
1	0	3	0	4
0	0	0	0	0
1	0	2	1	4
0	1	0	0	1
1	0	0	1	2
0	0	0	0	0
0	0	0	0	0
0	2	0	1	3
3	3	5	4	15

INTERSECTION TURNING MOVEMENT COUNTS

PREPARED BY: AimTD LLC. tel: 714 253 7888 cs@aimtd.com

DATE: Thu, May 23, 19	LOCATION: NORTH & SOUTH: EAST & WEST:	Tustin Tustin Ranch Warner North	PROJECT #: SC2143 LOCATION #: 10 CONTROL: SIGNAL
---------------------------------	--	--	---

NOTES:	AM	▲ N	E ►
	PM		
	MD	◀ W	
	OTHER OTHER	S ▼	

Add U-Turns to Left Turns

LANES:	NORTHBOUND Tustin Ranch			SOUTHBOUND Tustin Ranch			EASTBOUND Warner North			WESTBOUND Warner North			TOTAL
	NL X	NT 3	NR 1	SL 2	ST 3	SR X	EL X	ET X	ER X	WL 3	WT X	WR 2	

U-TURNS				
NB	SB	EB	WB	TTL

AM	7:00 AM	0	51	40	75	177	0	0	0	0	53	0	59	455	0	0	0	0	0
	7:15 AM	0	52	46	65	226	0	0	0	0	73	0	40	502	0	0	0	0	0
	7:30 AM	0	70	59	58	284	0	0	0	0	97	0	30	598	0	0	0	0	0
	7:45 AM	0	71	66	134	342	0	0	0	0	163	0	44	820	0	0	0	0	0
	8:00 AM	0	67	62	118	322	0	0	0	0	138	0	30	737	0	0	0	0	0
	8:15 AM	0	82	65	100	327	0	0	0	0	148	0	51	773	0	0	0	0	0
	8:30 AM	0	49	67	99	285	0	0	0	0	136	0	47	683	0	0	0	0	0
	8:45 AM	0	62	55	90	271	0	0	0	0	143	0	46	667	0	0	0	0	0
	VOLUMES	0	504	460	739	2,234	0	0	0	0	951	0	347	5,235	0	0	0	0	0
	APPROACH %	0%	52%	48%	25%	75%	0%	0%	0%	0%	73%	0%	27%						
APP/DEPART	964	/	851	2,973	/	3,185	0	/	1,199	1,298	/	0	0						
BEGIN PEAK HR	7:45 AM																		
VOLUMES	0	269	260	451	1,276	0	0	0	0	585	0	172	3,013						
APPROACH %	0%	51%	49%	26%	74%	0%	0%	0%	0%	77%	0%	23%							
PEAK HR FACTOR		0.900			0.907			0.000			0.914		0.919						
APP/DEPART	529	/	441	1,727	/	1,861	0	/	711	757	/	0	0						
PM	4:00 PM	0	342	151	73	104	0	0	0	0	86	0	99	855	0	0	0	0	
	4:15 PM	0	337	174	74	107	0	0	0	0	98	0	95	885	1	0	0	0	
	4:30 PM	0	369	169	83	102	0	0	0	0	98	0	105	926	2	0	0	0	
	4:45 PM	0	355	170	73	115	0	0	0	0	98	0	113	924	0	0	0	0	
	5:00 PM	0	429	228	82	126	0	0	0	0	112	0	120	1,097	0	0	0	0	
	5:15 PM	0	346	222	97	136	0	0	0	0	108	0	111	1,020	0	0	0	0	
	5:30 PM	0	407	248	87	121	0	0	0	0	142	0	96	1,101	0	0	0	0	
	5:45 PM	0	424	248	81	127	0	0	0	0	112	0	101	1,093	0	0	0	0	
	VOLUMES	0	3,009	1,610	650	938	0	0	0	0	854	0	840	7,904	3	0	0	0	
	APPROACH %	0%	65%	35%	41%	59%	0%	0%	0%	0%	50%	0%	50%						
APP/DEPART	4,622	/	3,849	1,588	/	1,795	0	/	2,260	1,694	/	0	0						
BEGIN PEAK HR	5:00 PM																		
VOLUMES	0	1,606	946	347	510	0	0	0	0	474	0	428	4,311						
APPROACH %	0%	63%	37%	40%	60%	0%	0%	0%	0%	53%	0%	47%							
PEAK HR FACTOR		0.949			0.920			0.000			0.947		0.979						
APP/DEPART	2,552	/	2,034	857	/	984	0	/	1,293	902	/	0	0						

0	0	0	0	0
0	0	0	0	0
0	0	0	0	0
0	0	0	0	0
0	0	0	0	0
0	0	0	0	0
0	0	0	0	0
0	0	0	0	0
0	0	0	0	0
0	0	0	0	0

0	0	0	0	0
1	0	0	0	1
2	0	0	0	2
0	0	0	0	0
0	0	0	0	0
0	0	0	0	0
0	0	0	0	0
0	0	0	0	0
0	0	0	0	0
3	0	0	0	3

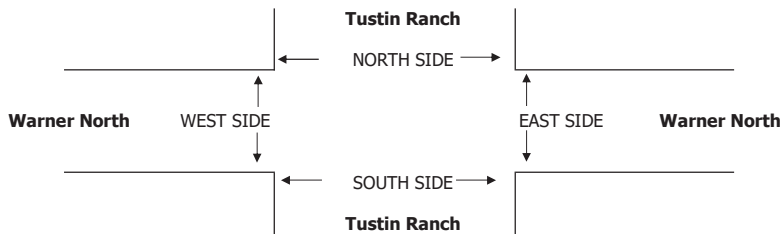

AM	7:00 AM	1	2	2	2	7
	7:15 AM	0	0	0	0	0
	7:30 AM	0	0	0	0	0
	7:45 AM	1	0	0	1	2
	8:00 AM	0	0	0	1	1
	8:15 AM	0	1	2	0	3
	8:30 AM	0	1	1	1	3
	8:45 AM	0	0	1	0	1
	TOTAL	2	4	6	5	17
	AM BEGIN PEAK HR	7:45 AM				
PM	4:00 PM	0	0	0	0	0
	4:15 PM	1	1	0	0	2
	4:30 PM	0	0	0	0	0
	4:45 PM	0	0	0	0	0
	5:00 PM	0	0	1	0	1
	5:15 PM	0	1	1	0	2
	5:30 PM	0	0	1	0	1
	5:45 PM	1	1	1	2	5
	TOTAL	2	3	4	2	11
	PM BEGIN PEAK HR	5:00 PM				

PEDESTRIAN + BIKE CROSSINGS				
N SIDE	S SIDE	E SIDE	W SIDE	TOTAL
1	2	2	2	7
0	0	0	0	0
0	0	0	0	0
1	0	0	1	2
0	0	0	1	1
0	1	2	0	3
0	1	1	1	3
0	0	1	0	1
2	4	6	5	17
7:45 AM				
0	0	0	0	0
1	1	0	0	2
0	0	0	0	0
0	0	0	0	0
0	0	1	0	1
0	1	1	0	2
0	0	1	0	1
1	1	1	2	5
2	3	4	2	11
5:00 PM				

PEDESTRIAN CROSSINGS				
N SIDE	S SIDE	E SIDE	W SIDE	TOTAL
0	0	1	0	1
0	0	0	0	0
0	0	0	0	0
0	0	0	0	0
0	0	0	0	0
0	0	2	0	2
0	0	1	0	1
0	0	1	0	1
0	0	1	0	1
0	0	5	0	5
0	0	3	0	3
0	0	0	0	0
0	1	0	0	1
0	0	0	0	0
0	0	1	0	1
0	0	0	0	0
0	1	1	0	2
0	0	1	0	1

BICYCLE CROSSINGS				
NS	SS	ES	WS	TOTAL
1	2	1	2	6
0	0	0	0	0
0	0	0	0	0
1	0	0	1	2
0	0	0	1	1
0	1	0	0	1
0	1	0	1	2
0	0	0	0	0
1	1	1	2	5
2	2	3	2	9

National Data & Surveying Services

Intersection Turning Movement Count

Location: Walnut Ave & Tustin Ranch Rd
City: Tustin
Control: Signalized

Project ID: 19-01171-001
Date: 8/27/2019

Total

NS/EW Streets:	Walnut Ave				Walnut Ave				Tustin Ranch Rd				Tustin Ranch Rd				TOTAL	
	NORTHBOUND				SOUTHBOUND				EASTBOUND				WESTBOUND					
AM	2 NL	2 NT	1 NR	0 NU	2 SL	2 ST	0 SR	0 SU	2 EL	3 ET	1 ER	0 EU	2 WL	3 WT	1 WR	0 WU		
7:00 AM	14	26	41	0	78	87	55	0	19	91	39	0	151	239	35	0	875	
7:15 AM	16	30	35	0	133	123	46	0	8	93	27	0	116	266	40	0	933	
7:30 AM	31	52	15	0	125	122	94	0	17	94	43	0	133	383	63	0	1172	
7:45 AM	31	33	36	0	115	133	100	0	15	125	72	0	103	383	93	0	1239	
8:00 AM	35	40	35	0	71	110	67	0	15	99	56	0	117	392	44	0	1081	
8:15 AM	47	53	47	0	58	97	68	0	15	78	43	0	130	447	43	1	1127	
8:30 AM	24	41	34	0	57	115	59	0	15	83	42	0	131	437	43	0	1081	
8:45 AM	30	62	42	0	58	120	59	0	17	85	51	0	152	345	24	0	1045	
TOTAL VOLUMES :	228	337	285	0	695	907	548	0	121	748	373	0	1033	2892	385	1	8553	
APPROACH %'s :	26.82%	39.65%	33.53%	0.00%	32.33%	42.19%	25.49%	0.00%	9.74%	60.23%	30.03%	0.00%	23.96%	67.08%	8.93%	0.02%		
PEAK HR :	07:30 AM - 08:30 AM																	
PEAK HR VOL :	144	178	133	0	369	462	329	0	62	396	214	0	483	1605	243	1	4619	
PEAK HR FACTOR :	0.766	0.840	0.707	0.000	0.738	0.868	0.823	0.000	0.912	0.792	0.743	0.000	0.908	0.898	0.653	0.250	0.932	
			0.774				0.833				0.792				0.939			
PM	2 NL	2 NT	1 NR	0 NU	2 SL	2 ST	0 SR	0 SU	2 EL	3 ET	1 ER	0 EU	2 WL	3 WT	1 WR	0 WU	TOTAL	
4:00 PM	33	234	203	0	33	51	27	0	70	326	42	0	47	138	78	0	1282	
4:15 PM	37	154	128	0	45	45	28	0	107	381	46	2	63	159	98	1	1294	
4:30 PM	31	185	178	0	48	59	26	1	79	429	41	1	49	147	88	2	1364	
4:45 PM	27	192	144	0	46	56	26	0	86	442	28	0	46	150	90	0	1333	
5:00 PM	42	204	174	1	50	55	35	0	105	439	44	1	61	157	111	0	1479	
5:15 PM	44	224	169	0	47	69	34	0	104	424	41	2	51	143	101	1	1454	
5:30 PM	37	222	166	0	39	48	35	0	104	448	44	1	60	151	113	0	1468	
5:45 PM	32	214	129	0	52	59	41	0	92	397	59	0	68	149	95	0	1387	
TOTAL VOLUMES :	283	1629	1291	1	360	442	252	1	747	3286	345	7	445	1194	774	4	11061	
APPROACH %'s :	8.83%	50.84%	40.29%	0.03%	34.12%	41.90%	23.89%	0.09%	17.04%	74.94%	7.87%	0.16%	18.41%	49.40%	32.02%	0.17%		
PEAK HR :	05:00 PM - 06:00 PM																	
PEAK HR VOL :	155	864	638	1	188	231	145	0	405	1708	188	4	240	600	420	1	5788	
PEAK HR FACTOR :	0.881	0.964	0.917	0.250	0.904	0.837	0.884	0.000	0.964	0.953	0.797	0.500	0.882	0.955	0.929	0.250	0.978	
			0.949				0.928				0.965				0.958			

INTERSECTION TURNING MOVEMENT COUNTS AVERAGE SHEET

PREPARED BY: AimTD LLC. tel: 714 253 7888 cs@aimtd.com

DATE: AVERAGE FOR THREE DAYS

LOCATION: NORTH & SOUTH: EAST & WEST:

Santa Ana SB SR-55 Ramps Irvine

PROJECT #: CMP2019 LOCATION #: 194 CONTROL: SIGNAL

NOTES:

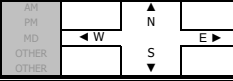

Add U-Turns to Left Turns

Main data table with columns for Northbound, Southbound, Eastbound, Westbound lanes and volumes. Includes AM and PM sections with time slots from 6:00 AM to 6:45 PM.

U-TURNS table with columns: NB, SB, EB, WB, TTL

Right-turn Overlap table with columns: NRR, SRR, ERR, WRR

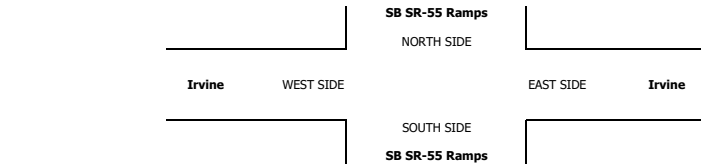

U-TURNS table (continued)

Right-turn Overlap table (continued)

AM and PM BEGIN PEAK HR summary table

ALL PED AND BIKE table with columns: N SIDE, S SIDE, E SIDE, W SIDE, TOTAL

PEDESTRIAN CROSSINGS table with columns: N SIDE, S SIDE, E SIDE, W SIDE, TOTAL

BICYCLE CROSSINGS table with columns: NS, SS, ES, WS, TOTAL

INTERSECTION TURNING MOVEMENT COUNTS AVERAGE SHEET

PREPARED BY: AimTD LLC. tel: 714 253 7888 cs@aimtd.com

T319

DATE:
AVERAGE FOR THREE DAYS

LOCATION:
NORTH & SOUTH:
EAST & WEST:

Tustin
NB SR-55 Ramps
Irvine

PROJECT #: CMP2019
LOCATION #: 232
CONTROL: SIGNAL



Add U-Turns to Left Turns

Main intersection data table with columns for Northbound, Southbound, Eastbound, and Westbound lanes, and rows for time intervals (6:00 AM to 8:45 AM), volumes, and peak hours.

U-TURNS table with columns NB, SB, EB, WB, TTL and rows for time intervals.

Right-turn Overlap table with columns NRR, SRR, ERR, WRR and rows for time intervals.

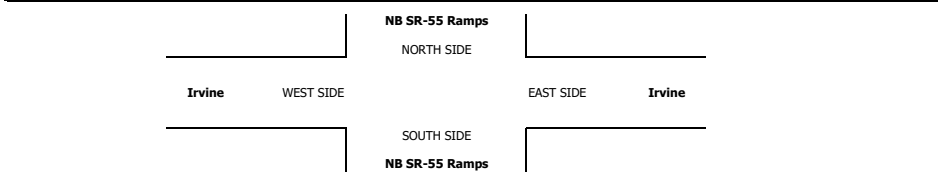

Summary table for Ped and Bike counts, with columns N Side, S Side, E Side, W Side, and Total, and rows for time intervals.

Summary table for Pedestrian Crossings, with columns N Side, S Side, E Side, W Side, and Total, and rows for time intervals.

Summary table for Bicycle Crossings, with columns NS, SS, ES, WS, and Total, and rows for time intervals.

Transportation Studies, Inc.

2640 Walnut Avenue, Suite L
Tustin, CA. 92780

Location : FIRST STREET
Segment : WEST CITY LIMIT TO EUCLID ST
Client : CITY SANTA ANA

Site: SANTA ANA
Date: 09/11/19

Interval	WB				EB				Combined		Day:	Wednesday
	AM		PM		AM		PM		AM	PM		
12:00	36	94	196	738	30	110	167	710	66	204	363	1.448
12:15	18		198		22		170		40		368	
12:30	20		178		28		187		48		365	
12:45	20		166		30		186		50		352	
01:00	18	62	170	710	12	41	163	702	30	103	333	1.412
01:15	17		172		10		172		27		344	
01:30	17		180		10		172		27		352	
01:45	10		188		9		195		19		383	
02:00	17	48	148	771	8	20	194	781	25	68	342	1.552
02:15	8		197		4		188		12		385	
02:30	10		212		3		176		13		388	
02:45	13		214		5		223		18		437	
03:00	8	38	224	860	8	53	210	848	16	91	434	1.708
03:15	8		208		12		220		20		428	
03:30	10		226		17		218		27		444	
03:45	12		202		16		200		28		402	
04:00	14	101	208	1,014	9	85	190	798	23	186	398	1.812
04:15	20		243		17		196		37		439	
04:30	36		280		25		196		61		476	
04:45	31		283		34		216		65		499	
05:00	26	184	276	1,178	47	194	260	950	73	378	536	2,128
05:15	37		303		31		252		68		555	
05:30	71		320		51		226		122		546	
05:45	50		279		65		212		115		491	
06:00	55	331	278	978	68	397	252	844	123	728	530	1.822
06:15	84		252		89		211		173		463	
06:30	78		246		98		197		176		443	
06:45	114		202		142		184		256		386	
07:00	118	685	214	743	182	865	170	576	300	1,550	384	1,319
07:15	136		151		204		138		340		289	
07:30	197		192		237		134		434		326	
07:45	234		186		242		134		476		320	
08:00	256	806	142	514	255	985	134	437	511	1,791	276	951
08:15	170		174		269		109		439		283	
08:30	182		102		233		92		415		194	
08:45	198		96		228		102		426		198	
09:00	175	737	110	414	152	641	101	351	327	1,378	211	765
09:15	188		108		188		100		376		208	
09:30	203		88		158		84		361		172	
09:45	171		108		143		66		314		174	
10:00	176	730	77	272	160	559	74	260	336	1,289	151	532
10:15	176		76		123		71		299		147	
10:30	201		53		138		56		339		109	
10:45	177		66		138		59		315		125	
11:00	176	709	51	203	178	696	58	160	354	1,405	109	363
11:15	146		50		168		33		314		83	
11:30	172		64		182		44		354		108	
11:45	215		38		168		25		383		63	
Totals	4,525		8,395		4,646		7,417		9,171		15,812	
Split%	49.3		53.1		50.7		46.9					
Day Totals		12,920				12,063				24,983		
Day Splits		51.7				48.3						
Peak Hour	07:30		04:45		07:30		04:45		07:30		04:45	
Volume	857		1,182		1,003		954		1,860		2,136	
Factor	0.84		0.92		0.93		0.92		0.91		0.96	

Transportation Studies, Inc.

2640 Walnut Avenue, Suite L
Tustin, CA. 92780

Location : EUCLID STREET
Segment : NCFADDEN AVE TO FIRST ST
Client : CITY SANTA ANA

Site: SANTA ANA
Date: 10/09/19

Interval	NB				SB				Combined				Day:	Wednesday
	AM		PM		AM		PM		AM		PM			
12:00	58	202	246	964	44	131	224	983	102	333	470	1,947		
12:15	52		242		34		258		86		500			
12:30	49		230		36		264		85		494			
12:45	43		246		17		237		60		483			
01:00	56	121	210	968	14	76	226	1,049	70	197	436	2,017		
01:15	28		222		18		259		46		481			
01:30	18		266		26		280		44		546			
01:45	19		270		18		284		37		554			
02:00	20	72	316	1,292	12	68	266	1,194	32	140	582	2,486		
02:15	15		288		23		284		38		572			
02:30	19		340		17		322		36		662			
02:45	18		348		16		322		34		670			
03:00	12	72	369	1,577	15	129	284	1,135	27	201	653	2,712		
03:15	22		377		27		277		49		654			
03:30	20		424		40		322		60		746			
03:45	18		407		47		252		65		659			
04:00	26	126	396	1,693	46	347	302	1,177	72	473	698	2,870		
04:15	30		418		60		278		90		696			
04:30	26		451		113		296		139		747			
04:45	44		428		128		301		172		729			
05:00	49	305	434	1,783	114	724	328	1,282	163	1,029	762	3,065		
05:15	74		457		154		318		228		775			
05:30	82		446		198		312		280		758			
05:45	100		446		258		324		358		770			
06:00	88	576	411	1,520	197	1,327	337	1,167	285	1,903	748	2,687		
06:15	123		393		288		294		411		687			
06:30	179		360		363		274		542		634			
06:45	186		356		479		262		665		618			
07:00	228	1,179	346	1,268	462	2,083	215	762	690	3,262	561	2,030		
07:15	275		323		552		186		827		509			
07:30	299		326		593		201		892		527			
07:45	377		273		476		160		853		433			
08:00	314	1,212	206	759	474	1,930	171	613	788	3,142	377	1,372		
08:15	352		211		521		164		873		375			
08:30	292		182		494		142		786		324			
08:45	254		160		441		136		695		296			
09:00	258	935	188	664	359	1,319	142	510	617	2,254	330	1,174		
09:15	220		144		362		134		582		278			
09:30	240		148		310		127		550		275			
09:45	217		184		288		107		505		291			
10:00	213	829	172	547	234	965	100	356	447	1,794	272	903		
10:15	208		158		252		100		460		258			
10:30	224		112		224		86		448		198			
10:45	184		105		255		70		439		175			
11:00	214	908	94	324	200	862	66	243	414	1,770	160	567		
11:15	248		77		200		66		448		143			
11:30	226		92		232		60		458		152			
11:45	220		61		230		51		450		112			
Totals	6,537		13,359		9,961		10,471		16,498		23,830			
Split%	39.6		56.1		60.4		43.9							
Day Totals		19,896				20,432				40,328				
Day Splits		49.3				50.7								
Peak Hour	07:30		05:00		07:15		05:15		07:30		05:00			
Volume	1,342		1,783		2,095		1,291		3,406		3,065			
Factor	0.89		0.98		0.88		0.96		0.95		0.99			

ADT227 SEVENTEENTH ST from HARBOR BL to CLINTON ST.

Prepared by AimTD tel. 714 253 7888

AM Period	NB	SB	EB	WB	PM Period	NB	SB	EB	WB			
0:30			23	18	12:00			189	248			
0:15			24	19	12:15			191	232			
0:30			21	20	12:30			192	214			
0:45			16	84	14	71	155	182	754	223	917	1671
1:00			15	15	13:00			213	204			
1:15			27	11	13:15			194	230			
1:30			19	14	13:30			184	265			
1:45			15	76	9	49	125	220	811	245	944	1755
2:00			12	9	14:00			255	241			
2:15			11	7	14:15			258	234			
2:30			8	10	14:30			292	253			
2:45			9	40	11	37	77	277	1082	271	999	2081
3:00			10	9	15:00			229	256			
3:15			11	13	15:15			242	270			
3:30			9	8	15:30			275	263			
3:45			8	38	15	45	83	232	978	291	1080	2058
4:00			12	17	16:00			256	304			
4:15			20	23	16:15			262	289			
4:30			16	26	16:30			294	293			
4:45			24	72	32	98	170	307	1119	303	1189	2308
5:00			32	49	17:00			302	313			
5:15			59	57	17:15			321	235			
5:30			68	65	17:30			276	241			
5:45			83	242	76	247	489	312	1211	285	1074	2285
6:00			103	85	18:00			300	274			
6:15			100	95	18:15			311	245			
6:30			167	112	18:30			268	231			
6:45			209	579	146	438	1017	238	1117	234	984	2101
7:00			285	159	19:00			215	203			
7:15			307	193	19:15			182	214			
7:30			366	256	19:30			152	201			
7:45			407	1365	283	891	2256	143	692	184	802	1494
8:00			393	274	20:00			117	174			
8:15			332	242	20:15			132	170			
8:30			319	249	20:30			114	182			
8:45			267	1311	232	997	2308	125	488	167	693	1181
9:00			196	195	21:00			103	142			
9:15			217	185	21:15			95	132			
9:30			204	174	21:30			115	95			
9:45			234	851	177	731	1582	94	407	112	481	888
10:00			222	184	22:00			88	76			
10:15			187	204	22:15			58	81			
10:30			199	213	22:30			53	53			
10:45			212	820	206	807	1627	60	259	58	268	527
11:00			189	201	23:00			46	43			
11:15			203	204	23:15			40	26			
11:30			199	216	23:30			32	31			
11:45			217	808	224	845	1653	28	146	20	120	266

Total Vol. 6286 5256 **11542** 9064 9551 **18615**

Daily Totals				
NB	SB	EB	WB	Combined
		15350	14807	30157

AM					PM				
Split %									
		54.5%	45.5%	38.3%		48.7%	51.3%	61.7%	
Peak Hour	0:30	0:30	7:30	7:30	7:30		16:30	16:15	16:30
Volume			1498	1055	2553		1224	1198	2368
P.H.F.			0.92	0.93	0.93		0.95	0.96	0.96

Transportation Studies, Inc.

2640 Walnut Avenue, Suite L
Tustin, CA. 92780

Location : HARBOR BOULEVARD
Segment : HAZARD AVE TO WESTMINSTER AVE
Client : CITY SANTA ANA

Site: SANTA ANA
Date: 10/03/19

Interval	NB				SB				Combined				Day:	Thursday
	AM		PM		AM		PM		AM		PM			
12:00	92	310	350	1.400	85	314	390	1.421	177	624	740	2.821		
12:15	72		382		72		334		144		716			
12:30	84		316		84		361		168		677			
12:45	62		352		73		336		135		688			
01:00	68	206	422	1.653	65	198	354	1.420	133	404	776	3.073		
01:15	48		418		40		366		88		784			
01:30	50		372		43		354		93		726			
01:45	40		441		50		346		90		787			
02:00	50	219	446	2.014	40	153	386	1.525	90	372	832	3.539		
02:15	69		482		40		354		109		836			
02:30	54		552		39		379		93		931			
02:45	46		534		34		406		80		940			
03:00	50	223	428	1.995	38	251	380	1.504	88	474	808	3.499		
03:15	52		526		48		380		100		906			
03:30	65		551		69		380		134		931			
03:45	56		490		96		364		152		854			
04:00	70	404	526	1.970	68	452	368	1.556	138	856	894	3.526		
04:15	90		528		76		362		166		890			
04:30	124		457		139		396		263		853			
04:45	120		459		169		430		289		889			
05:00	133	700	461	1.833	144	816	440	1.675	277	1,516	901	3,508		
05:15	178		460		184		426		362		886			
05:30	218		432		232		418		450		850			
05:45	171		480		256		391		427		871			
06:00	200	1,022	454	1.777	245	1,441	350	1.327	445	2,463	804	3,104		
06:15	252		452		299		323		551		775			
06:30	262		432		416		346		678		778			
06:45	308		439		481		308		789		747			
07:00	295	1,392	394	1.388	538	2,071	322	1,324	833	3,463	716	2,712		
07:15	356		362		531		375		887		737			
07:30	391		330		522		333		913		663			
07:45	350		302		480		294		830		596			
08:00	404	1,409	298	1.060	478	1,943	278	1.045	882	3,352	576	2.105		
08:15	344		280		498		280		842		560			
08:30	324		228		493		258		817		486			
08:45	337		254		474		229		811		483			
09:00	302	1,082	263	851	396	1,736	239	934	698	2,818	502	1,785		
09:15	260		248		462		254		722		502			
09:30	264		194		436		247		700		441			
09:45	256		146		442		194		698		340			
10:00	301	1,200	189	658	354	1,412	231	709	655	2,612	420	1,367		
10:15	327		162		380		190		707		352			
10:30	308		146		368		150		676		296			
10:45	264		161		310		138		574		299			
11:00	294	1,268	146	473	328	1,337	154	530	622	2,605	300	1,003		
11:15	293		108		337		126		630		234			
11:30	372		116		314		118		686		234			
11:45	309		103		358		132		667		235			
Totals	9,435		17,072		12,124		14,970		21,559		32,042			
Split%	43.8		53.3		56.2		46.7							
Day Totals		26,507				27,094				53,601				
Day Splits		49.5				50.5								
Peak Hour	07:15		03:30		06:45		04:45		07:15		02:30			
Volume	1,501		2,095		2,072		1,714		3,512		3,585			
Factor	0.93		0.95		0.96		0.97		0.96		0.95			

Transportation Studies, Inc.

2640 Walnut Avenue, Suite L
Tustin, CA. 92780

Location : FIRST STREET
Segment : HARBOR BLVD TO FAIRVIEW ST
Client : CITY SANTA ANA

Site: SANTA ANA
Date: 09/11/19

Interval	EB				WB				Combined		Day:	Wednesday
	AM		PM		AM		PM		AM	PM		
12:00	42	129	196	749	38	124	238	843	80	253	434	1,592
12:15	30		185		34		222		64		407	
12:30	24		188		26		169		50		357	
12:45	33		180		26		214		59		394	
01:00	24	79	214	890	29	90	220	924	53	169	434	1,814
01:15	22		228		17		240		39		468	
01:30	15		216		32		222		47		438	
01:45	18		232		12		242		30		474	
02:00	17	74	248	982	14	70	213	962	31	144	461	1,944
02:15	21		228		19		258		40		486	
02:30	18		238		17		225		35		463	
02:45	18		268		20		266		38		534	
03:00	16	84	268	1,096	18	80	267	1,186	34	164	535	2,282
03:15	16		266		17		318		33		584	
03:30	20		280		20		280		40		560	
03:45	32		282		25		321		57		603	
04:00	32	178	274	1,115	26	168	326	1,453	58	346	600	2,568
04:15	36		279		24		374		60		653	
04:30	56		282		54		372		110		654	
04:45	54		280		64		381		118		661	
05:00	56	382	278	1,164	55	304	382	1,520	111	686	660	2,684
05:15	68		302		79		398		147		700	
05:30	114		298		84		354		198		652	
05:45	144		286		86		386		230		672	
06:00	124	780	249	983	102	517	360	1,278	226	1,297	609	2,261
06:15	160		256		115		342		275		598	
06:30	234		254		141		322		375		576	
06:45	262		224		159		254		421		478	
07:00	336	1,556	236	824	156	835	253	889	492	2,391	489	1,713
07:15	384		198		204		208		588		406	
07:30	368		202		227		224		595		426	
07:45	468		188		248		204		716		392	
08:00	362	1,334	164	585	274	862	158	603	636	2,196	322	1,188
08:15	334		160		180		160		514		320	
08:30	326		126		204		147		530		273	
08:45	312		135		204		138		516		273	
09:00	252	914	137	484	175	730	118	477	427	1,644	255	961
09:15	232		134		188		127		420		261	
09:30	228		109		202		120		430		229	
09:45	202		104		165		112		367		216	
10:00	166	710	94	348	164	734	96	316	330	1,444	190	664
10:15	168		111		196		82		364		193	
10:30	216		67		186		70		402		137	
10:45	160		76		188		68		348		144	
11:00	200	785	66	202	176	815	54	205	376	1,600	120	407
11:15	176		58		206		65		382		123	
11:30	204		36		229		46		433		82	
11:45	205		42		204		40		409		82	
Totals	7,005		9,422		5,329		10,656		12,334		20,078	
Split%	56.8		46.9		43.2		53.1					
Day Totals		16,427				15,985				32,412		
Day Splits		50.7				49.3						
Peak Hour	07:15		05:00		07:15		04:30		07:15		05:00	
Volume	1,582		1,164		953		1,533		2,535		2,684	
Factor	0.85		0.96		0.87		0.96		0.89		0.96	

Transportation Studies, Inc.

2640 Walnut Avenue, Suite L
Tustin, CA. 92780

Location : EDINGER AVENUE
Segment : SANTA ANA RIVER TO FAIRVIEW ST
Client : CITY SANTA ANA

Site: SANTA ANA
Date: 09/17/19

Interval	EB				WB				Combined		Day:	Tuesday
	AM		PM		AM		PM		AM	PM		
12:00	21	88	144	628	28	83	176	659	49	171	320	1.287
12:15	35		165		17		162		52		327	
12:30	18		167		14		162		32		329	
12:45	14		152		24		159		38		311	
01:00	11	49	176	794	10	53	144	685	21	102	320	1.479
01:15	17		169		18		157		35		326	
01:30	11		231		11		186		22		417	
01:45	10		218		14		198		24		416	
02:00	8	32	185	881	5	40	200	870	13	72	385	1.751
02:15	4		202		8		205		12		407	
02:30	16		196		9		206		25		402	
02:45	4		298		18		259		22		557	
03:00	5	51	291	1.015	16	61	253	1.096	21	112	544	2.111
03:15	12		270		10		291		22		561	
03:30	19		216		14		268		33		484	
03:45	15		238		21		284		36		522	
04:00	21	151	266	1.009	11	137	304	1.244	32	288	570	2.253
04:15	31		232		20		326		51		558	
04:30	48		264		46		294		94		558	
04:45	51		247		60		320		111		567	
05:00	40	298	250	994	42	255	336	1.367	82	553	586	2.361
05:15	74		290		64		343		138		633	
05:30	78		224		70		332		148		556	
05:45	106		230		79		356		185		586	
06:00	104	578	212	799	63	489	310	1.167	167	1.067	522	1.966
06:15	130		214		111		319		241		533	
06:30	158		175		144		264		302		439	
06:45	186		198		171		274		357		472	
07:00	212	1.072	169	692	168	956	210	737	380	2.028	379	1.429
07:15	306		185		230		190		536		375	
07:30	298		185		268		191		566		376	
07:45	256		153		290		146		546		299	
08:00	274	1.018	184	673	249	821	162	564	523	1.839	346	1.237
08:15	262		168		224		156		486		324	
08:30	262		188		188		124		450		312	
08:45	220		133		160		122		380		255	
09:00	200	699	125	443	147	526	108	408	347	1,225	233	851
09:15	189		128		130		112		319		240	
09:30	172		95		111		110		283		205	
09:45	138		95		138		78		276		173	
10:00	147	668	82	240	162	638	89	256	309	1,306	171	496
10:15	137		70		156		70		293		140	
10:30	206		50		159		52		365		102	
10:45	178		38		161		45		339		83	
11:00	139	615	42	161	178	635	52	167	317	1,250	94	328
11:15	170		38		162		43		332		81	
11:30	142		48		151		39		293		87	
11:45	164		33		144		33		308		66	
Totals	5,319		8,329		4,694		9,220		10,013		17,549	
Split%	53.1		47.5		46.9		52.5					
Day Totals		13,648				13,914				27,562		
Day Splits		49.5				50.5						
Peak Hour	07:15		02:45		07:15		05:00		07:15		05:00	
Volume	1,134		1,075		1,037		1,367		2,171		2,361	
Factor	0.93		0.90		0.89		0.96		0.96		0.93	

Thursday, October 10, 2019

Location: Santa Ana

PROJECT:

ADT259 WARNER AVE from SANTA ANA RIVER to FAIRVIEW ST.

Prepared by AimTD tel. 714 253 7888

AM Period	NB	SB	EB	WB	PM Period	NB	SB	EB	WB			
0:30			37	21	12:00			194	204			
0:15			26	23	12:15			180	201			
0:30			24	20	12:30			211	176			
0:45			32	119	17	81	200	201	786	152	733	1519
1:00			22	8	13:00			212	204			
1:15			8	9	13:15			200	185			
1:30			14	11	13:30			231	211			
1:45			20	64	13	41	105	214	857	270	870	1727
2:00			15	9	14:00			259	308			
2:15			13	11	14:15			265	324			
2:30			14	8	14:30			290	386			
2:45			14	56	14	42	98	257	1071	337	1355	2426
3:00			17	13	15:00			231	377			
3:15			20	20	15:15			233	357			
3:30			21	12	15:30			238	398			
3:45			31	89	15	60	149	234	936	387	1519	2455
4:00			34	23	16:00			271	348			
4:15			43	14	16:15			253	346			
4:30			65	45	16:30			246	397			
4:45			63	205	101	183	388	303	1073	365	1456	2529
5:00			99	69	17:00			237	391			
5:15			123	91	17:15			216	418			
5:30			148	114	17:30			242	447			
5:45			240	610	126	400	1010	224	919	426	1682	2601
6:00			144	137	18:00			251	379			
6:15			145	123	18:15			214	336			
6:30			170	164	18:30			198	311			
6:45			250	709	189	613	1322	201	864	220	1246	2110
7:00			304	176	19:00			181	212			
7:15			400	223	19:15			157	156			
7:30			387	242	19:30			153	161			
7:45			375	1466	254	895	2361	144	635	154	683	1318
8:00			398	220	20:00			121	117			
8:15			408	245	20:15			149	137			
8:30			346	213	20:30			127	124			
8:45			334	1486	225	903	2389	103	500	114	492	992
9:00			284	198	21:00			125	87			
9:15			203	156	21:15			92	76			
9:30			214	158	21:30			109	82			
9:45			225	926	196	708	1634	116	442	54	299	741
10:00			200	185	22:00			76	56			
10:15			189	168	22:15			64	46			
10:30			192	157	22:30			53	38			
10:45			168	749	156	666	1415	47	240	41	181	421
11:00			176	147	23:00			67	57			
11:15			159	157	23:15			46	38			
11:30			188	166	23:30			41	52			
11:45			180	703	174	644	1347	34	188	37	184	372

Total Vol. 7182 5236 **12418** 8511 10700 **19211**

Daily Totals				
NB	SB	EB	WB	Combined
		15693	15936	31629

AM					PM				
Split %									
		57.8%	42.2%	39.3%		44.3%	55.7%	60.7%	
Peak Hour	0:30	0:30	7:30	7:30	7:30		16:00	17:00	16:45
Volume			1568	961	2529		1073	1682	2619
P.H.F.			0.96	0.95	0.97		0.89	0.94	0.95

Transportation Studies, Inc.

2640 Walnut Avenue, Suite L
Tustin, CA. 92780

Location : HARBOR BOULEVARD
Segment : MACARTHUR TO SEGERSTROM
Client : CITY SANTA ANA

Site: SANTA ANA
Date: 10/03/19

Interval	NB				SB				Combined				Day:	Thursday
	AM		PM		AM		PM		AM		PM			
12:00	67	199	312	1.356	41	122	402	1.498	108	321	714	2.854		
12:15	54		340		24		373		78		713			
12:30	34		350		34		373		68		723			
12:45	44		354		23		350		67		704			
01:00	34	116	314	1.472	20	82	361	1.358	54	198	675	2.830		
01:15	28		361		19		331		47		692			
01:30	26		382		28		356		54		738			
01:45	28		415		15		310		43		725			
02:00	25	100	385	1.670	16	78	314	1.316	41	178	699	2.986		
02:15	26		440		13		330		39		770			
02:30	27		463		26		350		53		813			
02:45	22		382		23		322		45		704			
03:00	17	92	475	1.874	24	137	302	1.218	41	229	777	3.092		
03:15	20		445		26		338		46		783			
03:30	26		498		41		289		67		787			
03:45	29		456		46		289		75		745			
04:00	20	134	515	1.899	56	408	308	1.239	76	542	823	3.138		
04:15	22		473		70		282		92		755			
04:30	28		472		116		339		144		811			
04:45	64		439		166		310		230		749			
05:00	63	336	430	1.763	115	782	298	1.203	178	1,118	728	2.966		
05:15	75		447		152		298		227		745			
05:30	90		432		221		316		311		748			
05:45	108		454		294		291		402		745			
06:00	116	561	488	1.876	236	1,432	280	1.016	352	1,993	768	2.892		
06:15	121		458		310		260		431		718			
06:30	150		454		400		242		550		696			
06:45	174		476		486		234		660		710			
07:00	174	870	444	1.525	536	2,323	216	816	710	3,193	660	2,341		
07:15	216		383		606		204		822		587			
07:30	204		388		599		210		803		598			
07:45	276		310		582		186		858		496			
08:00	282	1,104	239	905	575	2,323	192	666	857	3,427	431	1,571		
08:15	291		218		574		177		865		395			
08:30	275		210		568		167		843		377			
08:45	256		238		606		130		862		368			
09:00	232	892	193	815	487	1,885	140	510	719	2,777	333	1,325		
09:15	226		227		516		142		742		369			
09:30	228		203		455		122		683		325			
09:45	206		192		427		106		633		298			
10:00	250	930	226	667	362	1,490	103	339	612	2,420	329	1,006		
10:15	226		193		376		104		602		297			
10:30	222		124		338		70		560		194			
10:45	232		124		414		62		646		186			
11:00	264	1,142	100	463	376	1,415	56	241	640	2,557	156	704		
11:15	304		103		320		69		624		172			
11:30	278		114		353		56		631		170			
11:45	296		146		366		60		662		206			
Totals	6,476		16,285		12,477		11,420		18,953		27,705			
Split%	34.2		58.8		65.8		41.2							
Day Totals		22,761				23,897				46,658				
Day Splits		48.8				51.2								
Peak Hour	11:00		03:30		07:15		12:00		08:00		03:15			
Volume	1,142		1,942		2,362		1,498		3,427		3,138			
Factor	0.94		0.94		0.97		0.93		0.99		0.95			

Transportation Studies, Inc.

2640 Walnut Avenue, Suite L
Tustin, CA. 92780

Location : FAIRVIEW STREET
Segment : MCFADDEN AVE TO FIRST ST
Client : CITY SANTA ANA

Site: SANTA ANA
Date: 10/01/19

Interval	NB				SB				Combined				Day:	Tuesday
	AM		PM		AM		PM		AM		PM			
12:00	65	195	223	970	48	148	202	829	113	343	425	1,799		
12:15	63		244		41		240		104		484			
12:30	37		235		29		202		66		437			
12:45	30		268		30		185		60		453			
01:00	26	105	264	1,148	23	100	192	853	49	205	456	2,001		
01:15	28		287		31		205		59		492			
01:30	25		280		19		226		44		506			
01:45	26		317		27		230		53		547			
02:00	25	102	366	1,576	21	84	238	987	46	186	604	2,563		
02:15	29		376		25		196		54		572			
02:30	18		405		16		272		34		677			
02:45	30		429		22		281		52		710			
03:00	27	121	394	1,672	25	159	277	1,011	52	280	671	2,683		
03:15	26		425		30		256		56		681			
03:30	42		414		50		256		92		670			
03:45	26		439		54		222		80		661			
04:00	54	306	434	1,769	50	396	260	1,180	104	702	694	2,949		
04:15	56		446		68		316		124		762			
04:30	94		431		110		308		204		739			
04:45	102		458		168		296		270		754			
05:00	98	568	439	1,784	152	865	360	1,463	250	1,433	799	3,247		
05:15	150		475		189		350		339		825			
05:30	156		448		232		370		388		818			
05:45	164		422		292		383		456		805			
06:00	150	856	470	1,737	245	1,230	368	1,298	395	2,086	838	3,035		
06:15	184		451		228		330		412		781			
06:30	246		434		349		335		595		769			
06:45	276		382		408		265		684		647			
07:00	314	1,491	372	1,346	444	1,797	286	982	758	3,288	658	2,328		
07:15	391		352		458		260		849		612			
07:30	424		318		476		202		900		520			
07:45	362		304		419		234		781		538			
08:00	346	1,155	266	976	423	1,562	207	710	769	2,717	473	1,686		
08:15	299		258		454		180		753		438			
08:30	272		242		360		163		632		405			
08:45	238		210		325		160		563		370			
09:00	210	902	194	753	298	1,168	154	579	508	2,070	348	1,332		
09:15	238		194		271		158		509		352			
09:30	210		195		334		118		544		313			
09:45	244		170		265		149		509		319			
10:00	238	922	157	536	288	1,021	122	414	526	1,943	279	950		
10:15	202		162		260		117		462		279			
10:30	235		116		244		82		479		198			
10:45	247		101		229		93		476		194			
11:00	222	930	104	346	246	815	82	266	468	1,745	186	612		
11:15	232		84		206		78		438		162			
11:30	244		92		177		59		421		151			
11:45	232		66		186		47		418		113			
Totals	7,653		14,613		9,345		10,572		16,998		25,185			
Split%	45.0		58.0		55.0		42.0							
Day Totals		22,266				19,917				42,183				
Day Splits		52.8				47.2								
Peak Hour	07:15		04:45		07:00		05:15		07:15		05:15			
Volume	1,523		1,820		1,797		1,471		3,299		3,286			
Factor	0.90		0.96		0.94		0.96		0.92		0.98			

Transportation Studies, Inc.

2640 Walnut Avenue, Suite L
Tustin, CA. 92780

Location : FIRST STREET
Segment : FAIRVIEW ST TO RAITT ST
Client : CITY SANTA ANA

Site: SANTA ANA
Date: 09/11/19

Interval	WB				EB				Combined				Day:	Wednesday
	AM		PM		AM		PM		AM		PM			
12:00	50	149	268	1.002	50	161	230	914	100	310	498	1.916		
12:15	41		266		50		217		91		483			
12:30	27		222		29		233		56		455			
12:45	31		246		32		234		63		480			
01:00	26	96	266	1.099	31	90	250	1.006	57	186	516	2.105		
01:15	28		270		20		266		48		536			
01:30	30		289		21		232		51		521			
01:45	12		274		18		258		30		532			
02:00	25	85	292	1.206	15	74	276	1.054	40	159	568	2.260		
02:15	20		316		17		248		37		564			
02:30	23		292		24		258		47		550			
02:45	17		306		18		272		35		578			
03:00	18	96	326	1.396	15	88	300	1.173	33	184	626	2.569		
03:15	15		364		9		307		24		671			
03:30	30		350		26		294		56		644			
03:45	33		356		38		272		71		628			
04:00	26	176	372	1.563	30	205	296	1.192	56	381	668	2.755		
04:15	43		376		40		300		83		676			
04:30	52		404		67		304		119		708			
04:45	55		411		68		292		123		703			
05:00	68	348	385	1.506	82	433	288	1.274	150	781	673	2.780		
05:15	88		371		86		340		174		711			
05:30	92		360		115		318		207		678			
05:45	100		390		150		328		250		718			
06:00	106	582	334	1.328	155	842	284	1.101	261	1.424	618	2.429		
06:15	128		364		185		276		313		640			
06:30	160		326		232		263		392		589			
06:45	188		304		270		278		458		582			
07:00	211	1,049	256	933	340	1,568	254	885	551	2,617	510	1,818		
07:15	266		234		430		228		696		462			
07:30	274		237		398		215		672		452			
07:45	298		206		400		188		698		394			
08:00	250	899	195	695	410	1,426	172	652	660	2,325	367	1,347		
08:15	210		182		357		178		567		360			
08:30	227		160		335		155		562		315			
08:45	212		158		324		147		536		305			
09:00	218	873	168	599	285	1,040	128	482	503	1,913	296	1,081		
09:15	215		160		262		132		477		292			
09:30	232		153		249		124		481		277			
09:45	208		118		244		98		452		216			
10:00	211	872	118	357	206	822	104	334	417	1,694	222	691		
10:15	231		96		188		82		419		178			
10:30	232		65		244		80		476		145			
10:45	198		78		184		68		382		146			
11:00	214	968	72	217	214	877	70	230	428	1,845	142	447		
11:15	256		55		205		66		461		121			
11:30	262		42		216		54		478		96			
11:45	236		48		242		40		478		88			
Totals	6,193		11,901		7,626		10,297		13,819		22,198			
Split%	44.8		53.6		55.2		46.4							
Day Totals		18,094				17,923				36,017				
Day Splits		50.2				49.8								
Peak Hour	07:15		04:15		07:15		05:00		07:15		04:30			
Volume	1,088		1,576		1,638		1,274		2,726		2,795			
Factor	0.91		0.96		0.95		0.94		0.98		0.98			

Transportation Studies, Inc.

2640 Walnut Avenue, Suite L
Tustin, CA. 92780

Location : BRISTOL STREET
Segment : SEVENTEENTH ST TO SANTA CLARA
Client : CITY SANTA ANA

Site: SANTA ANA
Date: 09/17/19

Interval	SB			NB			Combined		Day:	Tuesday		
	AM	PM		AM	PM		AM	PM				
12:00	64	227	298	1.112	56	165	289	1.182	120	392	587	2.294
12:15	70		248		52		274		122		522	
12:30	39		288		23		321		62		609	
12:45	54		278		34		298		88		576	
01:00	58	179	274	1.147	22	111	312	1.288	80	290	586	2.435
01:15	48		288		27		316		75		604	
01:30	34		285		34		318		68		603	
01:45	39		300		28		342		67		642	
02:00	34	126	258	1.153	31	104	316	1.023	65	230	574	2.176
02:15	22		301		26		237		48		538	
02:30	36		292		24		214		60		506	
02:45	34		302		23		256		57		558	
03:00	28	102	340	1.457	28	173	257	1.238	56	275	597	2.695
03:15	22		363		34		231		56		594	
03:30	26		368		51		366		77		734	
03:45	26		386		60		384		86		770	
04:00	34	264	433	1.692	74	513	394	1.532	108	777	827	3.224
04:15	58		398		113		372		171		770	
04:30	74		422		158		400		232		822	
04:45	98		439		168		366		266		805	
05:00	82	514	412	1.684	179	919	440	1.645	261	1,433	852	3,329
05:15	113		454		226		406		339		860	
05:30	153		416		280		411		433		827	
05:45	166		402		234		388		400		790	
06:00	218	1,213	361	1.392	226	1,104	346	1.477	444	2,317	707	2,869
06:15	237		352		246		385		483		737	
06:30	356		358		332		386		688		744	
06:45	402		321		300		360		702		681	
07:00	388	1,469	296	1.065	288	1,307	354	1,254	676	2,776	650	2,319
07:15	344		284		290		322		634		606	
07:30	366		258		358		276		724		534	
07:45	371		227		371		302		742		529	
08:00	482	1,851	218	875	354	1,301	258	1,026	836	3,152	476	1,901
08:15	471		232		332		260		803		492	
08:30	455		238		302		238		757		476	
08:45	443		187		313		270		756		457	
09:00	324	1,360	225	866	278	1,036	264	949	602	2,396	489	1,815
09:15	328		224		260		252		588		476	
09:30	354		217		248		215		602		432	
09:45	354		200		250		218		604		418	
10:00	318	1,082	174	605	239	982	212	561	557	2,064	386	1,166
10:15	274		174		248		157		522		331	
10:30	244		133		250		102		494		235	
10:45	246		124		245		90		491		214	
11:00	268	1,061	142	472	242	1,122	84	244	510	2,183	226	716
11:15	261		128		262		66		523		194	
11:30	258		96		306		58		564		154	
11:45	274		106		312		36		586		142	
Totals	9,448		13,520		8,837		13,419		18,285		26,939	
Split%	51.7		50.2		48.3		49.8					
Day Totals		22,968				22,256				45,224		
Day Splits		50.8				49.2						
Peak Hour	08:00		04:30		07:30		05:00		08:00		04:45	
Volume	1,851		1,727		1,415		1,645		3,152		3,344	
Factor	0.96		0.95		0.95		0.93		0.94		0.97	

ADT20 SEVENTEENTH ST from COLLEGE AVE to BRISTOL ST. Prepared by AimTD tel. 714 753 7888

AM Period	NB	SB	EB	WB	PM Period	NB	SB	EB	WB						
0:30			10	34	12:00			178	356						
0:15			12	27	12:15			290	245						
0:30			9	20	12:30			286	251						
0:45			11	42	12:45			301	1155						
1:00			13	23	13:00			303	267						
1:15			10	15	13:15			298	242						
1:30			8	16	13:30			285	246						
1:45			7	38	13:45			274	1160						
2:00			6	10	14:00			296	286						
2:15			8	9	14:15			314	275						
2:30			11	12	14:30			348	258						
2:45			7	32	14:45			332	1290						
3:00			10	12	15:00			326	304						
3:15			12	14	15:15			325	321						
3:30			13	9	15:30			336	313						
3:45			17	52	15:45			342	1323						
4:00			22	15	16:00			326	343						
4:15			32	13	16:15			358	356						
4:30			33	18	16:30			339	324						
4:45			29	116	16:45			346	1369						
5:00			56	17	17:00			314	359						
5:15			102	24	17:15			380	356						
5:30			98	51	17:30			419	364						
5:45			105	361	17:45			439	1532						
6:00			127	75	18:00			377	321						
6:15			170	93	18:15			384	303						
6:30			229	84	18:30			352	297						
6:45			330	856	18:45			313	1426						
7:00			392	152	19:00			291	284						
7:15			460	195	19:15			352	352						
7:30			428	266	19:30			213	234						
7:45			361	1641	19:45			229	988						
8:00			393	234	20:00			186	210						
8:15			368	201	20:15			175	185						
8:30			374	173	20:30			191	178						
8:45			353	1488	20:45			179	729						
9:00			344	203	21:00			190	201						
9:15			360	183	21:15			203	194						
9:30			332	198	21:30			173	165						
9:45			318	1354	21:45			145	711						
10:00			286	216	22:00			113	114						
10:15			273	205	22:15			94	95						
10:30			263	200	22:30			65	75						
10:45			279	1101	22:45			43	315						
11:00			309	217	23:00			24	68						
11:15			314	246	23:15			18	45						
11:30			303	237	23:30			23	47						
11:45			293	1217	23:45			15	80						
Total Vol.			8298	5094	13392			12098	11485	23583					
								Daily Totals							
								NB	SB	EB	WB	Combined			
										20396	16579	36975			
										AM	PM				
Split %										62.0%	38.0%	36.2%	51.3%	48.7%	63.8%
Peak Hour	0:30	0:30			7:15	11:45	7:15			17:30	16:45	17:15			
Volume					1642	980	2615			1619	1454	2968			
P.H.F.					0.89	0.96	0.94			0.92	0.97	0.95			

Transportation Studies, Inc.

2640 Walnut Avenue, Suite L
Tustin, CA. 92780

Location : BRISTOL STREET
Segment : CIVIC CENTER DR TO SEVENTEENTH
Client : CITY SANTA ANA

Site: SANTA ANA
Date: 09/17/19

Interval	NB				SB				Combined				Day:	Tuesday
	AM		PM		AM		PM		AM		PM			
12:00	71	177	288	1.161	56	212	288	1.028	127	389	576	2.189		
12:15	48		274		64		254		112		528			
12:30	26		297		42		242		68		539			
12:45	32		302		50		244		82		546			
01:00	38	118	270	1.194	44	146	256	1.124	82	264	526	2.318		
01:15	26		308		42		280		68		588			
01:30	27		300		26		308		53		608			
01:45	27		316		34		280		61		596			
02:00	36	113	318	1.221	30	115	262	1.084	66	228	580	2.305		
02:15	34		315		24		230		58		545			
02:30	18		322		30		256		48		578			
02:45	25		266		31		336		56		602			
03:00	30	179	314	1.333	28	103	286	1.138	58	282	600	2.471		
03:15	40		308		23		278		63		586			
03:30	45		353		28		274		73		627			
03:45	64		358		24		300		88		658			
04:00	64	432	356	1.479	32	233	340	1.221	96	665	696	2.700		
04:15	88		373		52		277		140		650			
04:30	126		374		71		266		197		640			
04:45	154		376		78		338		232		714			
05:00	168	772	359	1.535	75	451	294	1.211	243	1,223	653	2.746		
05:15	190		418		88		332		278		750			
05:30	214		366		150		290		364		656			
05:45	200		392		138		295		338		687			
06:00	190	1.082	364	1.510	177	946	298	1.021	367	2.028	662	2.531		
06:15	270		408		191		204		461		612			
06:30	292		372		266		264		558		636			
06:45	330		366		312		255		642		621			
07:00	302	1.451	346	1.228	342	1.366	226	926	644	2.817	572	2.154		
07:15	376		302		356		252		732		554			
07:30	398		282		342		228		740		510			
07:45	375		298		326		220		701		518			
08:00	356	1.262	225	904	336	1.343	200	863	692	2.605	425	1.767		
08:15	334		233		314		219		648		452			
08:30	310		220		356		210		666		430			
08:45	262		226		337		234		599		460			
09:00	264	1.064	204	762	287	1,164	240	933	551	2,228	444	1,695		
09:15	272		194		288		222		560		416			
09:30	276		178		292		258		568		436			
09:45	252		186		297		213		549		399			
10:00	283	1.016	136	445	309	1,056	206	629	592	2,072	342	1,074		
10:15	245		118		275		179		520		297			
10:30	236		99		234		128		470		227			
10:45	252		92		238		116		490		208			
11:00	210	1.121	84	275	252	1,033	133	409	462	2,154	217	684		
11:15	278		87		260		112		538		199			
11:30	341		48		233		80		574		128			
11:45	292		56		288		84		580		140			
Totals	8,787		13,047		8,168		11,587		16,955		24,634			
Split%	51.8		53.0		48.2		47.0							
Day Totals		21,834				19,755				41,589				
Day Splits		52.5				47.5								
Peak Hour	07:15		05:15		07:00		04:45		07:15		04:45			
Volume	1,505		1,540		1,366		1,254		2,865		2,773			
Factor	0.95		0.92		0.96		0.93		0.97		0.92			

Transportation Studies, Inc.

2640 Walnut Avenue, Suite L
Tustin, CA. 92780

Location : FAIRVIEW STREET
Segment : SEVENTEENTH ST TO TRASK AVE
Client : CITY SANTA ANA

Site: SANTA ANA
Date: 10/01/19

Interval	NB				SB				Combined				Day:	Tuesday
	AM		PM		AM		PM		AM		PM			
12:00	46	143	238	970	59	202	228	919	105	345	466	1.889		
12:15	46		246		55		232		101		478			
12:30	23		238		48		204		71		442			
12:45	28		248		40		255		68		503			
01:00	24	109	225	1.056	38	131	214	968	62	240	439	2.024		
01:15	29		258		36		234		65		492			
01:30	26		276		22		226		48		502			
01:45	30		297		35		294		65		591			
02:00	18	81	324	1.416	30	88	268	1.189	48	169	592	2.605		
02:15	19		322		26		311		45		633			
02:30	21		380		13		276		34		656			
02:45	23		390		19		334		42		724			
03:00	30	178	379	1.461	20	107	342	1.267	50	285	721	2.728		
03:15	38		334		19		298		57		632			
03:30	68		374		42		310		110		684			
03:45	42		374		26		317		68		691			
04:00	78	443	390	1.560	39	261	315	1.248	117	704	705	2.808		
04:15	74		380		46		297		120		677			
04:30	144		394		78		304		222		698			
04:45	147		396		98		332		245		728			
05:00	167	819	420	1.635	102	634	338	1.280	269	1,453	758	2,915		
05:15	202		404		132		336		334		740			
05:30	246		419		186		318		432		737			
05:45	204		392		214		288		418		680			
06:00	234	1.037	385	1.489	215	1.070	302	1.144	449	2.107	687	2.633		
06:15	223		390		220		290		443		680			
06:30	286		388		287		288		573		676			
06:45	294		326		348		264		642		590			
07:00	296	1.230	362	1.197	359	1.401	225	908	655	2.631	587	2.105		
07:15	302		304		322		264		624		568			
07:30	322		279		358		202		680		481			
07:45	310		252		362		217		672		469			
08:00	357	1.108	238	805	390	1.327	208	728	747	2.435	446	1.533		
08:15	285		189		363		201		648		390			
08:30	256		186		306		146		562		332			
08:45	210		192		268		173		478		365			
09:00	184	851	188	728	274	1,156	188	636	458	2,007	376	1,364		
09:15	245		200		280		145		525		345			
09:30	197		189		288		150		485		339			
09:45	225		151		314		153		539		304			
10:00	236	917	128	413	252	907	147	489	488	1,824	275	902		
10:15	218		104		249		140		467		244			
10:30	226		95		204		94		430		189			
10:45	237		86		202		108		439		194			
11:00	197	908	84	261	213	863	94	294	410	1,771	178	555		
11:15	213		60		189		65		402		125			
11:30	228		69		216		72		444		141			
11:45	270		48		245		63		515		111			
Totals	7.824		12.991		8.147		11.070		15.971		24.061			
Split%	49.0		54.0		51.0		46.0							
Day Totals		20.815				19.217				40.032				
Day Splits		52.0				48.0								
Peak Hour	07:15		04:45		07:30		04:45		07:30		04:45			
Volume	1,291		1,639		1,473		1,324		2,747		2,963			
Factor	0.90		0.98		0.94		0.98		0.92		0.98			

Transportation Studies, Inc.

2640 Walnut Avenue, Suite L
Tustin, CA. 92780

Location : BRISTOL STREET
Segment : MCFADDEN AVE TO FIRST ST
Client : CITY SANTA ANA

Site: SANTA ANA
Date: 09/17/19

Interval	NB				SB				Combined		Day:	Tuesday
	AM		PM		AM		PM		AM	PM		
12:00	62	173	240	1.016	59	185	264	962	121	358	504	1.978
12:15	47		238		55		224		102		462	
12:30	30		253		37		230		67		483	
12:45	34		285		34		244		68		529	
01:00	32	114	234	1.114	44	135	202	943	76	249	436	2.057
01:15	24		302		38		218		62		520	
01:30	22		290		26		246		48		536	
01:45	36		288		27		277		63		565	
02:00	32	120	294	1.312	21	111	275	1.107	53	231	569	2.419
02:15	32		318		23		242		55		560	
02:30	29		324		27		306		56		630	
02:45	27		376		40		284		67		660	
03:00	27	136	412	1.701	26	107	316	1.282	53	243	728	2.983
03:15	33		468		17		342		50		810	
03:30	28		425		30		305		58		730	
03:45	48		396		34		319		82		715	
04:00	52	264	424	1.730	39	279	318	1.381	91	543	742	3.111
04:15	52		444		62		350		114		794	
04:30	84		435		100		338		184		773	
04:45	76		427		78		375		154		802	
05:00	117	493	432	1.778	94	499	360	1.504	211	992	792	3.282
05:15	112		448		82		394		194		842	
05:30	130		441		156		366		286		807	
05:45	134		457		167		384		301		841	
06:00	130	756	441	1.644	176	1.016	338	1.262	306	1.772	779	2.906
06:15	172		439		188		326		360		765	
06:30	216		393		264		296		480		689	
06:45	238		371		388		302		626		673	
07:00	239	1.371	346	1.289	412	1.829	262	1.004	651	3.200	608	2.293
07:15	352		344		484		296		836		640	
07:30	420		310		465		226		885		536	
07:45	360		289		468		220		828		509	
08:00	343	1.240	263	953	430	1.719	208	819	773	2.959	471	1.772
08:15	300		263		435		195		735		458	
08:30	292		189		446		227		738		416	
08:45	305		238		408		189		713		427	
09:00	208	872	168	677	265	1.107	223	820	473	1.979	391	1.497
09:15	220		190		260		191		480		381	
09:30	240		171		301		220		541		391	
09:45	204		148		281		186		485		334	
10:00	230	862	161	519	277	998	158	537	507	1,860	319	1,056
10:15	210		130		238		149		448		279	
10:30	216		110		240		122		456		232	
10:45	206		118		243		108		449		226	
11:00	205	967	78	286	218	942	82	306	423	1.909	160	592
11:15	254		76		227		96		481		172	
11:30	256		66		222		64		478		130	
11:45	252		66		275		64		527		130	
Totals	7,368		14,019		8,927		11,927		16,295		25,946	
Split%	45.2		54.0		54.8		46.0					
Day Totals		21,387			20,854				42,241			
Day Splits		50.6			49.4							
Peak Hour	07:15		05:15		07:15		05:00		07:15		05:00	
Volume	1,475		1,787		1,847		1,504		3,322		3,282	
Factor	0.88		0.98		0.95		0.95		0.94		0.97	

Transportation Studies, Inc.

2640 Walnut Avenue, Suite L
Tustin, CA. 92780

Location : CIVIC CENTER DRIVE
Segment : BRISTOL ST TO FLOWER ST
Client : CITY SANTA ANA

Site: SANTA ANA
Date: 09/18/19

Interval	EB				WB				Combined				Day:	Wednesday
	AM		PM		AM		PM		AM		PM			
12:00	13	36	98	441	8	42	139	489	21	78	237	930		
12:15	8		97		13		122		21		219			
12:30	9		118		8		138		17		256			
12:45	6		128		13		90		19		218			
01:00	7	23	132	549	4	33	96	593	11	56	228	1,142		
01:15	10		152		12		156		22		308			
01:30	3		145		15		186		18		331			
01:45	3		120		2		155		5		275			
02:00	6	21	122	507	5	19	129	572	11	40	251	1,079		
02:15	4		130		6		129		10		259			
02:30	5		119		4		132		9		251			
02:45	6		136		4		182		10		318			
03:00	6	27	190	635	6	24	146	645	12	51	336	1,280		
03:15	3		151		3		163		6		314			
03:30	9		160		12		170		21		330			
03:45	9		134		3		166		12		300			
04:00	7	65	154	588	7	60	206	859	14	125	360	1,447		
04:15	11		138		7		181		18		319			
04:30	19		140		26		234		45		374			
04:45	28		156		20		238		48		394			
05:00	30	171	166	659	24	129	273	969	54	300	439	1,628		
05:15	45		157		22		246		67		403			
05:30	41		168		28		250		69		418			
05:45	55		168		55		200		110		368			
06:00	67	425	156	501	58	310	198	573	125	735	354	1,074		
06:15	83		130		58		140		141		270			
06:30	119		134		84		121		203		255			
06:45	156		81		110		114		266		195			
07:00	175	1,064	94	316	120	867	88	353	295	1,931	182	669		
07:15	282		80		213		86		495		166			
07:30	293		82		258		92		551		174			
07:45	314		60		276		87		590		147			
08:00	240	836	62	240	196	571	78	260	436	1,407	140	500		
08:15	243		61		177		74		420		135			
08:30	189		57		110		50		299		107			
08:45	164		60		88		58		252		118			
09:00	104	396	61	196	76	299	66	200	180	695	127	396		
09:15	96		64		64		40		160		104			
09:30	92		40		76		46		168		86			
09:45	104		31		83		48		187		79			
10:00	70	322	40	122	90	324	45	127	160	646	85	249		
10:15	82		33		68		34		150		67			
10:30	102		27		76		28		178		55			
10:45	68		22		90		20		158		42			
11:00	74	354	16	53	99	470	23	80	173	824	39	133		
11:15	72		9		111		22		183		31			
11:30	88		12		128		20		216		32			
11:45	120		16		132		15		252		31			
Totals	3,740		4,807		3,148		5,720		6,888		10,527			
Split%	54.3		45.7		45.7		54.3							
Day Totals		8,547				8,868				17,415				
Day Splits		49.1				50.9								
Peak Hour	07:15		05:00		07:15		04:45		07:15		04:45			
Volume	1,129		659		943		1,007		2,072		1,654			
Factor	0.90		0.98		0.85		0.92		0.88		0.94			

Transportation Studies, Inc.

2640 Walnut Avenue, Suite L
Tustin, CA. 92780

Location : FLOWER STREET
Segment : MCFADDEN AVE TO FIRST ST
Client : CITY SANTA ANA

Site: SANTA ANA
Date: 09/10/19

Interval	NB				SB				Combined				Day:	Tuesday
	AM		PM		AM		PM		AM		PM			
12:00	22	58	65	330	24	82	69	305	46	140	134	635		
12:15	13		88		15		76		28		164			
12:30	12		92		18		82		30		174			
12:45	11		85		25		78		36		163			
01:00	6	29	76	370	12	44	78	332	18	73	154	702		
01:15	16		83		8		70		24		153			
01:30	5		101		10		93		15		194			
01:45	2		110		14		91		16		201			
02:00	5	17	100	575	11	37	100	438	16	54	200	1,013		
02:15	5		150		9		110		14		260			
02:30	1		169		9		98		10		267			
02:45	6		156		8		130		14		286			
03:00	8	34	174	682	6	38	158	531	14	72	332	1,213		
03:15	5		178		7		120		12		298			
03:30	8		164		14		121		22		285			
03:45	13		166		11		132		24		298			
04:00	15	86	172	729	9	76	136	536	24	162	308	1,265		
04:15	20		187		11		124		31		311			
04:30	29		190		24		140		53		330			
04:45	22		180		32		136		54		316			
05:00	44	230	175	788	28	205	142	543	72	435	317	1,331		
05:15	54		220		46		132		100		352			
05:30	62		186		70		130		132		316			
05:45	70		207		61		139		131		346			
06:00	70	365	209	754	54	332	134	490	124	697	343	1,244		
06:15	81		197		92		106		173		303			
06:30	96		190		96		132		192		322			
06:45	118		158		90		118		208		276			
07:00	122	627	122	404	112	498	96	383	234	1,125	218	787		
07:15	196		105		128		96		324		201			
07:30	182		96		126		96		308		192			
07:45	127		81		132		95		259		176			
08:00	156	519	90	309	137	548	80	297	293	1,067	170	606		
08:15	124		83		133		82		257		165			
08:30	133		64		142		74		275		138			
08:45	106		72		136		61		242		133			
09:00	76	293	60	217	82	306	82	276	158	599	142	493		
09:15	75		61		64		62		139		123			
09:30	68		49		74		68		142		117			
09:45	74		47		86		64		160		111			
10:00	68	283	35	144	62	293	60	195	130	576	95	339		
10:15	62		42		78		49		140		91			
10:30	77		39		72		51		149		90			
10:45	76		28		81		35		157		63			
11:00	53	283	25	84	76	322	52	150	129	605	77	234		
11:15	73		27		89		43		162		70			
11:30	77		19		77		25		154		44			
11:45	80		13		80		30		160		43			
Totals	2,824		5,386		2,781		4,476		5,605		9,862			
Split%	50.4		54.6		49.6		45.4							
Day Totals		8,210				7,257				15,467				
Day Splits		53.1				46.9								
Peak Hour	07:15		05:15		08:00		04:30		07:15		05:15			
Volume	661		822		548		550		1,184		1,357			
Factor	0.84		0.93		0.96		0.97		0.91		0.96			

Thursday, October 03, 2019

Location: Santa Ana

PROJECT:

ADT167 MAIN ST from SEVENTEENTH ST to SANTA CLARA AVE.

Prepared by AimTD tel. 714 253 7888

AM Period	NB	SB	EB	WB	PM Period	NB	SB	EB	WB
0:00	58	42			12:00	227	212		
0:15	53	30			12:15	236	221		
0:30	54	41			12:30	224	230		
0:45	36	201	35	148	12:45	239	926	219	882
1:00	46	29			13:00	268	218		
1:15	35	28			13:15	266	224		
1:30	27	26			13:30	241	205		
1:45	21	129	22	105	13:45	267	1042	197	844
2:00	34	20			14:00	274	198		
2:15	41	34			14:15	257	201		
2:30	30	25			14:30	286	213		
2:45	26	131	21	100	14:45	272	1089	219	831
3:00	21	16			15:00	269	216		
3:15	25	12			15:15	327	234		
3:30	30	8			15:30	312	265		
3:45	32	108	11	47	15:45	313	1221	255	970
4:00	35	12			16:00	306	233		
4:15	56	21			16:15	341	238		
4:30	76	32			16:30	335	295		
4:45	87	254	38	103	16:45	291	1273	248	1014
5:00	101	40			17:00	286	254		
5:15	99	62			17:15	295	266		
5:30	137	64			17:30	321	267		
5:45	144	481	98	264	17:45	309	1211	270	1057
6:00	137	114			18:00	326	253		
6:15	142	157			18:15	335	246		
6:30	161	234			18:30	320	216		
6:45	159	599	291	796	18:45	284	1265	204	919
7:00	187	318			19:00	260	180		
7:15	214	278			19:15	256	160		
7:30	204	258			19:30	240	139		
7:45	267	872	269	1123	19:45	222	978	109	588
8:00	234	298			20:00	197	125		
8:15	213	276			20:15	195	118		
8:30	204	293			20:30	178	113		
8:45	202	853	258	1125	20:45	186	756	96	452
9:00	215	242			21:00	195	99		
9:15	186	223			21:15	175	90		
9:30	170	210			21:30	155	124		
9:45	182	753	201	876	21:45	138	663	106	419
10:00	195	197			22:00	116	87		
10:15	177	185			22:15	124	76		
10:30	171	175			22:30	99	64		
10:45	185	728	204	761	22:45	54	393	45	272
11:00	198	189			23:00	58	55		
11:15	213	195			23:15	62	47		
11:30	217	201			23:30	56	42		
11:45	235	863	214	799	23:45	70	246	53	197
Total Vol.	5972	6247		12219		11063	8445		19508
								Daily Totals	
						NB	SB	EB	WB
						17035	14692		31727
								PM	
Split %	48.9%	51.1%		38.5%		56.7%	43.3%		61.5%
Peak Hour	11:45	6:45		7:45		15:45	16:30		17:30
Volume	922	1145		2054		1295	1063		2327
P.H.F.	0.98	0.90		0.96		0.95	0.90		0.99

Transportation Studies, Inc.

2640 Walnut Avenue, Suite L
Tustin, CA. 92780

Location : CIVIC CENTER DRIVE
Segment : FLOWER ST TO ROSS ST
Client : CITY SANTA ANA

Site: SANTA ANA
Date: 09/18/19

Interval	WB				EB				Combined				Day:	Wednesday
	AM		PM		AM		PM		AM		PM			
12:00	10	48	122	473	17	53	148	517	27	101	270	990		
12:15	17		114		10		131		27		245			
12:30	15		122		12		116		27		238			
12:45	6		115		14		122		20		237			
01:00	9	27	128	640	12	37	137	580	21	64	265	1,220		
01:15	5		166		7		146		12		312			
01:30	10		170		12		178		22		348			
01:45	3		176		6		119		9		295			
02:00	4	10	142	510	1	22	149	622	5	32	291	1,132		
02:15	4		116		3		138		7		254			
02:30	0		122		15		144		15		266			
02:45	2		130		3		191		5		321			
03:00	5	18	120	524	7	19	215	712	12	37	335	1,236		
03:15	3		132		0		169		3		301			
03:30	4		140		4		174		8		314			
03:45	6		132		8		154		14		286			
04:00	6	48	172	710	6	46	172	827	12	94	344	1,537		
04:15	4		144		11		182		15		326			
04:30	13		202		12		231		25		433			
04:45	25		192		17		242		42		434			
05:00	24	113	276	929	21	131	248	760	45	244	524	1,689		
05:15	16		241		28		172		44		413			
05:30	23		240		40		162		63		402			
05:45	50		172		42		178		92		350			
06:00	52	255	174	490	53	366	163	568	105	621	337	1,058		
06:15	54		124		68		154		122		278			
06:30	56		98		114		138		170		236			
06:45	93		94		131		113		224		207			
07:00	112	755	69	285	140	807	92	302	252	1,562	161	587		
07:15	172		73		196		78		368		151			
07:30	224		78		214		80		438		158			
07:45	247		65		257		52		504		117			
08:00	238	750	66	220	218	682	66	233	456	1,432	132	453		
08:15	218		64		176		50		394		114			
08:30	153		42		140		50		293		92			
08:45	141		48		148		67		289		115			
09:00	100	376	39	178	102	440	47	158	202	816	86	336		
09:15	94		46		121		52		215		98			
09:30	100		47		116		35		216		82			
09:45	82		46		101		24		183		70			
10:00	87	335	32	101	94	402	26	101	181	737	58	202		
10:15	84		23		104		36		188		59			
10:30	74		28		103		21		177		49			
10:45	90		18		101		18		191		36			
11:00	102	397	17	64	106	555	14	58	208	952	31	122		
11:15	91		17		143		18		234		35			
11:30	88		15		150		14		238		29			
11:45	116		15		156		12		272		27			
Totals	3,132		5,124		3,560		5,438		6,692		10,562			
Split%	46.8		48.5		53.2		51.5							
Day Totals		8,256				8,998				17,254				
Day Splits		47.8				52.2								
Peak Hour	07:30		04:45		07:15		04:15		07:30		04:30			
Volume	927		949		885		903		1,792		1,804			
Factor	0.94		0.86		0.86		0.91		0.89		0.86			

Wednesday, October 02, 2019

Location: Santa Ana

PROJECT:

ADT208 SANTA ANA BLVD from FLOWER ST to ROSS ST.

Prepared by AimTD tel. 714 753 7888

AM Period	NB	SB	EB	WB	PM Period	NB	SB	EB	WB			
0:30			7	9	12:00			98	97			
0:15			8	11	12:15			86	89			
0:30			7	9	12:30			94	104			
0:45			2	24	13	42	66	106	384	108	398	782
1:00			1	10	13:00			89	123			
1:15			1	7	13:15			86	132			
1:30			0	6	13:30			95	105			
1:45			3	5	8	31	36	79	349	101	461	810
2:00			2	11	14:00			108	96			
2:15			0	7	14:15			89	95			
2:30			2	4	14:30			87	103			
2:45			3	7	2	24	31	97	381	123	417	798
3:00			6	5	15:00			102	127			
3:15			4	1	15:15			113	145			
3:30			2	0	15:30			103	153			
3:45			3	15	2	8	23	107	425	167	592	1017
4:00			6	4	16:00			123	159			
4:15			10	5	16:15			156	153			
4:30			13	3	16:30			178	163			
4:45			11	40	8	20	60	168	625	175	650	1275
5:00			16	12	17:00			156	213			
5:15			24	24	17:15			134	234			
5:30			29	36	17:30			121	204			
5:45			39	108	65	137	245	102	513	195	846	1359
6:00			54	64	18:00			97	172			
6:15			75	75	18:15			87	142			
6:30			86	78	18:30			103	104			
6:45			103	318	95	312	630	76	363	123	541	904
7:00			123	121	19:00			86	96			
7:15			189	158	19:15			78	86			
7:30			254	175	19:30			64	74			
7:45			304	870	145	599	1469	61	289	76	332	621
8:00			234	157	20:00			58	78			
8:15			153	134	20:15			53	61			
8:30			145	109	20:30			43	56			
8:45			126	658	89	489	1147	37	191	64	259	450
9:00			103	76	21:00			45	64			
9:15			100	89	21:15			35	43			
9:30			87	75	21:30			32	63			
9:45			95	385	78	318	703	40	152	53	223	375
10:00			76	100	22:00			28	47			
10:15			68	89	22:15			17	41			
10:30			79	96	22:30			23	36			
10:45			81	304	78	363	667	24	92	27	151	243
11:00			74	86	23:00			14	32			
11:15			89	75	23:15			8	18			
11:30			94	95	23:30			12	20			
11:45			90	347	99	355	702	11	45	16	86	131

Total Vol. 3081 2698 **5779** 3809 4956 **8765**

Daily Totals

NB	SB	EB	WB	Combined
		6890	7654	14544

AM

PM

Split % 53.3% 46.7% **39.7%** 43.5% 56.5% **60.3%**

Peak Hour	0:30	0:30	7:15	7:15	7:15	16:15	17:00	16:30
Volume			981	635	1616	658	846	1421
P.H.F.			0.81	0.91	0.90	0.92	0.90	0.96

Transportation Studies, Inc.

2640 Walnut Avenue, Suite L
Tustin, CA. 92780

Location : FIRST STREET
Segment : MAIN ST TO STANDARD AVE
Client : CITY SANTA ANA

Site: SANTA ANA
Date: 09/11/19

Interval	EB				WB				Combined				Day:	Wednesday
	AM		PM		AM		PM		AM		PM			
12:00	54	193	299	1,249	58	185	274	1,115	112	378	573	2,364		
12:15	49		306		52		282		101		588			
12:30	42		320		46		269		88		589			
12:45	48		324		29		290		77		614			
01:00	38	144	325	1,375	28	112	316	1,211	66	256	641	2,586		
01:15	32		362		34		248		66		610			
01:30	28		356		23		334		51		690			
01:45	46		332		27		313		73		645			
02:00	31	116	330	1,314	36	136	333	1,369	67	252	663	2,683		
02:15	31		324		34		326		65		650			
02:30	25		323		36		350		61		673			
02:45	29		337		30		360		59		697			
03:00	22	163	352	1,395	21	117	378	1,446	43	280	730	2,841		
03:15	37		356		24		360		61		716			
03:30	42		315		32		362		74		677			
03:45	62		372		40		346		102		718			
04:00	56	376	324	1,440	33	135	356	1,451	89	511	680	2,891		
04:15	86		362		26		368		112		730			
04:30	101		392		38		352		139		744			
04:45	133		362		38		375		171		737			
05:00	135	791	381	1,560	60	304	374	1,454	195	1,095	755	3,014		
05:15	162		380		61		358		223		738			
05:30	236		406		72		354		308		760			
05:45	258		393		111		368		369		761			
06:00	258	1,243	330	1,294	118	566	352	1,279	376	1,809	682	2,573		
06:15	286		338		134		313		420		651			
06:30	365		324		133		306		498		630			
06:45	334		302		181		308		515		610			
07:00	378	1,557	310	1,171	230	1,266	298	1,109	608	2,823	608	2,280		
07:15	394		339		311		273		705		612			
07:30	384		264		355		278		739		542			
07:45	401		258		370		260		771		518			
08:00	375	1,422	221	866	291	1,086	192	772	666	2,508	413	1,638		
08:15	384		213		276		208		660		421			
08:30	331		210		269		184		600		394			
08:45	332		222		250		188		582		410			
09:00	344	1,238	166	639	259	1,014	171	659	603	2,252	337	1,298		
09:15	322		183		213		162		535		345			
09:30	278		154		276		162		554		316			
09:45	294		136		266		164		560		300			
10:00	270	1,088	125	446	248	998	158	566	518	2,086	283	1,012		
10:15	270		118		242		140		512		258			
10:30	256		119		242		136		498		255			
10:45	292		84		266		132		558		216			
11:00	276	1,157	90	285	246	1,068	102	336	522	2,225	192	621		
11:15	270		69		268		80		538		149			
11:30	290		68		276		66		566		134			
11:45	321		58		278		88		599		146			
Totals	9,488		13,034		6,987		12,767		16,475		25,801			
Split%	57.6		50.5		42.4		49.5							
Day Totals		22,522				19,754				42,276				
Day Splits		53.3				46.7								
Peak Hour	07:00		05:00		07:15		04:15		07:15		05:00			
Volume	1,557		1,560		1,327		1,469		2,881		3,014			
Factor	0.97		0.96		0.90		0.98		0.93		0.99			

Transportation Studies, Inc.

2640 Walnut Avenue, Suite L
Tustin, CA. 92780

Location : GRAND AVENUE
Segment : SANTA CLARA AVE TO FAIRHAVEN
Client : CITY SANTA ANA

Site: SANTA ANA
Date: 09/12/19

Interval	NB				SB				Combined				Day:	Thursday
	AM		PM		AM		PM		AM		PM			
12:00	21	72	192	780	21	81	199	746	42	153	391	1,526		
12:15	15		200		27		177		42		377			
12:30	20		212		17		170		37		382			
12:45	16		176		16		200		32		376			
01:00	12	43	190	804	10	41	214	722	22	84	404	1,526		
01:15	11		213		12		156		23		369			
01:30	11		198		12		164		23		362			
01:45	9		203		7		188		16		391			
02:00	14	57	209	968	7	36	184	814	21	93	393	1,782		
02:15	16		234		12		202		28		436			
02:30	15		251		6		222		21		473			
02:45	12		274		11		206		23		480			
03:00	10	59	248	1,055	8	51	208	900	18	110	456	1,955		
03:15	12		244		14		254		26		498			
03:30	21		285		6		210		27		495			
03:45	16		278		23		228		39		506			
04:00	24	143	304	1,253	16	116	213	917	40	259	517	2,170		
04:15	32		307		26		226		58		533			
04:30	41		316		38		250		79		566			
04:45	46		326		36		228		82		554			
05:00	62	302	353	1,463	26	260	287	1,099	88	562	640	2,562		
05:15	62		332		56		294		118		626			
05:30	87		406		74		270		161		676			
05:45	91		372		104		248		195		620			
06:00	78	432	354	1,319	132	1,016	224	769	210	1,448	578	2,088		
06:15	96		360		199		172		295		532			
06:30	132		320		306		180		438		500			
06:45	126		285		379		193		505		478			
07:00	140	777	228	799	383	1,728	176	659	523	2,505	404	1,458		
07:15	192		214		414		178		606		392			
07:30	227		189		481		153		708		342			
07:45	218		168		450		152		668		320			
08:00	189	675	134	524	477	1,806	144	509	666	2,481	278	1,033		
08:15	170		128		469		134		639		262			
08:30	168		142		415		117		583		259			
08:45	148		120		445		114		593		234			
09:00	148	575	126	404	422	1,174	124	427	570	1,749	250	831		
09:15	125		102		274		111		399		213			
09:30	136		90		230		94		366		184			
09:45	166		86		248		98		414		184			
10:00	175	627	96	292	184	686	88	241	359	1,313	184	533		
10:15	156		84		184		54		340		138			
10:30	150		64		164		49		314		113			
10:45	146		48		154		50		300		98			
11:00	164	693	43	149	166	674	48	170	330	1,367	91	319		
11:15	160		46		152		42		312		88			
11:30	176		36		178		34		354		70			
11:45	193		24		178		46		371		70			
Totals	4,455		9,810		7,669		7,973		12,124		17,783			
Split%	36.7		55.2		63.3		44.8							
Day Totals		14,265				15,642				29,907				
Day Splits		47.7				52.3								
Peak Hour	07:15		05:30		07:30		05:00		07:30		05:00			
Volume	826		1,492		1,877		1,099		2,681		2,562			
Factor	0.91		0.92		0.98		0.93		0.95		0.95			

Transportation Studies, Inc.

2640 Walnut Avenue, Suite L
Tustin, CA. 92780

Location : GRAND AVENUE
Segment : FOURTH ST TO SANTA ANA BLVD
Client : CITY SANTA ANA

Site: SANTA ANA
Date: 09/12/19

Interval	NB				SB				Combined		Day:	Thursday
	AM		PM		AM		PM		AM	PM		
12:00	44	105	252	1.022	25	101	257	918	69	206	509	1.940
12:15	26		266		33		227		59		493	
12:30	15		250		24		237		39		487	
12:45	20		254		19		197		39		451	
01:00	27	103	292	1.179	23	84	242	842	50	187	534	2.021
01:15	20		270		21		187		41		457	
01:30	31		293		27		192		58		485	
01:45	25		324		13		221		38		545	
02:00	19	80	360	1.415	18	61	183	866	37	141	543	2.281
02:15	26		331		13		229		39		560	
02:30	22		336		10		204		32		540	
02:45	13		388		20		250		33		638	
03:00	14	103	386	1.579	13	85	224	872	27	188	610	2.451
03:15	27		379		14		218		41		597	
03:30	30		423		26		206		56		629	
03:45	32		391		32		224		64		615	
04:00	48	245	370	1.627	33	279	242	886	81	524	612	2.513
04:15	55		409		58		218		113		627	
04:30	62		398		80		212		142		610	
04:45	80		450		108		214		188		664	
05:00	95	492	442	1.780	85	614	224	947	180	1,106	666	2.727
05:15	110		462		134		271		244		733	
05:30	164		444		175		229		339		673	
05:45	123		432		220		223		343		655	
06:00	138	692	480	1.766	184	1,045	221	763	322	1,737	701	2.529
06:15	158		460		205		181		363		641	
06:30	206		410		260		175		466		585	
06:45	190		416		396		186		586		602	
07:00	225	1,055	350	1.080	384	1,448	176	605	609	2,503	526	1.685
07:15	260		270		382		148		642		418	
07:30	288		270		348		143		636		413	
07:45	282		190		334		138		616		328	
08:00	230	886	206	722	460	1,892	134	507	690	2,778	340	1.229
08:15	228		178		487		111		715		289	
08:30	224		180		499		142		723		322	
08:45	204		158		446		120		650		278	
09:00	210	912	141	564	257	1,028	123	448	467	1,940	264	1,012
09:15	226		144		316		115		542		259	
09:30	234		149		227		118		461		267	
09:45	242		130		228		92		470		222	
10:00	242	896	118	395	212	788	104	271	454	1,684	222	666
10:15	190		112		186		65		376		177	
10:30	225		85		194		46		419		131	
10:45	239		80		196		56		435		136	
11:00	264	1,003	63	219	182	877	44	168	446	1,880	107	387
11:15	245		62		237		48		482		110	
11:30	256		60		198		35		454		95	
11:45	238		34		260		41		498		75	
Totals	6,572		13,348		8,302		8,093		14,874		21,441	
Split%	44.2		62.3		55.8		37.7					
Day Totals		19,920				16,395				36,315		
Day Splits		54.9				45.1						
Peak Hour	07:15		05:15		08:00		05:00		08:00		05:15	
Volume	1,060		1,818		1,892		947		2,778		2,762	
Factor	0.92		0.95		0.95		0.87		0.96		0.94	

ADT218 SANTA CLARA AVE from GR to AVE to TUSTIN AVE.

Prepared by AimTD tel. 714 253 7888

AM Period	NB	SB	EB	WB	PM Period	NB	SB	EB	WB			
0:00			4	4	12:00			72	69			
0:15			8	3	12:15			77	73			
0:30			5	5	12:30			82	67			
0:45			3	20	3	15	35	69	300	87	296	596
1:00			6	5	13:00			82	66			
1:15			4	2	13:15			64	97			
1:30			2	3	13:30			88	85			
1:45			3	15	3	13	28	71	305	95	343	648
2:00			3	8	14:00			83	76			
2:15			0	0	14:15			95	81			
2:30			0	6	14:30			127	84			
2:45			2	5	0	14	19	108	413	88	329	742
3:00			4	2	15:00			93	99			
3:15			6	4	15:15			103	94			
3:30			3	6	15:30			110	97			
3:45			4	17	4	16	33	106	412	107	397	809
4:00			8	4	16:00			118	98			
4:15			6	4	16:15			110	115			
4:30			10	4	16:30			83	117			
4:45			16	40	11	23	63	115	426	113	443	869
5:00			11	16	17:00			117	136			
5:15			14	12	17:15			110	124			
5:30			28	26	17:30			144	136			
5:45			24	77	17	71	148	98	469	128	524	993
6:00			22	20	18:00			116	148			
6:15			42	34	18:15			92	98			
6:30			61	52	18:30			82	116			
6:45			49	174	58	164	338	77	367	87	449	816
7:00			70	61	19:00			52	79			
7:15			121	78	19:15			72	83			
7:30			119	108	19:30			68	53			
7:45			120	430	112	359	789	42	234	49	264	498
8:00			107	85	20:00			40	47			
8:15			92	67	20:15			55	25			
8:30			67	70	20:30			47	45			
8:45			77	343	68	290	633	35	177	39	156	333
9:00			81	57	21:00			48	34			
9:15			69	76	21:15			38	41			
9:30			72	54	21:30			28	27			
9:45			70	292	61	248	540	41	155	23	125	280
10:00			58	51	22:00			25	19			
10:15			80	61	22:15			25	19			
10:30			72	64	22:30			15	19			
10:45			65	275	62	238	513	19	84	19	76	160
11:00			61	51	23:00			15	18			
11:15			56	60	23:15			13	6			
11:30			82	68	23:30			8	6			
11:45			72	271	69	248	519	7	43	5	35	78

Total Vol. 1959 1699 **3658** 3385 3437 **6822**

Daily Totals				
NB	SB	EB	WB	Combined
		5344	5136	10480

	AM			PM		
Split %	53.6%	46.4%	34.9%	49.6%	50.4%	65.1%
Peak Hour	7:15	7:15	7:15	16:45	17:15	17:15
Volume	467	383	850	486	536	1004
P.H.F.	0.96	0.85	0.92	0.84	0.91	0.90

ADT258 TUSTIN AVE from SANTA CLARA AVE to FAIRHAVEN AVE.

Prepared by AimTD tel. 714 253 7888

AM Period	NB	SB	EB	WB	PM Period	NB	SB	EB	WB	
0:00	19	25			12:00	196	232			
0:15	17	18			12:15	257	239			
0:30	21	24			12:30	219	251			
0:45	21	78	16	83	12:45	262	934	279	1001	
					1935					
1:00	21	24			13:00	231	256			
1:15	9	14			13:15	246	221			
1:30	9	11			13:30	259	248			
1:45	9	48	4	53	13:45	272	1008	245	970	
					1978					
2:00	11	12			14:00	263	229			
2:15	11	11			14:15	280	248			
2:30	8	12			14:30	270	220			
2:45	8	38	10	45	14:45	286	1099	253	950	
					2049					
3:00	8	8			15:00	277	267			
3:15	2	8			15:15	279	300			
3:30	6	16			15:30	294	259			
3:45	20	36	16	48	15:45	318	1168	257	1083	
					2251					
4:00	9	14			16:00	366	275			
4:15	24	26			16:15	348	267			
4:30	25	36			16:30	388	272			
4:45	24	82	41	117	16:45	432	1534	271	1085	
					2619					
5:00	36	49			17:00	516	335			
5:15	50	58			17:15	437	307			
5:30	57	60			17:30	445	325			
5:45	69	212	110	277	17:45	429	1827	269	1236	
					3063					
6:00	68	157			18:00	477	283			
6:15	74	218			18:15	347	224			
6:30	97	410			18:30	300	211			
6:45	92	331	481	1266	18:45	310	1434	206	924	
					2358					
7:00	119	548			19:00	260	208			
7:15	125	663			19:15	243	185			
7:30	148	672			19:30	203	156			
7:45	175	567	682	2565	19:45	148	854	162	711	
					1565					
8:00	166	671			20:00	205	162			
8:15	161	665			20:15	145	142			
8:30	156	647			20:30	117	125			
8:45	164	647	572	2555	20:45	134	601	130	559	
					1160					
9:00	172	479			21:00	108	125			
9:15	152	349			21:15	130	94			
9:30	168	270			21:30	94	94			
9:45	169	661	278	1376	21:45	77	409	100	413	
					822					
10:00	177	241			22:00	89	83			
10:15	181	238			22:15	61	62			
10:30	165	231			22:30	66	41			
10:45	187	710	221	931	22:45	50	266	65	251	
					517					
11:00	211	203			23:00	69	49			
11:15	188	240			23:15	40	32			
11:30	189	201			23:30	34	33			
11:45	233	821	234	878	23:45	31	174	29	143	
					317					
Total Vol.	4231	10194			14425	11308	9326		20634	
						Daily Totals				
						NB	SB	EB	WB	Combined
						15539	19520			35059
AM					PM					
Split %	29.3%	70.7%			54.8%	45.2%			58.9%	
Peak Hour	11:45	7:30			16:45	16:45			16:45	
Volume	905	2690			1830	1238			3068	
P.H.F.	0.88	0.99			0.88	0.92			0.90	

Thursday, October 10, 2019

Location: Santa Ana

PROJECT:

ADT239 SEVENTEENTH ST from CABRILLO PARK DR to TUSTIN AVE.

Prepared by AimTD tel. 714 253 7888

AM Period	NB	SB	EB	WB	PM Period	NB	SB	EB	WB			
0:30			12	34	12:00			256	258			
0:15			15	23	12:15			262	290			
0:30			9	17	12:30			304	306			
0:45			8	44	19	93	137	256	1078	317	1171	2249
1:00			7	12	13:00			245	291			
1:15			10	14	13:15			215	295			
1:30			7	11	13:30			277	326			
1:45			9	33	8	45	78	244	981	283	1195	2176
2:00			7	10	14:00			283	278			
2:15			5	14	14:15			261	229			
2:30			10	16	14:30			258	263			
2:45			5	27	9	49	76	235	1037	293	1063	2100
3:00			7	8	15:00			252	276			
3:15			5	13	15:15			245	287			
3:30			9	15	15:30			250	263			
3:45			9	30	8	44	74	248	995	319	1145	2140
4:00			12	7	16:00			273	316			
4:15			15	13	16:15			319	276			
4:30			25	21	16:30			302	311			
4:45			41	93	27	68	161	313	1207	290	1193	2400
5:00			52	28	17:00			323	314			
5:15			67	41	17:15			356	313			
5:30			62	57	17:30			374	349			
5:45			68	249	54	180	429	309	1362	353	1329	2691
6:00			86	58	18:00			303	316			
6:15			104	70	18:15			256	332			
6:30			176	97	18:30			289	283			
6:45			197	563	134	359	922	259	1107	282	1213	2320
7:00			191	186	19:00			277	283			
7:15			189	201	19:15			226	265			
7:30			207	268	19:30			180	190			
7:45			224	811	218	873	1684	175	858	214	952	1810
8:00			251	234	20:00			165	155			
8:15			272	271	20:15			150	171			
8:30			261	262	20:30			116	156			
8:45			248	1032	256	1023	2055	118	549	127	609	1158
9:00			217	233	21:00			123	154			
9:15			208	198	21:15			104	127			
9:30			200	209	21:30			97	106			
9:45			195	820	194	834	1654	105	429	72	459	888
10:00			188	226	22:00			71	80			
10:15			213	228	22:15			79	86			
10:30			232	244	22:30			78	54			
10:45			217	850	194	892	1742	70	298	47	267	565
11:00			218	252	23:00			67	42			
11:15			238	235	23:15			45	53			
11:30			257	232	23:30			32	41			
11:45			242	955	238	957	1912	26	170	35	171	341

Total Vol. 5507 5417 **10924** 10071 10767 **20838**

Daily Totals				
NB	SB	EB	WB	Combined
		15578	16184	31762

	AM					PM		
Split %	50.4%	49.6%	34.4%			48.3%	51.7%	65.6%
Peak Hour	0:30	0:30	11:45	11:45	11:45	16:45	17:30	17:00
Volume			1064	1092	2156	1366	1350	2691
P.H.F.			0.88	0.89	0.88	0.91	0.96	0.93

Tuesday, September 24, 2019

CITY: Santa Ana

PROJECT: SC

ADT255 TUSTIN AVE from FOURTH ST to FRUIT ST.

Prepared by AimTD tel. 714 253 7888

AM Period	NB	SB	EB	WB	PM Period	NB	SB	EB	WB
0:00	12	11			12:00	197	198		
0:15	12	15			12:15	182	177		
0:30	12	12			12:30	192	195		
0:45	8	44	9	47	12:45	153	724	197	767
				91					1491
1:00	6	4			13:00	178	196		
1:15	9	11			13:15	189	202		
1:30	7	8			13:30	199	181		
1:45	7	29	4	27	13:45	204	770	154	733
				56					1503
2:00	5	7			14:00	185	162		
2:15	7	5			14:15	183	167		
2:30	3	7			14:30	192	153		
2:45	6	21	4	23	14:45	259	819	145	627
				44					1446
3:00	3	6			15:00	259	176		
3:15	8	13			15:15	264	196		
3:30	8	6			15:30	286	191		
3:45	9	28	5	30	15:45	269	1078	187	750
				58					1828
4:00	18	13			16:00	263	181		
4:15	24	10			16:15	316	152		
4:30	13	24			16:30	319	202		
4:45	24	79	25	72	16:45	311	1209	206	741
				151					1950
5:00	27	27			17:00	327	247		
5:15	41	26			17:15	317	205		
5:30	30	57			17:30	340	201		
5:45	41	139	49	159	17:45	371	1355	166	819
				298					2174
6:00	51	91			18:00	361	133		
6:15	65	130			18:15	332	110		
6:30	100	205			18:30	309	147		
6:45	102	318	216	642	18:45	296	1298	113	503
				960					1801
7:00	115	310			19:00	189	105		
7:15	119	309			19:15	166	115		
7:30	138	320			19:30	143	106		
7:45	164	536	329	1268	19:45	95	593	85	411
				1804					1004
8:00	245	354			20:00	96	74		
8:15	235	333			20:15	97	73		
8:30	199	337			20:30	91	84		
8:45	239	918	334	1358	20:45	73	357	62	293
				2276					650
9:00	183	266			21:00	60	74		
9:15	187	240			21:15	77	51		
9:30	153	197			21:30	82	61		
9:45	197	720	195	898	21:45	51	270	59	245
				1618					515
10:00	160	179			22:00	43	56		
10:15	178	159			22:15	44	40		
10:30	173	149			22:30	31	34		
10:45	154	665	129	616	22:45	32	150	27	157
				1281					307
11:00	161	170			23:00	30	27		
11:15	177	158			23:15	20	35		
11:30	173	198			23:30	24	29		
11:45	172	683	210	736	23:45	15	89	20	111
				1419					200
Total Vol.	4180	5876		10056		8712	6157		14869

Daily Totals				
NB	SB	EB	WB	Combined
12892	12033			24925

	AM			PM		
Split %	41.6%	58.4%	40.3%	58.6%	41.4%	59.7%
Peak Hour	8:00	8:00	8:00	17:30	16:30	17:00
Volume	918	1358	2276	1404	860	2174
P.H.F.	0.94	0.96	0.95	0.97	0.87	0.95

Transportation Studies, Inc.

2640 Walnut Avenue, Suite L
Tustin, CA. 92780

Location : FIRST STREET
Segment : GRAND AVE TO LYON ST
Client : CITY SANTA ANA

Site: SANTA ANA
Date: 09/10/19

Interval	EB				WB				Combined		Day:	Tuesday
	AM		PM		AM		PM		AM	PM		
12:00	24	74	158	612	58	186	220	963	82	260	378	1.575
12:15	15		153		49		260		64		413	
12:30	14		158		43		225		57		383	
12:45	21		143		36		258		57		401	
01:00	15	48	162	668	30	139	243	976	45	187	405	1.644
01:15	12		172		34		236		46		408	
01:30	5		174		42		241		47		415	
01:45	16		160		33		256		49		416	
02:00	8	43	180	870	24	101	246	1.084	32	144	426	1.954
02:15	10		192		24		248		34		440	
02:30	14		260		25		300		39		560	
02:45	11		238		28		290		39		528	
03:00	6	65	202	800	15	101	289	1.137	21	166	491	1.937
03:15	14		209		28		271		42		480	
03:30	16		177		18		321		34		498	
03:45	29		212		40		256		69		468	
04:00	25	180	206	859	31	157	307	1.301	56	337	513	2.160
04:15	37		218		38		300		75		518	
04:30	50		229		39		326		89		555	
04:45	68		206		49		368		117		574	
05:00	70	375	186	505	70	335	344	1.360	140	710	530	1.865
05:15	78		62		70		342		148		404	
05:30	91		91		83		354		174		445	
05:45	136		166		112		320		248		486	
06:00	126	581	196	749	130	637	288	1.026	256	1.218	484	1.775
06:15	144		188		129		268		273		456	
06:30	148		187		164		240		312		427	
06:45	163		178		214		230		377		408	
07:00	170	608	147	497	240	1.222	222	852	410	1.830	369	1.349
07:15	172		140		305		210		477		350	
07:30	132		106		324		222		456		328	
07:45	134		104		353		198		487		302	
08:00	140	602	98	379	294	1.041	180	635	434	1.643	278	1.014
08:15	146		110		272		163		418		273	
08:30	150		101		234		150		384		251	
08:45	166		70		241		142		407		212	
09:00	162	620	78	283	236	938	130	581	398	1.558	208	864
09:15	150		86		266		162		416		248	
09:30	160		53		208		140		368		193	
09:45	148		66		228		149		376		215	
10:00	164	613	68	202	211	880	124	450	375	1.493	192	652
10:15	158		48		216		132		374		180	
10:30	138		42		220		104		358		146	
10:45	153		44		233		90		386		134	
11:00	144	630	40	138	240	948	94	303	384	1.578	134	441
11:15	148		36		234		64		382		100	
11:30	170		32		232		69		402		101	
11:45	168		30		242		76		410		106	
Totals	4.439		6.562		6.685		10.668		11.124		17.230	
Split%	39.9		38.1		60.1		61.9					
Day Totals		11.001				17.353				28.354		
Day Splits		38.8				61.2						
Peak Hour	06:30		02:30		07:15		04:45		07:15		04:15	
Volume	653		909		1,276		1,408		1,854		2,177	
Factor	0.95		0.87		0.90		0.96		0.95		0.95	

Transportation Studies, Inc.

2640 Walnut Avenue, Suite L
Tustin, CA. 92780

Location : FIRST STREET
Segment : SANTA ANA FWY TO GOLDEN CIRCLE
Client : CITY SANTA ANA

Site: SANTA ANA
Date: 09/11/19

Interval	WB			EB			Combined		Day:	Wednesday		
	AM	PM		AM	PM		AM	PM				
12:00	22	85	132	605	21	78	212	691	43	163	344	1.296
12:15	31		148		24		162		55		310	
12:30	17		168		17		165		34		333	
12:45	15		157		16		152		31		309	
01:00	24	72	180	669	16	66	161	705	40	138	341	1.374
01:15	14		168		14		168		28		336	
01:30	17		158		19		186		36		344	
01:45	17		163		17		190		34		353	
02:00	18	54	172	664	20	56	164	732	38	110	336	1.396
02:15	17		164		12		166		29		330	
02:30	14		184		11		203		25		387	
02:45	5		144		13		199		18		343	
03:00	12	57	192	725	12	76	196	826	24	133	388	1.551
03:15	15		170		21		199		36		369	
03:30	14		169		19		203		33		372	
03:45	16		194		24		228		40		422	
04:00	14	80	222	795	21	135	188	871	35	215	410	1.666
04:15	14		177		29		232		43		409	
04:30	32		188		45		229		77		417	
04:45	20		208		40		222		60		430	
05:00	41	199	222	817	58	247	250	978	99	446	472	1.795
05:15	46		222		58		240		104		462	
05:30	54		186		44		228		98		414	
05:45	58		187		87		260		145		447	
06:00	62	354	194	654	90	448	251	860	152	802	445	1.514
06:15	69		170		90		224		159		394	
06:30	91		160		116		210		207		370	
06:45	132		130		152		175		284		305	
07:00	155	811	144	503	120	484	138	482	275	1,295	282	985
07:15	176		138		115		130		291		268	
07:30	240		119		136		122		376		241	
07:45	240		102		113		92		353		194	
08:00	192	787	94	342	172	742	102	400	364	1,529	196	742
08:15	216		94		186		92		402		186	
08:30	191		82		166		119		357		201	
08:45	188		72		218		87		406		159	
09:00	164	612	82	277	192	659	77	281	356	1,271	159	558
09:15	150		67		146		60		296		127	
09:30	160		62		157		78		317		140	
09:45	138		66		164		66		302		132	
10:00	140	497	66	218	130	533	56	205	270	1,030	122	423
10:15	127		57		143		61		270		118	
10:30	126		61		134		46		260		107	
10:45	104		34		126		42		230		76	
11:00	160	563	38	138	162	602	37	129	322	1,165	75	267
11:15	134		35		130		36		264		71	
11:30	123		27		162		26		285		53	
11:45	146		38		148		30		294		68	
Totals	4,171		6,407		4,126		7,160		8,297		13,567	
Split%	50.3		47.2		49.7		52.8					
Day Totals		10,578				11,286				21,864		
Day Splits		48.4				51.6						
Peak Hour	07:30		04:30		08:15		05:15		08:00		05:00	
Volume	888		840		762		979		1,529		1,795	
Factor	0.93		0.95		0.87		0.94		0.94		0.95	

Transportation Studies, Inc.

2640 Walnut Avenue, Suite L
Tustin, CA. 92780

Location : FAIRVIEW STREET
Segment : HARVARD AVE TO EDINGER AVE
Client : CITY SANTA ANA

Site: SANTA ANA
Date: 09/25/19

Interval	SB				NB				Combined		Day:	Wednesday
	AM		PM		AM		PM		AM	PM		
12:00	18	72	204	942	56	175	268	969	74	247	472	1.911
12:15	21		254		44		211		65		465	
12:30	16		236		41		246		57		482	
12:45	17		248		34		244		51		492	
01:00	10	52	247	991	29	106	282	1.237	39	158	529	2.228
01:15	10		227		35		280		45		507	
01:30	16		245		21		328		37		573	
01:45	16		272		21		347		37		619	
02:00	14	66	283	1.116	39	110	440	1.615	53	176	723	2.731
02:15	16		265		23		352		39		617	
02:30	18		290		12		426		30		716	
02:45	18		278		36		397		54		675	
03:00	12	135	246	886	25	99	406	1.781	37	234	652	2.667
03:15	23		232		21		402		44		634	
03:30	42		206		21		475		63		681	
03:45	58		202		32		498		90		700	
04:00	64	471	216	841	43	183	462	1.914	107	654	678	2.755
04:15	68		226		38		486		106		712	
04:30	139		195		44		467		183		662	
04:45	200		204		58		499		258		703	
05:00	127	816	210	867	60	329	502	1.913	187	1,145	712	2.780
05:15	167		224		76		470		243		694	
05:30	228		204		96		467		324		671	
05:45	294		229		97		474		391		703	
06:00	218	1.231	195	685	124	600	454	1.687	342	1.831	649	2.372
06:15	278		170		140		399		418		569	
06:30	332		178		160		460		492		638	
06:45	403		142		176		374		579		516	
07:00	400	1.487	130	509	275	1.278	324	1.115	675	2.765	454	1.624
07:15	428		154		276		283		704		437	
07:30	350		113		375		256		725		369	
07:45	309		112		352		252		661		364	
08:00	370	1.480	107	403	250	886	238	829	620	2.366	345	1.232
08:15	374		118		220		207		594		325	
08:30	390		82		208		190		598		272	
08:45	346		96		208		194		554		290	
09:00	253	988	94	324	210	824	217	765	463	1,812	311	1,089
09:15	271		88		190		206		461		294	
09:30	239		68		234		165		473		233	
09:45	225		74		190		177		415		251	
10:00	182	812	52	190	181	731	136	531	363	1,543	188	721
10:15	205		45		181		159		386		204	
10:30	215		49		195		140		410		189	
10:45	210		44		174		96		384		140	
11:00	195	787	54	146	196	841	86	337	391	1,628	140	483
11:15	197		32		196		97		393		129	
11:30	191		33		226		88		417		121	
11:45	204		27		223		66		427		93	
Totals	8,397		7,900		6,162		14,693		14,559		22,593	
Split%	57.7		35.0		42.3		65.0					
Day Totals		16.297				20.855				37.152		
Day Splits		43.9				56.1						
Peak Hour	06:45		02:00		07:00		04:15		07:00		04:15	
Volume	1,581		1,116		1,278		1,954		2,765		2,789	
Factor	0.92		0.96		0.85		0.97		0.95		0.98	

Transportation Studies, Inc.

2640 Walnut Avenue, Suite L
Tustin, CA. 92780

Location : FAIRVIEW STREET
Segment : SEGERSTROM AVE TO WARNER AVE
Client : CITY SANTA ANA

Site: SANTA ANA
Date: 10/09/19

Interval	NB				SB				Combined				Day:	Wednesday
	AM		PM		AM		PM		AM		PM			
12:00	51	162	218	888	22	96	239	996	73	258	457	1.884		
12:15	40		222		30		222		70		444			
12:30	38		222		25		265		63		487			
12:45	33		226		19		270		52		496			
01:00	25	90	292	1.227	11	47	262	1.092	36	137	554	2.319		
01:15	28		280		11		246		39		526			
01:30	19		310		14		284		33		594			
01:45	18		345		11		300		29		645			
02:00	17	87	394	1.627	22	81	292	1.070	39	168	686	2.697		
02:15	15		380		14		251		29		631			
02:30	19		394		16		279		35		673			
02:45	36		459		29		248		65		707			
03:00	21	77	418	1.738	24	176	277	1.111	45	253	695	2.849		
03:15	17		424		22		289		39		713			
03:30	17		428		56		277		73		705			
03:45	22		468		74		268		96		736			
04:00	26	152	518	1.919	58	435	267	1.071	84	587	785	2.990		
04:15	25		483		98		234		123		717			
04:30	46		474		128		276		174		750			
04:45	55		444		151		294		206		738			
05:00	60	292	470	1.933	116	856	270	1.071	176	1,148	740	3,004		
05:15	48		501		188		274		236		775			
05:30	96		486		269		267		365		753			
05:45	88		476		283		260		371		736			
06:00	86	482	434	1.618	264	1,511	243	879	350	1,993	677	2,497		
06:15	132		406		312		208		444		614			
06:30	132		434		420		228		552		662			
06:45	132		344		515		200		647		544			
07:00	192	983	302	1.032	490	2,095	232	743	682	3,078	534	1,775		
07:15	213		290		556		182		769		472			
07:30	293		228		555		179		848		407			
07:45	285		212		494		150		779		362			
08:00	219	829	190	726	549	2,197	138	558	768	3,026	328	1,284		
08:15	218		196		558		142		776		338			
08:30	196		160		557		152		753		312			
08:45	196		180		533		126		729		306			
09:00	214	782	156	616	374	1,270	94	405	588	2,052	250	1,021		
09:15	184		162		334		128		518		290			
09:30	198		154		284		109		482		263			
09:45	186		144		278		74		464		218			
10:00	192	720	156	522	192	900	74	243	384	1,620	230	765		
10:15	174		144		234		52		408		196			
10:30	176		128		234		50		410		178			
10:45	178		94		240		67		418		161			
11:00	167	778	76	276	213	875	38	149	380	1,653	114	425		
11:15	205		72		198		33		403		105			
11:30	209		66		220		41		429		107			
11:45	197		62		244		37		441		99			
Totals	5,434		14,122		10,539		9,388		15,973		23,510			
Split%	34.0		60.1		66.0		39.9							
Day Totals		19,556				19,927				39,483				
Day Splits		49.5				50.5								
Peak Hour	07:30		03:45		08:00		01:30		07:30		04:45			
Volume	1,015		1,943		2,197		1,127		3,171		3,006			
Factor	0.87		0.94		0.98		0.94		0.93		0.97			

ADT147 MacARTHUR BL from SUSAN ST to FAIRVIEW ST.

Prepared by AimTD tel. 714 253 7888

AM Period	NB	SB	EB	WB	PM Period	NB	SB	EB	WB			
0:30			16	15	12:00			217	153			
0:15			6	15	12:15			221	175			
0:30			9	14	12:30			213	145			
0:45			6	37	4	48	85	192	843	200	673	1516
1:00			7	6	13:00			191	187			
1:15			6	8	13:15			186	198			
1:30			13	5	13:30			217	199			
1:45			9	35	7	26	61	178	772	218	802	1574
2:00			6	4	14:00			210	215			
2:15			6	4	14:15			163	218			
2:30			11	0	14:30			259	210			
2:45			9	32	0	8	40	232	864	232	875	1739
3:00			18	6	15:00			220	315			
3:15			9	5	15:15			202	278			
3:30			21	6	15:30			232	290			
3:45			31	79	8	25	104	177	831	374	1257	2088
4:00			35	21	16:00			236	362			
4:15			25	10	16:15			235	385			
4:30			23	41	16:30			258	383			
4:45			42	125	64	136	261	234	963	386	1516	2479
5:00			35	32	17:00			313	414			
5:15			32	36	17:15			249	358			
5:30			62	62	17:30			262	341			
5:45			60	189	83	213	402	205	1029	407	1520	2549
6:00			62	55	18:00			219	379			
6:15			71	68	18:15			205	318			
6:30			129	73	18:30			180	240			
6:45			154	416	96	292	708	174	778	265	1202	1980
7:00			210	101	19:00			165	212			
7:15			246	127	19:15			131	162			
7:30			337	141	19:30			164	154			
7:45			390	1183	191	560	1743	104	564	135	663	1227
8:00			257	174	20:00			105	123			
8:15			336	132	20:15			127	81			
8:30			298	148	20:30			98	56			
8:45			291	1182	159	613	1795	96	426	86	346	772
9:00			219	144	21:00			106	85			
9:15			186	141	21:15			80	52			
9:30			169	142	21:30			74	51			
9:45			145	719	144	571	1290	57	317	34	222	539
10:00			143	142	22:00			64	55			
10:15			144	118	22:15			40	49			
10:30			158	139	22:30			41	34			
10:45			163	608	164	563	1171	33	178	29	167	345
11:00			180	117	23:00			40	25			
11:15			171	136	23:15			25	34			
11:30			165	152	23:30			19	26			
11:45			209	725	171	576	1301	11	95	26	111	206

Total Vol. 5330 3631 **8961** 7660 9354 **17014**

Daily Totals				
NB	SB	EB	WB	Combined
		12990	12985	25975

AM					PM				
Split %									
		59.5%	40.5%	34.5%		45.0%	55.0%	65.5%	
Peak Hour	0:30	0:30	7:30	11:30	7:30		16:45	16:15	16:15
Volume			1320	651	1958		1058	1568	2608
P.H.F.			0.85	0.93	0.84		0.85	0.95	0.90

Transportation Studies, Inc.

2640 Walnut Avenue, Suite L
Tustin, CA. 92780

Location : EDINGER AVENUE
Segment : FAIRVIEW ST TO RAITT ST
Client : CITY SANTA ANA

Site: SANTA ANA
Date: 09/17/19

Interval	EB				WB				Combined		Day:	Tuesday
	AM		PM		AM		PM		AM	PM		
12:00	35	112	166	666	34	104	172	665	69	216	338	1.331
12:15	32		158		22		160		54		318	
12:30	30		186		21		175		51		361	
12:45	15		156		27		158		42		314	
01:00	17	79	193	791	14	57	162	750	31	136	355	1.541
01:15	18		182		18		168		36		350	
01:30	30		202		12		194		42		396	
01:45	14		214		13		226		27		440	
02:00	8	45	194	961	8	55	202	865	16	100	396	1.826
02:15	8		229		14		204		22		433	
02:30	15		276		15		207		30		483	
02:45	14		262		18		252		32		514	
03:00	5	48	300	1.073	14	78	264	1.093	19	126	564	2.166
03:15	8		272		12		280		20		552	
03:30	16		231		20		273		36		504	
03:45	19		270		32		276		51		546	
04:00	24	163	298	1.053	22	199	284	1.197	46	362	582	2.250
04:15	31		234		33		308		64		542	
04:30	56		269		66		294		122		563	
04:45	52		252		78		311		130		563	
05:00	49	337	280	1.103	62	379	317	1.213	111	716	597	2.316
05:15	64		282		84		288		148		570	
05:30	104		276		116		287		220		563	
05:45	120		265		117		321		237		586	
06:00	105	624	251	951	100	558	296	1.112	205	1.182	547	2.063
06:15	146		224		134		292		280		516	
06:30	176		252		152		242		328		494	
06:45	197		224		172		282		369		506	
07:00	244	1.080	204	856	198	905	240	797	442	1.985	444	1.653
07:15	308		218		216		202		524		420	
07:30	273		238		239		196		512		434	
07:45	255		196		252		159		507		355	
08:00	222	900	236	796	218	727	166	645	440	1.627	402	1.441
08:15	238		197		169		188		407		385	
08:30	220		195		176		149		396		344	
08:45	220		168		164		142		384		310	
09:00	164	669	155	561	150	580	126	464	314	1,249	281	1,025
09:15	188		144		156		147		344		291	
09:30	172		120		138		109		310		229	
09:45	145		142		136		82		281		224	
10:00	150	620	105	328	153	644	99	311	303	1,264	204	639
10:15	146		94		174		81		320		175	
10:30	167		70		145		71		312		141	
10:45	157		59		172		60		329		119	
11:00	148	635	58	200	170	614	50	164	318	1,249	108	364
11:15	158		59		162		44		320		103	
11:30	151		42		148		39		299		81	
11:45	178		41		134		31		312		72	
Totals	5,312		9,339		4,900		9,276		10,212		18,615	
Split%	52.0		50.2		48.0		49.8					
Day Totals		14,651				14,176				28,827		
Day Splits		50.8				49.2						
Peak Hour	07:00		02:30		07:15		04:15		07:00		05:00	
Volume	1,080		1,110		925		1,230		1,985		2,316	
Factor	0.88		0.93		0.92		0.97		0.95		0.97	

Thursday, October 10, 2019

Location: Santa Ana

PROJECT:

ADT174 McFADDEN AVE from FAIRVIEW ST to RAITT ST.

Prepared by AimTD tel. 714 253 7888

AM Period	NB	SB	EB	WB	PM Period	NB	SB	EB	WB			
0:30			21	35	12:00			103	104			
0:15			29	24	12:15			113	123			
0:30			23	20	12:30			98	113			
0:45			19	92	13	92	184	110	424	130	470	894
1:00			16	9	13:00			140	109			
1:15			10	11	13:15			158	121			
1:30			11	13	13:30			148	132			
1:45			14	51	12	45	96	156	602	126	488	1090
2:00			13	8	14:00			136	129			
2:15			8	5	14:15			169	132			
2:30			7	10	14:30			174	157			
2:45			12	40	16	39	79	184	663	184	602	1265
3:00			13	11	15:00			221	183			
3:15			19	13	15:15			193	203			
3:30			12	14	15:30			176	191			
3:45			15	59	17	55	114	187	777	205	782	1559
4:00			10	23	16:00			208	195			
4:15			19	25	16:15			194	175			
4:30			29	23	16:30			187	179			
4:45			35	93	41	112	205	181	770	190	739	1509
5:00			39	53	17:00			195	204			
5:15			58	62	17:15			204	195			
5:30			73	78	17:30			213	222			
5:45			87	257	86	279	536	217	829	216	837	1666
6:00			85	84	18:00			223	230			
6:15			91	78	18:15			197	200			
6:30			106	82	18:30			186	207			
6:45			127	409	101	345	754	181	787	189	826	1613
7:00			140	123	19:00			198	186			
7:15			178	164	19:15			179	175			
7:30			219	189	19:30			187	156			
7:45			229	766	196	672	1438	161	725	140	657	1382
8:00			218	187	20:00			124	117			
8:15			186	159	20:15			115	103			
8:30			174	122	20:30			134	111			
8:45			157	735	103	571	1306	110	483	100	431	914
9:00			125	98	21:00			102	98			
9:15			130	104	21:15			98	104			
9:30			108	91	21:30			94	68			
9:45			114	477	100	393	870	85	379	95	365	744
10:00			100	93	22:00			77	61			
10:15			109	98	22:15			79	71			
10:30			115	101	22:30			67	52			
10:45			116	440	109	401	841	68	291	38	222	513
11:00			123	117	23:00			56	27			
11:15			131	108	23:15			52	35			
11:30			119	107	23:30			47	24			
11:45			99	472	115	447	919	32	187	25	111	298

Total Vol. 3891 3451 **7342** 6917 6530 **13447**

Daily Totals				
NB	SB	EB	WB	Combined
		10808	9981	20789

AM					PM				
Split %									
		53.0%	47.0%	35.3%		51.4%	48.6%	64.7%	
Peak Hour	0:30	0:30	7:30	7:15	7:30		17:15	17:30	17:15
Volume			852	736	1583		857	868	1720
P.H.F.			0.93	0.94	0.93		0.96	0.94	0.95

Thursday, October 03, 2019

Location: Santa Ana

PROJECT:

ADT148 MacARTHUR BL from FAIRVIEW ST to RAITT ST.

Prepared by AimTD tel. 714 253 7888

AM Period	NB	SB	EB	WB	PM Period	NB	SB	EB	WB			
0:30			13	17	12:00			199	185			
0:15			15	15	12:15			186	197			
0:30			12	13	12:30			170	183			
0:45			11	51	16	61	112	173	728	194	759	1487
1:00			7	12	13:00			168	199			
1:15			6	8	13:15			201	214			
1:30			8	11	13:30			234	221			
1:45			4	25	7	38	63	208	811	237	871	1682
2:00			4	5	14:00			206	264			
2:15			2	10	14:15			229	242			
2:30			8	11	14:30			312	278			
2:45			14	28	9	35	63	304	1051	341	1125	2176
3:00			13	6	15:00			281	359			
3:15			11	8	15:15			242	342			
3:30			15	12	15:30			235	336			
3:45			21	60	18	44	104	214	972	407	1444	2416
4:00			31	15	16:00			206	400			
4:15			34	23	16:15			211	395			
4:30			39	27	16:30			214	414			
4:45			46	150	37	102	252	231	862	463	1672	2534
5:00			42	43	17:00			240	486			
5:15			57	45	17:15			238	452			
5:30			76	41	17:30			242	463			
5:45			68	243	48	177	420	214	934	461	1862	2796
6:00			84	52	18:00			218	451			
6:15			96	50	18:15			196	355			
6:30			124	78	18:30			167	374			
6:45			206	510	107	287	797	139	720	311	1491	2211
7:00			241	112	19:00			156	273			
7:15			353	199	19:15			124	223			
7:30			429	266	19:30			127	184			
7:45			435	1458	343	920	2378	104	511	136	816	1327
8:00			407	257	20:00			118	104			
8:15			320	168	20:15			105	112			
8:30			356	152	20:30			94	85			
8:45			322	1405	131	708	2113	103	420	96	397	817
9:00			252	127	21:00			95	86			
9:15			153	132	21:15			100	75			
9:30			142	121	21:30			96	72			
9:45			145	692	136	516	1208	68	359	67	300	659
10:00			136	108	22:00			54	62			
10:15			127	114	22:15			46	54			
10:30			134	119	22:30			41	46			
10:45			125	522	127	468	990	34	175	41	203	378
11:00			135	157	23:00			31	36			
11:15			153	154	23:15			23	45			
11:30			188	152	23:30			17	34			
11:45			213	689	163	626	1315	12	83	28	143	226

Total Vol. 5833 3982 **9815** 7626 11083 **18709**

Daily Totals				
NB	SB	EB	WB	Combined
		13459	15065	28524

AM					PM					
Split %										
	59.4%	40.6%	34.4%		40.8%	59.2%	65.6%			
Peak Hour	0:30	0:30	7:15	7:15	7:15			14:30	16:45	16:45
Volume			1624	1065	2689			1139	1864	2815
P.H.F.			0.93	0.78	0.86			0.91	0.96	0.97

cs@aimtd.com

Tell. 714 253 7888

ADT222 SEGERSTROM AVE from FAIRVIEW ST to RAITT ST.

Prepared by AimTD tel. 714 753 7888

AM Period	NB	SB	EB	WB	PM Period	NB	SB	EB	WB			
0:30			34	35	12:00			94	89			
0:15			37	32	12:15			86	101			
0:30			26	29	12:30			68	85			
0:45			31	128	31	127	255	71	319	88	363	682
1:00			34	25	13:00			75	108			
1:15			26	21	13:15			78	93			
1:30			18	22	13:30			85	95			
1:45			20	98	19	87	185	104	342	113	409	751
2:00			19	17	14:00			87	105			
2:15			10	10	14:15			78	104			
2:30			11	12	14:30			90	101			
2:45			5	45	6	45	90	86	341	105	415	756
3:00			3	8	15:00			96	112			
3:15			5	7	15:15			105	103			
3:30			4	6	15:30			108	123			
3:45			6	18	11	32	50	110	419	147	485	904
4:00			7	12	16:00			106	139			
4:15			6	10	16:15			114	167			
4:30			4	9	16:30			195	184			
4:45			8	25	8	39	64	175	590	271	761	1351
5:00			6	6	17:00			189	242			
5:15			11	7	17:15			173	196			
5:30			16	8	17:30			191	207			
5:45			15	48	12	33	81	178	731	242	887	1618
6:00			21	8	18:00			172	257			
6:15			26	17	18:15			176	280			
6:30			27	23	18:30			163	268			
6:45			31	105	29	77	182	157	668	282	1087	1755
7:00			34	31	19:00			186	302			
7:15			42	51	19:15			188	330			
7:30			59	72	19:30			207	294			
7:45			84	219	68	222	441	193	774	280	1206	1980
8:00			81	63	20:00			198	271			
8:15			95	70	20:15			174	245			
8:30			134	80	20:30			137	179			
8:45			153	463	112	325	788	106	615	180	875	1490
9:00			156	135	21:00			96	156			
9:15			231	185	21:15			78	132			
9:30			276	249	21:30			86	83			
9:45			257	920	297	866	1786	89	349	73	444	793
10:00			252	251	22:00			101	80			
10:15			204	142	22:15			72	72			
10:30			178	123	22:30			61	70			
10:45			132	766	134	650	1416	52	286	64	286	572
11:00			104	108	23:00			56	54			
11:15			112	100	23:15			45	43			
11:30			101	96	23:30			37	42			
11:45			91	408	84	388	796	35	173	37	176	349

Total Vol. 3243 2891 **6134** 5607 7394 **13001**

Daily Totals

NB	SB	EB	WB	Combined
		8850	10285	19135

AM

PM

Split %	AM			PM				
	52.9%	47.1%	32.1%	43.1%	56.9%	67.9%		
Peak Hour	0:30	0:30	9:15	9:15	9:15	19:15	18:45	19:00
Volume			1016	982	1998	786	1208	1980
P.H.F.			0.92	0.83	0.90	0.95	0.92	0.96

Transportation Studies, Inc.

2640 Walnut Avenue, Suite L
Tustin, CA. 92780

Location : BRISTOL STREET
Segment : WARNER AVE TO EDINGER AVE
Client : CITY SANTA ANA

Site: SANTA ANA
Date: 09/17/19

Interval	NB				SB				Combined		Day:	Tuesday
	AM		PM		AM		PM		AM	PM		
12:00	72	181	226	944	34	130	234	885	106	311	460	1.829
12:15	42		228		40		222		82		450	
12:30	29		225		34		222		63		447	
12:45	38		265		22		207		60		472	
01:00	34	123	251	1.071	28	86	212	892	62	209	463	1.963
01:15	23		272		18		188		41		460	
01:30	38		282		24		246		62		528	
01:45	28		266		16		246		44		512	
02:00	29	120	279	1.293	18	83	233	1.003	47	203	512	2.296
02:15	30		288		23		236		53		524	
02:30	24		344		16		266		40		610	
02:45	37		382		26		268		63		650	
03:00	29	92	402	1.547	22	124	332	1.088	51	216	734	2.635
03:15	18		384		20		236		38		620	
03:30	21		384		32		278		53		662	
03:45	24		377		50		242		74		619	
04:00	22	121	394	1.549	51	395	228	924	73	516	622	2.473
04:15	30		378		84		226		114		604	
04:30	33		376		146		216		179		592	
04:45	36		401		114		254		150		655	
05:00	44	220	426	1.569	99	606	266	1.057	143	826	692	2.626
05:15	48		394		115		241		163		635	
05:30	64		377		186		272		250		649	
05:45	64		372		206		278		270		650	
06:00	94	425	362	1.401	211	1.195	234	933	305	1.620	596	2.334
06:15	90		379		234		228		324		607	
06:30	108		336		328		239		436		575	
06:45	133		324		422		232		555		556	
07:00	190	1.030	254	1.057	421	1.708	226	858	611	2.738	480	1.915
07:15	236		283		432		252		668		535	
07:30	302		264		425		206		727		470	
07:45	302		256		430		174		732		430	
08:00	309	1.125	230	793	384	1.640	198	712	693	2.765	428	1.505
08:15	346		192		375		199		721		391	
08:30	300		187		445		177		745		364	
08:45	170		184		436		138		606		322	
09:00	165	704	166	649	310	1.110	146	578	475	1,814	312	1,227
09:15	169		171		256		143		425		314	
09:30	194		164		276		145		470		309	
09:45	176		148		268		144		444		292	
10:00	170	718	151	531	220	866	88	367	390	1,584	239	898
10:15	188		126		212		103		400		229	
10:30	182		110		206		90		388		200	
10:45	178		144		228		86		406		230	
11:00	198	870	91	347	229	924	68	225	427	1,794	159	572
11:15	241		100		219		57		460		157	
11:30	221		82		234		50		455		132	
11:45	210		74		242		50		452		124	
Totals	5,729		12,751		8,867		9,522		14,596		22,273	
Split%	39.3		57.2		60.7		42.8					
Day Totals		18,480				18,389				36,869		
Day Splits		50.1				49.9						
Peak Hour	07:30		04:45		07:00		02:45		07:45		02:45	
Volume	1,259		1,598		1,708		1,114		2,891		2,666	
Factor	0.91		0.94		0.99		0.84		0.97		0.91	

Transportation Studies, Inc.

2640 Walnut Avenue, Suite L
Tustin, CA. 92780

Location : BRISTOL STREET
Segment : SEGERSTROM AVE TO WARNER AVE
Client : CITY SANTA ANA

Site: SANTA ANA
Date: 09/17/19

Interval	NB				SB				Combined				Day:	Tuesday
	AM		PM		AM		PM		AM		PM			
12:00	58	170	250	1.064	40	130	261	1.063	98	300	511	2.127		
12:15	48		256		36		264		84		520			
12:30	25		278		31		288		56		566			
12:45	39		280		23		250		62		530			
01:00	34	113	256	1.083	20	83	256	1.022	54	196	512	2.105		
01:15	30		254		22		214		52		468			
01:30	30		304		28		280		58		584			
01:45	19		269		13		272		32		541			
02:00	25	90	304	1.360	20	81	228	1.087	45	171	532	2.447		
02:15	22		298		20		267		42		565			
02:30	20		342		23		282		43		624			
02:45	23		416		18		310		41		726			
03:00	18	58	409	1.493	18	113	342	1.115	36	171	751	2.608		
03:15	12		340		19		257		31		597			
03:30	13		320		32		258		45		578			
03:45	15		424		44		258		59		682			
04:00	15	75	390	1.460	53	396	212	922	68	471	602	2.382		
04:15	24		365		96		248		120		613			
04:30	14		373		120		234		134		607			
04:45	22		332		127		228		149		560			
05:00	26	150	400	1.480	106	604	271	1,092	132	754	671	2,572		
05:15	32		370		121		277		153		647			
05:30	40		364		196		272		236		636			
05:45	52		346		181		272		233		618			
06:00	64	340	372	1.324	204	1,218	247	987	268	1,558	619	2,311		
06:15	70		332		224		252		294		584			
06:30	98		308		348		234		446		542			
06:45	108		312		442		254		550		566			
07:00	158	913	277	1,092	408	1,907	235	922	566	2,820	512	2,014		
07:15	212		290		491		252		703		542			
07:30	243		269		525		216		768		485			
07:45	300		256		483		219		783		475			
08:00	292	999	220	804	444	1,814	220	730	736	2,813	440	1,534		
08:15	326		205		441		192		767		397			
08:30	223		201		464		166		687		367			
08:45	158		178		465		152		623		330			
09:00	154	685	192	648	394	1,306	124	511	548	1,991	316	1,159		
09:15	184		162		306		131		490		293			
09:30	171		137		292		130		463		267			
09:45	176		157		314		126		490		283			
10:00	177	741	141	493	254	942	86	379	431	1,683	227	872		
10:15	170		132		229		98		399		230			
10:30	200		106		215		107		415		213			
10:45	194		114		244		88		438		202			
11:00	239	989	104	352	244	1,034	58	197	483	2,023	162	549		
11:15	276		100		232		43		508		143			
11:30	226		84		280		54		506		138			
11:45	248		64		278		42		526		106			
Totals	5,323		12,653		9,628		10,027		14,951		22,680			
Split%	35.6		55.8		64.4		44.2							
Day Totals		17,976				19,655				37,631				
Day Splits		47.8				52.2								
Peak Hour	07:30		03:45		07:15		02:15		07:30		02:30			
Volume	1,161		1,552		1,943		1,201		3,054		2,698			
Factor	0.89		0.92		0.93		0.88		0.98		0.90			

ADT261 WARNER AVE from RAITT ST to BRISTOL ST

Prepared by AimTD tel. 714 253 7888

AM Period	NB	SB	EB	WB	PM Period	NB	SB	EB	WB				
0:30			32	32	12:00			182	187				
0:15			33	25	12:15			187	186				
0:30			25	29	12:30			177	222				
0:45			31	121	16	102	223	12:45	205	751	204	799	1550
1:00			14	24	13:00			189	232				
1:15			11	19	13:15			223	281				
1:30			13	14	13:30			240	270				
1:45			8	46	12	69	115	13:45	323	975	323	1106	2081
2:00			15	15	14:00			343	311				
2:15			7	14	14:15			386	303				
2:30			15	18	14:30			326	314				
2:45			16	53	13	60	113	14:45	312	1367	341	1269	2636
3:00			22	11	15:00			353	351				
3:15			23	13	15:15			321	376				
3:30			21	15	15:30			329	364				
3:45			34	100	18	57	157	15:45	319	1322	362	1453	2775
4:00			50	21	16:00			277	371				
4:15			55	31	16:15			298	395				
4:30			75	74	16:30			291	378				
4:45			111	291	85	211	502	16:45	321	1187	395	1539	2726
5:00			104	78	17:00			318	420				
5:15			130	96	17:15			348	421				
5:30			185	114	17:30			308	384				
5:45			204	623	127	415	1038	17:45	289	1263	397	1622	2885
6:00			195	121	18:00			296	393				
6:15			184	128	18:15			260	356				
6:30			231	139	18:30			275	324				
6:45			302	912	195	583	1495	18:45	231	1062	285	1358	2420
7:00			313	228	19:00			186	256				
7:15			363	324	19:15			165	241				
7:30			395	423	19:30			143	224				
7:45			408	1479	437	1412	2891	19:45	141	635	179	900	1535
8:00			274	313	20:00			134	165				
8:15			276	245	20:15			125	158				
8:30			241	213	20:30			114	132				
8:45			213	1004	194	965	1969	20:45	124	497	128	583	1080
9:00			202	185	21:00			118	124				
9:15			151	174	21:15			107	110				
9:30			179	170	21:30			114	116				
9:45			152	684	164	693	1377	21:45	96	435	98	448	883
10:00			153	169	22:00			86	94				
10:15			193	187	22:15			66	84				
10:30			175	168	22:30			71	100				
10:45			162	683	167	691	1374	22:45	40	263	78	356	619
11:00			177	189	23:00			45	64				
11:15			157	196	23:15			48	49				
11:30			171	185	23:30			34	51				
11:45			163	668	174	744	1412	23:45	29	156	37	201	357

Total Vol. 6664 6002 **12666** 9913 11634 **21547**

Daily Totals

NB	SB	EB	WB	Combined
		16577	17636	34213

AM

PM

Split %	AM				PM			
	52.6%	47.4%	37.0%		46.0%	54.0%	63.0%	
Peak Hour	0:30	0:30	7:00	7:15	7:15	13:45	17:00	16:45
Volume			1479	1497	2937	1378	1622	2915
P.H.F.			0.91	0.86	0.87	0.89	0.96	0.95

Transportation Studies, Inc.

2640 Walnut Avenue, Suite L
Tustin, CA. 92780

Location : BRISTOL STREET
Segment : SUNFLOWER AVE TO MACARTHUR BL
Client : CITY SANTA ANA

Site: SANTA ANA
Date: 09/17/19

Interval	NB				SB				Combined				Day:	Tuesday
	AM		PM		AM		PM		AM		PM			
12:00	56	191	290	1.165	31	116	300	1.251	87	307	590	2.416		
12:15	46		288		27		284		73		572			
12:30	51		296		34		324		85		620			
12:45	38		291		24		343		62		634			
01:00	31	96	290	1.166	24	76	300	1.126	55	172	590	2.292		
01:15	26		274		13		260		39		534			
01:30	22		302		22		260		44		562			
01:45	17		300		17		306		34		606			
02:00	31	105	286	1.183	18	67	268	1.003	49	172	554	2.186		
02:15	22		293		15		264		37		557			
02:30	20		298		14		232		34		530			
02:45	32		306		20		239		52		545			
03:00	10	43	313	1.196	15	99	268	955	25	142	581	2.151		
03:15	14		266		22		230		36		496			
03:30	12		300		27		229		39		529			
03:45	7		317		35		228		42		545			
04:00	18	76	322	1.261	40	333	218	846	58	409	540	2.107		
04:15	16		336		75		205		91		541			
04:30	20		303		108		227		128		530			
04:45	22		300		110		196		132		496			
05:00	36	171	338	1.277	96	555	200	872	132	726	538	2.149		
05:15	34		323		129		214		163		537			
05:30	43		318		162		220		205		538			
05:45	58		298		168		238		226		536			
06:00	59	313	291	1.193	186	1.017	226	857	245	1.330	517	2.050		
06:15	66		322		176		228		242		550			
06:30	84		286		311		183		395		469			
06:45	104		294		344		220		448		514			
07:00	110	549	261	1.019	328	1.535	222	854	438	2.084	483	1.873		
07:15	147		234		368		218		515		452			
07:30	124		262		413		197		537		459			
07:45	168		262		426		217		594		479			
08:00	160	629	212	795	424	1.606	204	738	584	2.235	416	1.533		
08:15	195		206		371		208		566		414			
08:30	161		208		409		180		570		388			
08:45	113		169		402		146		515		315			
09:00	140	637	180	639	350	1.093	142	500	490	1.730	322	1.139		
09:15	155		164		260		126		415		290			
09:30	168		139		233		122		401		261			
09:45	174		156		250		110		424		266			
10:00	179	751	138	491	228	884	112	362	407	1.635	250	853		
10:15	169		128		222		82		391		210			
10:30	193		106		252		84		445		190			
10:45	210		119		182		84		392		203			
11:00	240	1.081	93	332	254	1.052	82	231	494	2.133	175	563		
11:15	276		104		258		56		534		160			
11:30	279		75		270		45		549		120			
11:45	286		60		270		48		556		108			
Totals	4,642		11,717		8,433		9,595		13,075		21,312			
Split%	35.5		55.0		64.5		45.0							
Day Totals		16,359				18,028				34,387				
Day Splits		47.6				52.4								
Peak Hour	11:00		04:45		07:30		12:00		07:45		12:00			
Volume	1,081		1,279		1,634		1,251		2,314		2,416			
Factor	0.94		0.95		0.96		0.91		0.97		0.95			

Transportation Studies, Inc.

2640 Walnut Avenue, Suite L
Tustin, CA. 92780

Location : FLOWER STREET
Segment : SEGERSTROM AVE TO WARNER AVE
Client : CITY SANTA ANA

Site: SANTA ANA
Date: 09/10/19

Interval	SB			NB			Combined		Day:	Tuesday		
	AM		PM	AM		PM	AM	PM				
12:00	15	46	70	306	14	59	76	282	29	105	146	588
12:15	10		80		13		65		23		145	
12:30	10		78		19		65		29		143	
12:45	11		78		13		76		24		154	
01:00	3	15	80	295	11	29	96	361	14	44	176	656
01:15	2		60		9		78		11		138	
01:30	3		79		6		94		9		173	
01:45	7		76		3		93		10		169	
02:00	6	23	95	524	3	23	124	627	9	46	219	1,151
02:15	2		99		3		116		5		215	
02:30	5		140		8		172		13		312	
02:45	10		190		9		215		19		405	
03:00	3	34	109	425	8	23	275	935	11	57	384	1,360
03:15	7		113		0		217		7		330	
03:30	7		89		6		208		13		297	
03:45	17		114		9		235		26		349	
04:00	9	118	126	448	5	31	224	1,009	14	149	350	1,457
04:15	10		112		3		290		13		402	
04:30	44		105		9		236		53		341	
04:45	55		105		14		259		69		364	
05:00	30	260	120	506	10	90	320	1,217	40	350	440	1,723
05:15	61		124		20		321		81		445	
05:30	89		132		36		288		125		420	
05:45	80		130		24		288		104		418	
06:00	72	424	106	372	38	185	242	718	110	609	348	1,090
06:15	80		92		29		200		109		292	
06:30	122		92		48		156		170		248	
06:45	150		82		70		120		220		202	
07:00	171	727	92	331	84	538	118	418	255	1,265	210	749
07:15	186		79		127		102		313		181	
07:30	194		84		161		106		355		190	
07:45	176		76		166		92		342		168	
08:00	145	638	80	245	118	308	81	316	263	946	161	561
08:15	160		58		76		92		236		150	
08:30	164		61		62		79		226		140	
08:45	169		46		52		64		221		110	
09:00	115	346	41	146	57	186	47	204	172	532	88	350
09:15	78		38		40		53		118		91	
09:30	80		33		48		52		128		85	
09:45	73		34		41		52		114		86	
10:00	70	245	37	134	55	207	52	174	125	452	89	308
10:15	59		39		58		42		117		81	
10:30	56		30		42		42		98		72	
10:45	60		28		52		38		112		66	
11:00	59	262	11	54	48	253	45	109	107	515	56	163
11:15	62		15		78		28		140		43	
11:30	77		15		57		21		134		36	
11:45	64		13		70		15		134		28	
Totals	3,138		3,786		1,932		6,370		5,070		10,156	
Split%	61.9		37.3		38.1		62.7					
Day Totals		6,924				8,302				15,226		
Day Splits		45.5				54.5						
Peak Hour	07:00		02:30		07:15		05:00		07:15		05:00	
Volume	727		552		572		1,217		1,273		1,723	
Factor	0.94		0.73		0.86		0.95		0.90		0.97	

Transportation Studies, Inc.

2640 Walnut Avenue, Suite L
Tustin, CA. 92780

Location : EDINGER AVENUE
Segment : FLOWER ST TO BROADWAY
Client : CITY SANTA ANA

Site: SANTA ANA
Date: 09/24/19

Interval	EB				WB				Combined				Day:	Tuesday
	AM		PM		AM		PM		AM		PM			
12:00	36	91	176	638	50	123	237	1.094	86	214	413	1.732		
12:15	23		136		19		323		42		459			
12:30	17		148		30		262		47		410			
12:45	15		178		24		272		39		450			
01:00	13	60	157	642	30	99	280	1.289	43	159	437	1.931		
01:15	18		150		25		304		43		454			
01:30	11		161		23		339		34		500			
01:45	18		174		21		366		39		540			
02:00	20	59	176	892	15	74	403	1.786	35	133	579	2.678		
02:15	17		210		12		413		29		623			
02:30	10		232		20		406		30		638			
02:45	12		274		27		564		39		838			
03:00	20	113	250	948	10	56	480	2.087	30	169	730	3.035		
03:15	23		206		6		496		29		702			
03:30	32		226		16		564		48		790			
03:45	38		266		24		547		62		813			
04:00	48	381	244	905	15	116	556	2.316	63	497	800	3.221		
04:15	72		210		14		568		86		778			
04:30	124		225		38		574		162		799			
04:45	137		226		49		618		186		844			
05:00	93	664	242	1.036	40	254	594	2.327	133	918	836	3.363		
05:15	128		246		48		627		176		873			
05:30	190		280		80		598		270		878			
05:45	253		268		86		508		339		776			
06:00	211	1.018	225	839	86	482	566	1.836	297	1.500	791	2.675		
06:15	247		232		98		434		345		666			
06:30	254		194		134		438		388		632			
06:45	306		188		164		398		470		586			
07:00	272	1.034	173	671	200	819	394	1.472	472	1.853	567	2.143		
07:15	276		174		239		418		515		592			
07:30	234		164		206		341		440		505			
07:45	252		160		174		319		426		479			
08:00	230	997	168	606	180	759	302	1.013	410	1.756	470	1.619		
08:15	252		164		226		283		478		447			
08:30	245		146		209		240		454		386			
08:45	270		128		144		188		414		316			
09:00	194	703	110	405	148	708	203	758	342	1.411	313	1.163		
09:15	178		104		192		202		370		306			
09:30	155		100		176		215		331		315			
09:45	176		91		192		138		368		229			
10:00	144	576	82	257	184	725	163	558	328	1.301	245	815		
10:15	123		65		165		160		288		225			
10:30	168		55		170		125		338		180			
10:45	141		55		206		110		347		165			
11:00	144	598	48	156	216	793	105	339	360	1.391	153	495		
11:15	140		44		172		92		312		136			
11:30	164		40		213		74		377		114			
11:45	150		24		192		68		342		92			
Totals	6,294		7,995		5,008		16,875		11,302		24,870			
Split%	55.7		32.1		44.3		67.9							
Day Totals		14,289				21,883				36,172				
Day Splits		39.5				60.5								
Peak Hour	06:30		05:00		07:00		04:45		06:45		04:45			
Volume	1,108		1,036		819		2,437		1,897		3,431			
Factor	0.91		0.93		0.86		0.97		0.92		0.98			

Thursday, October 03, 2019

Location: Santa Ana

PROJECT:

ADT160 MAIN ST from EDINGER AVE to McFADDEN AVE.

Prepared by AimTD tel. 714 253 7888

AM Period	NB	SB	EB	WB	PM Period	NB	SB	EB	WB	
0:00	34	46			12:00	176	167			
0:15	38	36			12:15	204	187			
0:30	30	27			12:30	197	209			
0:45	36	138	40	149	12:45	216	793	175	738	
1:00	26	26			13:00	197	181			
1:15	25	13			13:15	205	167			
1:30	23	15			13:30	247	159			
1:45	27	101	17	71	13:45	206	855	202	709	
2:00	21	25			14:00	228	173			
2:15	23	21			14:15	295	153			
2:30	29	17			14:30	278	151			
2:45	22	95	22	85	14:45	267	1068	197	674	
3:00	15	19			15:00	305	177			
3:15	8	29			15:15	322	205			
3:30	17	23			15:30	290	188			
3:45	25	65	26	97	15:45	307	1224	197	767	
4:00	29	41			16:00	286	215			
4:15	24	31			16:15	332	181			
4:30	41	42			16:30	341	187			
4:45	40	134	54	168	16:45	320	1279	218	801	
5:00	48	49			17:00	323	200			
5:15	55	68			17:15	336	217			
5:30	78	78			17:30	307	223			
5:45	89	270	131	326	17:45	289	1255	238	878	
6:00	75	173			18:00	275	206			
6:15	111	155			18:15	311	190			
6:30	121	173			18:30	271	187			
6:45	137	444	212	713	18:45	229	1086	165	748	
7:00	159	317			19:00	184	161			
7:15	194	331			19:15	177	156			
7:30	243	324			19:30	180	152			
7:45	234	830	348	1320	19:45	150	691	162	631	
8:00	204	349			20:00	140	127			
8:15	185	326			20:15	169	134			
8:30	172	357			20:30	109	115			
8:45	164	725	325	1357	20:45	131	549	123	499	
9:00	131	298			21:00	113	133			
9:15	127	261			21:15	120	105			
9:30	135	208			21:30	104	101			
9:45	152	545	195	962	21:45	110	447	90	429	
10:00	165	169			22:00	97	86			
10:15	156	164			22:15	76	68			
10:30	146	171			22:30	86	76			
10:45	157	624	178	682	22:45	65	324	58	288	
11:00	185	180			23:00	73	47			
11:15	169	153			23:15	68	42			
11:30	152	166			23:30	42	41			
11:45	158	664	164	663	23:45	31	214	34	164	
Total Vol.	4635	6593		11228		9785	7326		17111	
								Daily Totals		
						NB	SB	EB	WB	Combined
						14420	13919			28339
				AM					PM	
Split %	41.3%	58.7%		39.6%		57.2%	42.8%			60.4%
Peak Hour	7:15	7:45		7:15		16:30	17:15			16:45
Volume	875	1380		2227		1320	884			2144
P.H.F.	0.90	0.97		0.96		0.96	0.93			0.97

Thursday, October 10, 2019

CITY: Santa Ana

PROJECT: SC

ADT159 MAIN ST from WARNER AVE to EDINGER AVE.

Prepared by AimTD tel. 714 253 7888

AM Period	NB	SB	EB	WB	PM Period	NB	SB	EB	WB
0:00	49	24			12:00	160	169		
0:15	45	37			12:15	170	159		
0:30	36	25			12:30	146	139		
0:45	31	161	35	121	12:45	184	660	146	613
1:00	26	26			13:00	188	170		
1:15	23	18			13:15	195	157		
1:30	26	19			13:30	235	177		
1:45	21	96	12	75	13:45	218	836	139	643
2:00	24	8			14:00	207	167		
2:15	20	16			14:15	271	182		
2:30	37	18			14:30	260	194		
2:45	26	107	19	61	14:45	314	1052	204	747
3:00	28	18			15:00	273	182		
3:15	13	15			15:15	274	186		
3:30	21	31			15:30	330	175		
3:45	11	73	41	105	15:45	346	1223	187	730
4:00	17	37			16:00	323	171		
4:15	24	65			16:15	353	165		
4:30	27	104			16:30	343	176		
4:45	37	105	116	322	16:45	318	1337	173	685
5:00	49	91			17:00	332	187		
5:15	52	119			17:15	342	229		
5:30	63	162			17:30	300	224		
5:45	57	221	197	569	17:45	301	1275	211	851
6:00	59	169			18:00	294	170		
6:15	66	195			18:15	337	165		
6:30	90	281			18:30	287	128		
6:45	106	321	317	962	18:45	283	1201	145	608
7:00	106	305			19:00	222	133		
7:15	145	372			19:15	209	144		
7:30	171	292			19:30	170	118		
7:45	193	615	299	1268	19:45	154	755	120	515
8:00	157	327			20:00	141	107		
8:15	137	334			20:15	176	119		
8:30	134	336			20:30	193	105		
8:45	133	561	356	1353	20:45	162	672	102	433
9:00	126	272			21:00	198	90		
9:15	122	204			21:15	174	93		
9:30	139	176			21:30	111	100		
9:45	155	542	165	817	21:45	118	601	80	363
10:00	148	162			22:00	105	65		
10:15	151	157			22:15	108	70		
10:30	128	157			22:30	85	68		
10:45	139	566	152	628	22:45	63	361	56	259
11:00	143	151			23:00	64	44		
11:15	163	141			23:15	78	47		
11:30	151	146			23:30	48	46		
11:45	164	621	155	593	23:45	50	240	35	172
Total Vol.	3989	6874		10863		10213	6619		16832
								Daily Totals	
						NB	SB	EB	WB
						14202	13493		27695
								PM	
Split %	36.7%	63.3%		39.2%		60.7%	39.3%		60.8%
Peak Hour	7:15	8:00		7:15		15:45	17:00		17:00
Volume	666	1353		1956		1365	851		2126
P.H.F.	0.86	0.95		0.95		0.97	0.93		0.93

Wednesday, September 11, 2019

Location: Santa Ana

PROJECT:

ADT157 MAIN ST from ALTON AVE to DYER RD.

Prepared by AimTD tel. 714 253 7888

AM Period	NB	SB	EB	WB	PM Period	NB	SB	EB	WB
0:00	37	30			12:00	230	160		
0:15	25	33			12:15	206	177		
0:30	38	38			12:30	202	191		
0:45	34	134	57	158	12:45	226	864	172	700
1:00	30	18			13:00	211	160		
1:15	26	19			13:15	277	171		
1:30	19	27			13:30	316	213		
1:45	16	91	20	84	13:45	291	1095	184	728
2:00	33	23			14:00	247	189		
2:15	16	21			14:15	309	191		
2:30	68	21			14:30	364	180		
2:45	34	151	15	80	14:45	404	1324	186	746
3:00	15	16			15:00	373	178		
3:15	17	16			15:15	340	174		
3:30	20	32			15:30	435	177		
3:45	20	72	34	98	15:45	359	1507	180	709
4:00	16	47			16:00	384	162		
4:15	13	80			16:15	405	191		
4:30	25	123			16:30	379	202		
4:45	49	103	132	382	16:45	361	1529	193	748
5:00	39	104			17:00	393	197		
5:15	32	125			17:15	435	191		
5:30	55	173			17:30	410	214		
5:45	79	205	209	611	17:45	444	1682	223	825
6:00	75	209			18:00	435	165		
6:15	54	238			18:15	389	132		
6:30	84	319			18:30	400	152		
6:45	119	332	366	1132	18:45	284	1508	118	567
7:00	137	353			19:00	241	108		
7:15	146	348			19:15	210	126		
7:30	190	394			19:30	166	120		
7:45	163	636	395	1490	19:45	158	775	119	473
8:00	167	356			20:00	137	94		
8:15	133	434			20:15	119	101		
8:30	139	402			20:30	120	98		
8:45	132	571	355	1547	20:45	104	480	84	377
9:00	140	236			21:00	101	78		
9:15	115	225			21:15	104	78		
9:30	141	208			21:30	111	70		
9:45	133	529	222	891	21:45	74	390	64	290
10:00	128	152			22:00	112	75		
10:15	127	137			22:15	78	73		
10:30	144	156			22:30	90	56		
10:45	134	533	143	588	22:45	75	355	62	266
11:00	181	165			23:00	83	43		
11:15	170	172			23:15	60	38		
11:30	169	180			23:30	58	35		
11:45	200	720	191	708	23:45	39	240	42	158
Total Vol.	4077	7769		11846		11749	6587		18336
								Daily Totals	
						NB	SB	EB	WB
						15826	14356		
									30182
								AM	PM
Split %	34.4%	65.6%		39.2%		64.1%	35.9%		60.8%
Peak Hour	11:45	7:45		7:30		17:15	17:00		17:15
Volume	838	1587		2232		1724	825		2517
P.H.F.	0.91	0.91		0.96		0.98	0.92		0.94

ADT224 SEGERSTROM AVE from BRISTOL ST to FLOWER ST.

Prepared by AimTD tel. 714 253 7888

AM Period	NB	SB	EB	WB	PM Period	NB	SB	EB	WB			
0:30			25	25	12:00			127	142			
0:15			20	15	12:15			125	116			
0:30			23	29	12:30			136	117			
0:45			29	97	23	92	189	144	532	111	486	1018
1:00			17	13	13:00			145	140			
1:15			12	8	13:15			161	166			
1:30			9	16	13:30			196	213			
1:45			6	44	7	44	88	213	715	206	725	1440
2:00			14	15	14:00			194	192			
2:15			11	6	14:15			165	187			
2:30			9	10	14:30			166	222			
2:45			13	47	12	43	90	182	707	250	851	1558
3:00			10	12	15:00			219	231			
3:15			11	14	15:15			177	204			
3:30			25	6	15:30			231	268			
3:45			29	75	17	49	124	194	821	303	1006	1827
4:00			29	17	16:00			209	315			
4:15			45	19	16:15			197	313			
4:30			59	36	16:30			244	332			
4:45			91	224	52	124	348	218	868	290	1250	2118
5:00			58	26	17:00			229	279			
5:15			97	36	17:15			251	265			
5:30			103	40	17:30			260	280			
5:45			135	393	49	151	544	225	965	285	1109	2074
6:00			90	57	18:00			212	318			
6:15			130	67	18:15			186	242			
6:30			159	83	18:30			144	214			
6:45			202	581	107	314	895	153	695	186	960	1655
7:00			261	125	19:00			116	145			
7:15			297	144	19:15			115	148			
7:30			312	191	19:30			124	132			
7:45			296	1166	160	620	1786	115	470	111	536	1006
8:00			212	123	20:00			111	100			
8:15			203	96	20:15			92	103			
8:30			212	148	20:30			96	90			
8:45			193	820	136	503	1323	81	380	80	373	753
9:00			153	95	21:00			84	90			
9:15			145	103	21:15			77	81			
9:30			132	100	21:30			60	77			
9:45			104	534	108	406	940	64	285	77	325	610
10:00			109	101	22:00			64	70			
10:15			97	93	22:15			48	64			
10:30			94	92	22:30			48	47			
10:45			104	404	88	374	778	38	198	40	221	419
11:00			100	111	23:00			38	43			
11:15			103	108	23:15			35	35			
11:30			103	114	23:30			26	32			
11:45			123	429	128	461	890	22	121	28	138	259

Total Vol. 4814 3181 **7995** 6757 7980 **14737**

Daily Totals				
NB	SB	EB	WB	Combined
		11571	11161	22732

Split %	AM				PM			
	0:30	0:30	7:00	7:00	7:00	17:00	15:45	16:00
	60.2%	39.8%	35.2%		45.9%	54.1%	64.8%	
Peak Hour	0:30	0:30	7:00	7:00	7:00	17:00	15:45	16:00
Volume			1166	620	1786	965	1263	2118
P.H.F.			0.93	0.81	0.89	0.93	0.95	0.92

Thursday, October 10, 2019

CITY: Santa Ana

PROJECT:

ADT152 MacArthur between Flower and Main Prepared by: Field Data Services of Arizor

Prepared by AimTD LLC tel. 714 253 7888

AM Period	NB	SB	EB	WB	PM Period	NB	SB	EB	WB			
0:00			24	41	12:00			213	294			
0:15			21	35	12:15			245	288			
0:30			15	37	12:30			257	269			
0:45			14	74	25	138	212	285	1000	314	1165	2165
1:00			16	23	13:00			308	287			
1:15			11	25	13:15			303	275			
1:30			12	20	13:30			294	303			
1:45			14	53	16	84	137	312	1217	286	1151	2368
2:00			10	19	14:00			281	321			
2:15			9	15	14:15			313	312			
2:30			13	23	14:30			310	345			
2:45			16	48	25	82	130	287	1191	331	1309	2500
3:00			21	14	15:00			312	350			
3:15			23	18	15:15			279	398			
3:30			31	22	15:30			253	421			
3:45			36	111	21	75	186	237	1081	475	1644	2725
4:00			47	17	16:00			231	563			
4:15			62	28	16:15			252	514			
4:30			98	42	16:30			248	557			
4:45			101	308	38	125	433	240	971	586	2220	3191
5:00			121	52	17:00			227	617			
5:15			129	50	17:15			234	595			
5:30			175	64	17:30			242	582			
5:45			196	621	79	245	866	231	934	556	2350	3284
6:00			200	76	18:00			214	525			
6:15			234	86	18:15			236	512			
6:30			306	107	18:30			223	456			
6:45			372	1112	96	365	1477	220	893	423	1916	2809
7:00			421	131	19:00			198	302			
7:15			463	185	19:15			203	253			
7:30			521	197	19:30			187	194			
7:45			535	1940	176	689	2629	179	767	195	944	1711
8:00			501	175	20:00			176	168			
8:15			461	187	20:15			153	150			
8:30			452	157	20:30			134	178			
8:45			423	1837	162	681	2518	140	603	145	641	1244
9:00			345	142	21:00			142	133			
9:15			269	147	21:15			144	142			
9:30			204	164	21:30			121	145			
9:45			214	1032	153	606	1638	93	500	123	543	1043
10:00			196	158	22:00			101	131			
10:15			185	165	22:15			98	120			
10:30			157	172	22:30			76	96			
10:45			175	713	169	664	1377	53	328	65	412	740
11:00			168	197	23:00			56	79			
11:15			203	235	23:15			43	75			
11:30			184	268	23:30			31	89			
11:45			195	750	286	986	1736	25	155	53	296	451
Total Vol.			8599	4740	13339			9640	14591	24231		
								Daily Totals				
								NB	SB	EB	WB	Combined
										18239	19331	37570
								AM				
Split %			64.5%	35.5%	35.5%			PM				
										39.8%	60.2%	64.5%
Peak Hour			7:15	11:45	7:15					14:15	16:45	16:45
Volume			2020	1137	2753					1222	2380	3323
P.H.F.			0.94	0.97	0.96					0.98	0.96	0.98

Wednesday, October 02, 2019

CITY: Santa Ana

PROJECT:

ADT155 Main between Sunflower and MacArthur.

Prepared by: Field Data Services of Arizor

Prepared by AimTD LLC tel. 714 253 7888

AM Period	NB	SB	EB	WB	PM Period	NB	SB	EB	WB	
0:00	23	16			12:00	167	141			
0:15	26	14			12:15	176	151			
0:30	21	12			12:30	206	158			
0:45	18	88	8	50	12:45	189	738	142	592	
					1330					
1:00	13	9			13:00	198	152			
1:15	14	7			13:15	223	145			
1:30	15	6			13:30	208	136			
1:45	11	53	4	26	13:45	198	827	142	575	
					1402					
2:00	9	6			14:00	206	121			
2:15	13	7			14:15	234	124			
2:30	15	4			14:30	254	117			
2:45	8	45	8	25	14:45	259	953	112	474	
					1427					
3:00	11	5			15:00	276	98			
3:15	8	5			15:15	298	110			
3:30	7	11			15:30	342	123			
3:45	11	37	14	35	15:45	331	1247	142	473	
					1720					
4:00	5	16			16:00	367	147			
4:15	12	24			16:15	389	136			
4:30	15	47			16:30	434	142			
4:45	16	48	75	162	16:45	456	1646	134	559	
					2205					
5:00	21	71			17:00	521	152			
5:15	28	67			17:15	489	157			
5:30	37	86			17:30	456	175			
5:45	35	121	97	321	17:45	467	1933	154	638	
					2571					
6:00	48	123			18:00	407	142			
6:15	54	156			18:15	342	113			
6:30	76	178			18:30	314	97			
6:45	70	248	207	664	18:45	286	1349	86	438	
					1787					
7:00	87	245			19:00	234	65			
7:15	123	289			19:15	201	76			
7:30	145	305			19:30	142	65			
7:45	179	534	311	1150	19:45	113	690	75	281	
					971					
8:00	168	352			20:00	101	54			
8:15	143	316			20:15	87	46			
8:30	125	308			20:30	97	63			
8:45	112	548	298	1274	20:45	67	352	45	208	
					560					
9:00	104	251			21:00	86	53			
9:15	107	214			21:15	97	51			
9:30	98	156			21:30	76	47			
9:45	97	406	132	753	21:45	86	345	32	183	
					528					
10:00	87	121			22:00	76	25			
10:15	76	123			22:15	65	34			
10:30	73	108			22:30	70	31			
10:45	89	325	127	479	22:45	53	264	25	115	
					379					
11:00	111	113			23:00	41	21			
11:15	104	134			23:15	42	16			
11:30	122	123			23:30	28	17			
11:45	136	473	125	495	23:45	32	143	20	74	
					217					
Total Vol.	2926	5434			8360	10487	4610			15097
										Daily Totals
					NB	SB	EB	WB	Combined	
					13413	10044			23457	
AM					PM					
Split %	35.0%	65.0%			35.6%	69.5%	30.5%			64.4%
Peak Hour	11:45	7:45			7:30	17:00	17:00			17:00
Volume	685	1287			1919	1933	638			2571
P.H.F.	0.83	0.91			0.92	0.92	0.91			0.96

Transportation Studies, Inc.

2640 Walnut Avenue, Suite L
Tustin, CA. 92780

Location : GRAND AVENUE
Segment : WARNER AVE TO EDINGER AVE
Client : CITY SANTA ANA

Site: SANTA ANA
Date: 09/12/19

Interval	NB				SB				Combined		Day:	Thursday
	AM		PM		AM		PM		AM	PM		
12:00	6	20	120	487	4	22	149	543	10	42	269	1.030
12:15	5		115		6		132		11		247	
12:30	5		130		10		136		15		266	
12:45	4		122		2		126		6		248	
01:00	3	14	144	580	1	8	133	451	4	22	277	1.031
01:15	4		134		2		98		6		232	
01:30	3		169		4		132		7		301	
01:45	4		133		1		88		5		221	
02:00	2	14	164	745	2	11	96	469	4	25	260	1.214
02:15	6		182		2		109		8		291	
02:30	2		213		3		138		5		351	
02:45	4		186		4		126		8		312	
03:00	4	16	224	1.101	4	28	153	582	8	44	377	1.683
03:15	4		256		6		148		10		404	
03:30	6		308		6		137		12		445	
03:45	2		313		12		144		14		457	
04:00	3	44	304	1.263	10	90	160	664	13	134	464	1.927
04:15	3		294		16		170		19		464	
04:30	11		341		16		184		27		525	
04:45	27		324		48		150		75		474	
05:00	18	124	328	1.305	30	177	226	701	48	301	554	2.006
05:15	26		322		34		182		60		504	
05:30	28		346		52		156		80		502	
05:45	52		309		61		137		113		446	
06:00	42	229	258	901	46	320	129	451	88	549	387	1.352
06:15	56		259		70		112		126		371	
06:30	57		220		90		105		147		325	
06:45	74		164		114		105		188		269	
07:00	90	428	131	374	120	554	96	354	210	982	227	728
07:15	96		99		124		80		220		179	
07:30	110		84		158		96		268		180	
07:45	132		60		152		82		284		142	
08:00	114	410	60	175	162	675	52	197	276	1.085	112	372
08:15	114		38		152		48		266		86	
08:30	94		42		175		47		269		89	
08:45	88		35		186		50		274		85	
09:00	101	338	29	124	138	464	46	153	239	802	75	277
09:15	78		36		132		35		210		71	
09:30	78		31		103		44		181		75	
09:45	81		28		91		28		172		56	
10:00	65	304	32	92	92	377	50	136	157	681	82	228
10:15	58		20		100		30		158		50	
10:30	84		22		91		24		175		46	
10:45	97		18		94		32		191		50	
11:00	88	430	18	53	114	482	31	79	202	912	49	132
11:15	104		14		94		18		198		32	
11:30	118		9		126		18		244		27	
11:45	120		12		148		12		268		24	
Totals	2,371		7,200		3,208		4,780		5,579		11,980	
Split%	42.5		60.1		57.5		39.9					
Day Totals		9,571				7,988				17,559		
Day Splits		54.5				45.5						
Peak Hour	07:30		04:45		08:00		04:30		07:45		04:30	
Volume	470		1,320		675		742		1,095		2,057	
Factor	0.89		0.95		0.91		0.82		0.96		0.93	

Transportation Studies, Inc.

2640 Walnut Avenue, Suite L
Tustin, CA. 92780

Location : EDINGER AVENUE
Segment : LYON ST TO NEWPORT FREEWAY
Client : CITY SANTA ANA

Site: SANTA ANA
Date: 09/24/19

Interval	EB				WB				Combined				Day:	Tuesday
	AM		PM		AM		PM		AM		PM			
12:00	29	101	286	1.162	47	137	310	1.168	76	238	596	2.330		
12:15	30		278		25		284		55		562			
12:30	28		312		38		282		66		594			
12:45	14		286		27		292		41		578			
01:00	18	61	297	1.164	23	70	288	1.159	41	131	585	2.323		
01:15	17		293		18		316		35		609			
01:30	16		300		16		286		32		586			
01:45	10		274		13		269		23		543			
02:00	15	67	251	1.217	16	74	315	1.382	31	141	566	2.599		
02:15	17		303		27		355		44		658			
02:30	20		338		16		336		36		674			
02:45	15		325		15		376		30		701			
03:00	22	121	324	1.308	11	87	376	1.535	33	208	700	2.843		
03:15	26		310		16		375		42		685			
03:30	37		367		26		390		63		757			
03:45	36		307		34		394		70		701			
04:00	47	374	352	1.393	38	329	376	1.582	85	703	728	2.975		
04:15	66		324		49		420		115		744			
04:30	113		348		86		402		199		750			
04:45	148		369		156		384		304		753			
05:00	120	744	461	1.655	136	642	368	1.396	256	1,386	829	3,051		
05:15	153		435		113		346		266		781			
05:30	235		415		180		320		415		735			
05:45	236		344		213		362		449		706			
06:00	224	1,226	292	1.048	252	1,030	375	1.326	476	2,256	667	2,374		
06:15	284		254		220		384		504		638			
06:30	346		266		258		331		604		597			
06:45	372		236		300		236		672		472			
07:00	382	1,650	248	777	354	1,266	208	728	736	2,916	456	1,505		
07:15	460		205		291		200		751		405			
07:30	424		162		285		180		709		342			
07:45	384		162		336		140		720		302			
08:00	385	1,439	134	541	338	1,299	174	553	723	2,738	308	1,094		
08:15	372		148		378		127		750		275			
08:30	352		135		303		131		655		266			
08:45	330		124		280		121		610		245			
09:00	282	1,022	122	412	277	1,075	114	437	559	2,097	236	849		
09:15	254		94		284		128		538		222			
09:30	240		106		264		102		504		208			
09:45	246		90		250		93		496		183			
10:00	260	1,012	108	294	292	1,059	120	342	552	2,071	228	636		
10:15	250		68		250		90		500		158			
10:30	256		57		245		62		501		119			
10:45	246		61		272		70		518		131			
11:00	256	1,114	50	169	268	1,083	61	205	524	2,197	111	374		
11:15	262		43		264		40		526		83			
11:30	306		42		264		52		570		94			
11:45	290		34		287		52		577		86			
Totals	8,931		11,140		8,151		11,813		17,082		22,953			
Split%	52.3		48.5		47.7		51.5							
Day Totals		20,071				19,964				40,035				
Day Splits		50.1				49.9								
Peak Hour	07:15		04:45		07:45		03:45		07:00		04:30			
Volume	1,653		1,680		1,355		1,592		2,916		3,113			
Factor	0.90		0.91		0.90		0.95		0.97		0.94			

ADT267 WARNER AVE from GR to AVE to PULLMAN ST.

Prepared by AimTD tel. 714 253 7888

AM Period	NB	SB	EB	WB	PM Period	NB	SB	EB	WB			
0:30			9	12	12:00			177	174			
0:15			8	9	12:15			159	165			
0:30			9	8	12:30			163	152			
0:45			11	37	7	36	73	150	649	144	635	1284
1:00			7	11	13:00			169	150			
1:15			8	7	13:15			156	167			
1:30			7	9	13:30			154	209			
1:45			6	28	6	33	61	178	657	187	713	1370
2:00			5	7	14:00			174	180			
2:15			8	9	14:15			170	254			
2:30			9	9	14:30			164	348			
2:45			7	29	5	30	59	163	671	312	1094	1765
3:00			7	6	15:00			156	301			
3:15			13	7	15:15			153	296			
3:30			27	10	15:30			154	303			
3:45			47	94	4	27	121	148	611	311	1211	1822
4:00			41	3	16:00			171	274			
4:15			51	5	16:15			155	315			
4:30			95	11	16:30			168	356			
4:45			113	300	14	33	333	197	691	302	1247	1938
5:00			97	18	17:00			224	324			
5:15			123	21	17:15			229	307			
5:30			175	20	17:30			205	310			
5:45			290	685	43	102	787	168	826	301	1242	2068
6:00			165	54	18:00			136	294			
6:15			209	59	18:15			146	237			
6:30			223	53	18:30			117	171			
6:45			242	839	79	245	1084	103	502	103	805	1307
7:00			231	112	19:00			85	78			
7:15			283	153	19:15			78	73			
7:30			272	158	19:30			73	82			
7:45			315	1101	164	587	1688	64	300	70	303	603
8:00			286	161	20:00			56	64			
8:15			274	158	20:15			46	60			
8:30			255	141	20:30			37	50			
8:45			258	1073	139	599	1672	55	194	64	238	432
9:00			166	111	21:00			43	44			
9:15			173	123	21:15			37	44			
9:30			142	127	21:30			35	49			
9:45			98	579	110	471	1050	49	164	46	183	347
10:00			125	116	22:00			32	42			
10:15			100	112	22:15			29	36			
10:30			107	106	22:30			24	37			
10:45			106	438	101	435	873	24	109	42	157	266
11:00			126	113	23:00			16	35			
11:15			143	92	23:15			14	24			
11:30			176	105	23:30			12	31			
11:45			175	620	125	435	1055	8	50	15	105	155

Total Vol. 5823 3033 **8856** 5424 7933 **13357**

Daily Totals

NB	SB	EB	WB	Combined
		11247	10966	22213

AM

PM

Split % 65.8% 34.2% **39.9%** 40.6% 59.4% **60.1%**

Peak Hour	0:30	0:30	7:15	7:30	7:15	16:45	16:15	16:30
Volume			1156	641	1792	855	1297	2107
P.H.F.			0.92	0.98	0.94	0.93	0.91	0.96

Thursday, October 03, 2019

Location: Santa Ana

PROJECT:

ADT264 WARNER AVE from MAIN ST to HALLADAY ST.

Prepared by AimTD tel. 714 253 7888

AM Period	NB	SB	EB	WB	PM Period	NB	SB	EB	WB				
0:30			16	27	12:00			167	152				
0:15			20	23	12:15			168	156				
0:30			13	25	12:30			193	164				
0:45			11	60	16	91	151	12:45	204	732	158	630	1362
1:00			5	14	13:00			231	175				
1:15			6	20	13:15			215	198				
1:30			5	18	13:30			244	204				
1:45			11	27	14	66	93	13:45	280	970	197	774	1744
2:00			16	20	14:00			252	188				
2:15			9	17	14:15			234	196				
2:30			18	9	14:30			241	218				
2:45			27	70	13	59	129	14:45	221	948	210	812	1760
3:00			20	19	15:00			236	229				
3:15			18	14	15:15			220	285				
3:30			21	8	15:30			227	270				
3:45			43	102	11	52	154	15:45	260	943	223	1007	1950
4:00			33	22	16:00			245	255				
4:15			54	13	16:15			235	277				
4:30			75	31	16:30			237	312				
4:45			71	233	28	94	327	16:45	213	930	263	1107	2037
5:00			94	34	17:00			241	275				
5:15			101	37	17:15			276	283				
5:30			230	63	17:30			319	267				
5:45			280	705	112	246	951	17:45	311	1147	253	1078	2225
6:00			224	103	18:00			265	248				
6:15			202	113	18:15			231	236				
6:30			209	109	18:30			208	245				
6:45			261	896	123	448	1344	18:45	178	882	213	942	1824
7:00			282	183	19:00			187	189				
7:15			322	231	19:15			153	156				
7:30			284	259	19:30			137	135				
7:45			324	1212	221	894	2106	19:45	123	600	115	595	1195
8:00			328	173	20:00			103	131				
8:15			286	150	20:15			106	96				
8:30			293	155	20:30			100	106				
8:45			267	1174	145	623	1797	20:45	92	401	115	448	849
9:00			196	147	21:00			94	108				
9:15			193	137	21:15			70	102				
9:30			141	153	21:30			87	88				
9:45			167	697	157	594	1291	21:45	52	303	68	366	669
10:00			146	149	22:00			61	92				
10:15			158	127	22:15			54	86				
10:30			151	135	22:30			47	58				
10:45			183	638	119	530	1168	22:45	42	204	47	283	487
11:00			158	158	23:00			26	42				
11:15			169	159	23:15			34	37				
11:30			145	146	23:30			26	36				
11:45			159	631	149	612	1243	23:45	30	116	33	148	264

Total Vol. 6445 4309 **10754** 8176 8190 **16366**

Daily Totals				
NB	SB	EB	WB	Combined
		14621	12499	27120

AM					PM				
Split %									
		59.9%	40.1%	39.7%		50.0%	50.0%	60.3%	
Peak Hour	0:30	0:30	7:15	7:00	7:15		17:15	16:30	17:00
Volume			1258	894	2142		1171	1133	2225
P.H.F.			0.96	0.86	0.97		0.92	0.91	0.95

ADT172 McFADDEN AVE from NEWHOPE ST to HARBOR BL.

Prepared by AimTD tel. 714 253 7888

AM Period	NB	SB	EB	WB	PM Period	NB	SB	EB	WB			
0:00			18	33	12:00			123	127			
0:15			23	19	12:15			125	119			
0:30			13	12	12:30			96	140			
0:45			10	64	13	77	141	120	464	106	492	956
1:00			7	16	13:00			115	127			
1:15			5	14	13:15			132	129			
1:30			7	7	13:30			124	106			
1:45			9	28	6	43	71	148	519	156	518	1037
2:00			11	18	14:00			155	162			
2:15			3	8	14:15			159	159			
2:30			5	9	14:30			145	165			
2:45			6	25	7	42	67	137	596	155	641	1237
3:00			10	3	15:00			166	180			
3:15			5	8	15:15			158	167			
3:30			11	5	15:30			139	183			
3:45			9	35	12	28	63	153	616	158	688	1304
4:00			12	12	16:00			151	163			
4:15			7	11	16:15			148	175			
4:30			20	20	16:30			148	194			
4:45			16	55	26	69	124	142	589	188	720	1309
5:00			25	22	17:00			166	233			
5:15			35	26	17:15			160	200			
5:30			32	40	17:30			171	211			
5:45			41	133	32	120	253	190	687	210	854	1541
6:00			52	44	18:00			184	178			
6:15			49	45	18:15			150	224			
6:30			69	64	18:30			152	181			
6:45			92	262	77	230	492	137	623	161	744	1367
7:00			108	95	19:00			136	159			
7:15			147	131	19:15			136	135			
7:30			159	170	19:30			128	129			
7:45			180	594	178	574	1168	96	496	129	552	1048
8:00			182	176	20:00			93	144			
8:15			207	145	20:15			92	96			
8:30			191	107	20:30			87	97			
8:45			160	740	117	545	1285	96	368	106	443	811
9:00			174	128	21:00			78	98			
9:15			140	111	21:15			87	108			
9:30			90	105	21:30			68	81			
9:45			106	510	106	450	960	67	300	70	357	657
10:00			113	115	22:00			60	76			
10:15			107	130	22:15			54	62			
10:30			108	108	22:30			41	75			
10:45			110	438	105	458	896	40	195	38	251	446
11:00			86	123	23:00			28	37			
11:15			96	107	23:15			34	32			
11:30			106	99	23:30			21	28			
11:45			120	408	114	443	851	21	104	27	124	228

Total Vol. 3292 3079 **6371** 5557 6384 **11941**

Daily Totals				
NB	SB	EB	WB	Combined
		8849	9463	18312

	AM			PM		
Split %	51.7%	48.3%	34.8%	46.5%	53.5%	65.2%
Peak Hour	7:45	7:30	7:30	17:15	17:00	17:00
Volume	760	669	1397	705	854	1541
P.H.F.	0.92	0.94	0.98	0.93	0.92	0.96

ADT181 McFADDEN AVE from GR to AVE to LYON ST.

Prepared by AimTD tel. 714 253 7888

AM Period	NB	SB	EB	WB	PM Period	NB	SB	EB	WB			
0:00			12	13	12:00			150	119			
0:15			16	21	12:15			118	118			
0:30			16	12	12:30			132	118			
0:45			10	54	13	59	113	119	519	130	485	1004
1:00			9	18	13:00			131	121			
1:15			5	13	13:15			126	135			
1:30			10	14	13:30			137	145			
1:45			15	39	13	58	97	124	518	159	560	1078
2:00			8	19	14:00			120	158			
2:15			9	9	14:15			157	148			
2:30			12	11	14:30			185	189			
2:45			11	40	16	55	95	186	648	166	661	1309
3:00			6	6	15:00			177	180			
3:15			7	8	15:15			203	196			
3:30			20	10	15:30			204	168			
3:45			33	66	24	48	114	176	760	221	765	1525
4:00			19	19	16:00			193	211			
4:15			37	20	16:15			172	191			
4:30			54	44	16:30			178	206			
4:45			58	168	51	134	302	173	716	191	799	1515
5:00			61	43	17:00			216	213			
5:15			88	50	17:15			196	191			
5:30			117	69	17:30			204	187			
5:45			137	403	80	242	645	182	798	181	772	1570
6:00			136	82	18:00			190	163			
6:15			159	82	18:15			155	193			
6:30			171	96	18:30			165	137			
6:45			195	661	115	375	1036	160	670	146	639	1309
7:00			180	121	19:00			133	143			
7:15			204	148	19:15			130	122			
7:30			179	150	19:30			117	122			
7:45			180	743	183	602	1345	127	507	104	491	998
8:00			237	154	20:00			118	98			
8:15			201	127	20:15			99	89			
8:30			145	122	20:30			99	79			
8:45			171	754	141	544	1298	69	385	93	359	744
9:00			158	97	21:00			79	66			
9:15			116	101	21:15			60	83			
9:30			114	119	21:30			72	57			
9:45			121	509	89	406	915	52	263	54	260	523
10:00			119	110	22:00			66	66			
10:15			96	95	22:15			45	62			
10:30			118	108	22:30			35	37			
10:45			94	427	96	409	836	39	185	52	217	402
11:00			125	126	23:00			40	39			
11:15			114	115	23:15			22	41			
11:30			131	126	23:30			19	35			
11:45			125	495	115	482	977	17	98	25	140	238

Total Vol. 4359 3414 **7773** 6067 6148 **12215**

Daily Totals				
NB	SB	EB	WB	Combined
		10426	9562	19988

	AM			PM		
Split %	56.1%	43.9%	38.9%	49.7%	50.3%	61.1%
Peak Hour	7:15	7:15	7:15	17:00	15:45	15:15
Volume	800	635	1435	798	829	1572
P.H.F.	0.84	0.87	0.92	0.92	0.94	0.97

Transportation Studies, Inc.

2640 Walnut Avenue, Suite L
Tustin, CA. 92780

Location : DYER ROAD
Segment : PULLMAN ST TO RED HILL AVE
Client : CITY SANTA ANA

Site: SANTA ANA
Date: 09/24/19

Interval	EB				WB				Combined		Day:	Tuesday
	AM		PM		AM		PM		AM	PM		
12:00	20	52	214	769	38	198	228	930	58	250	442	1.699
12:15	10		190		38		234		48		424	
12:30	14		183		84		230		98		413	
12:45	8		182		38		238		46		420	
01:00	13	32	204	728	24	73	246	1,032	37	105	450	1.760
01:15	11		162		28		250		39		412	
01:30	2		186		13		285		15		471	
01:45	6		176		8		251		14		427	
02:00	12	66	186	687	16	63	297	1,179	28	129	483	1.866
02:15	7		155		17		278		24		433	
02:30	17		170		18		335		35		505	
02:45	30		176		12		269		42		445	
03:00	18	187	158	741	16	60	286	1,286	34	247	444	2.027
03:15	31		191		20		332		51		523	
03:30	56		192		11		323		67		515	
03:45	82		200		13		345		95		545	
04:00	56	480	183	852	26	115	370	1,350	82	595	553	2.202
04:15	85		206		24		316		109		522	
04:30	137		227		40		342		177		569	
04:45	202		236		25		322		227		558	
05:00	175	904	243	1,101	32	209	389	1,412	207	1,113	632	2,513
05:15	205		276		36		358		241		634	
05:30	228		294		58		308		286		602	
05:45	296		288		83		357		379		645	
06:00	214	900	230	844	88	460	322	1,197	302	1,360	552	2.041
06:15	241		215		134		329		375		544	
06:30	231		234		102		313		333		547	
06:45	214		165		136		233		350		398	
07:00	220	991	146	486	172	777	300	986	392	1,768	446	1,472
07:15	251		106		176		266		427		372	
07:30	264		120		186		232		450		352	
07:45	256		114		243		188		499		302	
08:00	228	950	124	380	245	1,001	214	748	473	1,951	338	1,128
08:15	222		90		253		168		475		258	
08:30	238		74		267		170		505		244	
08:45	262		92		236		196		498		288	
09:00	218	868	82	293	224	785	194	654	442	1,653	276	947
09:15	233		84		187		158		420		242	
09:30	211		60		195		172		406		232	
09:45	206		67		179		130		385		197	
10:00	170	677	42	195	193	739	150	488	363	1,416	192	683
10:15	168		54		191		122		359		176	
10:30	181		57		175		122		356		179	
10:45	158		42		180		94		338		136	
11:00	208	870	22	83	188	776	98	285	396	1,646	120	368
11:15	219		19		201		66		420		85	
11:30	199		25		184		65		383		90	
11:45	244		17		203		56		447		73	
Totals	6,977		7,159		5,256		11,547		12,233		18,706	
Split%	57.0		38.3		43.0		61.7					
Day Totals		14,136				16,803				30,939		
Day Splits		45.7				54.3						
Peak Hour	07:15		05:00		07:45		05:00		07:45		05:00	
Volume	999		1,101		1,008		1,412		1,952		2,513	
Factor	0.95		0.94		0.94		0.91		0.97		0.97	

ADT176 McFADDEN AVE from BRISTOL ST to FLOWER ST.

Prepared by AimTD tel. 714 253 7888

AM Period	NB	SB	EB	WB	PM Period	NB	SB	EB	WB			
0:00			15	23	12:00			80	79			
0:15			23	15	12:15			103	90			
0:30			16	17	12:30			75	82			
0:45			15	69	14	69	138	74	332	73	324	656
1:00			12	15	13:00			100	78			
1:15			8	11	13:15			89	63			
1:30			5	11	13:30			79	103			
1:45			11	36	8	45	81	98	366	106	350	716
2:00			9	12	14:00			126	95			
2:15			7	9	14:15			122	116			
2:30			9	9	14:30			136	129			
2:45			4	29	8	38	67	113	497	146	486	983
3:00			7	7	15:00			147	160			
3:15			7	10	15:15			120	142			
3:30			17	10	15:30			125	137			
3:45			16	47	10	37	84	126	518	133	572	1090
4:00			18	10	16:00			115	139			
4:15			35	16	16:15			107	160			
4:30			36	26	16:30			117	154			
4:45			49	138	24	76	214	122	461	150	603	1064
5:00			50	26	17:00			109	140			
5:15			47	32	17:15			133	147			
5:30			83	45	17:30			143	143			
5:45			105	285	33	136	421	151	536	143	573	1109
6:00			87	60	18:00			125	131			
6:15			101	61	18:15			129	131			
6:30			103	73	18:30			132	138			
6:45			110	401	75	269	670	104	490	127	527	1017
7:00			119	96	19:00			116	123			
7:15			175	123	19:15			104	116			
7:30			194	118	19:30			102	100			
7:45			179	667	124	461	1128	98	420	104	443	863
8:00			161	119	20:00			90	102			
8:15			148	105	20:15			84	94			
8:30			124	66	20:30			85	56			
8:45			94	527	70	360	887	64	323	73	325	648
9:00			75	58	21:00			80	63			
9:15			85	74	21:15			75	47			
9:30			82	64	21:30			73	48			
9:45			70	312	63	259	571	63	291	62	220	511
10:00			70	84	22:00			40	61			
10:15			82	74	22:15			57	50			
10:30			87	68	22:30			35	38			
10:45			71	310	85	311	621	28	160	43	192	352
11:00			89	73	23:00			33	44			
11:15			68	75	23:15			30	33			
11:30			99	86	23:30			32	30			
11:45			84	340	93	327	667	28	123	15	122	245

Total Vol. 3161 2388 **5549** 4517 4737 **9254**

Daily Totals				
NB	SB	EB	WB	Combined
		7678	7125	14803

	AM			PM		
Split %	57.0%	43.0%	37.5%	48.8%	51.2%	62.5%
Peak Hour	7:15	7:15	7:15	17:15	16:15	17:15
Volume	709	484	1193	552	604	1116
P.H.F.	0.91	0.98	0.96	0.91	0.94	0.95

ADT169 MAIN ST from MAINPLACE DR to GARDEN GROVE FWY.

Prepared by AimTD tel. 714 253 7888

AM Period	NB	SB	EB	WB	PM Period	NB	SB	EB	WB
0:00	27	46			12:00	233	223		
0:15	20	34			12:15	261	227		
0:30	21	42			12:30	230	211		
0:45	34	102	23	145	12:45	231	955	269	930
1:00	31	32			13:00	197	240		
1:15	33	23			13:15	229	266		
1:30	34	19			13:30	199	247		
1:45	26	124	26	100	13:45	237	862	236	989
2:00	31	11			14:00	214	230		
2:15	31	28			14:15	270	234		
2:30	34	25			14:30	248	222		
2:45	34	130	10	74	14:45	209	941	246	932
3:00	23	30			15:00	174	251		
3:15	32	27			15:15	224	245		
3:30	34	24			15:30	245	254		
3:45	46	135	28	109	15:45	233	876	273	1023
4:00	41	25			16:00	217	238		
4:15	67	26			16:15	260	318		
4:30	113	26			16:30	240	295		
4:45	115	336	38	115	16:45	309	1026	319	1170
5:00	95	54			17:00	291	327		
5:15	52	58			17:15	341	302		
5:30	89	88			17:30	317	281		
5:45	87	323	88	288	17:45	296	1245	256	1166
6:00	101	109			18:00	254	216		
6:15	117	109			18:15	270	211		
6:30	161	196			18:30	225	192		
6:45	211	590	207	621	18:45	230	979	201	820
7:00	144	308			19:00	186	189		
7:15	166	340			19:15	175	210		
7:30	194	373			19:30	160	189		
7:45	233	737	307	1328	19:45	144	665	200	788
8:00	264	353			20:00	129	186		
8:15	206	320			20:15	111	132		
8:30	211	320			20:30	113	137		
8:45	218	899	232	1225	20:45	74	427	130	585
9:00	175	251			21:00	70	143		
9:15	149	206			21:15	88	144		
9:30	163	175			21:30	54	103		
9:45	208	695	186	818	21:45	63	275	87	477
10:00	190	169			22:00	155	86		
10:15	186	186			22:15	141	85		
10:30	206	190			22:30	135	76		
10:45	177	759	216	761	22:45	106	537	89	336
11:00	194	190			23:00	88	92		
11:15	245	206			23:15	64	65		
11:30	235	203			23:30	69	69		
11:45	209	883	226	825	23:45	56	277	68	294
Total Vol.	5713	6409		12122		9065	9510		18575
								Daily Totals	
						NB	SB	EB	WB
						14778	15919		30697
								PM	
Split %	47.1%	52.9%		39.5%		48.8%	51.2%		60.5%
Peak Hour	11:30	7:15		7:30		16:45	16:15		16:45
Volume	938	1373		2250		1258	1259		2487
P.H.F.	0.90	0.92		0.91		0.94	0.96		0.97

Transportation Studies, Inc.

2640 Walnut Avenue, Suite L
Tustin, CA. 92780

Location : FIRST STREET
Segment : BRISTOL ST TO FLOWER ST
Client : CITY SANTA ANA

Site: SANTA ANA
Date: 09/11/19

Interval	EB				WB				Combined		Day:	Wednesday
	AM	PM	AM	PM	AM	PM	AM	PM				
12:00	54	172	264	1.057	56	179	214	903	110	351	478	1.960
12:15	44		275		39		220		83		495	
12:30	40		268		45		221		85		489	
12:45	34		250		39		248		73		498	
01:00	30	108	294	1.201	30	105	260	1.055	60	213	554	2.256
01:15	27		312		30		279		57		591	
01:30	25		321		26		238		51		559	
01:45	26		274		19		278		45		552	
02:00	30	117	308	1.210	32	129	306	1.227	62	246	614	2.437
02:15	24		288		24		298		48		586	
02:30	31		308		36		277		67		585	
02:45	32		306		37		346		69		652	
03:00	20	115	340	1.336	24	104	340	1.445	44	219	680	2.781
03:15	25		318		18		388		43		706	
03:30	30		320		28		338		58		658	
03:45	40		358		34		379		74		737	
04:00	52	286	333	1.393	33	155	374	1.478	85	441	707	2.871
04:15	74		363		24		374		98		737	
04:30	80		342		52		366		132		708	
04:45	80		355		46		364		126		719	
05:00	103	596	350	1.468	51	267	376	1.486	154	863	726	2.954
05:15	127		398		54		339		181		737	
05:30	174		343		76		381		250		724	
05:45	192		377		86		390		278		767	
06:00	213	1.098	326	1.240	92	494	384	1.369	305	1.592	710	2.609
06:15	255		324		130		342		385		666	
06:30	295		270		110		336		405		606	
06:45	335		320		162		307		497		627	
07:00	372	1.684	294	1.009	185	944	258	966	557	2.628	552	1.975
07:15	450		285		212		234		662		519	
07:30	455		218		253		252		708		470	
07:45	407		212		294		222		701		434	
08:00	356	1.452	201	754	253	865	228	719	609	2.317	429	1.473
08:15	362		207		207		184		569		391	
08:30	354		178		208		170		562		348	
08:45	380		168		197		137		577		305	
09:00	349	1.177	181	639	188	832	152	629	537	2.009	333	1.268
09:15	294		154		200		179		494		333	
09:30	269		152		220		142		489		294	
09:45	265		152		224		156		489		308	
10:00	244	992	129	381	224	846	130	464	468	1.838	259	845
10:15	230		98		214		122		444		220	
10:30	280		78		200		106		480		184	
10:45	238		76		208		106		446		182	
11:00	220	1.014	71	241	194	938	104	281	414	1.952	175	522
11:15	263		76		240		74		503		150	
11:30	243		45		236		52		479		97	
11:45	288		49		268		51		556		100	
Totals	8,811		11,929		5,858		12,022		14,669		23,951	
Split%	60.1		49.8		39.9		50.2					
Day Totals		20,740				17,880				38,620		
Day Splits		53.7				46.3						
Peak Hour	07:00		05:00		07:15		05:30		07:15		05:00	
Volume	1,684		1,468		1,012		1,497		2,680		2,954	
Factor	0.93		0.92		0.86		0.96		0.95		0.96	

Transportation Studies, Inc.

2640 Walnut Avenue, Suite L
Tustin, CA. 92780

Location : FAIRHAVEN AVENUE
Segment : CAMBRIDGE ST TO TUSTIN AVE
Client : CITY SANTA ANA

Site: SANTA ANA
Date: 10/03/19

Interval	WB			EB			Combined		Day:	Thursday		
	AM	PM		AM	PM		AM	PM				
12:00	10	25	59	223	6	27	68	280	16	52	127	503
12:15	4		56		7		68		11		124	
12:30	7		46		4		70		11		116	
12:45	4		62		10		74		14		136	
01:00	4	11	66	269	2	13	68	261	6	24	134	530
01:15	4		76		5		54		9		130	
01:30	1		64		4		69		5		133	
01:45	2		63		2		70		4		133	
02:00	1	7	78	376	3	8	73	315	4	15	151	691
02:15	3		88		2		101		5		189	
02:30	0		94		1		78		1		172	
02:45	3		116		2		63		5		179	
03:00	0	6	118	452	3	8	114	360	3	14	232	812
03:15	2		134		4		88		6		222	
03:30	4		104		1		68		5		172	
03:45	0		96		0		90		0		186	
04:00	0	11	96	532	5	17	85	359	5	28	181	891
04:15	2		158		5		92		7		250	
04:30	3		116		5		102		8		218	
04:45	6		162		2		80		8		242	
05:00	5	35	155	657	7	43	108	418	12	78	263	1,075
05:15	9		169		8		106		17		275	
05:30	10		175		11		100		21		275	
05:45	11		158		17		104		28		262	
06:00	12	93	135	457	24	207	70	276	36	300	205	733
06:15	23		124		34		72		57		196	
06:30	26		110		73		74		99		184	
06:45	32		88		76		60		108		148	
07:00	41	354	66	209	118	705	46	187	159	1,059	112	396
07:15	65		58		177		53		242		111	
07:30	100		48		198		46		298		94	
07:45	148		37		212		42		360		79	
08:00	139	362	30	108	172	567	30	117	311	929	60	225
08:15	92		22		164		28		256		50	
08:30	72		34		111		28		183		62	
08:45	59		22		120		31		179		53	
09:00	50	194	18	78	74	304	22	93	124	498	40	171
09:15	44		30		80		28		124		58	
09:30	54		17		70		27		124		44	
09:45	46		13		80		16		126		29	
10:00	66	220	23	57	51	225	14	70	117	445	37	127
10:15	36		14		66		27		102		41	
10:30	56		14		44		20		100		34	
10:45	62		6		64		9		126		15	
11:00	56	221	8	20	68	248	10	32	124	469	18	52
11:15	56		7		54		7		110		14	
11:30	49		3		56		9		105		12	
11:45	60		2		70		6		130		8	
Totals	1,539		3,438		2,372		2,768		3,911		6,206	
Split%	39.4		55.4		60.6		44.6					
Day Totals		4,977				5,140				10,117		
Day Splits		49.2				50.8						
Peak Hour	07:30		04:45		07:15		05:00		07:30		05:00	
Volume	479		661		759		418		1,225		1,075	
Factor	0.81		0.94		0.90		0.97		0.85		0.98	

Transportation Studies, Inc.

2640 Walnut Avenue, Suite L
Tustin, CA. 92780

Location : FOURTH STREET
Segment : FRENCH ST TO GRAND AVE
Client : CITY SANTA ANA

Site: SANTA ANA
Date: 10/09/19

Interval	EB				WB				Combined				Day:	Wednesday
	AM		PM		AM		PM		AM		PM			
12:00	10	34	78	296	21	71	122	509	31	105	200	805		
12:15	9		66		13		125		22		191			
12:30	10		74		21		134		31		208			
12:45	5		78		16		128		21		206			
01:00	6	38	76	396	16	41	137	598	22	79	213	994		
01:15	14		111		7		141		21		252			
01:30	12		115		8		180		20		295			
01:45	6		94		10		140		16		234			
02:00	5	24	106	388	10	40	155	575	15	64	261	963		
02:15	6		84		12		148		18		232			
02:30	8		103		6		118		14		221			
02:45	5		95		12		154		17		249			
03:00	3	15	102	428	4	22	168	691	7	37	270	1,119		
03:15	2		97		8		177		10		274			
03:30	6		120		4		164		10		284			
03:45	4		109		6		182		10		291			
04:00	7	78	116	480	11	47	190	728	18	125	306	1,208		
04:15	16		112		12		172		28		284			
04:30	26		116		10		182		36		298			
04:45	29		136		14		184		43		320			
05:00	26	190	152	588	18	98	188	782	44	288	340	1,370		
05:15	38		155		24		177		62		332			
05:30	56		135		26		231		82		366			
05:45	70		146		30		186		100		332			
06:00	54	345	116	342	32	162	202	610	86	507	318	952		
06:15	67		82		40		135		107		217			
06:30	110		70		32		133		142		203			
06:45	114		74		58		140		172		214			
07:00	142	817	54	222	81	560	121	402	223	1,377	175	624		
07:15	185		63		118		97		303		160			
07:30	266		56		167		98		433		154			
07:45	224		49		194		86		418		135			
08:00	202	494	28	156	144	418	68	254	346	912	96	410		
08:15	118		32		92		69		210		101			
08:30	98		46		100		60		198		106			
08:45	76		50		82		57		158		107			
09:00	66	284	44	153	106	387	47	203	172	671	91	356		
09:15	76		44		92		54		168		98			
09:30	63		33		88		53		151		86			
09:45	79		32		101		49		180		81			
10:00	61	247	50	123	87	396	47	170	148	643	97	293		
10:15	61		33		97		36		158		69			
10:30	65		21		104		46		169		67			
10:45	60		19		108		41		168		60			
11:00	46	248	16	57	92	406	20	95	138	654	36	152		
11:15	57		15		89		22		146		37			
11:30	76		16		116		30		192		46			
11:45	69		10		109		23		178		33			
Totals	2,814		3,629		2,648		5,617		5,462		9,246			
Split%	51.5		39.2		48.5		60.8							
Day Totals		6,443				8,265				14,708				
Day Splits		43.8				56.2								
Peak Hour	07:15		05:00		07:15		05:15		07:15		05:00			
Volume	877		588		623		796		1,500		1,370			
Factor	0.82		0.95		0.80		0.86		0.87		0.94			

Transportation Studies, Inc.

2640 Walnut Avenue, Suite L
Tustin, CA. 92780

Location : BROADWAY
Segment : CIVIC CENTER TO SEVENTEENTH
Client : CITY SANTA ANA

Site: SANTA ANA
Date: 09/19/19
File: D1909027

Interval	NB				SB				Combined		Day:	Thursday
	AM		PM		AM		PM		AM	PM		
12:00	3	18	130	481	18	85	142	584	21	103	272	1.065
12:15	2		118		29		136		31		254	
12:30	8		129		18		138		26		267	
12:45	5		104		20		168		25		272	
01:00	8	15	94	440	7	46	162	686	15	61	256	1.126
01:15	5		108		16		164		21		272	
01:30	2		136		11		188		13		324	
01:45	0		102		12		172		12		274	
02:00	1	14	140	615	18	48	161	679	19	62	301	1.294
02:15	4		145		8		169		12		314	
02:30	4		168		9		163		13		331	
02:45	5		162		13		186		18		348	
03:00	0	11	208	908	9	33	186	678	9	44	394	1.586
03:15	1		223		6		170		7		393	
03:30	9		253		11		162		20		415	
03:45	1		224		7		160		8		384	
04:00	1	24	259	1,105	13	98	157	690	14	122	416	1.795
04:15	5		238		15		159		20		397	
04:30	8		316		22		170		30		486	
04:45	10		292		48		204		58		496	
05:00	16	70	312	1,050	48	271	188	723	64	341	500	1,773
05:15	15		228		44		201		59		429	
05:30	23		256		78		171		101		427	
05:45	16		254		101		163		117		417	
06:00	23	144	281	862	120	619	173	583	143	763	454	1,445
06:15	32		226		123		149		155		375	
06:30	54		195		146		139		200		334	
06:45	35		160		230		122		265		282	
07:00	52	368	143	443	276	1,279	114	456	328	1,647	257	899
07:15	58		114		322		126		380		240	
07:30	122		100		367		116		489		216	
07:45	136		86		314		100		450		186	
08:00	193	508	121	402	282	982	90	385	475	1,490	211	787
08:15	136		114		237		126		373		240	
08:30	91		92		213		86		304		178	
08:45	88		75		250		83		338		158	
09:00	67	312	85	300	212	668	100	329	279	980	185	629
09:15	74		82		153		80		227		162	
09:30	95		79		159		82		254		161	
09:45	76		54		144		67		220		121	
10:00	69	300	74	194	138	558	54	239	207	858	128	433
10:15	74		50		146		78		220		128	
10:30	73		44		142		54		215		98	
10:45	84		26		132		53		216		79	
11:00	72	402	15	62	100	493	51	166	172	895	66	228
11:15	102		26		133		47		235		73	
11:30	116		10		130		31		246		41	
11:45	112		11		130		37		242		48	
Totals	2,186		6,862		5,180		6,198		7,366		13,060	
Split%	29.7		52.5		70.3		47.5					
Day Totals		9,048				11,378				20,426		
Day Splits		44.3				55.7						
Peak Hour	07:30		04:15		07:15		04:45		07:15		04:30	
Volume	587		1,158		1,285		764		1,794		1,911	
Factor	0.76		0.92		0.88		0.94		0.92		0.96	

Transportation Studies, Inc.

2640 Walnut Avenue, Suite L
Tustin, CA. 92780

Location : BROADWAY
Segment : SANTA ANA BL TO CIVIC CENTER D
Client : CITY SANTA ANA

Site: SANTA ANA
Date: 09/19/19

Interval	NB				SB				Combined		Day:	Thursday
	AM		PM		AM		PM		AM	PM		
12:00	4	6	78	352	17	62	106	460	21	68	184	812
12:15	0		78		20		124		20		202	
12:30	1		106		13		106		14		212	
12:45	1		90		12		124		13		214	
01:00	3	9	99	389	6	31	126	498	9	40	225	887
01:15	4		86		10		119		14		205	
01:30	1		114		8		135		9		249	
01:45	1		90		7		118		8		208	
02:00	0	5	106	520	12	32	130	531	12	37	236	1.051
02:15	0		110		5		126		5		236	
02:30	1		156		5		136		6		292	
02:45	4		148		10		139		14		287	
03:00	0	8	189	753	4	19	154	566	4	27	343	1.319
03:15	0		196		2		148		2		344	
03:30	4		174		9		126		13		300	
03:45	4		194		4		138		8		332	
04:00	1	18	210	858	10	62	132	595	11	80	342	1.453
04:15	2		198		11		143		13		341	
04:30	5		238		13		148		18		386	
04:45	10		212		28		172		38		384	
05:00	5	33	203	836	24	154	168	641	29	187	371	1.477
05:15	7		209		24		192		31		401	
05:30	13		216		45		137		58		353	
05:45	8		208		61		144		69		352	
06:00	10	56	258	742	74	355	156	523	84	411	414	1.265
06:15	11		188		73		133		84		321	
06:30	17		164		82		124		99		288	
06:45	18		132		126		110		144		242	
07:00	36	200	129	353	154	690	100	405	190	890	229	758
07:15	42		92		186		103		228		195	
07:30	58		84		196		98		254		182	
07:45	64		48		154		104		218		152	
08:00	118	396	96	398	167	675	76	347	285	1.071	172	745
08:15	111		122		186		118		297		240	
08:30	82		100		148		86		230		186	
08:45	85		80		174		67		259		147	
09:00	67	270	82	305	141	482	84	299	208	752	166	604
09:15	70		84		108		86		178		170	
09:30	68		74		113		75		181		149	
09:45	65		65		120		54		185		119	
10:00	66	251	78	184	104	406	58	221	170	657	136	405
10:15	53		59		104		68		157		127	
10:30	80		39		106		50		186		89	
10:45	52		8		92		45		144		53	
11:00	50	284	8	21	88	390	45	156	138	674	53	177
11:15	78		6		113		44		191		50	
11:30	84		6		89		26		173		32	
11:45	72		1		100		41		172		42	
Totals	1.536		5.711		3.358		5.242		4.894		10.953	
Split%	31.4		52.1		68.6		47.9					
Day Totals		7.247				8.600				15.847		
Day Splits		45.7				54.3						
Peak Hour	08:00		05:15		07:15		04:30		08:00		04:30	
Volume	396		891		703		680		1.071		1.542	
Factor	0.84		0.86		0.90		0.89		0.90		0.96	

Transportation Studies, Inc.

2640 Walnut Avenue, Suite L
Tustin, CA. 92780

Location : CHESTNUT AVENUE
Segment : STANDARD AVE TO GRAND AVE
Client : CITY SANTA ANA

Site: SANTA ANA
Date: 09/25/19

Interval	EB				WB				Combined		Day:	Wednesday
	AM	PM	AM	PM	AM	PM	AM	PM				
12:00	0	1	20	55	0	4	16	70	0	5	36	125
12:15	0		9		1		16		1		25	
12:30	0		14		1		16		1		30	
12:45	1		12		2		22		3		34	
01:00	1	1	22	126	2	4	15	137	3	5	37	263
01:15	0		32		2		14		2		46	
01:30	0		50		0		70		0		120	
01:45	0		22		0		38		0		60	
02:00	0	1	18	69	0	2	30	96	0	3	48	165
02:15	0		16		0		16		0		32	
02:30	0		18		0		34		0		52	
02:45	1		17		2		16		3		33	
03:00	0	2	14	67	0	2	14	78	0	4	28	145
03:15	1		20		1		24		2		44	
03:30	1		13		0		20		1		33	
03:45	0		20		1		20		1		40	
04:00	0	4	20	64	0	9	32	112	0	13	52	176
04:15	2		16		1		24		3		40	
04:30	0		16		5		26		5		42	
04:45	2		12		3		30		5		42	
05:00	10	39	36	105	6	39	42	130	16	78	78	235
05:15	8		20		14		32		22		52	
05:30	11		23		9		26		20		49	
05:45	10		26		10		30		20		56	
06:00	10	75	25	63	15	69	24	78	25	144	49	141
06:15	19		12		14		14		33		26	
06:30	24		16		16		20		40		36	
06:45	22		10		24		20		46		30	
07:00	32	224	6	26	18	192	12	35	50	416	18	61
07:15	54		8		42		2		96		10	
07:30	80		7		78		11		158		18	
07:45	58		5		54		10		112		15	
08:00	13	52	10	23	18	56	13	26	31	108	23	49
08:15	13		3		14		6		27		9	
08:30	14		6		7		4		21		10	
08:45	12		4		17		3		29		7	
09:00	16	54	4	18	10	47	3	22	26	101	7	40
09:15	14		2		19		5		33		7	
09:30	10		6		14		9		24		15	
09:45	14		6		4		5		18		11	
10:00	21	54	2	13	17	63	4	16	38	117	6	29
10:15	18		4		20		3		38		7	
10:30	8		3		19		6		27		9	
10:45	7		4		7		3		14		7	
11:00	11	51	1	8	13	66	3	13	24	117	4	21
11:15	16		3		23		3		39		6	
11:30	14		3		14		5		28		8	
11:45	10		1		16		2		26		3	
Totals	558		637		553		813		1,111		1,450	
Split%	50.2		43.9		49.8		56.1					
Day Totals		1,195				1,366				2,561		
Day Splits		46.7				53.3						
Peak Hour	07:00		01:00		07:00		01:30		07:00		01:15	
Volume	224		126		192		154		416		274	
Factor	0.70		0.63		0.62		0.55		0.66		0.57	

Transportation Studies, Inc.

2640 Walnut Avenue, Suite L
Tustin, CA. 92780

Location : CIVIC CENTER DRIVE
Segment : MAIN ST TO SANTIAGO
Client : CITY SANTA ANA

Site: SANTA ANA
Date: 09/18/19

Interval	WB				EB				Combined				Day:	Wednesday	
	AM		PM		AM		PM		AM		PM				
12:00	4	13	50	217	9	41	84	337	13	54	134	554			
12:15	3		53		12		90		15		143				
12:30	2		54		10		94		12		148				
12:45	4		60		10		69		14		129				
01:00	3	9	71	268	4	19	70	357	7	28	141	625			
01:15	2		71		6		70		8		141				
01:30	2		66		6		130		8		196				
01:45	2		60		3		87		5		147				
02:00	1	4	53	208	1	14	86	388	2	18	139	596			
02:15	1		46		3		100		4		146				
02:30	1		63		8		92		9		155				
02:45	1		46		2		110		3		156				
03:00	2	7	79	315	5	15	116	503	7	22	195	818			
03:15	0		98		2		121		2		219				
03:30	4		72		5		148		9		220				
03:45	1		66		3		118		4		184				
04:00	4	18	80	288	7	44	153	744	11	62	233	1,032			
04:15	2		80		10		150		12		230				
04:30	4		66		11		191		15		257				
04:45	8		62		16		250		24		312				
05:00	10	63	64	270	18	101	234	654	28	164	298	924			
05:15	9		57		17		188		26		245				
05:30	16		75		32		130		48		205				
05:45	28		74		34		102		62		176				
06:00	24	165	62	183	29	207	110	380	53	372	172	563			
06:15	29		43		42		105		71		148				
06:30	26		35		66		93		92		128				
06:45	86		43		70		72		156		115				
07:00	76	529	39	144	68	472	74	223	144	1,001	113	367			
07:15	116		42		100		56		216		98				
07:30	182		32		144		45		326		77				
07:45	155		31		160		48		315		79				
08:00	140	417	37	99	153	376	56	227	293	793	93	326			
08:15	98		28		96		60		194		88				
08:30	109		22		60		57		169		79				
08:45	70		12		67		54		137		66				
09:00	62	226	24	84	54	222	26	124	116	448	50	208			
09:15	68		20		60		40		128		60				
09:30	48		26		56		36		104		62				
09:45	48		14		52		22		100		36				
10:00	55	170	10	32	56	228	28	93	111	398	38	125			
10:15	32		8		56		32		88		40				
10:30	48		10		56		22		104		32				
10:45	35		4		60		11		95		15				
11:00	50	203	4	15	90	384	11	64	140	587	15	79			
11:15	46		4		89		20		135		24				
11:30	55		4		101		18		156		22				
11:45	52		3		104		15		156		18				
Totals	1,824		2,123		2,123		4,094		3,947		6,217				
Split%	46.2		34.1		53.8		65.9								
Day Totals		3,947				6,217				10,164					
Day Splits		38.8				61.2									
Peak Hour	07:15		03:15		07:15		04:30		07:15		04:30				
Volume	593		316		557		863		1,150		1,112				
Factor	0.81		0.81		0.87		0.86		0.88		0.89				

Transportation Studies, Inc.

2640 Walnut Avenue, Suite L

Tustin, CA. 92780

Location : CIVIC CENTER DRIVE
 Segment : FAIRVIEW ST TO RAITT ST
 Client : CITY SANTA ANA

Site: SANTA ANA
 Date: 09/18/19

Interval	EB				WB				Combined				Day:	Wednesday
	AM		PM		AM		PM		AM		PM			
12:00	9	46	59	291	10	39	90	317	19	85	149	608		
12:15	17		64		9		77		26		141			
12:30	14		82		14		76		28		158			
12:45	6		86		6		74		12		160			
01:00	13	30	96	347	13	39	80	403	26	69	176	750		
01:15	10		96		14		88		24		184			
01:30	3		82		5		112		8		194			
01:45	4		73		7		123		11		196			
02:00	8	24	96	360	11	25	99	491	19	49	195	851		
02:15	7		94		3		134		10		228			
02:30	3		82		6		142		9		224			
02:45	6		88		5		116		11		204			
03:00	2	17	136	482	3	30	142	524	5	47	278	1,006		
03:15	3		112		11		154		14		266			
03:30	7		122		8		114		15		236			
03:45	5		112		8		114		13		226			
04:00	6	48	121	508	12	87	120	576	18	135	241	1,084		
04:15	10		128		22		144		32		272			
04:30	16		128		24		160		40		288			
04:45	16		131		29		152		45		283			
05:00	32	127	144	661	34	167	162	660	66	294	306	1,321		
05:15	26		174		26		196		52		370			
05:30	31		192		59		158		90		350			
05:45	38		151		48		144		86		295			
06:00	44	299	128	477	54	305	137	408	98	604	265	885		
06:15	54		128		72		108		126		236			
06:30	82		126		74		91		156		217			
06:45	119		95		105		72		224		167			
07:00	147	831	96	326	107	437	76	310	254	1,268	172	636		
07:15	186		70		102		72		288		142			
07:30	262		84		114		82		376		166			
07:45	236		76		114		80		350		156			
08:00	156	560	79	232	132	435	78	271	288	995	157	503		
08:15	164		52		100		66		264		118			
08:30	118		53		103		62		221		115			
08:45	122		48		100		65		222		113			
09:00	74	290	54	190	64	272	67	240	138	562	121	430		
09:15	61		60		60		68		121		128			
09:30	77		46		82		60		159		106			
09:45	78		30		66		45		144		75			
10:00	78	271	25	124	64	279	41	118	142	550	66	242		
10:15	66		40		96		28		162		68			
10:30	70		27		65		32		135		59			
10:45	57		32		54		17		111		49			
11:00	62	252	20	61	64	285	24	64	126	537	44	125		
11:15	53		11		65		19		118		30			
11:30	66		15		66		14		132		29			
11:45	71		15		90		7		161		22			
Totals	2,795		4,059		2,400		4,382		5,195		8,441			
Split%	53.8		48.1		46.2		51.9							
Day Totals		6,854				6,782				13,636				
Day Splits		50.3				49.7								
Peak Hour	07:15		05:00		07:15		04:30		07:15		05:00			
Volume	840		661		462		670		1,302		1,321			
Factor	0.80		0.86		0.88		0.85		0.87		0.89			

Transportation Studies, Inc.

2640 Walnut Avenue, Suite L
Tustin, CA. 92780

Location : FLOWER STREET
Segment : WARNER AVE TO EDINGER AVE
Client : CITY SANTA ANA

Site: SANTA ANA
Date: 09/10/19

Interval	NB			SB			Combined		Day:	Tuesday		
	AM	PM		AM	PM		AM	PM				
12:00	15	46	52	209	7	36	66	262	22	82	118	471
12:15	12		48		6		78		18		126	
12:30	9		47		13		60		22		107	
12:45	10		62		10		58		20		120	
01:00	11	25	52	248	6	25	60	241	17	50	112	489
01:15	8		46		5		50		13		96	
01:30	3		71		4		62		7		133	
01:45	3		79		10		69		13		148	
02:00	0	11	73	391	8	23	77	381	8	34	150	772
02:15	2		86		2		83		4		169	
02:30	4		92		4		116		8		208	
02:45	5		140		9		105		14		245	
03:00	2	18	135	524	3	34	66	298	5	52	201	822
03:15	2		134		9		66		11		200	
03:30	6		131		10		86		16		217	
03:45	8		124		12		80		20		204	
04:00	2	27	122	481	10	101	74	336	12	128	196	817
04:15	5		121		13		84		18		205	
04:30	7		118		41		84		48		202	
04:45	13		120		37		94		50		214	
05:00	10	91	134	525	33	255	100	408	43	346	234	933
05:15	26		140		46		100		72		240	
05:30	23		127		86		90		109		217	
05:45	32		124		90		118		122		242	
06:00	35	161	130	465	61	342	94	339	96	503	224	804
06:15	29		120		77		96		106		216	
06:30	44		120		106		72		150		192	
06:45	53		95		98		77		151		172	
07:00	43	270	78	308	118	474	70	282	161	744	148	590
07:15	77		73		122		73		199		146	
07:30	79		84		130		72		209		156	
07:45	71		73		104		67		175		140	
08:00	89	302	83	258	132	466	65	207	221	768	148	465
08:15	80		69		104		54		184		123	
08:30	68		60		127		42		195		102	
08:45	65		46		103		46		168		92	
09:00	33	155	45	186	86	263	38	141	119	418	83	327
09:15	36		50		53		29		89		79	
09:30	47		46		62		40		109		86	
09:45	39		45		62		34		101		79	
10:00	48	175	36	138	50	219	30	115	98	394	66	253
10:15	40		31		66		28		106		59	
10:30	42		40		44		36		86		76	
10:45	45		31		59		21		104		52	
11:00	40	214	33	80	68	238	20	61	108	452	53	141
11:15	52		16		56		16		108		32	
11:30	66		18		62		11		128		29	
11:45	56		13		52		14		108		27	

Totals	1,495		3,813		2,476		3,071		3,971		6,884	
Split%	37.6		55.4		62.4		44.6					

Day Totals		5,308				5,547			10,855			
Day Splits		48.9				51.1						

Peak Hour	07:30		02:45		07:15		05:00		07:15		05:00	
Volume	319		540		488		408		804		933	
Factor	0.90		0.96		0.92		0.86		0.91		0.96	

ADT138 HAZARD AVE from EUCLID ST to NEWHOPE ST.

Prepared by AimTD tel. 714 253 7888

AM Period	NB	SB	EB	WB	PM Period	NB	SB	EB	WB			
0:00			10	18	12:00			46	69			
0:15			8	6	12:15			51	47			
0:30			4	5	12:30			55	63			
0:45			4	26	10	39	65	52	204	45	224	428
1:00			4	5	13:00			59	43			
1:15			6	4	13:15			53	60			
1:30			12	4	13:30			63	55			
1:45			6	28	6	19	47	77	252	73	231	483
2:00			4	0	14:00			61	74			
2:15			4	3	14:15			85	77			
2:30			0	0	14:30			78	64			
2:45			3	11	3	6	17	90	314	64	279	593
3:00			4	7	15:00			91	94			
3:15			7	2	15:15			90	81			
3:30			5	6	15:30			90	79			
3:45			0	16	3	18	34	117	388	76	330	718
4:00			4	4	16:00			86	84			
4:15			10	6	16:15			75	78			
4:30			10	14	16:30			78	96			
4:45			12	36	10	34	70	97	336	100	358	694
5:00			11	13	17:00			90	96			
5:15			12	12	17:15			89	146			
5:30			19	14	17:30			95	125			
5:45			28	70	15	54	124	105	379	132	499	878
6:00			27	18	18:00			84	133			
6:15			32	21	18:15			90	106			
6:30			40	31	18:30			88	90			
6:45			54	153	37	107	260	91	353	83	412	765
7:00			55	40	19:00			65	71			
7:15			94	81	19:15			65	67			
7:30			114	136	19:30			60	49			
7:45			156	419	172	429	848	46	236	46	233	469
8:00			110	126	20:00			56	33			
8:15			120	81	20:15			54	46			
8:30			121	64	20:30			39	36			
8:45			82	433	60	331	764	42	191	33	148	339
9:00			68	60	21:00			33	29			
9:15			58	79	21:15			41	27			
9:30			47	67	21:30			28	21			
9:45			50	223	71	277	500	26	128	40	117	245
10:00			70	42	22:00			23	25			
10:15			47	51	22:15			23	24			
10:30			49	52	22:30			16	17			
10:45			48	214	47	192	406	12	74	11	77	151
11:00			79	48	23:00			17	14			
11:15			54	66	23:15			8	16			
11:30			51	55	23:30			12	9			
11:45			68	252	34	203	455	9	46	13	52	98

Total Vol. 1881 1709 **3590** 2901 2960 **5861**

Daily Totals

NB	SB	EB	WB	Combined
		4782	4669	9451

AM

PM

Split %	52.4%	47.6%	38.0%	49.5%	50.5%	62.0%
Peak Hour	7:45	7:15	7:30	15:00	17:15	17:15
Volume	507	515	1015	388	536	909
P.H.F.	0.81	0.75	0.77	0.83	0.92	0.96

ADT179 McFADDEN AVE from MAIN ST to STANDARD AVE.

Prepared by AimTD tel. 714 253 7888

AM Period	NB	SB	EB	WB	PM Period	NB	SB	EB	WB			
0:00			15	24	12:00			76	89			
0:15			12	17	12:15			87	95			
0:30			13	14	12:30			92	79			
0:45			12	52	13	68	120	92	347	78	341	688
1:00			7	13	13:00			63	81			
1:15			7	14	13:15			87	86			
1:30			6	6	13:30			86	115			
1:45			10	30	11	44	74	95	331	106	388	719
2:00			15	11	14:00			95	125			
2:15			5	11	14:15			116	152			
2:30			5	6	14:30			130	187			
2:45			7	32	6	34	66	127	468	167	631	1099
3:00			6	5	15:00			130	181			
3:15			11	7	15:15			151	180			
3:30			23	5	15:30			107	196			
3:45			37	77	14	31	108	127	515	187	744	1259
4:00			18	7	16:00			108	182			
4:15			44	12	16:15			100	221			
4:30			55	27	16:30			100	196			
4:45			57	174	17	63	237	113	421	220	819	1240
5:00			60	20	17:00			114	208			
5:15			82	27	17:15			109	211			
5:30			109	41	17:30			120	203			
5:45			168	419	36	124	543	122	465	154	776	1241
6:00			136	43	18:00			134	175			
6:15			145	51	18:15			116	172			
6:30			157	37	18:30			110	157			
6:45			185	623	49	180	803	128	488	125	629	1117
7:00			214	67	19:00			114	110			
7:15			187	80	19:15			114	124			
7:30			220	84	19:30			99	103			
7:45			199	820	98	329	1149	88	415	101	438	853
8:00			164	107	20:00			101	88			
8:15			161	87	20:15			84	84			
8:30			125	77	20:30			71	44			
8:45			149	599	66	337	936	66	322	67	283	605
9:00			88	72	21:00			66	58			
9:15			97	68	21:15			71	63			
9:30			84	86	21:30			68	53			
9:45			83	352	73	299	651	55	260	62	236	496
10:00			76	92	22:00			60	69			
10:15			80	72	22:15			36	53			
10:30			87	64	22:30			25	46			
10:45			67	310	80	308	618	24	145	42	210	355
11:00			95	74	23:00			36	40			
11:15			90	101	23:15			31	28			
11:30			84	98	23:30			12	35			
11:45			85	354	78	351	705	21	100	20	123	223

Total Vol. 3842 2168 **6010** 4277 5618 **9895**

Daily Totals				
NB	SB	EB	WB	Combined
		8119	7786	15905

Split %	AM			PM		
	63.9%	36.1%	37.8%	43.2%	56.8%	62.2%
Peak Hour	7:00	7:30	7:00	14:30	16:15	16:45
Volume	820	376	1149	538	845	1298
P.H.F.	0.93	0.88	0.94	0.89	0.96	0.97

Thursday, October 03, 2019

Location: Santa Ana

PROJECT:

ADT197 RAITT ST from FIRST ST to SANTA ANA BL.

Prepared by AimTD tel. 714 753 7888

AM Period	NB	SB	EB	WB	PM Period	NB	SB	EB	WB	
0:00	9	5			12:00	56	71			
0:15	6	6			12:15	58	67			
0:30	5	3			12:30	61	56			
0:45	2	22	5	19	12:45	65	240	64	258	
1:00	0	4			13:00	54	70			
1:15	0	0			13:15	53	65			
1:30	1	2			13:30	61	58			
1:45	1	2	4	10	13:45	74	242	62	255	
2:00	0	2			14:00	101	58			
2:15	2	0			14:15	89	67			
2:30	3	1			14:30	86	89			
2:45	1	6	0	3	14:45	103	379	79	293	
3:00	3	1			15:00	109	96			
3:15	1	4			15:15	129	74			
3:30	2	2			15:30	132	67			
3:45	2	8	0	7	15:45	152	522	78	315	
4:00	0	2			16:00	132	91			
4:15	3	4			16:15	164	76			
4:30	1	1			16:30	152	51			
4:45	6	10	5	12	16:45	175	623	57	275	
5:00	9	8			17:00	142	89			
5:15	16	16			17:15	151	93			
5:30	18	13			17:30	158	72			
5:45	23	66	14	51	17:45	173	624	59	313	
6:00	44	24			18:00	168	56			
6:15	36	25			18:15	152	64			
6:30	41	30			18:30	111	76			
6:45	52	173	48	127	18:45	85	516	78	274	
7:00	98	104			19:00	71	51			
7:15	141	132			19:15	58	57			
7:30	195	150			19:30	64	46			
7:45	153	587	114	500	19:45	47	240	56	210	
8:00	121	65			20:00	53	45			
8:15	98	53			20:15	56	39			
8:30	64	55			20:30	51	37			
8:45	51	334	49	222	20:45	42	202	46	167	
9:00	75	42			21:00	50	35			
9:15	53	45			21:15	34	37			
9:30	48	43			21:30	42	32			
9:45	70	246	35	165	21:45	25	151	28	132	
10:00	57	46			22:00	21	25			
10:15	67	40			22:15	16	21			
10:30	53	36			22:30	14	18			
10:45	69	246	35	157	22:45	18	69	16	80	
11:00	58	43			23:00	9	10			
11:15	59	65			23:15	7	7			
11:30	70	56			23:30	5	5			
11:45	66	253	54	218	23:45	7	28	5	27	
Total Vol.	1953	1491		3444		3836	2599		6435	
								Daily Totals		
						NB	SB	EB	WB	Combined
						5789	4090			9879
				AM						PM
Split %	56.7%	43.3%		34.9%		59.6%	40.4%			65.1%
Peak Hour	7:15	7:00		7:00		17:30	14:30			16:45
Volume	610	500		1087		651	338			937
P.H.F.	0.78	0.83		0.79		0.96	0.88			0.96

Wednesday, September 11, 2019

Location: Santa Ana

PROJECT:

ADT193 RAITT ST from SEGERSTROM AVE to WARNER AVE.

Prepared by AimTD tel. 714 253 7888

AM Period	NB	SB	EB	WB	PM Period	NB	SB	EB	WB
0:00	21	10			12:00	77	66		
0:15	12	7			12:15	54	60		
0:30	14	6			12:30	69	59		
0:45	11	58	7	30	12:45	71	271	69	254
1:00	10	4			13:00	86	98		
1:15	7	5			13:15	100	87		
1:30	6	2			13:30	176	90		
1:45	4	27	5	16	13:45	206	568	89	364
2:00	4	2			14:00	127	78		
2:15	7	4			14:15	113	57		
2:30	7	7			14:30	139	102		
2:45	5	23	4	17	14:45	185	564	112	349
3:00	2	9			15:00	250	106		
3:15	5	4			15:15	175	86		
3:30	2	8			15:30	209	69		
3:45	0	9	16	37	15:45	239	873	89	350
4:00	5	16			16:00	251	82		
4:15	8	14			16:15	257	70		
4:30	4	34			16:30	299	79		
4:45	4	21	33	97	16:45	268	1075	88	319
5:00	6	38			17:00	261	85		
5:15	11	62			17:15	234	90		
5:30	13	82			17:30	301	105		
5:45	12	42	95	277	17:45	237	1033	109	389
6:00	20	57			18:00	246	101		
6:15	21	106			18:15	210	89		
6:30	42	95			18:30	151	75		
6:45	103	186	156	414	18:45	143	750	89	354
7:00	117	172			19:00	128	91		
7:15	114	197			19:15	117	74		
7:30	176	187			19:30	104	57		
7:45	165	572	184	740	19:45	103	452	61	283
8:00	170	163			20:00	90	62		
8:15	74	143			20:15	73	56		
8:30	84	179			20:30	71	59		
8:45	146	474	207	692	20:45	81	315	37	214
9:00	104	87			21:00	67	58		
9:15	40	59			21:15	70	38		
9:30	34	65			21:30	57	28		
9:45	48	226	65	276	21:45	75	269	24	148
10:00	38	51			22:00	51	24		
10:15	31	36			22:15	56	14		
10:30	43	61			22:30	44	19		
10:45	46	158	53	201	22:45	36	187	16	73
11:00	46	49			23:00	27	9		
11:15	47	55			23:15	31	15		
11:30	52	44			23:30	24	6		
11:45	60	205	57	205	23:45	22	104	9	39
Total Vol.	2001	3002		5003		6461	3136		9597
								Daily Totals	
						NB	SB	EB	WB
						8462	6138		14600
								PM	
Split %	40.0%	60.0%		34.3%		67.3%	32.7%		65.7%
Peak Hour	7:15	7:00		7:15		16:15	14:30		16:45
Volume	625	740		1356		1085	406		1432
P.H.F.	0.89	0.94		0.93		0.91	0.91		0.88

ADT211 SANTA ANA BLVD from MAIN ST to FRENCH ST

Prepared by AimTD tel. 714 253 7888

AM Period	NB	SB	EB	WB	PM Period	NB	SB	EB	WB
0:00			0	23	12:00			0	44
0:15			0	14	12:15			0	69
0:30			0	16	12:30			0	48
0:45			0	13	12:45			0	62
<hr/>									
1:00			0	18	13:00			0	71
1:15			0	6	13:15			0	60
1:30			0	13	13:30			0	79
1:45			0	9	13:45			0	75
<hr/>									
2:00			0	6	14:00			0	71
2:15			0	17	14:15			0	85
2:30			0	17	14:30			0	86
2:45			0	11	14:45			0	90
<hr/>									
3:00			0	4	15:00			0	88
3:15			0	7	15:15			0	108
3:30			0	17	15:30			0	94
3:45			0	19	15:45			0	93
<hr/>									
4:00			0	12	16:00			0	135
4:15			0	19	16:15			0	151
4:30			0	18	16:30			0	166
4:45			0	24	16:45			0	171
<hr/>									
5:00			0	27	17:00			0	178
5:15			0	34	17:15			0	182
5:30			0	53	17:30			0	178
5:45			0	75	17:45			0	192
<hr/>									
6:00			0	71	18:00			0	146
6:15			0	55	18:15			0	124
6:30			0	78	18:30			0	127
6:45			0	117	18:45			0	121
<hr/>									
7:00			0	132	19:00			0	102
7:15			0	106	19:15			0	94
7:30			0	118	19:30			0	96
7:45			0	137	19:45			0	83
<hr/>									
8:00			0	107	20:00			0	80
8:15			0	72	20:15			0	77
8:30			0	67	20:30			0	80
8:45			0	52	20:45			0	73
<hr/>									
9:00			0	68	21:00			0	38
9:15			0	56	21:15			0	58
9:30			0	61	21:30			0	70
9:45			0	56	21:45			0	40
<hr/>									
10:00			0	64	22:00			0	43
10:15			0	58	22:15			0	46
10:30			0	48	22:30			0	36
10:45			0	53	22:45			0	42
<hr/>									
11:00			0	68	23:00			0	30
11:15			0	54	23:15			0	28
11:30			0	58	23:30			0	26
11:45			0	65	23:45			0	21

Total Vol. 2293 **2293** 4257 **4257**

Daily Totals				
NB	SB	EB	WB	Combined
			6550	6550

AM **PM**

Split %	100.0%	35.0%	100.0%	65.0%
Peak Hour	7:00	7:00	17:00	17:00
Volume	493	493	730	730
P.H.F.	0.90	0.90	0.95	0.95

ADT206 SANTA ANA BLVD from RAITT ST to BRISTOL ST.

Prepared by AimTD tel. 714 253 7888

AM Period	NB	SB	EB	WB	PM Period	NB	SB	EB	WB			
0:00			3	4	12:00			20	31			
0:15			0	7	12:15			18	40			
0:30			3	5	12:30			25	37			
0:45			2	8	4	20	28	23	86	27	135	221
1:00			2	0	13:00			35	26			
1:15			0	3	13:15			23	37			
1:30			0	0	13:30			21	28			
1:45			3	5	0	3	8	26	105	32	123	228
2:00			0	0	14:00			29	22			
2:15			2	0	14:15			15	28			
2:30			0	0	14:30			26	22			
2:45			0	2	0	0	2	25	95	40	112	207
3:00			0	0	15:00			28	47			
3:15			2	0	15:15			41	43			
3:30			3	2	15:30			35	45			
3:45			2	7	3	5	12	30	134	39	174	308
4:00			4	2	16:00			18	45			
4:15			3	2	16:15			27	55			
4:30			8	4	16:30			36	49			
4:45			11	26	9	17	43	34	115	67	216	331
5:00			8	2	17:00			33	76			
5:15			16	5	17:15			25	82			
5:30			10	19	17:30			33	71			
5:45			14	48	20	46	94	28	119	64	293	412
6:00			17	22	18:00			27	47			
6:15			21	15	18:15			30	31			
6:30			20	22	18:30			16	37			
6:45			31	89	23	82	171	27	100	34	149	249
7:00			42	23	19:00			19	30			
7:15			96	29	19:15			17	26			
7:30			108	39	19:30			19	29			
7:45			108	354	51	142	496	9	64	23	108	172
8:00			66	35	20:00			9	30			
8:15			60	43	20:15			9	16			
8:30			25	20	20:30			10	24			
8:45			37	188	26	124	312	11	39	14	84	123
9:00			27	18	21:00			12	13			
9:15			26	25	21:15			13	12			
9:30			23	20	21:30			14	21			
9:45			13	89	27	90	179	7	46	19	65	111
10:00			27	21	22:00			9	16			
10:15			14	28	22:15			6	14			
10:30			18	19	22:30			3	7			
10:45			28	87	21	89	176	9	27	12	49	76
11:00			18	26	23:00			3	9			
11:15			21	31	23:15			4	8			
11:30			26	33	23:30			2	2			
11:45			15	80	31	121	201	2	11	4	23	34

Total Vol. 983 739 **1722** 941 1531 **2472**

Daily Totals				
NB	SB	EB	WB	Combined
		1924	2270	4194

	AM			PM		
Split %	57.1%	42.9%	41.1%	38.1%	61.9%	58.9%
Peak Hour	7:15	7:30	7:15	15:00	16:45	16:45
Volume	378	168	532	134	296	421
P.H.F.	0.88	0.82	0.84	0.82	0.90	0.97

Wednesday, October 02, 2019

Location: Santa Ana

PROJECT:

ADT243 STANDARD AVE from McFADDEN AVE to CHESTNUT AVE.

Prepared by AimTD tel. 714 753 7888

AM Period	NB	SB	EB	WB	PM Period	NB	SB	EB	WB					
0:00	15	11			12:00	77	61							
0:15	11	9	9		12:15	73	56							
0:30	11	6			12:30	82	66							
0:45	12	49	13	39	12:45	80	312	85	268					
										580				
1:00	8	5			13:00	75	113							
1:15	9	6			13:15	86	105							
1:30	11	7			13:30	79	109							
1:45	13	41	4	22	13:45	91	331	92	419					
										750				
2:00	6	5			14:00	114	83							
2:15	6	4			14:15	115	92							
2:30	2	4			14:30	132	79							
2:45	4	18	8	21	14:45	129	490	85	339					
										829				
3:00	3	3			15:00	134	98							
3:15	5	5			15:15	166	96							
3:30	4	6			15:30	172	84							
3:45	7	19	4	18	15:45	166	638	92	370					
										1008				
4:00	3	10			16:00	184	106							
4:15	6	5			16:15	188	93							
4:30	10	8			16:30	196	107							
4:45	15	34	14	37	16:45	218	786	113	419					
										1205				
5:00	18	18			17:00	209	123							
5:15	15	19			17:15	222	114							
5:30	28	47			17:30	207	100							
5:45	31	92	48	132	17:45	197	835	99	436					
										1271				
6:00	24	40			18:00	172	97							
6:15	26	46			18:15	141	122							
6:30	52	60			18:30	153	95							
6:45	85	187	63	209	18:45	131	597	89	403					
										1000				
7:00	95	97			19:00	105	72							
7:15	105	112			19:15	96	74							
7:30	113	114			19:30	87	85							
7:45	156	469	146	469	19:45	91	379	72	303					
										682				
8:00	134	120			20:00	96	77							
8:15	104	99			20:15	68	64							
8:30	85	84			20:30	57	49							
8:45	103	426	74	377	20:45	48	269	51	241					
										510				
9:00	78	55			21:00	55	51							
9:15	70	74			21:15	45	53							
9:30	64	80			21:30	49	40							
9:45	73	285	76	285	21:45	32	181	43	187					
										368				
10:00	56	57			22:00	43	34							
10:15	53	46			22:15	35	19							
10:30	49	57			22:30	29	27							
10:45	45	203	63	223	22:45	23	130	25	105					
										235				
11:00	50	67			23:00	25	15							
11:15	56	78			23:15	15	23							
11:30	64	64			23:30	17	15							
11:45	74	244	59	268	23:45	13	70	16	69					
										139				
Total Vol.	2067	2100			4167	5018	3559			8577				
										Daily Totals				
										NB	SB	EB	WB	Combined
										7085	5659			12744
										AM		PM		
Split %	49.6%	50.4%			32.7%	58.5%	41.5%						67.3%	
Peak Hour	7:15	7:15			7:15	16:45	16:30						16:45	
Volume	508	492			1000	856	457						1306	
P.H.F.	0.81	0.84			0.83	0.98	0.93						0.97	

ADT241 STANDARD AVE from WARNER AVE to EDINGER AVE.

Prepared by AimTD tel. 714 253 7888

AM Period	NB	SB	EB	WB	PM Period	NB	SB	EB	WB
0:00	23	12			12:00	92	75		
0:15	12	12			12:15	82	72		
0:30	14	12			12:30	78	65		
0:45	11	60	12	48	12:45	70	322	69	281
1:00	32	10			13:00	79	66		
1:15	13	9			13:15	91	73		
1:30	15	5			13:30	126	55		
1:45	7	67	10	34	13:45	109	405	65	259
2:00	8	6			14:00	120	75		
2:15	4	6			14:15	112	76		
2:30	15	5			14:30	147	95		
2:45	6	33	11	28	14:45	165	544	96	342
3:00	5	3			15:00	198	94		
3:15	4	7			15:15	151	75		
3:30	9	7			15:30	202	77		
3:45	12	30	16	33	15:45	188	739	70	316
4:00	10	11			16:00	191	88		
4:15	9	29			16:15	188	88		
4:30	10	50			16:30	208	89		
4:45	23	52	74	164	16:45	257	844	86	351
5:00	27	58			17:00	274	79		
5:15	38	67			17:15	241	107		
5:30	39	72			17:30	197	90		
5:45	38	142	123	320	17:45	146	858	103	379
6:00	45	83			18:00	136	67		
6:15	51	79			18:15	149	65		
6:30	69	113			18:30	127	67		
6:45	67	232	120	395	18:45	102	514	71	270
7:00	94	112			19:00	74	60		
7:15	73	149			19:15	84	58		
7:30	89	160			19:30	79	65		
7:45	99	355	152	573	19:45	68	305	65	248
8:00	79	127			20:00	71	57		
8:15	78	112			20:15	56	47		
8:30	82	65			20:30	64	45		
8:45	72	311	80	384	20:45	47	238	44	193
9:00	54	68			21:00	42	39		
9:15	68	49			21:15	53	37		
9:30	62	67			21:30	37	35		
9:45	52	236	52	236	21:45	36	168	35	146
10:00	61	47			22:00	46	43		
10:15	53	50			22:15	35	30		
10:30	55	37			22:30	20	22		
10:45	47	216	48	182	22:45	33	134	20	115
11:00	67	33			23:00	24	20		
11:15	72	60			23:15	25	9		
11:30	74	59			23:30	18	11		
11:45	87	300	45	197	23:45	11	78	8	48
Total Vol.	2034	2594		4628		5149	2948		8097
								Daily Totals	
						NB	SB	EB	WB
						7183	5542		12725
								PM	
Split %	43.9%	56.1%		36.4%		63.6%	36.4%		63.6%
Peak Hour	7:00	7:15		7:00		16:30	17:00		16:30
Volume	355	588		928		980	379		1341
P.H.F.	0.90	0.92		0.92		0.92	0.89		0.95

Transportation Studies, Inc.

2640 Walnut Avenue, Suite L
Tustin, CA. 92780

Location : GREENVILLE STREET
Segment : WARNER AVE TO EDINGER AVE
Client : CITY SANTA ANA

Site: SANTA ANA
Date: 10/01/19

Interval	NB				SB				Combined		Day:	Tuesday
	AM		PM		AM		PM		AM	PM		
12:00	7	19	21	128	4	9	36	135	11	28	57	263
12:15	8		29		2		31		10		60	
12:30	2		38		2		33		4		71	
12:45	2		40		1		35		3		75	
01:00	7	20	43	172	4	12	23	155	11	32	66	327
01:15	4		43		1		42		5		85	
01:30	4		38		5		46		9		84	
01:45	5		48		2		44		7		92	
02:00	2	10	54	268	0	6	52	238	2	16	106	506
02:15	1		45		2		58		3		103	
02:30	1		77		2		48		3		125	
02:45	6		92		2		80		8		172	
03:00	2	11	110	433	0	14	68	212	2	25	178	645
03:15	2		114		4		46		6		160	
03:30	3		102		7		46		10		148	
03:45	4		107		3		52		7		159	
04:00	4	16	110	466	3	41	48	197	7	57	158	663
04:15	2		121		10		43		12		164	
04:30	6		113		16		56		22		169	
04:45	4		122		12		50		16		172	
05:00	7	45	113	499	15	107	60	226	22	152	173	725
05:15	11		135		16		54		27		189	
05:30	14		128		35		46		49		174	
05:45	13		123		41		66		54		189	
06:00	22	104	99	314	30	173	59	216	52	277	158	530
06:15	18		93		46		50		64		143	
06:30	28		69		43		58		71		127	
06:45	36		53		54		49		90		102	
07:00	50	272	44	149	70	340	50	195	120	612	94	344
07:15	70		35		102		52		172		87	
07:30	84		39		88		50		172		89	
07:45	68		31		80		43		148		74	
08:00	60	163	43	147	69	202	57	156	129	365	100	303
08:15	44		34		52		42		96		76	
08:30	36		35		42		34		78		69	
08:45	23		35		39		23		62		58	
09:00	20	107	34	114	31	127	30	101	51	234	64	215
09:15	32		34		30		28		62		62	
09:30	29		24		38		28		67		52	
09:45	26		22		28		15		54		37	
10:00	34	109	19	58	28	129	18	56	62	238	37	114
10:15	23		20		26		11		49		31	
10:30	20		12		43		17		63		29	
10:45	32		7		32		10		64		17	
11:00	32	138	17	38	24	146	7	27	56	284	24	65
11:15	40		15		33		8		73		23	
11:30	36		2		42		6		78		8	
11:45	30		4		47		6		77		10	
Totals	1,014		2,786		1,306		1,914		2,320		4,700	
Split%	43.7		59.3		56.3		40.7					
Day Totals		3,800				3,220				7,020		
Day Splits		54.1				45.9						
Peak Hour	07:15		05:00		07:00		02:15		07:15		05:00	
Volume	282		499		340		254		621		725	
Factor	0.84		0.92		0.83		0.79		0.90		0.96	

Transportation Studies, Inc.

2640 Walnut Avenue, Suite L
Tustin, CA. 92780

Location : GREENVILLE STREET
Segment : SEGERSTROM AVE TO WARNER AVE
Client : CITY SANTA ANA

Site: SANTA ANA
Date: 10/01/19

Interval	NB				SB				Combined				Day:	Tuesday	
	AM		PM		AM		PM		AM		PM				
12:00	6	29	41	158	5	21	32	145	11	50	73	303			
12:15	9		39		7		35		16		74				
12:30	4		36		9		36		13		72				
12:45	10		42		0		42		10		84				
01:00	3	15	46	187	3	12	32	193	6	27	78	380			
01:15	6		43		2		48		8		91				
01:30	4		43		2		51		6		94				
01:45	2		55		5		62		7		117				
02:00	6	14	67	404	1	7	56	280	7	21	123	684			
02:15	1		60		3		76		4		136				
02:30	2		84		1		72		3		156				
02:45	5		193		2		76		7		269				
03:00	1	5	192	642	4	14	66	219	5	19	258	861			
03:15	2		138		0		52		2		190				
03:30	2		142		1		43		3		185				
03:45	0		170		9		58		9		228				
04:00	1	8	181	663	6	51	35	199	7	59	216	862			
04:15	3		148		6		53		9		201				
04:30	1		178		17		47		18		225				
04:45	3		156		22		64		25		220				
05:00	4	24	174	666	16	122	57	229	20	146	231	895			
05:15	8		190		29		54		37		244				
05:30	8		162		27		62		35		224				
05:45	4		140		50		56		54		196				
06:00	14	76	122	408	28	198	70	212	42	274	192	620			
06:15	14		114		50		42		64		156				
06:30	21		93		44		50		65		143				
06:45	27		79		76		50		103		129				
07:00	26	231	52	205	94	571	39	184	120	802	91	389			
07:15	57		54		147		57		204		111				
07:30	62		43		188		44		250		87				
07:45	86		56		142		44		228		100				
08:00	72	160	52	214	102	310	51	137	174	470	103	351			
08:15	40		63		78		32		118		95				
08:30	30		53		54		31		84		84				
08:45	18		46		76		23		94		69				
09:00	31	117	47	136	36	153	22	90	67	270	69	226			
09:15	22		41		36		27		58		68				
09:30	30		21		49		22		79		43				
09:45	34		27		32		19		66		46				
10:00	39	107	25	81	41	159	17	54	80	266	42	135			
10:15	22		28		38		13		60		41				
10:30	18		10		34		11		52		21				
10:45	28		18		46		13		74		31				
11:00	32	141	15	61	40	153	5	28	72	294	20	89			
11:15	30		15		28		4		58		19				
11:30	43		13		40		10		83		23				
11:45	36		18		45		9		81		27				
Totals	927		3,825		1,771		1,970		2,698		5,795				
Split%	34.4		66.0		65.6		34.0								
Day Totals		4,752				3,741				8,493					
Day Splits		56.0				44.0									
Peak Hour	07:15		04:30		07:15		02:15		07:15		04:30				
Volume	277		698		579		290		856		920				
Factor	0.81		0.92		0.77		0.95		0.86		0.94				

Transportation Studies, Inc.

2640 Walnut Avenue, Suite L
Tustin, CA. 92780

Location : FLOWER STREET
Segment : SANTA CLARA TO MEMORY LN
Client : CITY SANTA ANA

Site: SANTA ANA
Date: 09/12/19
D1909110

File:

Interval	NB			SB			Combined		Day:	Thursday		
	AM	PM		AM	PM		AM	PM				
12:00	3	9	58	187	14	30	82	302	17	39	140	489
12:15	4		50		3		74		7		124	
12:30	2		41		4		76		6		117	
12:45	0		38		9		70		9		108	
01:00	4	7	54	180	0	8	102	373	4	15	156	553
01:15	1		34		2		74		3		108	
01:30	2		49		0		87		2		136	
01:45	0		43		6		110		6		153	
02:00	0	4	68	314	4	16	127	484	4	20	195	798
02:15	2		96		6		148		8		244	
02:30	1		92		4		93		5		185	
02:45	1		58		2		116		3		174	
03:00	0	7	80	332	6	20	118	401	6	27	198	733
03:15	1		78		6		100		7		178	
03:30	1		94		4		73		5		167	
03:45	5		80		4		110		9		190	
04:00	3	9	81	392	2	44	92	466	5	53	173	858
04:15	3		74		10		132		13		206	
04:30	2		112		20		122		22		234	
04:45	1		125		12		120		13		245	
05:00	10	28	132	600	16	121	130	569	26	149	262	1,169
05:15	2		164		23		149		25		313	
05:30	6		162		48		162		54		324	
05:45	10		142		34		128		44		270	
06:00	10	90	128	404	40	299	136	457	50	389	264	861
06:15	18		104		47		113		65		217	
06:30	26		92		80		96		106		188	
06:45	36		80		132		112		168		192	
07:00	33	267	86	232	165	971	108	340	198	1,238	194	572
07:15	68		58		230		94		298		152	
07:30	82		40		284		80		366		120	
07:45	84		48		292		58		376		106	
08:00	132	285	34	129	178	531	81	251	310	816	115	380
08:15	74		32		138		68		212		100	
08:30	46		33		136		54		182		87	
08:45	33		30		79		48		112		78	
09:00	35	123	20	72	87	347	48	213	122	470	68	285
09:15	30		25		92		61		122		86	
09:30	32		13		78		58		110		71	
09:45	26		14		90		46		116		60	
10:00	28	142	8	29	58	262	47	140	86	404	55	169
10:15	52		10		66		50		118		60	
10:30	31		3		68		25		99		28	
10:45	31		8		70		18		101		26	
11:00	38	151	10	33	82	303	19	71	120	454	29	104
11:15	30		10		58		16		88		26	
11:30	46		7		88		30		134		37	
11:45	37		6		75		6		112		12	
Totals	1,122		2,904		2,952		4,067		4,074		6,971	
Split%	27.5		41.7		72.5		58.3					
Day Totals		4,026				7,019				11,045		
Day Splits		36.5				63.5						
Peak Hour	07:30		05:00		07:15		05:15		07:15		05:15	
Volume	372		600		984		575		1,350		1,171	
Factor	0.70		0.91		0.84		0.89		0.90		0.90	

Transportation Studies, Inc.

2640 Walnut Avenue, Suite L
Tustin, CA. 92780

Location : DYER ROAD
Segment : PULLMAN ST TO RED HILL AVE
Client : CITY SANTA ANA

Site: SANTA ANA
Date: 09/24/19

Interval	EB				WB				Combined		Day:	Tuesday
	AM		PM		AM		PM		AM	PM		
12:00	20	52	214	769	38	198	228	930	58	250	442	1.699
12:15	10		190		38		234		48		424	
12:30	14		183		84		230		98		413	
12:45	8		182		38		238		46		420	
01:00	13	32	204	728	24	73	246	1,032	37	105	450	1.760
01:15	11		162		28		250		39		412	
01:30	2		186		13		285		15		471	
01:45	6		176		8		251		14		427	
02:00	12	66	186	687	16	63	297	1,179	28	129	483	1.866
02:15	7		155		17		278		24		433	
02:30	17		170		18		335		35		505	
02:45	30		176		12		269		42		445	
03:00	18	187	158	741	16	60	286	1,286	34	247	444	2.027
03:15	31		191		20		332		51		523	
03:30	56		192		11		323		67		515	
03:45	82		200		13		345		95		545	
04:00	56	480	183	852	26	115	370	1,350	82	595	553	2.202
04:15	85		206		24		316		109		522	
04:30	137		227		40		342		177		569	
04:45	202		236		25		322		227		558	
05:00	175	904	243	1,101	32	209	389	1,412	207	1,113	632	2,513
05:15	205		276		36		358		241		634	
05:30	228		294		58		308		286		602	
05:45	296		288		83		357		379		645	
06:00	214	900	230	844	88	460	322	1,197	302	1,360	552	2.041
06:15	241		215		134		329		375		544	
06:30	231		234		102		313		333		547	
06:45	214		165		136		233		350		398	
07:00	220	991	146	486	172	777	300	986	392	1,768	446	1,472
07:15	251		106		176		266		427		372	
07:30	264		120		186		232		450		352	
07:45	256		114		243		188		499		302	
08:00	228	950	124	380	245	1,001	214	748	473	1,951	338	1,128
08:15	222		90		253		168		475		258	
08:30	238		74		267		170		505		244	
08:45	262		92		236		196		498		288	
09:00	218	868	82	293	224	785	194	654	442	1,653	276	947
09:15	233		84		187		158		420		242	
09:30	211		60		195		172		406		232	
09:45	206		67		179		130		385		197	
10:00	170	677	42	195	193	739	150	488	363	1,416	192	683
10:15	168		54		191		122		359		176	
10:30	181		57		175		122		356		179	
10:45	158		42		180		94		338		136	
11:00	208	870	22	83	188	776	98	285	396	1,646	120	368
11:15	219		19		201		66		420		85	
11:30	199		25		184		65		383		90	
11:45	244		17		203		56		447		73	
Totals	6,977		7,159		5,256		11,547		12,233		18,706	
Split%	57.0		38.3		43.0		61.7					
Day Totals		14,136				16,803				30,939		
Day Splits		45.7				54.3						
Peak Hour	07:15		05:00		07:45		05:00		07:45		05:00	
Volume	999		1,101		1,008		1,412		1,952		2,513	
Factor	0.95		0.94		0.94		0.91		0.97		0.97	

Transportation Studies, Inc.

2640 Walnut Avenue, Suite L
Tustin, CA. 92780

Location : FAIRHAVEN AVENUE
Segment : TUSTIN AVE TO NEWPORT FWY
Client : CITY SANTA ANA

Site: SANTA ANA
Date: 10/03/19

Interval	WB				EB				Combined				Day:	Thursday
	AM		PM		AM		PM		AM		PM			
12:00	18	24	89	408	18	50	79	376	36	74	168	784		
12:15	2		128		14		94		16		222			
12:30	3		96		7		101		10		197			
12:45	1		95		11		102		12		197			
01:00	8	14	114	452	10	21	109	426	18	35	223	878		
01:15	2		114		5		92		7		206			
01:30	0		106		4		101		4		207			
01:45	4		118		2		124		6		242			
02:00	3	9	142	604	6	19	107	516	9	28	249	1,120		
02:15	2		134		10		144		12		278			
02:30	0		134		1		144		1		278			
02:45	4		194		2		121		6		315			
03:00	5	22	186	615	10	21	154	583	15	43	340	1,198		
03:15	7		146		3		158		10		304			
03:30	3		133		4		147		7		280			
03:45	7		150		4		124		11		274			
04:00	9	62	159	690	5	20	131	607	14	82	290	1,297		
04:15	16		203		3		160		19		363			
04:30	20		162		7		166		27		328			
04:45	17		166		5		150		22		316			
05:00	44	178	180	833	11	60	147	664	55	238	327	1,497		
05:15	38		238		14		188		52		426			
05:30	48		231		12		139		60		370			
05:45	48		184		23		190		71		374			
06:00	58	437	183	651	24	217	138	463	82	654	321	1,114		
06:15	107		170		49		118		156		288			
06:30	126		158		68		90		194		248			
06:45	146		140		76		117		222		257			
07:00	178	994	94	338	98	537	101	400	276	1,531	195	738		
07:15	202		78		123		112		325		190			
07:30	284		84		162		89		446		173			
07:45	330		82		154		98		484		180			
08:00	300	900	54	211	112	387	73	272	412	1,287	127	483		
08:15	230		51		102		68		332		119			
08:30	194		56		93		66		287		122			
08:45	176		50		80		65		256		115			
09:00	139	506	42	142	76	292	80	250	215	798	122	392		
09:15	109		34		64		58		173		92			
09:30	132		35		64		56		196		91			
09:45	126		31		88		56		214		87			
10:00	110	433	42	110	80	298	74	207	190	731	116	317		
10:15	104		24		74		47		178		71			
10:30	97		22		70		44		167		66			
10:45	122		22		74		42		196		64			
11:00	114	411	12	49	74	324	35	116	188	735	47	165		
11:15	93		16		76		26		169		42			
11:30	102		11		76		32		178		43			
11:45	102		10		98		23		200		33			
Totals	3,990		5,103		2,246		4,880		6,236		9,983			
Split%	64.0		51.1		36.0		48.9							
Day Totals		9,093				7,126				16,219				
Day Splits		56.1				43.9								
Peak Hour	07:30		05:15		07:15		05:00		07:30		05:00			
Volume	1,144		836		551		664		1,674		1,497			
Factor	0.87		0.88		0.85		0.87		0.86		0.88			

ADT219 SANTA CLARA AVE from TUSTIN AVE to NEWPORT FWY.

Prepared by AimTD tel. 714 253 7888

AM Period	NB	SB	EB	WB	PM Period	NB	SB	EB	WB			
0:00			10	7	12:00			68	47			
0:15			7	6	12:15			50	33			
0:30			3	0	12:30			72	51			
0:45			0	20	0	13	33	80	270	67	198	468
1:00			2	2	13:00			80	45			
1:15			4	0	13:15			69	66			
1:30			2	2	13:30			59	53			
1:45			2	10	4	8	18	52	260	87	251	511
2:00			3	3	14:00			58	64			
2:15			3	2	14:15			61	55			
2:30			0	2	14:30			110	72			
2:45			2	8	0	7	15	85	314	99	290	604
3:00			0	0	15:00			88	94			
3:15			0	2	15:15			85	76			
3:30			0	4	15:30			84	87			
3:45			0	0	4	10	10	58	315	77	334	649
4:00			0	2	16:00			82	64			
4:15			6	2	16:15			85	79			
4:30			0	5	16:30			88	96			
4:45			0	6	2	11	17	94	349	85	324	673
5:00			8	7	17:00			90	106			
5:15			9	13	17:15			111	118			
5:30			8	14	17:30			106	106			
5:45			9	34	15	49	83	87	394	108	438	832
6:00			11	13	18:00			94	81			
6:15			46	30	18:15			86	88			
6:30			55	43	18:30			72	80			
6:45			47	159	55	141	300	58	310	56	305	615
7:00			63	50	19:00			55	53			
7:15			151	76	19:15			48	46			
7:30			137	106	19:30			53	34			
7:45			130	481	116	348	829	46	202	41	174	376
8:00			106	122	20:00			51	41			
8:15			57	100	20:15			45	35			
8:30			52	72	20:30			45	31			
8:45			72	287	54	348	635	25	166	21	128	294
9:00			63	56	21:00			30	20			
9:15			67	53	21:15			27	25			
9:30			45	45	21:30			21	11			
9:45			45	220	47	201	421	27	105	18	74	179
10:00			35	44	22:00			26	22			
10:15			54	37	22:15			26	12			
10:30			46	35	22:30			18	11			
10:45			50	185	44	160	345	16	86	9	54	140
11:00			51	39	23:00			14	12			
11:15			49	41	23:15			10	5			
11:30			49	38	23:30			10	7			
11:45			58	207	38	156	363	10	44	5	29	73
Total Vol.			1617	1452	3069			2815	2599	5414		
								Daily Totals				
								NB	SB	EB	WB	Combined
										4432	4051	8483
								AM		PM		
Split %			52.7%	47.3%	36.2%			52.0%	48.0%	63.8%		
Peak Hour			7:15	7:30	7:15			16:45	17:00	17:00		
Volume			524	444	944			401	438	832		
P.H.F.			0.87	0.91	0.96			0.90	0.93	0.91		

Transportation Studies, Inc.

2640 Walnut Avenue, Suite L
Tustin, CA. 92780

Location : HARBOR BOULEVARD
Segment : EDINGER AVE TO MCFADDEN AVE
Client : CITY SANTA ANA

Site: SANTA ANA
Date: 10/03/19

Interval	NB				SB				Combined				Day:	Thursday
	AM		PM		AM		PM		AM		PM			
12:00	78	242	302	1,224	47	169	327	1,319	125	411	629	2,543		
12:15	70		304		42		322		112		626			
12:30	46		316		45		312		91		628			
12:45	48		302		35		358		83		660			
01:00	72	160	328	1,382	27	98	286	1,272	99	258	614	2,654		
01:15	36		326		25		308		61		634			
01:30	34		344		18		337		52		681			
01:45	18		384		28		341		46		725			
02:00	51	134	384	1,766	19	93	334	1,445	70	227	718	3,211		
02:15	26		439		18		363		44		802			
02:30	29		426		34		350		63		776			
02:45	28		517		22		398		50		915			
03:00	35	113	508	2,114	28	234	295	1,197	63	347	803	3,311		
03:15	27		548		42		311		69		859			
03:30	26		516		56		298		82		814			
03:45	25		542		108		293		133		835			
04:00	50	162	532	2,086	47	467	282	1,184	97	629	814	3,270		
04:15	26		526		86		300		112		826			
04:30	42		520		138		296		180		816			
04:45	44		508		196		306		240		814			
05:00	60	312	541	2,221	168	973	332	1,307	228	1,285	873	3,528		
05:15	73		561		198		324		271		885			
05:30	80		555		269		355		349		910			
05:45	99		564		338		296		437		860			
06:00	122	567	518	1,962	273	1,658	298	1,133	395	2,225	816	3,095		
06:15	118		556		319		283		437		839			
06:30	154		478		480		268		634		746			
06:45	173		410		586		284		759		694			
07:00	200	1,001	402	1,431	572	2,472	268	1,013	772	3,473	670	2,444		
07:15	224		394		612		262		836		656			
07:30	272		330		640		259		912		589			
07:45	305		305		648		224		953		529			
08:00	348	1,146	264	1,026	586	2,128	220	817	934	3,274	484	1,843		
08:15	282		268		522		209		804		477			
08:30	248		272		520		222		768		494			
08:45	268		222		500		166		768		388			
09:00	228	945	197	777	444	1,714	184	626	672	2,659	381	1,403		
09:15	216		204		427		156		643		360			
09:30	265		200		406		150		671		350			
09:45	236		176		437		136		673		312			
10:00	262	1,075	194	654	332	1,362	153	435	594	2,437	347	1,089		
10:15	269		170		320		105		589		275			
10:30	276		166		352		101		628		267			
10:45	268		124		358		76		626		200			
11:00	290	1,193	107	455	306	1,189	98	340	596	2,382	205	795		
11:15	303		94		253		80		556		174			
11:30	306		139		340		78		646		217			
11:45	294		115		290		84		584		199			
Totals	7,050		17,098		12,557		12,088		19,607		29,186			
Split%	36.0		58.6		64.0		41.4							
Day Totals		24,148				24,645				48,793				
Day Splits		49.5				50.5								
Peak Hour	07:30		05:00		07:15		02:00		07:15		05:00			
Volume	1,207		2,221		2,486		1,445		3,635		3,528			
Factor	0.87		0.98		0.96		0.91		0.95		0.97			

Transportation Studies, Inc.

2640 Walnut Avenue, Suite L
Tustin, CA. 92780

Location : HARBOR BOULEVARD
Segment : WARNER TO SANTA ANA RIVER
Client : CITY SANTA ANA

Site: SANTA ANA
Date: 10/09/19

Interval	NB				SB				Combined				Day:	Wednesday
	AM		PM		AM		PM		AM		PM			
12:00	74	265	359	1,359	42	128	330	1,343	116	393	689	2,702		
12:15	58		330		30		332		88		662			
12:30	63		318		32		357		95		675			
12:45	70		352		24		324		94		676			
01:00	68	204	328	1,473	14	71	333	1,305	82	275	661	2,778		
01:15	49		350		12		328		61		678			
01:30	50		390		24		336		74		726			
01:45	37		405		21		308		58		713			
02:00	52	156	494	1,931	30	115	400	1,374	82	271	894	3,305		
02:15	34		428		24		324		58		752			
02:30	49		496		30		341		79		837			
02:45	21		513		31		309		52		822			
03:00	37	110	604	2,356	24	229	291	1,175	61	339	895	3,531		
03:15	16		533		47		288		63		821			
03:30	29		631		50		300		79		931			
03:45	28		588		108		296		136		884			
04:00	43	149	626	2,489	66	569	237	995	109	718	863	3,484		
04:15	24		604		91		237		115		841			
04:30	36		619		164		258		200		877			
04:45	46		640		248		263		294		903			
05:00	48	270	672	2,625	184	1,200	290	1,012	232	1,470	962	3,637		
05:15	78		655		241		250		319		905			
05:30	66		624		339		234		405		858			
05:45	78		674		436		238		514		912			
06:00	90	456	584	2,265	338	1,964	236	960	428	2,420	820	3,225		
06:15	90		628		420		258		510		886			
06:30	140		549		456		232		596		781			
06:45	136		504		750		234		886		738			
07:00	202	1,014	406	1,437	628	3,573	190	712	830	4,587	596	2,149		
07:15	204		384		1,000		191		1,204		575			
07:30	272		340		974		176		1,246		516			
07:45	336		307		971		155		1,307		462			
08:00	274	970	246	925	1,004	3,226	144	598	1,278	4,196	390	1,523		
08:15	220		231		703		158		923		389			
08:30	237		218		714		170		951		388			
08:45	239		230		805		126		1,044		356			
09:00	228	928	201	797	759	2,203	112	515	987	3,131	313	1,312		
09:15	231		207		562		170		793		377			
09:30	243		187		430		132		673		319			
09:45	226		202		452		101		678		303			
10:00	255	998	238	729	370	1,366	96	300	625	2,364	334	1,029		
10:15	228		174		332		66		560		240			
10:30	262		159		314		80		576		239			
10:45	253		158		350		58		603		216			
11:00	261	1,131	148	497	332	1,171	54	207	593	2,302	202	704		
11:15	308		142		284		60		592		202			
11:30	260		128		277		46		537		174			
11:45	302		79		278		47		580		126			
Totals	6,651		18,883		15,815		10,496		22,466		29,379			
Split%	29.6		64.3		70.4		35.7							
Day Totals		25,534				26,311				51,845				
Day Splits		49.3				50.7								
Peak Hour	11:00		05:00		07:15		02:00		07:15		04:30			
Volume	1,131		2,625		3,949		1,374		5,035		3,647			
Factor	0.92		0.97		0.98		0.86		0.96		0.95			



IBI GROUP
18401 Von Karman Avenue – Suite 300
Irvine CA 92612 USA
tel 949 833 5588 fax 949 833 5511
ibigroup.com

Technical Memorandum

To/Attention City of Santa Ana **Date** October 22, 2020
From IBI Group **Project No** 119772
cc
Subject Addendum to Santa Ana General Plan Traffic Impact Study

Overview

This memo serves as an addendum to the Traffic Impact Study (October 2020) prepared in support of the Santa Ana General Plan Update Environmental Impact Report (EIR). Presented in this memo is the analysis for ten (10) additional study intersections identified by the City of Tustin and Orange County Transportation Authority (OCTA) as locations where impacts may occur due to the project. The study intersections are listed below are shown in Exhibit A attached to this memo.

106. Red Hill Avenue and El Camino Real (City of Tustin)
107. Red Hill Avenue and I-5 NB Ramps (City of Tustin)
108. Red Hill Avenue and I-5 SB Ramps (City of Tustin)
109. Red Hill Avenue and Nisson Road (City of Tustin)
110. Red Hill Avenue and Walnut Avenue (City of Tustin)
111. Red Hill Avenue and Valencia Avenue (City of Tustin)
112. Tustin Ranch Road and Warner Avenue North (City of Tustin)
113. Tustin Ranch Road and Walnut Avenue (City of Tustin)
114. SR-55 SB Ramps and Irvine Boulevard (Orange County CMP)
115. SR-55 NB Ramps and Irvine Boulevard (Orange County CMP)

This analysis follows the methodology outlined in the Traffic Impact Study (October 2020). Intersection level of service (LOS) analyses were conducted for the Existing Year (2020) No Project, Future Year (2045) No Project, and Future Year (2045) With Project scenarios. Significant impacts were assessed for the year 2045 scenarios using the impact criteria of the presiding agency.

Existing Year (2020) No Project

A summary of the AM and PM peak hour level of service analysis results for the Existing Year (2020) No Project condition is provided in Table 1. Intersections are considered unacceptable if the level of service (LOS) is “E” or “F”. It should be noted that Caltrans and OC CMP intersections have a minimum LOS of C and E, respectively. The following intersections are forecast to operate at an unacceptable level of service in the Existing Year (2020) No Project condition:

- INT 113 – Tustin Ranch Road and Walnut Avenue (City of Tustin)

City of Santa Ana – October 22, 2020

Table 1: Existing Year (2020) No Project Intersection LOS Summary

ID	INTERSECTION	AM		PM	
		V/C or Delay	LOS	V/C or Delay	LOS
106	Red Hill Avenue and El Camino Real	0.71	C	0.62	B
107	Red Hill Avenue and I-5 NB Ramps	20.3	C	23.3	C
108	Red Hill Avenue and I-5 SB Ramps	22.0	C	22.8	C
109	Red Hill Avenue and Nissan Road	0.65	B	0.70	B
110	Red Hill Avenue and Walnut Avenue	0.68	B	0.79	C
111	Red Hill Avenue and Valencia Avenue	0.54	A	0.55	A
112	Tustin Ranch Road and Warner Avenue North	0.43	A	0.76	C
113	Tustin Ranch Road and Walnut Avenue	1.19	F	1.63	F
114	SR-55 SB Ramps and Irvine Boulevard	0.97	E	0.79	C
115	SR-55 NB Ramps and Irvine Boulevard	0.80	C	0.81	D

Notes: (1) LOS – Level of Service; (2) V/C – Volume to Capacity

Future Year (2045) No Project

A summary of the AM and PM peak hour level of service analysis results for the Future Year (2045) No Project condition is provided in Table 2. Intersections are considered unacceptable if the level of service (LOS) is “E” or “F”. It should be noted that Caltrans and OC CMP intersections have a minimum LOS of C and E, respectively. The following intersections are forecast to operate at an unacceptable level of service in the Future Year (2045) No Project condition:

- INT 113 – Tustin Ranch Road and Walnut Avenue (City of Tustin)
- INT 114 – SR-55 SB Ramps and Irvine Boulevard (Caltrans - CMP)

Table 2: Future Year (2045) No Project Intersection LOS Summary

ID	INTERSECTION	AM		PM	
		V/C or Delay	LOS	V/C or Delay	LOS
106	Red Hill Avenue and El Camino Real	0.65	B	0.78	C
107	Red Hill Avenue and I-5 NB Ramps	20.8	C	23.7	C
108	Red Hill Avenue and I-5 SB Ramps	23.7	C	22.2	C
109	Red Hill Avenue and Nissan Road	0.65	B	0.69	B
110	Red Hill Avenue and Walnut Avenue	0.64	B	0.74	C
111	Red Hill Avenue and Valencia Avenue	0.65	B	0.74	C
112	Tustin Ranch Road and Warner Avenue North	0.45	A	0.89	D
113	Tustin Ranch Road and Walnut Avenue	1.27	F	1.72	F
114	SR-55 SB Ramps and Irvine Boulevard	1.10	F	0.92	E

City of Santa Ana – October 22, 2020

ID	INTERSECTION	AM		PM	
		V/C or Delay	LOS	V/C or Delay	LOS
115	SR-55 NB Ramps and Irvine Boulevard	0.91	E	0.93	E

Notes: (1) LOS – Level of Service; (2) V/C – Volume to Capacity

Future Year (2045) With Project

A summary of the AM and PM peak hour level of service analysis results for the Future Year (2045) With Project condition is provided in Table 3. Intersections are considered unacceptable if the level of service (LOS) is “E” or “F”. It should be noted that Caltrans and OC CMP intersections have a minimum LOS of C and E, respectively. The following intersections are forecast to operate at an unacceptable level of service in the Future Year (2045) With Project condition:

- INT 112 – Tustin Ranch Road and Warner Avenue North
- INT 113 – Tustin Ranch Road and Walnut Avenue
- INT 114 – SR-55 SB Ramps and Irvine Boulevard (Caltrans - CMP)

Table 3: Future Year (2045) With Project Intersection LOS Summary

ID	INTERSECTION	AM		PM	
		V/C or Delay	LOS	V/C or Delay	LOS
106	Red Hill Avenue and El Camino Real	0.64	B	0.70	B
107	Red Hill Avenue and I-5 NB Ramps	20.1	C	23.6	C
108	Red Hill Avenue and I-5 SB Ramps	24.7	C	21.8	C
109	Red Hill Avenue and Nisson Road	0.66	B	0.72	C
110	Red Hill Avenue and Walnut Avenue	0.64	B	0.75	C
111	Red Hill Avenue and Valencia Avenue	0.68	B	0.75	C
112	Tustin Ranch Road and Warner Avenue North	0.46	A	0.92	E
113	Tustin Ranch Road and Walnut Avenue	1.31	F	1.77	F
114	SR-55 SB Ramps and Irvine Boulevard	1.18	F	0.93	E
115	SR-55 NB Ramps and Irvine Boulevard	0.82	D	0.84	D

City of Santa Ana – October 22, 2020

Intersection Impact Assessment

Intersection impacts were determined using the criteria established by the presiding agency and further evaluated in order to determine the cause for the impact. Impacts are expected to occur due to the proposed land use changes, reclassifications, or a combination of both. The impacted intersections and the cause of impact is identified below:

- **INT 112 – Tustin Ranch Road and Warner Avenue North (PM peak hour / Tustin)**
 - The impact at this intersection is expected to occur as a result of the proposed land use changes. Specific improvements to this intersection to address this identified impact are presented in Table 5. Additionally, the City of Santa Ana will contribute to improvements based on the calculated fair-share percentage presented in Table 5.
- **113 – Tustin Ranch Road and Walnut Avenue (Tustin)**
 - The worsening of LOS at this intersection is expected to occur as a result of the proposed land use changes. Specific improvements to this intersection to address this identified impact are presented in Table 5. Additionally, the City of Santa Ana will contribute to improvements based on the calculated fair-share percentage presented in Table 5.

Table 6 summarizes intersection LOS for the future year scenario, with and without the project, as well as with the improvement measures implemented. All impacts are expected to be mitigated.



IBI GROUP
 18401 Von Karman Avenue – Suite 300
 Irvine CA 92612 USA
 tel 949 833 5588 fax 949 833 5511
 ibigroup.com

Table 4: Future Year (2045) LOS Impact Summary

ID	INTERSECTION	PEAK HOUR	2045 No Project		2045 With Project		DELTA	LOS IMPACT?
			V/C or Delay	LOS	V/C or Delay	LOS		
106	Red Hill Avenue and El Camino Real	AM	0.65	B	0.64	B	-0.01	NO
		PM	0.78	C	0.70	B	-0.08	NO
107	Red Hill Avenue and I-5 NB Ramps	AM	20.8	C	20.1	C	-0.7	NO
		PM	23.7	C	23.6	C	-0.1	NO
108	Red Hill Avenue and I-5 SB Ramps	AM	23.7	C	24.7	C	1.0	NO
		PM	22.2	C	21.8	C	-0.4	NO
109	Red Hill Avenue and Nisson Road	AM	0.65	B	0.66	B	0.01	NO
		PM	0.69	B	0.72	C	0.03	NO
110	Red Hill Avenue and Walnut Avenue	AM	0.64	B	0.64	B	0.00	NO
		PM	0.74	C	0.75	C	0.01	NO
111	Red Hill Avenue and Valencia Avenue	AM	0.65	B	0.68	B	0.03	NO
		PM	0.74	C	0.75	C	0.01	NO
112	Tustin Ranch Road and Warner Avenue North	AM	0.45	A	0.46	A	0.01	NO
		PM	0.89	D	0.92	E	0.03	YES
113	Tustin Ranch Road and Walnut Avenue	AM	1.27	F	1.31	F	0.04	NO
		PM	1.72	F	1.77	F	0.05	NO
114	SR-55 SB Ramps and Irvine Boulevard	AM	1.10	F	1.18	F	0.08	NO
		PM	0.92	E	0.93	E	0.01	NO
115	SR-55 NB Ramps and Irvine Boulevard	AM	0.91	E	0.82	D	-0.09	NO
		PM	0.93	E	0.84	D	-0.09	NO

City of Santa Ana – October 22, 2020

Table 5: Intersection LOS Improvement Measures

ID	INTERSECTION	IMPROVEMENT
112	Tustin Ranch Road and Warner Avenue North	<ul style="list-style-type: none"> Convert single NB-RT to dual right-turn with overlap control. Fair-Share: 29.1% (PM)
113	Tustin Ranch Road and Walnut Avenue	<ul style="list-style-type: none"> Modify WB-RT to be a channelized RT. Modify EB approach to be: 2LT, 2T, and 1RT. Fair-Share: 84.5% (AM) / 24.0% (PM)

Table 6: Future Year (2045) With Project – Mitigated Impact Summary

ID	INTERSECTION	PEAK HOUR	2045 No Project		2045 With Project		DELTA	IMPACT?	2045 With Project – Mit.		DELTA	IMPACT?
			V/C or Delay	LOS	V/C or Delay	LOS			V/C or Delay	LOS		
112	Tustin Ranch Road and Warner Avenue North	AM	0.45	A	0.46	A	0.01	NO	0.46	A	0.01	NO
		PM	0.89	D	0.92	E	0.03	YES	0.75	C	-0.14	NO
113	Tustin Ranch Road and Walnut Avenue	AM	1.27	F	1.31	F	0.04	YES	1.18	F	-0.09	NO
		PM	1.72	F	1.77	F	0.05	YES	1.59	F	-0.13	NO



IBI GROUP
18401 Von Karman Avenue – Suite 300
Irvine CA 92612 USA
tel 949 833 5588 fax 949 833 5511
ibigroup.com

Conclusion

Ten (10) additional intersections were assessed in order to determine project-related impacts. In assessing the intersection LOS it was determined that an impact is expected to occur at one location. The impacted intersection is listed below:

- **INT 112 – Tustin Ranch Road and Warner Avenue North (PM / City of Tustin)**
 - An improvement measure was developed and proposed as part of this study; implementation of the measure is expected to improve intersection LOS and fully mitigate the impact. The fair-share contribution, based on the project's contribution to increased traffic volumes, was calculated to be 29.1% for the PM peak hour.
- **INT 113 – Tustin Ranch Road and Walnut Avenue (AM & PM / City of Tustin)**
 - An improvement measure was developed and proposed as part of this study; implementation of the measure is expected to improve intersection LOS and fully mitigate the impact. The fair-share contribution, based on the project's contribution to increased traffic volumes, was calculated to be 84.5% and 24.0% for the Am and PM peak hours, respectively.

Exhibit A - Study Intersection Locations

