



Sigfox connected objects: Radio specifications

March 2022

	Sigfox connected objects Radio specifications	Ref.: EP-SPECS
		Rev.: 1.6
		Date: Mar.2022

Terms of use

These terms of use (the "Terms") issued by SIGFOX SA ("SIGFOX") governs your use of this document entitled "Sigfox connected objects - radio specifications" and its content (the "Document"). These Terms shall be governed by the laws of France.

You acknowledge that you have read, understood and agree to be bound by all of the terms and conditions set forth in these Terms. If you do not agree to the Terms, do not use this Document.

For the purpose of these Terms, (i) "Product" means an end-device or end-point or wireless transmit/receive unit (WTRU) including, but not limited to, a user equipment, a sensor, an actuator, a fixed or mobile subscriber unit, a cellular telephone, a computer, or any other type of end-device capable of operating in a wireless environment, enabling access to the SIGFOX Network; and (ii) "SIGFOX Network" means the radio access network and associated network infrastructure designed by SIGFOX.

SIGFOX owns and retains all proprietary rights, title and interest, including all intellectual property rights in and to the Document. You acknowledge that the rights granted under these Terms do not provide you with title to or ownership on the Document, but only a right of limited use in accordance with these Terms.

Subject to these Terms, SIGFOX grants you a limited, non-exclusive, non-transferable, worldwide, royalty-free right to use the Document, during the whole duration of legal protection by intellectual property rights of the Document, solely to the extent necessary to develop a Product to be connected to the SIGFOX Network and/or for academic, educational purposes to discover, promote, improve Sigfox technology. Any other use is strictly prohibited.

Please note that you may not sell, make available for sale, or otherwise distribute any Product, unless and until such Product (a) embeds the applicable authentication credentials (to be generated and provided by SIGFOX) and (b) has been SIGFOX certified (such certification is subject to the terms and conditions of the SIGFOX's certification program).

You shall not (a) modify the document or create any derivative work of any part of the Document; (b) use the Document in any way that would not be in compliance with these Terms or with applicable laws or regulations; (c) develop any Product that exploits or creates vulnerabilities in SIGFOX Network, introduces in SIGFOX Network any virus, worm, Trojan horse or similar harmful or malicious code, or otherwise harms SIGFOX Network; (d) remove or attempt to remove any SIGFOX trademark, logo or copyright notice displayed on the Document.

THIS DOCUMENT IS PROVIDED TO YOU FOR FREE, ON AN "AS IS" AND "AS AVAILABLE" BASIS. SIGFOX MAKES NO WARRANTIES, EXPRESS, IMPLIED, STATUTORY, OR OTHERWISE, WITH RESPECT TO THIS DOCUMENT OR ITS CONTENT. SIGFOX SPECIFICALLY DISCLAIMS THE WARRANTIES OF MERCHANTABILITY, FITNESS FOR A PARTICULAR PURPOSE AND NON-INFRINGEMENT AND THOSE ARISING FROM A COURSE OF DEALING OR USAGE OR TRADE, AND ALL SUCH WARRANTIES ARE HEREBY EXCLUDED TO THE FULLEST EXTENT PERMITTED BY APPLICABLE LAWS.

THE CONTENT OF THE DOCUMENT IS PROVIDED ON AN INDICATIVE BASIS. IN NO EVENT SIGFOX SHALL BE LIABLE FOR THE RELIABILITY, EFFECTIVENESS OR COMPLETENESS OF THE INFORMATION CONTAINED IN THIS DOCUMENT. TO THE MAXIMUM EXTENT PERMITTED BY APPLICABLE LAW, In no event shall SIGFOX be liable under THESE TERMS for consequential, special, exemplary, or any OTHER indirect (including without limitation, lost profits, loss of records or data) DAMAGES regardless of whether arising from breach of contract, warranty, tort, strict liability, or otherwise, even if advised of the possibility of the loss or damage or if the loss or damage could have been reasonably foreseen.

Table of content

1	INTRODUCTION.....	3
2	RADIO HARDWARE ENGINEERING.....	4
2.1	LOCAL REGULATION CONSTRAINTS	4
2.2	FREQUENCY-RELATED TERMS AND VALUES	5
2.3	SYMBOL RATES.....	6
2.4	END-POINT TX CHARACTERISTICS.....	7
2.5	END-POINT RX CHARACTERISTICS	10
3	3D-UNB RULES IN UPLINK	13
3.1	UPLINK FRAME CONSTRUCTION OVERVIEW.....	13
3.2	UPLINK MESSAGE CONTENT	13
3.3	LENGTH INDICATOR (LI).....	14
3.4	BIDIRECTIONAL FRAG (BF)	14
3.5	REPEATED FLAG (REP).....	14
3.6	MESSAGE COUNTER (MC)	14
3.7	IDENTIFIER (ID)	15
3.8	UPLINK AUTHENTICATION (UL-AUTH).....	15
3.9	UPLINK ERROR DETECTION FIELD (UL-CRC).....	16
3.10	UPLINK CONVOLUTIONAL CODING FUNCTION	17
3.11	UPLINK FRAME TYPE (FT).....	17
3.12	UPLINK PREAMBLE (UL-Pr).....	18
3.13	UPLINK PROCEDURE.....	18
4	3D-UNB RULES IN DOWNLINK.....	21
4.1	DOWNLINK FRAME CONSTRUCTION OVERVIEW.....	21
4.2	DOWNLINK MESSAGE CONTENT	21
4.3	DOWNLINK AUTHENTICATION (DL-AUTH)	21
4.4	DOWNLINK ERROR DETECTION (DL-CRC)	22
4.5	DOWNLINK ERROR CORRECTION (ECC).....	23
4.6	DOWNLINK WHITENING FUNCTION.....	24
4.7	DOWNLINK FRAME TYPE (FT)	24
4.8	DOWNLINK PREAMBLE (DL-Pr).....	24
4.9	BIDIRECTIONAL PROCEDURE	25
5	APPLICATIVE/CONTROL LEVEL	28
5.1	KEEP-ALIVE CONTROL MESSAGE.....	28
5.2	CONFIRMATION CONTROL MESSAGE	28
5.3	APPLICATIVE PAYLOAD ENCRYPTION	29
6	ANNEX A (INFORMATIVE): TIME INTERVAL RECAP.....	30
7	ANNEX B (INFORMATIVE): MESSAGE TYPES, MESSAGE SIZES AND FRAME TYPE VALUES.....	35
8	ANNEX C (INFORMATIVE): NUMERICAL EXAMPLES	36
8.1	UL FRAME CONSTRUCTION	36
8.2	DL FRAME CONSTRUCTION	36
8.3	USABLE FREQUENCIES IN RC1	37
9	ANNEX D (INFORMATIVE): MISCELLANEOUS	38
9.1	DEFINITIONS	38
9.2	ACRONYMS	38
9.3	SYMBOLS.....	39
9.4	DRAWING AND DESCRIPTION CONVENTIONS.....	40
9.5	DOCUMENT HISTORY.....	40

1 INTRODUCTION

This document describes the radio interface (see Figure 1-1) between Sigfox connected objects and Sigfox network (SNW). This radio interface implements Sigfox V1 radio communication rules, revision 1.4, which main functions are illustrated in Figure 1-2.

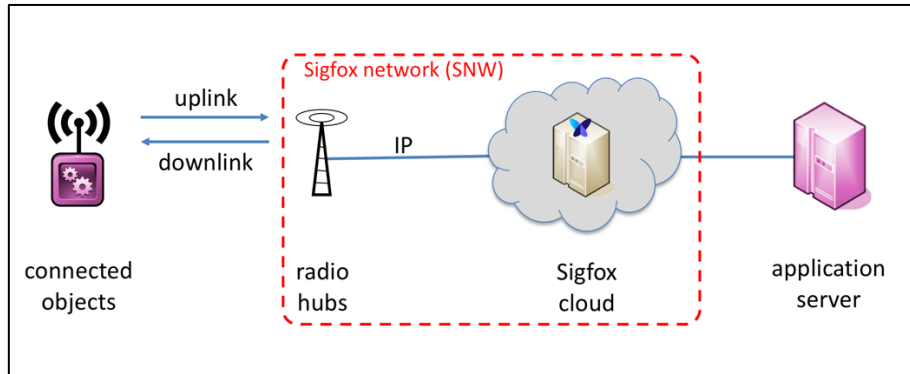

Figure 1-1 : Radio interface

To ensure consistency between documents describing the Sigfox solution, Sigfox radio communication rules are named "3D-UNB" or "3D-UNB rules" in the present document. 3D stands for triple diversity, i.e. diversity in time, in frequency and in space. Sigfox connected objects are named end-points (EP).

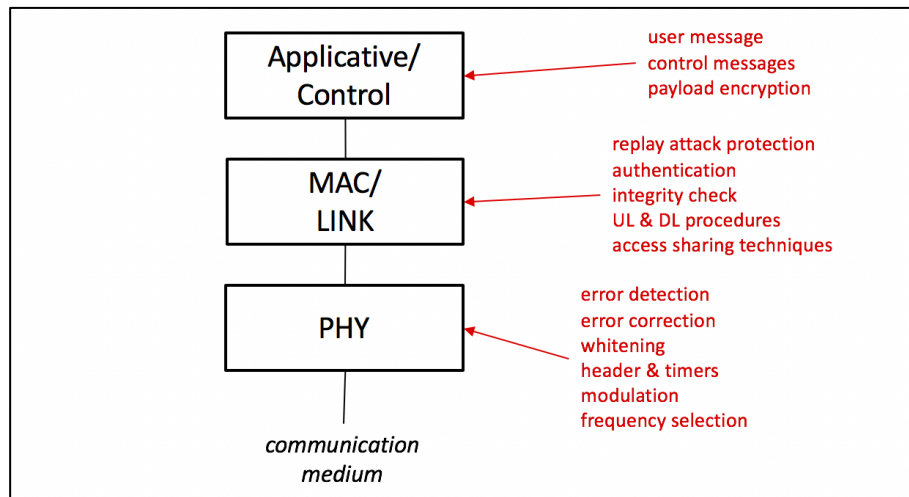

Figure 1-2 : Main functions of Sigfox V1 radio communication rules

NOTE 1: the present document specifies radio interface for objects connected to Sigfox network (SNW), as a whole. Description and technical specifications of radio hubs (i.e. Sigfox base stations) and Sigfox cloud are out of scope of the present document.

NOTE 2: some features, described here after, may not be available in all countries, where Sigfox network is operated.

NOTE 3: following what is in the present document is a prerequisite, but not a guarantee, for getting Sigfox certification.

	Sigfox connected objects Radio specifications	Ref.: EP-SPECS
		Rev.: 1.6
		Date: Mar.2022

2 RADIO HARDWARE ENGINEERING

2.1 Local regulation constraints

3D-UNB is designed to operate in license-free frequency bands. In each country, these frequency bands are ruled by local regulations, that define technical constraints for sharing the unlicensed spectrum.

As local regulations may vary from country to country, Sigfox has defined Radio Configurations (RC) that define radio parameter values that comply local regulations for a set of countries. Radio parameters values corresponding to a radio configuration are called a regional profile.

End-points have to comply with local regulations and implement Sigfox radio configuration parameters for each country, where they are intended to be used.

NOTE: constraints on uplink and downlink traffic model, that end-points may use to comply with commercial data plans, are out of scope of the present document.

2.1.1 ETSI 300 220: duty cycle

In European countries, access to the unlicensed spectrum is ruled by Duty Cycle (DC) limits and Tx power limits. The applicable regulations are:

- [NORM1] Short Range Devices (SRD) operating in the frequency range 25 MHz to 1000 MHz; Part 1: Technical characteristics and methods of measurement - ETSI EN 300 220-1 - Revision 3.1.1 - February 2017
- [NORM2] Short Range Devices (SRD) operating in the frequency range 25 MHz to 1000 MHz; Part 2: Harmonized Standard for access to radio spectrum for non-specific radio equipment - ETSI EN 300 220-2 - Revision 3.2.0 - September 2017

2.1.2 FCC 15 247: frequency hopping

In North American countries, access to the unlicensed spectrum is ruled by dwell time limits and Frequency Hopping (FH) constraints. The US applicable regulation is:

- [NORM3] CFR Title 47 Part 15 section 15.247 - Operation within the bands 902-928 MHz, 2400-2483.5 MHz, and 5725-5850MHz - April 7, 2017

2.1.3 ARIB T108: listen before talk

In Japan, access to the unlicensed spectrum is ruled by either Listen Before Talk (LBT) or Low Duty Cycle(LDC) and Tx power limits. The Japanese applicable regulations are:

- [NORM4] (English translation) 920MHz-Band Telemeter, Telecontrol and Data Transmission radio equipment - ARIB STD-T108 - version1.4 – 23rd Aprils 2022

2.1.4 Regional profile beaconing

Sigfox implementation of 3D-UNB uses several specific broadcast messages to help mobile end-points discovering what is the regional profile operated on their location. These broadcast messages are encapsulated in DL frames that have specific PHY format and modulation patterns. They are described in a dedicated Sigfox Specification document.

2.2 Frequency-related terms and values

2.2.1 Operating macro-channels

At time of printing, each radio configuration contains one uplink macro-channel and one downlink macro-channel, where SNW operates. Named "operating macro-channels", these channels are 192kHz wide and implemented with an accuracy of +/-1.62ppm. Table 2-1 details values of operating macro-channels per RCs.

Table 2-1 : UL and DL operating macro-channels of SNW

Frequency (in MHz)	RC1	RC2	RC3	RC4	RC5	RC6	RC7
UL low boundary	868.034	902.104	923.104	920.704	923.204	865.104	868.704
UL center	868.130	902.200	923.200	920.800	923.300	865.200	868.800
UL high boundary	868.226	902.296	923.296	920.896	923.396	865.296	868.896
DL low boundary	869.429	905.104	922.104	922.204	922.204	866.204	869.004
DL center	869.525	905.200	922.200	922.300	922.300	866.300	869.100
DL high boundary	869.621	905.296	922.296	922.396	922.396	866.396	869.196
Δf_{GAP}	+1.395	+3.000	-1.000	+1.500	-1.000	+1.100	+0.3

Usable macro-channel is operating macro-channel where low and high boundaries are shifted inward to compensate frequency inaccuracy of SNW implementation.

End-point shall use UL usable macro-channel and DL usable macro-channel to communicate with current SNW implementation.

NOTE: Annex 8 gives a numerical example of UL usable macro-channel for RC1.

2.2.2 Micro-channels

When local regulations require frequency hopping techniques, end-point shall implement at least 6 contiguous micro-channels of 25kHz in each uplink macro-channel (see 3.13.3).

2.2.3 Frequency reference stability in end-point

In 3D-UNB, stability of frequency reference in end-point has two impacts:

- a shift of end-point frequency reference (i.e. long-term stability),
- a drift of carrier center frequency of radio bursts transmitted by end-point (i.e. short-term stability).

NOTE: long-term stability of EP frequency reference includes all sources of frequency change, such as production inaccuracy, temperature, aging, supply voltage, etc.

End-points shall have an overall accuracy better than +/- 20ppm for their frequency reference.

End-points shall ensure that peak and mean drifts of carrier center frequency within an UL radio burst comply with Table 2-2.

Table 2-2: Frequency drifts within a radio burst

	BR100 _{UL}	BR600 _{UL}
Peak frequency drift	+/- 30 Hz/sec	+/- 100Hz/sec
Mean frequency drift	+/- 20 Hz/sec	+/- 50Hz/sec

where:

- the peak frequency drift is evaluated over the first 19 symbols of a radio burst (i.e. symbols corresponding to the UL-Pr field),
- the mean frequency drift is evaluated over the symbols corresponding to the FT field and the UL-PHY-CONTENT field.

2.3 Symbol rates

In uplink, end-point may select the symbol rate (see Table 2-3) on a per message basis and according to regional profile allowance (see Table 2-4).

It shall use the same symbol rate for all the radio bursts associated to a message.

The duration of an uplink symbol is named TS_{UL}.

Table 2-3: Symbol rates in 3D-UNB system

Communication	Symbol rate name	Symbol rate (in baud)	Cumulated error over full length of radio burst
uplink	BR100 _{UL}	100	+/- 3%
	BR600 _{UL}	600	+/- 3%
downlink	BR600 _{DL}	600	+/- 0,01%

Table 2-4: Allowed symbol rates in uplink per regional profile

	RC1	RC2	RC3	RC4	RC5	RC6	RC7
allowed symbol rates	BR100 _{UL} BR600 _{UL}	BR600 _{UL}	BR100 _{UL} BR600 _{UL}	BR600 _{UL}	BR100 _{UL} BR600 _{UL}	BR100 _{UL} BR600 _{UL}	BR100 _{UL} BR600 _{UL}

End-point shall keep the jitter on uplink symbol duration lower or equal to +/- 1%.

For downlink radio bursts, SNW uses symbol rate BR600_{DL}, as specified in Table 2-3. The duration of a downlink symbol is named TS_{DL}.

2.4 End-point Tx characteristics

2.4.1 Output power

In 3D-UNB systems, the output power of an end-point is defined by giving a target transmit power (EP-Pwr_{TARG}). EP-Pwr_{TARG} value is expressed in dBm EIRP; it is profile dependent. This target value (see Table 2-5) is used to evaluate coverage of 3D-UNB systems in each country.

Table 2-5 : Target output power of end-point

Power (dBm EIRP)	RC1	RC2	RC3	RC4	RC5	RC6	RC7
EP-Pwr _{TARG}	16	24	16	24 22 (Singapore)	14	16	16

2.4.2 Power class

An end-point, that transmits at EP-Pwr_{TARG}, is said to be "Class 0".

When local regulation allows, end-point may transmit at higher transmit power, but the drawback is an increased power consumption.

An end-point may transmit at lower transmit power, but the drawback is a reduced quality of service in uplink.

Four end-point power classes are defined, as in Table 2-6.

Table 2-6: End-point power classes

Tx Power Class	End-point actual transmit power (in dBm EIRP)		
	max.	typ.	min.
0	local regulation	EP-Pwr _{TARG}	EP-Pwr _{TARG} - 4
1	EP-Pwr _{TARG} - 4	EP-Pwr _{TARG} - 6	EP-Pwr _{TARG} - 9
2	EP-Pwr _{TARG} - 9	EP-Pwr _{TARG} - 11	EP-Pwr _{TARG} - 14
3	EP-Pwr _{TARG} - 14	EP-Pwr _{TARG} - 16	not defined

2.4.3 Uplink modulation scheme

3D-UNB implements a differential binary phase shift keying (D-BPSK) modulation in uplink (see Figure 2-1). A symbol shaping is added during the phase rotation for power class 0 and class 1 end-points, to keep the emission spectrum within the limits defined in section 2.4.4.

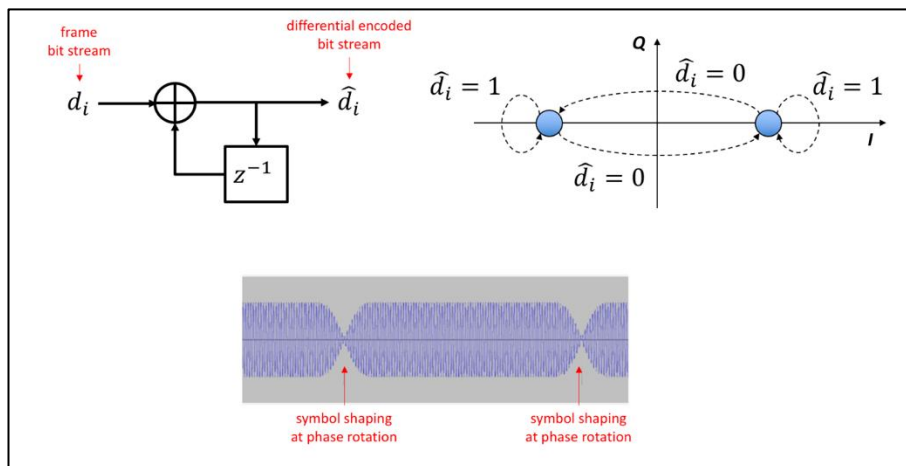

Figure 2-1 : D-BPSK principle for class 0 and class 1 end-points in 3D-UNB

The end-point shall have a phase modulation accuracy in uplink as specified in Table 2-7.

Table 2-7: modulation accuracy values

Parameter	Value
Maximum modulation RMS phase error	10°
Maximum modulation peak phase error	30°

Before the first symbol corresponding to the first bit of a frame, a radio burst may start with a ramp-up and extra symbols (see Figure 2-2). This extra transmission shall be less or equal to $2 \times TS_{UL}$ and with no phase modulation in it.

In the same manner, a radio burst may end with extra symbols and a ramp down (see Figure 2-2). This extra transmission shall be less or equal to $2 \times TS_{UL}$ and with no phase modulation in it.

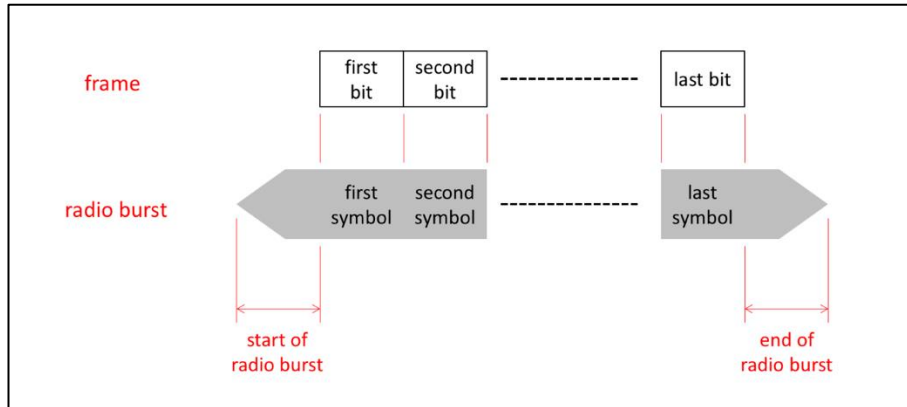

Figure 2-2 : radio burst shaping

NOTE: the starting point and the ending point of a radio burst are the times where the Tx power level crosses the stabilized transmit power level minus 20dB (see Figure 2-3).

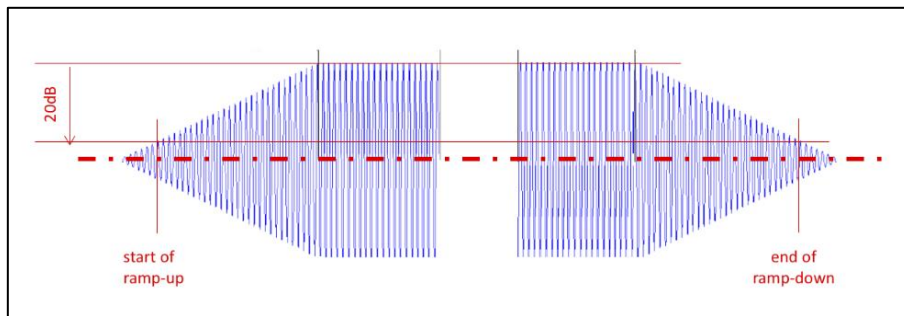

Figure 2-3: Ramp-up and ramp-down limits

2.4.4 Tx spectrum template

Tx spectrum of end-point results from modulation within radio bursts and switching transients. Table 2-8 defines maximum limits for Tx power spectral density for power class 0 and power class 1 devices.

Table 2-8: Frequency intervals and limits for Tx spectrum of power class 0 and power class 1 end-points

Frequency interval	Averaged power spectral density on frequency interval (in dBc)
$[-96\text{kHz}; -25/\text{TS}_{\text{UL}}]$	-52
$[-25/\text{TS}_{\text{UL}}; -5/\text{TS}_{\text{UL}}]$	-45
$[-5/\text{TS}_{\text{UL}}; -3/\text{TS}_{\text{UL}}]$	-35
$[-3/\text{TS}_{\text{UL}}; -1/\text{TS}_{\text{UL}}]$	-20
$[-1/\text{TS}_{\text{UL}}; +1/\text{TS}_{\text{UL}}]$	0
$[+1/\text{TS}_{\text{UL}}; +3/\text{TS}_{\text{UL}}]$	-20
$[+3/\text{TS}_{\text{UL}}; +5/\text{TS}_{\text{UL}}]$	-35

[+5/TS _{UL} ; +25/TS _{UL}]	-45
[+25/TS _{UL} ; +96kHz]	-52

Table 2-9 defines maximum limits for Tx power spectral density for power class 2 and power class 3 devices.

Table 2-9: Frequency intervals and limits for Tx spectrum of power class 2 and power class 3 end-points

Frequency interval	Averaged power spectral density on frequency interval (in dBc)
[-96kHz; -25/TS _{UL}]	-45
[-25/TS _{UL} ; -10/TS _{UL}]	-40
[-10/TS _{UL} ; -5/TS _{UL}]	-20
[-5/TS _{UL} ; -3/TS _{UL}]	-15
[-3/TS _{UL} ; -1/TS _{UL}]	-8
[-1/TS _{UL} ; +1/TS _{UL}]	0
[+1/TS _{UL} ; +3/TS _{UL}]	-8
[+3/TS _{UL} ; +5/TS _{UL}]	-15
[+5/TS _{UL} ; +10/TS _{UL}]	-20
[+10/TS _{UL} ; +25/TS _{UL}]	-40
[+25/TS _{UL} ; +96kHz]	-45

2.5 End-point Rx characteristics

2.5.1 Foreword on end-point Rx characteristics

3D-UNB is designed to operated even if some end-points are uplink only. Receiving capability is optional in end-point. Therefore, values for the technical parameters listed in the present section are target values, recommended for getting a good downlink behavior if the final usage of an end-point requires bidirectional communications.

Engineering designers are strongly encouraged to pay close attention to end-point receivers, because their characteristics have a direct impact on the overall performance of the downlink communication.

2.5.2 Modulation scheme in DL

For downlink transmission, 3D-UNB implements a GFSK modulation with 600 baud symbol rate (see Table 2-3) and a frequency deviation of $\Delta f_{MOD} = 800\text{Hz}$.

2.5.3 Nominal error rate

The nominal error rate applies to nominal and static conditions without interference.

For 3D-UNB end-points, the nominal frame error rate shall be $FER_{NOM} = 10^{-6}$, evaluated with a conducted input level 10dB above $RxSens_{REF}$.

2.5.4 Reference sensitivity

In 3D-UNB systems, reference receiver sensitivity ($RxSens_{REF}$) is defined as the conducted input level at which the reference error rate of $FER_{REF}=10\%$ is met. $RxSens_{REF}$ value is -126dBm.

2.5.5 Target end-point radiated sensitivity

In 3D-UNB systems, the sensitivity of an end-point is defined by giving a target end-point sensitivity ($EP-Sen_{TARG}$) at the antenna. This recommended value is used to evaluate coverage of 3D-UNB systems in each country.

The target end-point radiated sensitivity is $EP-Sen_{TARG} = -126dBm$, evaluated with a dipole antenna and with $FER=10\%$.

NOTE: although some final usages may accept less sensitivity than the target value, improved sensitivity, improved resistance to interferers and good electromagnetic compatibility are key for the performance of end-point receivers.

2.5.6 Downlink radio burst shaping

SNW transmits a downlink radio burst with shaping limits, as follows:

- duration of the start of radio burst less or equal to $0,5 \times TSDL$,
- duration of the end of radio burst less or equal to $0,5 \times TSDL$.

2.5.7 Resistance to interferers and blocking characteristics

For 3D-UNB end-points, the resistance to interference is driven by the end-point final usage and its operating conditions. Table 2-10 gives target values for resistance to near interferers; Table 2-11 is for blocking.

Table 2-10: Interference level

Carrier offset	C/I
3.5kHz	-30 dB
10kHz	-50 dB
>1MHz	-60 dB

Table 2-11: Blocking levels

Carrier offset	Blocker level
$\pm 10MHz$	-50dBm

	Sigfox connected objects Radio specifications	Ref.: EP-SPECS
		Rev.: 1.6
		Date: Mar.2022

2.5.8 Receiver dynamic input range

Dynamic range of receivers generally includes quite a number of technical conditions. Target value, defined in the present clause, is an indication of the linear range, before saturation. Maximum conducted power at end-point receiver is -42dBm.

3 3D-UNB RULES IN UPLINK

3.1 Uplink frame construction overview

This section deals with formats and functions in uplink, from applicative/control level down to physical level. An overview of the uplink communication stack and the corresponding construction steps is illustrated in Figure 3-1.

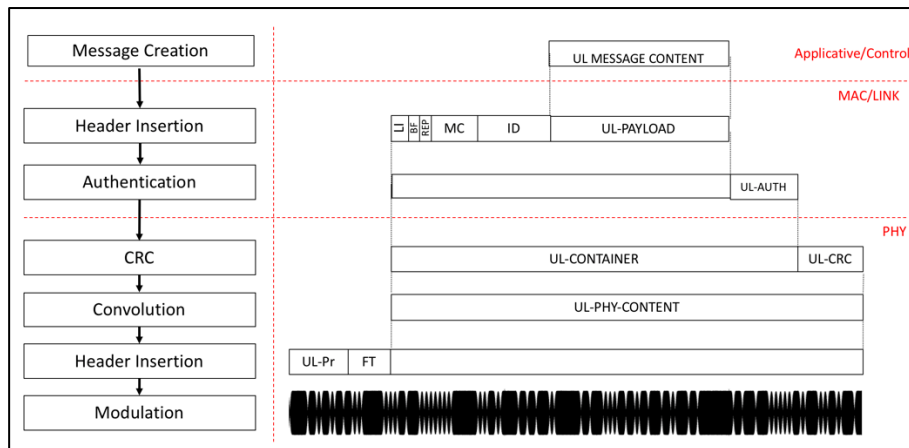

Figure 3-1: Uplink communication stack overview

3.2 Uplink message content

The content of the uplink message may be applicative data or control data. The format of an applicative message content is freely defined by the application. The format of control message content is specified in section 5.

End-point shall copy the message content into UL-PAYLOAD field, as detailed in Table 3-1.

Table 3-1 : LI values and UL-AUTH size in relation with other message parameters

UL message content	UL-PAYLOAD content	LI value (MSB, LSB)	UL-AUTH size (in bytes)	UL-CONTAINER size (in bytes)
empty	empty (*)	00	2	8
0b0	empty (*)	10	2	8
0b1	empty (*)	11	2	8
1 byte	message content	00	2	9
2 bytes	message content	10	4	12
3 bytes	message content	01	3	12
4 bytes	message content	00	2	12
5 bytes	message content	11	5	16
6 bytes	message content	10	4	16
7 bytes	message content	01	3	16
8 bytes	message content	00	2	16

9 bytes	message content	11	5	20
10 bytes	message content	10	4	20
11 bytes	message content	01	3	20
12 bytes	message content	00	2	20

(*): In such case, the UL-PAYLOAD field is omitted in the UL-CONTAINER.

3.3 Length Indicator (LI)

It is a 2-bit field. EP shall set LI bits according to Table 3-1.

3.4 Bidirectional Frag (BF)

It is 1-bit field. EP shall set it, as follows:

- 0b0 in an UL-container carrying application message in a U-procedure,
- 0b1 in an UL-container carrying application message in a B-procedure.

3.5 Repeated Flag (REP)

It is a 1-bit field. EP shall set it to 0x0.

3.6 Message Counter (MC)

It is a 12-bit field taking values between 0 and $(MC_{max}-1)$. The MC_{max} value is defined in the product certificate and known by the 3D-UNB system.

The end-point shall increment the message counter by 1 after each UL message sent over the air. When an UL message is sent with MC equals to $(MC_{max}-1)$, the MC of the next UL message shall be 0.

If a device does not support payload encryption, its MC_{max} shall be constant over its whole lifetime and chosen among one of the following values:

- 128
- 256
- 512
- 1024
- 2048
- 4096

If a device supports payload encryption, its MC_{max} shall be 4096.

NOTE: the message counter value is the same for all the N uplink frames induced by an UL message.

NOTE: the message counter is incremented after each new message, irrespective of the U- or B- procedure used over the air.

NOTE: although there is no strong requirement on the initial value of MC, the recommended practice is to use 0x000 as MC initial value in production.

3.7 Identifier (ID)

It is a 32-bit field. EP shall load its EP identifier bytes in reverse order into the ID field (see Figure 3-2).

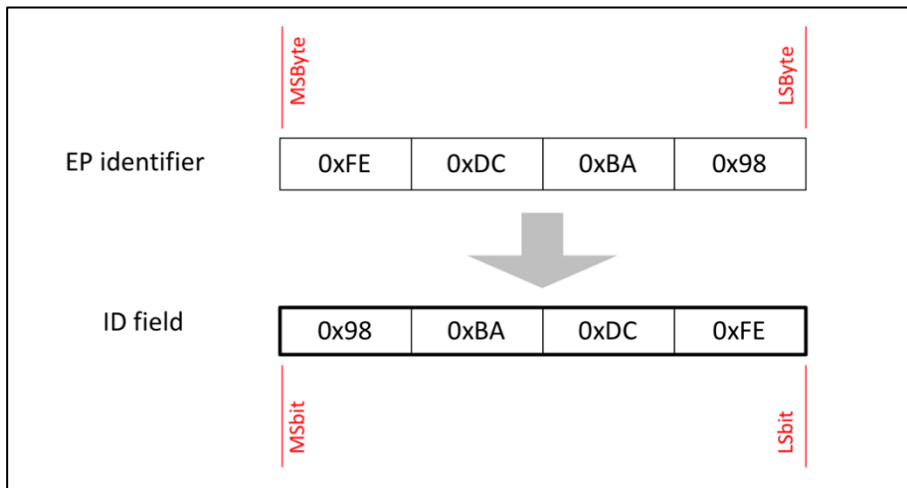

Figure 3-2: Example of EP identifier copied in ID field

3.8 Uplink Authentication (UL-AUTH)

It is a variable length field. EP shall set its length according to Table 3-1 and its content according to the three steps, as follows:

Step 1:

To build UL-DATA_{IN}, the end-point shall concatenate six fields in order: LI, BF, REP, MC, ID and UL-PAYLOAD (see Figure 3-3). When payload encryption is active, the end-point shall add the RoC field, as a first field of UL-DATA_{IN}.

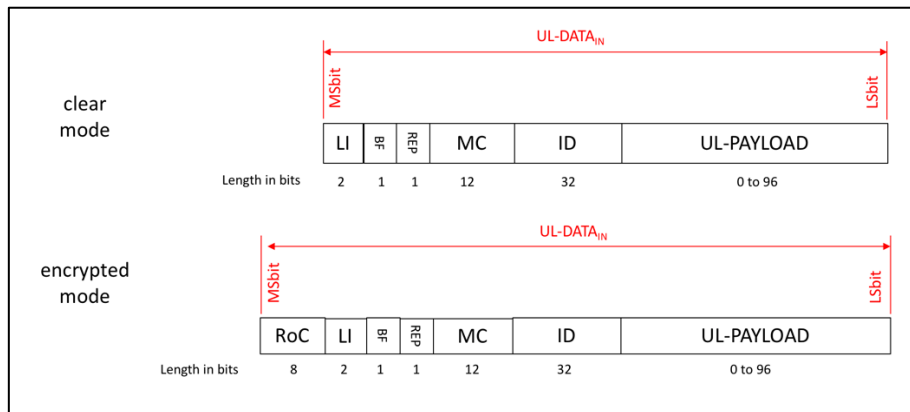

Figure 3-3: UL-DATA_{IN} field construction

Step 2:

The end-point shall use AES128 in mode CBC as authentication algorithm, as follows (see Figure 3-4), where authentication key (Ka) is provided the 3D-UNB system owner.

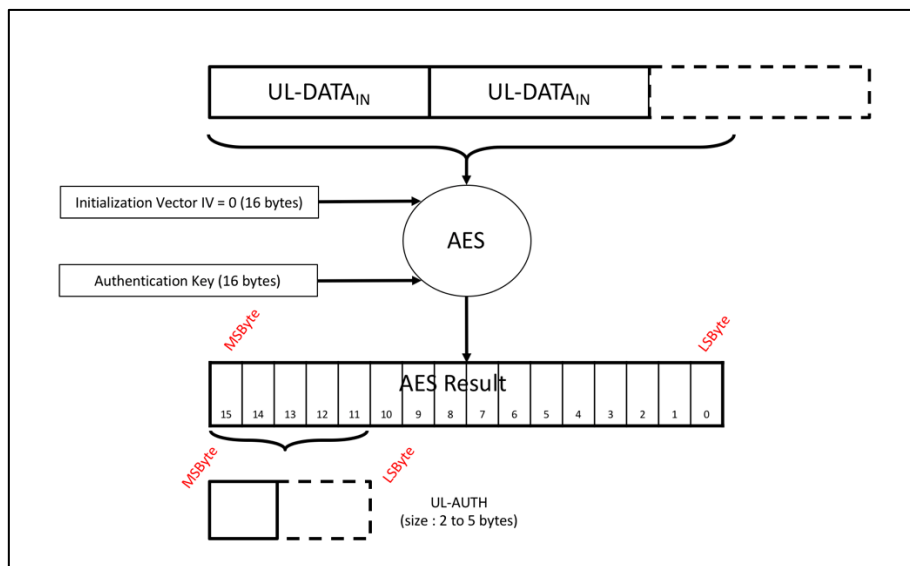

Figure 3-4: Principle of UL-AUTH field evaluation

Step 3:

The end-point shall copy 2 to 5 of the MSBytes of the AES/CBC result into the UL-AUTH field, according to the length defined in Table 3-1.

3.9 Uplink error detection field (UL-CRC)

It is a 16-bit field. EP shall evaluate the UL-CRC field, as follows (see Figure 3-5):

- devise the UL-CONTAINER value with the polynomial generator $X^{16} + X^{12} + X^5 + 1$,
- XOR the remainder with 0xFFFF.

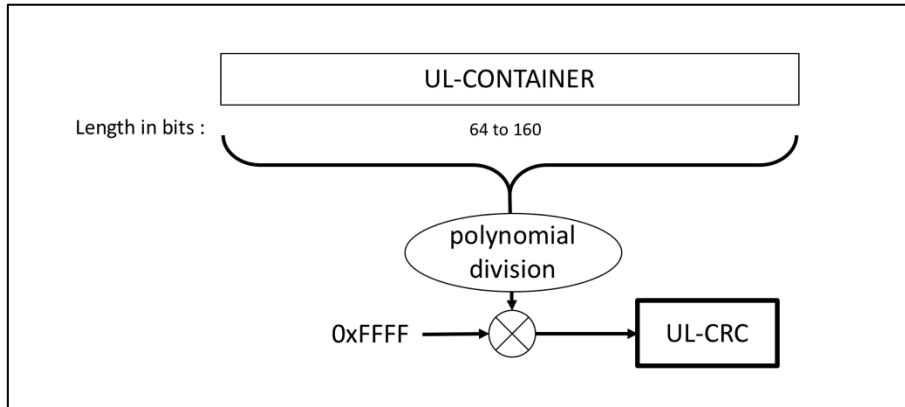

Figure 3-5: UL-CRC computation

3.10 Uplink convolutional coding function

The end-point shall encode the concatenation of UL-CONTAINER + UL-CRC with one of the convolutional codes in Table 3-2 and shall put the result in UL-PHY-CONTENT field (see Figure 3-6).

Table 3-2: Polynomials for convolution coding of UL frames

Number of frames	Frame emission rank	Polynomial
multiple	First	$R=1$ (identity)
multiple	Second	$R=1+X+X^2$
multiple	Third	$R=1+X^2$
single	/	$R=1$ (identity)

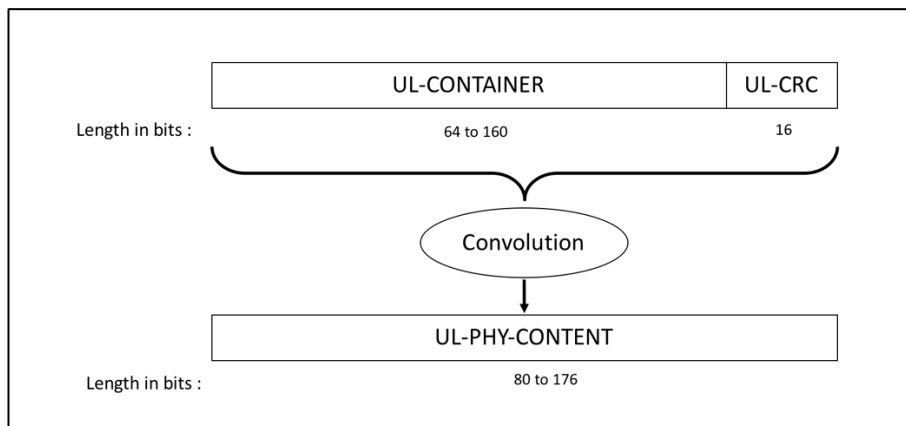

Figure 3-6: Convolutional coding in uplink

3.11 Uplink frame type (FT)

It is a 13-bit field. EP shall select its value according to Table 3-3.

Table 3-3: Frame type values in UL

Message type	Container Length (in bytes)	Frame Type value (in binary)	Frame Type value (in hexa (*))	UL frame emission rank
Application Message	8	0b0 0000 0110 1011	0x006B	first
		0b0 0110 1110 0000	0x06E0	second
		0b0 0000 0011 0100	0x0034	third
	9	0b0 0000 1000 1101	0x008D	first
		0b0 0000 1101 0010	0x00D2	second
		0b0 0011 0000 0010	0x0302	third
	12	0b0 0011 0101 1111	0x035F	first
		0b0 0101 1001 1000	0x0598	second
		0b0 0101 1010 0011	0x05A3	third
	16	0b0 0110 0001 0001	0x0611	first
		0b0 0110 1011 1111	0x06BF	second
		0b0 0111 0010 1100	0x072C	third
20	0b0 1001 0100 1100	0x094C	first	
	0b0 1001 0111 0001	0x0971	second	
	0b0 1001 1001 0111	0x0997	third	
Control Message	16	0b0 1111 0110 0111	0x0F67	first
		0b0 1111 1100 1001	0x0FC9	second
		0b1 0001 1011 1110	0x11BE	third

(*): Hexadecimal values given with most significant bits padded with zero.

3.12 Uplink preamble (UL-Pr)

It is a 19-bit field. End-point shall set its value to 0b1010101010101010101.

3.13 Uplink procedure

The uplink only procedure (i.e. U-procedure) is initiated by an end-point wishing to send a UL message to the SNW, with no onward downlink message. The end-point chooses the U-procedure on a per message basis.

3.13.1 Single/multiple frame principle

For an uplink message, 3D-UNB rules allow to create one or three frame(s) and then to transmit one or three radio burst(s) over the air. This feature is named single/multiple frame.

The parameter N defines the number of uplink frames per message (see Figure 3-7). The selection of N=1 results in the lowest end-point energy consumption, whereas a value of N=3 provides increased resiliency. N=2 is not permitted. End-point shall set the FT value according to Table 3-3.

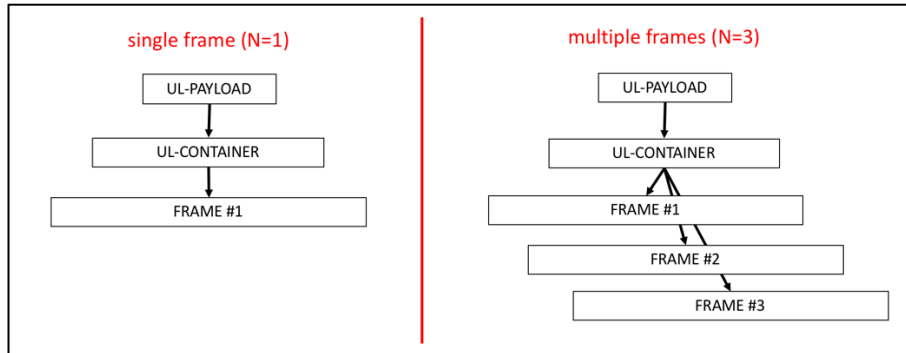

Figure 3-7: Principle of multiple transmissions in uplink

NOTE: single or multiple frame(s) carry the same UL-CONTAINER and the same UL-CRC; only convolution code and FT value are different.

3.13.2 Time intervals in U-procedure

Time intervals in U-procedure are illustrated in Figure 6-1 to Figure 6-6, with values as follows:

Table 3-4 : Time interval values for frames in U-procedure

	RC1	RC2	RC3	RC4	RC5	RC6	RC7
$T_{IFU\ MIN}$	10ms	10ms	10ms	10ms	10ms	10ms	10ms
$T_{IFU\ MAX}$	2000ms	2000ms	N.A.	2000ms	N.A.	2000ms	2000ms
$T_{IFP\ MIN}$	10ms	10ms	10ms	10ms	10ms	10ms	10ms
$T_{IFP\ MAX}$	N.A.	N.A.	N.A.	N.A.	N.A.	N.A.	N.A.
T_{LF}	N.A.	N.A.	8s (*)	N.A.	8s	N.A.	N.A.

(*) Only applicable if LBT method access is used (not applicable in LDC). Note that for RC3 certification relying on LDC access method, when interframe (T_{IFU}) < 50ms is selected, Japanese regulation ARIB STD-T108 Version 1. 4 requires that device emission does not exceed 4s. Therefore, when interframe < 50ms is selected, usable Sigfox payload length must not exceed 1byte.

3.13.3 Frequency selection in U-procedure

End-point shall select the center carrier frequency f_{UL} of each radio burst pseudo-randomly.

End-point shall ensure that:

- pseudo-random frequencies are statistically independent and evenly distributed,
- all f_{UL} values fall within SNW usable macro-channel,
- its pseudo-random frequency series is unique for each end-point,
- its radio contribution makes the overall spectral occupation of all the same product units uniform over the full uplink usable macro-channel.

	Sigfox connected objects Radio specifications	Ref.: EP-SPECS
		Rev.: 1.6
		Date: Mar.2022

When local regulations require frequency hopping techniques, end-point shall ensure that the f_{UL} distribution is independent and evenly distributed among micro-channels as well as within each of the micro-channels.

NOTE: Annex 8 gives numerical example of allowable frequency range for f_{UL} .

4 3D-UNB RULES IN DOWNLINK

4.1 Downlink frame construction overview

This section deals with formats and functions in downlink, from applicative/control level down to physical level. An overview of the downlink communication stack and the corresponding construction steps are illustrated in Figure 4-1.

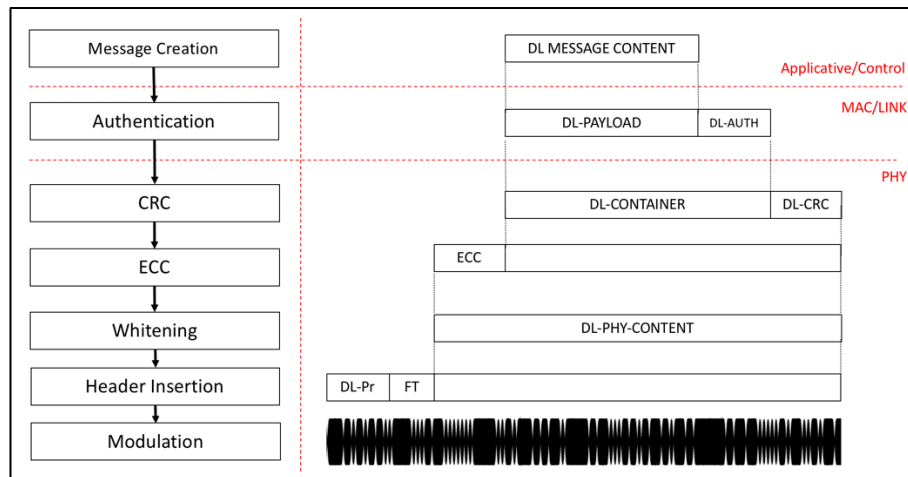

Figure 4-1: Downlink communication stack overview

4.2 Downlink message content

The content of downlink message is a fixed-length field. It carries applicative data prepared by user's distant application server in response to an uplink message. Format of the DL-PAYLOAD field is user dependent.

4.3 Downlink authentication (DL-AUTH)

DL-AUTH field is evaluated in three steps by the SNW:

Step 1:

SNW concatenates five fields in order (see Figure 4-2) to build DL-DATA_{IN}.

Step 2:

SNW runs the AES128 algorithm (see Figure 4-3) on DL-DATA_{IN} and with the authentication key (Ka), known by the 3D-UNB system owner.

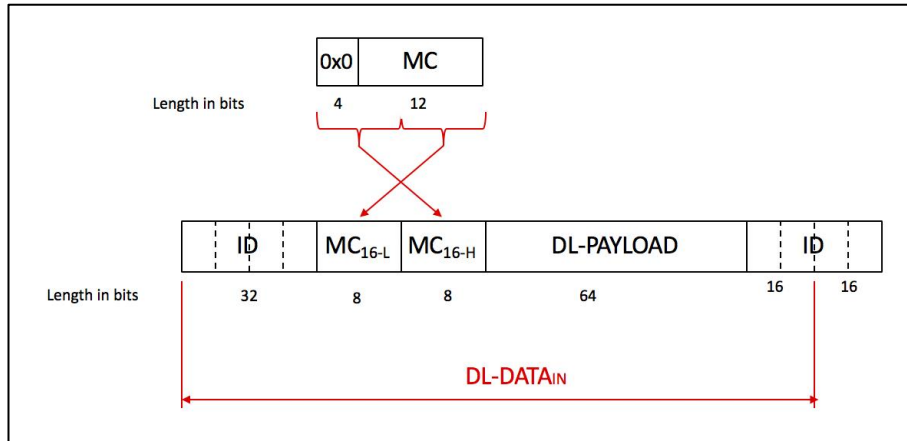

Figure 4-2: DL-DATA_{IN} construction principle

Step 3:

SNW copies the two MSByte of the AES128 result into the DL-AUTH field.

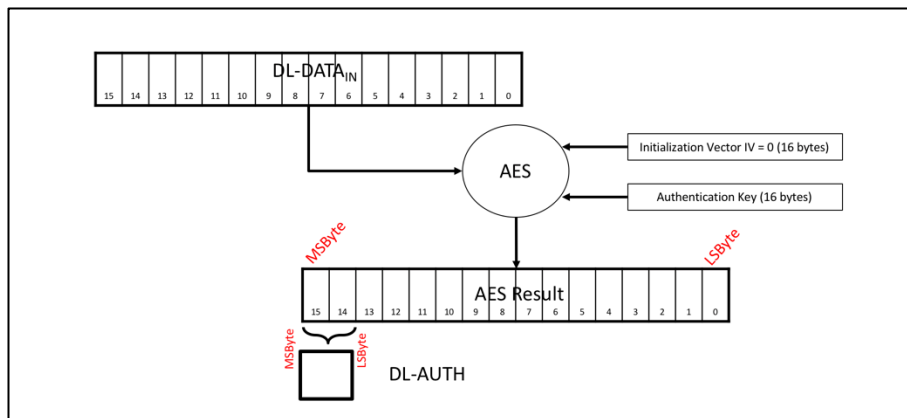

Figure 4-3: DL-AUTH computation

4.4 Downlink error detection (DL-CRC)

SNW evaluates the DL-CRC field (see Figure 4-4), as follows:

- devise the DL-CONTAINER value with the polynomial generator $X^8 + X^5 + X^3 + X^2 + X + 1$,
- copy the remainder in DL-CRC field.

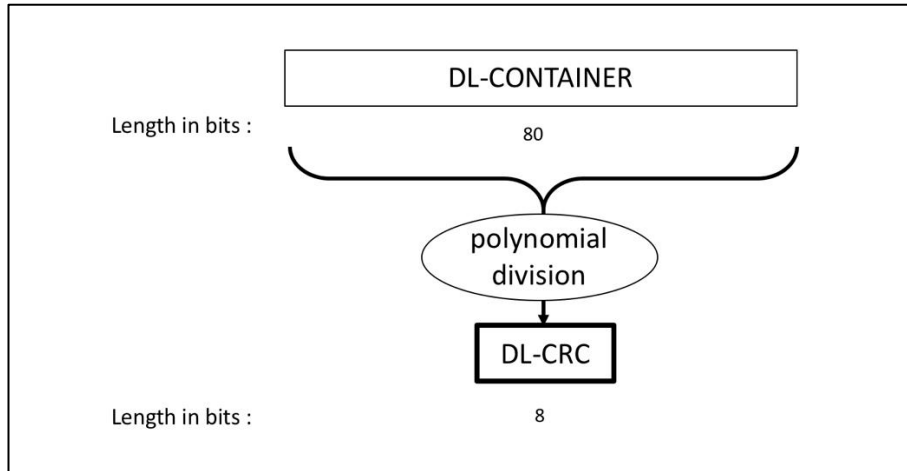

Figure 4-4: DL-CRC field evaluation in DL

4.5 Downlink error correction (ECC)

The error correction function in downlink implements BCH15-11 Error Correction Codes over the concatenation of DL-CONTAINER and DL-CRC fields.

SNW evaluates the ECC field in two steps (see Figure 4-5).

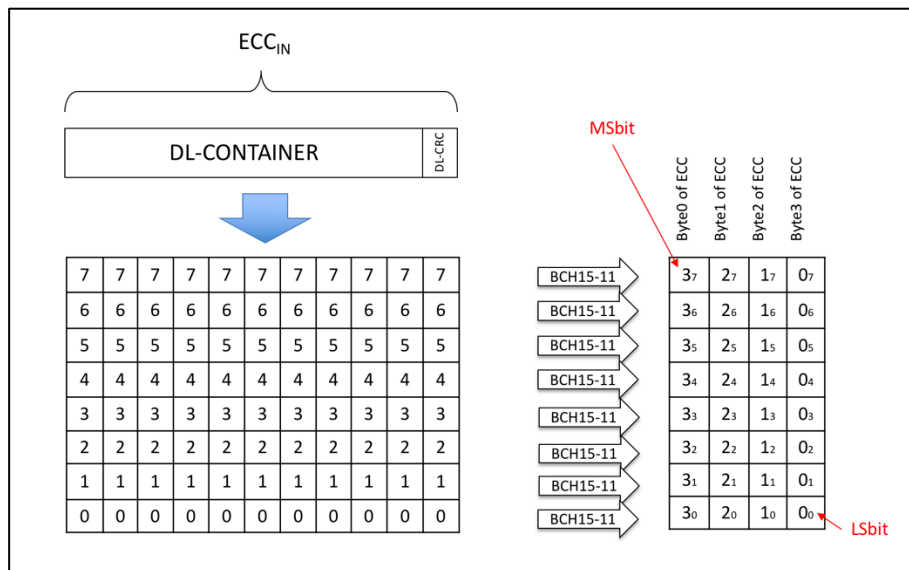

Figure 4-5: ECC field computation in DL

4.6 Downlink whitening function

SNW evaluates the DL-PHY-CONTENT in two steps (see Figure 4-6), as follows:

- initialize the whitening function with following value with big endian encoding :
 - if (DEVICE ID x MC) mod512 equals 0, then set the initialization value to 51110,
 - else set the initialization value (DEVICE ID x MC) mod512
- XOR the concatenation of ECC, DL-CONTAINER and DL-CRC fields, in order, with the PN9-SEQUENCE generated by the PN9 polynomial: $R=X^9 +X^4 +1$ initiated with the above initialization value.

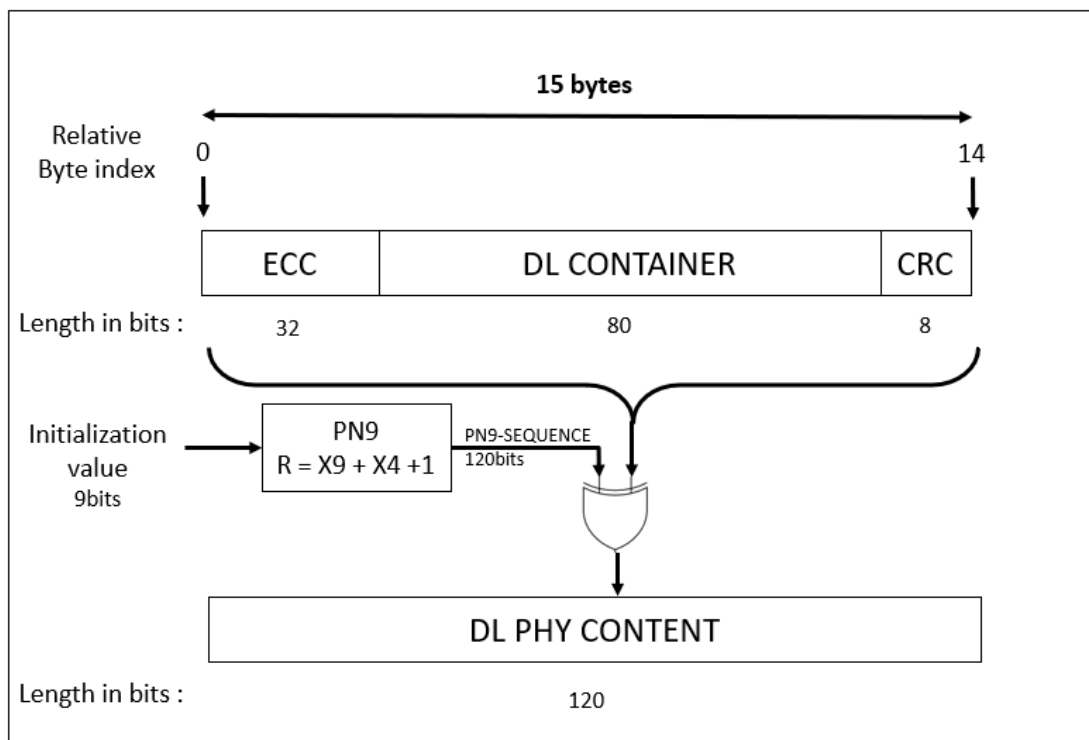

Figure 4-6: Whitening function in DL

4.7 Downlink frame type (FT)

It is a 13-bit long, with value 0b1001000100111 (i.e. 0x1227 when MSbits are zero padded).

4.8 Downlink preamble (DL-Pr)

It is a 91-bit field (see Figure 4-7). Its value is a string of bits composed of 1 and 0 alternately, ending with a 1.

Table 4-2 : Time interval values in B-procedure at PHY level

	RC1	RC2	RC3	RC4	RC5	RC6	RC7
$T_{IFB\ MIN}$	500ms	500ms	10ms	500ms	10ms	500ms	500ms
$T_{IFB\ MAX}$	525ms	525ms	N.A.	525ms	N.A.	525ms	525ms
$T_{IFP\ MIN}$	10ms	10ms	10ms	10ms	10ms	10ms	10ms
$T_{IFP\ MAX}$	N.A.	N.A.	N.A.	N.A.	N.A.	N.A.	N.A.
T_{LF}	N.A.	N.A.	8s(*)	N.A.	8s	N.A.	N.A.

(*) Only applicable if LBT method access is used (not applicable in LDC). Note that for RC3 certification relying on LDC access method, when interframe (T_{IFU}) < 50ms is selected, Japanese regulation ARIB STD-T108 Version 1.4 requires that device emission does not exceed 4s. Therefore, when interframe < 50ms is selected, usable Sigfox payload length must not exceed 1byte

NOTE: definition of T_{IFP} prevents an end-point to interpose a new procedure when waiting for reception window in a B-procedure.

4.9.2 Frequency selection in B-procedure

Generally speaking, EP shall select carrier center frequency of its first uplink frame in a B-procedure the same way as in U-procedure (see section 3.13.3).

In case of multiple frame procedure, second and third carrier center frequencies have a fixed difference Δf_{MF} with the first one (see Figure 4-9). Δf_{MF} is regional profile dependent and defined in Table 4-3.

Table 4-3 : Frequency parameters in B-procedure

	RC1	RC2	RC3	RC4	RC5	RC6	RC7
Δf_{MF}	6kHz	25kHz	6kHz	25kHz	6kHz	6kHz	6kHz

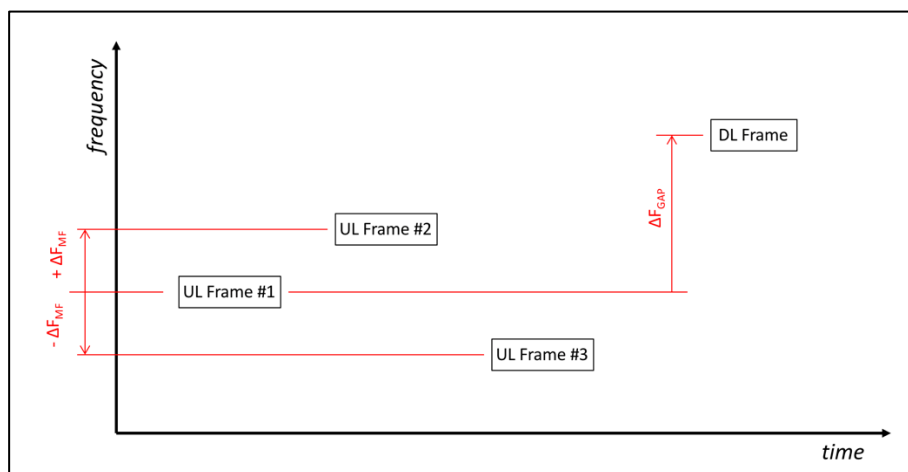

Figure 4-9 : Frequency layout in B-procedure

	Sigfox connected objects Radio specifications	Ref.: EP-SPECS
		Rev.: 1.6
		Date: Mar.2022

Carrier center frequency of the radio burst sent back by SNW is shifted by Δf_{GAP} from the estimated carrier center frequency of the corresponding uplink radio burst (see Table 2-1). Δf_{GAP} is regional profile dependent and defined in Table 2.1. SNW implements Δf_{GAP} with an accuracy of +/-150Hz.

NOTE: Accuracy of Δf_{GAP} includes errors on UL frequency estimation and DL frequency synthesis in SNW base stations.

EP shall select carrier center frequency for the UL confirmation control message, sent at successful completion of a B-procedure, pseudo-randomly in compliance with UL frequency selection described in section 3.13.3.

5 APPLICATIVE/CONTROL LEVEL

5.1 Keep-alive control message

The keep-alive control message (see Figure 5-1) is optionally sent by end-point for reporting local parameters. End-point shall send a keep alive control message in a multiple frame procedure (i.e. three frames) and with the following four fields in order:

- Control Type (CT) field is 8-bit long. Its value shall be 0x08,
- VDD-IDLE field is a 16-bit unsigned integer. It shall contain the battery voltage value outside an EP radio burst transmission with 1mV per unit (i.e. voltage from 0mV to 65 535mV),
- VDD-Tx field is a 16-bit unsigned integer. It shall contain the battery voltage value within an EP radio burst transmission with 1mV per unit (i.e. voltage from 0mV to 65 535mV),
- TEMP field is a 16-bit signed integer, with two's complement representation. It shall contain the EP temperature with 0,1°C per unit.

End point shall serialize VDD-IDLE, VDD-Tx and TEMP fields with little endian encoding.

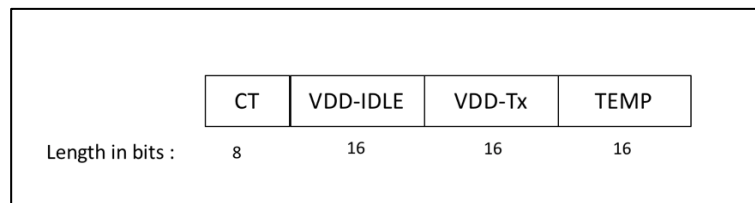

Figure 5-1 : Payload of a keep-alive control message

5.2 Confirmation control message

The UL confirmation control message (see Figure 5-2) is mandatorily sent by the end-point after the successful reception of a downlink message in a B-procedure. End-point shall send an UL confirmation control message in a single frame procedure (i.e. one frame) and with the following five fields in order:

- Control Type (CT) field is 8-bit long. Its value shall be 0x09,
- VDD-IDLE field is a 16-bit unsigned integer. It shall contain the battery voltage value outside an EP radio burst transmission with 1mV per unit (i.e. voltage from 0mV to 65 535mV),
- VDD-Tx field is a 16-bit unsigned integer. It shall contain the battery voltage value within an EP radio burst transmission with 1mV per unit (i.e. voltage from 0mV to 65 535mV),
- TEMP field is a 16-bit signed integer, with two's complement representation. It shall contain the EP temperature with 0,1°C per unit,
- RSSI field is an 8-bit signed integer, with two's complement representation. It shall code the received signal strength (RSS) estimation, made by the end-point over the DL frame of the B-procedure, with the following formula: $RSSI = \text{"EP RSS estimation"} + 100$ (unit: dBm). RSSI accuracy shall be within +/-2dB.

End point shall serialize VDD-IDLE, VDD-Tx and TEMP fields with little endian encoding.

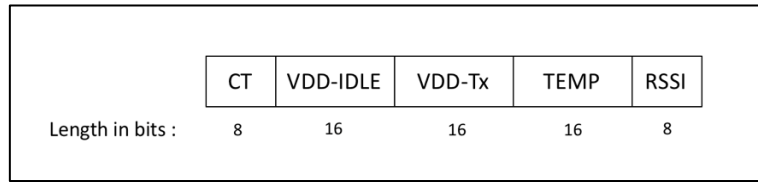

Figure 5-2 : Payload of a UL confirmation control message

5.3 Applicative payload encryption

Payload encryption is a procedure that encrypts the payload of applicative messages over the air, in both uplink and downlink communication. It uses an AES128 algorithm in mode CTR with an encryption key (Ke), unique per end-point. The procedure is specified in a dedicated Sigfox specification document.

6 ANNEX A (INFORMATIVE): TIME INTERVAL RECAP

This informative annex recaps how time intervals apply depending on U- or B- procedures, single or multiple frames and spectrum sharing techniques (i.e. DC, FH or LBT). Twelve configurations are possible. For each configuration, the relevant time intervals are illustrated here after.

NOTE: relative frame positions on frequency vertical axis are purely indicative.

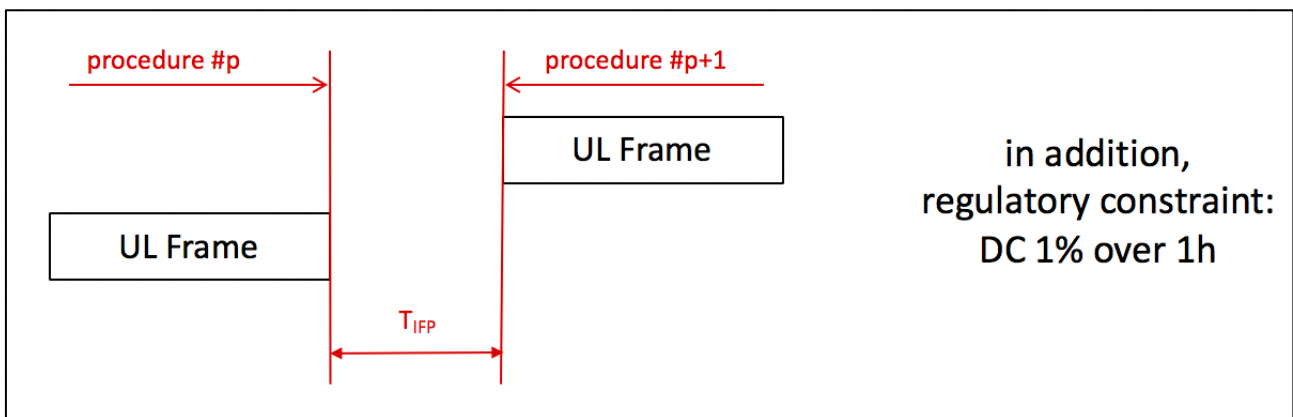

Figure 6-1 : U-procedure, single frame, DC

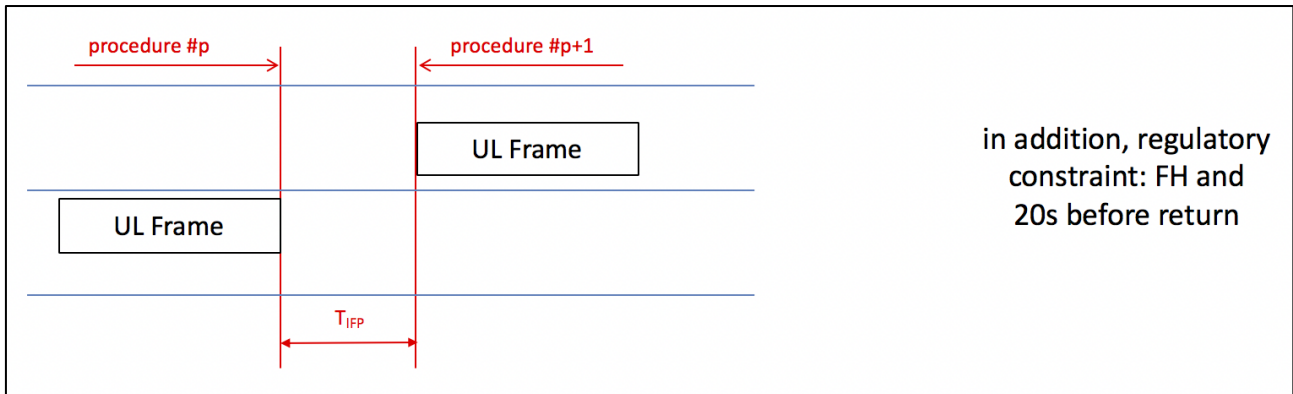

Figure 6-2 : U-procedure, single frame, FH

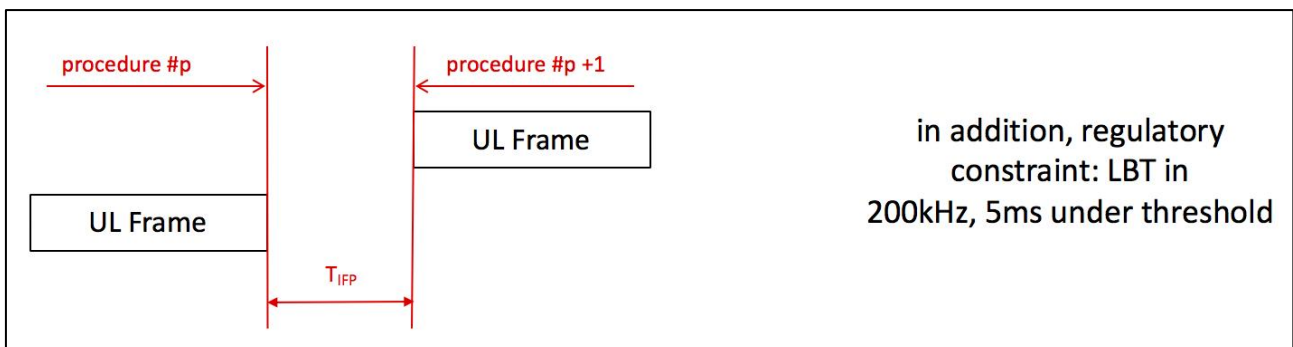

Figure 6-3 : U-procedure, single frame, LBT

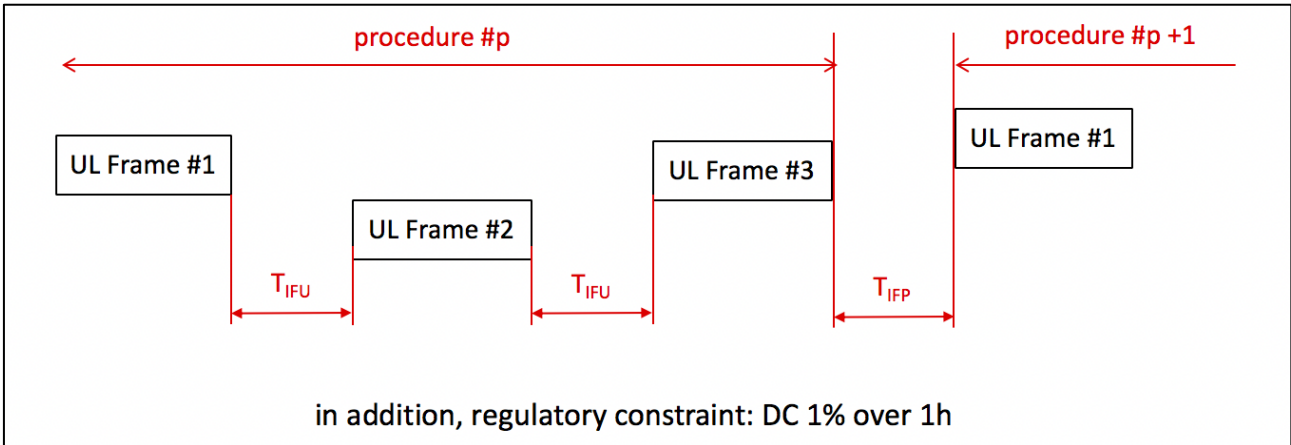

Figure 6-4 : U-procedure, multiple frames, DC

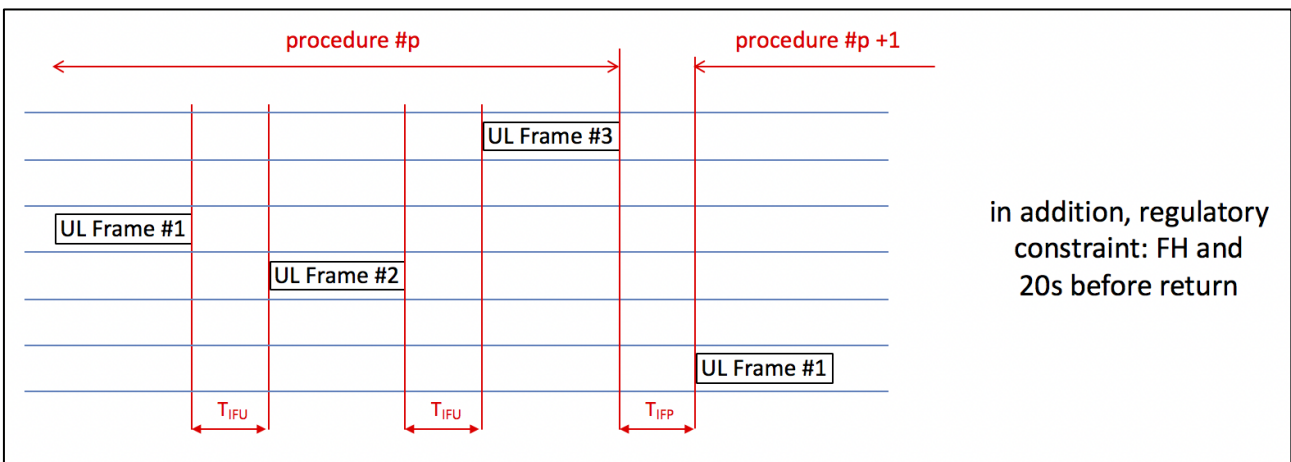

Figure 6-5 : U-procedure, multiple frames, FH

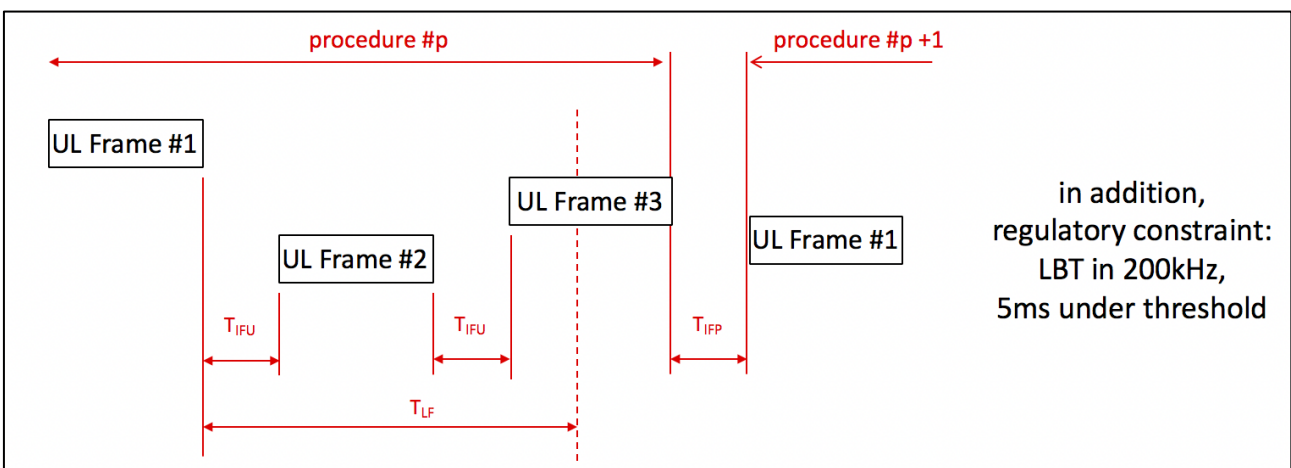

Figure 6-6 : U-procedure, multiple frames, LBT

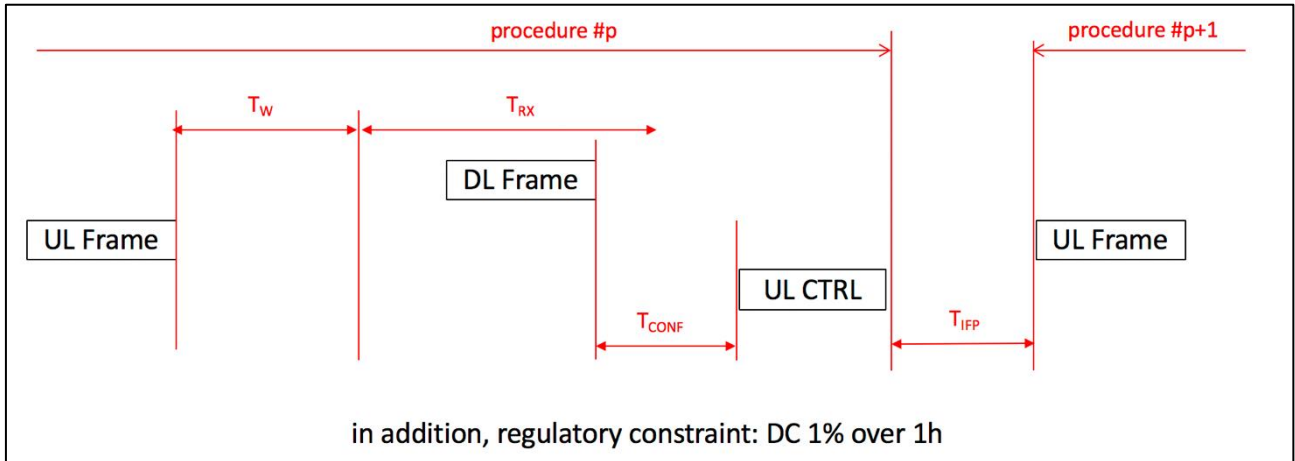

Figure 6-7 : B-procedure, single frame, DC

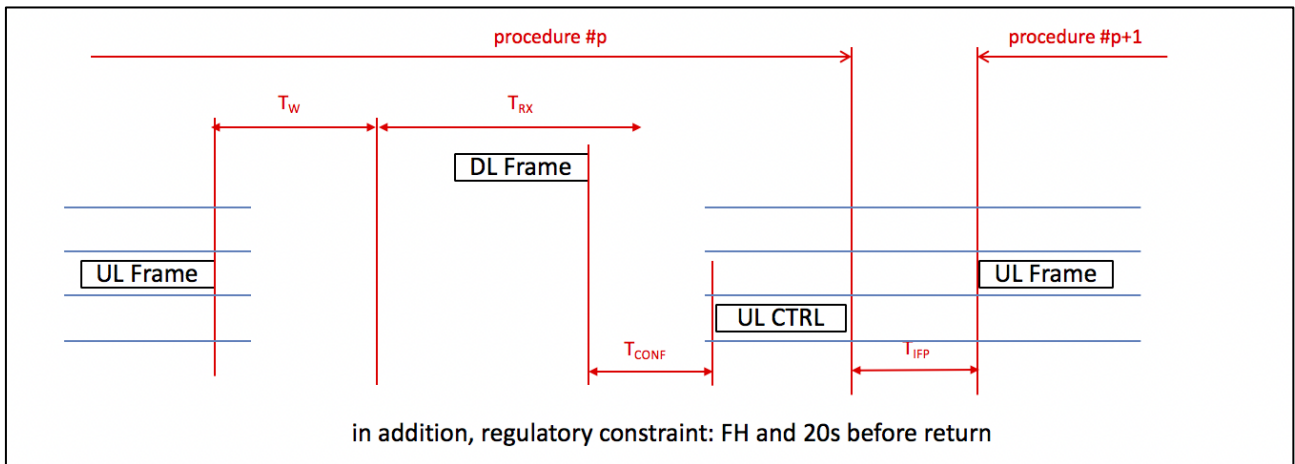

Figure 6-8 : B-procedure, single frame, FH

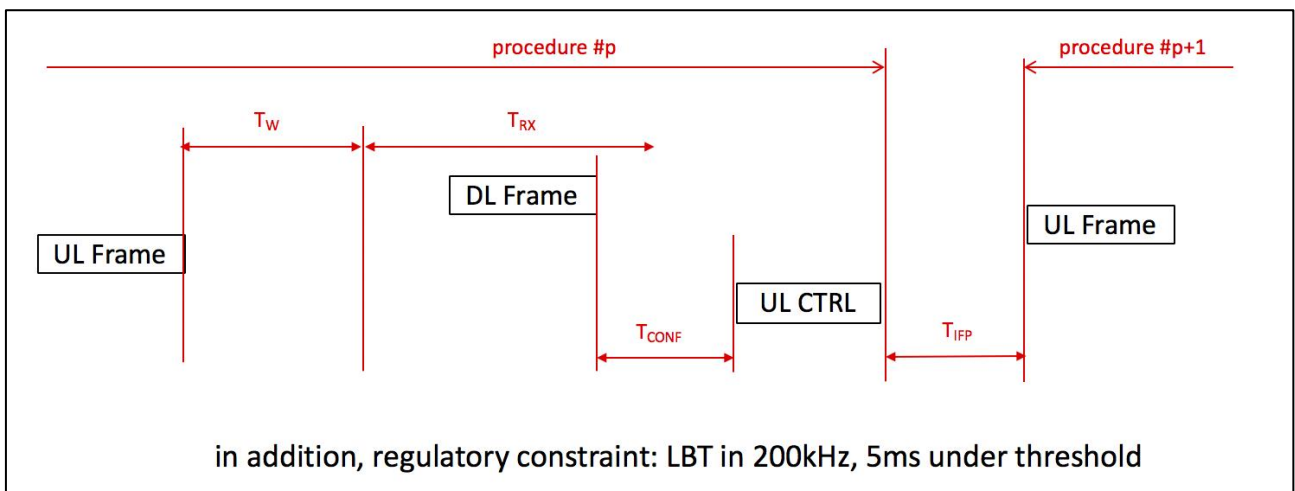

Figure 6-9 : B-procedure, single frame, LBT

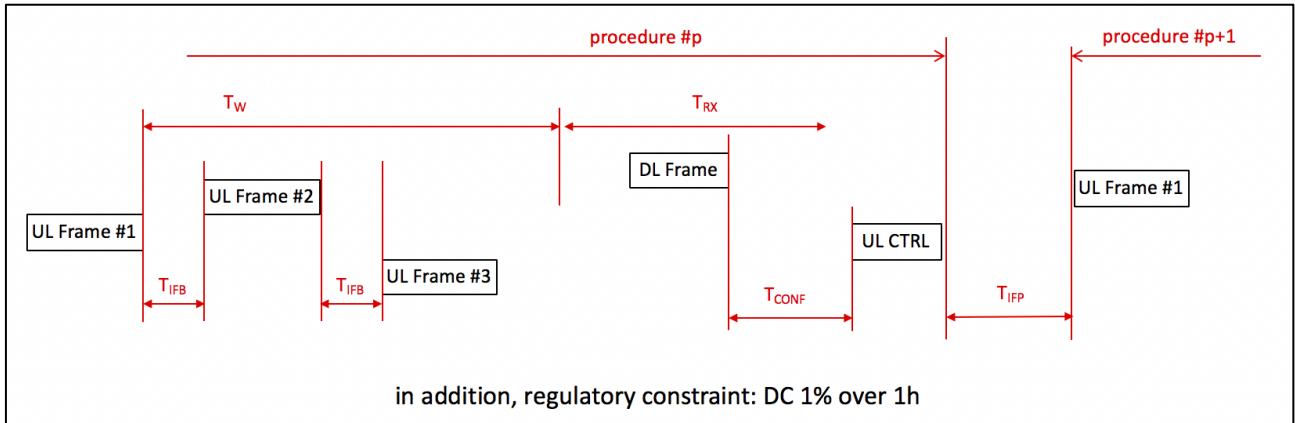

Figure 6-10 : B-procedure, multiple frames, DC

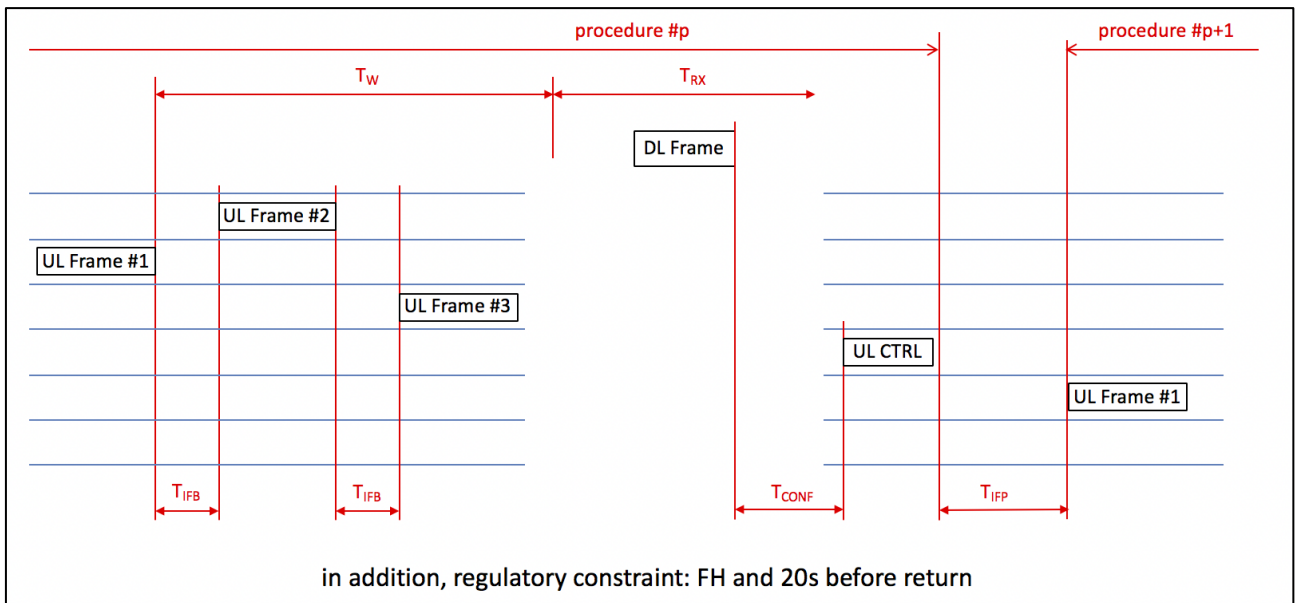

Figure 6-11 : B-procedure, multiple frames, FH

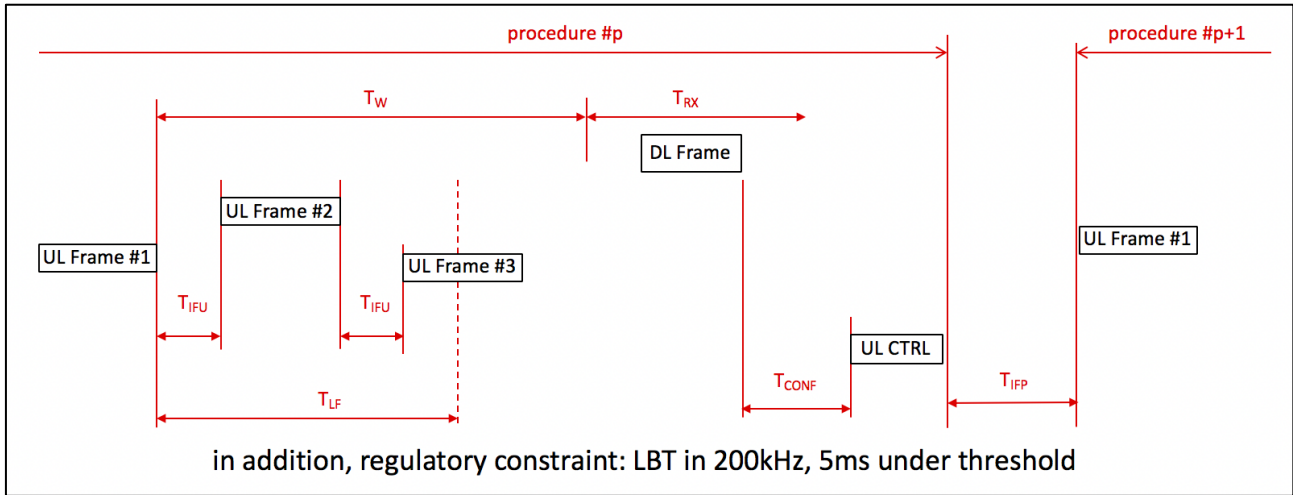

Figure 6-12 : B-procedure, multiple frames, LBT



7 ANNEX B (INFORMATIVE): MESSAGE TYPES, MESSAGE SIZES AND FRAME TYPE VALUES

Message type	UL Payload	LI value (binary)	UL-AUTH field size (bytes)	UL-Container size (bytes)	Frame length (bytes)	Frame rank	FT value (binary)	FT value (hexa)	Radio burst duration (@100baud)	Radio burst duration (@600baud)
Application Message	empty	00	2	8	14	first	0b0000001101011	0x006B	1,12s	187ms
	1 bit (=0)	10	2			second	0b0011011100000	0x06E0		
	1 bit (=1)	11	2			third	0b0000000110100	0x0034		
	1 byte	00	2	9	15	first	0b0000010001101	0x008D	1,20s	200ms
	2 bytes	10	4	12	18	second	0b0000011010010	0x00D2		
	3 bytes	01	3			third	0b0001100000010	0x0302		
	4 bytes	00	2			first	0b0001101011111	0x035F		
	5 bytes	11	5	16	22	second	0b0010110011000	0x0598	1,44s	240ms
	6 bytes	10	4			third	0b0010110100011	0x05A3		
	7 bytes	01	3			first	0b0011000010001	0x0611		
	8 bytes	00	2	20	26	second	0b0011010111111	0x06BF	1,76s	293ms
	9 bytes	11	5			third	0b0011100101100	0x072C		
10 bytes	10	4	first			0b0100101001100	0x094C			
11 bytes	01	3	20	26	second	0b0100101110001	0x0971	2,08s	347ms	
12 bytes	00	2			third	0b0100110010111	0x0997			
Control Message	5 bytes	11			5	16	22			first
	6 bytes	10	4	second	0b0111111001001			0x0FC9		
	7 bytes	01	3	third	0b1000110111110			0x11BE		
	8 bytes	00	2							

8 ANNEX C (INFORMATIVE): NUMERICAL EXAMPLES

8.1 UL frame construction

With reference to Figure 3-1, an example of application message construction in uplink is as follows:

UL-MESSAGE-CONTENT=0x 00 01 02 03 04 05 06 07
 LI=0b00, BF=0, REP=0, MC=0x 06 72
 End-point identifier=0x FE DC BA 98 → ID=0x 98 BA DC FE
 Ke=0x 01 23 45 67 89 AB CD EF 01 23 45 67 89 AB CD EF
 UL-AUTH=0x 96 EF
 UL-CRC=0x CD FB

UL Frame	UL FT	UL-PHY-CONTENT
#1	0x 06 11	06 72 98 BA DC FE 00 01 02 03 04 05 06 07 96 E7 CD FB
#2	0x 06 BF	04 D7 72 C9 05 BE 80 01 C3 82 47 06 C4 85 B8 2D D8 78
#3	0x 07 2C	07 EE 3E 94 6B C1 80 01 42 83 C5 04 47 86 73 5E 3E 85

UL Frame	Full bit stream before modulation (UL-Pr included)
#1	AA AA A6 11 06 72 98 BA DC FE 00 01 02 03 04 05 06 07 96 E7 CD FB
#2	AA AA A6 BF 04 D7 72 C9 05 BE 80 01 C3 82 47 06 C4 85 B8 2D D8 78
#3	AA AA A7 2C 07 EE 3E 94 6B C1 80 01 42 83 C5 04 47 86 73 5E 3E 85

8.2 DL frame construction

With reference to Figure 4-1, an example of application message construction in downlink is as follows:

UL-MESSAGE-CONTENT=0x 00 01 02 03 04 05 06 07
 LI=0b00, BF=1, REP=0, MC=0x 06 72
 End-point identifier=0xFEDCBA98 → ID=0x 98 BA DC FE
 Ke=0x 01 23 45 67 89 AB CD EF 01 23 45 67 89 AB CD EF
 UL-AUTH=0x F3 BA
 UL-CRC=0x F4 68

DL-MESSAGE-CONTENT=0x 30 31 32 33 34 35 36 37
 DL-AUTH=0x 85 2D
 DL-CRC=0x 02
 ECC=0x AB 83 9E A9
 Initialization value for PN9 of whitening function=0x 01 B0

DL Frame	DL FT	DL-PHY-CONTENT
/	0x 12 27	0x C6 05 30 38 C6 4B F9 2E 71 8A AC 45 06 3E 00

DL Frame	Full bit stream before modulation (DL-Pr included)
/	0x AA AA AA AA AA AA AA AA AA AA AA AA B2 27 C6 05 30 38 C6 4B F9 2E 71 8A AC 45 06 3E 00

With reference to Figure 5-2, the corresponding confirmation control message is as follows:

```
CT=0X 09
VDD-IDDL=0x E4 0C (+3 300mV)
VDD-Tx=0x CC 10 (+4 300mV)
TEMP=0x FA 00 (+25°C)
RSSI=0x E6 (-126dBm)
LI=0b00, BF=0, REP=0, MC=0x 06 73
UL-AUTH=0x BF 9D
UL-CRC=0x 81 0E
```

UL Frame	UL FT	UL-PHY-CONTENT
#1	0x 0F 67	06 73 98 BA DC FE 09 E4 0C CC 10 FA 00 E6 BF 9D 81 0E

UL Frame	Full bit stream before modulation (UL-Pr included)
#1	AA AA AF 67 06 73 98 BA DC FE 09 E4 0C CC 10 FA 00 E6 BF 9D 81 0E

8.3 Usable frequencies in RC1

With reference to Table 2-1, Table 8-1 and Figure 8-1 give a numerical example of a usable macro-channel for RC1 and corresponding available frequency range for uplink transmission, taking into account accuracy of EP frequency reference.

Table 8-1: Numerical example of usable frequencies in RC1

Parameter	Value (in kHz)	Comment
width of operating macro-channel	192	
ϵ_{SNW} : margin due to SNW reference frequency inaccuracy	1.406	1.62ppm of center frequency (i.e. 868.13MHz for RC1)
ϵ_{EP} : margin due to end-point reference frequency inaccuracy	17.363	20ppm of center frequency (i.e. 868.13MHz)
EP frequency range available for f_{UL} frequencies	154.462	

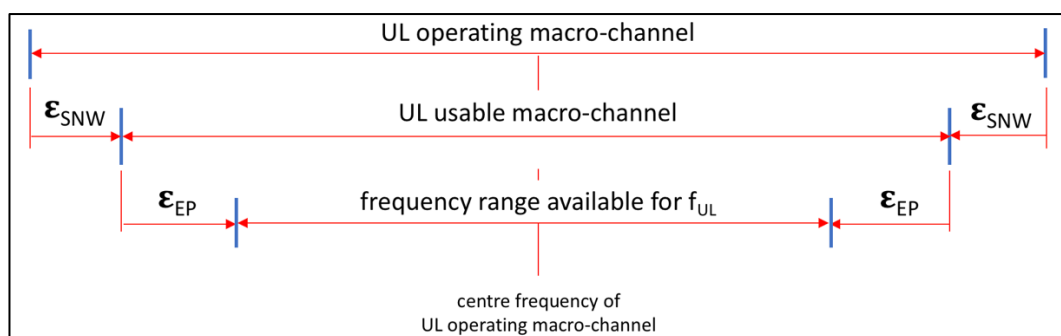

Figure 8-1: Numerical example for f_{UL} available range

9 ANNEX D (INFORMATIVE): MISCELLANEOUS

9.1 Definitions

B-procedure	bidirectional procedure at MAC/LINK level, triggered by an uplink message
container	datagram exchanged at MAC/LINK level in 3D-UNB
downlink	communication from the Sigfox network to an end-point
end-point	leaf node of a 3D-UNB system
frame	binary stream ready for modulation and transmission over the 3D-UNB radio interface
macro-channel	frequency interval within an unlicensed spectrum where end-point may communicate
payload	array of bits carried by 3D-UNB communication stack over a 3D-UNB radio interface
radio burst	radio transmission over the air which starts with a ramp up, finishes with a ramp down and which contains a stream of symbols carrying the modulated bits of a frame
symbol	steady state in amplitude, phase and frequency of a radio wave, carrying a piece of digital information
uplink	communication from an end-point to Sigfox network
U-procedure	uplink-only procedure at MAC/LINK level

9.2 Acronyms

3D-UNB	Triple Diversity UNB
AES	Advanced Encryption Standard
AUTH	Authentication
BER	Bit Error Rate
BF	Bi-directional Flag
CRC	Cyclic Redundancy Check
CT	Control Type
CTR	CounTeR (AES mode)
DC	Duty Cycle
DL	Downlink
ECC	Error Correction Code
EP	End-Point
EIRP	Equivalent Isotropic Radiated Power
ERP	Effective Radiated Power
FER	Frame Error Rate
FH	Frequency Hopping
FT	Frame Type
GFSK	Gaussian Frequency Shift Keying

ID	Identity
Ka	Authentication Key (used in authentication and integrity check procedures)
Ke	Encryption Key (used in payload encryption of applicative message)
LBT	Listen Before Talk
LDC	Low Duty Cycle
LI	Length Indicator
LSByte	Least Significant Byte
LSbit	Least Significant bit
MAC	Medium Access Control
MC	Message Count
MC _{max}	Message Count maximum value
MSbit	Most Significant bit
MSByte	Most Significant Byte
N.A.	Not Applicable
PHY	Physical
Pr	Preamble
RC	Radio Configuration
RoC	Rollover Counter
RSSI	Received Signal Strength Indicator
SNW	Sigfox NetWork
TEMP	Temperature
UL	Uplink
UNB	Ultra-Narrow Band
VDD	Positive Supply Voltage
XOR	eXclusive OR (logical operation "exclusive disjunction")

9.3 Symbols

Δf	fixed frequency shift for successive radio bursts sent in a B-procedure
Δf_{GAP}	frequency offset between uplink macro-channel and downlink macro-channel
f_{DL}	carrier center frequency of a DL radio burst
f_{UL}	carrier center frequency of a UL radio burst
m	generic value for message numbering
N	generic value for the number of UL frames transmitted at the beginning of a unidirectional or bidirectional procedure
p	generic value for MAC/LINK procedure numbering
T_{CONF}	delay between DL and confirmation message in a bidirectional procedure
T_{IFB}	time interval between uplink frames in a B-procedure
T_{IFP}	time interval between last UL frame of a procedure and the first UL frame of the next procedure
T_{IFU}	time interval between uplink frames in a U-procedure
T_{LF}	time interval in case of multiple frame procedure when LBT applies
T_{SUL}	duration of an uplink symbol
T_{SDL}	duration of a downlink symbol
T_{RX}	maximum duration of the receive window in a bidirectional procedure

T_w waiting time between UL and DL in a bidirectional procedure

9.4 Drawing and description conventions

In this document, sketches use drawing conventions of communication protocol description (see Figure 9-1), where:

- Fields to be transmitted are drawn from left to right,
- First field on the left is transmitted first,
- Last field on the right is transmitted last,
- Fields are always transmitted MSbit first.

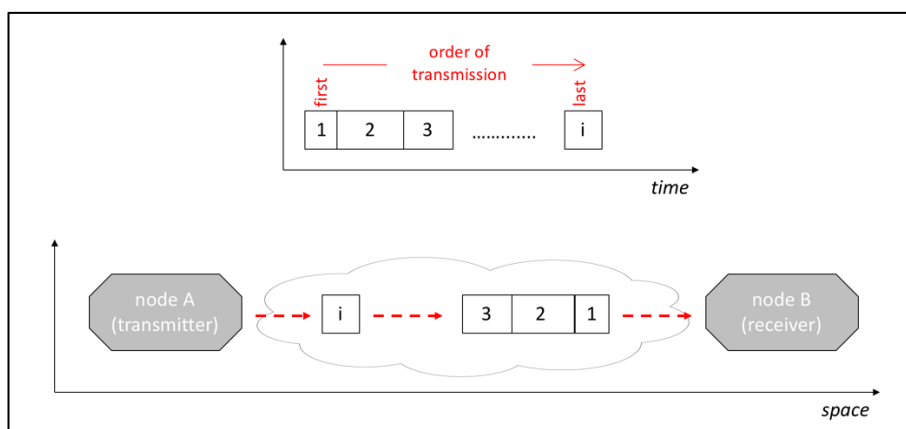

Figure 9-1 : Frame serialization over the air

9.5 Document history

Date	Radio interface revision	Description
February 2019	1.3	First public document
November 2019	1.4	Wording improvement in sections 2.2.1 (macro-channel definition) and 3.13.3 (frequency selection procedure). Updates in sections 2.4.4 (spectrum template), 2.5.4 (reference sensitivity measurement), 3.13.3 (frequency granularity relaxed), 5.1 & 5.2 (endianness clarified) and in Table 2-3 (symbol rate accuracy) Annex 8 added (numerical examples)
February 2020	1.5	Relax constraints on baud rate cumulated error in section 2.3, message counter numbering in section 3.6 and Tx spectrum template for class 2 and class 3 devices in section 2.4.4. Replace requirement on frequency granularity for each end-point with requirement on uniform spectral

	Sigfox connected objects Radio specifications	Ref.: EP-SPECS
		Rev.: 1.6
		Date: Mar.2022

		occupation of the whole device population, in section 3.13.3. Support of RC7 regional profile added. Signed integer representation added in section 5.1 and 5.2
March 2022	1.6	Clarify target end-point output power for device at Singapore in RC4 in Table 2-5. Clarify impact of Japanese regulation update on T_{LF} allowing use of Low Duty Cycle method access, in table 3-4 and 4-2. Clarification of whitening function in DL including in section 4.6

----- end of document -----

+33 (0)5 82 08 07 10
Bâtiment E-volution
425, rue Jean Rostand
31670 Labège – France
Sigfox.com

