

SIGFOX CERTIFICATION HANDBOOK

REV. V3.2.4

TABLE OF CONTENTS

1. Definitions and acronyms	4
2. Why Sigfox Certification?	7
3. What is Sigfox Certification?	7
4. Sigfox Ready™ certification	8
4.1 Fundamentals	8
4.2 Sigfox Ready™ approaches	9
4.2.1 Full approach	9
4.2.2 Modular approach	9
4.3 Sigfox Ready™ additional offers	11
4.3.1 Similarity offer	11
4.3.2 Derived offer	12
4.3.3 Upgrade offer	13
4.4 Summary of Sigfox Ready™ approaches and offers	14
5. Sigfox Verified™ certification	15
5.1 Why does Sigfox deliver this intermediate label?	16
5.2 What is a Sigfox Verified™ Modular Design?	16
5.3 Sigfox Verified™ Modular Design requirements	16
5.4 What is “Sigfox Verified™ Development Solution”?	19
5.5 Sigfox Verified™ Development solution requirements	19
5.6 Sigfox Verified™ Upgrade offer	20
6. Sigfox Certification process	22
6.1 Create product	22
6.2 Plan testing	23
6.3 Prepare device for testing	23
6.4 Execute tests against a valid CBL and generate report (by <i>Sigfox Accredited Test House</i>)	24
6.5 Prepare submission file	24

6.6	Submit for certification.....	25
6.7	Analysis of submission file and issuing of certificate (by Sigfox)	25
7.	Pre-certification testing	26
8.	Annex 1.....	27
8.1	CBL Definition	27
8.2	CBL Rules.....	28
9.	Annex 2.....	29
9.1	Sigfox Ready offers.....	29
9.2	Sigfox Verified offers	31

Changes description

Version	Description	Author	Date
V1.0	Initial version	Susana Barreiro Mouriz	19/09/2018
V1.1	Typo corrections	Susana Barreiro Mouriz	12/10/2018
V1.2	Removal of Minor library upgrade	Susana Barreiro Mouriz	20/11/2018
V1.3	Table 9: Addition of photos for similar offer and removal of datasheet antenna for Derived offer	Susana Barreiro Mouriz	28/01/2019
V2.0	Major changes about T&C and mechanism synchronization	Helene Ardiller	19/09/2019
V3.0	CBL Rules added	Helene Ardiller	19/11/2019
V3.1	Take into account Secure Element offer	Helene Ardiller	07/01/2020
V3.2.0	Final version before CBL June	Helene Ardiller	20/02/2020
V3.2.1	Addition of modular design only for class 2 or 3 mention	Susana Barreiro Mouriz	12/05/2020
V3.2.2	Clarifications on table 9	Susana Barreiro Mouriz	10/10/2020
V3.2.3	Radiated test for RC7 information	L Bordes	February 1, 2021
V3.3	Addition of annex 9	Susana Barreiro Mouriz	25/04/2023

1. DEFINITIONS AND ACRONYMS

CANDIDATE MODULAR DESIGN/DEVICE/DEVELOPMENT SOLUTION

A unit of a *Modular Design/Device/Development Solution* model sent for certification testing against a valid CBL. Can be a prototype but shall be representative to series.

DERIVED DEVICE:

is a variant of an existing Sigfox Ready™ *Device* that has been modified to support another radio configuration.

DEVELOPMENT SOLUTION:

Engineering board, technology evaluation board or prototyping tool that is not used to operate on Sigfox network for commercial service delivery. It can be a development kit, breakout, shield board, expansion/extension board...

DEVICE:

A manufactured end-product that is intended for use by end-user customers on the Sigfox network.

MAJOR CHANGE:

any change that could have an impact on the *Sigfox Certification Specifications* or on associated tests (*Sigfox RF & protocol* or *Sigfox radiated performance*). The change must be tested against a valid CBL to assess the actual impact and the need for certification re-submission (upgrade offer). If in doubt, *Partner* can contact support.sigfox.com to assess the need for re-certification.

MINOR CHANGE:

a change that has no impact on any *Sigfox Certification Specifications* nor on associated tests (*Sigfox RF & protocol* and *Sigfox radiated performance*). If in doubt, *Partner* can contact support.sigfox.com to assess the need for re-certification.

MODULAR DESIGN:

is defined as a HW/SW design which must:

- *be integrated into a device to operate on Sigfox network (ex: Development Solutions)*
- *address Sigfox Verified™ modular design requirements*

MODULE:

Ready to use component to be soldered to a printed circuit board.

PARTNER:

The person/company developing a Sigfox product which can be either a *Modular Design*, *Device*, or *Development Solution*, intended to go through the Sigfox certification process.



PRODUCT:

Term used in this document and build.sigfox.com covering Devices and modular designs.

PRODUCT MODEL:

Commercial reference of the device or modular design.

REFERENCE DESIGN:

Collection of schematics, Bill of Material including components values and tolerances, PCB layout, PCB stack-up that defines its HW/SW design.

RSA:

Radio Signal Analyzer (also called "RSA") is a user-friendly software to analyze Sigfox signals. RF equipment catch Sigfox signal and *RSA* analyses and compares the results (I/Q) with the Sigfox RF & Protocol requirements.

SECURE ELEMENT:

External chip for secure frame building and sensitive data storing. In Sigfox case it is used to store Sigfox credentials.

SIGFOX ACCREDITED TEST HOUSE:

is a test house accredited by Sigfox to execute *Sigfox RF & protocol tests* and/or *Sigfox radiated performance tests against valid CBL*.

SIGFOX CERTIFICATION SPECIFICATIONS:

term used in this document and build.sigfox.com covering *Sigfox RF & protocol specifications* and *Sigfox Radiated performance specifications*.

SIGFOX PROTOCOL LIBRARY:

SW Binary file for management of the protocol part of the Sigfox communication

SIGFOX RADIATED PERFORMANCE SPECIFICATIONS:

are the documents containing radiated performance requirements for Sigfox certification.

SIGFOX RADIATED PERFORMANCE TESTS:

are the set of radiated performance tests against a valid CBL required for Sigfox certification

SIGFOX READY™ CERTIFICATION:

is the certification required for each *Device* that is intended to operate on the Sigfox network.

SIGFOX RF & PROTOCOL SPECIFICATIONS:

are the documents containing RF & protocol requirements for Sigfox certification.



SIGFOX RF & PROTOCOL TESTS:

is the set of RF & protocol tests against a valid CBL required for Sigfox certification.

SIGFOX VERIFIED™ CERTIFICATION:

is the intermediate certification granted only to modular designs in order to be used for the modular approach of the Sigfox Ready™ certification.

SIGFOX VERIFIED™ MODULAR DESIGN:

is a *Modular design* that has obtained the Sigfox Verified certificate.

SIGFOX VERIFIED™ DEVELOPMENT SOLUTION:

is an intermediate label that allows the registration of a *Development Solution* which is not based on a *Sigfox Verified™ Modular Design* on the Sigfox network.

SIMILAR DEVICE:

is a variant of an existing Sigfox Ready™ *Device* using a different sensor type or application.

UPGRADED DEVICE:

is an upgraded version of a Sigfox Ready™ *Device*

Acronyms

BOM	Bill of material
CBL	Certification Base Line
FW	Firmware
HW	Hardware
Modem	Modulator/demodulator
PCB	Printed Circuit Board
RC	Sigfox Radio Configuration
RF	Radio Frequency
SW	Software
SE	Secure Element

2. WHY SIGFOX CERTIFICATION?

Certifications are a major step in every project. They allow the validation of product compliance with the required standards, whether regulatory or Sigfox-specific.

Sigfox requires Sigfox certification for devices intending to communicate on the Sigfox Network to ensure interoperability and service delivery at nominal performance level.

Upon Sigfox certification process completion, a Sigfox certificate is granted to the *Partner* for their *Device*, which will be required to register any device of the same model on the Sigfox network.

3. WHAT IS SIGFOX CERTIFICATION?

Sigfox Certification is the acknowledgement of the compliance of a *Device* with *Sigfox Certification Specifications* in order to ensure its compatibility with Sigfox services and nominal performance on the network. It implies the commitment of the *Partner* to do everything necessary to ensure that all their devices registered on the Sigfox network are compliant with the *Sigfox Certification Specifications*, in all the operational conditions of the *Device* and during its complete life cycle.

Partner will accompany this commitment with evidence of compliance generated on a *Candidate Device* which is representative of all devices of the same model deployed on the network. This evidence is declarative information and test results generated by *Sigfox Accredited test houses*; and will be provided to Sigfox during the certification submission process (filing).

There are 2 types of tests required as evidence:

- ***Sigfox RF & protocol tests***, to check Sigfox protocol & RF performance compliance.
- ***Sigfox radiated performance tests*** to assess the radiated performances of the *Device*.

These radiation tests will define a radiated power classification of the *Device* in uplink mode.

All tests must be performed against a valid CBL. Check Annex 8.1 for more information.

Following *Partner's* commitment and compliance evidence, Sigfox delivers a *Sigfox Ready™ certificate* to the *Partner* for a given *Device* model.

Note: As certification tests are gathered on a single *Candidate Device* and not in all its possible operational conditions, *Partner* shall put in place all necessary means in the design, validation, manufacturing and maintenance phases to ensure that each unit of the device model will be compliant with *Sigfox Certification Specifications*.

All material concerning Sigfox certification (Specifications, process, list of *Sigfox Accredited test houses*, etc....) are available in the Certification' section on build.sigfox.com.

4. SIGFOX READY™ CERTIFICATION

4.1 Fundamentals

Sigfox Ready™ certification is mandatory for any *Device* to be connected to the Sigfox network except for *Development Solutions*.

A *Device* candidate for *Sigfox Ready™ certification* must comply to all *Sigfox Certification Specifications (Sigfox RF & protocol and Sigfox radiated performance)*.

To achieve Sigfox Certification, *Partner* has to apply through build.sigfox.com providing following the documentation and evidence:

- *Sigfox RF & protocol tests* evidence (demonstrating compliance to a valid CBL)
- *Sigfox radiated performance tests* evidence
- Other required documentation & information which may include:
 - Internal and external photos
 - datasheets
 - BOM, Schematics and PCB layouts
 - etc....

Detailed required documents & information are described on build.sigfox.com and depend on the kind of certification and approach chosen.

Partner must confirm that the declarative requirements below mentioned are implemented:

- "Time and frequency randomness on the physical layer (RAN) are an inherent characteristic of the Sigfox technology. Partner declares that no time synchronization mechanisms have been implemented on the device"
- "Pseudo-random frequency series for UL transmissions is unique for each device"

The outcome of *Sigfox Ready™ certification* are:

- A certificate allowing Partner to register their *Devices* onto the Sigfox network.
- Access to the Sigfox Partner Network for Partner to advertise their company and products.
- The rights for Partner to use the Sigfox Ready™ logo for their packaging & communication

4.2 Sigfox Ready™ approaches

There are 2 ways to achieve a *Sigfox Ready™ certification* for a *Device*:

- Full approach
- Modular approach

4.2.1 Full approach

In the full approach, all certification tests (*Sigfox RF & protocol tests* and *Sigfox radiated performance tests*) are performed against a valid CBL on the *Candidate Device* that is in its final state, i.e. representative of mass production.

During certification submission, *Partner* provides test reports for both kinds of tests, generated on the *Candidate Device*, all information and documents requested in build.sigfox.com

Additional requirements are applicable when a *Sigfox Verified Modular design* is not used:

#	Type	Requirement	Comment
1	Declarative	<p><i>Partner</i> shall read and consider the Security Guidelines (Sigfox-Best_Current_Practices_v1.0.pdf) that can be found on build.sigfox.com during its design phase, including protection of <i>Device's</i> private ID and private KEY:</p> <ul style="list-style-type: none"> • <i>Device</i> private ID shall be stored in a non-volatile manner and shall not be modifiable. • <i>Device</i> private KEY shall be stored in a non-volatile manner and shall not be modifiable nor accessible/readable externally to the <i>Device</i>. 	<p><i>This shall be applied on candidate product and on the commercial product.</i></p>

Table 1: Additional requirements on full approach if a *Sigfox Verified™ modular design* is not used

4.2.2 Modular approach

Sigfox proposes a modular approach allowing the *Partner* to inherit *Sigfox RF & protocol tests* evidence from a *Sigfox Verified™ Modular Design*.

To do so, the *Partner* should integrate a *Sigfox Verified™ Modular Design* in their device by respecting the conditions, limitations and procedures defined by the *Sigfox Verified™ Modular Design* provider.

There are 2 types of modular approach:

- Modular approach based on a Reference Design
- Modular approach based on an existing module

In this approach, *Partner* only needs to perform *Sigfox radiated performance tests* against valid CBL on the *Candidate Device*. They will accompany their certification submission with the following:

- Performance Radiated test report
- Sigfox Verified™ certificate of the *Modular Design* integrated in the *Device*
- Documents to provide evidence the conditions, limitations and procedures defined by the *Sigfox Verified™ Modular Design* provider have been respected.

	RF & Protocol testing	Radiated performance testing
Full approach	Tested on the <i>Device</i>	Tested on the <i>Device</i>
Modular approach	Evidence inherited from <i>Sigfox Verified™ Modular Design</i>	Tested on the <i>Device</i>

Table 3: Sigfox Ready™ approaches summary

Note: From June 2020, a modular design can also be certified to be used only on Class 2 and Class 3 devices.

Device makers must select modular design adapted to their needs. The information will appear in the certificate.

Note from February 2021: **Only one radiated test report is necessary, if you apply for RC1 and RC7.**

4.3 Sigfox Ready™ additional offers

To ease the creation of existing *Device* variants or series, three additional adapted offers are available to *Partner*:

- Similarity offer
- Derived offer
- Upgrade offer

4.3.1 Similarity offer

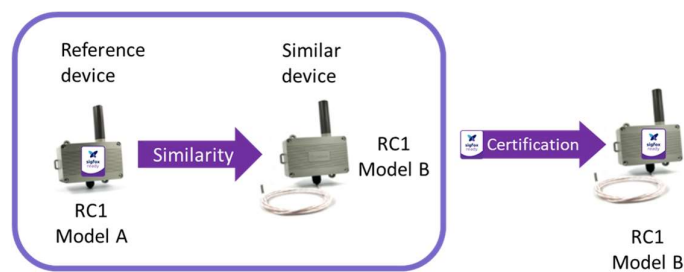

Picture 1: Similarity offer

This offer is typically applicable for a series of products. It applies to a *Device* based on a Sigfox Ready™ *Device* (namely the reference device) to which changes that do not affect the RF communication part of the device (RF schematics, RF layout, RF Firmware, device power supply, antenna, mechanical housing...) have been applied.

In short, the change applied allows for the creation of a variant of a *Device* with a different sensor type. Model name must be different between *Similar Device* and reference *Device*.

There is no need to perform Sigfox radiated performance tests on the Similar Device at the Sigfox Accredited test house. The *Partner* only needs to submit the device similarity checklist document available in build.sigfox.com and submit the *Similar Device* documentation for analysis by Sigfox.

Sigfox will assess whether the Similarity offer is applicable and acknowledge submission. If positive, a new product certificate is issued for the *Similar Device*.

Summary of allowed changes for similarity offer:

Change from the reference device	Applicability for <u>similar offer</u>
Model name	Mandatorily different from reference device
Sensor	Can change from reference device
RC	Cannot change from reference device
Antenna	Cannot change from reference device
Casing and Power supply	Cannot change from reference device
PCB layout or stack	Cannot change from reference device
Sigfox Verified™ modular design	Cannot change from reference device

Table 4: Similar device requirement table

4.3.2 Derived offer

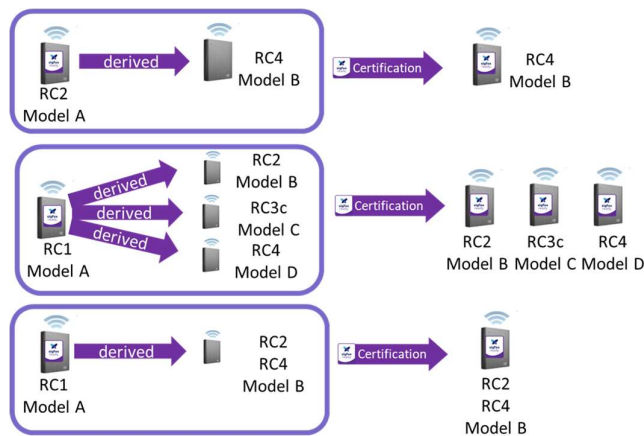

Picture 2: Derived offer

This case applies to an existing Sigfox Ready™ *Device* declined into another or several other RCs.

The derived *Device* has same commercial name and follows the same use-case.

A design change in the RF communication part is authorized as long as it complies with *Sigfox RF & protocol specifications* through a full approach or modular approach. Antenna change is also accepted but casing, battery and sensor changes are not acceptable.

A derived device is to be tested against a valid CBL by a *Sigfox Accredited test house* for the relevant RC.

Sigfox will assess whether the derived offer is applicable and acknowledge submission. If positive, a new product certificate is issued for the *Derived Device*.

Summary of allowed changes for derived offer:

Change from the reference device	Applicability for <u>derived offer</u>
Model name	Mandatorily different from reference device
Sensor	Cannot change from reference device
RC	Mandatorily different from reference device
Antenna	Can change from reference device
Casing and Power supply	Cannot change from reference device
PCB layout or stack	Can change from reference device
Sigfox Verified™ modular design	Can change from reference device

Table 5: Derived device requirement table

A device can be derived from a Sigfox Ready™ Device that was certified with modular approach or full approach.

4.3.3 Upgrade offer

Example here is the antenna upgrade

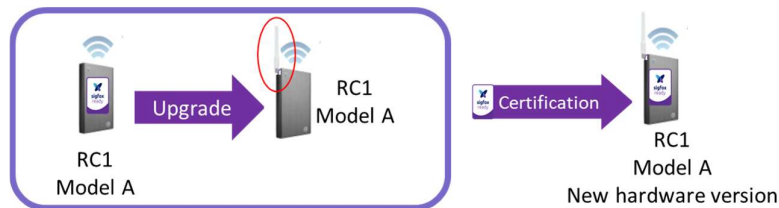

Example here is the casing upgrade

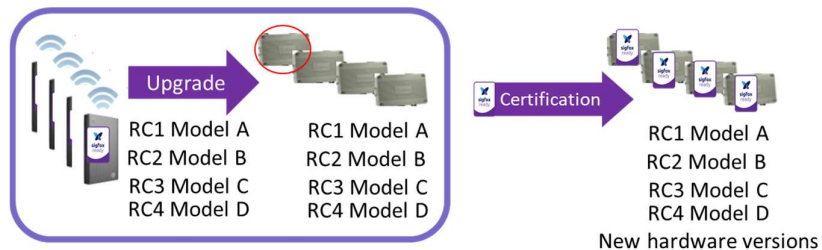

Picture 3: Upgrade offer

An *Upgraded Device* is a new version of an existing Sigfox Ready™ Device and for this reason the model name must be the same. It is applicable to a Device that is Sigfox Ready™ certified but where *Major Changes* have been applied while keeping the same model name (reference). Typically, a product evolution due to product improvement, obsolescence management, etc....

There are 2 types of upgrade:

Upgrade type	Description	What to test	Who tests?	Re-certification is needed?
Upgrade	Major Changes	Depends on the change	a <i>Sigfox Accredited test house</i>	YES
Library upgrade	The only change is a <i>Sigfox protocol library</i> upgrade	RF & protocol tests	a <i>Sigfox Accredited test house</i>	YES

Table 6: Summary of upgrade types for a Sigfox Ready™ device

Sigfox will assess eligibility of the upgrade offer and acknowledge the Partner’s request during submission. If positive, the same certificate is kept but updated. Sigfox Ready certificate is issued for the upgraded *Device*.

4.4 Summary of Sigfox Ready™ approaches and offers

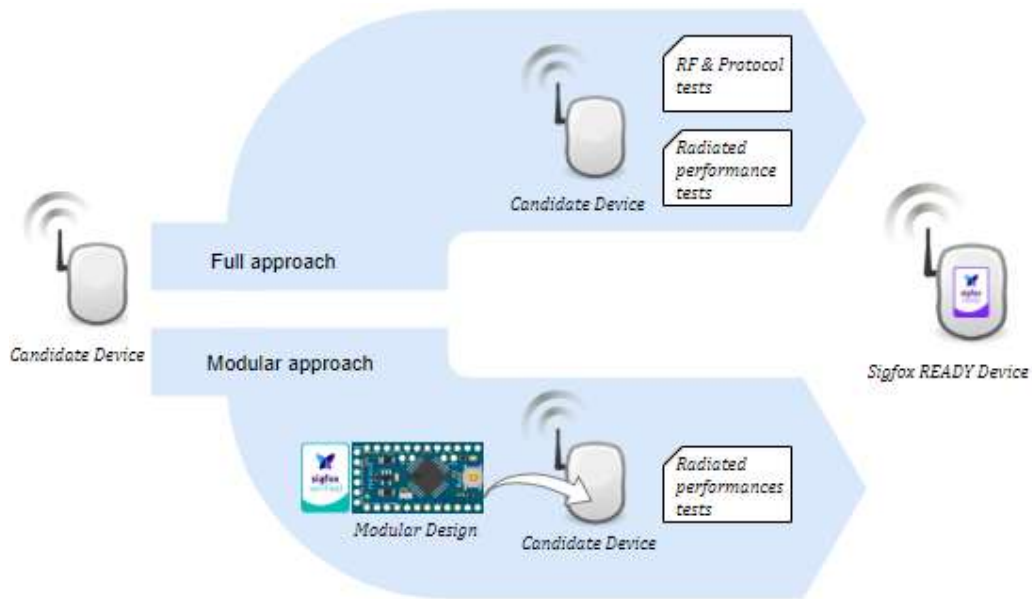

Picture 4: summary of Sigfox Ready certification approaches

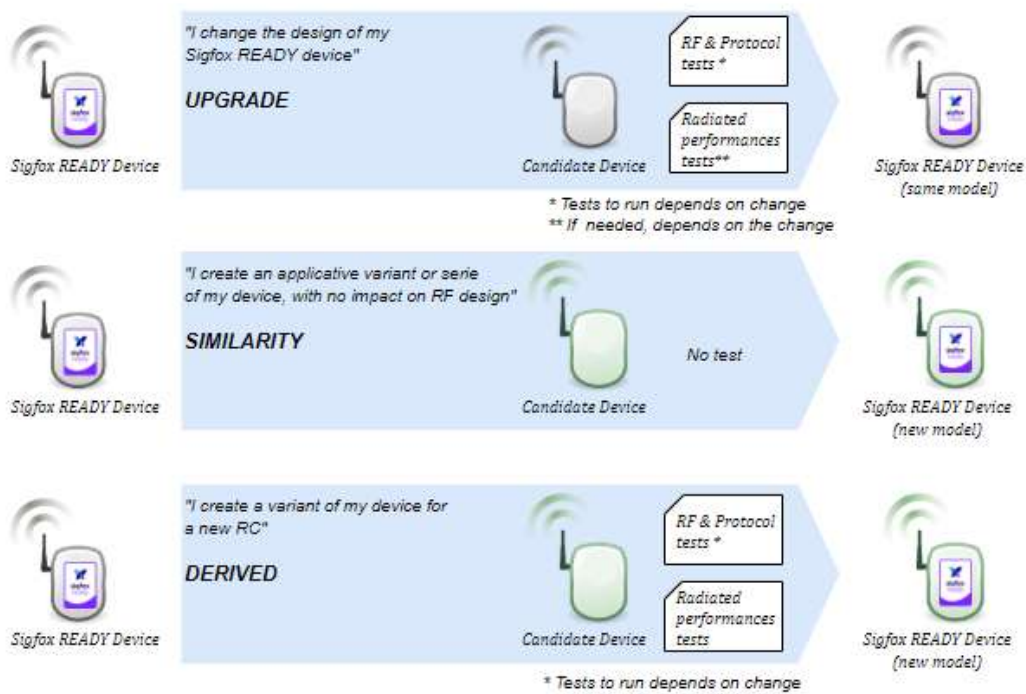

Picture 5: Summary of Sigfox Ready certification additional offers

5. SIGFOX VERIFIED™ CERTIFICATION

Sigfox delivers *Sigfox Verified™ certificate* to acknowledge compliance to *Sigfox RF & protocol specifications* of a *Modular Design and Development solutions*.

This intermediate label is provided to designs that are not intended to connect directly to Sigfox network, i.e. *Modular Designs* (that can be *Modules* or *Reference Designs*).

With the exception of *Development Solutions*, this certificate does not allow the registration on the Sigfox network.

A *Sigfox Verified™ Modular Design* enables the *Partner* designing a *Device* to apply the modular approach of the *Sigfox Ready™ certification*, as described in 5.3.

5.1 Why does Sigfox deliver this intermediate label?

Sigfox delivers this intermediate label to help to foster the *Device* development journey by:

- Acknowledging compliance of *Modular Designs* with *Sigfox Certification Specifications* - which guarantees interoperability on the Sigfox Network for device makers using these solutions and speeds-up their RF design phase
- Allowing *Candidate Devices* to inherit *Sigfox RF & protocol tests* evidence from the *Sigfox Verified™ Modular Design* – which speeds-up the certification process as only *Sigfox radiated performance tests* against a valid CBL are needed at end-device level in this case
- Allowing Sigfox Verified™ *Development solutions* to connect to the Sigfox network – for early testing and technology evaluation by the Sigfox ecosystem

5.2 What is a Sigfox Verified™ Modular Design?

Sigfox Verified™ Modular Design is defined as a HW/SW design which must:

- be integrated into a device to operate on the Sigfox network
- address *Sigfox Verified™ Modular Design* requirements as described in chapter 5.3
- have obtained the Sigfox Verified™ certificate

5.3 Sigfox Verified™ Modular Design requirements

#	Type	Requirement	Comment
1	Functional	100% compliant to <i>Sigfox RF & protocol specifications</i> in its complete operation range	Test Report must be done by a <i>Sigfox Accredited test house</i> against a valid CBL
2	Declarative	The HW definition shall be defined and fixed (i.e. no HW configurability). The version of this HW shall be provided	
3	Declarative	The FW version of the complete design, or at least the version of the sub-FW managing Sigfox modulation/demodulation part are to be provided	<i>Some Modular Designs only ensure Sigfox modem function and are controlled by a third-party MCU. The complete FW version is then required here.</i> <i>Some Modular Designs can embed "client" applicative code. In that case, Modular Design manufacturer shall demonstrate independence between the code managing Sigfox</i>

			<i>modulation/demodulation and the "client" applicative code.</i>
4	Declarative	<p><i>Partner</i> shall read and take into account the Security Guidelines (Sigfox-Best_Current_Practices_v1.0.pdf) that can be found on build.sigfox.com during the design phase, including protection of <i>Device's</i> private ID and private KEY.</p> <ul style="list-style-type: none"> • <i>Device</i> private ID shall be stored in a non-volatile manner and shall not be modifiable. • <i>Device</i> private KEY shall be stored in a non-volatile manner and shall not be modifiable nor accessible/readable externally to the <i>Device</i>. 	<i>This shall be applied on candidate product but also on the commercial product.</i>
5	Document	<p>The HW definition file shall be provided on the certification package., including:</p> <ul style="list-style-type: none"> • Schematics • BOM • PCB layout 	
6	Document	<p>The Modular Design datasheet shall be provided on the certification package.</p>	<i>Draft is allowed. It should include definitive operational conditions (power supply range, RF output power range, temperature conditions, etc.)</i>
7	Document	<p>The Modular Design commercial user manual shall be provided on the certification package., including:</p> <ul style="list-style-type: none"> • Integration constraints for the device maker in order to ensure <i>Sigfox RF & protocol specifications</i> compliance (conditions, limitations and procedures) • Procedures to control the Modular Design in order to operate Sigfox modulation/demodulation • Procedures to control the Modular Design in order to operate Sigfox test functions (add-ons activation, addons control...) configuration functions and all other functional requirements listed in this chapter. 	<i>Draft is allowed.</i>
8	Document	<p>The RF oscillator datasheet shall be provided with the certification package.</p> <p>This datasheet must include</p> <ul style="list-style-type: none"> • Ageing value (for 5 years) • Temperature tolerance (with the temperature range) 	Used to check the global RF frequency accuracy of the device.
9	Functional	<p>The 'RF & protocol SW addon' shall be implemented in the Modular Design in order to allow Sigfox RF & Protocol test execution on the device using this Modular Design.</p>	<i>'RF & protocol SW addon' is provided with the Sigfox Library among other addons.</i>
10	Functional	<p>An interface to activate all SIGFOX ADDONS Library test modes, Sigfox Message and other command (Public Key, config Words, etc.) mentioned in the Sigfox Test Procedures shall be provided.</p> <p>To be documented in the commercial user manual.</p>	<i>This can be done through AT commands or any command (give all commands), Built-in tests (hardcoded functions), GPIOs, ...</i>

11	Functional	If applicable, a way to calibrate the RF frequency offset of the Modular Design shall be provided (this offset should be applied to Uplink and Downlink Frequency). To be documented in the commercial user manual.	<i>F frequency calibration is not applicable if frequency accuracy is achieved by design in all operational conditions (e.g.: with a TCXO).</i> <i>This will be mainly used at the manufacturing phase by the device maker using the solution.</i>
12	Functional	If applicable, a way to calibrate the RX RSSI estimation of the Modular Design shall be provided. To be documented in the commercial user manual.	<i>Applicable if the Modular Design targets RCs that operates with LBT (listen before talk) and/or downlink feature</i>
13	Functional	If applicable, a way to set the LBT (listen before talk) threshold (i.e. the minimum RX RSSI from which device is allowed to transmit) shall be provided. To be documented in the commercial user manual.	<i>Applicable if the Modular Design targets RCs that operates with LBT (listen before talk) and/or downlink feature</i>
14	Functional	If applicable, a way to know (print, GPIO or else...) that a downlink frame is received successfully with its corresponding RSSI level, through the RX-GFSK test mode shall be provided. During Sigfox RF & protocol test, candidate product shall report (UART or else) the status of Sigfox frame reception (FAILED or PASSED) and RSSI level of each downlink frame received. To be documented in the commercial user manual.	<i>Applicable for devices supporting DOWNLINK feature.</i> <i>Example: During the Test Mode RX-GFSK : the RSSI value will be returned in the terminal with "TEST-PASSED" if the frame has been received properly.</i>
15	Functional	A way to generate a continuous unmodulated signal (CW) at a specified frequency shall be provided. To be documented in the commercial user manual.	<i>Example: AT\$CW=902200000,1</i> <i>Required for Device Maker for test purpose at Device level</i>
16	Functional	A way to generate a continuous Sigfox modulated (CM) signal at a specified frequency shall be provided. To be documented in the commercial user manual.	<i>Example: AT\$CM=902200000,1</i> <i>Required for Device Maker for test purpose at Device level</i>
17	Functional	A way to get the ID and initial PAC shall be provided. This command is mandatory to allow End Product Maker / User to register device on the network. PAC is the Porting Authorization Code. <ul style="list-style-type: none"> • ID = Unique ID (4 bytes length) • PAC = Initial PAC used for Device registering on SIGFOX network (8 bytes length): mandatory to give to customer for registering To be documented in the commercial user manual.	<i>This feature shall be available in candidate product but also on all units of the commercial product in order to allow end customer registering its device on Sigfox network.</i> <i>Example: AT\$ID? and AT\$PAC?</i>
18	Declarative	Time and frequency randomness on the physical layer (RAN) are an inherent characteristic of the Sigfox technology. Partner declares that <ul style="list-style-type: none"> • no time synchronization and/or frequency calibration mechanisms have been implemented on the device • pseudo-random frequency series for UL transmissions is unique for each device 	

Table 7: Sigfox Verified™ modular design requirements

Sigfox will assess the eligibility of a candidate *Modular Design* and acknowledge the *Partner's request* during submission process.

For more information on *Modular Design* eligibility, contact support.sigfox.com.

5.4 What is “Sigfox Verified™ Development Solution”?

Sigfox Verified™ Development Solution is an intermediate label that allows the registration of a *Development Solution* which is NOT based on a *Sigfox Verified™ Modular Design* on the Sigfox network.

To add Sigfox connectivity into *Development solution*, *partner* will not need to apply for Sigfox certification assuming the solution is based on a *Sigfox Verified™ modular design*.

Any *Development Solution* that is NOT based on a *Sigfox Verified™ Modular Design* must apply for *Sigfox Verified™ certification*.

5.5 Sigfox Verified™ Development solution requirements

#	Type	Requirement	Comment
1	Functional	100% compliant to <i>Sigfox RF & protocol specifications</i> in its complete operational range	Test Report must be done by a <i>Sigfox Accredited test house</i> against a valid CBL
2	Declarative	HW definition shall be defined and fixed (i.e. no HW configurability). The version of this HW shall be provided	
3	Declarative	The FW version of the complete design, or at least the version of the sub-FW managing Sigfox modulation/demodulation part shall be provided	
4	Declarative	<i>Partners</i> shall read and take into account the Security Guidelines (Sigfox-Best_Current_Practices_v1.0.pdf) that can be found on build.sigfox.com during its design phase, including the protection of <i>Device's</i> private ID and private KEY. <ul style="list-style-type: none"> • <i>Device</i> private ID shall be stored in a non-volatile manner and shall not be modifiable. • <i>Device</i> private KEY shall be stored in a non-volatile manner and shall not be modifiable nor accessible/readable externally to the <i>Device</i>. 	<i>This shall be applied on candidate product as well as on the commercial product.</i>
5	Document	The HW definition file shall be provided on the certification package., including:	

		<ul style="list-style-type: none"> • Schematics • BOM • PCB layout 	
6	Document	The product datasheet shall be provided on the certification package.	<i>Draft is allowed. It should include definitive operational conditions (power supply range, RF output power range, temperature conditions, etc.)</i>
7	Document	The Development solution commercial user manual shall be provided on the certification package.	<i>Draft is allowed.</i>
8	Document	<p>The RF oscillator datasheet shall be provided with the certification package.</p> <p>This datasheet must include</p> <ul style="list-style-type: none"> • Ageing value (for 5 years) • Temperature tolerance (with the temperature range) 	It is used to check the global RF frequency accuracy of the device.
9	Declarative	<p>Time and frequency randomness on the physical layer (RAN) are an inherent characteristic of the Sigfox technology. Partner declares that</p> <ul style="list-style-type: none"> • no time synchronization and/or frequency calibration mechanisms have been implemented on the device • pseudo-random frequency series for UL transmissions is unique for each device 	

Table 8: Sigfox Verified™ Development solution requirements

Sigfox will assess the eligibility of a candidate *Development solution* and acknowledge the *Partner's request* during the submission process.

5.6 Sigfox Verified™ Upgrade offer

An upgraded *Modular design* is a new version of an existing *Sigfox Verified™ Modular Design* and is why the model name must be the same and the measured conducted output power must remain the same (+2dB). It is applicable to a *Modular design* that is already Sigfox Verified™ certified but where *Major Changes* have been applied while keeping the same model name (reference). Typically, a product evolution due to product improvement, obsolescence management, etc.

Major Change can include change HW change, PCB layout, PCB stack-up, *Sigfox protocol library*, oscillator, etc. Sigfox requires a new certification for *Major Changes*.

In case of *Minor Changes* that have no impact on the *Sigfox RF & protocol Specifications* and associated tests. Sigfox does NOT require a new certification for *minor changes*.

There are 2 types of upgrade for major changes:

Upgrade type	Description	Who tests?	Re-certification is needed?	Certification fees
General Upgrade	HW, PCB, BOM, Schematics, new RC...	a <i>Sigfox Accredited test house</i>	YES	YES
Library upgrade	The only change is a <i>Sigfox protocol library</i> upgrade	a <i>Sigfox Accredited test house</i>	YES	NO

Table 9: Summary of upgrade types for a Sigfox Verified™ modular design

Sigfox will assess eligibility of the upgrade offer and acknowledge the Partner’s request during submission. If positive, the same certificate is kept but updated. Sigfox Verified certificate is issued for the upgraded *Modular design*.

6. SIGFOX CERTIFICATION PROCESS

The Sigfox certification process includes all steps from a prepared *Candidate Product* from the *Partner* to the issuance of *Sigfox certificate* by Sigfox.

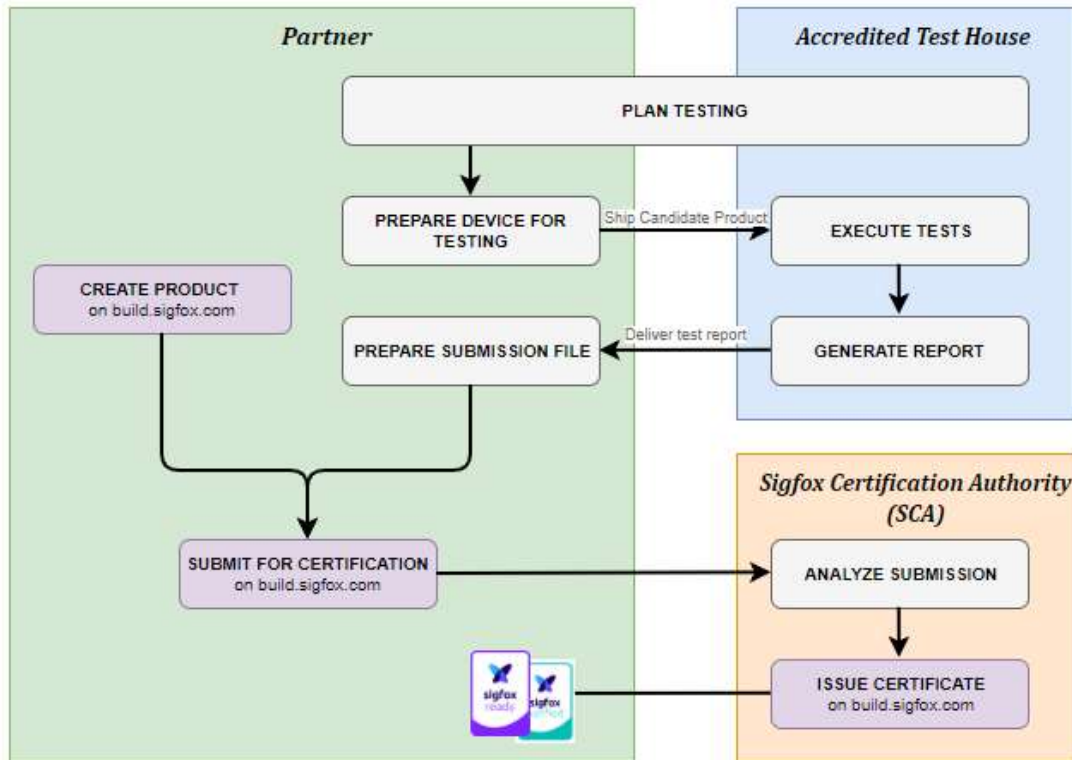

Picture 6: Sigfox certification process

Details of the certification process phases are detailed below:

6.1 Create product

Partner logs on build.sigfox.com to create their new product in their personal space. This step is independent from any testing phases. However, it should be completed at the latest prior to certification submission.

6.2 Plan testing

Partner contacts a Sigfox Accredited Test House to request a quotation and schedules a testing slot for the *Sigfox RF & protocol tests* and/or the *Sigfox radiated performance tests* for each possible radio configuration of their *Device*.

It is recommended to anticipate the availability of slots available at *Sigfox Accredited Test Houses*.

Tests must always be performed against a valid CBL. Please read [“CBL Rules” in Annex 8.1 to know more about Certification Baseline.](#)

Note: While all *Sigfox Accredited Test Houses* can perform *Sigfox radiated performance tests* only some of them are accredited to perform *Sigfox RF & protocol tests*. Please check the list of *Sigfox Accredited Test Houses* and their capabilities on build.sigfox.com:

build.sigfox.com/steps/certification/#Sigfox-accredited-test-houses

Note: *Sigfox Accredited Test Houses* can also execute regulatory certification tests. Consolidating Sigfox testing and regulatory testing may help reduce costs and/or delays for *Partner*.

6.3 Prepare device for testing

Partner follows the “Be prepared for *Sigfox RF & protocol tests*” document and/or “Be prepared for *Sigfox radiated performance tests*” document (depending on type of tests to be carried out), and completes the [checklist](#) which must be provided to the *Sigfox Accredited Test House* prior testing.

Sigfox Certification Specifications are available on build.sigfox.com

These documents include the test modes required for the test house to execute the tests. Note that these test modes are dependent on the device communication mode and supported features.

Partner prepares one or more *Candidate Device* depending on targeted RCs and type of tests to be carried out (i.e. *Sigfox RF & protocol tests* and/or *Sigfox radiated performance tests*). *Partner* should ensure that the HW is ready for use by the *Sigfox Accredited Test House* (power supply access available and documented, RF connector when required, etc.).

To increase the chances of success in testing, Sigfox recommends that *Partner* pre-test certification requirements before sending to the *Sigfox Accredited Test House*, using the test means available on build.sigfox.com. More details can be found in chapter 0

The product is shipped by the *Partner* directly to the *Sigfox Accredited Test House* for testing.

6.4 Execute tests against a valid CBL and generate report (by *Sigfox Accredited Test House*)

Sigfox Accredited Test House executes all tests ordered by Partner according to Sigfox Certification Specifications, assuming *Candidate Device* is properly set with required test modes.

Sigfox Accredited Test House generates a test report according to test requirements and communicates it directly to the *Partner*.

Note from February 2021: Only one radiated test performance is necessary, if you apply for RC1 and RC7.

6.5 Prepare submission file

Partner gathers all required documents for certification to complete the Sigfox Certification submission file. Content depends on the certification request:

Requested documents	Sigfox Ready™					Sigfox Verified™
	Full approach	Modular approach	Similar	Derived	Upgrade	new or upgrade
Product datasheet	X	X	X	X	X	X
Antenna datasheet or antenna characteristics	X	X		X	X	
Battery or power supply datasheet	X	X			X	
External photo of the product in jpg format	X	X	X	X	X	X
Internal photo of the product in jpg format	X	X	X	X	X	X
Sigfox radiated performance test reports	X	X		X	X	
Radiated sensitivity (optional)	X	X		X	X	
Build of Material (BOM) with version number	X	If ref design		If ref design or full approach	If ref design or full approach	X
Schematics with version number	X	If ref design		If ref design or full approach	If ref design or full approach	X
PCB layout with version number	X	If ref design		If ref design or full approach	If ref design or full approach	X
Sigfox RF & protocol test report	X			If full approach	If full approach	X
Commercial User manual						X
RF oscillator datasheet	X			If full approach	If full approach	X
Sigfox RF & protocol test house results (tar.gz)	X			If full approach	If full approach	X
Sigfox Verified™ certificate of Modular design used		X		If modular approach	If modular approach	
Similarity checklist			X			

Table 10: Required documents summary list

6.6 Submit for certification

The submission phase is carried out on build.sigfox.com and is split into 3 steps:

- Upload of the submission files
- Signature of the Sigfox Certification Terms and Conditions,
- order and payment of certification fees.

Partner uploads their submission file online, on the page related to the *Device* created beforehand

Partner orders and pays for certification by credit card or bank transfer directly online. NB: bank transfer confirmation requires a delay for response from the bank. The submission is not effective until payment confirmation is received by the Sigfox Certification Authority.

By proceeding with Sigfox certification on Build.sigfox.com, *Partner* agrees with terms and conditions of certification.

6.7 Analysis of submission file and issuing of certificate (by Sigfox)

Upon *Partner's* submission, Sigfox will analyze the submission file and provide the following feedback through build.sigfox.com:

- Approved
- Additional information is required
- Rejected (after prior discussion with the *Partner*)

If approval is provided by Sigfox, a certificate is granted and delivered to *Partner* through build.sigfox.com, on the dedicated *Device* page.

7. PRE-CERTIFICATION TESTING

Pre-certification testing is strongly recommended by Sigfox in order to ensure that the *Candidate Device* meets the requirements before submitting for formal certification tests.

Pre-certification testing can be done directly by the *Partner* using generic RF lab equipment or tools developed by Sigfox: the SDR-dongle and the *RSA* software (Radio Signal Analyzer). Information about these tools can be found on build.sigfox.com

Note: These tools allow the execution of the majority of *Sigfox RF & Protocol Tests* in conducted mode. However, results may differ from *Sigfox Accredited test houses* results as SDR-Dongle/*RSA* are low-cost tools that do not meet the precise performance of RF laboratory equipment. Please read the user manual carefully before starting pre-testing with *RSA*. *Sigfox Accredited test houses* can propose pre-testing offers to assess *Candidate Device* performance before formal certification tests.

8. ANNEX 1

8.1 CBL Definition

Sigfox Certification baseline (CBL) is a fixed reference point defining all necessary material to perform Sigfox certification tests.

As Sigfox technology evolves, the Certification Baseline has a lifecycle associated to the content of the evolved baseline. The different steps of CBL are defined below:

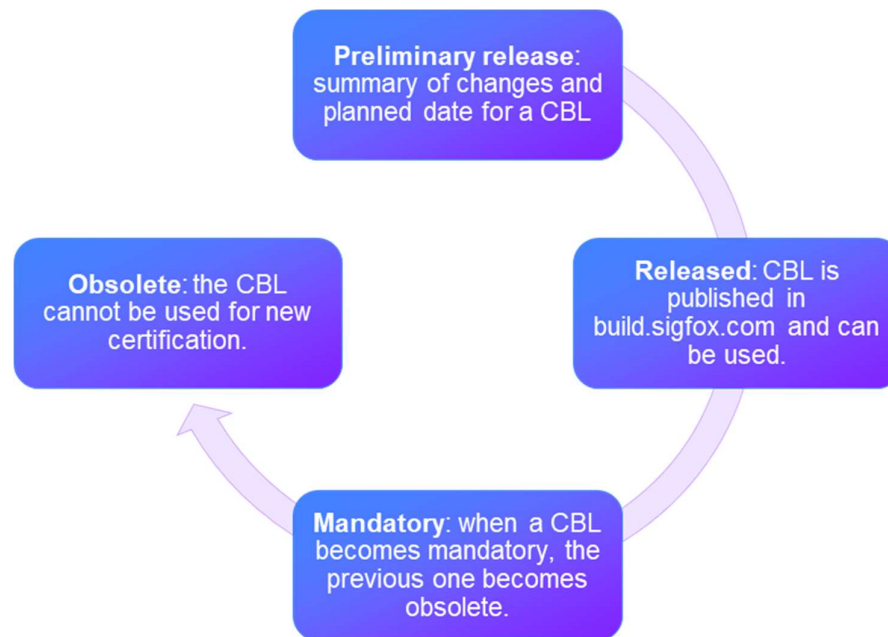

A CBL is composed by the following items:

- Sigfox Testing process
- Sigfox Radiated Test Specification (including Be prepared for Sigfox Radiated performance testing)
- Sigfox RF & Protocol Specification & Test Plan (including Be prepared for Sigfox RF & protocol testing)
- Sigfox RF & Protocol Test Procedures (including test report generator)
- Radio Signal Analyzer (bootable iso) – (including RSA user manual)

8.2 CBL Rules

All devices applying for certification must show compliance to Sigfox Certification specifications from a valid certification baseline.

A valid Certification Baseline is a CBL which can be used for certification testing:

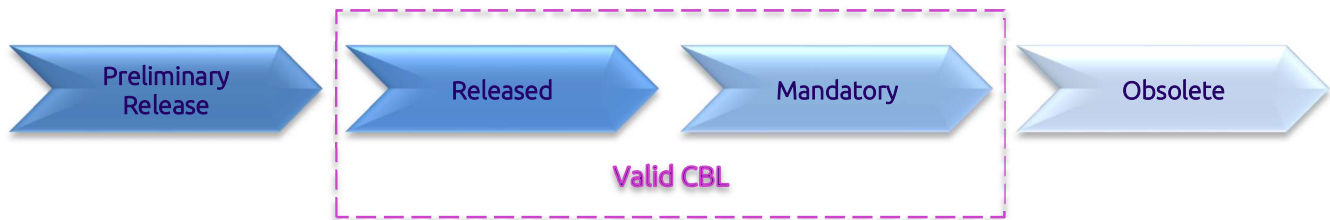

The rules associated to the lifecycle of the CBL are the followings:

- ➔ A new CBL becomes mandatory in average 3 months after being released
- ➔ When a CBL becomes mandatory, the previous mandatory one becomes obsolete
- ➔ From the moment the new CBL version is released, it can be used for certification
- ➔ If a device includes a new feature, which associated testing is not included in current mandatory CBL version, it must use the new released CBL as soon as it is available.
- ➔ Maximum time between submission and granted certification is 6 months.

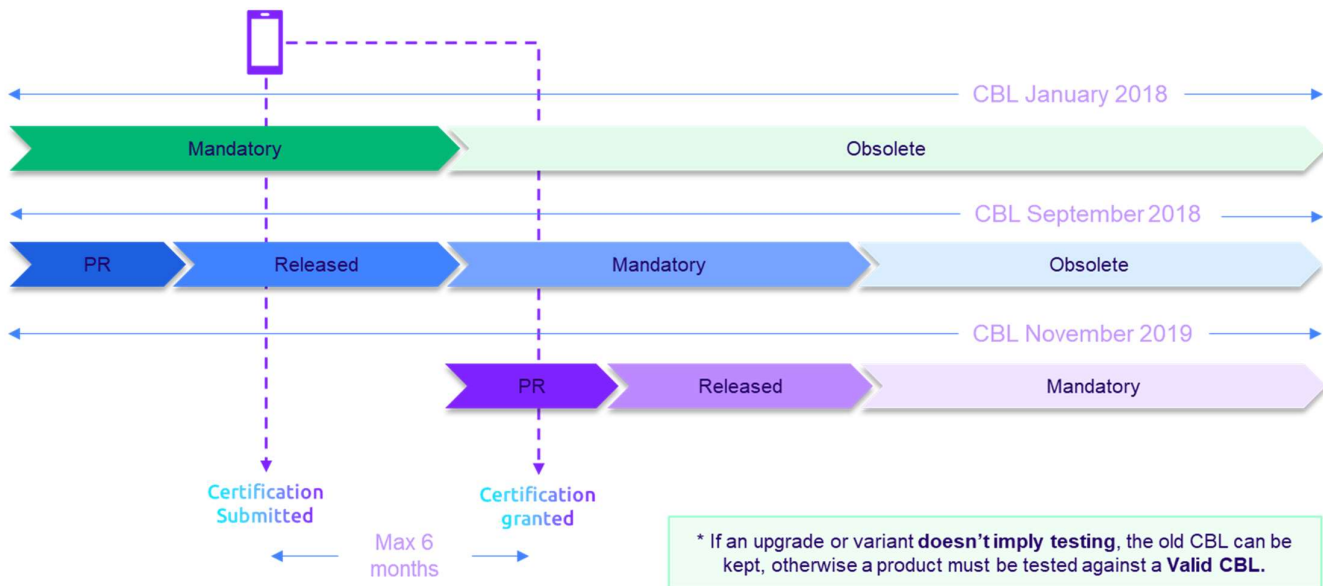

A new device must **always** be certified **against a valid Certification Baseline**.

When a Partner applies for a variant which doesn't imply testing, the product can keep the CBL initially used.

If the variant implies testing, the product must **always** be tested against a valid CBL.

*Example: If a device is certified during the "Released" of September 2018 a Variant which implies testing submitted on November 2019 need to be tested against a valid CBL (Released or Mandatory of November 2019 if the previous one is **Obsolete**).*

9. ANNEX 2

9.1 Sigfox Ready offers

Understanding the offers: For any new device you're bringing to the market, you will have to go through a full Certification Process. If your new device supports multiple RCs with the same hardware, there is only one certification to perform (but with one test report from your test house for every supported RC). If you have created a new device based on a previously Sigfox Ready certified one, you can apply to these cases:

- If you've only changed the module for a different RC, and maybe changed the antenna, then you can apply to the **"Derived" device certification**. Note that you still need your device to be tested with your test house.
- If you've kept the same RF design, but only changed a sensor, then you can apply to the **"Similar" device certification**". In this case, no radiation tests are needed since RF hasn't changed.

About the Derived/Similarity device offer: If you submit several devices for the Derived or Similarity certification, you will only pay for the first Derived or Similar device – the other Derived or Similar ones will be certified free of charge. Case 1: Let's say you have one device that you want to be certified for all current RCs – RC1 through RC7. That means you can use the following offers:

- **RC1 device: first device** offer or **subsequent new device** offer, depending on whether or not this is your company's first ever Sigfox certification (1500€ or 1000€).
- **RC2 device: Derived Device** offer (500€).
- **RC3, RC4, RC5, RC6 and RC7 devices: Free of charge**, if you submit all Derived devices (here, RC2 to RC7) at the same time.

Note: if you apply for RC1 and RC7, only one radiated performance test is necessary Case 2: Let's say you have one device that you want to be certified for 5 different sensors. That means you can use the following offers:

- **RC1 device: first device** offer or **subsequent new device** offer, depending on whether or not this is your company's first ever Sigfox certification (1500€ or 1000€).
- **RC1 device with another sensor: similarity device** offer (500€).
- **3 other** devices with different sensors: **free of charge**, if you submit all Similar devices at the same time.

Note: you can use the same “similarity checklist” for all the similar devices, and if you have many variants, they can be submitted as one similar product on Build.

To help you better understand which offer is the best fit for your situation, we have devised this decision tree:

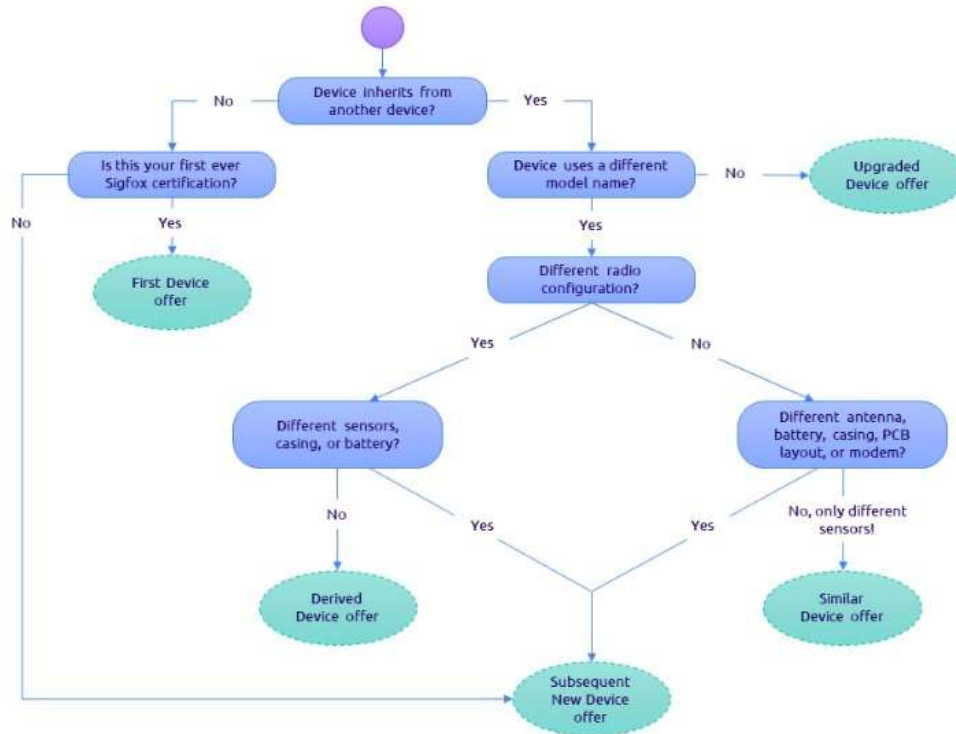

9.2 Sigfox Verified offers

Understanding the offer: for any new modular design you bring to the market, you will have to go through the Sigfox Verified certification process. If your new modular design supports multiple RCs with the same hardware, there's only one certification to perform (but with one test report from your test house for every supported RC).

About the Upgrade offers: in addition to the main certification offer, two offers are available for upgrades:

- **"Upgrade" offer**, applies to a version of an existing Sigfox Verified modular design where major changes have been applied while keeping the same model name (reference) and same RC.
- **"Library Upgrade" offer**, applies to a version of an existing Sigfox Verified modular design where **only the Sigfox Protocol Library** version has been modified while keeping the same model name (reference) and same RC.

In all cases, a test report by RC from an accredited test house is required.