

URBANITY



URINAL (BACK INLET)

PRODUCT ID

(RB.UNY.07G.100.01.07 / RB.TGN.0FS310.PL.PC)

Vitreous China wall mounted Urinal with back inlet water connection, modelled to be used with a sensor operated concealed flush valve.

FEATURES

- Wall hung urinal
- Back inlet only
- Includes D170 concealed fixing bracket
- Vitrious china
- P-trap

WARRANTY

- 25 year written warranty against crazing and dunting

STANDARDS APPLICABLE

Specified model meets or exceeds the following:

- BS 3402:1969
- BS EN 13407:2006

TECHNICAL INFORMATION

** Approximate measurements for comparison only

| CONFIGURATION | WALL MOUNTED URINAL |
|-----------------------|---------------------|
| Weight | 14 kg |
| Height - Floor to Rim | 882 mm |
| Nominal Dimensions | 360 x 530 x 295 mm |
| Inlet Hole | 41 mm |
| Waste Hole | 45 mm |

URBANITY - URINAL (BACK INLET)

TECHNICAL DRAWINGS

All drawings contain the necessary measurements, which are subject to standard tolerances. They are stated in mm, are drawn on a scale of 1:20 and are non-binding. Exact measurements, in particular for customized installation scenarios, can only be taken from the finished ceramic piece.

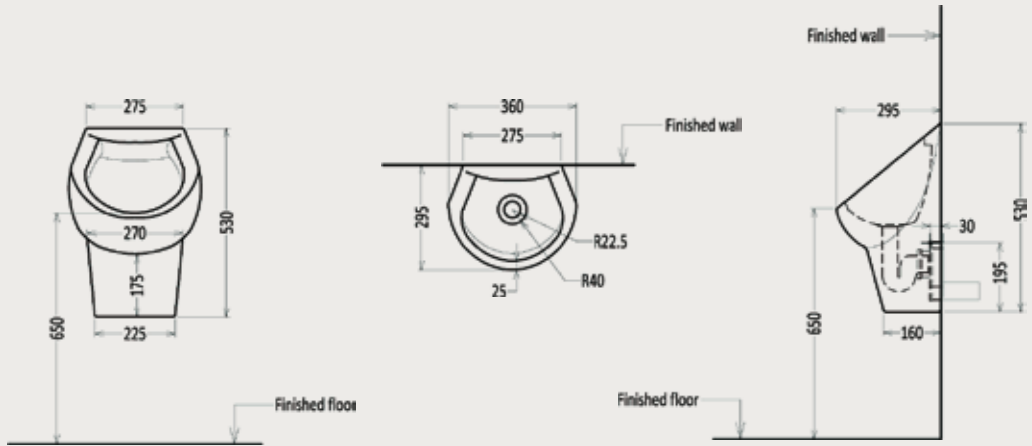

INSTALLATION NOTES

- Install this product according to the installation guide



Royal Ceramics Lanka PLC.

No.20, R.A. De Mel Mawatha, Colombo 03, Sri Lanka.

☎ 076 6 223 344 ✉ info@rcl.lk 🌐 www.rocell.com

FOLLOW US



** Dimensions of fixtures are nominal and may vary within the range of tolerance. These measurements are subject to change or cancellation. No responsibility is assumed for use of superseded or voided leaflet.