

**MODEX-OPTS-TX
MODEX-OPTM-TX
MODEX-OPTS-RX
MODEX-OPTM-RX**



SAFETY INSTRUCTIONS

Class I apparatus construction. This equipment must be used with a main power system with a protective earth connection. The third (earth) pin is a safety feature, do not bypass or disable it.

This equipment should be operated only from the power source indicated on the product.

To disconnect the equipment safely from power, remove the power cord from the rear of the equipment, or from the power source. The MAINS plug is used as the disconnect device, the disconnect device shall remain readily operable.

There are no user-serviceable parts inside of the unit. Removal of the top cover will expose dangerous voltages. To avoid personal injury, do not remove the top cover. Do not operate the unit without the cover installed.

The apparatus shall not be exposed to dripping or splashing and that no objects filled with liquids, such as vases, shall be placed on the apparatus.

The apparatus must be safely connected to multimedia systems. Follow instructions described in this manual.

WEEE (Waste Electrical & Electronic Equipment)

Correct Disposal of This Product

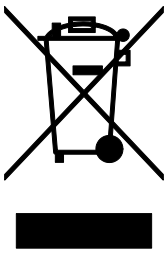

This marking shown on the product or its literature, indicates that it should not be disposed with other household wastes at the end of its working life. To prevent possible harm to the environment or human health from uncontrolled waste disposal, please separate this from other types of wastes and recycle it responsibly to promote the sustainable reuse of material resources.

Household users should contact either the retailer where they purchased this product, or their local government office, for details of where and how they can take this item for environmentally safe recycling.

Business users should contact their supplier and check the terms and conditions of the purchase contract. This product should not be mixed with other commercial wastes for disposal.

Caution: Laser product

This laser product is designated as Class 1M, wavelengths are 850 nm, 1310 nm, 1490 nm, 1550 nm.

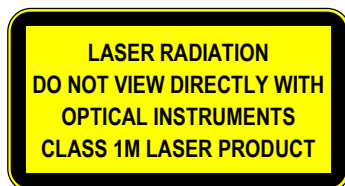



DECLARATION OF CONFORMITY

We,

Lightware Kft. 1071 Budapest Peterdy str. 15 HUNGARY

as manufacturer declare, that the products

**MODEX-OPTS-TX
MODEX-OPTM-TX
MODEX-OPTS-RX
MODEX-OPTM-RX**
(Computer Monitor Extender)

in accordance with the EMC Directive 2004/108/EC and the Low Voltage Directive 2006/95/EEC are in conformity with the following standards:

EMI/EMC EN 55103-1 E3, EN 55103-2

Safety EN 60065 Class I

Date: 1 April 2014

Name: Gergely Vida (Managing Director)

Signed:

Table of contents

1. INTRODUCTION.....	9
1.1. BOX CONTENTS.....	9
1.2. DESCRIPTION.....	9
1.3. FEATURES.....	10
1.4. APPLICATIONS.....	11
2. CONTROLS AND CONNECTIONS.....	12
2.1. MODEX CONCEPT.....	12
2.2. FRAMES.....	13
2.2.1. Transmitter front view.....	13
2.2.2. Receiver front view.....	14
2.3. REAR VIEW.....	15
2.4. MEDIA CONNECTORS.....	15
2.5. VIDEO & AUDIO MODULES.....	16
2.6. INTERFACE MODULES.....	17
2.7. ELECTRICAL CONNECTIONS.....	18
2.7.1. Fiber optical connectors.....	18
2.7.2. HDMI inputs and outputs.....	18
2.7.3. DVI inputs and outputs.....	19
2.7.4. DisplayPort input and output.....	19
2.7.5. BNC connectors (SDI).....	20
2.7.6. Ethernet port.....	20
2.7.7. Symmetrical analog stereo audio.....	20
2.7.8. S/PDIF digital audio input and output.....	21
2.7.9. IR connectors.....	21
2.7.10. RS-232 / RS-422 port.....	21
2.7.11. Neutrik power connector.....	22
3. TECHNOLOGIES.....	23
3.1. UNDERSTANDING EDID.....	23
3.1.1. Basics.....	23
3.1.2. Common problems related to EDID.....	23
3.2. ADVANCED EDID MANAGEMENT.....	24
3.3. HDCP MANAGEMENT.....	24
3.3.1. Protected and unprotected content.....	24
3.3.2. Real life examples.....	25
4. INSTALLATION.....	26
4.1. CONNECTING DEVICES.....	26
4.2. SERIAL DEVICES.....	27
4.2.1. General information about serial communication.....	27
4.2.2. Example connection diagrams.....	27
4.3. MOUNTING OPTIONS.....	28
4.3.1. Rack shelf mounting (with 1U high rack shelf).....	28
4.3.2. Truss mounting (with Mounting bracket V2).....	28
4.3.3. Through furniture mounting (with Mounting bracket V2).....	28
5. FRONT PANEL OPERATIONS.....	29
5.1. FRONT PANEL MENU.....	29
5.2. INFO MENU.....	30
5.3. SETTINGS MENU.....	30
5.3.1. Network settings.....	30
5.3.2. System settings.....	31
5.4. MODULES MENU.....	32
5.4.1. MODEX-PH-OPTS.....	32
5.4.2. MODEX-AV-HDMI-OM and MODEX-AV-HDMI14-OM.....	32
5.4.3. MODEX-AV-HDMI-DVI-IM and MODEX-AV-HDMI-DVI-4K-IM.....	32
5.4.4. MODEX-IF-AUD.....	33

5.4.5.	MODEX-IF-RS232-IR	33
5.5.	CROSSPOINTS MENU	34
5.6.	USB K&M MENU	34
5.7.	EDID MENU (TRANSMITTER)	34
5.7.1.	Viewing and changing the emulated EDID	34
5.8.	EDID MENU (RECEIVER)	35
5.9.	PRESETS MENU	35
5.9.1.	Applying a preset	35
6.	WEB CONTROL – USING THE BUILT-IN WEBSITE	36
6.1.	NETWORK STRUCTURE	36
6.1.1.	IP settings	36
6.1.2.	Establishing the connection	36
6.2.	LAYOUT OF BUILT-IN WEB	37
6.3.	CROSSPOINT MENU	38
6.3.1.	Video crosspoint	39
6.3.2.	Audio crosspoint	39
6.3.3.	Infra crosspoint	40
6.3.4.	Serial crosspoint	41
6.4.	MODULE PROPERTIES AND SETTINGS	43
6.4.1.	Optical link quality	43
6.4.2.	Video modules	43
6.4.3.	Audio modules	43
6.5.	PORT PROPERTIES AND SETTINGS	46
6.5.1.	Analog audio input port	47
6.5.2.	Analog audio output port	47
6.5.3.	HDMI output port	47
6.5.4.	HDMI input port	48
6.5.5.	SDI port	48
6.5.6.	IR port	49
6.5.7.	RS-232 port	49
6.6.	EDID MENU	50
6.6.1.	About EDID memory (transmitter)	50
6.6.2.	EDID types	50
6.6.3.	Advanced EDID Management	51
6.6.4.	Changing emulated EDID	51
6.6.5.	Learning an EDID	52
6.6.6.	Exporting an EDID	52
6.6.7.	Importing an EDID	52
6.6.8.	EDID Summary window	52
6.6.9.	Creating an EDID	52
6.6.10.	Editing an EDID	53
6.6.11.	Deleting EDID(s)	53
6.7.	CONTROL MENU	53
6.7.1.	Ethernet tab	53
6.7.2.	USB tab	54
6.8.	EVENT MANAGER	54
6.8.1.	The event area	55
6.8.2.	Wizard mode	56
6.8.3.	Advanced mode	57
6.8.4.	Save, load or clear an event	58
6.9.	SETTINGS MENU	59
6.9.1.	Core tab	59
6.9.2.	Network tab	59
6.9.3.	Status tab	60
6.9.4.	System log tab	60
6.9.5.	Presets tab	61
6.9.6.	Backup tab	62
6.9.7.	Lock tab	63
6.10.	ADVANCED VIEW	64

7. PROGRAMMER'S REFERENCE	65
7.1. LW3 PROTOCOL – OVERVIEW.....	65
7.1.1. Elements of tree structure.....	65
7.1.2. Escaping.....	67
7.1.3. Error messages.....	68
7.1.4. Prefix summary.....	68
7.2. COMMANDS.....	69
7.2.1. Get all children of a node.....	69
7.2.2. Get all properties and methods of a node.....	69
7.2.3. Get all child nodes, properties and methods of a node.....	70
7.2.4. Set command.....	70
7.2.5. Invocation.....	71
7.2.6. Subscription.....	71
7.2.7. Notifications about the changes of the properties.....	73
7.2.8. Signature.....	73
7.2.9. Manual.....	74
7.2.10. Formal definitions.....	74
7.3. LW3 PROTOCOL TREE.....	74
7.3.1. /REMOTE.....	75
7.3.2. /PRESETS.....	75
7.3.3. /MANAGEMENT/.....	75
7.3.4. /EDID.....	76
7.3.5. /MEDIA.....	76
7.3.6. /SYS.....	76
7.4. VIDEO PORT AND CROSSPOINT SETTINGS.....	76
7.4.1. Query the video crosspoint setting.....	76
7.4.2. Query the status of source ports.....	77
7.4.3. Mute an input port.....	78
7.4.4. Unmute an input port.....	78
7.4.5. Lock an input port.....	78
7.4.6. Unlock an input port.....	78
7.4.7. Mute the output.....	78
7.4.8. Unmute the output.....	79
7.4.9. Lock the output.....	79
7.4.10. Unlock the output.....	79
7.5. AUDIO PORT AND CROSSPOINT SETTINGS.....	79
7.5.1. Query the audio crosspoint setting.....	79
7.5.2. Switching audio input.....	80
7.6. RS-232 PORT CONFIGURATION.....	80
7.6.1. BAUD rate setting.....	80
7.6.2. Databit setting.....	80
7.6.3. Stopbit setting.....	80
7.6.4. Parity setting.....	81
7.7. NETWORK CONFIGURATION.....	81
7.7.1. Query the DHCP state.....	81
7.7.2. Change the DHCP state.....	81
7.7.3. Query the IP address (dynamic).....	81
7.7.4. Change the IP address (static).....	81
7.7.5. Query the subnet mask (static network mask).....	82
7.7.6. Change the subnet mask (static).....	82
7.7.7. Query the gateway address (static).....	82
7.7.8. Change the gateway address (static).....	82
7.8. EVENT SETTINGS (CONDITIONS AND ACTIONS).....	82
7.8.1. Set the source node (condition).....	83
7.8.2. Set the source property (condition).....	83
7.8.3. Set the value of the source property (condition).....	83
7.8.4. Set the target node (action).....	83
7.8.5. Set the target property (action).....	84
7.8.6. Set the value of the target property (action).....	84
7.9. EDID MANAGEMENT.....	84

7.9.1.	Query the emulated EDIDs	84
7.9.2.	Query the validity of a dynamic EDID	84
7.9.3.	Query a user EDID header	84
7.9.4.	Emulating an EDID to an input port	85
7.9.5.	Copy an EDID to user memory	85
7.9.6.	Deleting an EDID from user memory	85
7.9.7.	Resetting emulated EDIDs	85
8.	FIRMWARE UPGRADE.....	86
8.1.	SHORT INSTRUCTIONS.....	86
8.2.	DETAILED INSTRUCTIONS.....	86
8.2.1.	Get the firmware pack and the LDU application	86
8.2.2.	Install the LDU application	86
8.2.3.	Connect the computer to the MODEX device(s)	89
8.2.4.	Start the LDU and follow the instructions shown on the screen	89
9.	SPECIFICATIONS	94
9.1.	FRAMES	94
9.1.1.	MODEX-F15 frames	94
9.2.	MEDIA CONNECTORS.....	95
9.2.1.	MODEX-OPTS and MODEX-OPTM.....	95
9.3.	VIDEO & AUDIO MODULES.....	96
9.3.1.	MODEX-AV-DVIDL-IM.....	96
9.3.2.	MODEX-AV-DVIDL-OM.....	96
9.3.3.	MODEX-AV-HDMI-DVI-IM.....	97
9.3.1.	MODEX-AV-HDMI-DVI-4K-IM	97
9.3.2.	MODEX-AV-HDMI-OM	98
9.3.3.	MODEX-AV-HDMI-4K-OM.....	98
9.3.4.	MODEX-AV-DP-IM	99
9.3.5.	MODEX-AV-DP-OM.....	99
9.3.6.	MODEX-AV-3GSDI-IM.....	100
9.3.7.	MODEX-AV-DVI-OM.....	100
9.3.8.	MODEX-AV-DVI-IM	101
9.3.9.	MODEX-AV-DVI-4K-OM	102
9.3.10.	MODEX-AV-HDMI-DVI-4K-OM	102
9.4.	INTERFACE MODULES	103
9.4.1.	MODEX-IF-RS232	103
9.4.2.	MODEX-IF-2xRS232	103
9.4.3.	MODEX-IF-RS232-RS422	103
9.4.4.	MODEX-IF-RS232-IR	104
9.4.5.	MODEX-IF-ETH	104
9.4.6.	MODEX-IF-AUDIN	104
9.4.7.	MODEX-IF-AUDOUT	105
9.4.8.	MODEX-IF-AUD.....	105
9.4.9.	MODEX-IF-4ETH.....	105
9.4.10.	MODEX-IF-ETH-ECN	106
10.	TROUBLESHOOTING.....	107
11.	APPENDIX	110
11.1.	MECHANICAL DRAWINGS.....	110
11.2.	FACTORY DEFAULT SETTINGS	111
11.3.	FACTORY EDID LIST	112
12.	VERSION APPLICABILITY	113
13.	WARRANTY	113
14.	DOCUMENT REVISION HISTORY	113

1. Introduction

Thank you for choosing MODEX, Lightware's Modular Extender family. The MODEX family is a hybrid, modular and multi-layer group of extenders supporting AV and broadcast industry's formats. Capable of extending digital and analog audio and video, USB KVM, Ethernet and control signals like RS-232, RS-422 or Infrared.

1.1. Box contents

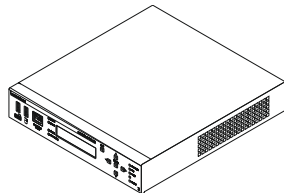

MODEX transmitter or receiver

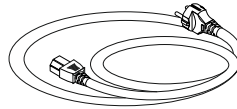

Power cable with IEC connector

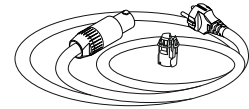

Power cable with Neutrik powerCON connector and additional chuck¹

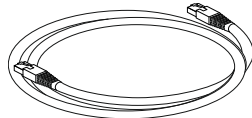

UTP patch cable (1 m)

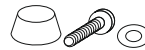

Rubber feet with screws and washers (4x)

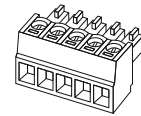

Phoenix® Combicon (3.5mm pitch) connector²

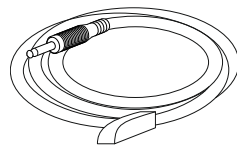

Infrared transmitter with TS male connector³

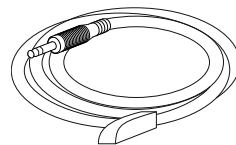

Infrared receiver with TRS male connector³

1.2. Description

The technology built into the MODEX family breaks many standard limitations allowing 30 meters DVI cable on input, Advanced EDID Management, Pixel Accurate Reclocking, LAN and RS-232/RS-422 control.

The half unit extender allows one video & audio module and two interface modules (each can be the same or different type). The front panel has an additional 10/100 Mbps Ethernet port (with full functionality, but can be used as control interface) and USB KVM connectors (transmitter has one USB-B for the computer; receiver has two USB-A connectors for the keyboard and mouse). Keyboard and mouse functions are emulated by the extender and no USB enumeration occurs while operator switching. A computer is not aware when a keyboard or mouse has been changed.

MODEX includes a family of long distance transmitters and receivers for sending and receiving video, audio, RS-232 and IR control, USB KVM and Ethernet over a single fiber cable. Media connector, the heart of the MODEX determines the signal transportation type as well as the direction (the unit is a transmitter or receiver).

The MODEX is fully compatible with the 25G hybrid architecture.

¹ For the following media connectors: MODEX-CON-OPTS-NT-PCN and MODEX-CON-OPTM-NT-PCN.

² For the following modules: MODEX-IF-AUDIN and MODEX-IF-AUDOUT (1-1 pc.), MODEX-IF-AUD (2 pcs.)

³ For the following module: MODEX-IF-RS232-IR

1.3. Features⁴

- **Variable A/V modules** – MODEX can be supplied with different type of Video ports both on transmitter and receiver side: HDMI, DVI, DisplayPort and 3G-SDI connectors. To increase the flexibility, transmitter and receiver can be assembled with different type of video ports.
- **Wide range of interface modules** – There are two slots in the extenders where interface modules can be installed. Numerous modules are available which contains Analog-, S/PDIF audio connectors, Ethernet-, RS-232- and Infrared ports in many combinations.
- **Physical modules with different connectors** – MODEX can be ordered with many type of power connectors and optical connectors.
- **LW3 protocol** – The devices use the new LW3 protocol which is based on a well-structured protocol tree. Wide range of properties and methods allow to get information about the ports or create controlling commands.
- **25G compatibility** – Thanks for the LW3 protocol and the design of MODEX and 25G matrix, the devices are compatible and able to send controlling commands to each other.
- **Signal transmission up to 10 km** – MODEX with single mode optical unit is able to transmit the signal to 10 km distance.
- **Single fiber technology** – MODEX-OPTS and -OPTM extenders give optical transmission over a single or duplex fiber; equipped with a Neutrik OpticalCON or industrial grade connector but both can be used with LC fiber cable.
- **Pixel accurate reclocking** – The video output on the receiver has a clean, jitter free signal, eliminating signal instability and distortion caused by long cables or connector reflections.
- **Built-in web page** – Easy access from a Web browser to control and configure the MODEX pair.
- **Controlling functions with the Event manager** – MODEX can be configured to perform an action if a condition appears. E.g. if a signal is present on an input, a command is sent via the RS-232 port.
- **Advanced EDID Management** – User can emulate any EDID on video input ports, read out and store any monitor's EDID.
- **HDCP enable / disable** – MODEX extenders are HDCP-capable ones. To display unprotected content on a non-HDCP capable sink, HDCP can be disabled via the front panel menu or from a web browser by the built-in web page.
- **USB K+M** – Connected USB HID devices (e.g. keyboard, mouse) are extended from transmitter to receiver thus a computer can be remote controlled.
- **Simple and fast Firmware upgrade** –Lightware Device Updater helps to upgrade many devices together. The process is easier than before: the extenders use the same firmware package.
- **Front panel control** – EDID emulation, Network settings, Preset handling and the most important module settings are available on LCD-based menu with navigation buttons.
- **Half-rack sized** – The housing of the extenders fits to the industrial standard rack dimension: 1 rack unit high and half rack wide. Further accessories help to mount the units easily.
- **Built-in universal power supply** – The extenders are equipped with a built-in universal power supply, which accepts AC voltages from 100 to 240 Volts with 50 or 60 Hz line frequency.
- **Front panel LEDs** – Audio, Video, Optical Link and PSU LEDs to get immediate feedback about the signals and link status.

⁴ The available features depend on the modules installed into the given MODEX product.

1.4. Applications



Figure 1-1. Integrated system

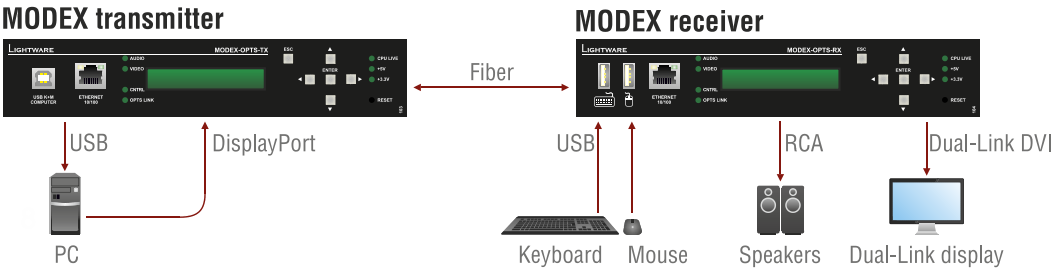

Figure 1-2. Stand-alone application

2. Controls and connections

2.1. MODEX concept

Code sequence

Each MODEX unit has a 15-character-long code sequence which identifies the modules built in the frame. The code sequence consists of 5x3 blocks of characters. The 3-character-long blocks are the last three characters of a module's part code (this code is also painted on the module/frame).

The following example represents the structure of the code sequence:



The module code – that is displayed in idle state – of above MODEX unit is:

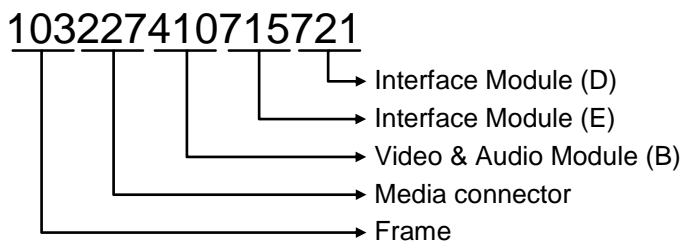

103:	(9161 0103) MODEX-OPTS-TX	Frame
227:	(9161 0227) MODEX-CON-NT-OPTS	Media connector
410:	(9161 0410) MODEX-AV-HDMI-DVI-4K-IM	Video & Audio Module (B)
715:	(9161 0715) MODEX-IF-RS232-IR	Interface Module (E)
721:	(9161 0721) MODEX-IF-AUD	Interface Module (D)

Info: The order of the modules and codes are determined by Lightware.

Module layout

The layout of the modules is fixed so as the order of the module codes. B, D and E letters determine the module positions which help to identify them in LW3 protocol.

C means the physical module (PHY), which is integrated into the Core module in MODEX-OPT extenders.

The letters are also displayed in the built-in website in the Settings menu, Status submenu, see section [6.9.3](#) on page [60](#), and Lock submenu, see in section [6.9.6](#) on page [62](#).

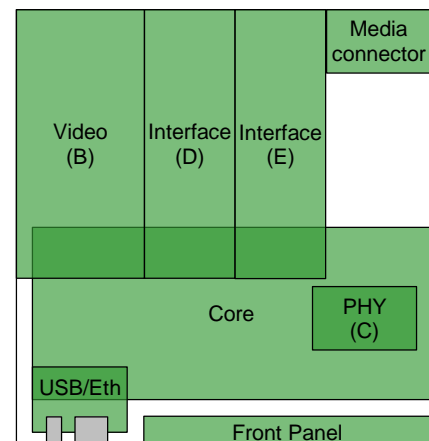

2.2. Frames

2.2.1. Transmitter front view

Info: MODEX-OPTS frames can be seen on the photos which are almost the same as MODEX-OPTM frames. Their housing contains just two differences: the 'OPTM' designation and the part number.

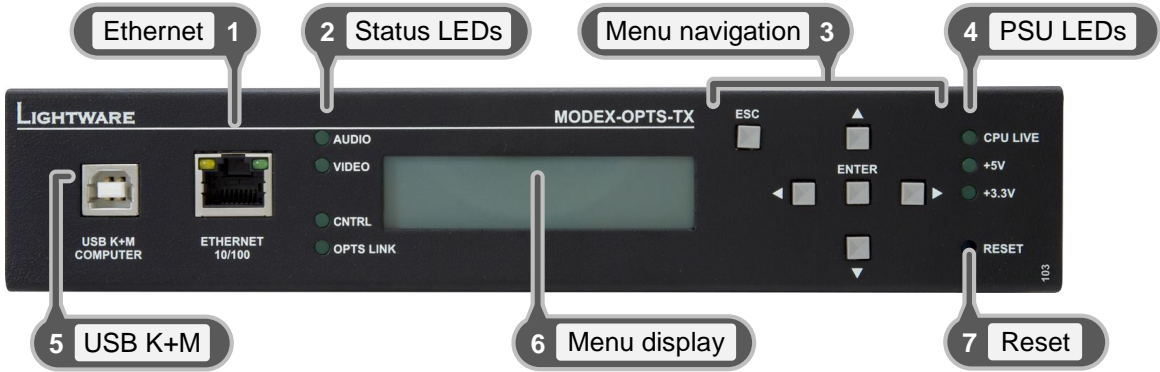

- 1 Ethernet** Locking RJ45 socket. Remote control port for connecting the unit to Local Area Network (LAN).
- 2 Status LEDs** Audio LED lights green when the audio transfer is active. Video LED indicates correct video transmission. CNTRL LED is green when low speed handshake of the extenders is complete. OPTS LINK LED lights when optical link is active.
- 3 Menu navigation** Up, down, left, right, enter and escape buttons for menu navigation.
- 4 PSU LEDs** CPU live LED blinks to indicate normal operation. +5V and +3.3V LEDs light green when the extender is powered on.
- 5 USB K+M** USB connection to HOST (Computer) unit via USB B-type connector.
- 6 Menu display** Displays status information and menu operation on the LCD with 2x16 characters.
- 7 Reset** Reset button reboots the extender. This is the same as disconnecting from power source and reconnecting again.

Transmitter frames

Frame type	Part nr.
MODEX-F15-OPTS-TX	9161 0103
MODEX-F15-OPTM-TX	9161 0106

2.2.2. Receiver front view

Info: MODEX-OPTS frames can be seen on the photos which are almost the same as MODEX-OPTM frames. Their housing contains just two differences: the 'OPTM' designation and the part number.

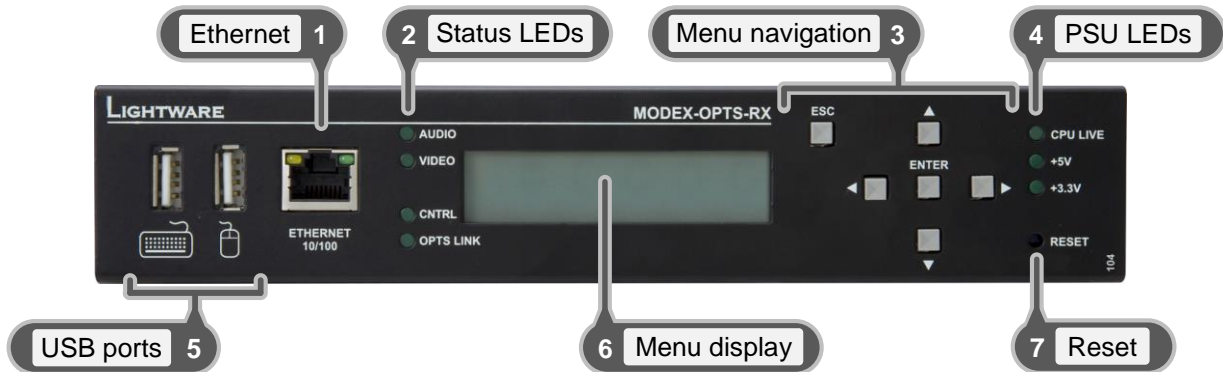

- 1 Ethernet** Locking RJ45 socket. Remote control port for connecting the unit to Local Area Network (LAN).
- 2 Status LEDs** Audio LED lights green when the audio transfer is active. Video LED indicates correct video transmission. CNTRL LED is green when low speed handshake of the extenders is complete. OPTS LINK LED lights when optical link is active.
- 3 Menu navigation** Up, down, left, right, enter and escape buttons for menu navigation.
- 4 PSU LEDs** CPU live LED blinks to indicate normal operation. +5V and +3.3V LEDs light green when the extender is powered on.
- 5 USB ports** USB K+M ports for HID¹ devices (preferably Keyboard and mouse). See more information in section [6.7.2](#) on page [54](#).
- 6 Menu display** Displays status information and menu operation on the LCD with 2x16 characters.
- 7 Reset** Reset button reboots the extender. This is the same as disconnecting from power source and reconnecting again.

Receiver frames

Frame type	Part nr.
MODEX-F15-OPTS-RX	9161 0104
MODEX-F15-OPTM-RX	9161 0107

¹ HID: Human Interface Device

2.3. Rear view

MODEX can be supplied with many kind of interface modules, thus the rear view of the extenders are different. Following example shows the structure of the installed modules.

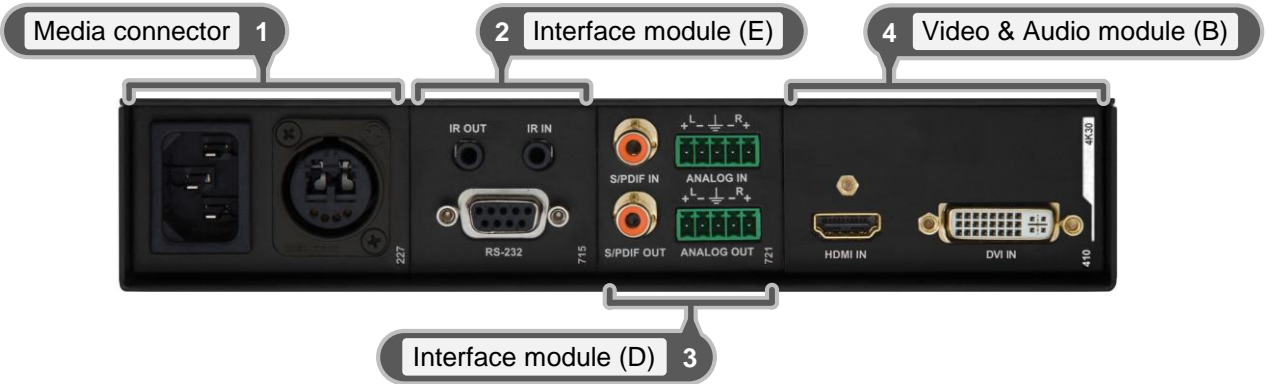

2.4. Media connectors



MODEX-CON-NT-OPTS
Part nr. 9161 0227



MODEX-CON-NT-OPTM
Part nr. 9161 0228



MODEX-CON-OPTS-ODVA
Part nr. 9161 0229



MODEX-CON-OPTM-ODVA
Part nr. 9161 0230



MODEX-CON-OPTS-NT-PCN
Part nr. 9161 0231



MODEX-CON-OPTM-NT-PCN
Part nr. 9161 0232



MODEX-CON-OPTS-ST
Part nr. 9161 0235



MODEX-CON-OPTM-ST
Part nr. 9161 0236



MODEX-CON-OPTS-SC
Part nr. 9161 0237



MODEX-CON-OPTM-SC
Part nr. 9161 0238



MODEX-CON-OPTS-NT-BRK-LC
Part nr. 9161 0241¹



MODEX-CON-OPTM-NT-BRK-LC
Part nr. 9161 0242¹

¹ „BRK” means the breakout connector. „X” sign means that the LC connector is not connected internally.

2.5. Video & Audio modules



MODEX-AV-DVIDL-IM
Part nr. 9161 0401



MODEX-AV-DVIDL-OM
Part nr. 9161 0404



MODEX-AV-HDMI-DVI-IM
Part nr. 9161 0407



MODEX-AV-HDMI-DVI-4K-IM
Part nr. 9161 0410

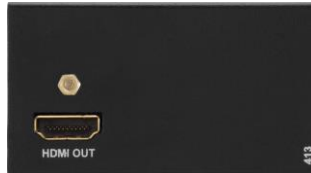

MODEX-AV-HDMI-OM
Part nr. 9161 0413



MODEX-AV-HDMI-4K-OM
Part nr. 9161 0416



MODEX-AV-DP-IM
Part nr. 9161 0419



MODEX-AV-DP-OM
Part nr. 9161 0422



MODEX-AV-3GSDI-IM
Part nr. 9161 0426



MODEX-AV-DVI-OM
Part nr. 9161 0430



MODEX-AV-DVI-IM
Part nr. 9161 0433

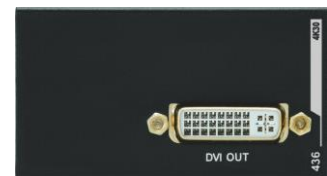

MODEX-AV-DVI-4K-OM
Part nr. 9161 0436



MODEX-AV-HDMI-DVI-4K-OM
Part nr. 9161 0439

2.6. Interface modules



MODEX-IF-RS232
Part nr. 9161 0712



MODEX-IF-2xRS232
Part nr. 9161 0713



MODEX-IF-RS232-RS422
Part nr. 9161 0714



MODEX-IF-RS232-IR
Part nr. 9161 0715



MODEX-IF-ETH
Part nr. 9161 0718



MODEX-IF-AUDIN
Part nr. 9161 0719



MODEX-IF-AUDOUT
Part nr. 9161 0720

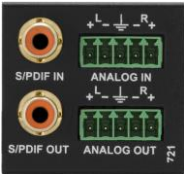

MODEX-IF-AUD
Part nr. 9161 0721



MODEX-IF-4xETH
Part nr. 9161 0726



MODEX-IF-ETH-ECN
Part nr. 9161 0727

2.7. Electrical connections

2.7.1. Fiber optical connectors

MODEX can be ordered with several standard fiber connector types.

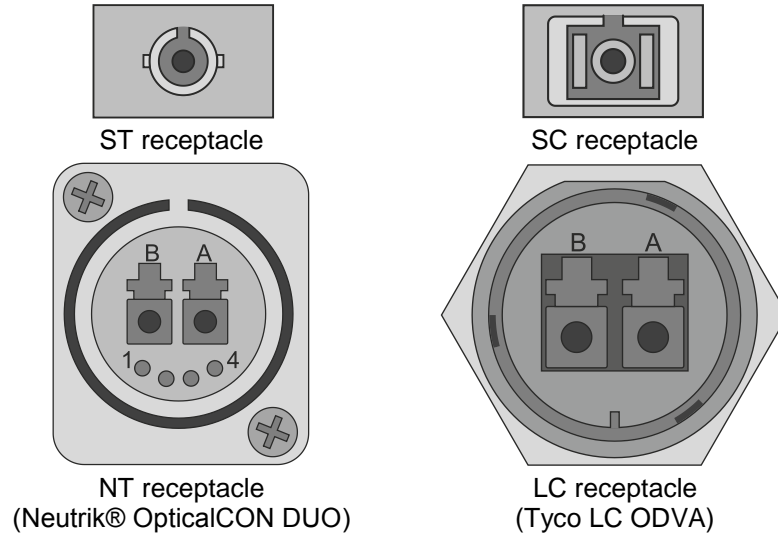
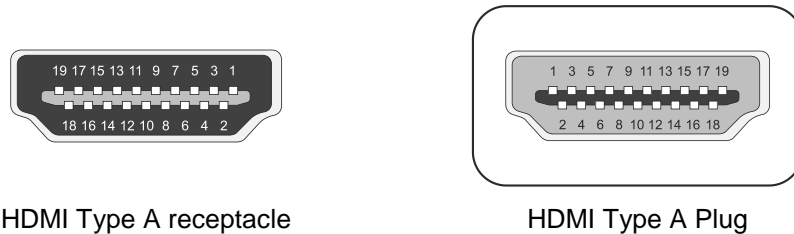

Figure 2-1. Available Fiber optical connectors for MODEX

Neutrik OpticalCON connector (NO2-4FDW type LC duplex) and LC ODVA connector have two fiber channels, channel A and channel B. Only one channel is used (from channel A on transmitter to channel B on receiver). The copper pins of the Neutrik connector are not in use.

2.7.2. HDMI inputs and outputs

19-pole HDMI connectors are provided for inputs and outputs.



Pin	Signal	Pin	Signal
1	TMDS Data2+	11	TMDS Clock Shield
2	TMDS Data2 Shield	12	TMDS Clock-
3	TMDS Data2-	13	CEC
4	TMDS Data1+	14	Reserved
5	TMDS Data1 Shield	15	SCL
6	TMDS Data1-	16	SDA
7	TMDS Data0+	17	DDC/CEC/HEC Ground
8	TMDS Data0 Shield	18	+5 V Power (max 50 mA)
9	TMDS Data0-	19	Hot Plug Detect
10	TMDS Clock+		

Table 2-1. HDMI connector and pin assignments

2.7.3. DVI inputs and outputs

29 pole DVI-I connectors, however internally connected pins vary by interface types. This way, user can plug in any DVI connector, but keep in mind that analog signals (such as VGA or RGBHV) are currently not processed – planned for future developments.

Always use high quality DVI cable for connecting sources and displays. Pay attention to the DVI cable, if dual link signal is to be sent, use only dual link capable DVI cables.

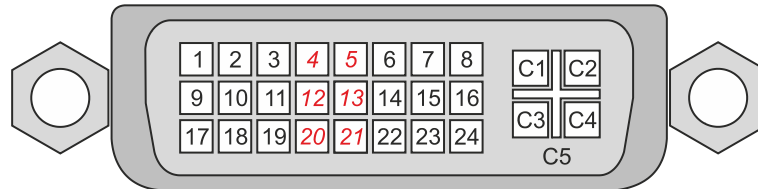

Pin	Signal	Pin	Signal	Pin	Signal
1	TMDS Data2-	9	TMDS Data1-	17	TMDS Data0-
2	TMDS Data2+	10	TMDS Data1+	18	TMDS Data0+
3	TMDS Data2/4 Shield	11	TMDS Data1/3 Shield	19	TMDS Data0/5 Shield
4	<i>TMDS Data4⁻¹</i>	12	<i>TMDS Data3⁻¹</i>	20	<i>TMDS Data5⁻¹</i>
5	<i>TMDS Data4⁺</i>	13	<i>TMDS Data3⁺</i>	21	<i>TMDS Data5⁺</i>
6	DDC Clock	14	+5V Power	22	TMDS Clock Shield
7	DDC Data	15	GND (for +5V)	23	TMDS Clock+
8	n.c.	16	Hot Plug Detect	24	TMDS Clock-
C1	n.c.	C2	n.c.	C3	n.c.
C4	n.c.	C5	GND		

Table 2-2. DVI-I connector pin assignments

2.7.4. DisplayPort input and output

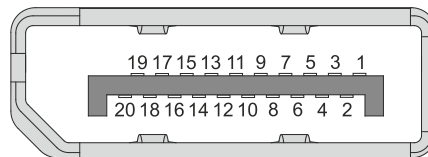

INPUT				OUTPUT			
Pin	Signal	Pin	Signal	Pin	Signal	Pin	Signal
1	ML_Lane 3 (n)	11	GND	1	ML_Lane 0 (p)	11	GND
2	GND	12	ML_Lane 0 (p)	2	GND	12	ML_Lane 3 (n)
3	ML_Lane 3 (p)	13	Config1	3	ML_Lane 0 (n)	13	Config1
4	ML_Lane 2 (n)	14	Config2	4	ML_Lane 1 (p)	14	Config2
5	GND	15	AUX CH (p)	5	GND	15	AUX CH (p)
6	ML_Lane 2 (p)	16	GND	6	ML_Lane 1 (n)	16	GND
7	ML_Lane 1 (n)	17	AUX CH (n)	7	ML_Lane 2 (p)	17	AUX CH (n)
8	GND	18	Hot Plug	8	GND	18	Hot Plug
9	ML_Lane 1 (p)	19	Return	9	ML_Lane 2 (n)	19	Return
10	ML_Lane 0 (n)	20	DP_PWR	10	ML_Lane 3 (p)	20	DP_PWR

Table 2-3. DisplayPort connector pin assignments

¹ These pins are connected only in MODEX-AV-DVIDL-IM and MODEX-AV-DVIDL-OM modules.

2.7.5. BNC connectors (SDI)

Standard BNC receptacle is used for SD/HD/3G-SDI input and outputs.

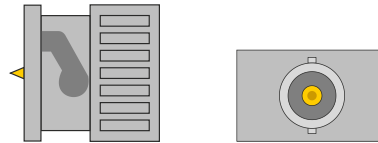

Figure 2-2. BNC receptacle and plug

Recommended coax cable type: Belden 1694A

2.7.6. Ethernet port

MODEX can be remote controlled through Ethernet. The Ethernet port can be connected to a LAN hub, switch or router with a UTP patch cable.

Info: Do not connect more than one port of the MODEX pair to the same LAN to avoid loops.

	LED1 (green)	LED2 (orange)	Pin nr.	Name	Wire color
OFF	no link / 10 Mbps	no activity	1	TX +	Green stripe
ON	100 Mbps	N/A	2	TX -	Green
Blink	N/A	activity	3	RX +	Orange stripe
			4	Not used	Blue
			5	Not used	Blue stripe
			6	RX -	Orange
			7	Not used	Brown stripe
			8	Not used	Brown

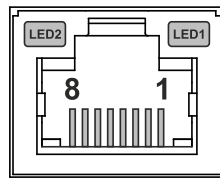

Table 2-4. RJ45 connector and Ethernet pin connections

2.7.7. Symmetrical analog stereo audio

5-pole Phoenix connector is used for symmetrical analog audio. The connector is used on certain interface modules as a configurable input or output. Always check if this connector is configured as an output or input to prevent connecting two outputs together.

Asymmetrical audio signals can be connected as well. For asymmetrical output, connect only + and ground. For asymmetrical input connect + and ground to the source and connect - to the ground.

Pin nr.	Signal
1	Left+
2	Left-
3	Ground
4	Right-
5	Right+

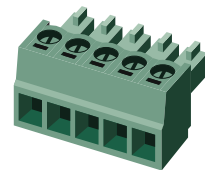
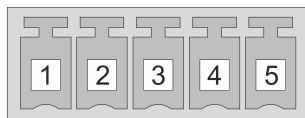

Figure 2-3. Analog input connector pin assignments

Compatible plug type:

Phoenix® Combicon series (3.5mm pitch), type: MC 1.5/5-ST-3.5, order nr. 1840395.

2.7.8. S/PDIF digital audio input and output

Some interface modules have standard RCA receptacles for digital coaxial audio inputs and outputs.

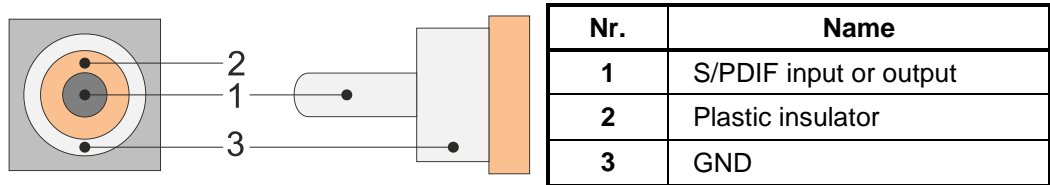

Figure 2-4. S/PDIF receptacle and plug assignments

Info: Plugs and sockets on consumer equipment are conventionally color-coded by CEA/CEDIA-863-B (ANSI) to aid correct connections. According to the standard Lightware devices are supplied with orange colored RCA connectors for S/PDIF signals.

2.7.9. IR connectors

IR Receiver and Transmitter are connected with TRS (Tip, Ring, and Sleeve) connectors. They are also known as (3,5 mm or approx. 1/8") audio jack, phone jack, phone plug or mini-jack plug.

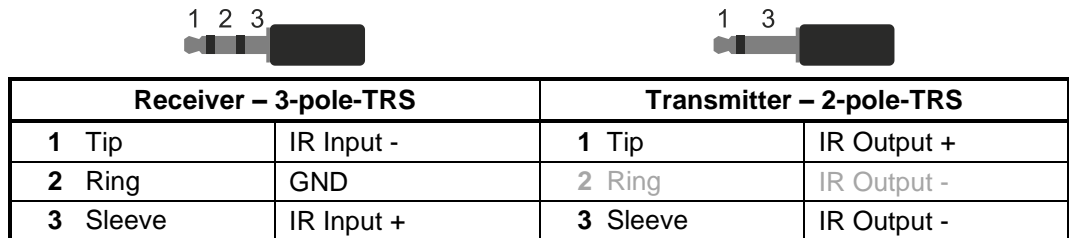
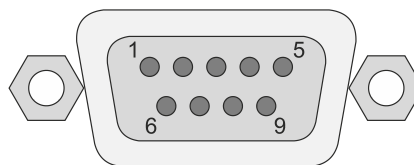

Table 2-5. TRS connector pin assignment for supplied IR accessories

Info: Transmitter's Ring pole is optional. If your IR Transmitter has three pole TRS plug, then the Ring and the Sleeve are the same signal (Output -).

2.7.10. RS-232 / RS-422 port

MODEX can be ordered with interface containing industry standard RS-232 and RS-422 9-pole D-SUB male connector.



Pin nr.	RS-232	RS-422
1	NC - not connected	RX- data receive complement
2	RX data receive (input)	RX+ data receive true
3	TX data transmit (output)	TX+ data transmit true
4	DTR (Internally connected to Pin 6)	TX- data transmit complement
5	GND signal ground (shield)	GND signal ground (shield)
6	DSR (Internally connected to Pin 4)	DSR (Internally connected to Pin 4)
7	RTS	RTS
8	CTS	CTS
9	NC - not connected	NC - not connected

Table 2-6. D-SUB 9-pole-connector and pin assignments

2.7.11. Neutrik power connector

Certain MODEX Media connectors are assembled with special Neutrik power connector, NAC3MPA-1 (Power In). It ensures a very rugged solution in combination with a locking device in order to guarantee a safe power connection.

Important! PowerCON is a connector without breaking capacity; it should not be connected or disconnected under load or live!

After plugging it in, turn the plug clockwise; to disconnect, first pull the latch backward, turn the plug counterclockwise and unplug the connector.

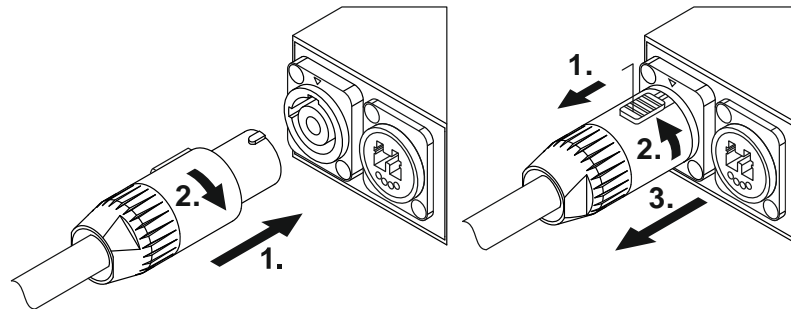

Figure 2-5. Locking and unlocking Neutrik power connector

Supplied power cable

The cable is assembled with NAC3FCA Neutrik power connector (Power In) with white chuck that fits for thin cables (diameter between 6.0 and 11.0 mm). A black-colored chuck is also supplied that fits for thick cables (diameter between 9.5 and 15.0 mm).

Assembling

Important! Cable assembling can be done only by qualified person!

If the cable needs to be replaced, the following steps help when assembling:

- Step 1.** Put bushing and chuck onto the cable.
- Step 2.** Prepare the cable.
- Step 3.** Insert the wire into the terminals and fasten the clamping device by a flat screw driver.
- Step 4.** Push insert and chuck into housing (pay attention to the guiding keyway!)
- Step 5.** Fasten bushing by means of a fork wrench 3/4", min. Torque 2.5 Nm.

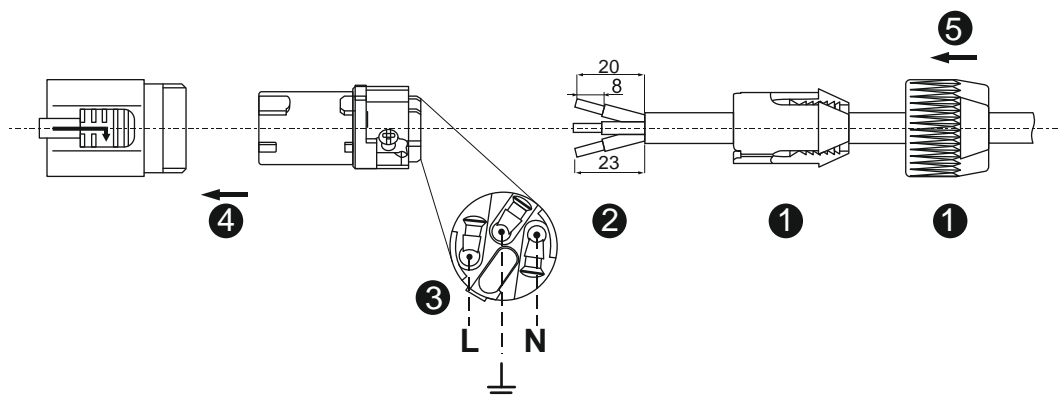

Figure 2-6. Neutrik power connector assembling

3. Technologies

3.1. Understanding EDID

3.1.1. Basics

EDID stands for Extended Display Identification Data. Simply put, EDID is the passport of display devices (monitors, TV sets, projectors). It contains information about the display's capabilities, such as supported resolutions, refresh rates (these are called Detailed Timings), the type and manufacturer of the display device, etc.

After connecting a DVI source to a DVI display, the source reads out the EDID to determine the resolution and refresh rate of the image to be transmitted.

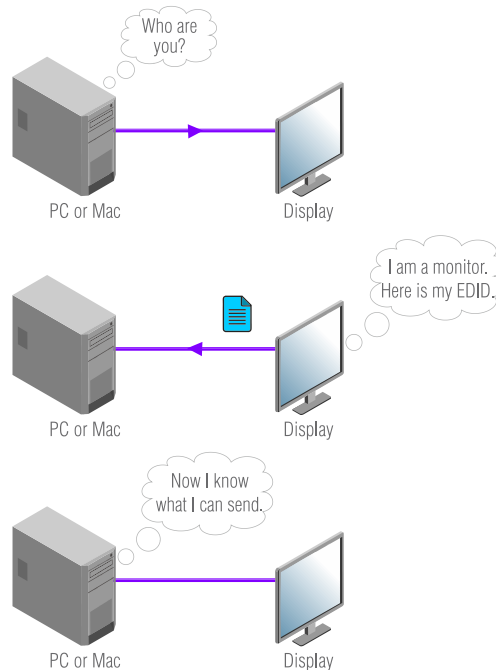

Figure 3-1. EDID communication

Most DVI computer displays have 128-byte long EDID structure. However, Digital Televisions and HDMI capable displays may have another 128 bytes, which is called E-EDID and defined by CEA (Consumer Electronics Association). This extension contains information about additional Detailed Timings, audio capabilities, speaker allocation and HDMI capabilities. It is important to know, that all HDMI capable devices must have CEA extension, but not all devices are HDMI capable which have the extension.

3.1.2. Common problems related to EDID

Problem: „I have changed to a different EDID on MODEX-OPTS-TX to have a different resolution but nothing happens.”

Solution: Some graphics cards and video sources read out the EDID only after power-up and later they don't sense that EDID has been changed. You need to restart your source to make it read out the EDID again.

Problem: „I have a MODEX-OPTS-TX and I'm using a Lightware factory preset EDID. I would like to be able to choose from different resolutions, but my source allows only one resolution.”

Solution: Most Lightware factory preset EDIDs allow only one resolution, forcing the sources to output only that particular signal. You need to select the Universal EDID that supports all common VESA resolutions; see the factory EDID list in section [11.3](#) on page [112](#).

3.2. Advanced EDID management

Each DVI sink (e.g. monitors, projectors, plasma displays, and switcher inputs) must support the EDID data structure. Source BIOS and operating systems are likely to query the sink using DDC2B protocol to determine what pixel formats and interface are supported. DVI standard makes use of EDID data structure for the identification of the monitor type and capabilities. Most DVI sources (VGA cards, set top boxes, etc.) will output DVI signal after accepting the connected sink's EDID information. In case of EDID readout failure or missing EDID, the source will not output DVI video signal.

MODEX transmitters provide Lightware's Advanced EDID Management function that helps system integration. The transmitter's built-in EDID memory stores and emulates more than 100 EDID data (factory presets and user memory, the exact number depends on the firmware) plus the monitor's EDID that is connected to the receiver's output connector. MODEX stores the EDID of the attached monitor or projector in a non-volatile memory. This way the EDID from a monitor is available when the monitor is unplugged, or switched off.

The EDID emulated on the DVI input can be copied from the transmitter's memory (static EDID emulation), or from the last attached monitors memory (dynamic EDID emulation). For example, the transmitter can be set up to emulate a device, which is connected to the receiver's DVI output. In this case the EDID automatically changes, if the monitor is replaced with another display device (as long as it has a valid EDID).

Advanced EDID management can be controlled by the front panel's control buttons and via the built-in webpage.

Info: The user is not required to disconnect the DVI cable to change an EDID as opposed to other manufacturer's products. EDID can be changed even if source is connected to the input and powered ON.

Info: When EDID has been changed, the transmitter toggles the HOTPLUG signal for 2 seconds. Some sources do not observe this signal, so in this case the change is not recognized by the source. In such cases the source device must be restarted or powered OFF and ON again.

3.3. HDCP management

Lightware Visual Engineering is a legal HDCP adopter. Several functions have been developed which help to solve HDCP-related problems. Complex AV systems often have both HDCP and non-HDCP components. MODEX extenders allow to transmit HDCP encrypted and unencrypted signals. The devices will be still HDCP compliant, as they will never output an encrypted signal to a non-HDCP compliant display device. If an encrypted signal is switched to a non-compliant output, a red screen alert or muted screen will be shown.

3.3.1. Protected and unprotected content

Many video sources send HDCP protected signal if they detect that the sink is HDCP capable – even if the content is not copyrighted. This can cause trouble if a HDCP capable device (e.g. an extender-pair) is connected between the source and the display. In this case, the content cannot be viewed on non-HDCP capable displays and interfaces like event controllers.

Rental and staging technicians often complain about certain laptops, which always send HDCP encrypted signals if the receiver device (display, matrix router, etc.) reports HDCP compliancy. However, HDCP encryption is not required all the time e.g. computer desktop image, certain laptops still do that.

To avoid unnecessary HDCP encryption, Lightware introduced the HDCP enabling/disabling function: the HDCP capability can be disabled on the extenders. If HDCP is disabled, the connected source will detect that the sink is not HDCP capable, and turn off authentication.

3.3.2. Real life examples

HDCP-compliant sink

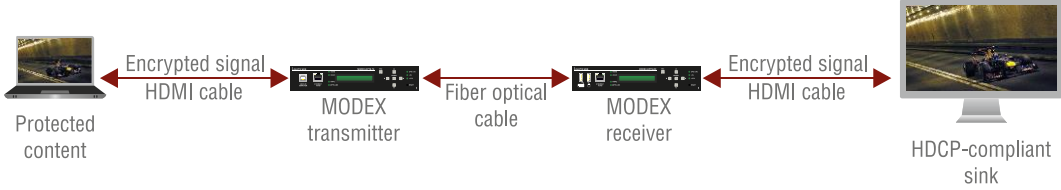

Figure 3-2. HDCP-compliant sink (HDMI/DVI)

All devices are HDCP-compliant, no manual setting is required, both protected and unprotected content is transmitted and displayed on the sink.

Non-HDCP-compliant sink (HDMI/DVI) 1.

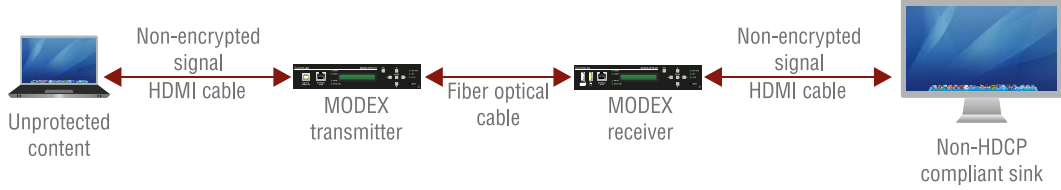

Figure 3-3. Non-HDCP compliant sink displaying unprotected content

Non-HDCP compliant sink is connected to the receiver. Some sources (e.g. computers) always send HDCP encrypted signals if the receiver device reports HDCP compliancy, however HDCP encryption is not required all the time (e.g. computer desktop image). If HDCP is enabled in the extenders, the image will not be displayed.

Settings the HDCP parameter to Auto on the output port and disable HDCP on the input port, the transmitted signal will not be encrypted if the content is not protected. Thus non-HDCP compliant sinks will display non-encrypted signal.

Non-HDCP-compliant sink (HDMI/DVI) 2.

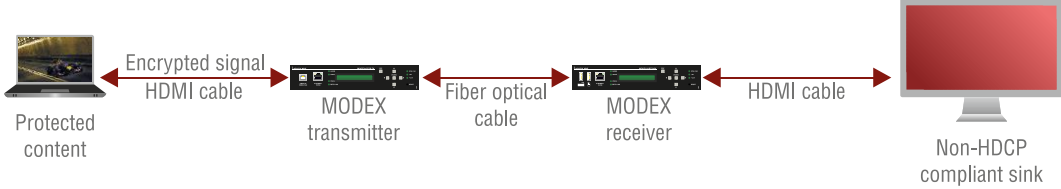

Figure 3-4. Non-HDCP compliant sink and protected content

The layout is the same as in previous case: non-HDCP compliant display device is connected to the receiver but now the source would send protected content with encryption. If HDCP is enabled on the input port of the transmitter, the source will send encrypted signal. The sink is not HDCP-compliant, thus it will not display the video signal (but blank/red/muted/etc. screen). If HDCP is disabled on the input port of the transmitter, the source will not send the signal to the transmitter. The solution is to replace the display device to a HDCP-capable one.

4. Installation

4.1. Connecting devices

When building an electronic system, make sure that all devices are powered down before connecting them. Powered on devices may have dangerous voltage levels that can damage sensitive electronic circuits. After the system is complete, connect the power cables to the extenders and to the power outlet; the units are immediately powered ON.

Info: If the transmitter and the receiver are linked by fiber optical cable, do not connect both to the same LAN, only one of them.

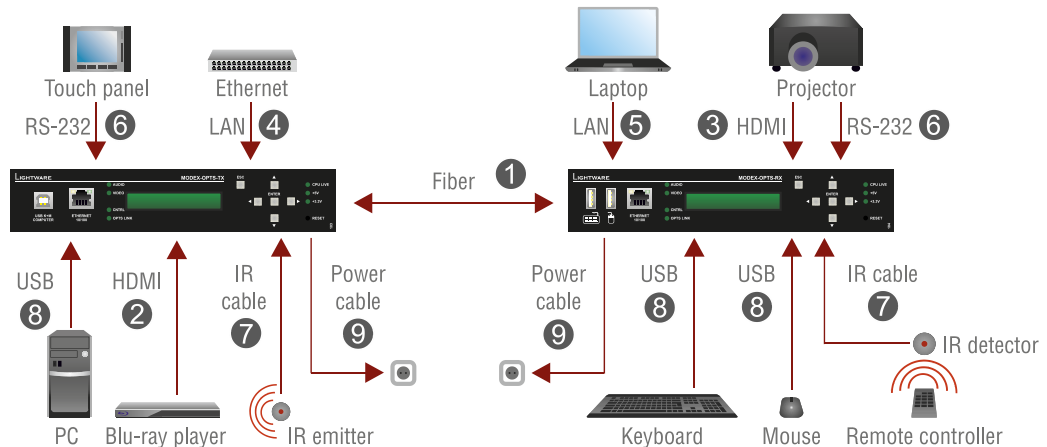

Figure 4-1. Connecting devices

- Step 1.** Connect the transmitter and the receiver by a multi- or single mode fiber cable. Connect channel A on transmitter to channel B on receiver.
- Step 2.** Connect a DVI or HDMI source (e.g. computer) to the transmitter's DVI or HDMI INPUT connector.
- Step 3.** Connect a DVI or HDMI sink (e.g. projector) to the receiver's DVI or HDMI output.
- Step 4.** Optionally connect the transmitter or the receiver to a Local Area Network in order to control the devices by the built-in Web page. More information about establishing the connection can be found in section [6.1.2](#) on page [36](#).
- Step 5.** Optionally connect Ethernet devices¹ (e.g. switch, laptop, computer etc.) to the available RJ45 connector(s) of the extender(s). All connected devices will work as if they are connected to the same network.
- Step 6.** Optionally for RS-232 extension¹:
 - Connect a controller unit (e.g. Touch panel) to the RS-232 port of the transmitter with a null modem serial cable.
 - Connect a controlled device (e.g. Projector) to the RS-232 port of the receiver with a regular serial cable.
- Step 7.** Optionally for Infra-Red extension¹:
 - Connect the supplied IR emitter to the IR OUT port of the transmitter or receiver.
 - Connect the supplied IR detector to the IR IN port of the transmitter or receiver.
- Step 8.** Optionally for USB HID extension:
 - Connect at least one USB HID device to the receiver.
 - Connect the transmitter to the computer by the USB-B cable.
- Step 9.** Power on the devices using the power cables.

¹ Mentioned devices are examples and can be connected to either transmitter or receiver.

4.2. Serial devices

4.2.1. General information about serial communication

There are two kind of devices in general serial communication from our aspect:

Data Terminal Equipment (DTE)

DTE is an end-instrument that converts user information into signals or reconverts received signals. Typical DTE devices: computers, LCD touch panels, control systems.

Data Circuit-terminating Equipment (DCE)

DCE is device that sits between the DTE and a data transmission circuit. It also called data communication equipment and data carrier equipment. Typical DCE devices: projectors, industrial monitors and amplifiers.

Among others the pin assignment is different between DTE and DCE and different type of serial cables have to be used between the serial devices.

	DTE	DCE
Pin2	RD	TD
Pin3	TD	RD

	DTE	DCE
DTE	Null-modem	Straight
DCE	Straight	Null-modem

Legend: RD=Received data; TD=Transmitted data

Table 4-1. Pin assignments and applicable serial cables

Serial cable types

Straight serial cable	Null-modem serial cable
Straight pin-outs on both ends	Straight pin-out at the one end and cross pin-out at the other end (interchange lines of TX and RX)

Table 4-2. Serial cable types

4.2.2. Example connection diagrams

Following cases are examples; devices may have different receptacles and pin-outs.

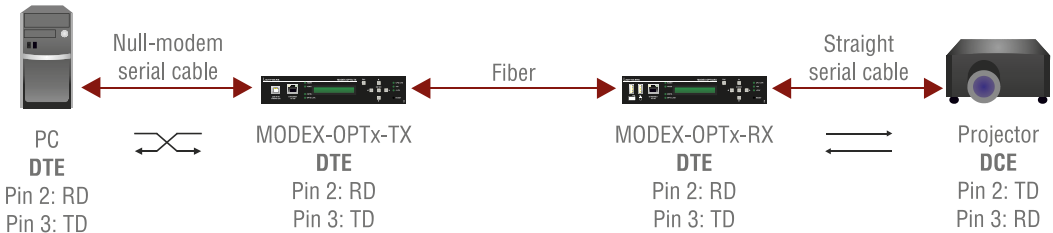

Figure 4-2. Extending RS-232 between computer (DTE) and projector (DCE)

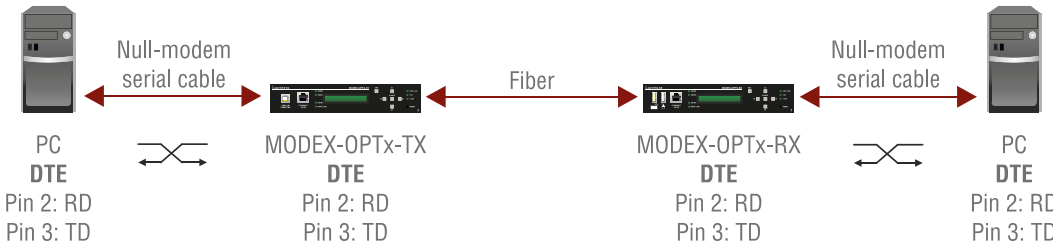

Figure 4-3. Extending RS-232 between computer (DTE) and computer (DTE)

4.3. Mounting options

Devices can be mounted in several ways, depending on the application. Besides using with rack shelf, a mounting bracket is available which offers easy mounting on truss systems with standard clamps or using the unit built into furniture.

Important! Pay attention to the ventilation holes when designing the system or the extender is built into/under furniture. Side ventilation holes must not be covered. If the ventilation of a MODEX extender is limited to a closed space, the designer shall provide satisfactory ventilation to prevent excessive heat build-up inside.

4.3.1. Rack shelf mounting (with 1U high rack shelf)

- Step 1.** Turn the unit upside down.
- Step 2.** Put the rack shelf upside down on the unit, and position it to get the mounting holes aligned.
- Step 3.** Fasten the unit on the rack shelf with the provided screws.
- Step 4.** Mount the rack shelf in the rack.



4.3.2. Truss mounting (with Mounting bracket V2)

- Step 1.** Fasten the mounting bracket on the side of the unit with the provided screws.
- Step 2.** Use a bolt to attach a standard clamp. (The clamp is not supplied with the device.)
- Step 3.** Mount the unit on the truss with the clamp.



4.3.3. Through furniture mounting (with Mounting bracket V2)

To get a good result, the thickness of the board should not exceed 25 millimeters.

- Step 1.** Cut a suitable hole in the board.
- Step 2.** Attach the mounting bracket on the side of the unit with the provided screws.
- Step 3.** Mount the unit on the board.
- Step 4.** Loosen the screws a little on the bracket and adjust the unit to line up with the front of the board.



5. Front panel operations

5.1. Front panel menu

The extenders have LCD menu and navigation buttons on the front panel. This can be used to change basic settings or display different information about the modules.

Navigation

Front panel LCD has 2 lines and 16 characters in each line. The name of the menu item is always displayed in the first line. If no button is pressed for 10 minutes, LCD returns to its idle state and Device information is shown.

Button	Function
▲ (up)	Toggle between menu items
▼ (down)	
◀ (left)	Move the cursor or step back to previous menu
▶ (right)	Move the cursor
◆ (enter)	Execute changes or enter submenu
◻ (escape)	Step back to previous menu

Menu structure

Info ↔ Settings ↔ Modules ↔ Crosspoints ↔ USB K&M ↔ EDID ↔ Presets

Info: The content of the underlined menu items depend on the installed modules.

Idle state (Device information)

If no button is pressed for 10 minutes or the user navigates out from the menu by the escape ◻ and/or the left ◀ button, LCD gets into idle state. Front panel menu displays the following information in idle state:

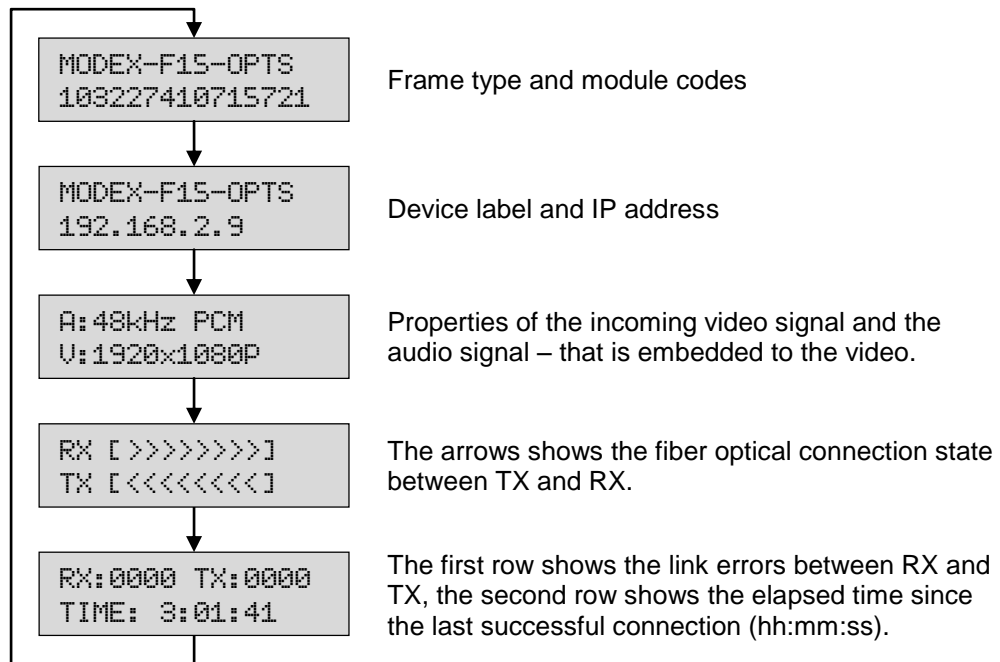

Locking

Modules can be locked by using the built-in website. If a module is locked, a closed padlock sign is displayed. Front panel menu can be locked as follows:

- **Lock LCD home screen:** The whole screen is locked, no front panel operations can be done, front panel buttons are disabled, Device information is displayed.
- **Disable setup from LCD menu:** Front panel operations are enabled, but settings cannot be changed, a closed padlock sign is displayed.

```

┌ IP Address:  ...
└ 192.168.002.20
    
```

Info: The locking/unlocking can be switched from the built-in website, see more information in section [6.9.6](#) on page [62](#).

5.2. Info menu

The Info menu displays basic information about the unit as follows:

- MCU Firmware version
- FPGA Firmware version
- Web content version
- Supply A (the power supply unit)
- Temperature – measured on the core module. If the temperature is above the Overheat limit, the speaker sounds, the unit reboots and the event is logged.

5.3. Settings menu

5.3.1. Network settings

If the extender is connected to an Ethernet Network, the settings are available in this submenu.



Info: If you change more settings in Network submenu, it is not necessary to restart the device after every step. Reboot after setting all necessary parameters is enough.

Setting the IP address

Step 1. Navigate to Settings / Network Settings / IP Address submenu and press the enter  button.



```

┌ Network Setting...
└ IP Address  ▶
    
```

Step 2. Use left  and right  buttons to place the cursor to the desired number.

```

┌ IP Address:  ...
└ 192.168.002.20
    
```

Step 3. Set the numbers by the up  and down  buttons.

Step 4. Press the enter  button to save changes.

```

Restart now?
ENTER=Yes ESC=No
    
```

Step 5. Press the enter  button to restart device (recommended).

Setting the Subnet mask

Step 1. Navigate to Settings / Network Settings / Subnet mask submenu and press the enter  button.

```

┌ Network Setting...
└ Subnet mask  ▶
    
```

Step 2. Use left  and right  buttons to place the cursor to the desired number.

```

┌ Subnet mask:  ...
└ 255.255.255.00
    
```

Step 3. Set the numbers by the up  and down  buttons.







Step 4. Press the enter  button to save changes.

```

Restart now?
ENTER=Yes ESC=No
    
```

Step 5. Press the enter  button to restart (recommended).

Setting the Static gateway

- Step 1. Navigate to Settings / Network Settings / Static gateway submenu, press the enter  button.
- Step 2. Use left  and right  buttons to place the cursor to the desired number.
- Step 3. Set the numbers by the up  and down  buttons.
- Step 4. Press the enter  button to save changes.
- Step 5. Press the enter  button to restart device (recommended).

```

*Network Setting
  |--Static Gateway
  
```





```

*Static Gateway:
  192.168.000.0#
  
```

```

Restart now?
ENTER=Yes ESC=No
  
```

DHCP setting

- Step 1. Navigate to Settings / Network Settings / DHCP submenu and press the enter  button.
- Step 2. Use the up  and down  buttons to toggle between Enabled and Disabled settings.
- Step 3. Press the enter  button to save changes.
- Step 4. Press the enter  button to restart device (recommended).

```

*Network Setting
  |--DHCP
  
```



```

*DHCP:
  Disabled
  
```

```

Restart now?
ENTER=Yes ESC=No
  
```

Renew the IP address

- Step 1. Navigate to Settings / Network Settings / Renew IP submenu and press the enter  or the right  button.
- Step 2. Press the enter  button to confirm.

```



*Network Setting
  |--Renew IP
  
```

```

Renew IP?
Enter=YES ESC=NO
  
```

5.3.2. System settings

Resetting the device

- Step 1. Navigate to Settings / System / Reset submenu and press the enter  button.
- Step 2. Press the enter  button to restart device or the escape  button to cancel.
- Step 3. The extender is immediately restarted.

```



*System
  |--Reset
  
```

```

Restart Device?
ENTER=Yes ESC=No
  
```

Enter bootloader mode

Firmware upgrade of the device can be executed only in Bootload mode. If the working mode of the device is not switched to bootload mode automatically, the mode can be also switched manually.

- Step 1. Navigate to Settings / System / Enter bootloader submenu and press the enter  button.
- Step 2. Press the enter  button to switch to Bootload mode.
- Step 3. LCD will turn to dark. (The device can be switched to normal operation mode by pressing the reset button or turning it off and on again.)

```

*System
  |--Enter bootlo
  
```



```

Enter Bootload?
ENTER=Yes ESC=No
  
```

```

-----
  
```

Loading factory defaults

- Step 1. Navigate to Settings / System / Fact. defaults submenu and press the enter  button.
- Step 2. Press the enter  button to load factory defaults or the escape  button to cancel.
- Step 3. The device is restarted; factory default settings and parameters are set. See the list about the details in section [11.2](#) on page [111](#).

```

*System
  |--Fact. default
  
```

```

Fact. defaults?
ENTER=Yes ESC=No
  
```

5.4. Modules menu

This menu contains information and certain settings of the modules. The menu shows only the installed modules. Each module contains two submenus:

- Info: Contains basic information about the module: Part number, Hardware version and Serial number.
- Settings: Different module by module (see the following sections).

5.4.1. MODEX-PH-OPTS

Info

The followings are listed about core module – besides basic information:

- Firmware ID: Firmware version of the integrated optical module.
- Link quality: If the Link measurement is enabled in the Settings submenu, link quality between transmitter and receiver is displayed in brackets; if the link is not established, the brackets are empty. This is also shown in idle state; for more information see section [5.1](#) on page [29](#).
- Link errors: Number of Link errors is shown in the other submenu, which means the occurrences of link problems (e.g. unsure connection) between the extenders. This is tracked only when Link measurement is enabled.

Settings

- Link measurement: The link quality between transmitter and receiver can be checked when Link measurement option is enabled in this submenu. Link quality and Link errors are displayed in the Info submenu.

5.4.2. MODEX-AV-HDMI-OM and MODEX-AV-HDMI14-OM

Settings

- Video: The following parameters of the output video port can be set:
 - HDMI mode: Auto / DVI / HDMI 24bit / HDMI 30 bit / HDMI 36 bit
 - Color space: Auto / RGB / YUV 4:4:4 / YUV 4:2:2
 - HDCP mode: Auto / Always
When the HDCP mode is set to Always, the signal on the output is encrypted regardless of the incoming signal. When the mode is set to Auto, the output is encrypted only if the content is protected.
 - Color range: Auto / Compress / Expand
Some sources may send the video signal with different color range. If the black or white level seems to be incorrect in the picture try to set this parameter to compress or expand the color range.

Info: Changed settings are saved immediately when selecting by the buttons.

5.4.3. MODEX-AV-HDMI-DVI-IM and MODEX-AV-HDMI-DVI-4K-IM

Settings

- Input port: Active video input port can be selected by this setting (DVI or HDMI).

Step 1. Select the desired port by the up  and down  buttons.

Step 2. Press the enter  button to save settings.

Info: If the module is locked, active input port cannot be changed.



5.4.4. MODEX-IF-AUD

Settings



- Application mode: Basic working mode can be set; for details about application modes see section [6.4.3](#) on page [43](#).
 - (0) Analog ↔ Emb. & Ret. Aux (default): Analog audio to Main audio Group, S/PDIF to S/PDIF Audio Group (see section [6.4.3.1](#) on page [43](#)).
 - (1) Analog ↔ Forw. & Ret., S/: Analog audio to S/PDIF Audio Group, S/PDIF disabled (see section [6.4.3.2](#) on page [44](#)).
 - (2) S/PDIF → Emb., Analog not: S/PDIF audio in to Main Audio Group, Analog audio disabled (see section [6.4.3.3](#) on page [45](#)).

Changes are stored automatically without pressing the enter  button.

- Analog in: Certain parameters of the input signal can be adjusted as follows:
 - Gain: from 0 dB to +24 dB, step 3 dB (default is 0 dB)
 - Volume: from 0 dB to -63 dB, step 0.5 dB (default is 0 dB)
 - Balance: from 0 to 100%, step 1% (default is 50%=center)

Use the up  and down  buttons to change values. Changes are stored automatically without pressing the enter  button.

- Analog out: Certain parameters of the output signal can be adjusted as follows:
 - Volume: from 0 dB to -52 dB (step 0.5 dB), from -54 dB to -66 dB (step 2 dB); -69 dB; -72 dB; -78 dB (default is 0 dB)
 - Balance: from 0 to 100%, step 1% (default is 50%=center)

Use the up  and down  buttons to change values. Changes are stored automatically without pressing the enter  button.

5.4.5. MODEX-IF-RS232-IR

Settings

- RS232:
 - Baud rate: 2400 / 4800 / 9600 / 19200 / 38400 / 57600 / 115200 / 128000 / 153600 / 230400 / 256000
 - Data bits: 5 / 6 / 7 / 8 / 9
 - Stop bits: 1 / 1.5 / 2
 - Parity: None / Odd / Even / Mark / Space
- IR Input
 - Carrier frequency: from 30.000 to 200.000 Hz, step 500 Hz (default is 38.000 Hz)
- IR Output
 - Carrier frequency: from 30.000 to 200.000 Hz, step 500 Hz (default is 38.000 Hz)

Use navigation buttons to change values and press the enter  button to store the new settings.

5.5. Crosspoints menu



The following simple operations can be done in the Crosspoints menu:

- port locking/unlocking,
- port muting/unmuting,
- output switching.

These features are available at the audio and video ports that are installed in the given MODEX.

5.6. USB K&M menu

Connected USB devices' state and basic information are displayed in this menu.

HS USB port: , FS USB port: 

- Manufacturer
- Product
- Serial
- VID
- PID
- 5V present: (True / False) – only in TX units.
- Device state: (Disconnected / Suspended / Enumerated / Connected) – only in TX units.
- Host info: HID / Free – only in RX units.





5.7. EDID menu (transmitter)

Available input ports are listed in the EDID menu of the transmitter. If there is a DVI and an HDMI input port on the AV module, both will be listed. Currently emulated EDID can be set on each port.

5.7.1. Viewing and changing the emulated EDID

Step 1. Navigate to EDID menu and press the enter  button.





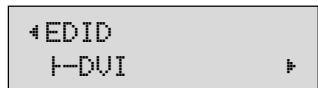

Step 2. Select the desired port by the up  and down  buttons, than press the enter  or the right  button.

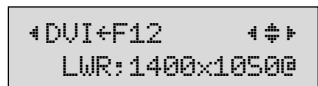

Step 3. Currently emulated EDID is shown. In the first line the selected port and the source of the EDID is shown. On attached figure factory EDID nr. 12 is emulated on DVI input port. The second line is scrolled automatically to display more information about the EDID: the manufacturer code, the resolution with the refresh rate and the sink type.



Step 4. Use the left  and right  buttons to select EDID group: Factory EDIDs (F) / User EDIDs (U) / Dynamic EDID (D). Use the up  and down  buttons to select the desired EDID (keep the button pressed to scroll the list faster). The second line of the LCD is scrolled automatically to display more information about the EDID. See more information about EDID structure in section [6.6.1](#) on page [50](#).

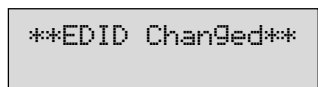

Step 5. Press the enter  button to emulate selected EDID on the input port.

5.8. EDID menu (receiver)

The available video output port is displayed in the EDID menu of the receiver. The EDID of the last attached sink is shown in this menu.

```
◀HDMI◀D1
  USC:1600x1200@
```

In the first line the output port (D1, Dynamic EDID) is shown. The second line is scrolled automatically to display more information about the EDID: manufacturer code, resolution with refresh rate and sink type.

Info: Attached monitor's EDID is stored automatically, until a new monitor is attached to that particular output. In case of powering the unit off, last attached monitor's EDID remains in non-volatile memory even if the monitor is unconnected.



5.9. Presets menu

Each MODEX extender has eight preset memories which can be used to store LW3 commands (settings and configurations). This feature allows to set the MODEX with previously determined parameters, execute a group of commands, etc... Presets can be organized via the built-in web easily, see section [6.9.5](#) on page [61](#), but the preset can be applied (run) via the front panel, too.



5.9.1. Applying a preset

Step 1. Navigate to the Presets menu and press the enter  button.

```
◀Presets
  ↳Process Pres▶
```

Step 2. Select the Process preset submenu and press the enter , or the right  button.

```
◀Process Preset:
  Preset 1 ▾
```

Step 3. Select a preset by the up  and down  buttons.

```
Preset Processed
```

Step 4. Press the enter  button to apply the preset.

6. Web control – Using the built-in website

MODEX extenders have several configuration options. More settings are available using the built-in website than on the front panel. Connection can be established to the website through any Ethernet connector of the MODEX.

6.1. Network structure

MODEX extenders have a front panel Ethernet port. Additional rear-side Ethernet connectors are available on MODEX-IF-ETH interface module. All the connectors and the controller entity belong to the same network inside the MODEX. Ethernet link is also transferred to the connected pair via physical layer link. Connect any RJ45 connector of the transmitter or the receiver to a LAN and you can control both units.

Info: Do not connect more than one port of a MODEX to the same LAN to avoid loops. In the same way; if a MODEX transmitter and a receiver are linked by fiber optical cable, do not connect both to the same LAN, only one of them.

6.1.1. IP settings

Before you connect to a MODEX extender using a Web browser the IP address must be set. The Ethernet port can be configured on the front panel LCD menu or remotely through the built-in website. There are three different ways to configure the IP address.

Set the factory default static IP address

MODEX extenders have static IP settings at the first startup. You can reload these settings to the default state by the LCD menu (Settings / System / Factory Default). For detailed information about this step see section [5.3.1](#) on page [30](#). Factory default IP addresses are described in section [11.2](#) on page [111](#).

Set a user-defined static IP address

IP address, Subnet mask and Static gateway can be set by the user on front panel LCD menu (Settings / Network Settings). For detailed information about this step see section [5.3.1](#) on page [30](#).

Set a dynamic IP address

DHCP mode can be enabled on the front panel LCD menu (Settings / Network Settings / DHCP). The extenders acquire IP addresses from the DHCP server on the LAN in this case. For detailed information about this step see section [5.3.1](#) on page [30](#).

6.1.2. Establishing the connection

To connect to a MODEX launch a web browser and type the IP address. You can verify the actual address of the MODEX unit on its front panel display (Settings / Network).

Info: Built-in webpage can be opened at most in 4 different browser tabs simultaneously.

System requirements

Operating System: Microsoft Windows XP, Windows Vista, Windows 7, Mac OS X, or Linux.

Web Browser: Mozilla Firefox, Apple Safari (Microsoft Internet Explorer is not supported).

6.2. Layout of built-in web

After the connection is established Crosspoint menu appears by default. Device selector indicates which device has been connected to. This is the local device. In this window remote device can be selected. Both devices must be configured for appropriate transfer. There are three tabs in main menu: Crosspoint, EDID and Settings.

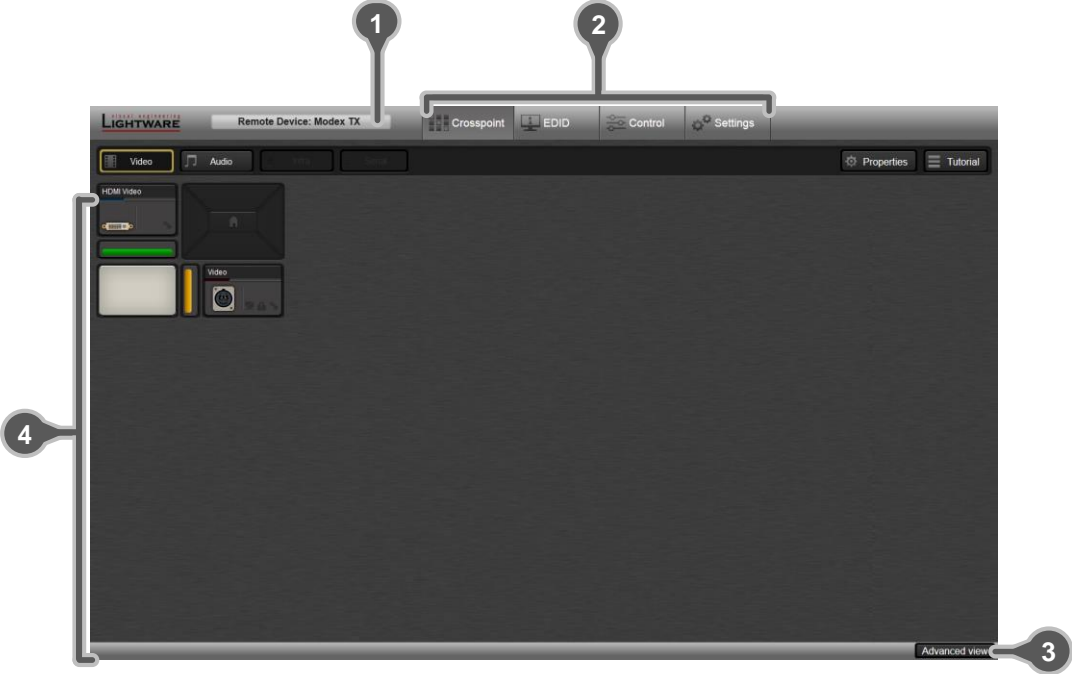

- 1 Device selector Selecting Local or Remote Device by clicking the grey tab; it will be loaded in the browser window.
- 2 Main menu Displaying Crosspoint, EDID, Control or Settings from the main menu.
- 3 Advanced view button Displaying Advanced view page, showing the terminal window and the protocol tree.
- 4 Active area Displaying the content of the selected menu and module.

Local and remote control



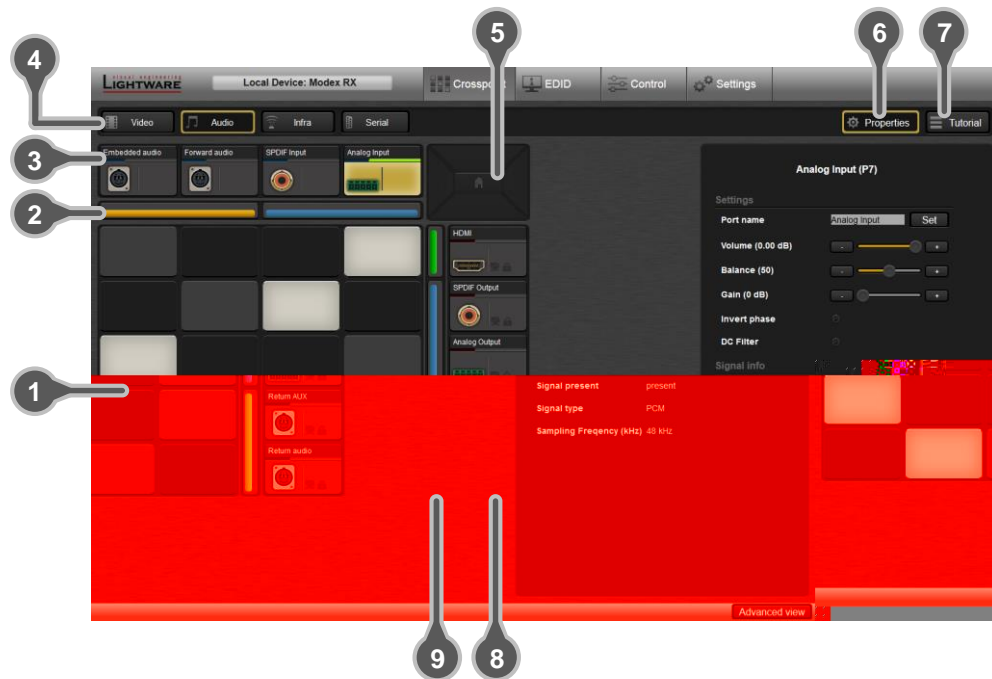

When the transmitter and the receiver are linked by a fiber cable and one of them is connected to a LAN, the other extender can be also controlled. In this case the extender that is connected by the LAN cable is the Local Device, the other extender is the Remote Device.

6.3. Crosspoint menu



- | | |
|--|---|
| <p>1 Crosspoint panel</p> | <p>Displaying connections between the input and output ports:</p> <p>Dark tiles: Connection is not possible.</p> <p>Grey tiles: Connection is possible but not established.</p> <p>White tiles: Connection is established.</p> |
| <p>2 Input module properties</p> | <p>Each color bar represents a module. Properties window appears displaying information and settings about the given input module by clicking on the colored bar.</p> |
| <p>3 Input ports</p> | <p>Displaying available input ports of the selected layer.</p> |
| <p>4 Layers</p> | <p>Showing the available layers as submenus; they depend on the installed interface modules.</p> |
| <p>5 Navigation buttons</p> | <p>If the window is smaller than required, input and/or output ports may not fit in the available area. Thus the arrows on this button get activated and the ports can be scrolled. Clicking in the middle icon restores the original layout (crosspoint is arranged to the left top corner).</p> |
| <p>6 Properties button</p> | <p>Showing the properties of selected port by toggling the button (or click on a port by the left mouse button).</p> |
| <p>7 Tutorial button</p> | <p>Displaying MODEX tutorial in the appearing window containing the most important descriptions shortly.</p> |
| <p>8 Output ports</p> | <p>Displaying available output ports of selected layer.</p> |
| <p>9 Output module properties</p> | <p>Each color bar represents a module. Properties window appears displaying information and settings about the given output module by clicking on the colored bar.</p> |

Icons on the ports:

- | | |
|---|--|
|  HDCP is enabled and the signal is encrypted (black) |  HDCP is disabled or the signal is not encrypted (grey) |
|  Port is muted (black) |  Port is unmuted (grey) |
|  Port is locked (black) |  Port is unlocked (grey) |

6.3.1. Video crosspoint

The number of the inputs and the outputs are depending on the number and the direction of the video modules. As MODEX supports only one video transmission over the link, the link appears as an input or as an output depending on the direction of the extender.

At the transmitter side the link appears as an output. At the receiver side the link appears as an input.

Example

The figure shows one input and one output. HDMI is the input port and the output port is the fiber optical connector – towards to the receiver. In this case there is no real crosspoint switching, the signal of the input port is always switched to the output port (except if the output is muted).



6.3.2. Audio crosspoint

MODEX extenders support two audio groups: the Main audio group and the S/PDIF audio group. These groups are independent from each other. In this case there are forbidden crosspoint connections. The link can support four audio layers:

Main audio group:

- Embedded audio (from transmitter to receiver)
- Return AUX (from receiver to transmitter)

S/PDIF audio group:

- Forward Audio (from transmitter to receiver)
- Return Audio (from receiver to transmitter)

At the transmitter side the Embedded audio and the Forward Audio appears as an output, the Return Audio and the Return AUX appears as an input. At the receiver side the direction is the opposite.

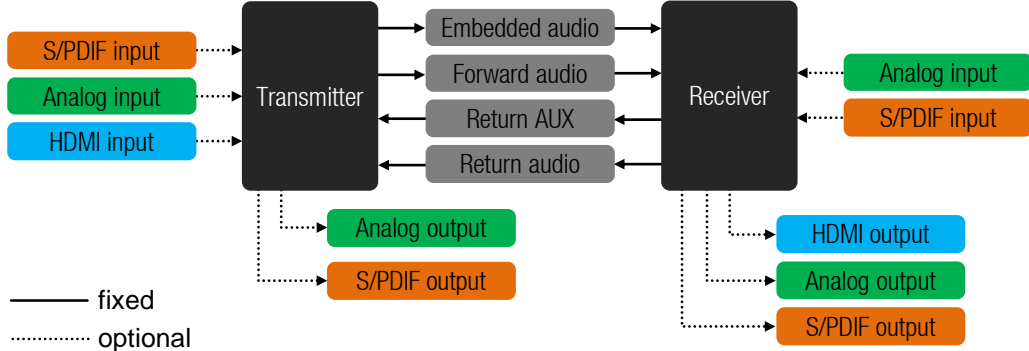

Figure 6-1. Audio layers

The four audio layers, between the transmitter and the receiver are defined and fixed, always extended. The other audio inputs and outputs are optional and depend on the installed interface modules; the available crosspoint settings depend on the application mode set in the properties of the audio module.



Figure 6-2. Audio crosspoint

Example

Above screenshot was made of a MODEX transmitter’s Audio crosspoint layout (assembled with MODEX-IF-AUD module). Settings are according to section [6.4.3.1](#) on page [43](#).

The following connections are established:

- HDMI audio input port is switched to Analog Output and to Embedded audio,
- S/PDIF input port is switched to S/PDIF output port,
- Return audio is switched to Forward audio.

Info: To have the desired audio crosspoint setup, check the settings in both extenders.

6.3.3. Infra crosspoint

All infrared inputs are transmitted to the remote device all the time. As the data of all infra input ports can be transmitted via the link, the link does not appear as an output as it appears in the video or in the audio crosspoint. The input port with a link icon symbolizes the input of the remote side.

The number of the available ports in a unit is determined as follows:

Number of inputs = Number of inputs [local unit] + Number of inputs [remote unit]

Number of outputs = Number of outputs [local unit]

Info: The selection should be done on the local device which infra source(s) has/have to be output on a local infra port.

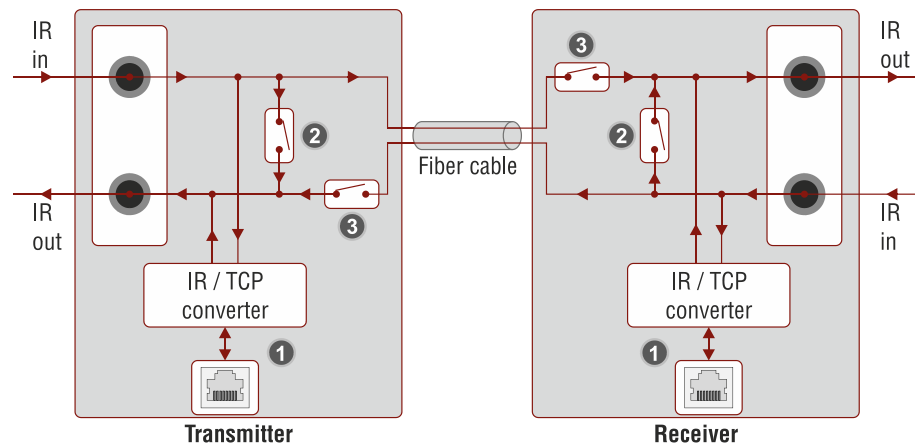
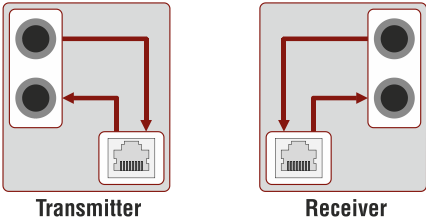

Figure 6-3. Signal path of IR data

1 Command injection

Signal path:



Shown in LDC: (port properties)

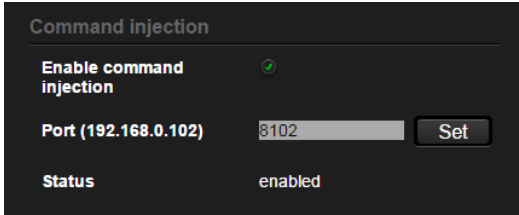

Signal transmission between local IR input/IR output ports and local IP port.

2 Loopback

Signal path:

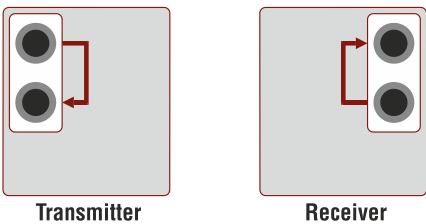

Shown in LDC: (IR crosspoint)



Signal transmission between local IR input and local IR output ports. The white tile means the ON state of the switch – the loopback of local IR ports is activated.

3 Extended data

Signal path:

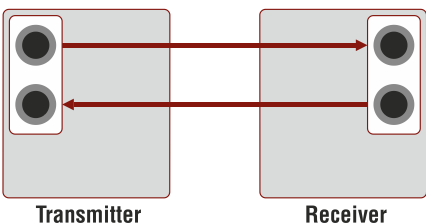

Shown in LDC: (IR crosspoint)



Signal transmission between local and remote devices. The white tile means the ON state of the switch.

Info: The working method is similar when more IR input and output ports are assembled in the MODEX, e.g. 2 pcs. MODEX-IF-RS232-IR interface modules (with 2 pcs. IR input and 2 pcs. IR output). But in that case the number of the signal path is multiplied.

6.3.4. Serial crosspoint

In crosspoint view every serial port appears as an input and an output. It means that Tx data channel of the port is an input and Rx data channel is an output – within one port.

All serial inputs are transmitted to the remote device all the time. As the data of all serial ports can be transmitted via the link, the link does not appear as an output as it appears in video or in audio crosspoint. The input port with a link icon symbolizes the input of the remote side. The serial source switched to the local output can be selected on the local device.

The number of the available ports in a unit is determined as follows:

Number of inputs = Number of the ports [local unit] + Number of the ports [remote unit]

Number of outputs = Number of the ports [local unit]

If an input is switched to an output, and both the input and the output belongs to the same serial port connector, that results an internal loopback. This way the serial link can be tested between the source device and the MODEX.

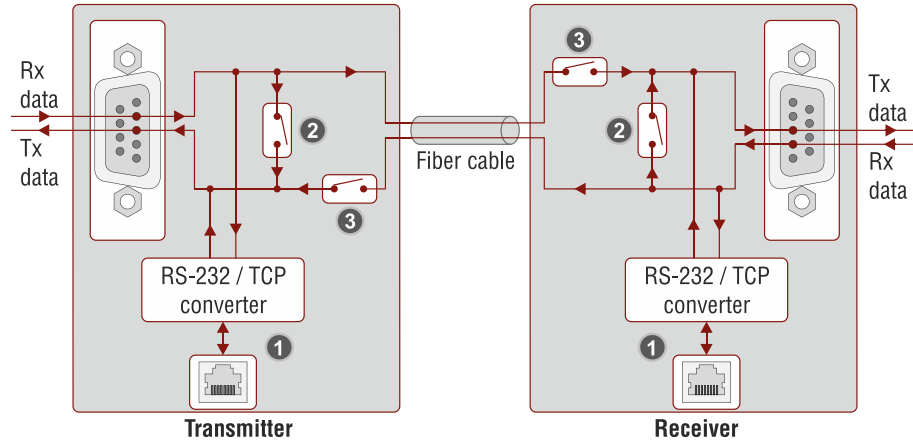
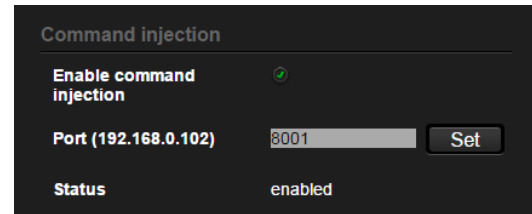
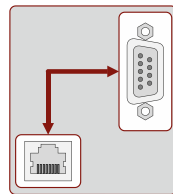
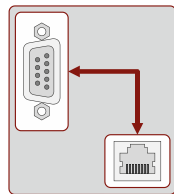

Figure 6-4. Signal path of serial data

1 Command injection

Signal path:

Shown in LDC: (port properties)



Signal transmission between local Tx/Rx pins and local IP port.

2 Loopback

Signal path:

Shown in LDC: (serial crosspoint)

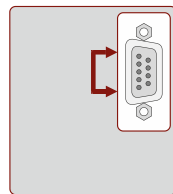
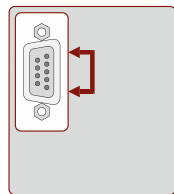

Signal transmission between local Tx and Rx pins. The white tile means the ON state of the switch – the loopback of local UART port is activated.

3 Extended data

Signal path:

Shown in LDC: (serial crosspoint)

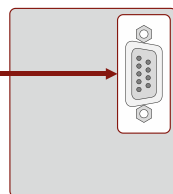
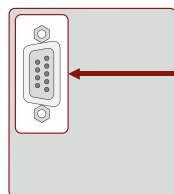

Signal transmission between local and remote devices. The white tile means the ON state of the switch.

Info: To have a bidirectional connection the link must be enabled in both extenders.

Info: The working method is similar when more RS-232 ports are assembled in the MODEX, e.g. 2 pcs. MODEX-IF-2xRS232 interface modules (with 2 x 2 pcs. RS-232 ports). But in that case the number of the signal path is multiplied.

6.4. Module properties and settings

General

General information is displayed about the module: Module name, Part number, Hardware version, Serial number and further module-dependent information and settings.

Settings

Each MODEX modules – including video-, interface- and physical link modules – have their special property list. Related ports are indicated by the color of the module property bar. Different color means different module. Left click on Module property bar to open module property window.

6.4.1. Optical link quality

The properties panel of MODEX-PH-OPTx module contains a feature that gives information about the optical link quality between the extenders. (Scroll down in the window and the section will be visible.) If the radio button is checked, link quality measurement is in progress (data is collected in the background). If the button is unchecked, error counter is reset to 0.

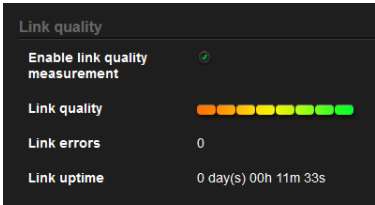

Info: If the module is locked, link quality measurement cannot be enabled or disabled.

6.4.2. Video modules

Certain video modules have more than one video inputs or outputs, but only one of these inputs or outputs can be used in video crosspoint. The reason is that only one video stream transmission is permitted between the core module and the video module. Under Settings there is a Mode selector which activates the interface. The active input or output port of selected mode appears in video crosspoint and the port property becomes available.

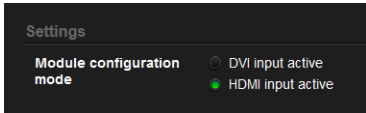

Info: If the module is locked, the active interface cannot be changed.

6.4.3. Audio modules

There is a mode selector under Settings of Audio modules. Each audio port can be assigned to one of the two audio groups (Main or S/PDIF) using mode function. After setting the mode of the audio interface module, the supported input and/or output port of the selected mode appears in audio crosspoint and the port property window becomes available.

Info: This setting can be set in the transmitter and in the receiver separately.

Info: If the module is locked, the audio interface mode cannot be changed.

6.4.3.1. Analog audio to Main Audio Group, S/PDIF to S/PDIF group

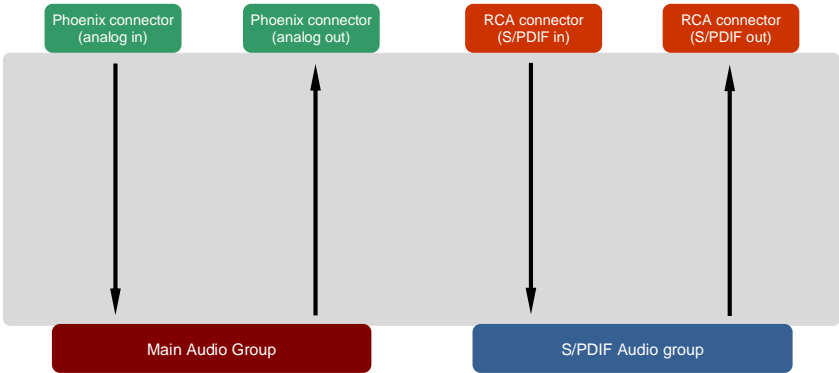

Available connections

Transmitter					
Return AUX	Return audio	HDMI	Analog Input	S/PDIF input	
✓		✓	✓		Analog output
	✓			✓	S/PDIF Output
✓		✓	✓		Embedded audio
	✓			✓	Forward audio

Table 6-1. Available connections (when setting in the transmitter)

Receiver				
Embedded audio	Forward audio	Analog Input	S/PDIF input	
✓		✓		HDMI
✓		✓		Analog output
	✓		✓	S/PDIF Output
✓		✓		Return AUX
	✓		✓	Return audio

Table 6-2. Available connections (when setting in the receiver)

6.4.3.2. Analog audio to S/PDIF Audio Group, S/PDIF disabled

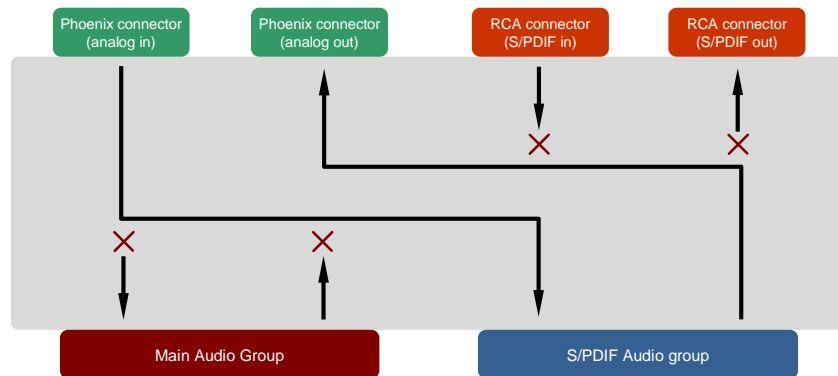

Available connections

Transmitter				
Return AUX	Return audio	HDMI	Analog Input	
	✓		✓	Analog output
✓		✓		Embedded audio
	✓		✓	Forward audio

Table 6-3. Available connections (when setting in the transmitter)

Receiver			
Embedded audio	Forward audio	Analog Input	
✓			HDMI
	✓	✓	Analog output
✓			Return AUX
	✓	✓	Return audio

Table 6-4. Available connections (when setting in the receiver)

6.4.3.3. S/PDIF audio in to Main Audio Group, Analog audio disabled

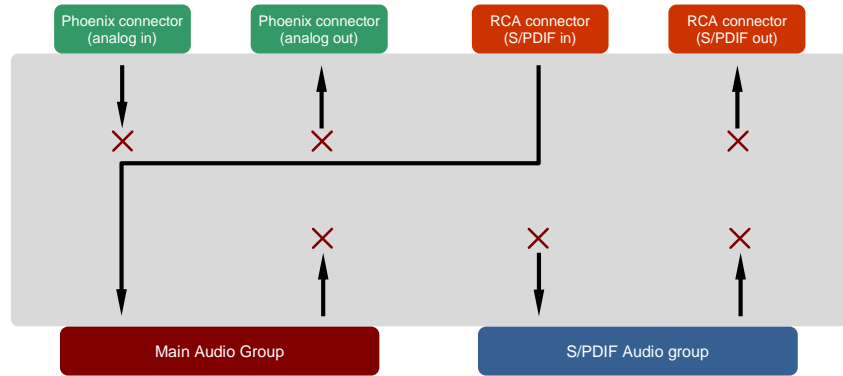

Transmitter				
Return AUX	Return audio	HDMI	S/PDIF input	
✓		✓	✓	Embedded audio
	✓			Forward audio

Table 6-5. Available connections (when setting in the transmitter)

Receiver			
Embedded audio	Forward audio	S/PDIF input	
✓		✓	HDMI
✓		✓	Return AUX
	✓		Return audio

Table 6-6. Available connections (when setting in the receiver)

6.4.3.4. S/PDIF audio out from Main Audio Group, Analog audio disabled

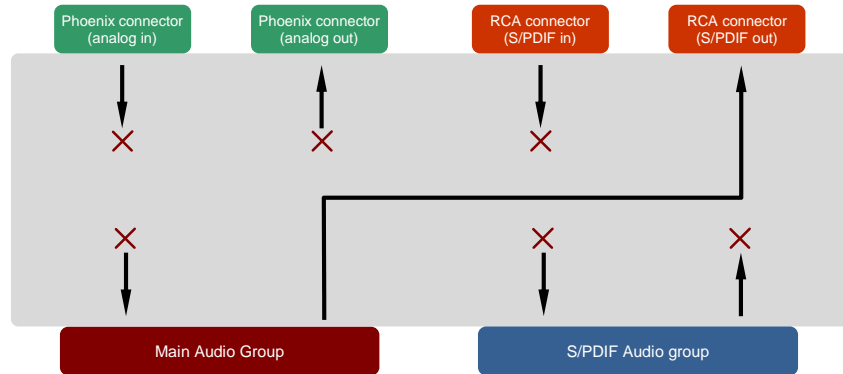

Transmitter			
Return AUX	Return audio	HDMI	
✓		✓	S/PDIF output
✓		✓	Embedded audio
	✓		Forward audio

Table 6-7. Available connections (when setting in the transmitter)

Receiver		
Embedded audio	Forward audio	
✓		HDMI
✓		S/PDIF output
✓		Return AUX
	✓	Return audio

Table 6-8. Available connections (when setting in the receiver)

6.5. Port properties and settings

Left click on Port property icon to open Property window. The physical port, the input and the output ports have different property windows. Status information about the port and signal information about incoming and outgoing signals are displayed in the property window. At the same time it gives the opportunity to set parameters, rename a port or access special functions – e.g. Frame detector at input port side.

Muting (only on output ports)

Outputs can be easily muted by clicking on the button Unmuted. If the output is muted, button text is Muted. When a port is muted, no signal is present on the output.

Locking (only on input ports)

Outputs can be easily locked by clicking on the button Unlocked. If the output is locked, button text is Locked.

Info: If the port is locked, its mute state cannot be changed neither by the button, nor by loading a preset.

Port name

The name of a port can be changed by typing the new name and clicking the *Set* button. The change will be visible on the port button and on front panel menu.

The following characters are allowed when naming:

Letters (A-Z) and (a-z), hyphen (-), underscore (_), numbers (0-9) and dot (.).

Frame detector (on video input ports)

Input ports can show detailed information about the signal like blanking intervals and active video resolution. This feature is a good troubleshooter if compatibility problems occur during system installation. To access this function, open parameter window for the input port on which the signal has to be checked. Click on Frame Detector button to show detailed timings.

Frame detector

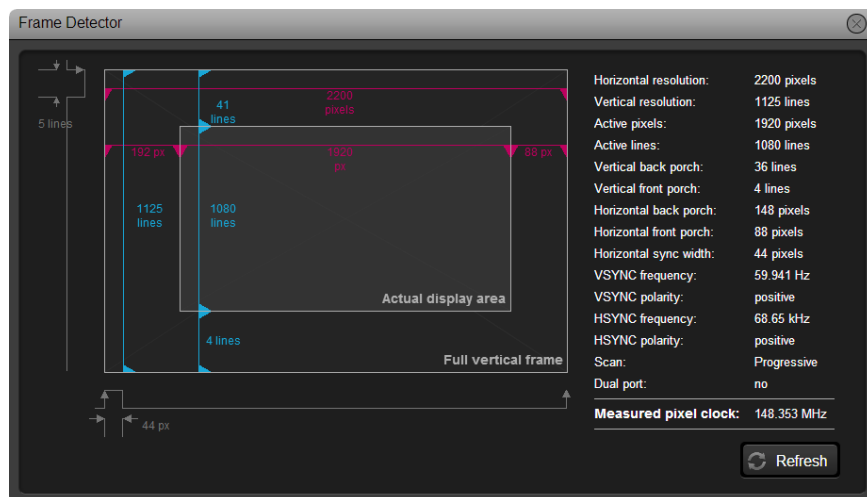

Figure 6-5. Frame detector window

Lightware's frame detector function works like an input signal analyzer and makes possible to determine the exact video format that is sent by the source, thus helps to identify many problems. E.g. actual timing parameters may differ from the expected and this may cause some displays to drop the picture.

Frame detector measures detailed timings on the matrices' incoming video signals just like a built-in oscilloscope, but it is much more easy to use. Actual display area shows the active video size (light gray). Dark gray area of the full frame is the blanking interval which can contain the info frames and embedded audio data for HDMI signals. Shown values are measured actually on the signal and not retrieved only from the HDMI info frames.

6.5.1. Analog audio input port

Certain parameters of analog audio input signal can be adjusted as follows:

- Volume:
from 0 dB to -52 dB (step 0.5 dB), from -54 dB to -66 dB (step 2 dB); -69 dB; -72 dB; -78 dB (default is 0 dB)
- Balance:
from 0 to 100%, step 1% (default is 50%=center)
- Gain:
from 0 to 24 dB, step 3 dB (default is 0 dB)
- Invert phase: enabled/disabled
- DC filter: enabled/disabled

Current values are displayed in brackets.



6.5.2. Analog audio output port

Certain parameters of analog audio output signal can be adjusted as follows:

- Volume:
from 0 dB to -52 dB (step 0.5 dB), from -54 dB to -66 dB (step 2 dB); -69 dB; -72 dB; -78 dB (default is 0 dB)
- Balance:
from 0 to 100%, step 1% (default is 50%=center)
- Bass:
from 0 to 24, step 2 (default is 0)
- Treble:
from 0 to 6, step 2 (default is 0)
- Invert phase: enabled/disabled

Current values are displayed in brackets.

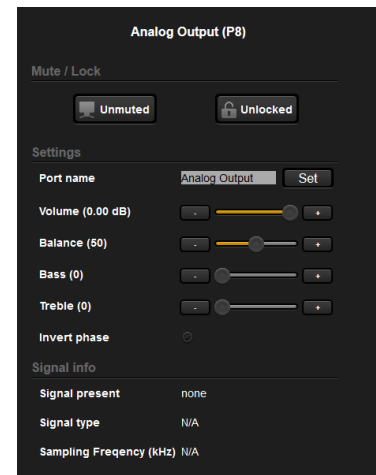

6.5.3. HDMI output port

The properties panel of HDMI output port contains the following adjustable settings:

- HDMI mode:
Auto / DVI / HDMI 24 bit / HDMI 30 bit / HDMI 36 bit
- Color space:
Auto / RGB / YCbCr 4:4:4 / YCbCr: 4:2:2
- Color range:
Auto / Compress / Expand
- HDCP:
Auto / Always

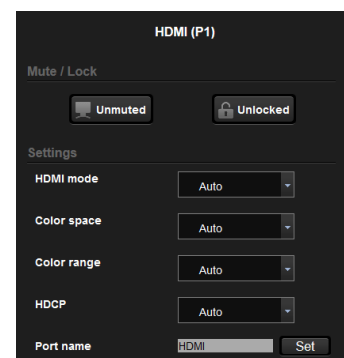

6.5.4. HDMI input port

Only one setting belongs to HDMI input port: HDCP can be enabled or disabled.

6.5.5. SDI port

SDI channel configuration window can be displayed by pressing its button on properties panel.

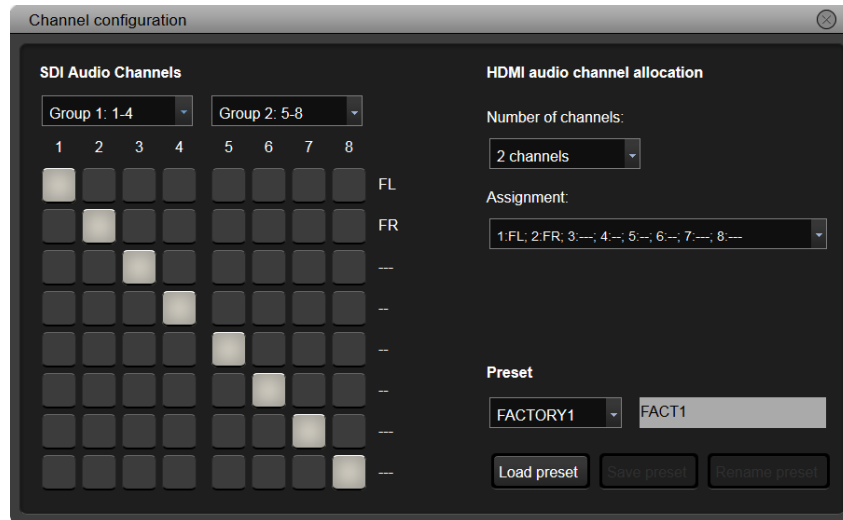
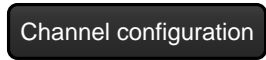

Figure 6-6. SDI Channel configuration

SDI Audio Channels

SDI signal can carry up to 16 audio channels – 8 of them can be allocated to dedicated channels in line with HDMI audio channel allocation settings. Select the two groups from the drop-down menus and click on a cube to connect the channels. (Same groups cannot be selected at the same time.)

Info: Channel assignment is not changed on the cubes when another group is selected from the drop-down menu – layout of the cubes remains unchanged.

HDMI audio channel allocation

Number of channels can be selected from 2 to 8 channels:

Number of channels	Assignment
2	1:FL; 2:FR
3	1:FL; 2:FR; 3:LFE
4	1:FL; 2:FR; 3:LFE; 4:FC
5	1:FL; 2:FR; 3:LFE; 4:FC; 5:RL
6	1:FL; 2:FR; 3:LFE; 4:FC; 5:RL; 6:RR
7	1:FL; 2:FR; 3:LFE; 4:FC; 5:RL; 6:RR; 7:RLC
8	1:FL; 2:FR; 3:LFE; 4:FC; 5:RL; 6:RR; 7:RLC; 8:RRC, or 1:FL; 2:FR; 3:LFE; 4:FC; 5:RL; 6:RR; 7:FLC; 8:FRC

Table 6-9. HDMI audio channel allocation

Preset

Preset memories can be used to store SDI audio settings and configurations. There are 4 factory and 5 user programmable preset memories. Factory presets cannot be changed, and cannot be renamed. User programmable preset memories can be saved, changed, loaded and renamed as well.

Info: Preset memory stores the full configuration of SDI audio settings: channel allocation and assignments.

6.5.6. IR port

General

- Carrier frequency [kHz] (set according to the needs of the IR device). The value can be set between 30 and 200 kHz with one decimal, further digits are truncated. E.g. if typed value is '37.52', saved value is '37.5'. Default value is 38.0 kHz.
- Port name, which will be visible on its button and in Modules of front panel menu.)

Info: When using the supplied IR units, the incoming signal is demodulated by the IR receiver and MODEX got a baseband signal. The carrier frequency value – set on the input – will be used to encode the IR signal; the value – set on the output – will be used to interpret the encoded signal.

Command injection

When a port is in command injection mode, it works as an IR-Ethernet converter (bidirectional); the Ethernet packets are converted to IR signal and vica versa.

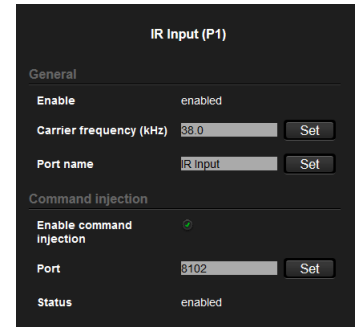

6.5.7. RS-232 port

Port name can be set, which will be visible on its button and in Crosspoint settings of front panel menu.

General

- Baud rate: 2400 / 4800 / 9600 / 19200 / 38400 / 57600 / 115200 / 128000 / 153600 / 230400 / 256000 baud
- Data Bits: 5 / 6 / 7 / 8 / 9
- Stop Bits: 1 / 1.5 / 2
- Parity: None / Odd / Even / Mark / Space

Command injection

When the device is in RS-232 command injection mode, it works as an RS-232-Ethernet converter (bidirectional). On these ports the Ethernet packets are converted to RS-232 data and vica versa.

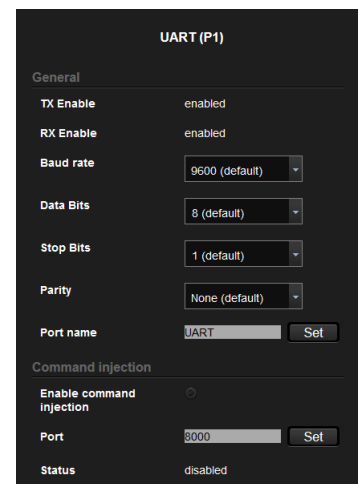

6.6. EDID menu

6.6.1. About EDID memory (transmitter)¹

EDID memory is non-volatile and consists of four blocks, each for different purposes:

- Factory preset EDIDs
- User-saved EDIDs
- Dynamic EDID (EDID of last connected sink on the output port)
- Emulated EDIDs (EDID currently emulated on a specific input port)

EDIDs are numbered from 1 in each block. They can be referred as the first letter of the block name and the number of the desired EDID. This way F02 refers to the second factory preset EDID.

Dynamic and emulated EDID blocks' size depends on the A/V modules. EDID memory structure is the following:

- F01..F119..... Factory Preset EDIDs
- U01..U31 User programmable memories
- Dxx Last attached monitor's EDID (output)
- Exx Emulated EDID (input)

Dynamic, factory and user EDIDs can be switched and emulated at the input(s).

Info: Factory EDIDs (Fxx) are factory preprogrammed and cannot be modified. These are the most commonly used resolutions. The EDID list can be found in section 11.3 on page 112.

Info: MODEX can handle both 128 Byte EDID and 256 Byte extended EDID structures.

Info: Attached monitor's EDID is stored automatically, until a new monitor is attached to that particular output. In case of powering the unit off, last attached monitor's EDID remains in non-volatile memory even if the monitor is disconnected.

6.6.2. EDID types

Most of the factory preset EDIDs include only one resolution. This is to force the connected source to give a signal with the needed resolution. However there are Universal EDIDs as well which allow many resolutions.

Factory EDIDs are divided into groups regarding their type. Some EDIDs support DVI only, some support HDMI and some are for analog VGA signals. Also there are EDIDs for Dual Link DVI resolutions.

DVI EDIDs does not support audio. Universal DVI EDID indicates support for many PC (VESA) resolutions.

HDMI EDIDs support embedded audio. These EDIDs have PCM stereo audio format enabled. To allow other audio formats like Dolby and DTS, special EDIDs have to be used. There are three Universal HDMI EDIDs which include the same resolutions but support different capabilities:

EDID	PCM audio	other audio	deep color
Universal_HDMI_PCM	yes	no	no
Universal_HDMI_ALL	yes	yes	no
Universal_HDMI_DC	yes	yes	yes

Table 6-10. Universal HDMI EDIDs

Info: Analog EDIDs are for future developments.

Dual Link DVI EDIDs does not support audio. Use only for Dual Link ports.

¹ The exact EDID memory size depends on the firmware and the installed A/V modules.

6.6.3. Advanced EDID Management









Select the EDID button from the main menu.

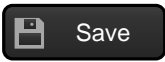

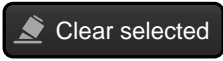
Figure 6-7. EDID management

The window contains two panels: left panel contains the EDIDs that can be used as a source; right panel contains the target places where the EDIDs can be emulated. The list can be scrolled by mouse wheel or by grabbing the list.

Control buttons

-  Save Exporting an EDID (save to a file)  Executing EDID emulation/learning (Transfer button)
-  Load Importing an EDID (load from a file)  Deleting EDID (from user memory)
-  Info Opening EDID Summary window with selected EDID  Selecting all memory places in the right panel
-  Edit Opening Advanced EDID Editor with selected EDID  Selecting none of the memory places in the right panel
-  Create Opening Easy EDID Creator

6.6.4. Changing emulated EDID

- Step 1.** Select desired EDID list from one of the three sources by pressing its button above left panel.
- Step 2.** Select an EDID from the left panel that has to be emulated; the EDID will be highlighted with yellow cursor.
- Step 3.** Press Emulated button above right panel; currently emulated EDID is shown.
- Step 4.** Select desired port where the EDID has to be emulated (more ports can also be selected); the EDID will be highlighted with yellow cursor.
- Step 5.** Press Transfer button to change emulated EDID.

6.6.5. Learning an EDID

Info: The process is the same like changing emulated EDID; the only difference is the target on the right panel: select 'User' button. Thus one or more EDIDs can be copied into user memory either from factory memory or from a connected sink (Dynamic).

6.6.6. Exporting an EDID

The EDID listed in left panel can be downloaded as a file (*.bin) to the computer.

Step 1. Select desired EDID from the left panel (the EDID has to be highlighted with yellow cursor).

Step 2. Press Save button to download the file to the computer.

6.6.7. Importing an EDID

Previously saved EDID (*.bin file) can be imported into user memory as follows:

Step 1. Press User button above left panel.

Step 2. Select a memory slot from the list; it will be highlighted with yellow cursor.

Step 3. Press Load button below left panel.

Step 4. Browse the file in the opening window then click on Load EDID. Browsed EDID is imported into the selected User memory slot.

Info: The imported EDID overwrites the selected memory slot even if it is not empty.

6.6.8. EDID Summary window

Select an EDID in the left panel and press Info button to display EDID summary.

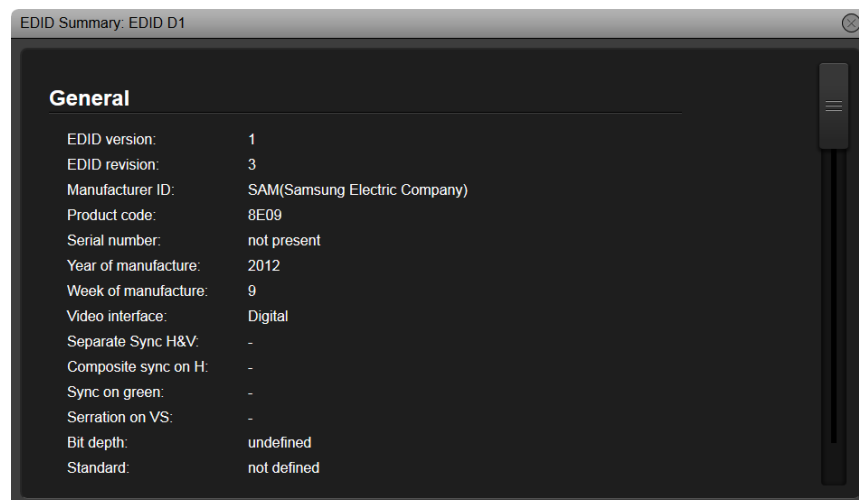

Figure 6-8. EDID Summary

6.6.9. Creating an EDID

Since the above mentioned advanced editor needs more complex knowledge about EDID, Lightware introduced a wizard like interface for fast and easy EDID creation. With Lightware Easy EDID Creator it is possible to create custom EDIDs in four simple steps. By clicking on the wizard icon, the Easy EDID Creator opens in a new window.

For further information, see the user's manual of Easy EDID Creator.

6.6.10. Editing an EDID

Select an EDID from left panel and press Edit button to display Advanced EDID editor window. Modified EDID can be stored in user memory.

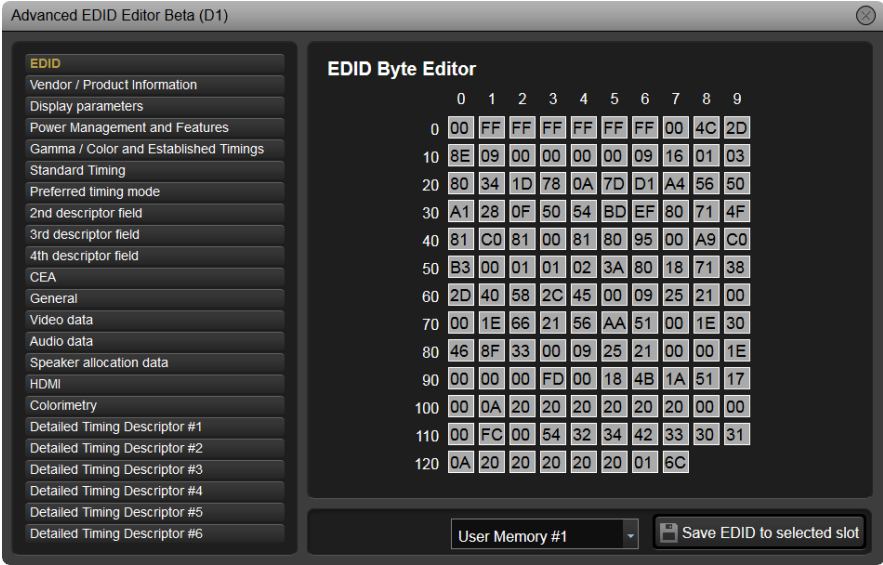

Figure 6-9. Advanced EDID Editor

6.6.11. Deleting EDID(s)

The EDID(s) in User memory can be deleted as follows:

- Step 1.** Click on User button above right panel.
- Step 2.** Select one or more EDID from the list that are desired to be deleted.
- Step 3.** Click on Clear selected button to delete selected EDID(s).

6.7. Control menu

6.7.1. Ethernet tab

The Ethernet tab shows the available Ethernet ports. Under the port settings the name of the port and the Ethernet mode can be set. Front port is the one on the front panel, Link is the transmitted line to the other extender. Further ports depend on the installed interface modules. Above picture shows that two modules are installed: module D contains one Ethernet port, module E contains 4 ports.

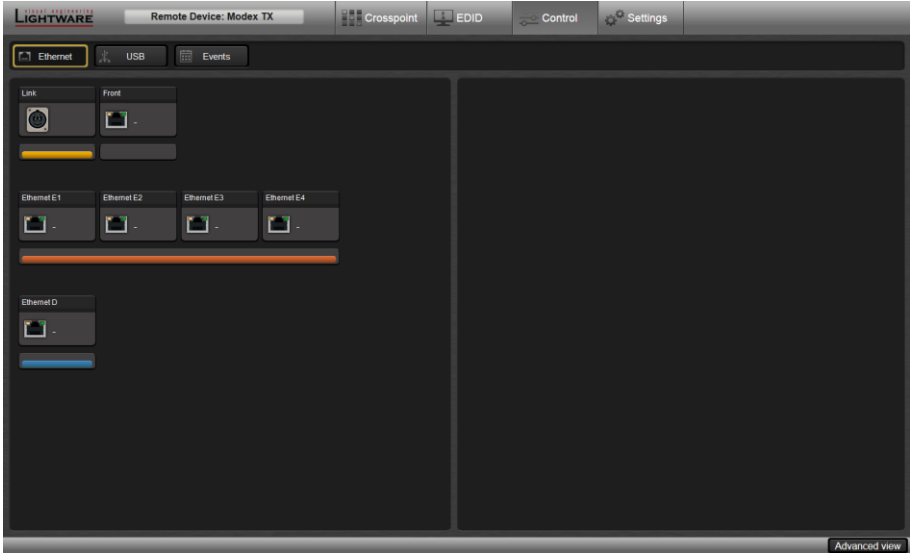

6.7.2. USB tab

MODEX devices are able to extend two USB 1.1 and/or USB 2.0 devices from the transmitter to the receiver that are compatible and in line with USB HID standard. Typical supported USB devices are:

- USB mouse and keyboard,
- Smart Card (reader).

Typical application is when a computer located at the transmitter is controlled at receiver's side by the connected keyboard and mouse via USB. Certain touch monitors fulfill the USB HID standard, which can also be connected.

Connected USB devices and the status are displayed on the panels:

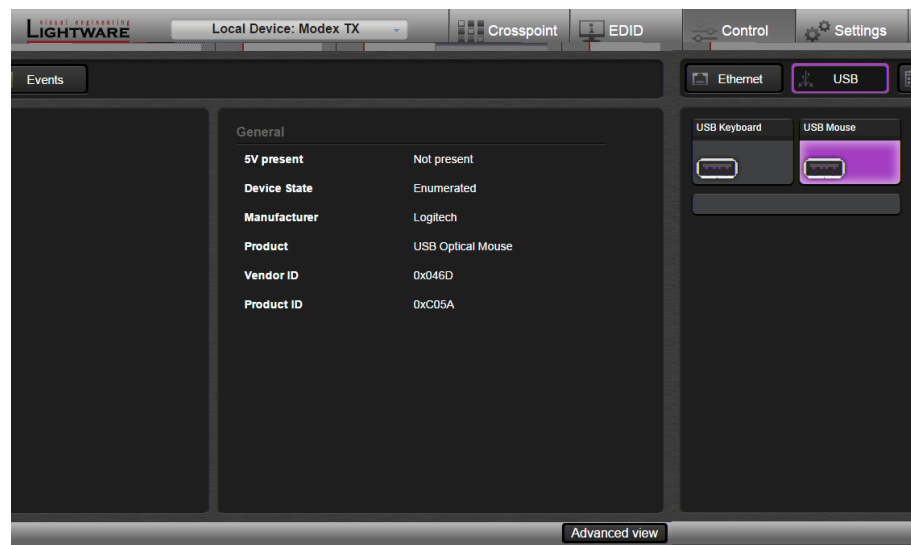

Figure 6-10. USB tab in the Control menu

Device states

- Disconnected: No device is connected to the USB port and no device is emulated to the computer.
- Enumerated: USB device is connected and install is in progress.
- Connected: USB device is connected to the receiver and emulated on the computer.
- Suspended: Keyboard and mouse functions are emulated by the extender and no USB enumeration occurs while operator switching. A computer is not aware when the device has been changed. When the state is Suspended, device is disconnected from the extender however it is still emulated to the computer.

6.8. Event manager

The Event manager was developed because of user needs to display internal events (such as signal present or HDCP active) on GPIO ports, and controlling the device with GPIO inputs instead of front panel buttons. However the Event manager can be used without GPIO module, too. The function is very comfortable when the device is built under the desk and the front panel pushbuttons and LEDs are not accessible.

Basically the Event manager can be configured to detect LW3 CHANGE messages, and if the condition (the given change message) appears, the event will be fired. The device will perform an action (send out a preprogrammed LW3 SET or CALL message to itself). E.g. the desired setup is that after the input signal has been present on the VGA port, the level of GPIO1 pin is changed. The settings can be done via the LDC in the Control/Events tab, or by LW3 protocol commands, see section [7.8](#) on page [82](#).

32 events can be configured, which are available in Control/Events submenu. The user can see all the 32 events here and is able to modify them by two ways:

- Event setting Wizard, or
- Advanced event setting.

Info: Conditions and actions can be set by both Wizard or Advanced modes. If the condition was set by wizard the action can be set by wizard or also advanced mode (and vice versa).

6.8.1. The event area

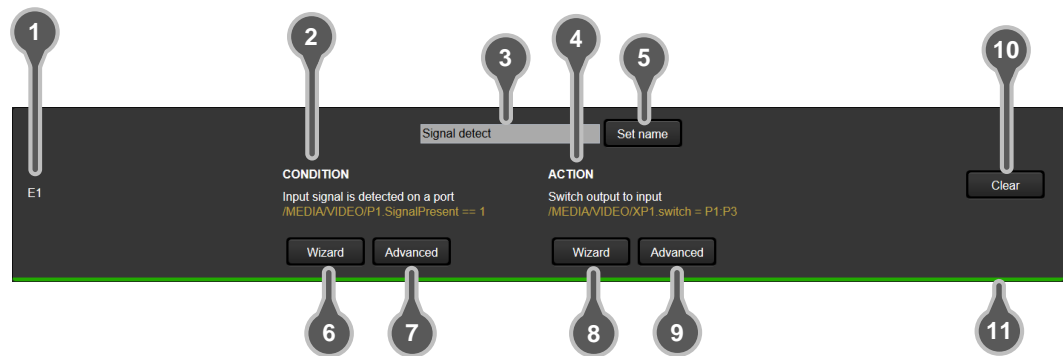

Figure 6-11. First event (E1) settings

- | | |
|--|--|
| <p>1 Number of the event</p> | 32 events can be defined, the label shows their ID (E1-E32). (This number is the node in the protocol tree, too.) |
| <p>2 Condition</p> | If the condition was set, the description (white colored text) and the exact LW3 protocol expression (yellow colored text) can be seen. If advanced mode was used the description is "Custom condition". |
| <p>3 Name of the event</p> | Text as the name of the event can be stored. Click into the text box and type desired name. |
| <p>4 Action</p> | If the action was set, the description (white colored text) and the exact LW3 protocol expression (yellow colored text) can be seen. If advanced mode was used the description is "Custom action". |
| <p>5 Set name button</p> | The device stores the name of the event if the Set name button was pressed. |
| <p>6 Set condition (wizard)</p> | Run the wizard to choose from the most common expressions as a condition. |
| <p>7 Set condition (advanced)</p> | Advanced setting contains wide range of LW3 expressions. If the desired expression cannot be set by wizard, use this method. |
| <p>8 Set action (wizard)</p> | Run the wizard to choose from the most common expressions as an action. |
| <p>9 Set action (advanced)</p> | Advanced setting contains wide range of LW3 expressions. If the desired expression cannot be set by wizard, use this method. |
| <p>10 Clear event button</p> | Unwanted events can be cleared with a single click on this button. Confirmation is needed for deleting. |
| <p>11 Check bar</p> | If the event is ready and syntactically correct the check bar becomes green. |

6.8.2. Wizard mode

A simple wizard makes things easy for the user, because it lists the most common conditions and actions, so the user does not have to look for LW3 nodes and properties, the wizard does it instead. Conditions and actions also have their own button.

Step 1. Click on the Wizard button.

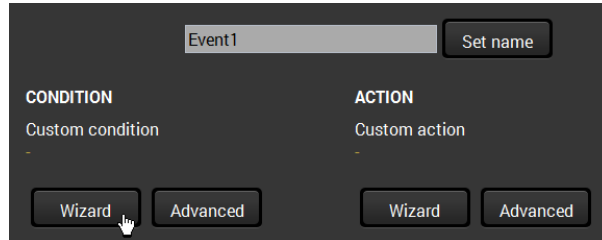

Step 2. Select the desired category from the drop-down menu.



All the values can be changed during the whole process.

Step 3. Select an Expression.

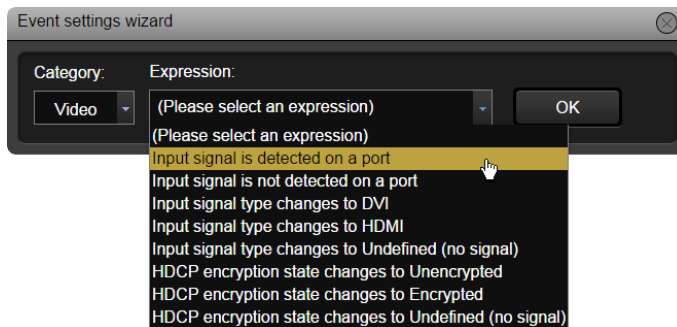

The given expressions determine the further possible parameters. E.g. if the Expression is a video signal detection of any port on the Video layer, the port has to be defined in the following step.

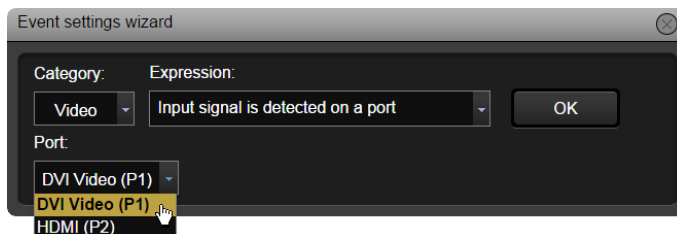

If the parameters are selected in the drop-down boxes, click on the OK to finish the wizard of the condition; the set condition can be seen above the buttons. The white text is the name of the selected condition. The yellow one is the accurate property name and value by LW3 protocol. You do not need to remember or note this text, LDC shows it continuously.

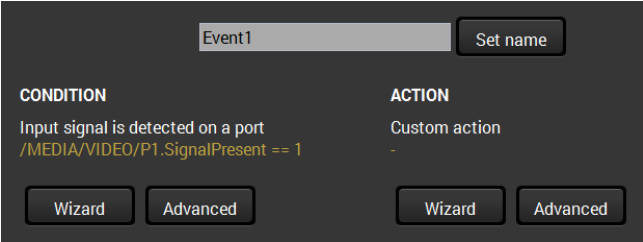

The action is the “reply” if the condition becomes true. There is no sequence between the condition and the action. Either of them can be set firstly.

Step 4. To set the action, click on the wizard button on the action side.

The process is the same. Click on the down arrow of the drop-down menu than select the desired item. The category and the expression can be set. If the expression requires further parameter, select it. E.g. if the Expression is a switching on the video layer, the input and the output port has to be selected in the next step.

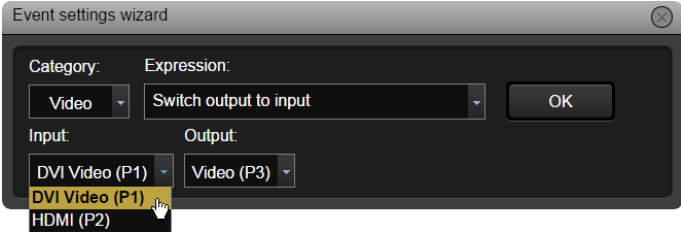

Step 5. Click on the OK to finish the wizard of the action.

The window of the wizard is closed; the created action can be seen above the buttons. The white text is the name of the selected action, the yellow is the accurate property (and its value) or method name by LW3 protocol. You do not need to remember or note this text, LDC shows it continuously. The system checks the validity of the event. If everything is correct, a green line can be seen at the bottom of the event area.

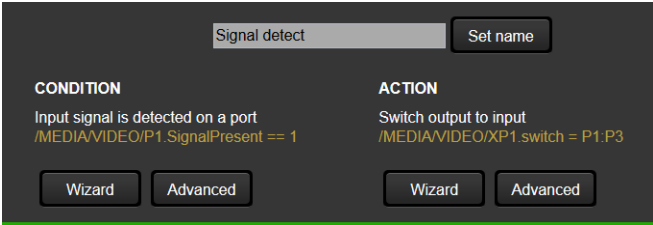

6.8.3. Advanced mode

The goal of this mode is the same as of the wizard: set the properties and methods for conditions and actions. The difference is the number of the available and usable properties and methods of the LW3 protocol. Advanced mode allows almost all of it.

Step 1. Click the Advanced button. A new window comes up.

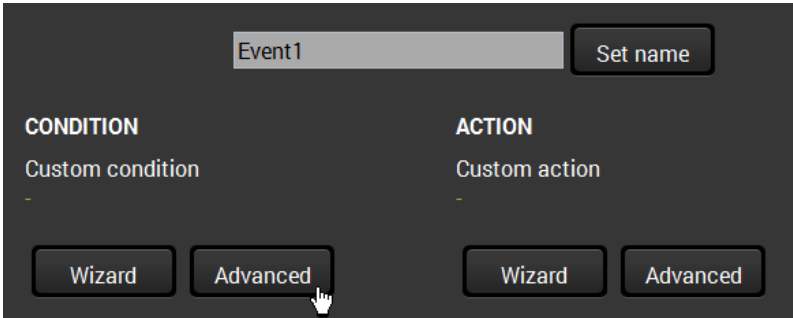

Step 2. Select the desired node and the property; on the left side there is the closed LW3 tree of the device. To open it, click on the plus sign (in the red square).

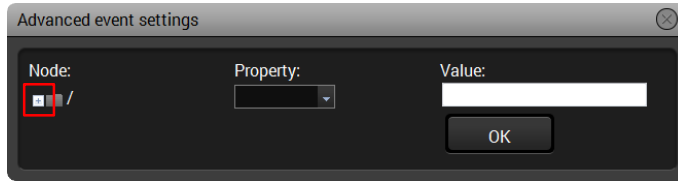

The tree structure is opened and the available properties are listed in the drop-down box. The manual of the selected property can be seen below it.

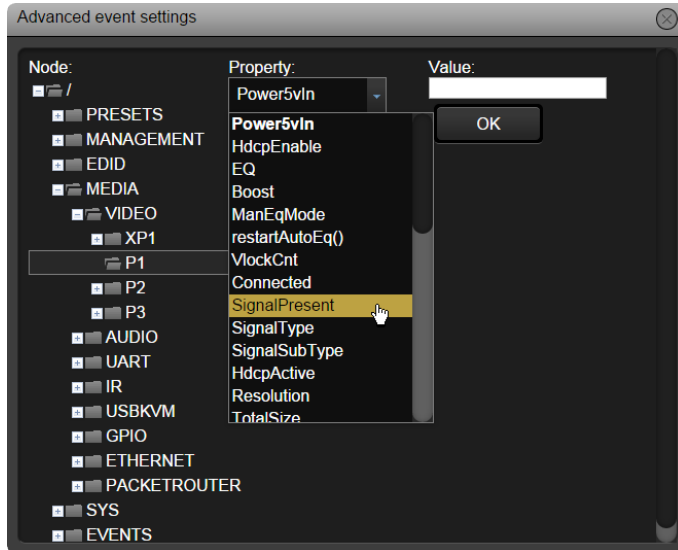

Step 3. Set the desired value in the field next to the list.

Step 4. Click on the OK button to apply the settings.

If the condition is finished, set the action with the same method. The system checks the validity of the event. If everything is correct, a green line can be seen at the bottom of the event area.

6.8.4. Save, load or clear an event

Save an event

Although the device stores the set events, – even after reboot or firmware upgrade – in some cases event saving to the computer can be useful (e.g. transfer to another TPS device). Events can be stored in a readable CSV file (Comma Separated Values) which is a human readable file type and can be imported/edited by many spreadsheet application.



Info: Events cannot be exported one by one. All events will be stored with the exportation.

To save all events click on Export to CSV button, browse the desired folder, then click on Save button.

Load an event

Click on the Import from CSV button. A browse window comes up. Find the .CSV file than click on the Open button.



Clear an event

Click on the Clear button, a confirmation window comes up. Click on the OK button to clear the event. Clearing the events means setting them to the factory default values. The names become Event1..32, the condition and the action get empty value.

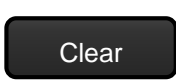

Clear all events

All events can be cleared at the same time with the loading factory default values. All the values will be cleared: names, conditions, actions. Click on the Load factory defaults button. A warning message appears; confirm it by clicking on the OK button.



6.9. Settings menu

Reboot

When Settings menu is selected, Reboot button is displayed in the right top corner; the extender can be rebooted after confirmation.

6.9.1. Core tab

The submenu displays information about MODEX frame. Device label can be also changed which is visible on the front panel LCD.

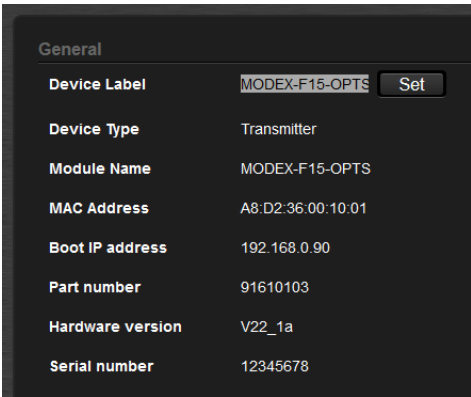

Figure 6-12. Core tab

6.9.2. Network tab

When the extender is connected to a network or directly to a computer, the necessary settings can be set in this submenu. If a fixed IP address is planned to use, fill Static IP address, Static subnet mask and Static gateway fields. If dynamic IP address is planned to use, set DHCP to Enabled from the drop-down list; other settings are made automatically.

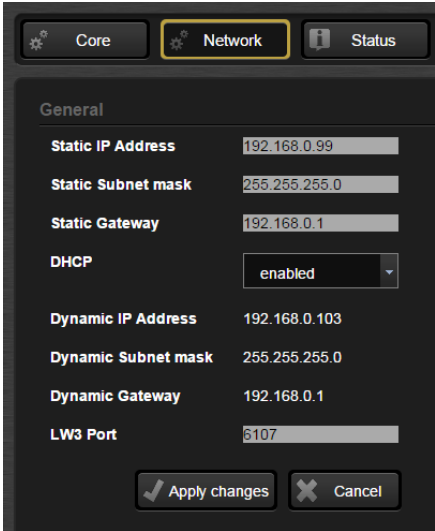

Figure 6-13. Network tab

Click on Apply changes button to save settings.

6.9.3. Status tab

Besides some general information and firmware versions in left panel, name of the installed modules are listed in the right panel of this submenu. System time means the elapsed time since last boot.

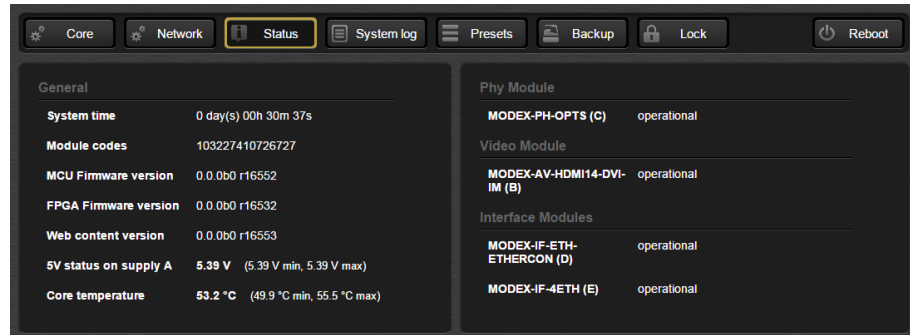

Figure 6-14. Status tab

Info: Supply B is reserved for future developments.

6.9.4. System log tab

Info: The feature is available only when connecting to the MODEX directly (as a Local Device).

The submenu shows events that have been logged by MODEX. Use the selectors to display the logged Notices, Warnings, Errors or Fatal errors. The log can be scrolled by the mouse wheel or grabbing and moving the lists.

Click on Export button to save all events as a CSV file (Comma Separated Values).

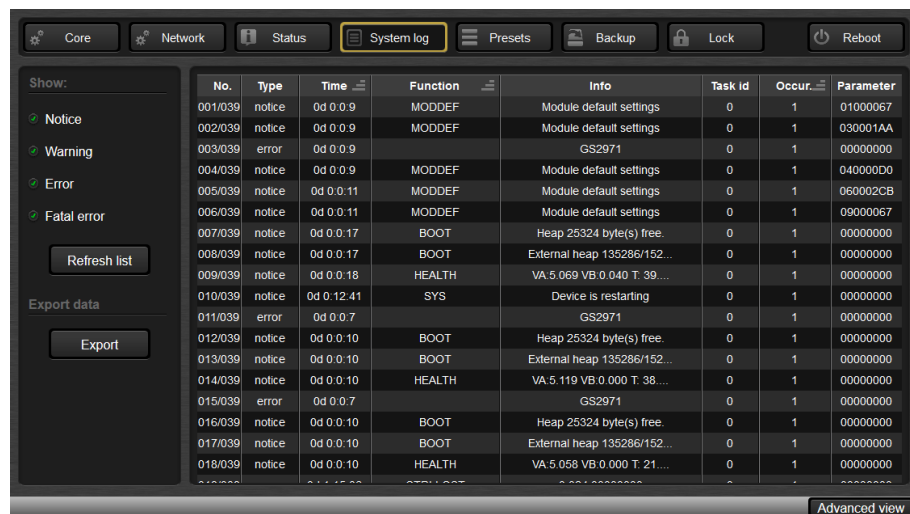

Figure 6-15. System log tab

6.9.5. Presets tab

Info: The feature is available only when connecting to the MODEX directly (as a Local Device).

Each MODEX extender has eight preset memories which can be used to store LW3 commands (settings and configurations). This feature allows to set the MODEX with previously determined parameters, execute a group of commands, etc... The preset memories can be filled by browsing a simple text file that contains the commands.

The structure of the file has to be the following:

Format	Example
;•<description>CrLf <command ₁ >CrLf <command ₂ >CrLf ... <command _n > CrLf	; P1 switching CALL /MEDIA/VIDEO/XP1:switch(P1:P2) CALL /MEDIA/VIDEO/XP1:unmuteSource(P1;) CALL /MEDIA/AUDIO/XP1:switch(P4:P3;P6:P8) CALL /MEDIA/AUDIO/XP1:unmuteSource(P4;P6;)

• = space character; CrLf = Carriage Return, Line feed

Explanation: The first line must start with “;” (semicolon) character, then a space and the description of the preset. Lines must be closed with CrLf even the last line, too, or else that command will not be processed.

The LW3 commands must be in line with the rules written in chapter 7 from page 65.

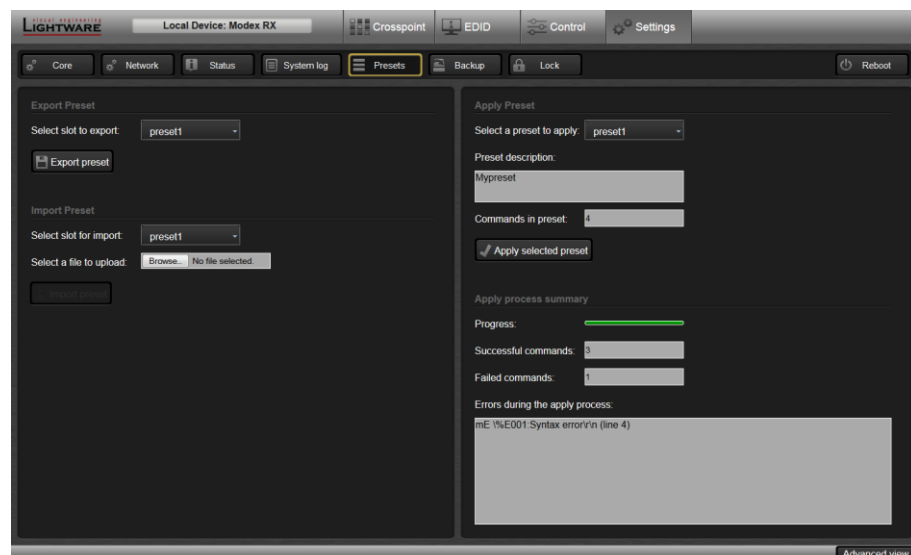

Figure 6-16. Presets tab

Import a preset

The import allows to store a group of commands in one of the preset memories. The import is processed from a text file as follows:

- Step 1.** Navigate to the Settings/Presets tab.
- Step 2.** Select a slot for the import from the drop-down menu on the left (Import Preset section).
- Step 3.** Click on the Browse button below the slot number and select the desired file.
- Step 4.** Click on the Import preset button. The preset is filled with the content of the file.

Export a preset

- Step 1.** Navigate to the Settings/Presets tab.
- Step 2.** Select a slot to export from the drop-down menu on the left (Export Preset section).
- Step 3.** Click on the Export preset button; the selected preset will loaded to a new tab in the browser.

Apply a preset (run a preset)

- Step 1.** Navigate to the Settings/Presets tab.
- Step 2.** Select a preset from the drop-down menu (Apply Preset section). Preset description is loaded into the textbox and the number of the found commands is displayed, too.
- Step 3.** Click on the Apply selected preset button; the process indicator shows the status. The Apply process summary section contains the results:
 - The number of successfully run commands,
 - The number of failed commands which could not run, and
 - The errors during the apply process.

Example

```
; P1 switching
CALL /MEDIA/VIDEO/XP1:switch(P1:P2)
CALL /MEDIA/VIDEO/XP1:unmuteSource(P1;)
CALL /MEDIA/AUDIO/XP1:switch(P4:P3;P6:P8)
CALL /MEDIA/AUDIO/XP1:unmuteSource(0;P6;)
```

After applying (processing) above preset, the result is the following:

- Commands in preset: 4
- Successful commands: 3
- Failed commands: 1
- Errors during the apply process: mE /%E001:Syntax error/r/n (line 4)

Explanation: The last command could not be run due to a syntax error. The correct syntax of the “unmuteSource” method can be found in section [7.4.4](#) on page [78](#).

6.9.6. Backup tab

Info: The feature is available only when connecting to the MODEX directly (as a Local Device).

The extender’s settings can be saved and loaded to/from the computer. When creating a backup of a MODEX, the following settings are stored:

- All ports’ settings (writable properties’ values) of all layers,
- Crosspoint settings of all layers,
- All EDID data stored in the User memory,
- All Events (from the Event manager) and
- Network settings.

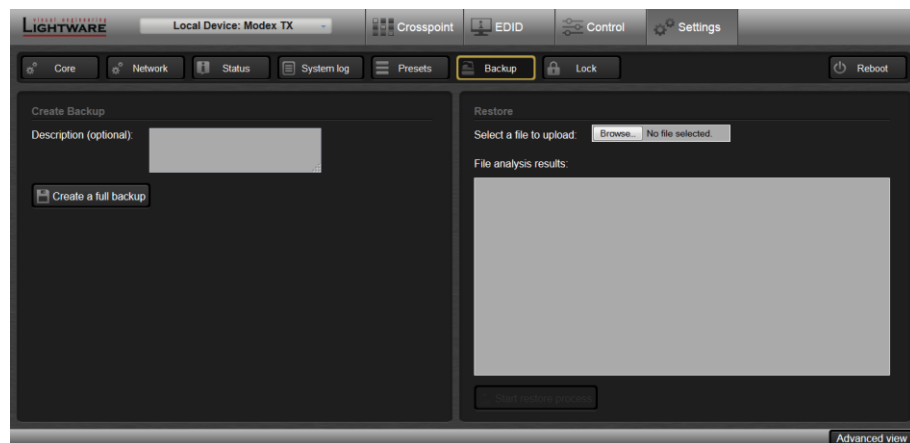

Figure 6-17. Backup tab

Create a full backup of the MODEX

- Step 1.** Arrange the desired settings in the MODEX.
- Step 2.** Navigate to Settings/Backup menu.
- Step 3.** Write a short description in the textbox on the left (optionally).
- Step 4.** Press the Create a full backup button. You will be prompted to save the collection information as a file to the computer (select the desired folder and save the file).

Restore a backup file

Previously saved backup file can be restored as follows:

- Step 1.** Navigate to the Settings/Backup menu.
- Step 2.** Click on the Browse button on the right panel and select the desired file.
- Step 3.** The file is checked and the result will be displayed in the textbox below. If the file is correct, the settings will be restored.

Info: Please note that the settings will be overwritten with the restored parameters in the MODEX permanently. Withdrawal is not possible.

6.9.7. Lock tab

Locking a module means settings of the module cannot be changed: neither on user interface, nor by protocol commands (Advanced view); however it will be still active. Modules and settings can be locked on this page:

- **Lock core module:** Crosspoint change is not allowed on any layer (Video, Audio, Infra, Serial, etc...).
- **Lock LCD Home Screen:** When this option is checked, front panel menu is locked. Only idle state is shown, front panel operations are disabled.
- **Disable setup from LCD menu:** Front panel menu is available, but settings cannot be changed.

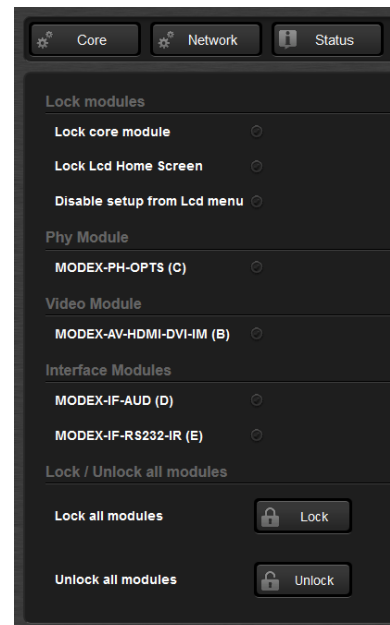

6.10. Advanced view

Advanced view is the surface for LW3 protocol settings with terminal window. Commands and specific parameters (that are not available on the user interface) can be run and set. Detailed information about the protocol, nodes, methods and parameters can be found in chapter 7 on page 65. Click on Close button to hide the Advanced view.

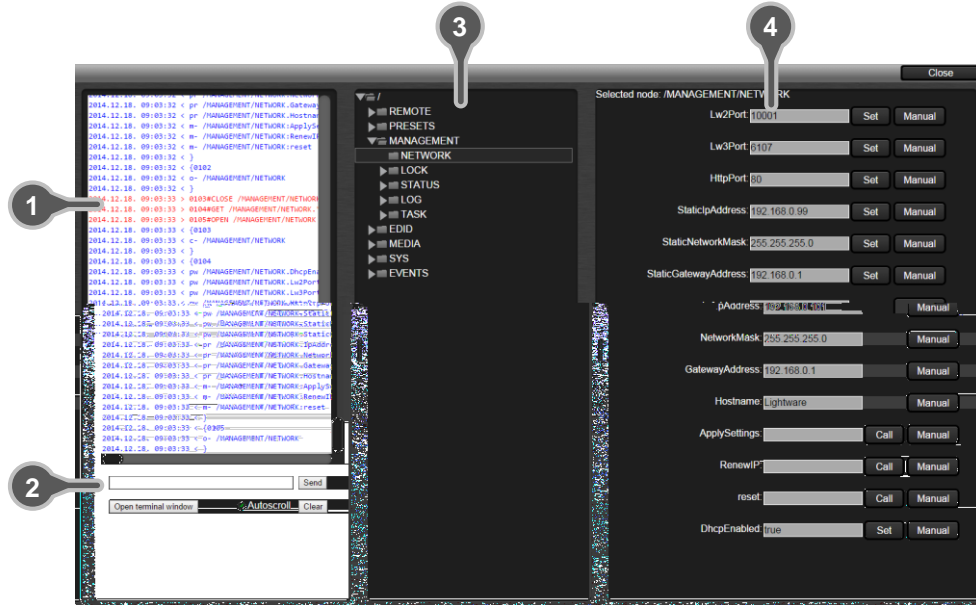

Figure 6-18. Advanced view

- 1 Terminal window**

Commands and responses are listed in this window. The timecode in every row shows the exact time when the command was sent or the response received. Sent command is displayed in red and starts with ' > ' character, received response is displayed in blue and starts with ' < ' character. The content of the window can be emptied by the Clear button.
- 2 Command line**

Commands/queries can be typed directly into this field.

Send button: Execute the command in the field.

Clear button: Empty the terminal window.

Open terminal window: The separate window can show the commands and responses after closing the advanced view.
- 3 Protocol tree**

The protocol tree is available via this panel. Select an item to see its content.
- 4 Node content**

The properties and methods are shown which belong to the selected node in the protocol tree.

Manual button: Manual (short description) of the node can be called and displayed in the terminal window. See more information about manuals in section 7.2.9 on page 74.

Set button: Saves the value/parameter typed in the textbox.

Call button: Calls the method with the typed value, e.g. reloads factory default settings.

Info: If a module is locked, its settings cannot be changed; parameters, values will not be saved, and factory default settings cannot be reloaded.

7. Programmer's reference

7.1. LW3 protocol – Overview

Lightware 3 (LW3) protocol is currently used by MODEX extender family, 25G product line and will be the preferred protocol in new developments.

LW3 is an ASCII based protocol and all commands are terminated with a carriage return (Cr, '\r') and line feed (Lf, '\n') pair. It is organized as a tree structure that provides outstanding flexibility for implementing a human readable, but still easy to programmatically parse protocol, which is suitable for different products with different feature list.

The concept

In order to implement a flexible, easy-to-use protocol that is straightforward to adapt to new devices and provides outstanding scalability and sustainability, Lightware decided to organize all settings, parameters and properties of the device to a tree structure with 'nodes', 'properties' and 'methods'.

7.1.1. Elements of tree structure

Info: All names and values are case sensitive. The space character is replaced by '•' character in elements and commands descriptions.

Node

- Basic building block of the tree structure is the 'node'.
- A node can have multiple child nodes, but only one parent.
- The tree has only one root: the 'root node'.
- The leaves of the tree are also nodes, which do not have child nodes.
- The nodes are separated by a slash ('/') character.
- The identifier of the root node is a slash ('/').
- Nodes' name can contain elements of the English alphabet and numbers.
- The path of a node has to contain all parent nodes from the root node.

Format (the root node): nX•/

Path: nX•/[nodeName]/[nodeName]/[nodeName]

Legend: 'n': node

'X' can be:

'-': default for a node,

'm': manual for the node (see section [7.2.9](#) on page [74](#)),

'E': error message for the node (see section [7.1.3](#) on page [68](#)),

Info: All parent nodes must be listed in the path of a node.

Following example presents the depth tree traversal of [Figure 7-1](#):

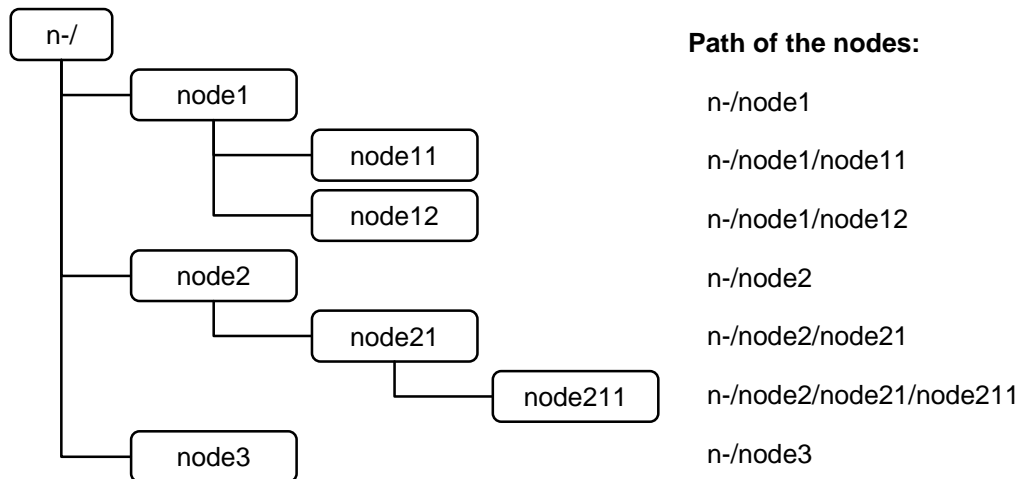

Figure 7-1. Tree structure of nodes

Property

The 'property' in the LW3 protocol is basically a leaf, which has a well-defined value.

- A property has a value.
- A property cannot have child nodes or child properties. It is always a leaf.
- A node can have any number of properties (may not have any).
- A property is referenced with a dot ('.') after the node name.
- The properties' name can contain the elements of the English alphabet, numbers and underscore ('_') character.
- By convention, properties are beginning with capital letter, all other characters are lowercase ones. In case of compound words, all words are beginning with a capital letter (CamelCase).
- The value of the property can contain any readable ASCII character (the control characters have to be escaped, see section [7.1.2](#) on page [67](#)).
- A property can be read-only or read/write.

Format: pX•/[nodeName].[propertyName]=[propertyValue]

Legend: p: property

X can be:

- 'r': if the property is read-only.
- 'w': if the property is readable, writable.
- 'm': manual for the property (see section [7.2.9](#) on page [74](#)).
- 'E': error message for the property (see section [7.1.3](#) on page [68](#)).

Example:

First one is a read-only property, second one is a read-write property:

```

< pr•/SYS/CORE.PartNumber=91610103
< pw•/SYS/CORE.DeviceLabel=MODEX-F15-OPTS
  
```

Method

'Method' in the LW3 protocol is also a leaf. It cannot have a value, such as the properties, but it can be invoked with a parameter with the help of a special 'CALL' command (see section [7.2.5](#) on page [71](#)).

- A method cannot have child nodes or child methods. It is always a leaf.
- A node can have any number of methods (may not have any).
- A method is referenced with a colon (':') after the node.
- Methods' name can contain the elements of the English alphabet, numbers and underscore ('_') character.
- By convention, methods are beginning with lowercase letter. In case of compound words, the very first letter is lowercase, and the first letter of each other words are capitalized (lowerCamelCase).
- The parameter of the method can contain any readable ASCII character (control characters have to be escaped, see section [7.1.2](#) on page [67](#)).
- The method always has a return 'state' if the method could be executed. The state could be either 'OK' or 'FAILED'.
- The method not necessarily has a return 'value'. If it does, it can contain additional information, which is always specific for the current case (return value can specify why the execution failed). Find details in section [7.2.5](#) on page [71](#).
- When the method cannot be executed (e.g. the parameter list is illegal), there is an error message (see section [7.1.3](#) on page [68](#)).

Format: mX•/[nodeName]:[methodName]=[returnValue]

Legend: m: method

X can be:

'O': when the execution of the method was successful,

'F': when the execution of the method failed,

'm': manual for the method (see section [7.2.9](#) on page [74](#)),

'E': error message for the method (see section [7.1.3](#) on page [68](#)).

Example:

```
< mO•/node1/node12:method1
< mO•/MEDIA/IR/XP1:DefaultSwitch
< mO•/EDID>DeleteEdid
```

7.1.2. Escaping

Property values and method parameters can contain characters that are used as control characters in the protocol. They must be escaped. The escape character is the backslash ('\') and escaping means injecting a backslash before the character that should be escaped (like in C language).

Control characters are the followings: \ { } # % () \r \n \t

Example:

Original text: John•(Doe) .•#3:•5%2=1•node1\node11

Escaped text: John•\ (Doe\) .•\#3:•5%\%2=1•node1\\node11

7.1.3. Error messages

There are several error messages defined in LW3 protocol. All of them have a unique error number which can be used programmatically, and an informative error message.

Format: XE•[primitive]•%EYYYY:•[Error message]

Legend: X can be:

- '-': syntax error. Cannot parse the command at all.
- 'n': node error.
- 'p': property error.
- 'm': method error.

YYY: error code, which can be one of the followings:

E001	Syntax error	E010	Illegal parameter count
E002	Node not found	E011	Item already exist
E003	EOL expected	E012	Item does not exist
E004	Writing read-only property	E013	Illegal operation
E005	Invalid value	E014	Internal error
E006	Property does not exist	E015	Access denied
E007	Syntax error	E016	Write access denied
E008	Illegal method	E017	Reserved
E009	Method does not exist	E018	Waiting timeout

7.1.4. Prefix summary

The following prefixes are defined in LW3 protocol:

- 'n-': a node,
- 'nE': an error for a node,
- 'nm': a manual for a node,
- 'pr': a read-only property,
- 'pw': read-write property,
- 'pE': an error for the property,
- 'pm': a manual for the property,
- 'm-': a method,
- 'mO': a response after a success method execution,
- 'mF': a response after a failed method execution,
- 'mE': an error for a method,
- 'mm': a manual for a method.

7.2. Commands

Getter

The 'GET' command can be used to get sub nodes, properties and methods of a specific node. It also can be used to get the value of a property.

Response format

The first two characters of a response unambiguously identifies the type of the element that the response line concerns. First character is the type of the element (node/property/method), second is for miscellaneous information (e.g. read/write rights).

Defined prefixes are:

'n-': node
'pr': property – only readable
'pw': property – writable, readable
'm-': method executable

After prefix the response contains the full path of the node, property or method after a space character.

7.2.1. Get all children of a node

Get all of the child nodes of a parent node, with one GET command.

Command format: GET●[nodePath]

Response format: n-●[nodePath]

Example:

```
> GET●/MEDIA/IR
< n-●/MEDIA/IR/XP1
< n-●/MEDIA/IR/P1
< n-●/MEDIA/IR/P2
```

7.2.2. Get all properties and methods of a node

Get all properties and methods of a specific node, with one GET command, using an asterisk wildchar.

Command format: GET●[nodePath].*

Response format: (for properties)

pX●[nodePath].[propertyName]=[parameter]

Legend: X can be:

'r': read-only
'w': read-write

Response format: (for methods)

m-●[nodePath]:[methodName]

Example:

```
> GET●/PRESETS/1.*
< pr●/PRESETS/1.Index=1
< pw●/PRESETS/1.RemoveLock=false
< pw●/PRESETS/1.Text=Preset 1
```

7.2.3. Get all child nodes, properties and methods of a node

Get all child nodes, properties and methods of a node with one command, without using a wildchar.

Command format: GETALL●[nodePath]

Response format: (for nodes)

n-●[nodePath]

Response format: (for properties)

pX●[nodePath].[propertyName]=[parameter]

Legend: X can be:

'r': read-only

'w': read-write

Response format: (for methods)

m-●[nodePath]:[methodName]

Example:

```
> GETALL●/MANAGEMENT
< n-●/MANAGEMENT/NETWORK
< n-●/MANAGEMENT/STATUS
< n-●/MANAGEMENT/LOCK
< n-●/MANAGEMENT/LOG
< pr●/MANAGEMENT.rebootNeeded=false
< pw●/MANAGEMENT.WebEnvironment=
< m-●/MANAGEMENT:Udc
< m-●/MANAGEMENT:Msg
```

Info: The command does not list child nodes and properties of listed child nodes, only that belongs to the node directly. E.g. the child nodes and properties of /MANAGEMENT/NETWORK is not listed in this example, those can be queried if 'GETALL●/MANAGEMENT/NETWORK' is run.

7.2.4. Set command

The setter command can be used to modify the value of a property.

Command format: SET●[nodePath].[propertyName]=[newPropertyValue]

Response format:

The response for setting a property to a new value is the same as the response for 'GET' command. The value in the response is the new value if the execution of 'SET' command was successful, otherwise the unmodified 'old value' with an error message.

pw●[nodePath].[propertyName]=[newPropertyValue]

Example:

```
> SET●/MANAGEMENT/NETWORK.PortNumber=6107
< pw●/MANAGEMENT/NETWORK.PortNumber=6107
```

Error response format:

If there were errors during setting a property, an error message follows the unmodified property value. Find the error numbers in section [7.1.3](#) on page [68](#).

pE●[nodePath].[propertyName]=[unmodifiedValue]●%EXXX:Error message

Legend:

XXX: error number (see section [7.1.3](#) on page [68](#)).

Examples:

```
> SET●/SYS/CORE/B/VIDEODV000.HdcpEnable=false
< nE●%E002:Node not found
> SET●/SYS/CORE.PartNumber=12345678
< pE●%E004:Writing read-only property
> SET●/SYS/CORE/B/VIDEODVI.HdcpEnable=falssss
< pE●%E005:Invalid value
> SET●/SYS/CORE/B/VIDEODVI.HdcpEnab=false
< pE●%E006:Property not exists
```

7.2.5. Invocation

A method can be invoked with the help of 'CALL' command.

Command format: CALL●[nodePath]:[methodName]([parameter])

Response format:

The response for a method execution is a state and a value. The state is mandatory and always defined, if the method could be executed. It can be either a success or a failure. The value is optional and it can contain additional information – such as the reason why the state is a failure or a specific value when the state is success – which the client can process. It is also possible to get an error message, when the method could not be executed – e.g. the parameter was illegal – and hence not even the state of the execution could be specified.

mX●[nodePath]:[methodName]=Y

Legend: X can be:

- 'O': if the execution is successful.
- 'F': if the execution is failed, but the method could be executed.
- 'E': if the method could not be executed: e.g. illegal parameter count.

Y can be:

- the return value of the method if any.
- it is valid that a method does not have any return value. In this case the equal sign ('=') can be omitted.

Example:

```
> CALL●/MANAGEMENT/LOCK:LockAll ()
< mO●/MANAGEMENT/LOCK:LockAll
```

Error response format:

If there were errors during the execution, an error message is received, which follows the method name. Find the error codes in section [7.1.3](#) on page [68](#).

mE●[nodePath]:[methodName]●%E00X:Error message

Example:

```
> CALL●/EDID>DeleteEdid(U100)
< mE●%E005:Invalid●value
```

7.2.6. Subscription

User can subscribe to any node. Subscribe to a node means that user will get a notification if any of the properties of the node is changed. These notifications are asynchronous messages – such as the ones described above – and hence they are useful to keep client application up-to-date, without receiving any unwanted information. When user does not want to be informed about the changes anymore, he can simply unsubscribe from the node.

Info: The subscriptions are handled separately for connections and not for users. Hence, if the connection is terminated all registered subscriptions are deleted. After every connection the subscribe command has to be sent in order to get the notifications of the changes.

Subscribe to a node

Command format: OPEN●[nodePath]

Response format: o-●[nodePath]

Example:

```
> OPEN●/MANAGEMENT/NETWORK
< o-●/MANAGEMENT/NETWORK
```

Subscribe to multiple nodes

In order to subscribe to multiple nodes, asterisk wildchar can be used.

Command format: OPEN●[nodePath]/*

Response format: o-●[nodePath]/*

Example:

```
> OPEN●/MANAGEMENT/LOG/*
< o-●/MANAGEMENT/LOG/*
```

Get the active subscriptions

Issuing an 'OPEN' command without any parameters returns the active subscriptions for the current connection.

Command format: OPEN

Response format: o-●[nodePath]

Example:

```
> OPEN
< o-●/SYS/CORE
< o-●/MEDIA/VIDEO
< o-●/MEDIA/AUDIO
< o-●/MEDIA/IR
< o-●/MEDIA/UART
```

Unsubscribe from a node

Command format: CLOSE●[nodePath]

Response format: c-●[nodePath]

Example:

```
> CLOSE●/MANAGEMENT/LOCK
< c-●/MANAGEMENT/LOCK
```

Unsubscribe from multiple nodes

In order to unsubscribe from multiple nodes, asterisk wildchar can be used.

Command format: CLOSE●[nodePath]/*

Response format: c-●[nodePath]/*

Example:

```
> CLOSE●/MANAGEMENT/*
< c-●/MANAGEMENT/*
```

7.2.7. Notifications about the changes of the properties

When the value of a property is changed and the user is subscribed to the node, which the property belongs to, an asynchronous notification is generated. This notification is called as the 'change message'. The format of such a message is very similar to the response for 'GET' command.

Format: CHG●[nodePath].[propertyName]=[newPropertyValue]

A short example of how to use the subscription

Below an example is presented, how the subscriptions work and how to use them. In the example there are two independent users controlling the device through two independent connections ('C #1' and 'C #2'). The events in the rows occur after each other.

C #1	<pre>> OPEN●/EDID < o-●/EDID > GET●/EDID.EdidStatus < pr●/EDID.EdidStatus=D1:E1;D1:E2</pre>	<ul style="list-style-type: none"> - User1 subscribes to /EDID node - User1 queries /EDID.EdidStatus
C #2	<pre>> GET●/EDID.EdidStatus < pr●/EDID.EdidStatus=D1:E1;D1:E2 > CALL●/EDID:switch(U1:E1) < mO●/EDID:switch</pre>	<ul style="list-style-type: none"> - User2 queries /EDID.EdidStatus - User2 switches EDID
C #1	<pre>> CHG●/EDID.EdidStatus=U1:E1;D1:E2 > CLOSE●/EDID < c-●/EDID</pre>	<ul style="list-style-type: none"> - User1 got a change message - User1 unsubscribes from the node

7.2.8. Signature

For some command the response can contain multiple lines. Every line is terminated with a carriage return (Cr, '\r') and line feed (Lf, '\n') characters. In several cases the number of the lines in the response cannot be determined in advance. In several cases the client is intended waiting for the whole response and also wants to be sure, that received lines belong together and to the same command. In these cases a special feature the 'signature' can be used.

The signature is a four-digit-long hexadecimal value that can be optionally placed before every command. In that case, the response to that particular command will also be preceded by the signature, and the corresponding lines will be in between brackets.

Command format: XXXX#[command]

Legend: xxxx: four-digit-long hexadecimal value.

Response format:

```
{XXXX
[command lines]
}
```

Example:

```
> 0001#GET●/MEDIA
< {0001
< n-●/MEDIA/VIDEO
< n-●/MEDIA/AUDIO
< n-●/MEDIA/UART
< n-●/MEDIA/IR
< n-●/MEDIA/PACKETROUTER
< }
```

Info: The lines of the signature are also Cr and Lf terminated.

7.2.9. Manual

For every property and method in the tree there is a manual. The manual is a human readable text that describes the syntax and provides a hint for how to use the primitives.

Command format:

for property: MAN●[nodePath].[propertyName]

for method: MAN●[nodePath]:[methodName]

Response format:

The human readable manual is separated by a space (' ') character from the primitives.

for properties: pm●[nodePath].[propertyName]●Human readable manual

for methods: mm●[nodePath]:[methodName]●Human readable manual

Example:

```
> MAN●/PRESETS.Count
< pm●/PRESETS.Count:[int] Number of presets
> MAN●/SYS/CORE:ResetLink
< mm●/SYS/CORE:ResetLink:Reset optical link.
```

7.2.10. Formal definitions

Method parameters and property values are specified in a modified version of Backus-Naur Form (BNF). The syntax is the following:

"literal"	literals are quoted
<expression1> <expression2>	vertical bars denote alternatives
[<expression>]	expressions in square brackets are optional
<number>*[<expression>]	expression is repeated at least <number> times
*[<expression>]	<number> may be omitted, in this case number defaults to 0
<number>{* <expression> }	expressions in curly brackets are repeated exactly <number> times

7.3. LW3 protocol tree

The /MEDIA node contains the sub nodes which are representing the different layers, e.g. video (/MEDIA/VIDEO), audio (/MEDIA/AUDIO) or RS-232 (/MEDIA/UART). Each layer has a crosspoint to define connections between the ports associated to the layer, all of them are represented by a specific node. E.g. the video layer node is /MEDIA/VIDEO: under the video layer node, the video crosspoint node (XP1) and the video ports (P1, P2, ...) are located.

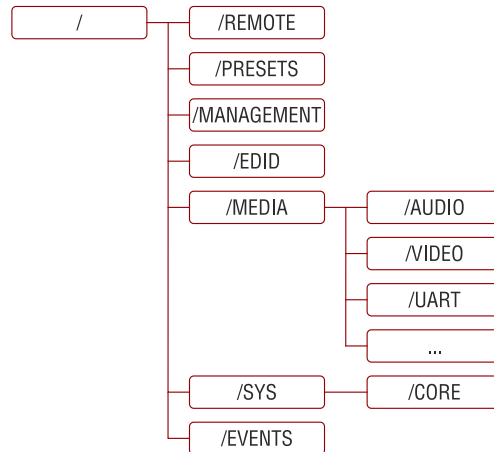

The exact content of the nodes (especially the /MEDIA node) depend on the installed modules. The tree structure is available via the Web (Advanced view), see section [6.10](#) on page [64](#).

7.3.1. /REMOTE

The node contains the protocol tree of the remote device (if connected): PRESETS, MANAGEMENT, EDID, MEDIA, SYS and EVENT sub nodes. Settings and values are valid for the remote device only below the /REMOTE node.

7.3.2. /PRESETS

Group node for the eight available presets; each preset has own sub node with its properties.

7.3.3. /MANAGEMENT/

A group node for every management related settings. The features and settings here are not related to the current crosspoint settings. The node contains the following sub nodes:

/MANAGEMENT/NETWORK

Contains Network-related properties, such as IP address, Gateway, Subnet mask, DHCP and Port settings.

/MANAGEMENT/STATUS

Basic status values are stored about the MODEX: Firmware versions, Internal Voltage values, Module code, System time (elapsed time since last booting in seconds).

/MANAGEMENT/LOCK

Installed modules can be locked/unlocked individually or together.

Info: The locking state is also stored under /SYS/CORE nodes and its sub nodes (as read-only property), but the settings can be done in /MANAGEMENT/LOCK.

/MANAGEMENT/LOG

Last logged events can be queried here. /MANAGEMENT/LOG node contains five properties (Warning, Error, Debug, Fatal and Notice), which shows the number of the occurrence of the given event type. The log can be emptied by the calling the *clearLog* method.

The node has five sub nodes (NOTICE, WARNING, ERROR, FATAL, DEBUG) which contain the log entries as a property describing the logged event with details.

7.3.4. /EDID

The node and its sub nodes represent all information about EDID management. The node contains basic methods in connection with EDID emulation such as Copy, Delete or Emulate EDID. Sub nodes refer to the type of the EDID as follows:

- F: Factory EDIDs,
- U: User EDID,
- D: Dynamic EDID (The EDID of the monitor last attached to the receiver),
- E: Emulated EDID (List of assigned video ports).

The node structure of Factory, User and Dynamic EDIDs contain the available EDIDs as sub nodes. The structure of these EDID sub nodes is the same:

- Header: *Valid/Invalid* (based on EDID header)
- Data: *EDID data* – in HEX format
- IsValid: *True/False* – (based on EDID data)

For detailed information about EDID memory see section [6.6.1](#) on page [50](#).

7.3.5. /MEDIA

MEDIA node contains the available layers on installed modules, such as VIDEO, AUDIO, UART or IR module. Port and Crosspoint settings are structured in sub nodes with methods and properties in the nodes of the layers.

7.3.6. /SYS

The node has two sub nodes: LOG and CORE.

/SYS/LOG

Last log events collected from last booting. The structure is the same as for /MANAGEMENT/LOG.

/SYS/CORE

The node contains properties of MODEX frame; nevertheless its sub nodes contain the installed modules (B, C, D and E). Signal parameters are listed in the sub nodes.

7.4. Video port and crosspoint settings

Info: Port numbers, commands and responses depend on the modules built in the given MODEX unit; see the P1..Pn properties under /MEDIA/VIDEO node.

7.4.1. Query the video crosspoint setting

Command format: GET●/MEDIA/VIDEO/XP1.DestinationConnectionList

Response format: pr●/MEDIA/VIDEO/XP1.DestinationConnectionList=<input>:<output>

Legend: <input>: Video input port number
<output>: Video output port number

Example:

```
> GET●/MEDIA/VIDEO/XP1.DestinationConnectionList
< pr●/MEDIA/VIDEO/XP1.DestinationConnectionList=P2:P3
```

7.4.2. Query the status of source ports

Command format: GET●/MEDIA/VIDEO/XP1.SourcePortStatus

Response format: pr●/MEDIA/VIDEO/XP1.SourcePortStatus=[<port#1>:<status>;<port#2>:<status>;...;<port#n>:<status>]

Example:

```
> GET●/MEDIA/VIDEO/XP1.SourcePortStatus
< pr●/MEDIA/VIDEO/XP1.SourcePortStatus=P2:T000B
```

Legend

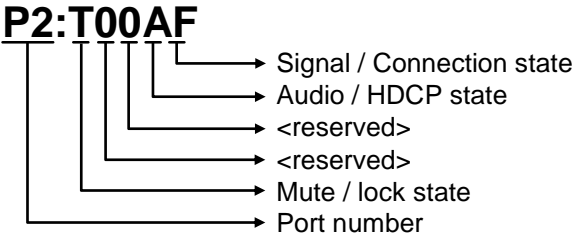

Mute / lock state	T: unlocked, unmuted L: locked, unmuted M: unlocked, muted U: locked, muted
Audio / HDCP state	0: audio unknown, HDCP state unknown 1: audio signal unknown 2: audio unknown, not HDCP-encrypted 3: audio unknown, HDCP-encrypted 4: HDCP state unknown 5: <reserved> 6: signal is not HDCP-encrypted 7: signal is HDCP-encrypted 8: embedded audio not present, HDCP state unknown 9: embedded audio not present A: embedded audio not present, signal is not HDCP-encrypted B: embedded audio not present, signal is HDCP-encrypted C: embedded audio is present, HDCP state unknown D: embedded audio is present E: embedded audio is present, signal is not HDCP-encrypted F: embedded audio is present, signal is HDCP-encrypted
Signal / connection state	0: Signal and connection states unknown 1: Signal state unknown 2: Signal state unknown, no connection 3: Signal state unknown, connection established 4: Connection state unknown 5: <reserved> 6: No connection 7: Connection is established 8: Signal not present, connection state unknown 9: Signal not present A: Signal not present, no connection B: Signal not present, connection established C: Signal present, connection state unknown D: Signal present E: Signal present, no connection F: Signal present, connection established

Explanation: (P2:T00AF) Video signal is connected and present on Port#2, the signal does not contain audio and not HDCP-encrypted. The port is unlocked, unmuted.

7.4.3. Mute an input port

Command format: CALL●/MEDIA/VIDEO/XP1:muteSource(<input>)

Response format: mO●/MEDIA/VIDEO/XP1:muteSource

Legend: <input>: Input port number

Example:

```
> CALL●/MEDIA/VIDEO/XP1:muteSource(P1)
< mO●/MEDIA/VIDEO/XP1:muteSource
```

7.4.4. Unmute an input port

Command format: CALL●/MEDIA/VIDEO/XP1:unmuteSource(<input>)

Response format: mO●/MEDIA/VIDEO/XP1:unmuteSource

Legend: <input>: Input port number

Example:

```
> CALL●/MEDIA/VIDEO/XP1:unmuteSource(P1)
< mO●/MEDIA/VIDEO/XP1:unmuteSource
```

7.4.5. Lock an input port

Command format: CALL●/MEDIA/VIDEO/XP1:lockSource(<input>)

Response format: mO●/MEDIA/VIDEO/XP1:lockSource

Legend: <input>: Input port number

Example:

```
> CALL●/MEDIA/VIDEO/XP1:lockSource(P1)
< mO●/MEDIA/VIDEO/XP1:lockSource
```

7.4.6. Unlock an input port

Command format: CALL●/MEDIA/VIDEO/XP1:unlockSource(<input>)

Response format: mO●/MEDIA/VIDEO/XP1:unlockSource

Legend: <input>: Input port number

Example:

```
> CALL●/MEDIA/VIDEO/XP1:unlockSource(P1)
< mO●/MEDIA/VIDEO/XP1:unlockSource
```

7.4.7. Mute the output

Command format: CALL●/MEDIA/VIDEO/XP1:muteDestination(<output>)

Response format: mO●/MEDIA/VIDEO/XP1:muteDestination

Legend: <output>: Output port number

Example:

```
> CALL●/MEDIA/VIDEO/XP1:muteDestination(P2)
< mO●/MEDIA/VIDEO/XP1:muteDestination
```

7.4.8. Unmute the output

Command format: CALL●/MEDIA/VIDEO/XP1:unmuteDestination(<output>)

Response format: mO●/MEDIA/VIDEO/XP1:unmuteDestination

Legend: <output>: Output port number

Example:

```
> CALL●/MEDIA/VIDEO/XP1:unmuteDestination(P2)
< mO●/MEDIA/VIDEO/XP1:unmuteDestination
```

7.4.9. Lock the output

Command format: CALL●/MEDIA/VIDEO/XP1:lockDestination(<output>)

Response format: mO●/MEDIA/VIDEO/XP1:lockDestination

Legend: <output>: Output port number

Example:

```
> CALL●/MEDIA/VIDEO/XP1:lockDestination(P2)
< mO●/MEDIA/VIDEO/XP1:lockDestination
```

7.4.10. Unlock the output

Command format: CALL●/MEDIA/VIDEO/XP1:unlockDestination(<output>)

Response format: mO●/MEDIA/VIDEO/XP1:unlockDestination

Legend: <output>: Output port number

Example:

```
> CALL●/MEDIA/VIDEO/XP1:unlockDestination(P2)
< mO●/MEDIA/VIDEO/XP1:unlockDestination
```

7.5. Audio port and crosspoint settings

Info: Port numbers, commands and responses depend on the modules built in the given MODEX unit; see the P1..Pn properties under /MEDIA/AUDIO node.

There are two audio groups in MODEX extenders: S/PDIF and Main audio groups. This is also visible in the protocol tree:

- /MEDIA/AUDIO/XP1 : node of the audio ports within S/PDIF group
- /MEDIA/AUDIO/XP2 : node of the audio ports within Main audio group

Info: The available ports within a group depend on the audio module setting. See more information in section [6.3.2](#) on page [39](#).

7.5.1. Query the audio crosspoint setting

Command format: GET●/MEDIA/AUDIO/XP1.DestinationConnectionList

Response format: pr●/MEDIA/AUDIO/XP1.DestinationConnectionList=<input>:<output>

Legend: <input>: Audio input port number

<output>: Audio output port number

Example:

```
> GET●/MEDIA/AUDIO/XP1.DestinationConnectionList
< pr●/MEDIA/AUDIO/XP1.DestinationConnectionList=P6:P4;P3:P8
```

Explanation: P6 input is connected to P4 output, P3 input is connected to P8 output.

7.5.2. Switching audio input

Command format: CALL●/MEDIA/AUDIO/XP1:switch(<input>:<output>)

Response format: mO●/MEDIA/AUDIO/XP1:switch

Legend: <input>: Audio input port number
<output>: Audio output port number

Example:

```
> CALL●/MEDIA/AUDIO/XP1:switch(P3:P4)
< mO●/MEDIA/AUDIO/XP1:switch
```

Explanation: P3 input port is switched to P4 output port.

Info: The current audio mode determines the possible crosspoint switches.

7.6. RS-232 port configuration

7.6.1. BAUD rate setting

Command format: SET●/MEDIA/UART/P1.Baudrate=<baud_value>

Response format: pw●/MEDIA/UART/P1.Baudrate=<baud_value>

Example:

```
> SET●/SYS/MB/RS232/Local.Baudrate=9600
< pw●/SYS/MB/RS232/Local.Baudrate=9600
```

Parameters:

<baud_value>: Baud rate value between 75 and 18432000

7.6.2. Databit setting

Command format: SET●/MEDIA/UART/P1.DataBits=<databit_value>

Response format: pw●/MEDIA/UART/P1.DataBits=<databit_value>

Example:

```
> SET●/MEDIA/UART/P1.DataBits=8
< pw●/MEDIA/UART/P1.DataBits=8
```

Parameters:

<databit_value>: Databit value between 1 and 15

7.6.3. Stopbit setting

Command format: SET●/MEDIA/UART/P1.StopBits={0|1|2}

Response format: pw●/MEDIA/UART/P1.StopBits={0|1|2}

Example:

```
> SET●/MEDIA/UART/P1.StopBits=0
< pw●/MEDIA/UART/P1.StopBits=0
```

Parameters:

.StopBits	Stopbit value
0	1
1	1,5
2	2

7.6.4. Parity setting

Command format: SET●/MEDIA/UART/P1.Parity={0|1|2|3|4}

Response format: pw●/MEDIA/UART/P1.Parity={0|1|2|3|4}

Example:

```
> SET●/MEDIA/UART/P1.Parity=0
< pw●/MEDIA/UART/P1.Parity=0
```

Parameters:

.Parity	Parity setting
0	no parity
1	odd
2	even
3	zero
4	one

7.7. Network configuration

7.7.1. Query the DHCP state

Command format: GET●/MANAGEMENT/NETWORK.DhcpEnabled

Response format: pw●/MANAGEMENT/NETWORK.DhcpEnabled={true|false}

Example:

```
> GET●/MANAGEMENT/NETWORK.DhcpEnabled
< pw●/MANAGEMENT/NETWORK.DhcpEnabled=true
```

7.7.2. Change the DHCP state

Command format: SET●/MANAGEMENT/NETWORK.DhcpEnabled={true|false}

Response format: pw●/MANAGEMENT/NETWORK.DhcpEnabled={true|false}

Example:

```
> SET●/MANAGEMENT/NETWORK.DhcpEnabled=false
< pw●/MANAGEMENT/NETWORK.DhcpEnabled=false
```

7.7.3. Query the IP address (dynamic)

Command format: GET●/MANAGEMENT/NETWORK.IpAddress

Response format: pr●/MANAGEMENT/NETWORK.IpAddress=<IP_address>

Example:

```
> GET●/MANAGEMENT/NETWORK.IpAddress
< pr●/MANAGEMENT/NETWORK.IpAddress=192.168.0.102
```

7.7.4. Change the IP address (static)

Command format: SET●/MANAGEMENT/NETWORK.StaticIpAddress=<IP_address>

Response format: pw●/MANAGEMENT/NETWORK.StaticIpAddress=<IP_address>

Example:

```
> SET●/MANAGEMENT/NETWORK.StaticIpAddress=192.168.0.105
< pw●/MANAGEMENT/NETWORK.StaticIpAddress=192.168.0.105
```

7.7.5. Query the subnet mask (static network mask)

Command format: GET●/MANAGEMENT/NETWORK.StaticNetworkMask

Response format: pr●/MANAGEMENT/NETWORK.StaticNetworkMask=<netmask>

Example:

```
> GET●/MANAGEMENT/NETWORK.StaticNetworkMask
< pr●/MANAGEMENT/NETWORK.StaticNetworkMask=255.255.255.0
```

7.7.6. Change the subnet mask (static)

Command format: SET●/MANAGEMENT/NETWORK.StaticNetworkMask=<netmask>

Response format: pw●/MANAGEMENT/NETWORK.StaticNetworkMask=<netmask>

Example:

```
> SET●/MANAGEMENT/NETWORK.StaticNetworkMask=255.255.255.0
< pw●/MANAGEMENT/NETWORK.StaticNetworkMask=255.255.255.0
```

Info: Device needs to be restarted to apply changes.

7.7.7. Query the gateway address (static)

Command format: GET●/MANAGEMENT/NETWORK.GatewayAddress

Response format: pr●/MANAGEMENT/NETWORK.GatewayAddress=<gw_address>

Example:

```
> GET●/MANAGEMENT/NETWORK.GatewayAddress
< pr●/MANAGEMENT/NETWORK.GatewayAddress=192.168.0.1
```

7.7.8. Change the gateway address (static)

Command format: SET●/MANAGEMENT/NETWORK.StaticGatewayAddress=
<gw_address>

Response format: pr●/MANAGEMENT/NETWORK.StaticGatewayAddress=
<gw_address>

Example:

```
> SET●/MANAGEMENT/NETWORK.StaticGatewayAddress=192.168.0.5
< pw●/MANAGEMENT/NETWORK.StaticGatewayAddress=192.168.0.5
```

7.8. Event settings (conditions and actions)

32 events can be configured in the transmitter, these nodes are located under /EVENTS. More details can be found in section [6.8](#) on page [54](#).

The process of setting an event/action by protocol commands is described step-by-step through a simple example. The event will be set under the /EVENTS/E1 node and the desired setting is:

IF SIGNAL IS PRESENT ON INPUT PORT P1, SEND AN RS-232 MESSAGE ON SERIAL PORT 1.

The settings are stored in 6 different properties which are described in the following sections.

7.8.1. Set the source node (condition)

Command format: SET●/EVENTS/E<event_nr>.SourceNode=
<node_path>"/"<node_name>

Response format: pw●/EVENTS/E<event_nr>.SourceNode=
<node_path>"/"<node_name>

Example:

```
> SET●/EVENTS/E1.SourceNode=/MEDIA/VIDEO/P1
< pw●/EVENTS/E1.SourceNode=/MEDIA/VIDEO/P1
```

Explanation: This node contains the path of the property that will fire the E1 event (the path of the P1 video input port).

Info: Node path must be started with "/".

7.8.2. Set the source property (condition)

Command format: SET●/EVENTS/E<event_nr>.SourceProperty=<property>

Response format: pw●/EVENTS/E<event_nr>.SourceProperty=<property>

Example:

```
> SET●/EVENTS/E1.SourceProperty=SignalPresent
< pw●/EVENTS/E1.SourceProperty=SignalPresent
```

Explanation: This node contains the property that will fire the E1 event (signal present state of P1 port).

7.8.3. Set the value of the source property (condition)

Command format: SET●/EVENTS/E<event_nr>.SourcePropertyValue=<value>

Response format: pw●/EVENTS/E<event_nr>.SourcePropertyValue=<value>

Example:

```
> SET●/EVENTS/E1.SourcePropertyValue=1
< pw●/EVENTS/E1.SourcePropertyValue=1
```

Explanation: The E1 event will be fired, if this property is changed to the set value (signal is present on input port P1).

7.8.4. Set the target node (action)

Command format: SET●/EVENTS/E<event_nr>.TargetNode=
<node_path>"/"<node_name>

Response format: pw●/EVENTS/E<event_nr>.TargetNode=
<node_path>"/"<node_name>

Example:

```
> SET●/EVENTS/E1.TargetNode=/MEDIA/UART/P1
< pw●/EVENTS/E1.TargetNode=/MEDIA/UART/P1
```

Explanation: This node contains the path of the property that will be changed after the E1 event is fired.

Info: Node path must be started with "/".

7.8.5. Set the target property (action)

Command format: SET●/EVENTS/E<event_nr>.TargetProperty=<property>

Response format: pw●/EVENTS/E<event_nr>.TargetProperty=<property>

Example:

```
> SET●/EVENTS/E1.TargetProperty=SendMessage
< pw●/EVENTS/E1.TargetProperty=SendMessage
```

Explanation: The node contains the property that will be changed after E1 event is fired.

7.8.6. Set the value of the target property (action)

Command format: SET●/EVENTS/E<event_nr>.TargetPropertyValue=<value>

Response format: pw●/EVENTS/E<event_nr>.TargetPropertyValue=<value>

Example:

```
> SET●/EVENTS/E1.TargetPropertyValue=Sample_message
< pw●/EVENTS/E1.TargetPropertyValue=Sample_message
```

Explanation: If the E1 event is fired, this value will be stored in the set target property.

7.9. EDID management

7.9.1. Query the emulated EDIDs

Command format: GET●/EDID.EdidStatus

Response format: pr●/EDID.EdidStatus(["*{\<edid_id>":"<emulated_edid_id>";"}])

Example:

```
> GET●/EDID.EdidStatus
< pr●/EDID.EdidStatus=D1:E1;D1:E2
```

Explanation: The available video input ports are listed and the emulated EDID's number is displayed. E.g. D1 (Dynamic) EDID is emulated on E1 input.

7.9.2. Query the validity of a dynamic EDID

Command format: GET●/EDID/D/D1.Validity

Response format: pr●/EDID/D/D1.Validity={true|false}

Example:

```
> GET●/EDID/D/D1.Validity
< pr●/EDID/D/D1.Validity=true
```

Explanation: The 'Validity' property is true, valid EDID is stored in D1 memory place.

7.9.3. Query a user EDID header

Command format: GET●/EDID/U/U1.Header

Response format: pr●/EDID/U/U1.Header={"Invalid"|<edid_header>}

Legend: <edid_header>: ID of manufacturer; preferred timing; monitor name

Example1:

```
> GET●/EDID/U/U1.Header
< pr●/EDID/U/U1.Header=Invalid
```

Explanation1: The memory place U1 does not contain valid EDID.

Example2:

```
> GET●/EDID/U/U2.Header
< pr●/EDID/U/U2.Header=LWR;640x480@60.0Hz;D640x480p60
```

Explanation2: The memory place U2 contains valid EDID.

7.9.4. Emulating an EDID to an input port

Command format: CALL●/EDID:switch(<source>:<destination>)

Response format: mO●/EDID:switch

Example:

```
> CALL●/EDID:switch(F49:E2)
< mO●/EDID:switch
```

Legend: <source>: Source EDID memory places that can be Factory, User or Dynamic EDID memory.

<destination>: The emulated EDID memory of the desired input port.

7.9.5. Copy an EDID to user memory

Command format: CALL●/EDID:copy(<source>:<destination>)

Response format: mO●/EDID:copy

Example:

```
> CALL●/EDID:copy(D1:U1)
< mO●/EDID:copy
```

Legend: <source>: Source EDID memory places that can be Factory, User or Dynamic EDID memory.

<destination>: User EDID memory place (U1...U31).

Explanation: The EDID of the last connected sink (Dynamic EDID, D1) has been copied to the user memory (U1).

7.9.6. Deleting an EDID from user memory

Command format: CALL●/EDID:delete(<user_edid_memory>)

Response format: mO●/EDID:delete

Example:

```
> CALL●/EDID:delete(U1)
< mO●/EDID:delete
```

7.9.7. Resetting emulated EDIDs

Command format: CALL●/EDID:reset(1)

Response format: mO●/EDID:reset

Example:

```
> CALL●/EDID:reset(1)
< mO●/EDID:reset
```

Explanation: Calling this method switches all emulated EDIDs to factory default one. See the table in section [11.2](#) on page [111](#).

8. Firmware upgrade

MODEX can be upgraded by connecting a Windows PC via LAN and using Lightware Device Updater (LDU). The application can be downloaded from www.lightware.eu. In order to get the firmware pack with the necessary components (*.lfp file) for your specific product, please contact support@lightware.eu. LDU can be installed to a Windows PC.

Info: While the firmware is being upgraded, normal operation mode is suspended as the extender is switched to bootload mode. Signal processing between the extenders is not performed. Do not interrupt the firmware upgrade. If any problem occurs, switch off the extender and restart the process.

Info: User EDID memory or settings are not modified/erased during the upgrade.

Important! Always upgrade both extenders of a MODEX pair: if you upgrade the transmitter, use the same firmware package also on the receiver. More devices can be upgraded at the same time: in this case connect them to the LAN via Ethernet and make sure they are not connected to each other by fiber optical cable.

8.1. Short instructions

- Step 1.** Get the firmware pack and the Lightware Device Updater (LDU) application.
- Step 2.** Install the LDU application.
- Step 3.** Connect the computer to the MODEX device(s).
- Step 4.** Start the LDU and follow the instructions shown on the screen.

8.2. Detailed instructions

8.2.1. Get the firmware pack and the LDU application

In order to get the firmware pack with the necessary components (*.lfp file) for your device(s), please contact support@lightware.eu. The LDU application can be downloaded from www.lightware.eu.

8.2.2. Install the LDU application

- Step 1.** Run `install_LDU_v1.0.7b1.exe`.

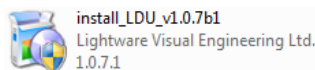

- Step 2.** Click Next in the opening Welcome window.



Step 3. Select the type of the installation. Here can be chosen the normal and the snapshot install. Select the optional components then click Next. (Using the Normal install as the default value is highly recommended.)

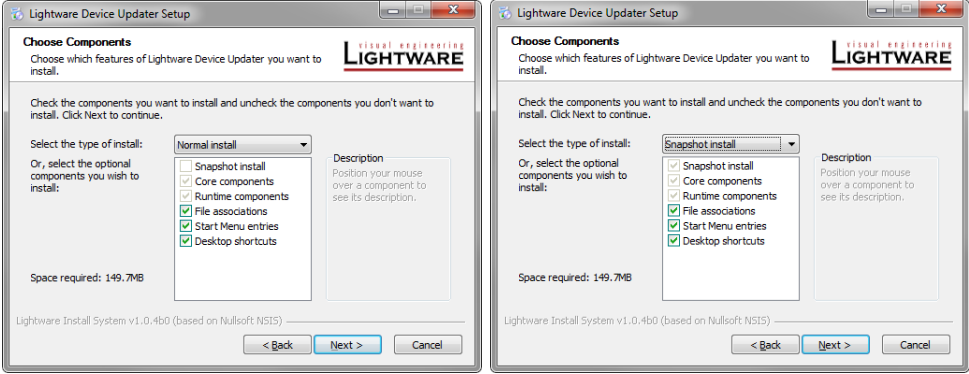

Normal install (recommended)	Snapshot install
The installer can update only this instance.	Cannot be updated.
One only updateable instance can exist for all users.	More than one different version can be installed for all users.
Does not contain the version in its name.	Version number is displayed in the name.

Step 4. Select the destination folder and click Next. (Using the default path is highly recommended.)

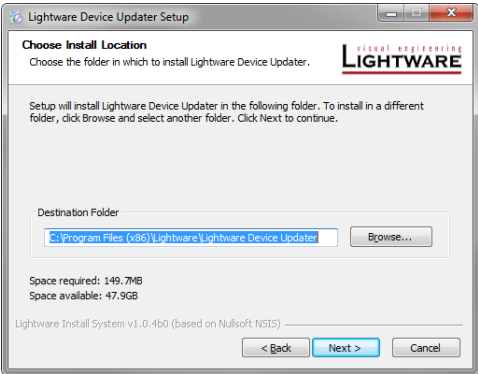

Step 5. Select the Start menu folder and click Next. (Using the default folder is highly recommended. If the Start menu entries was not checked in the Step 2, this window will be skipped.)

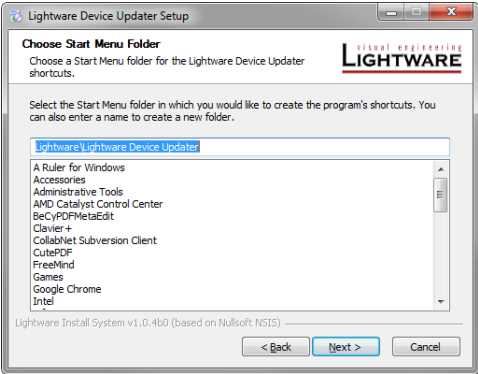

Step 6. Verify the settings and click **I**nstall, or click **B**ack and change the settings.

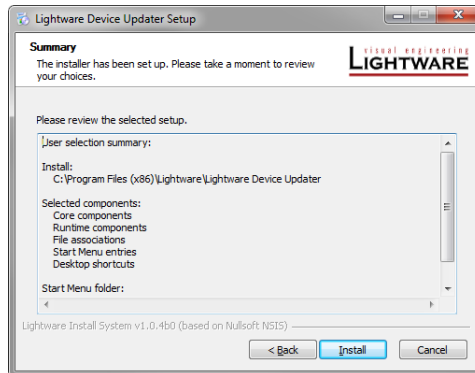

Step 7. After the installation of the last component the **N**ext button is activated – click on it.

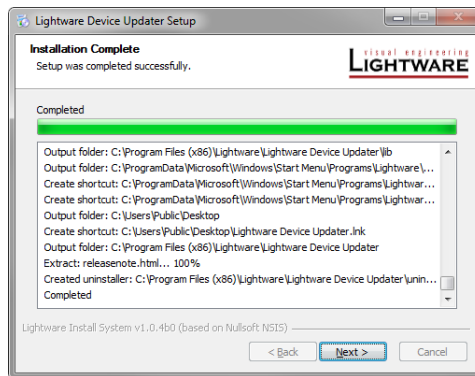

Step 8. If the installation is complete, click **F**inish.



Upgrade the LDU

Step 1. Run the application.

Step 2. In the welcome screen click on the  button in the top right corner – the About window will appear. Click on the *Update* button.



Step 3. The program checks the available updates on Lightware website and shows its version. Set the desired update settings in the *Options* section.

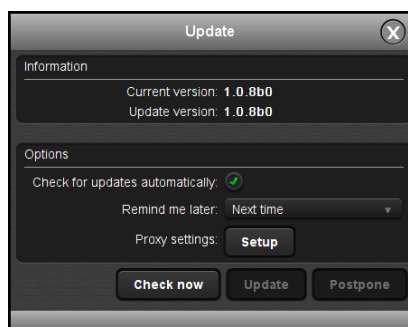

8.2.3. Connect the computer to the MODEX device(s)

Make sure that the computer and the MODEX are connected and the connection is established either by a patch cable via LAN, or directly by a cross-link cable.

Important! Do not connect more than one port of a MODEX to the same LAN to avoid loops. In the same way, if you want to upgrade the firmware of a transmitter and a receiver, connect both to the LAN, but make sure they are not connected via fiber optical cable.

8.2.4. Start the LDU and follow the instructions shown on the screen

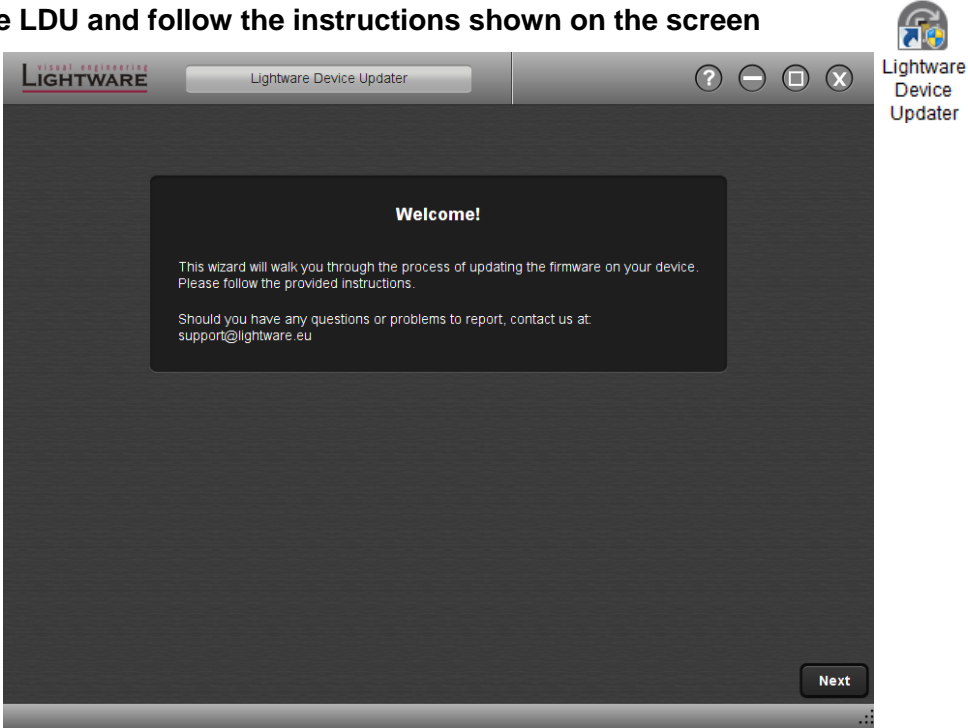

The welcome screen will appear, click on Next button.

Step 1. Select package

Select the package (*.lfp file) on the computer that will be used for the upgrading. Click on Browse button and select the file.

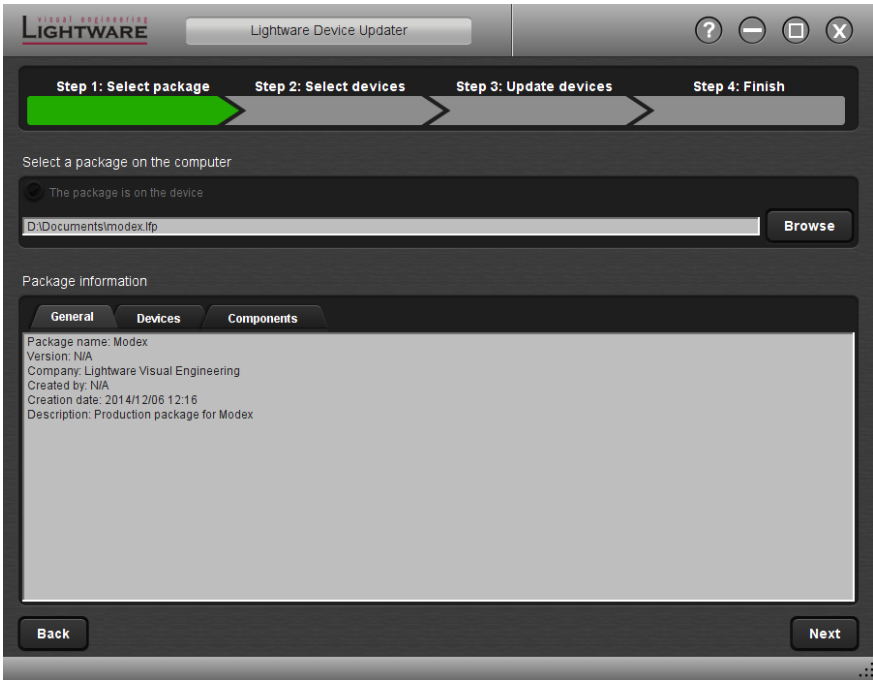

Package information is loaded to the tabs:

- **General** version info, creation date, short description,
- **Devices** which are compatible with the firmware,
- **Components** in the package with release notes.

Click on Next button and follow the instructions below:

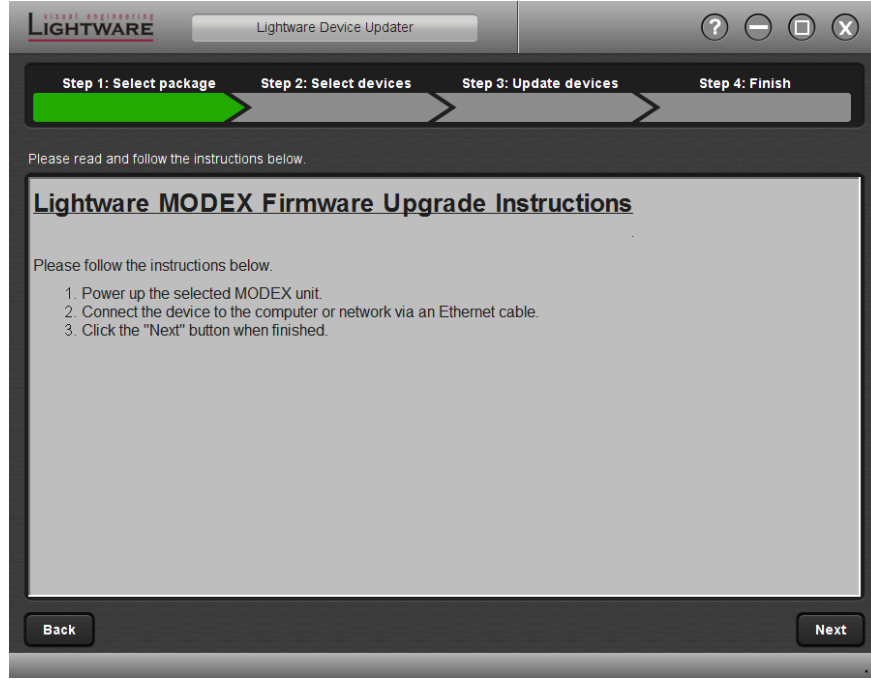

Info: This window can be also displayed by pressing the  button.

Info: Files with “.lfp” extension are associated to LDU during installation. If you double click on the “.lfp” file, the application is run and the package is loaded automatically. In this case you will see above screen.

Step 2. Select devices

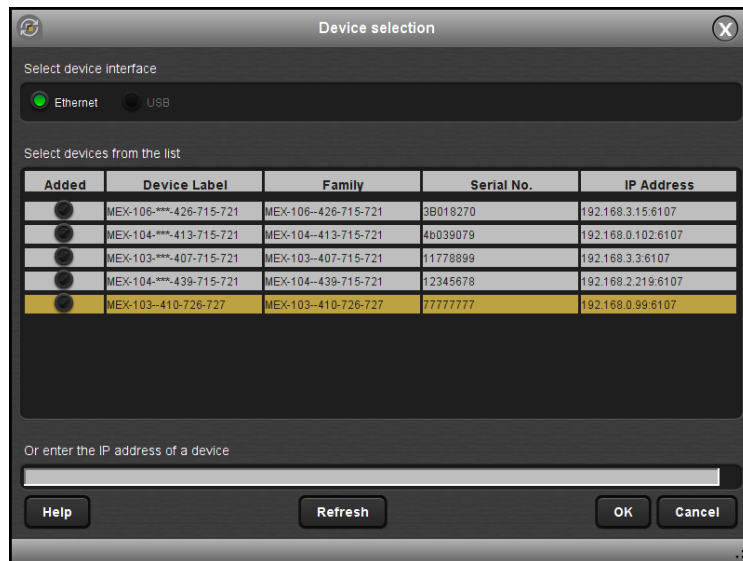

The following step is to select the device(s) which will be updated. The available and supported devices are searched and listed automatically; currently, LDU is able to update the firmware of devices connected via Ethernet or USB port. MODEX can be updated via Ethernet. If the desired device is not listed, update the list by clicking the Refresh button and/or type its IP address in the line.

Select the desired devices: highlight them with yellow cursor, then click *OK*.

The firmware components of the devices are listed on the following screen; their version and the one that is available in the browsed package. Update versions will be uploaded into the device(s).

Info: The media connector code of the MODEX is replaced by *******, since it has no importance from firmware upgrade point of view.

Info: If MODEX cannot send the details about its firmware, click on the *Use Bootloader* button:

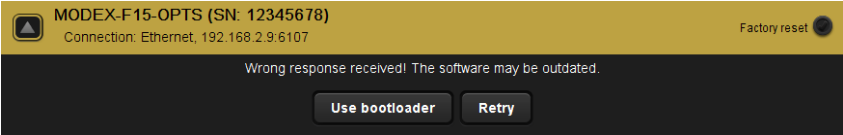

Add a device by clicking on the Add device button. The previous screen will be shown; devices, what have already been added are marked in the first column. Select the desired device(s) and click on *OK*.

Remove a device by selecting it (highlight with yellow) and click on Remove device button; or click on Remove all button to empty the list.

Factory reset can be executed by ticking the option on the right. The settings has the same effect as resetting the device from front panel.

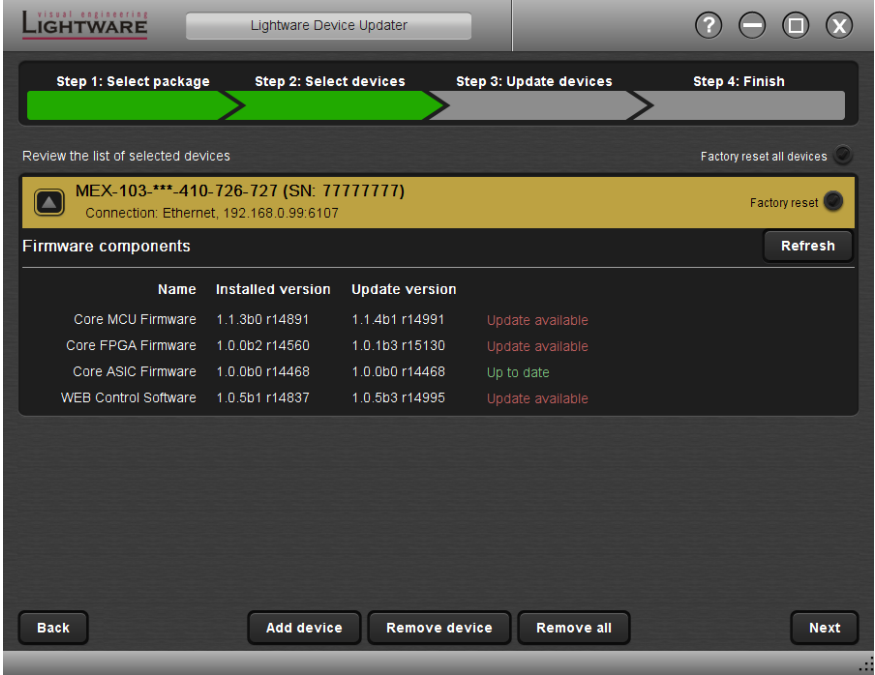

Click on Next button to step forward.

Step 3. Update devices

The selected devices are listed with their status. The setup is logged automatically; the default path can be changed by ticking the option and browsing a folder.

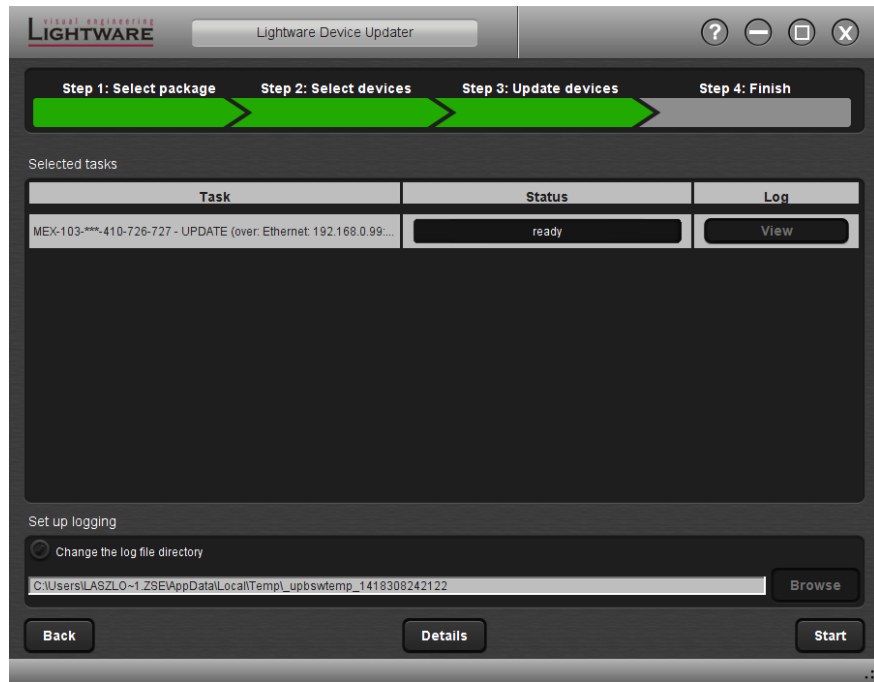

Start button begins the upgrade process.

Details button opens a new window that displays the process.

If the upgrade of a device is finished, its log can be opened by the View button on the right. When all the tasks are finished, a windows appears. Click OK to close and Next to display the summary page.

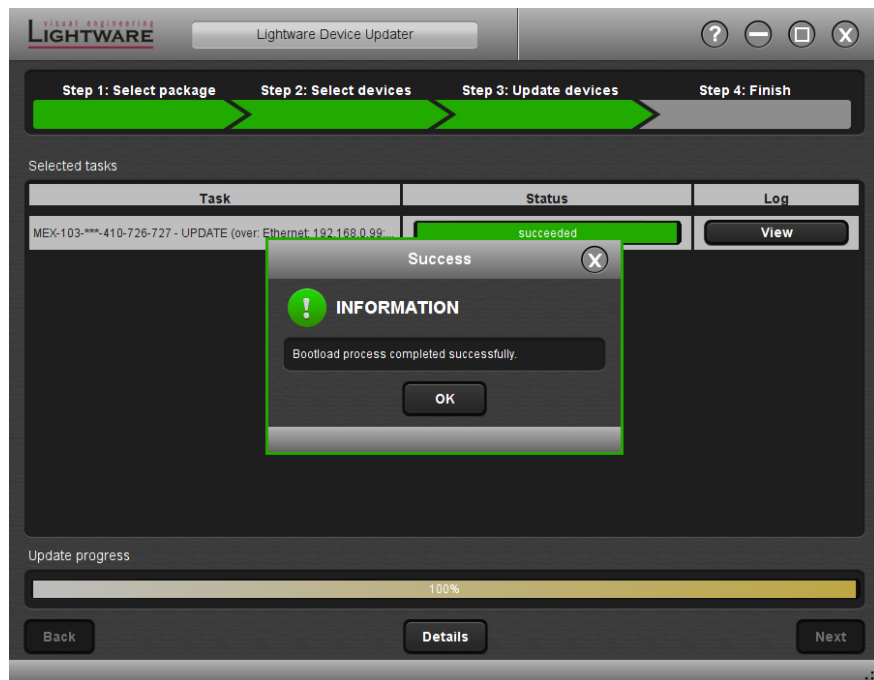

Step 4. Finish

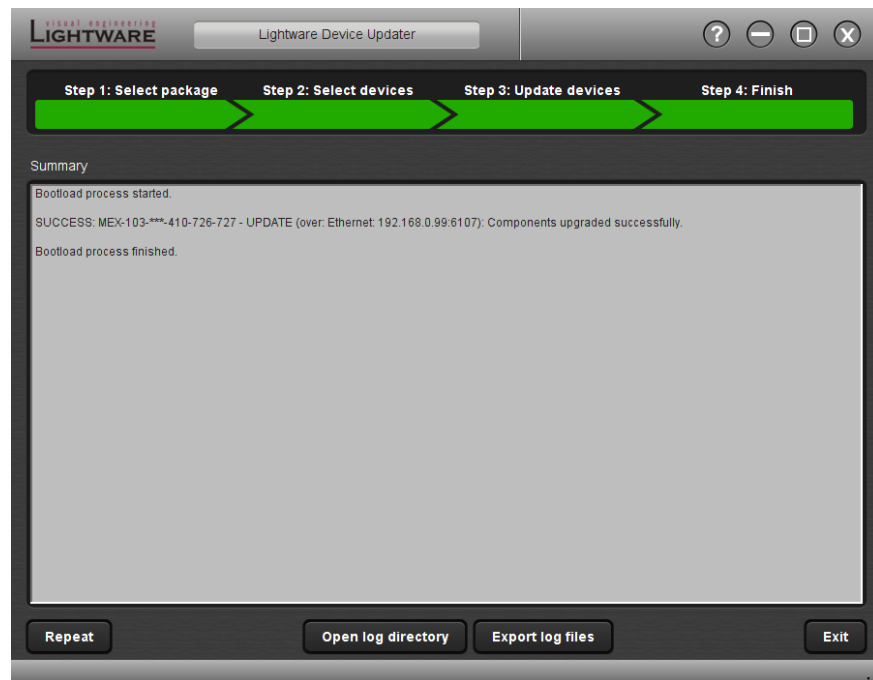

Repeat button starts the process again with the selected device(s).

Open log directory shows the temporary folder where the logs can be found.

Export log files by saving them as a zipped file.

Press **Exit** to close the program. However the devices are rebooted after the firmware upgrade, switching off and on again is recommended.

9. Specifications

9.1. Frames

9.1.1. MODEX-F15 frames

Control

Front panel buttons	Yes
Front panel LCD.....	Yes, 2 x 16 characters
Web.....	Built-in website (TCP/IP Ethernet)
EDID management (transmitter)	119 factory and 31 user programmable EDID
EDID emulation.....	256-Byte Extended EDID v1.3

Connectors

Ethernet	RJ45 connector
USB KVM (transmitter)	1 x USB-B female connector
USB KVM (receiver).....	2 x USB-A female connector

Ethernet specification

Ethernet	10/100 Mbit/s
----------------	---------------

USB specifications

USB standards.....	Only HID devices, Smart Card
USB HUB	Not supported
Device number.....	2xUSB HID devices

General

Dimensions	221 W x 240 D x 42.5 H mm
Weight.....	1850 g (excluding all modules)
Power consumption	6.5 W (typical), 8 W (max) without modules
.....	15 W (typical) 25 W (max) with modules
Power.....	IEC 110-230V
ESD protection.....	IEC61000-4-2 Level 4
Operation temperature.....	0°C to +50°C
Storage temperature	-20°C to +85°C
Humidity	10% to 90% non-condensing
Compliance	CE
Warranty	3 years

9.2. Media connectors

9.2.1. MODEX-OPTS and MODEX-OPTM

Fiber specifications

Link speed.....	6.25 Gbps
Single mode fiber wavelength.....	1310, 1490, 1550 nm
Multimode fiber wavelength	850, 1310, 1550 nm
Single mode extension distance	10 km (32800 ft)
Multimode extension distance	300 m (1000 ft)
Optical transmission channel 1	OPTS/OPTM connection
Optical transmission channel 2	currently not in use

Connectors*

Fiber optical	Neutrik opticalCON connector
Fiber optical	LC ODVA
Fiber optical	ST receptacle
Fiber optical	SC receptacle
Fiber optical	Neutrik opticalCON connector
Power connector	IEC C14 AC
Power connector	PowerCON AC

* The exact type depends on the selected Media connector

Video specifications

Supported video resolutions	Up to 4K (30 Hz, 4:2:2, 297 MHz, 24 bit)
Max pixel clock.....	297 MHz
Frame delay	No delay
Video signal latency	Approx. 3 lines

Audio specification

Embedded audio*	8 channel PCM or HBR compressed
Return AUX.....	4 channel PCM or 5.1 compressed
Forward audio	2 channel PCM or 5.1 compressed
Return audio	2 channel PCM or 5.1 compressed

* The embedded audio in the video stream can be switched to any other audio

9.3. Video & Audio modules

9.3.1. MODEX-AV-DVIDL-IM

Part number	9161 0401
Max resolution.....	2560x1600@60Hz
.....	1920x1200@120Hz
Max cable length (22 AWG).....	20 m
Color depth	8 bit per color
Color space.....	RGB
Frame delay	No delay
Data rate	Total max 9.9 Gbps
Max pixel clock.....	165 MHz
Supported video formats.....	DVI 1.0
3D support	Yes
Embedded audio / Return audio	No / No
EDID emulation.....	Yes, Advanced EDID management
HDCP compliancy.....	1.1
Audio capability.....	Not supported
Weight.....	100 g
Power consumption	1.4W (typ), 2W (max)
Connectors.....	DVI-D
ESD protection.....	IEC61000-4-2 Level 4

9.3.2. MODEX-AV-DVIDL-OM

Part number	9161 0404
Max resolution.....	2560x1600@60Hz
.....	1920x1200@120Hz
Color depth	8 bit per color, RGB
Frame delay	No delay
Data rate	Total max 9.9 Gbps
Max pixel clock.....	165 MHz
Supported video formats.....	DVI 1.0
3D support	Yes
Embedded audio / Return audio	No / No
EDID emulation.....	Yes, Advanced EDID management
HDCP compliancy.....	1.3
Audio capability.....	Not supported
Weight.....	100 g
Power consumption	3.5W (typ), 3.5W (max)
Connectors.....	DVI-D
ESD protection.....	IEC61000-4-2 Level 4

9.3.3. MODEX-AV-HDMI-DVI-IM

Part number	9161 0407
Max resolution.....	1920x1200@36 bit
.....	1600x1200@24 bit
Max cable length (22 AWG).....	30 m
Color depth	24, 30, 36 bit deep color
Color space.....	RGB, YCbCr 4:4:4/4:2:2
Frame delay	No delay
Data rate	Total max 6.75 Gbps
Max pixel clock.....	225 MHz
Supported video formats.....	DVI 1.0, HDMI 1.3a
3D support	No
Embedded audio / Return audio	Yes / No
EDID emulation.....	Yes, Advanced EDID management
HDCP compliancy.....	1.3
Audio capability*	8 channel PCM or HBP compressed
Weight.....	105 g
Power consumption	1.3 W (typ) 2.2 W (max)
Connectors.....	DVI-D, HDMI
ESD protection.....	IEC61000-4-2 Level 4

* The transmitted audio depends on the Media connector. For final audio transmission capabilities please see the audio specification of the chosen Media connector.

9.3.1. MODEX-AV-HDMI-DVI-4K-IM

Part number	9161 0410
Max resolution.....	1600x1200@60Hz, 36 bit
.....	3840x2160@30Hz, 24 bit
.....	1920x1080p@120Hz, 24 bit
Max cable length (22 AWG).....	30 m
Color depth	24, 30, 36 bit deep color
Color space.....	RGB, YCbCr 4:4:4/4:2:2
Frame delay	No delay
Data rate	9 Gbps
Max pixel clock.....	300 MHz
Supported video formats.....	DVI 1.0, HDMI 1.4
3D support	Yes
Embedded audio / Return audio	Yes / No
EDID emulation.....	Yes, Advanced EDID management
HDCP compliancy.....	1.4
Audio capability*	8 channel PCM or HBR compressed
Weight.....	105 g

Power consumption	2.75W (max)
Connectors.....	DVI-D, HDMI
ESD protection.....	IEC61000-4-2 Level 4

* The transmitted audio depends on the Media connector. For final audio transmission capabilities please see the audio specification of the chosen Media connector.

9.3.2. MODEX-AV-HDMI-OM

Part number	9161 0413
Max resolution.....	1920x1200@36bit
.....	1600x1200@24bit
Color depth	24, 30, 36 bit deep color
Color space.....	RGB, YCbCr 4:4:4/4:2:2
Frame delay	No delay
Data rate	Total max 6.75 Gbps
Max pixel clock.....	225 MHz
Supported video formats.....	DVI 1.0, HDMI 1.3a
3D support	No
Embedded audio / Return audio	Yes / No
EDID emulation.....	Yes, Advanced EDID management
HDCP compliancy.....	1.3
Audio capability*	8 channel PCM or HBP compressed
Weight.....	95 g
Power consumption	0.4 W (typ) 0.7 W (max)
Connectors.....	HDMI
ESD protection.....	IEC61000-4-2 Level 4

* The transmitted audio depends on the Media connector. For final audio transmission capabilities please see the audio specification of the chosen Media connector.

9.3.3. MODEX-AV-HDMI-4K-OM

Part number	9161 0416
Max resolution.....	1600x1200@60Hz, 36 bit
.....	3840x2160@30Hz, 24 bit
.....	1920x1080p@120Hz, 24 bit
Color depth	24, 30, 36 bit deep color
Color space.....	RGB, YCbCr 4:4:4/4:2:2
Frame delay	No delay
Data rate	9 Gbps
Max pixel clock.....	300 MHz
Supported video formats.....	DVI 1.0, HDMI 1.4
3D support	Yes
Embedded audio / Return audio	Yes / No

EDID emulation	Yes, Advanced EDID management
HDCP compliancy	1.4
Audio capability*	8 channel PCM or HBR compressed
Weight	95 g
Power consumption	0.38W (typ), 2.88 W (max)
Connectors	HDMI
ESD protection	IEC61000-4-2 Level 4

* The transmitted audio depends on the Media connector. For final audio transmission capabilities please see the audio specification of the chosen Media connector.

9.3.4. MODEX-AV-DP-IM

Part number	9161 0419
Max. resolution	2560x1600 @ 60Hz
.....	4096x2160 @ 24Hz
Max DP cable length (24 AWG)	15 m
Color depth	24 / 30 / 36 bit deep color
Color space	RGB/YUV (4:4:4) – 10 bit-color
.....	YUV (4:2:2/4:2:0) – 12 bit-color
.....	RGB (4:4:4) to YUV (4:4:4)
Frame delay	no delay
Data rate	Total max. 10.8 Gpbs (1.62/2.7 Gpbs/lane)
Supported video standards	DP 1.1a compliant
3D support	Yes
Embedded audio	Yes
EDID emulation	Yes, Advanced EDID management
HDCP compliancy	1.3
Audio capability*	8 channel PCM or HBR compressed
Weight	95 g
Power consumption	0.8W (typ), 2.5W (max)
Connectors	Standard DisplayPort gold plated connector
ESD protection	IEC61000-4-2 Level 4

* The transmitted audio depends on the Media connector. For final audio transmission capabilities please see the audio specification of the chosen Media connector.

9.3.5. MODEX-AV-DP-OM

Part number	9161 0422
Max. resolution	2560x1600 @ 60Hz
.....	4096x2160 @ 24Hz
Color depth	24 / 30 / 36 bit deep color
Color space	RGB/YUV (4:4:4) – 10 bit-color
.....	YUV (4:2:2/4:2:0) – 12 bit-color
.....	RGB (4:4:4) to YUV (4:4:4)

Frame delay	no delay
Data rate	Total max. 10.8 Gbps (1.62/2.7 Gbps/lane)
Supported video standards	DP 1.1a compliant
3D support	Yes
Embedded audio	Yes
EDID emulation	Yes, Advanced EDID management
HDCP compliancy	1.3
Audio capability*	8 channel PCM or HBR compressed
Weight	95 g
Power consumption	0.8W (typ), 2.5W (max)
Connectors	Standard DisplayPort gold plated connector
ESD protection	IEC61000-4-2 Level 4

* The transmitted audio depends on the Media connector. For final audio transmission capabilities please see the audio specification of the chosen Media connector.

9.3.6. MODEX-AV-3GSDI-IM

Part number	9161 0426
Max resolution	1920x1080p@60Hz
.....	3G-SDI Level A: 1920x1080p YCbCr 4:2:2
.....	3G-SDI Level B: 1920x1080p YCbCr 4:2:2
Max input cable length	130 m @ 3G-SDI
Color depth	20 bit
Color space	10 bit / Y, 10 bit / CbCr, 12 bit RGB
Frame delay	No delay
Data rate	Total max 2.97 Gbps
Supported video formats	SD-SDI, HD-SDI, 3G-SDI
3D support	No
Embedded audio	Yes
EDID emulation	No
Audio capability*	8 channel PCM
Weight	120 g
Power consumption	0.7W (typ), 1.1W (max)
Connectors	3xBNC (1x in, 2x loop out)
ESD protection	IEC61000-4-2 Level 4

* The transmitted audio depends on the Media connector. For final audio transmission capabilities please see the audio specification of the chosen Media connector.

9.3.7. MODEX-AV-DVI-OM

Part number	9161 0430
Max resolution	1920x1200@ 36 bit
.....	1600x1200@ 24 bit
Color depth	24, 30, 36 bit deep color

Color space	RGB, YCbCr 4:4:4/4:2:2
Frame delay	No delay
Data rate	Total max 6.75 Gbps
Max pixel clock.....	225 MHz
Supported video formats.....	DVI 1.0, HDMI 1.3a
3D support	No
Embedded audio / Return audio	Yes / No
EDID emulation.....	Yes, Advanced EDID management
HDCP compliancy.....	1.3
Audio capability*	8 channel PCM or HBR compressed
Weight.....	95 g
Power consumption	0.4W (typ), 0.7W (max)
Connectors.....	DVI-D
ESD protection.....	IEC61000-4-2 Level 4

* The transmitted audio depends on the Media connector. For final audio transmission capabilities please see the audio specification of the chosen Media connector.

9.3.8. MODEX-AV-DVI-IM

Part number	9161 0433
Max resolution.....	1920x1200@ 36 bit
.....	1600x1200@ 24 bit
max cable length (22 AWG).....	30 m
Color depth	24, 30, 36 bit deep color
Color space	RGB, YCbCr 4:4:4/4:2:2
Frame delay	No delay
Data rate	Total max 6.75 Gbps
Max pixel clock.....	225 MHz
Supported video formats.....	DVI 1.0, HDMI 1.3a
3D support	No
Embedded audio / Return audio	Yes / No
EDID emulation.....	Yes, Advanced EDID management
HDCP compliancy.....	1.3
Audio capability*	8 channel PCM or HBR compressed
Weight.....	105 g
Power consumption	1.3W (typ), 2.2W (max)
Connectors.....	DVI-D
ESD protection.....	IEC61000-4-2 Level 4

* The transmitted audio depends on the Media connector. For final audio transmission capabilities please see the audio specification of the chosen Media connector.

9.3.9. MODEX-AV-DVI-4K-OM

Part number	9161 0436
Max resolution.....	1600x1200@60Hz, 36 bit
.....	3840x2160@30Hz, 24 bit
.....	1920x1080@120Hz, 24 bit
Color depth	24, 30, 36 bit deep color
Color space.....	RGB, YCbCr 4:4:4/4:2:2
Frame delay	No delay
Data rate	9 Gbps
Max pixel clock.....	300 MHz
Supported video formats.....	DVI 1.0, HDMI 1.4
3D support	Yes
Embedded audio / Return audio	Yes / No
EDID emulation.....	Yes, Advanced EDID management
HDCP compliancy.....	1.4
Audio capability*	8 channel PCM or HBR compressed
Weight.....	100 g
Power consumption	0.38 W (typ), 2.88 (max)
Connectors.....	DVI-D
ESD protection.....	IEC61000-4-2 Level 4

* The transmitted audio depends on the Media connector. For final audio transmission capabilities please see the audio specification of the chosen Media connector.

9.3.10. MODEX-AV-HDMI-DVI-4K-OM

Part number	9161 0439
Max resolution.....	1600x1200@60Hz, 36 bit
.....	3840x2160@30Hz, 24 bit
.....	1920x1080p@120Hz, 24 bit
Color depth	24, 30, 36 bit deep color
Color space.....	RGB, YCbCr 4:4:4/4:2:2
Frame delay	No delay
Data rate	9 Gbps
Max pixel clock.....	300 MHz
Supported video formats.....	DVI 1.0, HDMI 1.4
3D support	Yes
Embedded audio / Return audio	Yes / Yes (on HDMI connector)
EDID emulation.....	Yes, Advanced EDID management
HDCP compliancy.....	1.4
Audio capability*	8 channel PCM or HBR compressed
Weight.....	110 g
Power consumption	0.38 W (typ), 2.88 W (max)

Connectors..... DVI-D, HDMI
ESD protection..... IEC61000-4-2 Level 4

* The transmitted audio depends on the Media connector. For final audio transmission capabilities please see the audio specification of the chosen Media connector.

9.4. Interface modules

9.4.1. MODEX-IF-RS232

Part number 9161 0712
Supported baud ratefrom 2400 to 256000 (configurable)
Signal type RX/TX bidirectional
Weight..... 60 g
Power consumption0.1 W (typ) 0,2 W (max)
Connector9-pole D-sub
ESD protection..... IEC61000-4-2 Level 4

9.4.2. MODEX-IF-2xRS232

Part number 9161 0713
Supported baud ratefrom 2400 to 256000 (configurable)
Signal type RX/TX bidirectional
Weight..... 70 g
Power consumption0.1 W (typ) 0,2 W (max)
Connector2 x 9-pole D-sub
ESD protection..... IEC61000-4-2 Level 4

9.4.3. MODEX-IF-RS232-RS422

Part number 9161 0714
Weight..... 70 g
Power consumption0.1 W (typ) 0,2 W (max)
Connector2 x 9-pole D-sub
ESD protection..... IEC61000-4-2 Level 4

RS-232

Supported baud ratefrom 2400 to 256000 (configurable)
Signal type RX/TX bidirectional

RS-422

Pin assignment 1: RX-, 2: RX+, 3: TX+, 4: TX-, 5: GND
Signal levels..... ± 5 V

9.4.4. MODEX-IF-RS232-IR

Part number 9161 0715
 Weight..... 65 g
 Power consumption0.1 W (typ) 0.2 W (max)
 IR connector..... 2x3.5 mm TRS connector (1/8" mini-jack), 9-pole D-sub
 ESD protection.....No

RS-232

Supported baud ratefrom 2400 to 256000 (configurable)
 Signal type RX/TX bidirectional

IR (valid for the supplied IR receiver and IR emitter)

Supported frequencies (input carrier frequency) 38 kHz
 Supported frequencies (output carrier frequency) 38 kHz (configurable)

9.4.5. MODEX-IF-ETH

Part number 9161 0718
 Ethernet data rate 10/100Base-T, full duplex with autodetect
 Ethernet protocol..... ARP, ICMP (ping), IP, TCP, DHCP, HTTP, SMTP, Telnet
 Power over Ethernet Not supported
 Auto-MDIX Yes
 Weight..... 70 g
 Power consumption0.05 W (typ) 0,066 W (max)
 Connector 1 x female RJ45
 ESD protection..... IEC61000-4-2 Level 4

9.4.6. MODEX-IF-AUDIN

Part number 9161 0719
 Weight..... 80 g
 Power consumption0.2 W (typ) 0.33 W (max)
 Connectors..... 1xRCA, 1x5 pole PHOENIX
 ESD protection..... IEC61000-4-2 Level 4

S/PDIF digital audio

Audio format.....S/PDIF
 Supported sample rates..... 16 to 48 kHz
 AES/EBU compatibility.....No
 Bit depths Up to 24 bits

Analog audio

Sample frequency 48 kHz
 Maximum level Input: 4.4 Vp-p
 Frequency response 20 Hz to 20 kHz: ±1 dB
 Gain..... -5dB to 19dB
 Input impedance28 kΩ

9.4.7. MODEX-IF-AUDOUT

Part number	9161 0720
Weight.....	80 g
Power consumption	0.2 W (typ) 0.33 W (max)
Connectors.....	1xRCA, 1x5 pole PHOENIX
ESD protection.....	IEC61000-4-2 Level 4

S/PDIF digital audio

Audio format.....	S/PDIF
Supported sample rates.....	16 to 48 kHz
AES/EBU compatibility.....	No
Bit depths	Up to 24 bits

Analog audio

Sample frequency	16 to 96 kHz
Maximum level	4.4 Vp-p (6 dBu)
Frequency response	20 Hz to 20 kHz: ± 1 dB
Volume.....	+5dB to -73dB (and $-\infty$ dB)
Output impedance.....	1.2 k Ω

9.4.8. MODEX-IF-AUD

Part number	9161 0721
Weight.....	90 g
Power consumption	0.2 W (typ) 0.33 W (max)
Connectors.....	2xRCA, 2x5 pole PHOENIX
ESD protection.....	IEC61000-4-2 Level 4

S/PDIF digital audio

Audio format.....	S/PDIF
Supported sample rates.....	16 to 48 kHz (input), 16 to 48 kHz (output)
AES/EBU compatibility.....	No
Bit depths	Up to 24 bits

Analog audio

Sample frequency	48 kHz
Maximum level	Input: 4.4 Vp-p; output: 4.4 Vp-p (6 dBu)
Frequency response	20 Hz to 20 kHz: ± 1 dB
Volume.....	Input: -5dB to 19dB
	Output: +5dB to -73dB (and $-\infty$ dB)
Input/output impedance	Input: 28 k Ω ; output: 1.2 k Ω

9.4.9. MODEX-IF-4ETH

Part number	9161 0726
Ethernet data rate	10/100Base-T, full duplex with autodetect
Ethernet protocol.....	ARP, ICMP (ping), IP, TCP, DHCP, HTTP, SMTP, Telnet
Power over Ethernet	Not supported

Auto-MDIX Yes
Weight..... 75 g
Power consumption 1.5 W (typ) 2.3 W (max)
Connectors..... 4 x female RJ45
ESD protection..... IEC61000-4-2 Level 4

9.4.10. MODEX-IF-ETH-ECN

Part number 9161 0727
Ethernet data rate 10/100Base-T, full duplex with autodetect
Ethernet protocol..... ARP, ICMP (ping), IP, TCP, DHCP, HTTP, SMTP, Telnet
Power over Ethernet Not supported
Auto-MDIX Yes
Weight..... 75 g
Power consumption 0.1 W (typ) 0.2 W (max)
Connector Neutrik Ethercon RJ-45 receptacle with latch lock (NE8FBH-S)
ESD protection..... IEC61000-4-2 Level 4

10. Troubleshooting

Usually, if the system seems not to transport the signal as expected, the best strategy for troubleshooting is to check signal integrity through the whole signal chain starting from source side and moving forward to receiver end.

At first check front panel LEDs and take the necessary steps according to their states. For more information about status LEDs refer to section [2.2.1](#) on page [13](#) and section [2.2.2](#) on page [14](#).

Symptom	Root cause	Action	Refer to
Video & Audio module			
No picture on the video output port	Device(s) not powered properly	Check the extenders and the other devices if they are properly powered; try to unplug and reconnect them.	
	Cable connection problem	Cables must fit very well, check all the connectors.	
	Not the proper video port is the active one	Check the properties of the Video & Audio module.	Section 6.4.2
	Not the proper interface is the active one	If the source/display has more connectors, check if the proper interface is selected.	
	The output is muted	Check the mute state of output port of TX and RX.	Section 6.5
	Display is not able to receive the video format	Check the emulated EDID and select another (e.g. emulate the display's EDID on the input port).	Section 6.6.4
	Data rate is too high for the video cable	Select a lower resolution; if the source is a computer try to modify the refresh rate (only for expert users).	
	HDCP is disabled	Enable HDCP on input port.	Section 6.5.3
Audio interface module			
No audio is present on output	Other audio port is switched to the output	Check the crosspoint settings of audio layer.	Section 6.3
	Audio application mode set to another layout	Check the Audio application mode of the Audio module.	Section 5.4.4 or section 6.4.3
	Output port is muted	Check the Audio port properties.	Section 6.5
	Analog audio input: volume is set very low	Check the Analog audio input port settings (Volume).	Section 5.4.4 or section 6.5.1
	Analog audio output: volume is set very low	Check the Analog audio output port settings (Volume).	Section 5.4.4 or 6.5.2
HDMI output signal contains no audio	HDMI mode was set to DVI	Check the properties of the output port on RX and set to HDMI or Auto.	Section 5.4.2 or section 6.5.3

Symptom	Root cause	Action	Refer to
HDMI output signal contains no audio	DVI EDID is emulated	Check the EDID and select an HDMI EDID to emulate.	Section 5.7 or section 6.6
Serial and Infra modules			
Connected serial device cannot be controlled	Cable connection problem	Check the connectors to fit well; check the wiring of the plugs.	Section 2.7.10
	Serial settings are different	Check the serial port settings in the MODEX to meet with the requirements of the serial device.	Section 6.5.7
	Serial port is muted	Check the mute state of serial port(s).	Section 6.5
	Serial crosspoint is not set properly	Check the crosspoint state of Serial layer.	Section 0
Connected IR device cannot be controlled	IR Emitter and/or detector connection problem	Check if the IR emitter is plugged in the IR output, and the IR detector in the IR input connector.	Section 4.1
	IR carrier frequency setting is different	Check the IR settings in the MODEX to meet with the requirements of the IR device.	Section 6.5.4
	IR port is muted	Check the mute state of IR port(s).	Section 6.5
	Infra crosspoint is not set properly	Check the crosspoint state of Infra layer.	Section 6.3.3
Front panel menu			
Navigation buttons are out of operation	LCD home screen is locked	Connect to the MODEX via the built-in web and unlock LCD.	Section 6.9.6
Settings cannot be changed on front panel	Setup is disabled on front panel	Connect to the MODEX via the built-in web and unlock front panel setup.	Section 6.9.6
LAN (Ethernet)			
No LAN connection can be established	Incorrect IP address is set (direct connect)	Disable DHCP server and set the IP addresses to be in the same subnet.	
	IP address conflict	Change the IP address to a not reserved one or enable DHCP if DHCP server exists in the network.	
USB			
USB device does not operate	Cables are not connected on both sides	Check the USB cable between TX and the computer.	Section 4.1 , Step 8
	Not supported USB device is connected	Keyboard, mouse (USB HID devices) are supported mostly, check your device type.	Section 6.7.2

Symptom	Root cause	Action	Refer to
Optical module			
Extenders are not linked or remote device cannot be reached	Fiber cable is connected to the not used channel	Check the connectors: from TX (Channel A) to RX (Channel B).	Section 4.1
	Optical cable became contaminated	Use special fiber optical cable cleaning equipment or a soft cloth to carefully clean it.	
	Different firmware is installed	Check the firmware in TX and RX; the versions have to match. If necessary do firmware upgrade.	Section 6.9.3 and Chapter 8
Miscellaneous			
Crosspoint setting cannot be changed	Core module is locked	Unlock the core module via the built-in website.	Section 6.9.6
Module property cannot be changed	The module is locked	Unlock the module via the built-in website.	Section 6.9.6

11. Appendix

11.1. Mechanical drawings

Front view (MODEX-OPTM-TX)

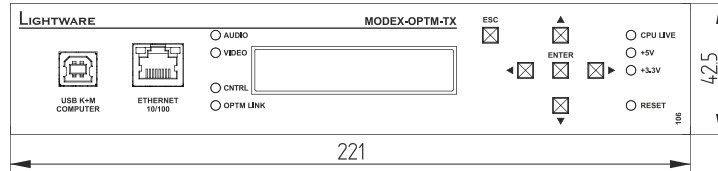

Bottom view

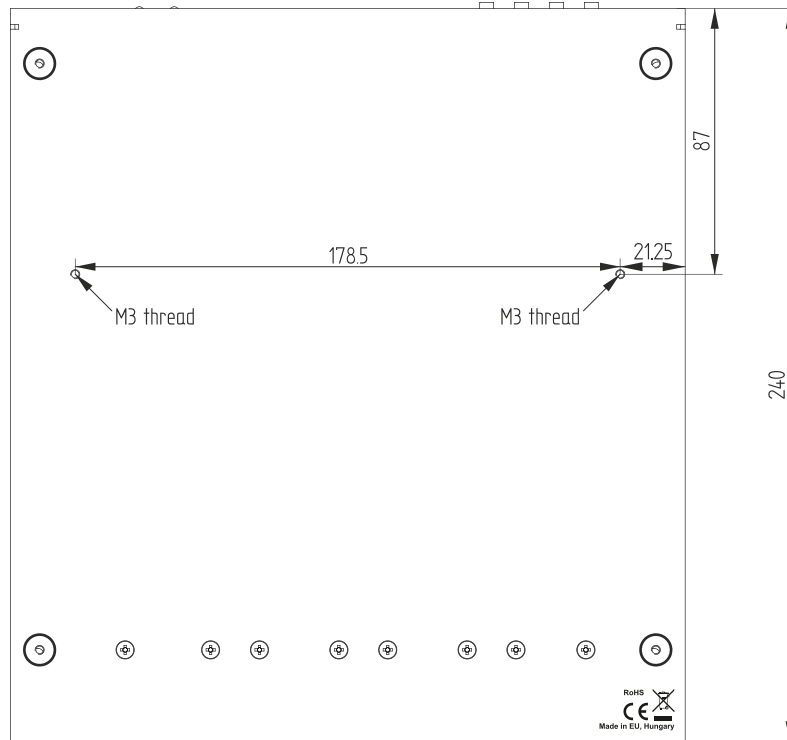

Side view

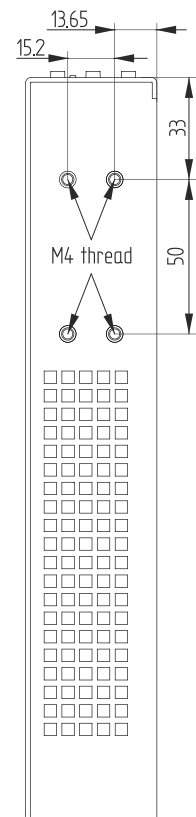

11.2. Factory default settings

Parameter	Setting/Value
Network settings	
IP address (transmitter)	192.168.0.101
IP address (receiver)	192.168.0.102
Subnet mask	255.255.255.0
Static gateway	192.168.0.1
Port number	6107
DHCP	disabled
HTTP port	80
WEB socket	81
HDMI input port	
Input port	HDMI
HDMI output port	
HDMI mode	Auto
Color space	Auto
HDCP mode	Auto
Color range	Auto
Serial port (RS-232)	
RS-232 Baud rate [baud]	9600
RS-232 data bits	8
Stop bits	1
Parity	None
Infrared port	
IR input carrier frequency [Hz]	38000
IR output carrier frequency [Hz]	38000
Analog audio ports	
Application mode	(0) Analog ↔ Emb. & Ret. Aux
Analog in Gain [dB] (only on input)	0
Analog out Volume [dB]	0
Analog out Balance	50% (centered)
Invert phase	disabled
DC filter	disabled
EDID settings	
DVI port	F49
HDMI port	F49

11.3. Factory EDID list

Mem.	Resolution	Type	Mem.	Resolution	Type
F01	640 x 480 @ 59.95 Hz	D	F61	1280 x 768 @ 59.92 Hz	A
F02	848 x 480 @ 60.0 Hz	D	F62	1280 x 768 @ 75.0 Hz	A
F03	800 x 600 @ 60.30 Hz	D	F63	1360 x 768 @ 60.1 Hz	A
F04	1024 x 768 @ 60.0 Hz	D	F64	1364 x 768 @ 50.0 Hz	A
F05	1280 x 768 @ 50.0 Hz	D	F65	1364 x 768 @ 59.93 Hz	A
F06	1280 x 768 @ 59.92 Hz	D	F66	1364 x 768 @ 74.98 Hz	A
F07	1280 x 768 @ 75.0 Hz	D	F67	1280 x 1024 @ 50.0 Hz	A
F08	1360 x 768 @ 60.1 Hz	D	F68	1280 x 1024 @ 60.1 Hz	A
F09	1280 x 1024 @ 50.0 Hz	D	F69	1366 x 1024 @ 59.99 Hz	A
F10	1280 x 1024 @ 60.1 Hz	D	F70	1400 x 1050 @ 49.99 Hz	A
F11	1280 x 1024 @ 75.1 Hz	D	F71	1400 x 1050 @ 59.99 Hz	A
F12	1400 x 1050 @ 49.99 Hz	D	F72	1400 x 1050 @ 75.0 Hz	A
F13	1400 x 1050 @ 59.99 Hz	D	F73	1920 x 540 @ 50.0 Hz	A
F14	1400 x 1050 @ 75.0 Hz	D	F74	1920 x 540 @ 59.98 Hz	A
F15	1680 x 1050 @ 59.99 Hz	D	F75	1920 x 1080 @ 50.0 Hz	A
F16	1920 x 1080 @ 50.0 Hz	D	F76	1920 x 1080 @ 60.0 Hz	A
F17	1920 x 1080 @ 60.0 Hz	D	F77	1600 x 1200 @ 50.0 Hz	A
F18	2048 x 1080 @ 50.0 Hz	D	F78	1600 x 1200 @ 60.0 Hz	A
F19	2048 x 1080 @ 59.99 Hz	D	F79	1920 x 1200 @ 59.55 Hz	A
F20	1600 x 1200 @ 50.0 Hz	D	F80	1920 x 1200 @ 50.0 Hz	A
F21	1600 x 1200 @ 60.0 Hz	D	F81	Reserved	
F22	1920 x 1200 @ 50.0 Hz	D	F82	Reserved	
F23	1920 x 1200 @ 59.55 Hz	D	F83	Reserved	
F24	2048 x 1200 @ 59.95 Hz	D	F84	Reserved	
F25	Reserved		F85	Reserved	
F26	Reserved		F86	Reserved	
F27	Reserved		F87	Reserved	
F28	Reserved		F88	Reserved	
F29	Universal_DVI	D	F89	Univ_Analog	A
F30	1440 x 240i @ 60.3 Hz	H	F90	1920 x 2160 @ 59.98 Hz	DL
F31	1440 x 288i @ 50.6 Hz	H	F91	1024 x 2400 @ 60.1 Hz	DL
F32	640 x 480 @ 59.94 Hz	H	F92	1920 x 2400 @ 59.97 Hz	DL
F33	720 x 480 @ 59.92 Hz	H	F93	2048 x 2400 @ 59.97 Hz	DL
F34	720 x 576 @ 50.0 Hz	H	F94	2048 x 1536 @ 59.99 Hz	DL
F35	1280 x 720 @ 50.0 Hz	H	F95	2048 x 1536 @ 74.99 Hz	DL
F36	1280 x 720 @ 60.0 Hz	H	F96	2560 x 1600 @ 59.85 Hz	DL
F37	1920 x 540i @ 50.3 Hz	H	F97	3840 x 2400 @ 23.99 Hz	DL
F38	1920 x 540i @ 50.0 Hz	H	F98	1280 x 720 @ 60.0 Hz	H3D
F39	1920 x 540i @ 59.98 Hz	H	F99	1920 x 1080 @ 60.0 Hz	H3D
F40	1920 x 540i @ 60.5 Hz	H	F100	1024 x 768 @ 60.0 Hz	H
F41	1920 x 1080 @ 24.0 Hz	H	F101	1280 x 1024 @ 50.0 Hz	H
F42	1920 x 1080 @ 24.99 Hz	H	F102	1280 x 1024 @ 60.1 Hz	H
F43	1920 x 1080 @ 30.0 Hz	H	F103	1280 x 1024 @ 75.1 Hz	H
F44	1920 x 1080 @ 50.0 Hz	H	F104	1600 x 1200 @ 50.0 Hz	H
F45	1920 x 1080 @ 59.93 Hz	H	F105	1600 x 1200 @ 60.0 Hz	H
F46	1920 x 1080 @ 60.0 Hz	H	F106	1920 x 1200 @ 59.55 Hz	H
F47	Universal_HDMI_PCM	H	F107	2560 x 1440 @ 59.94 Hz	H
F48	Universal_HDMI_ALL	H	F108	2560 x 1600 @ 59.85 Hz	H
F49	Universal_HDMI_DC	H	F109	3840 x 2400 @ 23.99 Hz	H
F50	720 x 480 @ 30.1 Hz	A	F110	3840 x 2160 @ 24.0 Hz	H
F51	720 x 576 @ 25.3 Hz	A	F111	3840 x 2160 @ 25.0 Hz	H
F52	640 x 480 @ 60.0 Hz	A	F112	3840 x 2160 @ 30.0 Hz	H
F53	640 x 480 @ 75.0 Hz	A	F113	Reserved	
F54	800 x 600 @ 50.0 Hz	A	F114	Reserved	
F55	800 x 600 @ 60.3 Hz	A	F115	Reserved	
F56	800 x 600 @ 74.99 Hz	A	F116	Reserved	
F57	1024 x 768 @ 49.98 Hz	A	F117	Reserved	
F58	1024 x 768 @ 60.0 Hz	A	F118	Universal_4K_PCM	H4K
F59	1024 x 768 @ 75.2 Hz	A	F119	Universal_4K_ALL	H4K
F60	1280 x 768 @ 50.0 Hz	A			

EDID types: **D**=DVI EDID; **H**=HDMI EDID; **A**=Analog EDID; **DL**=Dual-Link DVI EDID;
H3D=HDMI EDID with 3D support; **H4K**: HDMI EDID with 4K resolution support

12. Version applicability

This User's Manual applies to the following version of the mentioned firmware:

Firmware	Version
MCU Firmware	1.2.0b5
FPGA Firmware	1.1.0b3
Web Content	1.2.0b2
Lightware Device Updater	1.0.8 b0

13. Warranty

Lightware Visual Engineering warrants this product against defects in materials and workmanship for a period of three years from the date of purchase.

Customer shall pay shipping charges when unit is returned for repair. Lightware will cover shipping charges for return shipments to customers.

In case of defect please call your local representative, or contact Lightware at

Lightware Visual Engineering

H-1071 Budapest, Peterdy Street 15, HUNGARY

E-mail: support@lightware.eu

14. Document revision history

Document	Release Date	Changes	Editor
Rev. 1.4	08-04-2015	New modules added, serial and IR crosspoint sections changed.	Laszlo Zsedenyi
Rev. 1.3	16-01-2015	Minor changes in Technologies section (HDCP)	Laszlo Zsedenyi
Rev. 1.2	19-12-2014	New modules added, Lightware Device Updater added and Firmware upgrade process changed, Web control section updated.	Laszlo Zsedenyi
Rev. 1.1	06-10-2014	New modules added	Laszlo Zsedenyi
Rev. 1.0	20-03-2014	Initial version	Laszlo Zsedenyi