

# Roland

MULTI-FORMAT VIDEO SWITCHER **V-800HD**

## Owner's Manual

Before using this unit, carefully read the sections entitled: "IMPORTANT SAFETY INSTRUCTIONS" (p.2), "USING THE UNIT SAFELY" (p. 3), and "IMPORTANT NOTES" (p. 5). These sections provide important information concerning the proper operation of the unit. Additionally, in order to feel assured that you have gained a good grasp of every feature provided by your new unit, owner's manual should be read in its entirety. The manual should be saved and kept on hand as a convenient reference.





Copyright © 2012 ROLAND CORPORATION

All rights reserved. No part of this publication may be reproduced in any form without the written permission of ROLAND CORPORATION.

\* Roland is either registered trademark or trademark of Roland Corporation in the United States and/or other countries.

\* All product names mentioned in this document are trademarks or registered trademarks of their respective owners.

**WARNING:** To reduce the risk of fire or electric shock, do not expose this apparatus to rain or moisture.

 <b>CAUTION</b> RISK OF ELECTRIC SHOCK DO NOT OPEN	
<b>ATTENTION:</b> RISQUE DE CHOC ELECTRIQUE NE PAS OUVRIR	
<b>CAUTION:</b> TO REDUCE THE RISK OF ELECTRIC SHOCK, DO NOT REMOVE COVER (OR BACK). NO USER-SERVICEABLE PARTS INSIDE. REFER SERVICING TO QUALIFIED SERVICE PERSONNEL.	



The lightning flash with arrowhead symbol, within an equilateral triangle, is intended to alert the user to the presence of uninsulated dangerous voltage within the product's enclosure that may be of sufficient magnitude to constitute a risk of electric shock to persons.



The exclamation point within an equilateral triangle is intended to alert the user to the presence of important operating and maintenance (servicing) instructions in the literature accompanying the product.

INSTRUCTIONS PERTAINING TO A RISK OF FIRE, ELECTRIC SHOCK, OR INJURY TO PERSONS.

## IMPORTANT SAFETY INSTRUCTIONS SAVE THESE INSTRUCTIONS

**WARNING** - When using electric products, basic precautions should always be followed, including the following:

1. Read these instructions.
2. Keep these instructions.
3. Heed all warnings.
4. Follow all instructions.
5. Do not use this apparatus near water.
6. Clean only with a dry cloth.
7. Do not block any of the ventilation openings. Install in accordance with the manufacturer's instructions.
8. Do not install near any heat sources such as radiators, heat registers, stoves, or other apparatus (including amplifiers) that produce heat.
9. Do not defeat the safety purpose of the polarized or grounding-type plug. A polarized plug has two blades with one wider than the other. A grounding type plug has two blades and a third grounding prong. The wide blade or the third prong are provided for your safety. If the provided plug does not fit into your outlet, consult an electrician for replacement of the obsolete outlet.
10. Protect the power cord from being walked on or pinched particularly at plugs, convenience receptacles, and the point where they exit from the apparatus.
11. Only use attachments/accessories specified by the manufacturer.
12. Use only with the cart, stand, tripod, bracket, or table specified by the manufacturer, or sold with the apparatus. When a cart is used, use caution when moving the cart/apparatus combination to avoid injury from tip-over.
13. Unplug this apparatus during lightning storms or when unused for long periods of time.
14. Refer all servicing to qualified service personnel. Servicing is required when the apparatus has been damaged in any way, such as power-supply cord or plug is damaged, liquid has been spilled or objects have fallen into the apparatus, the apparatus has been exposed to rain or moisture, does not operate normally, or has been dropped.



For the U.K.

**WARNING:** THIS APPARATUS MUST BE EARTHED

**IMPORTANT:** THE WIRES IN THIS MAINS LEAD ARE COLOURED IN ACCORDANCE WITH THE FOLLOWING CODE.  
GREEN-AND-YELLOW: EARTH, BLUE: NEUTRAL, BROWN: LIVE

As the colours of the wires in the mains lead of this apparatus may not correspond with the coloured markings identifying the terminals in your plug, proceed as follows:

The wire which is coloured GREEN-AND-YELLOW must be connected to the terminal in the plug which is marked by the letter E or by the safety earth symbol  $\oplus$  or coloured GREEN or GREEN-AND-YELLOW.



The wire which is coloured BLUE must be connected to the terminal which is marked with the letter N or coloured BLACK.

The wire which is coloured BROWN must be connected to the terminal which is marked with the letter L or coloured RED.



# USING THE UNIT SAFELY

## INSTRUCTIONS FOR THE PREVENTION OF FIRE, ELECTRIC SHOCK, OR INJURY TO PERSONS

### About ⚠ WARNING and ⚠ CAUTION Notices

 <b>WARNING</b>	Used for instructions intended to alert the user to the risk of death or severe injury should the unit be used improperly.
 <b>CAUTION</b>	Used for instructions intended to alert the user to the risk of injury or material damage should the unit be used improperly. * Material damage refers to damage or other adverse effects caused with respect to the home and all its furnishings, as well to domestic animals or pets.

### About the Symbols

	The ⚠ symbol alerts the user to important instructions or warnings. The specific meaning of the symbol is determined by the design contained within the triangle. In the case of the symbol at left, it is used for
	The ⊘ symbol alerts the user to items that must never be carried out (are forbidden). The specific thing that must not be done is indicated by the design contained within the circle. In the case of the symbol at left, it means that the unit must never be disassembled.
	The ● symbol alerts the user to things that must be carried out. The specific thing that must be done is indicated by the design contained within the circle. In the case of the symbol at left, it means that the power-cord plug must be unplugged from the outlet.

### ALWAYS OBSERVE THE FOLLOWING

#### **WARNING**

Make sure that the power cord is grounded.

- Connect mains plug of this model to a mains socket outlet with a protective earthing connection.



Do not disassemble or modify by yourself.

- Do not open or perform any internal modifications on the unit.



Do not repair or replace parts by yourself.

- Do not attempt to repair the unit, or replace parts within it (except when this manual provides specific instructions directing you to do so). Refer all servicing to your retailer, the nearest Roland Service Center, or an authorized Roland distributor, as listed on the "Information" sheet.



Do not use or store in the following types of locations.

- Subject to temperature extremes (e.g., direct sunlight in an enclosed vehicle, near a heating duct, on top of heat-generating equipment); or are
- Damp (e.g., baths, washrooms, on wet floors); or are
- Exposed to steam or smoke; or are
- Subject to salt exposure; or are
- Humid; or are
- Exposed to rain; or are
- Dusty or sandy; or are
- Subject to high levels of vibration and shakiness.



Do not place in an unsuitable location.

- When using the unit with a rack or stand recommended by Roland, the rack or stand must be carefully placed so it is level and sure to remain stable. If not using a rack or stand, you still need to make sure that any location you choose for placing the unit provides a level surface that will properly support the unit, and keep it from wobbling.



#### **WARNING**

Use only the included power cord.

- Use only the attached power-supply cord. Also, the supplied power cord must not be used with any other device.



Connect the power cord to an outlet of the correct voltage.

- The unit should be connected to a power supply only of the type described in the operating instructions, or as marked on the side panel of unit.



Do not bend the power cord or place heavy objects on it.

- Do not excessively twist or bend the power cord, nor place heavy objects on it. Doing so can damage the cord, producing severed elements and short circuits. Damaged cords are fire and shock hazards!



Don't allow foreign objects or liquid to enter unit; never place containers with liquid on unit.

- Do not place containers containing liquid on this product. Never allow foreign objects (e.g., flammable objects, coins, wires) or liquids (e.g., water or juice) to enter this product. Doing so may cause short circuits, faulty operation, or other malfunctions.



Turn off the unit if an abnormality or malfunction occurs.

- Immediately turn the unit off, remove the power cord from the outlet, and request servicing by your retailer, the nearest Roland Service Center, or an authorized Roland distributor, as listed on the "Information" sheet when:
  - The power-supply cord or the plug has been damaged; or
  - If smoke or unusual odor occurs
  - Objects have fallen into, or liquid has been spilled onto the unit; or
  - The unit has been exposed to rain (or otherwise has become wet); or
  - The unit does not appear to operate normally or exhibits a marked change in performance.



**⚠ WARNING**

Adults must provide supervision in places where children are present.

- When using the unit in locations where children are present, be careful so no mishandling of the unit can take place. An adult should always be on hand to provide supervision and guidance.



Do not drop or subject to strong impact

- Protect the unit from strong impact. (Do not drop it!)



Do not share an outlet with an unreasonable number of devices.

- Do not force the unit's power-supply cord to share an outlet with an unreasonable number of other devices. Be especially careful when using extension cords - the total power used by all devices you have connected to the extension cord's outlet must never exceed the power rating (watts/amperes) for the extension cord. Excessive loads can cause the insulation on the cord to heat up and eventually melt through.



Do not use overseas.

- Before using the unit in a foreign country, consult with your retailer, the nearest Roland Service Center, or an authorized Roland distributor, as listed on the "Information" sheet.



**⚠ CAUTION**

Place in a well ventilated location.

- The unit should be located so that its location or position does not interfere with its proper ventilation.



Grasp the plug when connecting or disconnecting the power cord.

- Always grasp only the plug on the power-supply cord when plugging into, or unplugging from, an outlet or this unit.



Periodically clean the power cord's plug.

- At regular intervals, you should unplug the power plug and clean it by using a dry cloth to wipe all dust and other accumulations away from its prongs. Also, disconnect the power plug from the power outlet whenever the unit is to remain unused for an extended period of time. Any accumulation of dust between the power plug and the power outlet can result in poor insulation and lead to fire.



Manage cables for safety.

- Try to prevent cords and cables from becoming entangled. Also, all cords and cables should be placed so they are out of the reach of children.



Avoid climbing on top of the unit, or placing heavy objects on it.

- Never climb on top of, nor place heavy objects on the unit.



Do not connect or disconnect the power cord with wet hands.

- Never handle the power cord or its plugs with wet hands when plugging into, or unplugging from, an outlet or this unit.



Disconnect everything before moving the unit.

- Before moving the unit, disconnect the power plug from the outlet, and pull out all cords from external devices.



Unplug the power cord from the outlet before cleaning.

- Before cleaning the unit, turn it off (p. 13) and unplug the power cord from the outlet.



If there is a possibility of lightning strike, disconnect the power cord from the outlet.

- Whenever you suspect the possibility of lightning in your area, pull the plug on the power cord out of the outlet.



Keep small items out of the reach of children

- To prevent accidental ingestion of the parts listed below, always keep them out of the reach of small children.
  - Removable Parts
  - Screws for rack mount angles (p. 53)



Handle the ground terminal carefully.

- If you remove the screw from the ground terminal, be sure to replace it; don't leave it lying around where it could accidentally be swallowed by small children. When refastening the screw, make that it is firmly fastened, so it won't come loose.



Take care not to be burned.

- The rear panel of this unit may become hot, so take care to avoid burns.



# IMPORTANT NOTES

## Power Supply

- Do not connect this unit to same electrical outlet that is being used by an electrical appliance that is controlled by an inverter or a motor (such as a refrigerator, washing machine, microwave oven, or air conditioner). Depending on the way in which the electrical appliance is used, power supply noise may cause this unit to malfunction or may produce audible noise. If it is not practical to use a separate electrical outlet, connect a power supply noise filter between this unit and the electrical outlet.
- To prevent malfunction and equipment failure, always make sure to turn off the power on all your equipment before you make any connections.
- Although the LCD and LEDs are switched off when the unit is turned off, this does not mean that the unit has been completely disconnected from the source of power. If you need to turn off the power completely, first turn off the unit's switch, then unplug the power cord from the power outlet. For this reason, the outlet into which you choose to connect the power cord's plug should be one that is within easy reach and readily accessible.

## Placement

- This device may interfere with radio and television reception. Do not use this device in the vicinity of such receivers.
- Noise may be produced if wireless communications devices, such as cell phones, are operated in the vicinity of this unit. Such noise could occur when receiving or initiating a call, or while conversing. Should you experience such problems, you should relocate such wireless devices so they are at a greater distance from this unit, or switch them off.
- Do not expose the unit to direct sunlight, place it near devices that radiate heat, leave it inside an enclosed vehicle, or otherwise subject it to temperature extremes. Excessive heat can deform or discolor the unit.
- When moved from one location to another where the temperature and/or humidity is very different, water droplets (condensation) may form inside the unit. Damage or malfunction may result if you attempt to use the unit in this condition. Therefore, before using the unit, you must allow it to stand for several hours, until the condensation has completely evaporated.
- Depending on the material and temperature of the surface on which you place the unit, its rubber feet may discolor or mar the surface. You can place a piece of felt or cloth under the rubber feet to prevent this from happening. If you do so, please make sure that the unit will not slip or move accidentally.
- Do not put anything that contains water on this unit. Also, avoid the use of insecticides, perfumes, alcohol, nail polish, spray cans, etc., near the unit. Swiftly wipe away any liquid that spills on the unit using a dry, soft cloth.

## Maintenance

- For everyday cleaning wipe the unit with a soft, dry cloth or one that has been slightly dampened with water. To remove stubborn dirt, use a cloth impregnated with a mild, non-abrasive detergent. Afterwards, be sure to wipe the unit thoroughly with a soft, dry cloth.
- Never use benzine, thinners, alcohol or solvents of any kind, to avoid the possibility of discoloration and/or deformation.

## Additional Precautions

- This unit allows you to switch images or turn video effects on/off at high speed. For some people, viewing such images can cause headache, nausea, or other discomfort. Do not use this unit to create video that might cause these types of health problems. Roland Corporation will accept no responsibility for any such health problems that may occur in yourself or in viewers.
- Unfortunately, it may be impossible to restore the contents of data that was stored in the unit's memory or USB memory once it has been lost. Roland Corporation assumes no liability concerning such loss of data.
- Use a reasonable amount of care when using the unit's buttons, sliders, or other controls; and when using its jacks and connectors. Rough handling can lead to malfunctions.
- When disconnecting all cables, grasp the connector itself - never pull on the cable. This way you will avoid causing shorts, or damage to the cable's internal elements.
- A small amount of heat will radiate from the unit during normal operation.
- When you need to transport the unit, package it in the box (including padding) that it came in, if possible. Otherwise, you will need to use equivalent packaging materials.

## Before Using USB Memories

- Carefully insert the USB memory all the way in--until it is firmly in place.
- Never touch the terminals of the USB memory. Also, avoid getting the terminals dirty.
- USB memories are constructed using precision components; handle the memories carefully, paying particular note to the following.
  - To prevent damage to the cards from static electricity, be sure to discharge any static electricity from your own body before handling the cards.
  - Do not touch or allow metal to come into contact with the contact portion of the cards.
  - Do not bend, drop, or subject cards to strong shock or vibration.
  - Do not keep cards in direct sunlight, in closed vehicles, or other such locations.
  - Do not allow cards to become wet.
  - Do not disassemble or modify the cards.

## Others

- Security Slot (  )  
<http://www.kensington.com/>

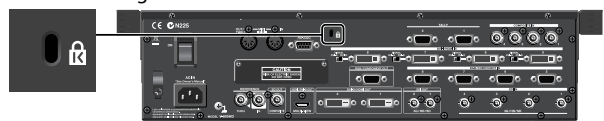

- This product is a Class A digital device under FCC part 15 for use in other than residential environment. Use of this equipment in a residential environment may cause radio interference requiring the user to take appropriate preventative measures. In such instances, take steps such as using cables with ferrite cores near their connectors. For information on specific preventive methods, contact your dealer, the nearest Roland Service Center, or an authorized Roland distributor, as listed on the "Information" sheet.
- When this device is connected to a video cameras or other such Class B equipment, the system as a whole is then classified as a Class A device.
- Recording, duplication, distribution, sale, lease, performance, or broadcast of copyrighted material (musical works, visual works, broadcasts, liver performances, etc.) belonging to a third party in part or in whole without the permissions of copyright owner is forbidden by law.
- Do not use this product for purposes that could infringe on a copyright held by a third party. We assume no responsibility whatsoever with regard to any infringements of third-party copyrights arising through your use of this product.

# Contents

<b>Check the Included Items .....</b>	<b>8</b>
<b>About the Multi-view Monitor .....</b>	<b>9</b>
Connecting the Monitor.....	9
Selecting an Output Format for the Multi-view Monitor .....	9
About the Menu Displays .....	9
About the Display on the Multi-view Monitor .....	10
<b>About Power Supply .....</b>	<b>11</b>
About the Ground Terminal.....	11
About the Cord Hook .....	12
Turning the Power On and Off.....	13
<b>Part Names and Functions .....</b>	<b>14</b>
Top Panel .....	14
Rear Panel .....	16
Signal Flow .....	18
<b>Connecting External Equipment .....</b>	<b>19</b>
Connecting Source Equipment .....	20
Connecting Video Sources .....	20
Connecting a Computer or HDMI Equipment.....	22
Connecting a Clock Source .....	24
Connecting Output Equipment.....	25
Connecting a Projector.....	25
Connecting Recording Equipment.....	25
Tally Output .....	25
<b>Selecting the Output Format .....</b>	<b>26</b>
<b>Inputting HDCP Signals.....</b>	<b>29</b>
<b>Basic Operations .....</b>	<b>31</b>
Using Buttons to Switch the Video.....	31
Using the Fader to Switch the Video .....	33
Applying Fade to Final Output .....	34
<b>Compositing the Video .....</b>	<b>35</b>
Compositing Using Picture-in-Picture .....	35
Compositing Using Luminance/Chroma Key .....	37
Compositing Using DSK .....	39
<b>About Other Features.....</b>	<b>41</b>
Enlarging/Reducing the Picture .....	41
Changing the Multi-view Labels.....	42
Saving Settings to MEMORY Buttons .....	43
Using a USB Memory Device.....	44
Saving Settings on a USB Memory Device.....	45
Using Still-image Files .....	46
Creating a Still Image from Final-output Video .....	48
Changing Cross-Points.....	49
Returning to the Factory-default State .....	50

---

<b>Menu Operations .....</b>	<b>51</b>
<b>Appendices.....</b>	<b>52</b>
Main Specifications .....	52
Name Plate .....	52
About Remote Control.....	53
About Rack Mounting .....	53
About the Input Template.....	53
Troubleshooting.....	54
Dimensions .....	55
<b>V-800HD Version 1.50 Added Functions.....</b>	<b>56</b>
<b>Index .....</b>	<b>60</b>

# Check the Included Items

The following items are included. Please make sure that all items are present. If anything is missing, please contact your dealer.

## V-800HD itself



## Owner's manual (this document)



## Power cord



## Rack mount angle (two)



\* For fitting of rack mount angles, refer to "About Rack Mount Angles" (p. 53).

## Input Template



\* Refer to "About the Input Template" (p. 53).

The explanations in this manual include illustrations that depict what should typically be shown by the display. Note, however, that your unit may incorporate a newer, enhanced version of the system, so what you actually see in the display may not always match what appears in the manual.

MMP (Moore Microprocessor Portfolio) refers to a patent portfolio concerned with microprocessor architecture, which was developed by Technology Properties Limited (TPL). Roland has licensed this technology from the TPL Group.



# About the Multi-view Monitor

## Connecting the Monitor

To operate the V-800HD, a monitor must be connected. Connect a monitor that supports HDMI input to the connector shown below.

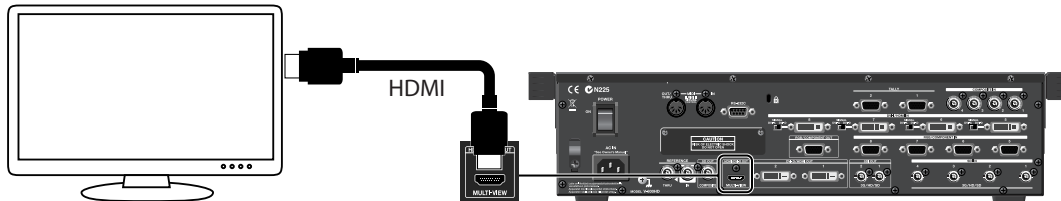

## Selecting an Output Format for the Multi-view Monitor

You can select an output format for the monitor connected to the V-800HD. Depending on the monitor you are using, select one from below.

### Output Y/Cb/Cr signal

Hold down [1] of the MEMORY buttons and turn the power on.



### Output RGB signal

Hold down [2] of the MEMORY buttons and turn the power on.

\* Select RGB output when you are connecting a monitor using a HDMI - DVI conversion cable or the like.



### MEMO

Once you select, the setup is kept and valid from the next booting. While booting, [1] or [2] of the MEMORY will light up in red and enables you to check your setup.

## About the Menu Displays

Pressing the [MENU] button on the top panel displays the menu. To make the menu disappear, press the [EXIT] or [MENU] button on the top panel.

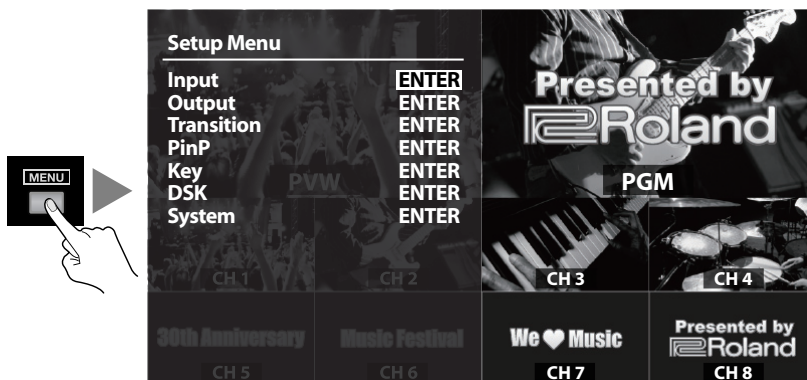

### cf.

For information on using the menus, refer to "Menu Operations" (p. 51). For information of the menu items, download "Reference Manual" from the following Roland website.

<http://www.rolandsystemsgroup.net/>

## About the Display on the Multi-view Monitor

When the source device is connected to the V-800HD and turned on, the output video and the source video are displayed as shown below.



### 1. PVW Section (Preview Output)

The video selected on the inactive bus (standby) is shown here. If that bus becomes active, the selected video will become the new program output.

### 2. PGM Section (Program Output)

The final output is displayed here. This is the program output sent to your displays.

### 3. CH 1 - CH 8 Section (Source Monitors)

This lets you monitor the video from source equipment connected to channels 1 through 8. A red border is displayed around the channel that is sent to the final output (PGM). A green border is displayed around channel that is on standby (PVW).

- \* The input source images are displayed here directly (without any parameter changes). Settings such as color adjustment or scaling are not applied.
- \* Changing the channel assignments at the cross-point (p. 49) also changes the order of displayed sources.
- \* Still images imported from USB memory are not displayed on the source monitor.

#### NOTE

The frame rate for the DVI-I/HDMI inputs and RGB/Component inputs is reduced by about 5 fps. Images of SDI inputs and composite inputs are displayed at the original frame rate coming from the source devices.

#### cf. ➔

You can change the text strings for [PGM] and [PVW] and for [CH 1] through [CH 8]. Refer to "Changing the Multi-view Labels" (p. 42).

# About Power Supply

Connect the included power cord to AC IN connector on rear panel. Be sure to use the included power cord for AC connection.

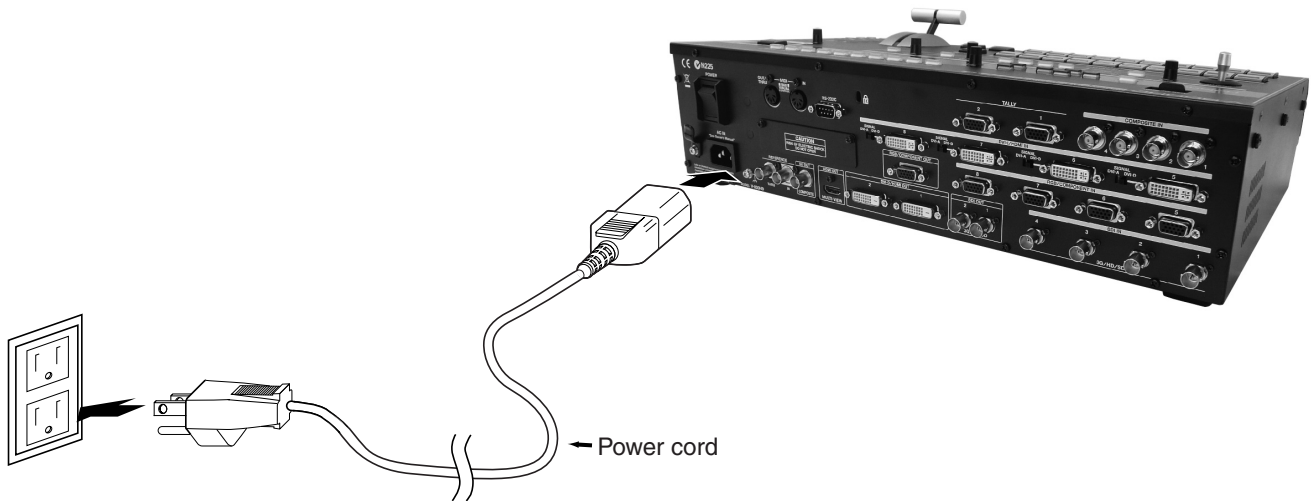

## About the Ground Terminal

Depending on the circumstances of a particular setup, you may experience a discomforting sensation, or perceive that the surface feels gritty to the touch when you touch this device, video cameras connected to it, or the metal portions of other objects, such as projectors. This is due to an infinitesimal electrical charge, which is absolutely harmless. However, if you are concerned about this, connect the ground terminal (see figure) with an external ground. When the unit is grounded, a slight hum may occur, depending on the particulars of your installation. If you are unsure of the connection method, contact the nearest Roland Service Center, or an authorized Roland distributor, as listed on the "Information" sheet.

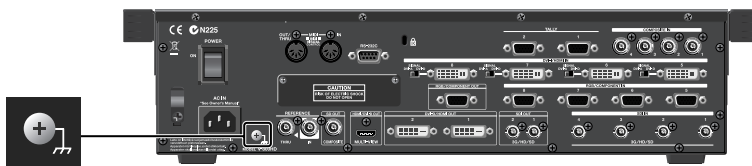

### Unsuitable places for connection

- Water pipes (may result in shock or electrocution)
- Gas pipes (may result in fire or explosion)
- Telephone-line ground or lightning rod (may be dangerous in the event of lightning)

## About the Cord Hook

Secure the power cord in place using the cord hook as shown below. This can help prevent power loss due to the plug being pulled out if the power cord is accidentally yanked.

### 1. Connect the power cord to the AC IN connector.



### 2. Secure the power cord in place with the cord hook.

Clamp the cord hook onto the power cord to secure it in place.



## Turning the Power On and Off

### Turning the Power On

Once everything is properly connected (p. 11, p. 19), be sure to follow the procedure below to turn on their power. If you turn on equipment in the wrong order, you risk causing malfunction or equipment failure.

- \* This unit is equipped with a protection circuit. A brief interval (a few seconds) after power up is required before the unit will operate normally.
- \* When still images are saved to the internal memory, booting of this unit will take longer because of preparations.

#### 1. Connect the peripheral devices.

Connect video cameras or other equipment. Make the connections while the power to all equipment, including the V-800HD, is turned off.

#### 2. Turn on the power to the V-800HD.

Set the POWER switch on the rear panel to ON to turn on the power to the V-800HD.

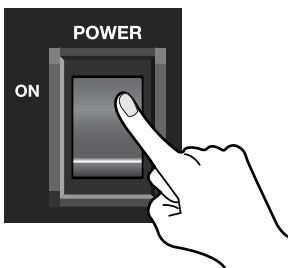

#### 3. Turn on the power to the source devices.

Turn on the power to the source devices like video cameras connected to the V-800HD.

#### 4. Turn on the power to the output devices

Turn on the power to the output devices like projectors connected to the V-800HD.

### Turning the Power Off

#### 1. Turn off the power to the output devices.

Turn off the power to the output devices connected to the V-800HD.

#### 2. Turn off the power to the V-800HD.

Set the POWER switch on the rear panel to OFF to turn off the power to the V-800HD.

#### 1. Turn off the power to the source devices.

Turn off the power to the source devices connected to the V-800HD.

#### NOTE

Do not turn off the power while a message of "Processing..." is shown on menu display area of the multi-view monitor. Your settings may not be saved properly.

#### MEMO

If you need to turn off the power completely, first turn off the unit, then unplug the power cord from the power outlet. Refer to Power Supply(p. 5).

# Part Names and Functions

## Top Panel

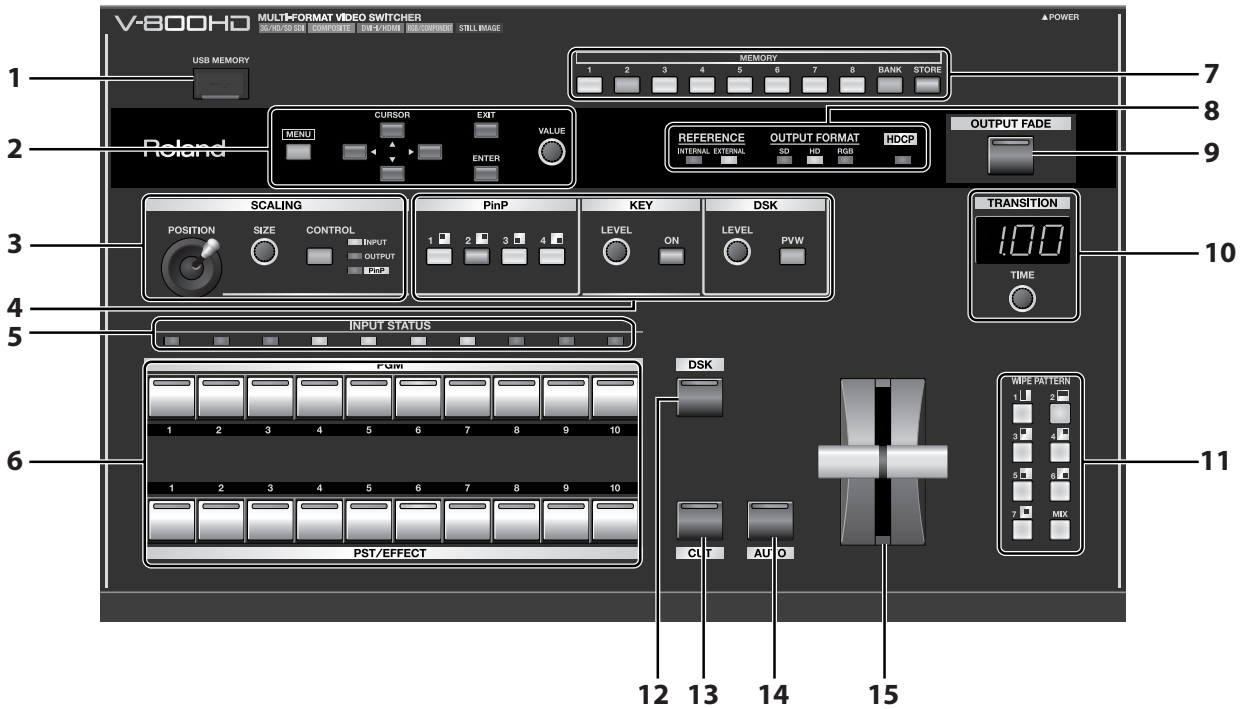

### 1 USB Port

This is for connecting a USB memory device when importing a still image or when saving/loading settings (p. 44).

\* Open the sliding cover only when you are using the USB port. When this is not in use, be sure to keep the sliding cover closed to protect the connector inside.

### 2 Setup Section

Use these menu controls to change settings on the V-800HD.

### 3 Scaling Section

You can zoom in/out the screen or adjust the display location. When you are applying Picture-in-Picture, you can use controls in this section to adjust the display location and size of the inset screen (p. 36, p. 41).

### 4 Compositing Section

Use the controls in this section when compositing two screens like Picture-in-Picture (p. 35), key compositing (p. 37), or DSK (p. 39).

### 5 INPUT STATUS Indicators

The indicators here indicate the input status for cross-points. They light up when valid signals are input.

### 6 Cross-Points

10 buttons each on the [PGM] and [PST/EFFECT] sides. Use these to select the output video and standby video.

- PGM

The button for the channel currently being output lights up in red, and the channel is displayed in [PGM] section of the multi-view monitor.

- PST/EFFECT

These select the video you want to output (put into standby) next, and the source for compositing, such as the inset screen for Picture-in-Picture. Pressing a button to select the source makes the button light up in green. (When a compositing effect is applied, the button lights up in red.) The video is also displayed in the [PVW] section of the multi-view monitor. You can switch from standby to output by operating the [CUT] or [AUTO] button or the video fader.

By default, inputs from source devices are assigned to [1] through [8]. A still image is assigned to [9], and plain color video (by default, black) is assigned to [10]. For information on changing button and source combinations, refer to "Changing Cross-Points" (p. 49).

## 7 MEMORY Buttons

Use these to save the current settings to the internal memory. You can also use them to call up saved settings (p. 43).

## 8 Signal Indicators

These display the status of synchronization and the format of the output signal (p. 24).

- REFERENCE

[INTERNAL] lights up during synchronization to the internal clock of the V-800HD, and [EXTERNAL] lights up during synchronization to an external source. The indicator flashes when the V-800HD cannot synchronize with the external device.

- OUTPUT FORMAT

This indicates the output format (p. 26) of the V-800HD. The corresponding combinations of the SD, HD, and RGB indicators are as follows.

SD	480i, 576i
HD	480p, 576p, 720p, 1080i, 1080p
RGB	VGA (640x480) through WUXGA (1920x1200)

- HDCP

Refer to "Inputting HDCP Signals" (p. 29).

## 9 OUTPUT FADE Button

This applies fade to program output. The button flashes while the fade is in progress. The button lights up continuously when a fade-out has been completed. The button goes dark when a fade-in has been completed (p. 34).

\* By default, the fade time is set at 0.5 seconds. You can use the menus (p. 51) to change the fade time. For information on the details of menus and their items, download "Reference Manual" from the following Roland website.

<http://www.rolandsystemsgroup.net/>

\* By default, the video fades to black. You can use the menus to change it. It is possible to fade to an imported still image (p. 46) or to the still image (freeze frame) made from the video currently being output (p. 48).

## 10 TRANSITION Dial and Indicator

Use this dial to set the transition time (p. 31).

\* You can use the menus to change time unit to be displayed here. By default, the unit is second. You can change it to frames or to seconds + frames.

## 11 WIPE PATTERN Selectors

These select the effect used for a video transition.

\* You can use the menus to assign other wipe patterns to the buttons.

## 12 DSK Button

This makes the DSK source appear or disappear. It lights when the key source video is displayed and goes dark when the key source video is removed. (p. 39).

\* The length of time for appearance/disappearance depends on the setting for transition time.

## 13 CUT Button

Press this button to output the channel in standby. Pressing this button provides an immediate hard cut between sources.

## 14 AUTO Button

Press this button to output the channel in standby. Pressing this button applies the transition effect selected using the [WIPE PATTERN] selectors.

## 15 Video Fader

You can use the video fader instead of the [CUT] or [AUTO] buttons to perform a transition manually. When the transition is made manually, the time for transition effect changes depending on movement of the fader, regardless of the setting for transition time.

## Rear Panel

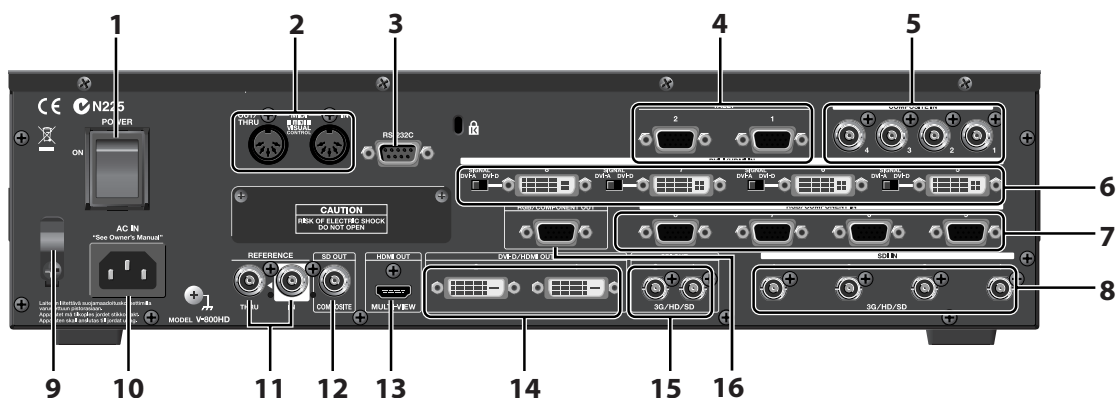
**1 POWER Switch**

This turns the power to the V-800HD on and off.

**2 MIDI IN and OUT/THRU Connectors**

You can use these when you remote control the unit from an external MIDI device (a device compatible with MIDI VISUAL CONTROL or the like), or when using the unit to perform remote control of another device.

**3 RS-232C Connector**

You can use this when you remote control the unit from an external RS-232C device.

\* For information about operating the unit remotely via MIDI or the RS-232C interface, download the "Remote Control Guide" from the following Roland website.

<http://www.rolandsystemsgroup.net/>

**4 TALLY Connectors**

Connect devices provided with tally-light feature (p. 25).

**5 COMPOSITE IN Connectors**

Connect video cameras or other equipment capable of composite output. Composite inputs are assigned to channels 1 through 4.

**NOTE**

By default, SDI IN 1 through 4 are selected as the sources for channels 1 through 4. To enable composite input, use the menus to change the source. Refer to "Making a Composite Connection" (p. 20).

**6 DVI-I/HDMI IN Connectors**

Connect a computer or other source equipment capable of DVI output. DVI input is assigned to channels 5 through 8.

**NOTE**

Use the switches to select [DVI-A] or [DVI-D] as required to match the type of output signal from the source equipment. Refer to "Making a DVI/HDMI Connection" (p. 22).

**7 RGB/COMPONENT IN Connectors**

At RGB/COMPONENT IN, connect a computer or other source equipment capable of analog RGB output. RGB inputs are assigned to channels 5 through 8.

\* By using a conversion cable from component to mini D-Sub 15-pin type, you can also connect equipment capable of Y/Pb/Pr component output.

**NOTE**

By default, DVI-I/HDMI IN 5 through 8 are selected as the sources for channels 5 through 8. To enable RGB input, use the menus to change the source. Refer to "Making an RGB/Component Connection" (p. 22).

**8 SDI IN Connectors**

Connect video cameras or other source equipment capable of SDI output. SDI inputs are assigned to channels 1 through 4.

\* As SDI source equipment, you can connect devices that output 3G-SDI, HD-SDI or SD-SDI signals.



## 9 Cord Hook

Securing the power cord in place using the cord hook can help prevent power loss due to the plug being pulled out if the power cord is accidentally yanked.

## 10 AC IN Connector

This is for connecting the included power cord.

## 11 REFERENCE IN/THRU Connectors

Connect an external source device for synchronization to the REFERENCE IN connector. When supplying a synchronizing signal to an external device via the V-800HD, use the REFERENCE THRU connector.

\* For information on using an external source device for synchronizing, refer to "Connecting a Clock Source" (p. 24).

## 12 SD OUT Connector

Video converted to NTSC or PAL is output here, irrespective of the output format of the SDI OUT or DVI-D/HDMI OUT connectors.

\* When HDCP (p. 29) is set to [ON], nothing is output from the SD OUT connector.

## 13 HDMI OUT Connector

Connect a multi-view monitor here (p. 9).

## 14 DVI-D/HDMI OUT Connectors

Connect a projector or other output equipment capable of DVI-D input. By using a conversion cable from DVI-D to HDMI, you can also connect equipment capable of HDMI input.

## 15 SDI OUT Connectors

Connect a TV monitor, a video deck, or other equipment capable of SDI input.

\* When the setting for HDCP signal input has been made, nothing is output from these connectors.

\* When the output format is set to RGB or 480p/576p, nothing is output from these connectors.

## 16 RGB/COMPONENT OUT Connector

Analog RGB/component signals are output from here, irrespective of the output format of the SDI OUT or DVI-D/HDMI OUT connectors. Separate scaling is possible for analog output.

\* By using a conversion cable from mini D-Sub 15-pin type to component, you can also connect equipment capable of Y/Pb/Pr component input.

\* When HDCP (p. 29) is set to [ON], nothing is output from the RGB/COMPONENT OUT connectors.



For information on the output format setting, refer to "Selecting the Output Format" (p. 26).

# Signal Flow

The internal signal flow of the V-800HD is as shown below.

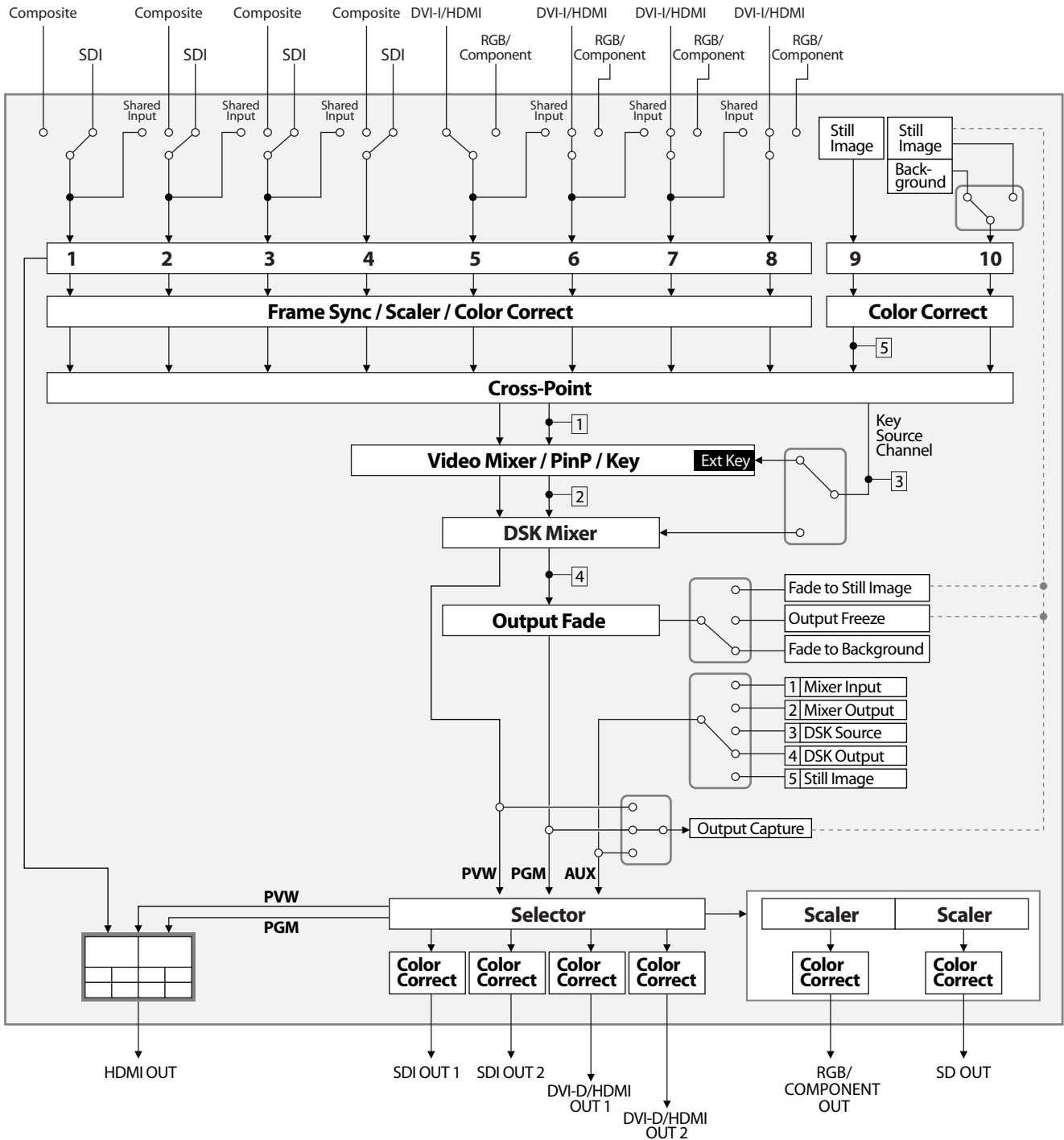

**NOTE**

Areas in the figure that are connected by dotted lines cannot be used simultaneously. For example, when assigning a still image to output fade or freezing the output, assigning the still image to channel 10 is not possible. In such cases, change the source on channel 10 to plain colored video (background color).

# Connecting External Equipment

Connect external equipment as shown in this chapter. For information on specific connection methods, refer to the following pages.

\* To prevent malfunction or damage to video monitors or other devices, always turn off the power on all devices before making any connections.

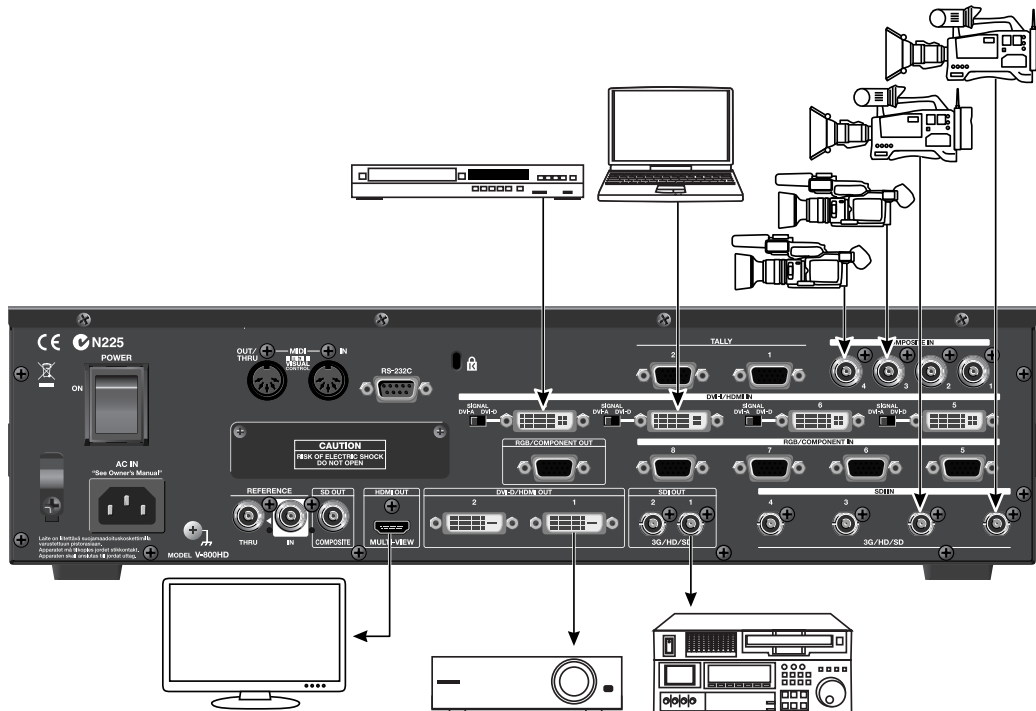

## About Input Formats

Signals of the formats shown below can be input from source equipment.

\* RGB/DVI refresh rates are the maximum value at the respective resolution.

### SDI

480/59.94i, 576/50i, 720/50p, 720/59.94p, 1080/50i, 1080/59.94i, 1080/50p, 1080/59.94p

### Component

480/59.94i, 576/50i, 480/59.94p, 576/50p, 720/59.94p, 720/50p, 1080/59.94i, 1080/50i, 1080/59.94p, 1080/50p

### RGB

640x480/60 Hz, 800x600/60 Hz, 1024x768/60 Hz, 1280x768/60 Hz, 1280x1024/60 Hz, 1366x768/60 Hz, 1400x1050/60 Hz, 1600x1200/60 Hz, 1920x1200/60 Hz (Reduced Blanking)

### DVI/HDMI

640x480/60 Hz, 800x600/60 Hz, 1024x768/60 Hz, 1280x768/60 Hz, 1280x1024/60 Hz, 1366x768/60 Hz, 1400x1050/60 Hz, 1600x1200/60 Hz, 1920x1200/60 Hz (Reduced Blanking), 480/59.94i, 576/50i, 480/59.94p, 576/50p, 720/59.94p, 720/50p, 1080/59.94i, 1080/50i, 1080/59.94p, 1080/50p

### Composite

480/59.94i, 576/50i

#### MEMO

The V-800HD automatically detects the input format.

#### MEMO

For information on output format, refer to "Selecting the Output Format" (p. 26).

## Connecting Source Equipment

### Connecting Video Sources

#### Making SDI Connections

Connect SDI equipment such as video cameras or video decks to the SDI IN connectors. SDI inputs are assigned to channels 1 through 4. The type of signal output from the source equipment (3G-SDI, HD-SDI or SD-SDI) is detected automatically.

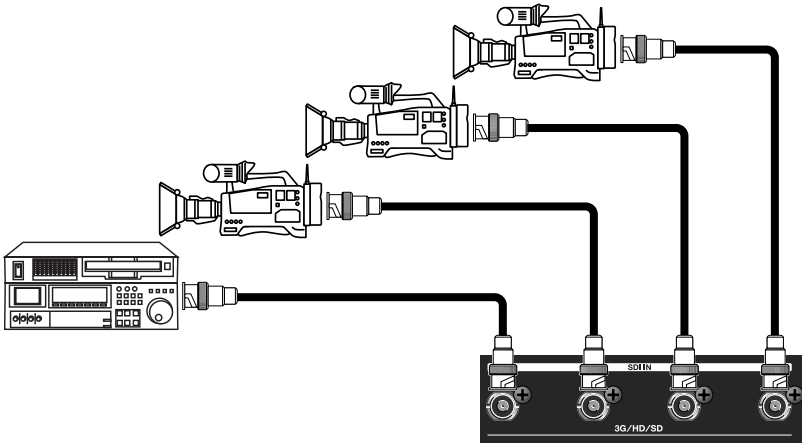

**MEMO**

You can connect 3G-SDI, HD-SDI or SD-SDI source equipment to the SDI IN connectors. If a signal is input that has an aspect ratio different from the V-800HD's output format, the image fills the screen at the output (default setting). You can also use the menus (p. 51) to select Letterbox, Crop, or Squeeze.

#### Making Composite Connections

Connect equipment capable of composite output such as video cameras or DVD players to the COMPOSITE IN connectors.

\* When connecting equipment that has an RCA pin type output jack, use a conversion plug.

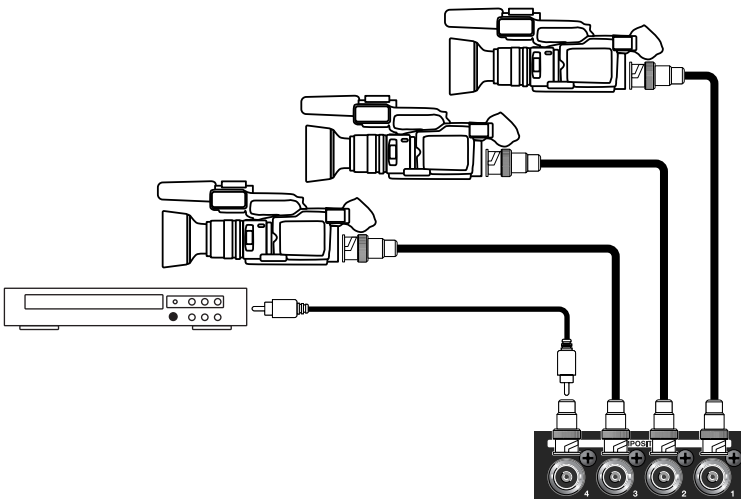

Connecting source equipment to a COMPOSITE IN connector requires changing the setting on the V-800HD. Use the procedure described below to change the source from SDI to composite.

**1. Display the Input menu.**

Press the [MENU] button to display the menu. Use the [CURSOR] buttons to select [Input], then press the [ENTER] button to display the Input menu.

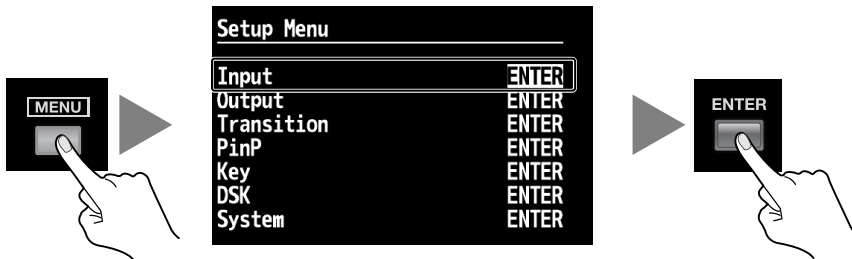

**2. Select the channel.**

Use the [CURSOR] buttons to select which input format you wish to use at this input channel.

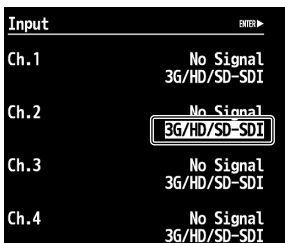

**3. Change the assignment.**

Turn the [VALUE] dial to change the setting to [Composite] or [3G/HD/SD-SDI], depending on which source type is plugged into that input.

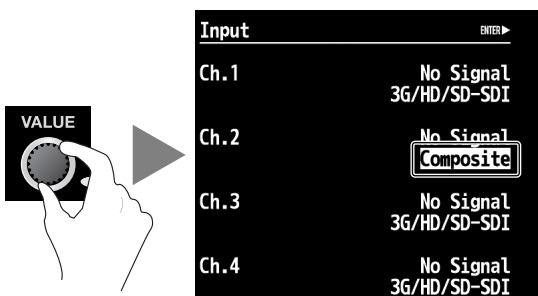

**4. Exit the menu.**

Press the [EXIT] button several times to quit the menu.



## Connecting a Computer or HDMI Equipment

### Making a DVI/HDMI Connection

Connect computers and video cameras capable of DVI or HDMI output to the DVI-I/HDMI IN connectors. Inputs are assigned to channels 5 through 8.

\* For equipment capable of HDMI output, make the connection using a conversion cable.

**MEMO**

By default, the V-800HD does not support HDCP (High-bandwidth Digital Content Protection). When inputting video to which HDCP is applied, refer to "Inputting HDCP Signals" (p. 29) and change the settings on the V-800HD.

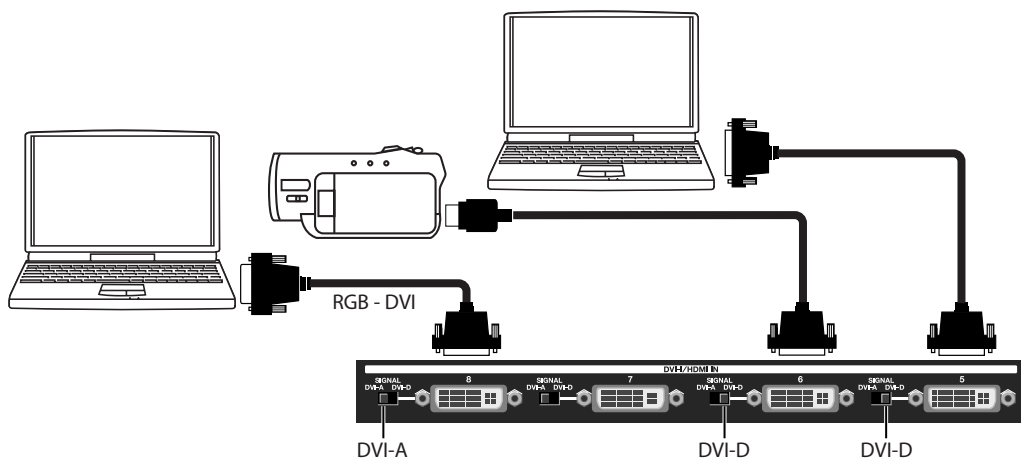

**NOTE**

Use the switch shown below for each respective connector to select [DVI-A] or [DVI-D] to match the type of output signal from the computer. If this switch is set incorrectly, you will not have any input signal. When [DVI-A] has been selected, analog RGB can also be connected. In such cases, use a conversion cable from mini D-Sub 15-pins to DVI.

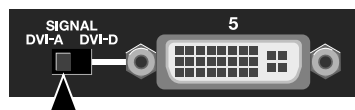

### Making an RGB/Component Connection

Connect computers capable of analog RGB output to the RGB/COMPONENT IN connectors.

**MEMO**

By using a conversion cable from component to mini D-Sub 15-pins type, you can also connect equipment capable of component output.

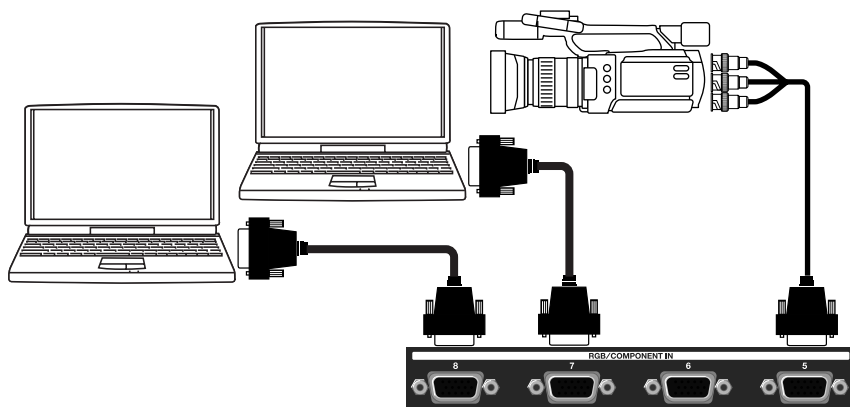

**NOTE**

The resolution and refresh rate of the input signal are detected automatically, but inputting signals not listed in "About Input Formats" (p. 19) is not possible. Adjust the output resolution and refresh rate of your computer to match the valid input format.

Connecting source equipment to RGB/COMPONENT IN connectors requires changing a setting on the V-800HD. Use the procedure described below to change the source from DVI to RGB/Component.

### 1. Display the Input menu.

Press the [MENU] button to display the menu. Use the [CURSOR] buttons to select [Input], then press the [ENTER] button to display the Input menu.

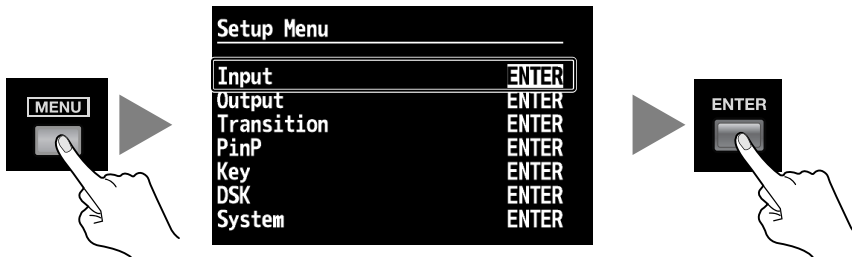

### 2. Select the channel.

Use the [CURSOR] buttons to select which input format you wish to use at this input channel.

\* If the target channel is not displayed, press the left or right [CURSOR] button to change the page.

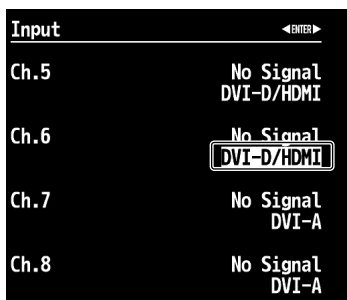

### 3. Change the assignment.

Turn the [VALUE] dial to change the setting to [RGB/Component].

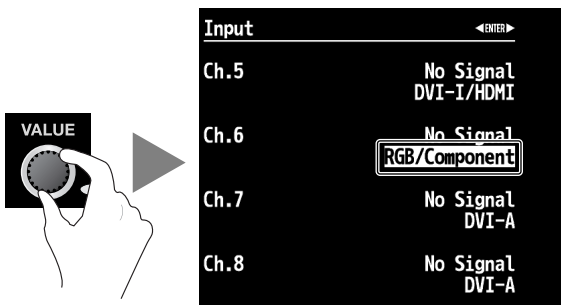

### 4. Exit the menu.

Press the [EXIT] button several times to quit the menu.



## About Sharing a Source

Channels 1 through 4 and channels 5 through 8 can share source video. Using this feature, you can assign the video on channel 1 to channels 2 through 4 and the video on channel 5 to channels 6 through 8.

When shared, a single source video is assigned to multiple cross-point buttons. To share, go to the input format display area of the Input menu and select [Shared Input].

\* Only the source of the previous adjacent channel can be shared. Therefore, when sharing the source on channel 1 with channels 2 through 4, [Shared Input] must be selected for each channel from 2 to 4.

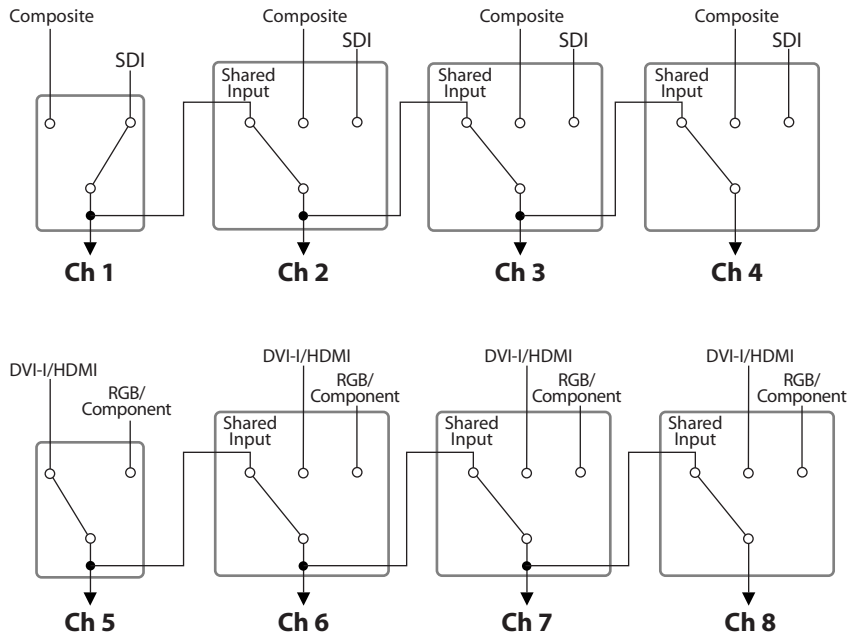

## Connecting a Clock Source

You can connect a source device for synchronizing.

\* You can send (thru-out) the synchronizing signal from the THRU connector.

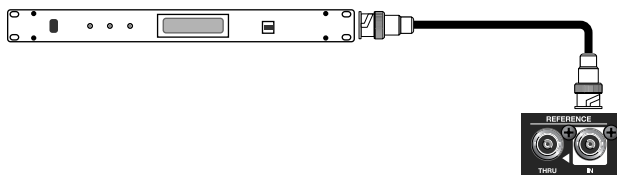

The V-800HD supports the external clocks shown below. To synchronize with an external clock, select [Reference] in System menu and set the value to [External].

- Black burst (frame synchronization)
- Bi-level synchronization, tri-level synchronization

### NOTE

The composite output from SD OUT jack always synchronizes to the V-800HD's internal clock regardless to the setting of [Reference] parameter.



## Connecting Output Equipment

For information on signal formats that can be output from the V-800HD, refer to “Selecting the Output Format” (p. 26).

### Connecting a Projector

Connect to an RGB/COMPONENT OUT connector or to a DVI-D/HDMI OUT connector, depending on the input connector on the projector.

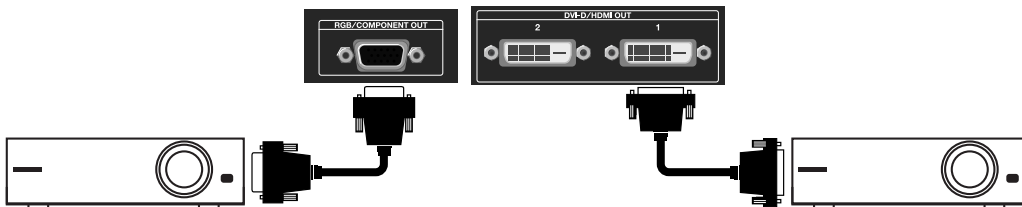

### Connecting Recording Equipment

Connect recording equipment such as video decks to the SD OUT connector or to an SDI OUT connector.

\* NTSC or PAL video is output from the SD OUT connector, irrespective of the setting for output format on the V-800HD.

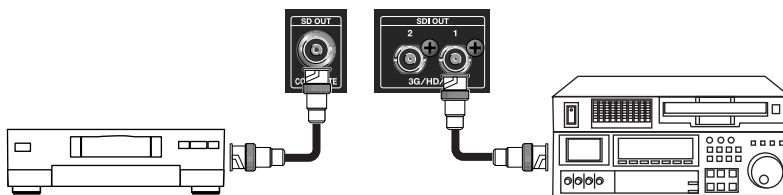

**NOTE**

When HDCP is set to [ON] (p. 29), output from the V-800HD will be DVI-D/HDMI signal only. The HDCP will be applied to DVI-D/HDMI only.

### Tally Output

The V-800HD is equipped with two D-Sub 15-pins TALLY connectors. Connecting a video monitor capable of tally input to these makes it possible to illuminate the tally lamps on the monitor. The lamp is switched on and off according to the channel selection, enabling you to see which channel is currently in use on the monitor.

\* The specifications of TALLY connectors are as below.

- D-sub 15-pin type, max input: 12 V/200 mA
- Open-collector type

The channels shown below are assigned to the TALLY 1 and 2 connectors on the V-800HD.

TALLY 1		TALLY 2	
Pin No.	Channel	Pin No.	Channel
1	PGM Ch.1	1	PGM Ch.5
2	PST Ch.1	2	PST Ch.5
3	NC	3	NC
4	GND	4	GND
5	PGM Ch.4	5	PGM Ch.8
6	PGM Ch.2	6	PGM Ch.6
7	PST Ch.2	7	PST Ch.6
8	NC	8	NC
9	GND	9	GND
10	PST Ch.4	10	PST Ch.8
11	PGM Ch.3	11	PGM Ch.7
12	PST Ch.3	12	PST Ch.7
13	NC	13	NC
14	GND	14	GND
15	NC	15	NC

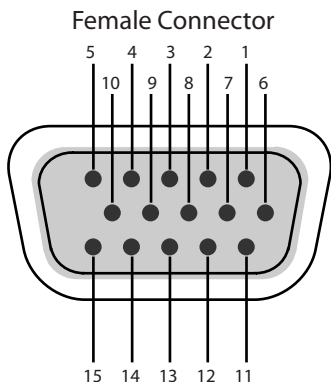

# Selecting the Output Format

## NOTE

When the procedure in "Inputting HDCP Signals" (p. 29) has been followed to set the HDCP mode to [ON], output from the SDI OUT, SD OUT, and RGB/COMPONENT OUT connectors will be stopped. Note, however, that HDCP-applied output from the DVI-D/HDMI OUT connectors and output to the multi-view monitor will continue.

## About the Setting for the Output Format

This selects the format of the main output (digital) and analog outputs shown below. Signals that have different resolutions can be output from digital and analog connectors.

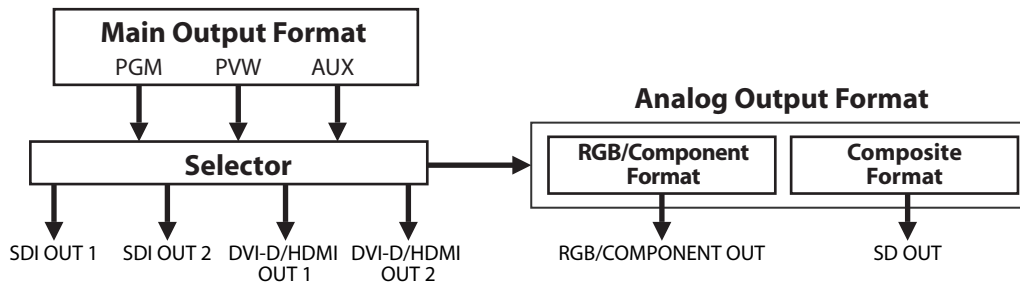

The [OUTPUT FORMAT] indicator for the format selected for the main output lights up. The corresponding output formats of the SD, HD, and RGB indicators are as follows.

- SD 480i, 576i
- HD 480p, 576p, 720p, 1080i, 1080p
- RGB VGA (640x480) through WUXGA (1920x1200)

\* By default, [HD] is selected, and the unit is set to output 1080i.



For information on the selectable output formats, refer to "About the Output Formats of the Connectors" on the following page.

## Changing the Format of the Main Output

This changes the output format of the SDI OUT connectors and DVI-D/HDMI OUT connectors. This setting is shown by the [OUTPUT FORMAT] indicators.

### 1. Display the Output menu.

Press the [MENU] button to display the menu. Use the [CURSOR] buttons to select [Output], then press the [ENTER] button to display the Output menu.

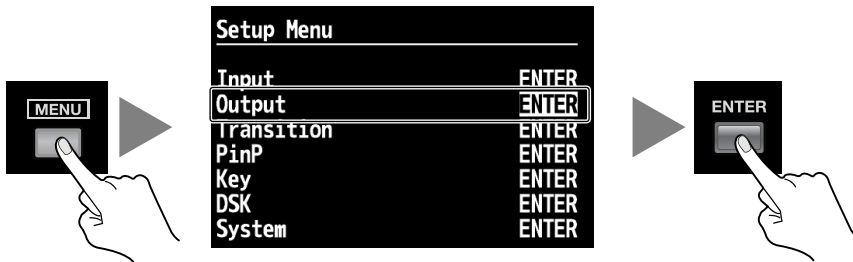

### 2. Select the main output.

Use the [CURSOR] buttons to go to [Format] and select the [Main] format display area, then use the [VALUE] dial to change the format.

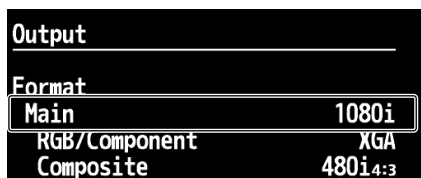

### 3. Exit the menu.

Press the [EXIT] button several times to quit the menu.



## About the Format Setting for RGB/Component and Composite Output

After setting the format for the main (digital) output, you can also carry out scaling. At the Output menu, select [RGB/Component] or [Composite], and you can then turn the [VALUE] dial to set the output format.

\* The format settings for analog outputs will not be shown by the [OUTPUT FORMAT] indicators.

## About Color Correction for Output

Using the menus, you can apply color correction separately to the main outputs and to analog outputs. For information on the details of menus and their items, download the "Reference Manual" from the following Roland website.

<http://www.rolandsystemsgroup.net>

## About the Output Formats of the Connectors

The V-800HD can output signals of the following formats from the various output connectors. But the output to the multi-view monitor (the HDMI OUT connector) is fixed at 1920x1080/60 Hz.

### **NOTE**

The format you can select differs depending on the system frame rate of the V-800HD.

### **SDI OUT Connectors**

480/59.94i, 576/50i, 720/50p, 720/59.94p, 1080/50i, 1080/59.94i, 1080/50p, 1080/59.94p

### **RGB/COMPONENT OUT Connectors**

640x480, 800x600, 1024x768, 1280x768, 1280x1024, 1366x768, 1400x1050, 1600x1200, 1920x1200,  
480/59.94p, 576/50p, 720/59.94p, 720/50p, 1080/59.94p, 1080/50p

\* For switching of 59.94p and 50p, go to the System menu and use [Frame Rate] to select [59.94Hz] or [50Hz].

### **DVI-D/HDMI OUT Connectors**

640x480, 800x600, 1024x768, 1280x768, 1280x1024, 1366x768, 1400x1050, 1600x1200, 1920x1200, 480/59.94i, 576/50i, 480/  
59.94p, 576/50p, 720/59.94p, 720/50p, 1080/59.94i, 1080/50i, 1080/59.94p, 1080/50p

\* The underlined formats are output at 75 Hz when the system refresh rate is set at 50 Hz.

### **SD OUT Connectors**

480/59.94i, 576/50i

\* Output from the SD OUT connector is always 480/59.94i or 576/50i, irrespective of the setting for output format.

## About the Setting for the Output Source

On the V-800HD, you can select PGM, PVW, or AUX as the output source. Display the Output menu and select an output connector. Then you can select [PGM], [PVW] or [AUX].

\* Separate sources can be assigned to SDI OUT (1/2) and DVI/HDMI OUT (1/2), but the source for the RGB/COMPONENT OUT and COMPOSITE OUT connectors will be changed simultaneously.

# Inputting HDCP Signals

By default, the V-800HD does not support HDCP (High-bandwidth Digital Content Protection). This means that HDCP-applied signals from Blu-ray Disc players and the like cannot be input. When inputting signals to which HDCP is applied, follow the procedure shown below to change the setting.

\* HDCP is copyright-protection technology that prevents unlawful copying of content.

## 1. Display the System menu.

Press the [MENU] button to display the menu. Use the [CURSOR] buttons to select [System], then press the [ENTER] button to display the System menu.

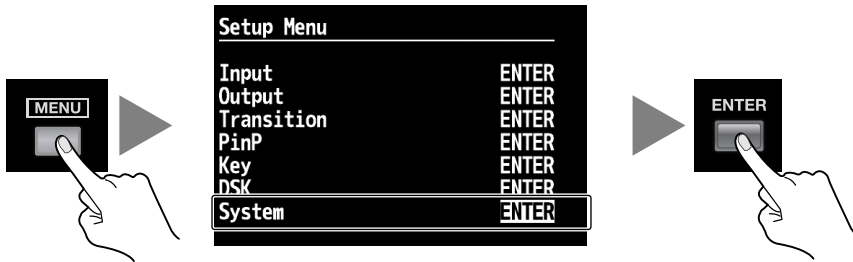

## 2. Change the setting.

Use the [CURSOR] buttons to select [HDCP]. Turn the [VALUE] dial to change the setting from [OFF] to [ON]. A confirmation screen appears. Press the [ENTER] button.

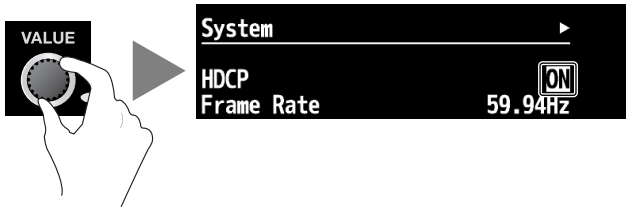

## 3. Exit the menu.

Press the [EXIT] button several times to quit the menu.



### NOTE

When the setting change just described has been made, output from the SD OUT, SDI OUT, and RGB/COMPONENT OUT connectors will be stopped. Note, however, that HDCP-applied output from the DVI-D/HDMI OUT connectors and output to the multi-view monitor will continue.

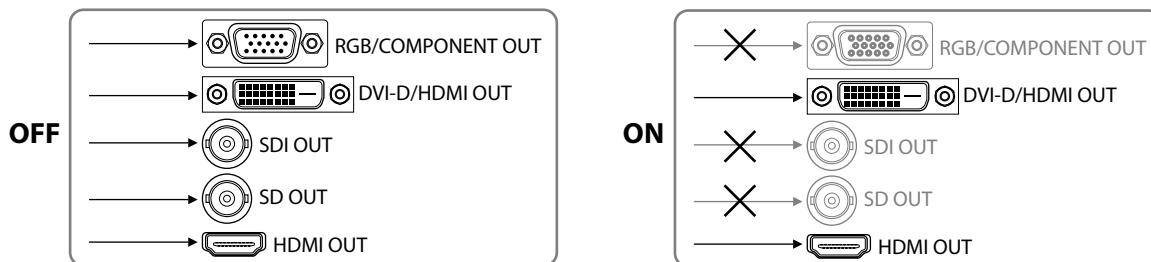

### About the HDCP Indicator

The [HDCP] indicator on the top panel operates as described below.

- It lights up when an HDCP compatible device is connected as the output device.
- It flashes when nothing is connected or when the connected device is not compatible with HDCP.
- It goes dark when [HDCP] is set to [OFF].

### About Verification of HDCP compatible Equipment

You can examine the HDCP compatibility of source equipment and output equipment. From the Input menu or Output menu, selecting [HDCP] displays a screen like the one shown below.

\* If the target channel is not displayed, press the left or right [CURSOR] button to change the page.

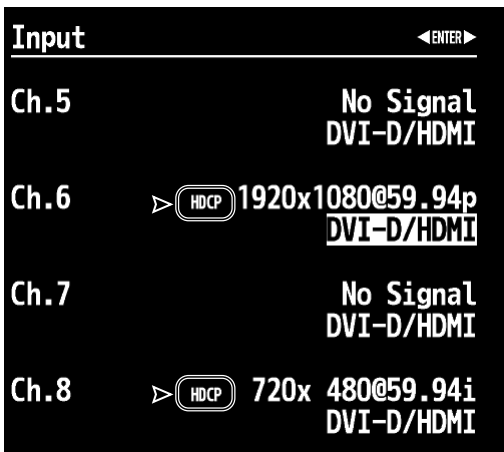

# Basic Operations

## Using Buttons to Switch the Video

### Applying Transition Effects

Using the [AUTO] button, you can apply transition effects during video switching. The transition effects are applied according to the settings of transition time and wipe pattern.

#### 1. Move the video fader all the way.

Before the transition, move the video fader all the way toward either the front or the back.

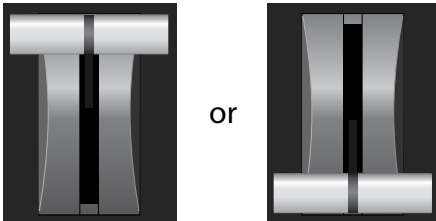

#### 2. Set the transition time.

Turn the TRANSITION [TIME] dial to set the time for the transition effect.

\* By default, the transition time is set at 1 second. When the unit is started for the first time, the indicator displays [1.0].

\* You can also use the menus (p. 51) to select the unit of time display. You can select from seconds, frames or seconds + frames as the display mode.



#### 3. Select the transition effect.

Use the buttons in the WIPE PATTERN section to choose a transition effect.

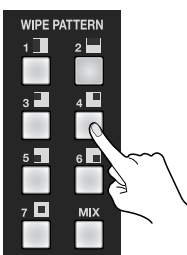

- MIX The transition is made progressively as the two pictures are mixed.
- WIPE 1 - 7 The transition is made using one of the following wipe patterns.

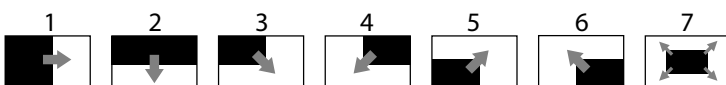

#### MEMO

You can also use the menus (p. 51) to select a different pattern and the direction of the wipe.

#### 4. Select the channel you want to output next (standby).

Use the cross-points on the [PST/EFFECT] side to choose the channel you want to output next. Pressing the button makes it light up in green. On the multi-view monitor, the selected channel is displayed with a green border around it. The video on the selected channel is also displayed in the [PVW] section.

- \* The 9 and 10 buttons on the [PST/EFFECT] side are used when outputting a still image or a color background.
- \* You can change the source assignments to cross-points (p. 49).

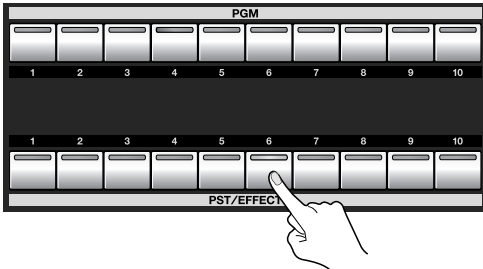

#### 5. Switch the video.

Preview the standby video, and press the [AUTO] button when you want to make the transition. The picture changes and the [PGM] button for the selected channel lights up in red. On the multi-view monitor, a red border is displayed around the channel being output. The output video is also displayed in the [PGM] section. The channel selected before transition on the [PGM] side becomes the selected one on the [PST/EFFECT] side.

- \* The button flashes while the transition effect is applied. On the multi-view monitor, the border around the source video turns to red.

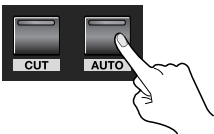

#### Switching without Transitions Effects

Using the [CUT] button makes the video change instantly, with no transition effect applied. Use [PST/EFFECT] buttons 1 through 8 to select the channel you want to output next, then press the [CUT] button.





## Using the Fader to Switch the Video

When you use the [AUTO] button to switch, the transition effect is applied according to the setting of transition time. Using the video fader, you can control the transition time manually.

### 1. Move the video fader all the way.

Before the transition, move the video fader all the way toward either the front or the back.

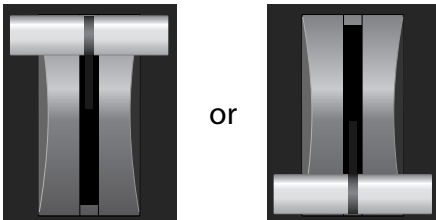

### 2. Select the transition effect.

Use the buttons in the WIPE PATTERN section to choose a transition effect.

### 3. Select the channel you want to output next (standby).

Use the cross-points on the [PST/EFFECT] side to choose the channel you want to output next. Pressing the button makes it light up in green. On the multi-view monitor, the selected channel is displayed with a green border around it. The video on the selected channel is also displayed in the [PVW] section.

### 4. Switch the video.

Move the video fader in the opposite direction of step 1. The button of the channel on [PGM] side lights up in red. On the multi-view monitor, a red border is displayed around the channel being output. The output video is also displayed in the [PGM] section. The channel selected before transition on the [PGM] side becomes the selected one on the [PST/EFFECT] side.

\* The button lights up while you are moving the video fader. On the multi-view monitor, a red border is displayed around the source video.

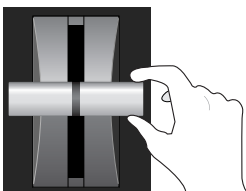

#### MEMO

The channel to output always changes from the [PST/EFFECT] side to the [PGM] side, irrespective of the fader movement direction.

## Applying Fade to Final Output

You can use the [OUTPUT FADE] button to apply a fade to the final output of the V-800HD. Applying a fade makes the output video gradually disappear (fade-out) or appear (fade-in).

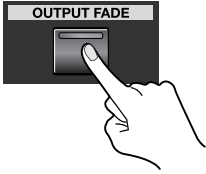

### 1. Apply a fade-out.

Pressing the [OUTPUT FADE] button makes the button flash and starts a fade-out. When the fade-out has been completed, the button stops flashing and stays lit.

### 2. Apply a fade-in.

Pressing the button a second time makes it flash and starts a fade-in. When the fade-in has been completed, the button goes dark.

#### MEMO

You can use the menus (p. 51) to change the following settings related to fades.

- Fade time The default setting is 0.5 seconds.
- Fade color The default setting is black.

## Fades to Other Images

Fades to plain color (like black) are possible. Using menus, you can change settings.

### Fade to Still Image

You can apply a fade to a still image imported into the V-800HD's internal memory from a USB memory device (p. 44). From the System menu, select [Output Fade], then for the [Mode] setting, select [Fade to Still Image].

#### NOTE

If the still image is assigned to channel 10, then assigning the still image to an output fade or freezing the picture during output is not possible. Also, when you are freezing the video during output, the source on channel 10 changes to a plain colored image (background color).

### Fade to Output Freeze

You can stop (freeze) the video currently being output (p. 48). From the System menu, select [Output Fade], then for the [Mode] setting, select [Output Freeze].

# Compositing the Video

## Picture-in-Picture (PinP)

This displays an inset screen superimposed upon a background picture. Use the dial and joystick of the SCALING section to adjust the size and position of the inset screen.

## Luminance Key/Chroma Key/External Key (KEY)

This performs compositing with a key-extracted video superimposed upon a background video. Use the [LEVEL] dial to adjust the amount of keying.

- \* By default, the setting is to apply black extraction. You can select different color using the menus (p. 51).
- \* When you are using external key, DSK cannot be used.

## Downstream Keyer (DSK)

You can make the results of a video transition or of PinP or of key compositing the background. Then overlay a logo or text (three-layer compositing). You can switch or composite the background video while continuing to display the logo or text unchanged. Use the [LEVEL] dial to adjust the amount of keying.

- \* By default, video input on channel 8 is assigned as the source for the DSK. You can select a different channel using the menus (p. 51).

### MEMO

Even if you switch video while compositing is carried out, no glitch occurs to the output video. You can switch the foreground picture (the inset screen for Picture-in-Picture, or the logo /text) or the background picture smoothly.

## Compositing Using Picture-in-Picture

This composites an inset screen into background video.

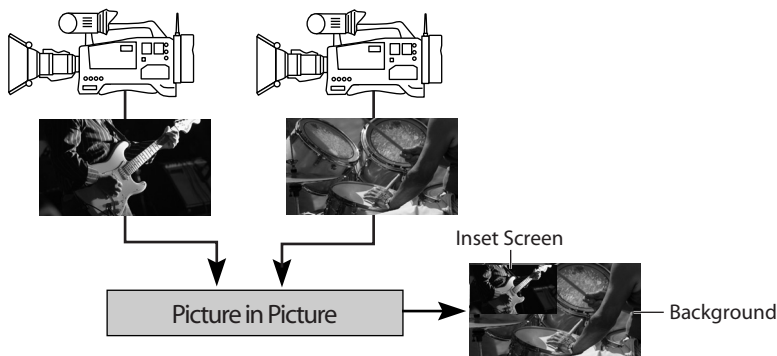

### 1. Select the background channel.

Use buttons 1 through 8 on the [PGM] side to select the background channel.

- \* When you want to use a still image or a plain colored background, press select 9 or 10.

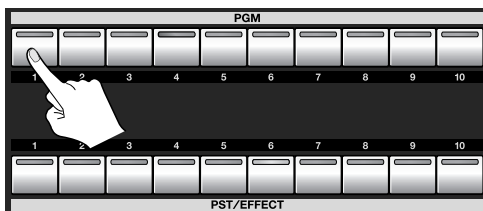

## 2. Select the channel of the inset screen.

Use buttons 1 through 8 on the [PST/EFFECT] side to select the channel of the inset screen.

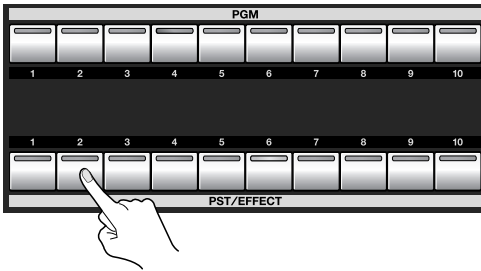

## 3. Preview the result of compositing.

Press any [PinP] position button to make it light up in green. The location where the inset screen is displayed varies depending on the button you press. When any of the [PinP] buttons is lighted, a preview of the compositing result is displayed in [PWV] section of the multi-view monitor. At this stage, the final output has not yet been changed.

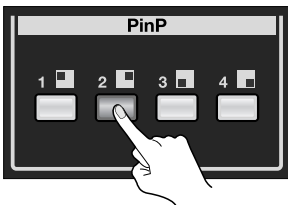

## 4. Adjust the size and position.

Go to the SCALING section and use the [CONTROL] button to select [PinP]. Use the [SIZE] dial and the [POSITION] joystick to adjust the size and positioning.

\* You can use the menus to save the size and position as well as settings for border color, width, and other parameters to individual PinP position buttons. You can also zoom the picture in the inset screen.

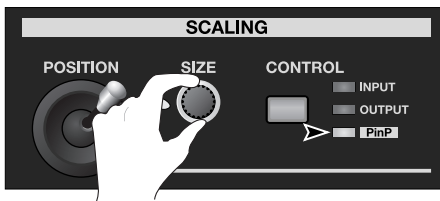

## 5. Output the composited result.

Use the [AUTO] or [CUT] button or the video fader to output the result of compositing. The color of the PinP position button changes to red at this time.

## 6. Make the inset screen disappear.

Pressing the [AUTO] or [CUT] button again or moving the video fader in the opposite direction makes the inset screen disappear. Making a second press of the [PinP] button you pressed in step 3 also makes the inset screen disappear.

### MEMO

You can use the menus to move the displayed position inside the inset screen. For information on the details of menus and their items, download "Reference Manual" from the following Roland website.

<http://www.rolandsystemsgroup.net/>

# Compositing Using Luminance/Chroma Key

You can perform compositing using luminance key or chroma key.

\* By default, black extraction is applied. You can select a different color using the menus (p. 51).

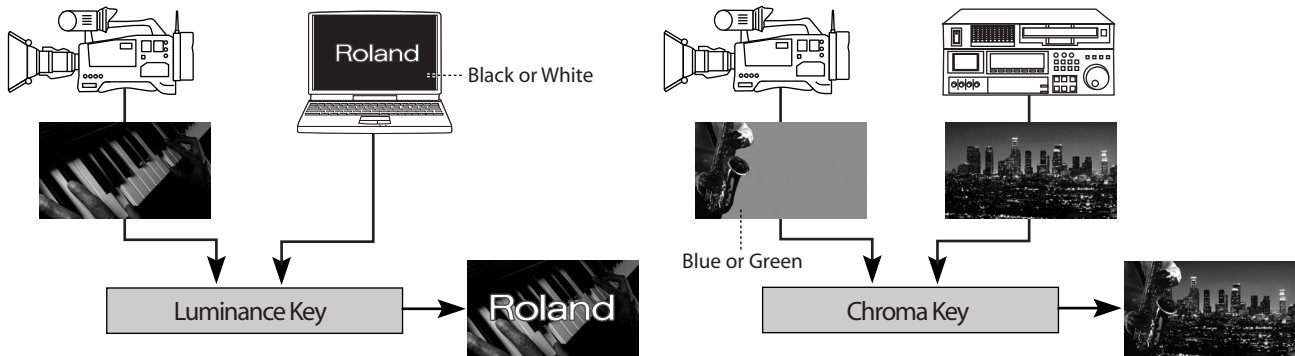

### 1. Select the background channel.

Use buttons 1 through 8 on the [PGM] side to select the background channel.

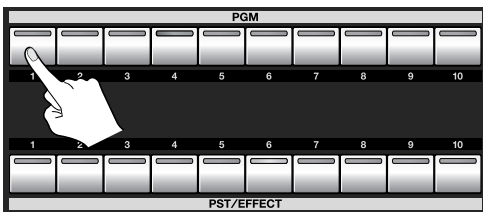

### 2. Select the channel to overlay.

Use buttons 1 through 8 on the [PST/EFFECT] side to select the channel to overlay.

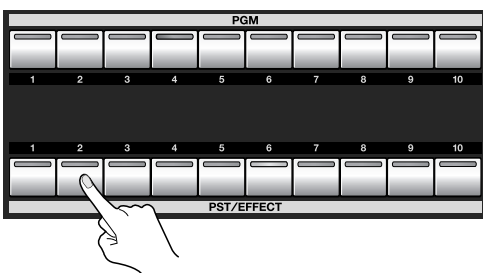

### 3. Preview the results of compositing.

At the KEY section, press the [ON] button to make it light up green. When the [ON] button lights up, a preview of the compositing result is displayed in [PVW] section of the multi-view monitor. At this stage, the final output has not yet been changed.

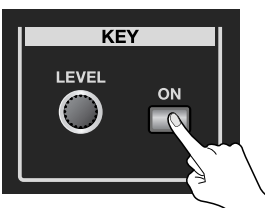

#### 4. Adjust the amount of keying.

While viewing the preview, turn the [LEVEL] dial in the KEY section to adjust the amount of keying.

\* You can use the menus to change the degree of edge blur. At the Key menu, adjust [Gain]. Also, when you are using chroma key, you can use [Hue] to adjust the extraction color.



#### 5. Output the composited results.

Use the [AUTO] or [CUT] button or the video fader to output the results of compositing. The color of the [ON] button changes to red at this time.

#### 6. Make the overlaid picture disappear.

Pressing the [AUTO] or [CUT] button again or moving the video fader in the opposite direction makes the overlaid video disappear. Making a second press of the [ON] button you pressed in step 3 also makes the overlaid picture disappear.



Combining Picture-in-Picture and luminance/chroma key lets you use the [SIZE] dial to enlarge or reduce the size of the overlaid picture. You can also use the [POSITION] joystick to move the display position. When combining, press any of the [PinP] buttons to make it light up.



### About External Key

At the Key menu, selecting [Mode] and changing the setting to [External Key] lets you perform compositing using an external key source.

\* You can select either white or black as the extraction color. Go to [Type] of the Key menu to make the setting.

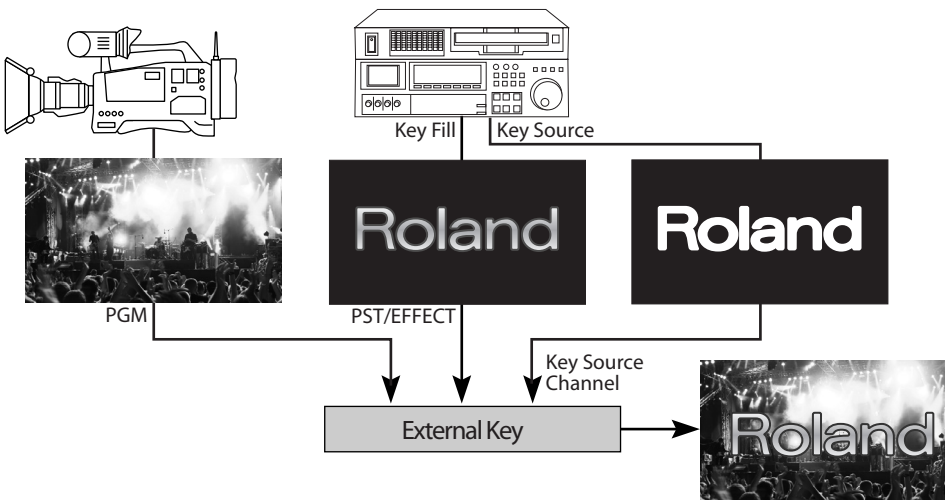

The channel where the external key source is input must be set at the Key menu. Select the channel in [Key Source Channel]. The procedure for compositing is the same as for luminance key or chroma key.

#### NOTE

When you use external key, DSK cannot be used.

## Compositing Using DSK

By default, channel 8 is set as the source for the DSK. Also, by default, the unit is set to extract black. A white logo or text on black background can be extracted clearly.

\* You can change the DSK source channel or extraction color using the menus (p. 51).

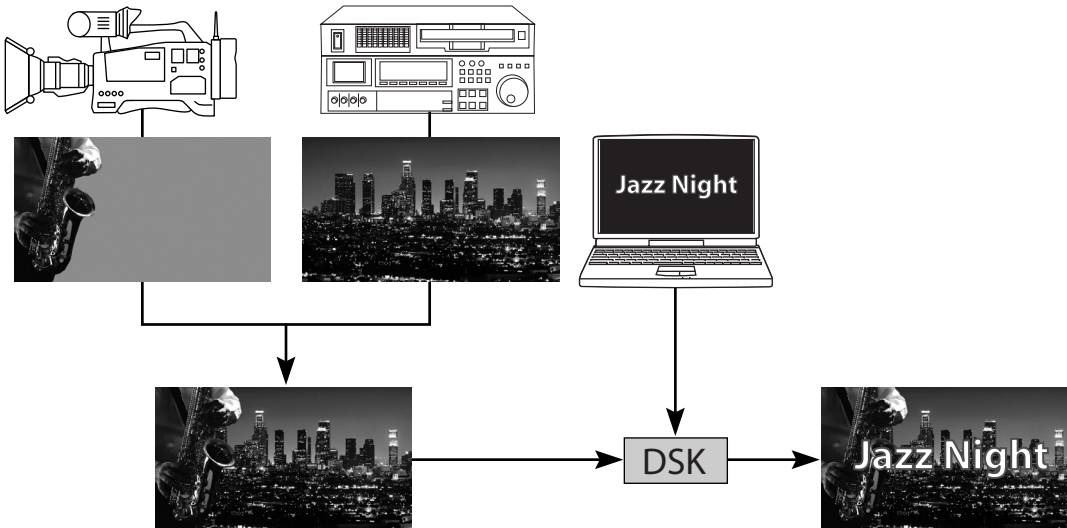

### 1. Check the background video.

On [PVW] section of the multi-view monitor, confirm the video to be the background.

### 2. Preview the result of compositing.

At the DSK section, press the [PVW] button to make it light up. The video overlaid with the logo or text from source channel (by default, channel 8) is displayed in [PVW] section of the multi-view monitor. At this stage, the final output has not yet been changed.

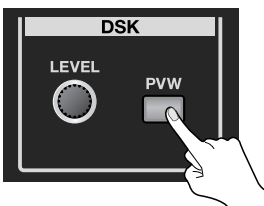

### 3. Adjust the amount of keying and the degree of edge blur.

While viewing the preview, use the [LEVEL] dial in the DSK section to adjust the amount of keying.

\* You can use the menus to change the degree of edge blur. At the DSK menu, adjust the setting for [Gain]. You can also use [Hue] to adjust the extraction color.

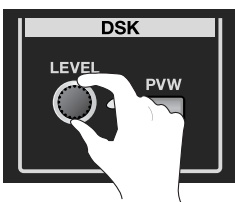

#### 4. Output the composited results.

Press the [DSK] button to output the results of compositing. The logo or text fades in. The fade time depends of your setting of transition time.



#### 5. Switch the background picture.

You can change the background picture while continuing to display a logo or text unchanged. Use the buttons on the [PST/EFFECT] side to select the standby video, then use the [AUTO] or [CUT] button or the video fader to change the background picture.

##### **NOTE**

When you are using external key, DSK cannot be used. When using DSK, be sure to set [Key Mode] to [Self Key].

##### **TIP**

The settings of a compositing operation for a DSK source will be remembered. Just press the DSK button to make the DSK source appear or disappear.



# About Other Features

## Enlarging/Reducing the Picture

Using the [SIZE] dial in the SCALING section, you can enlarge or reduce the view of the picture. You can also use the [POSITION] joystick to change the display position.

\* On the V-800HD, you can enlarge or reduce the picture within a range of 10% to 1,000%.

### Enlarging/Reducing the Source Picture

#### 1. Put the picture you want to enlarge or reduce into standby.

On the [PST/EFFECT] side, select the channel of the picture you want to enlarge or reduce.

#### 2. Enlarge or reduce the picture, and adjust its display position.

At the SCALING section, press the [CONTROL] button to make the [INPUT] indicator light up. The results of the adjustments using the [SIZE] dial and the [POSITION] joystick are shown on [PVW] section of the multi-view monitor.

\* Note, however, that the picture on the source monitor will not be modified.

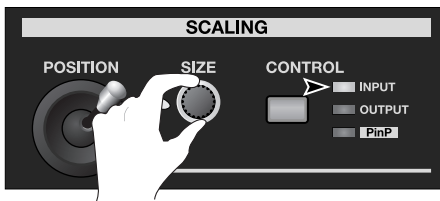

#### 3. Output the enlarged or reduced picture.

Use the [AUTO] or [CUT] button or the video fader to output the picture on standby.

#### MEMO

You can also enlarge or reduce the picture and adjust its display position by changing the values of [Zoom] and [Position] in the Input menu. In the Input menu, you can also change cropping parameters and the aspect ratio for the picture.

### Enlarging/Reducing the Currently Output Picture

At the SCALING section, press the [CONTROL] button to make the [OUTPUT] indicator light up. You can enlarge or reduce the picture by using the [SIZE] dial. You can also use the [POSITION] joystick to change the display position. The results of the adjustments are shown on [PGM] section of the multi-view monitor.

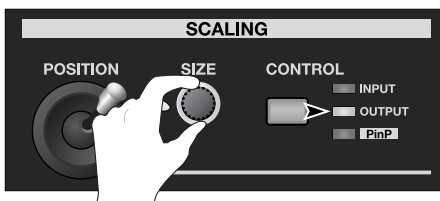

#### MEMO

You can also enlarge or reduce the picture and adjust its display position by changing the values of [Zoom] and [Position] in the Output menu. In the Output menu, you can also enlarge or reduce the vertical/horizontal size of the picture independently.

## Changing the Multi-view Labels

You can change the text strings for channel names and the like displayed on the multi-view monitor. Up to 8 characters of text can be displayed.

### 1. Display the System menu.

Press the [MENU] button to display the menu. Use the [CURSOR] buttons to select [System], then press the [ENTER] button to display the System menu.

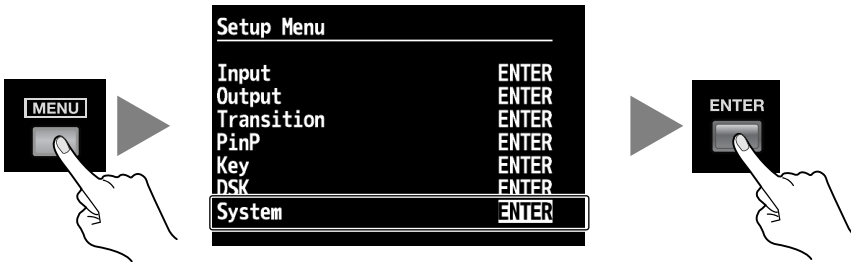

### 2. Select the channel whose text string you want to change.

Use the [CURSOR] buttons to select [Multi-View Label], then press the [ENTER] button. From among either [PGM] and [PWV] or [CH 1] through [CH 8], use the [CURSOR] buttons to select the channel whose text string you want to change. Pressing the [ENTER] button switches the display to the screen for changing the text string.

\* You can also hide the labels by going to the [Multi-View Label] list and setting [Indicate] to [OFF].

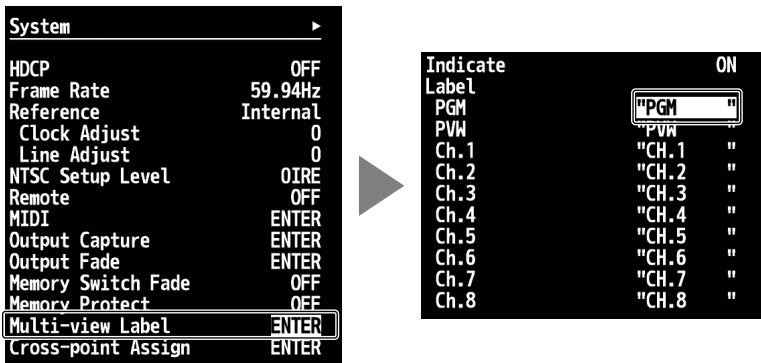

### 3. Change the text string.

Use the [CURSOR] buttons to move the cursor left or right, and turn the [VALUE] dial to change the text string.

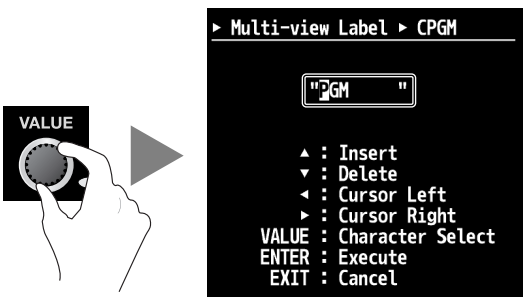

### 4. Exit the menu.

Use the [ENTER] button to finalize the text string, then press the [EXIT] button several times to quit the menu.

#### NOTE

The display on the multi-view monitor is not updated while editing is in progress. The display is updated when you quit the menu.

## Saving Settings to MEMORY Buttons

You can save the current settings to a MEMORY button. The V-800HD's internal memory contains banks from 1 to 8, and up to 8 sets of settings can be saved in each bank, for a total of up to 64.

### NOTE

When [Memory Protect] on the System menu is set to [ON], saving operations is not possible.

### Saving the Current Settings

This saves the current state of the V-800HD.

#### 1. Put the unit in the state you want to save.

Operate the dials and buttons on the panel to put the unit in the state you want to save.

#### 2. Put the unit in standby for saving.

Press the [STORE] button to make the unit in standby for saving. The MEMORY button selected last time flashes at this stage.



#### 3. Select the bank to save to.

Go to the MEMORY section and press the [BANK] button. The button for the currently selected bank lights up. Choose a bank from [1] to [8] to select the destination for saving.

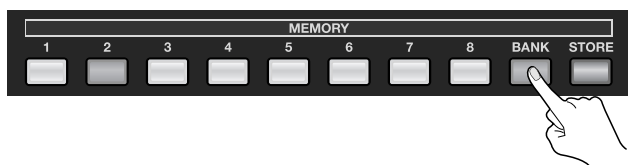

#### 4. Select the number to save to.

Press a button from [1] to [8] to select the destination for saving. Settings are saved at the selected number in the selected bank.

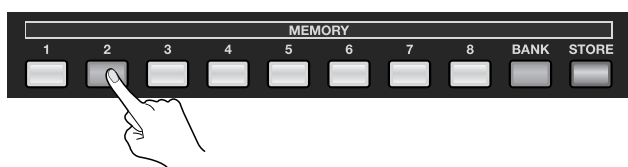

### Recalling Saved Settings

When the V-800HD starts, memory 1 in bank 1 is loaded. You can call up the settings saved at a different bank and memory number by using the [BANK] button to select the bank, then pressing the button for the number you want to call up.

### TIP

Going to the System menu and setting [Memory Switch Fade] to [ON] automatically applies an output fade when saved settings are called up. When recall finishes and the settings have changed, the output fade will be ended.

### NOTE

Settings related to remote control and settings of output-fade cannot be saved individually. Only a single set of settings related to these can be saved. The settings are saved when you quit the menu display.

# Using a USB Memory Device

## Connecting and Formatting a USB Memory Device

Carefully insert the USB memories all the way in-until it is firmly in place.



- \* Open the sliding cover only when you are using the USB port. When this is not in use, be sure to keep the sliding cover closed to protect the connector inside.
- \* Be careful to orient the USB memory device correctly front and back and in the correct direction for insertion, and insert it firmly, as far as it will go. Never insert using undue force.

**NOTE**

Operation has been tested for commonly available USB memory devices, but operation of all USB memory devices is not assured. Depending on the manufacturer and type of the USB memory device, correct operation may not be possible.

Follow the procedure below to format the connected USB memory device. You must format your USB memory device in the V-800HD or it will not be recognized by the unit.

**1. Display the System menu.**

Press the [MENU] button to display the menu. Use the [CURSOR] buttons to select [System], then press the [ENTER] button to display the System menu.

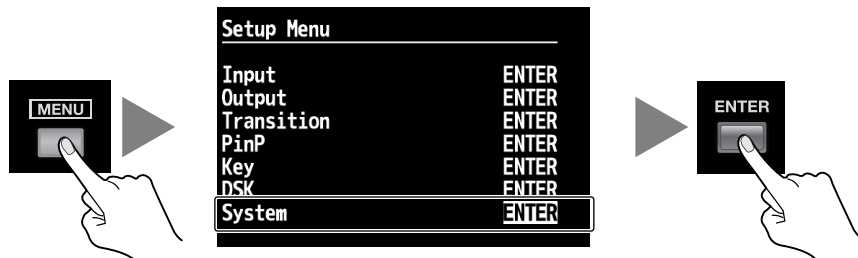

**2. Select the Format menu.**

Use the [CURSOR] buttons to go to [USB Memory] and select [Format], then press the [ENTER] button.

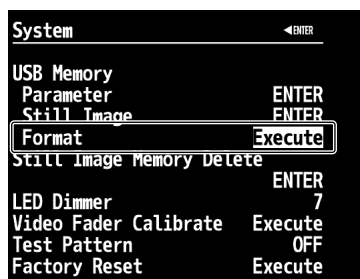

**3. Format the USB memory device.**

Pressing the [ENTER] button in step 2 makes the message [Push ENTER to execute] appear. To execute formatting, press the [ENTER] button.

- \* Formatting will permanently wipe all data on the USB memory device.

**4. Exit the menu.**

Press the [EXIT] button several times to quit the menu.

## Saving Settings on a USB Memory Device

You can copy data saved in the V-800HD's internal memory to a USB memory device formatted on the V-800HD. A batch copy of all data in internal memory from 1-1 to 8-8 is carried out at this time.

### 1. Display the System menu.

Press the [MENU] button to display the menu. Use the [CURSOR] buttons to select [System], then press the [ENTER] button to display the System menu.

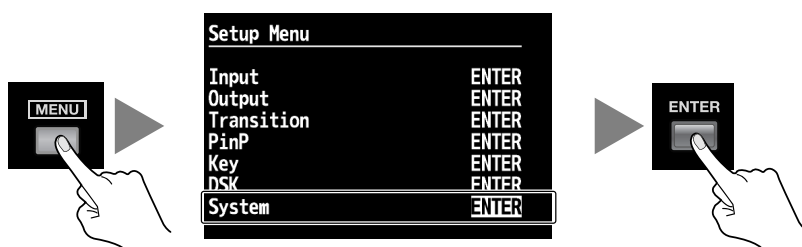

### 2. Select the Save menu.

Use the [CURSOR] buttons to go to [USB Memory] and select [Parameter], then press the [ENTER] button. The display changes to a screen for selecting the operation.

### 3. Select the Save As menu.

Use the [CURSOR] buttons to select [Save As], then press the [ENTER] button. The display changes to a screen for editing the file name.

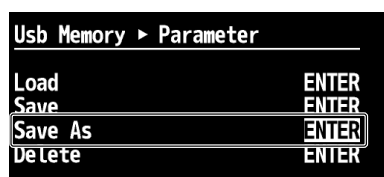

### 4. Edit the file name.

Use the [CURSOR] buttons to move the cursor left or right, and turn the [VALUE] dial to change the text string.

\* The extension of the file name is [V08]. If you have edited the file name on your computer, small letters are displayed after conversion to capitals.

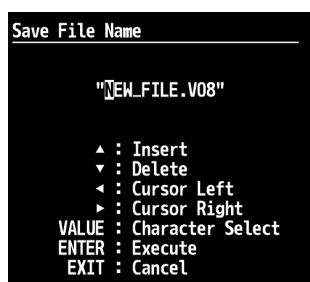

### 5. Save to the USB memory device.

Press the [ENTER] button to finalize the file name. Pressing it displays the message [Push ENTER to execute]. To save, press the [ENTER] button.

### 6. Exit the menu.

Press the [EXIT] button several times to quit the menu.

## Menu Items for Save/Load Operations

At the System menu, the following operation menu items are displayed under [Parameter] in [USB Memory].

- Load This copies setting values saved on a USB memory device to the V-800HD's internal memory. The settings in internal memory are overwritten.
- Save This saves settings by overwriting. Selecting this menu item changes the display to a screen for selecting the file to overwrite.
- Save As This saves a new set of settings.
- Delete This deletes a settings file from the USB memory device. Selecting this menu item changes the display to a screen for selecting the file to delete.

## Using Still-image Files

On the V-800HD, you can use still-image files in the ways described below. To use a still-image file, first import it into the V-800HD's internal memory. Direct output from a USB memory device is not possible.

- You can assign separate still images to channel 9 and channel 10.
- You can save up to 16 still-image files in internal memory. The data remains in memory after the power is turned off.
- You can create and save a still image from output video.

### About the Format and Sizes of Still-image Data

Save still-image data onto a USB memory device. The format and size must be as below. Data in other formats or sizes cannot be imported into the V-800HD.

- Format Bitmap (.bmp), 24 bits/pixel, uncompressed
- Maximum resolution 1920 x 1200

### Assigning Still Images to Channels 9/10

Still images saved on a USB memory device can be assigned to channel 9 or channel 10 on the V-800HD.

#### 1. Save still-image data on a USB memory device.

Save the still-image data in the root directory of a USB memory device formatted on the V-800HD. Use a file name containing no more than eight single-byte alphanumeric characters, and be sure to add the ".bmp" file extension.

#### 2. Display the System menu.

Press the [MENU] button to display the menu. Use the [CURSOR] buttons to select [System], then press the [ENTER] button to display the System menu.

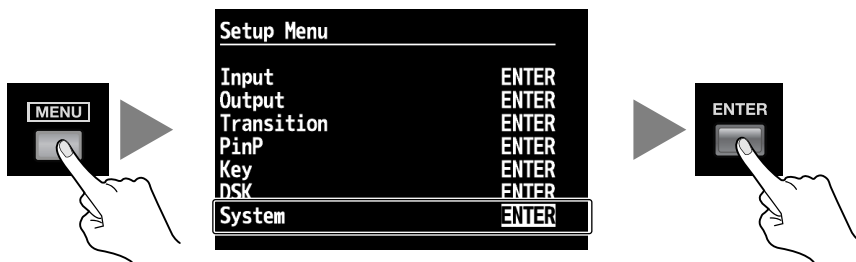

### 3. Display the menu for loading still images.

At [USB Memory], select [Still Image], then press the [ENTER] button.

\* If the target menu is not displayed, press the left or right [CURSOR] button to change the page.

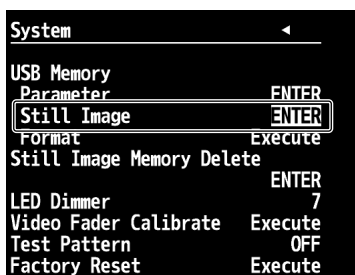

### 4. Select the assignment destination for the still image.

Use [Still Image Memory No.] to select the internal memory number ([1] through [16]) for the assignment destination.

\* A [\*] next to a number indicates that a still image is already assigned to internal memory at that number.

### 5. Display the menu for loading still images.

Use the [CURSOR] buttons to select [Load], then press the [ENTER] button. The display changes to a screen for selecting still images.



### 6. Select the still image to import.

Use the [CURSOR] buttons to select a still-image file, then press the [ENTER] button. The message [Push ENTER to execute] appears. Pressing the [ENTER] button once more copies the selected still-image file from the USB memory device to the V-800HD's internal memory.

### 7. Select the channel for assignment.

Return temporarily to the initial menu screen and select the Input menu. Press the [CURSOR] buttons to select [CH 9] or [CH 10].

\* If the target channel is not displayed, press the left or right [CURSOR] button to change the page.

### 8. Choose the still image to assign to the selected channel.

Check to make sure the source assignment is [Still Image], then press the [ENTER] button. The display changes to a screen to select memory number. Choose the internal memory number you selected in step 3.

\* You can adjust the display position and the color at the same screen.



### 9. Exit the menu.

Press the [EXIT] button several times to quit the menu.

## Deleting Still-image Data from Internal Memory

At the System menu, select [Delete] under [Still Image Memory No.]. Selecting it displays the message [Execute]. You can delete the still-image data from internal memory by pressing the [Enter] button once more.

\* Deleting still-image data from internal memory shortens startup times.

## Creating a Still Image from Final-output Video

You can create a still image from the V-800HD's output video and save it to internal memory (Output Capture).

\* The created still image cannot be saved to a USB memory device.

### 1. Display the System menu.

Press the [MENU] button to display the menu. Use the [CURSOR] buttons to select [System], then press the [ENTER] button to display the System menu.

### 2. Select [Output Capture].

Use the [CURSOR] buttons to select [Output Capture], then press the [ENTER] button to move to the next screen.

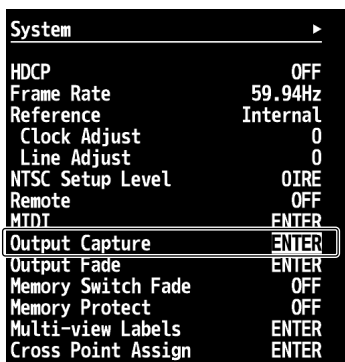

### 3. Select the source.

Use [Source Bus] to select the source video. You can select from among [PGM], [PVW] or [AUX]. Selecting a source makes the video appear at [PGM] section of the multi-view monitor.

### 4. Select the memory of the destination for saving.

Under [Destination], select saving-destination memory number ([1] through [16]) in [Still Image Memory No.].



### 5. Execute creation and saving of the still image.

Use the [CURSOR] buttons to highlight [Execute], then press the [ENTER] button. A still image is created from the video being output and saved at the number specified in step 3.

Using the procedure just described to create a still image lets you assign it to channel 9 or 10. You can also assign it to an output fade (p. 34) in the same way as for still images imported from a USB memory device.



## Changing Cross-Points

You can assign a source channel to any cross-point button ([1] through [10]). You can also cancel the assignments and disable button operations.

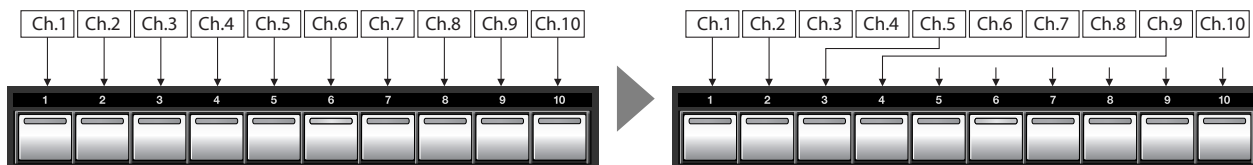

### 1. Display the System menu.

Press the [MENU] button to display the menu. Use the [CURSOR] buttons to select [System], then press the [ENTER] button to display the System menu.

### 2. Display the cross-point setting screen.

Select [Cross-point Assign], then press the [ENTER] button. The channel assignments for the respective cross points are displayed.

### 3. Change the assignments.

Use the [CURSOR] buttons to select a cross-point ([1] to [10]), then turn the [VALUE] dial to change the channel assignment.

```
System > Cross-point Assign
Cross-point      Input
1                Ch.1
2                Ch.2
3                Ch.3
4                Ch.4
5                Ch.5
6                Ch.6
7                Ch.7
8                Ch.8
9                Ch.9
10               Ch.10
```

### 4. Exit the menu.

Press the [EXIT] button several times to quit the menu.

## Returning to the Factory-default State

This returns various settings to their factory defaults. If following the instructions for a procedure results in operation that differs from what is described in the Owner's Manual, execute a factory reset.

\* Executing a factory reset causes all setting values saved up to then to be lost. Please be aware that all settings saved to MEMORY buttons and still images saved in internal memory are also lost.

### 1. Display the System menu.

Press the [MENU] button to display the menu. Use the [CURSOR] buttons to select [System], then press the [ENTER] button to display the System menu.

### 2. Select the Factory Reset menu.

Use the [CURSOR] buttons to select [Factory Reset], then press the [ENTER] button. The message [Push ENTER to execute] appears.

\* If the target menu is not displayed, press the left or right [CURSOR] button to change the page.

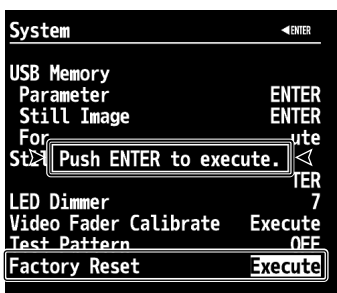

### 3. Execute the factory reset.

Pressing the [ENTER] button executes the factory reset.

### 4. Exit the menu.

Press the [EXIT] button several times to quit the menu.

# Menu Operations

The V-800HD's setting menus are displayed on the multi-view monitor. Menu operations follow the flow described below. For information on the details of menus and their items, download "Reference Manual" from the following Roland website.  
<http://www.rolandsystemsgroup.net/>

## 1. Display the menu.

Press the [MENU] button to display the menu. Displayed initially is the first level, shown below.

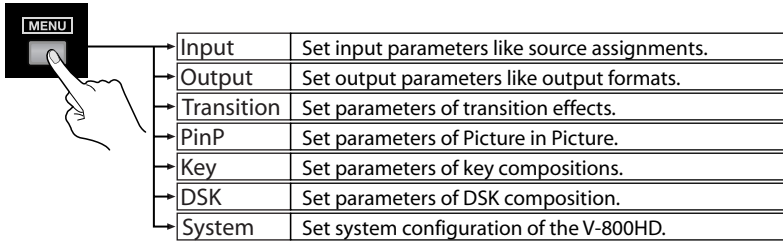

## 2. Select the target menu.

Use the up and down [CURSOR] buttons to select the target menu. After making the selection, press the [ENTER] button to display the items that the menu contains.

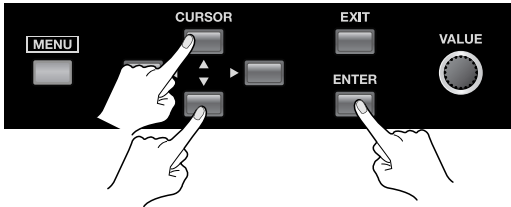

## 3. Select the item whose setting you want to change.

Use the up and down [CURSOR] buttons to select the target item. If the items span two or more pages, triangle symbols are displayed at the top of the screen. When these symbols are displayed, you can use the left and right [CURSOR] buttons to change the page shown. Also, when [ENTER] is displayed at the top of the screen, you can move down one level by pressing the [ENTER] button.

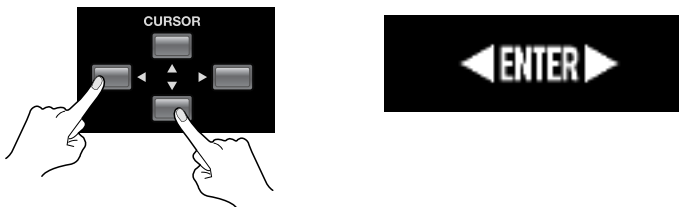

## 4. Change the setting value.

If the displayed setting value is highlighted, you can change the value by turning the [VALUE] dial.

\* You can change a setting value up or down by 10 units at one time by holding down the [ENTER] button and turning the [VALUE] dial. You can also return the setting value to its factory default by holding down the [ENTER] button and pressing the [EXIT] button.

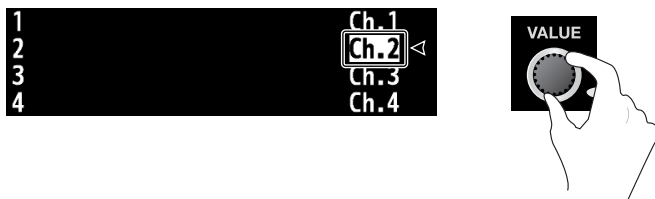

## 5. Exit the menu.

Press the [EXIT] button to quit the menu screen.

### NOTE

The setting value is not stored in internal memory unless it is saved to a [MEMORY] button. Refer to "Saving Settings to MEMORY Buttons" (p. 43) and save the settings before turning off the power.

# Appendices

## Main Specifications

Video Processing		Output Connectors	
Processing		Y:Pb:Pr, 4:4:4, 10 bits	
Supported Formats	Video	480/59.94i, 576/50i, 480/59.94p, 576/50p, 720/59.94p, 720/50p, 1080/59.94i, 1080/50i, 1080/59.94p, 1080/50p	
	RGB	640 x 480 / 60 Hz, 800 x 600 / 60 Hz, 1024 x 768 / 60 Hz, 1280 x 1024 / 60 Hz, 1280 x 1024 / 60 Hz, 1366 x 768 / 60 Hz, 1400 x 1050 / 60Hz (Output refresh rate is 75 Hz when system frame rate is set to 50 Hz) 1600 x 1200 / 60 Hz, 1920 x 1200 / 60 Hz (Reduced Blanking) * Conforms to VESA DMT Version 1.0 Revision 10	
	Still Image	Windows (R) Bitmap File (.bmp) * Maximum 1920 x 1200 pixels, 24 bit per pixel, uncompressed	
Input/Output Level and Impedance		Other Connectors	
Composite		TALLY	
Analog HD/RGB		Remote	
Input Connectors		REFERENCE	
Analog Video	SD	USB port (host)	
	HD	Effects	
Analog RGB		Transition	
SDI (3G/HD/SD)		Composition	
DVI-I/HDMI		Others	
		Others	
		Power Supply	
		Power Consumption	
		Dimensions	
		Weight	
		Accessories	

- \* When Sync Reference is set to [External], the resolution of 800 x 600 and refresh rate of 60 Hz are no longer compliant with the VESA standard. This means that display on some devices may not be possible in this situation.
- \* In the interest of product improvement, the specifications and/or appearance of this unit are subject to change without prior notice.

## Name Plate

A name plate bearing the power consumption, model name, and serial number of this product is attached at the location shown below.

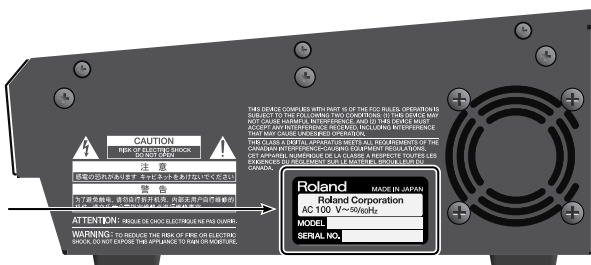

## About Remote Control

The V-800HD supports remote control via MIDI and the RS-232C interface, enabling you to operate the unit remotely from an external device. When performing remote control, download “Remote Control Guide” from the following Roland website.  
<http://www.rolandsystemsgroup.net/>



The V-800HD can be operated remotely from a device that supports MIDI Visual Control. MIDI Visual Control is a feature that uses MIDI to link visual expression to a musical performance.

## About Rack Mounting

### About Rack-mount Angles

When using the unit installed with the rack-mount angles, remove the screws at the locations shown in the figure below (at 3 locations on each side, for a total of 6) at first and install the angles with original screws.

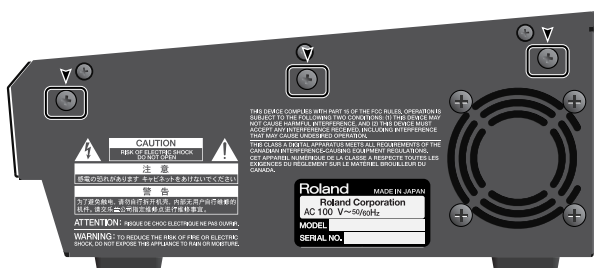

**NOTE**

When installing or detaching the rack-mount angles, give attention to the following precautions.

- Before removing any screws, turn off the power to the V-800HD and detach the power cord and all connection cables.
- Be sure to block the screw holes with the removed screws.
- Never use any screws except the removed ones to block the screw holes. Using other screws may cause malfunction.
- When installing the rack-mount angles, turn off the power to the V-800HD and detach the power cord and all connection cables. Also, be sure to install using the original screws.

### Mounting in a 19-inch Rack

**NOTE**

When mounting the unit in a rack, observe the following precautions.

- The video fader protrudes beyond the mounting surface of the rack. Take care not to damage it when mounting the unit.
- To prevent incorrect operation or malfunction, take care not to subject areas protruding beyond the rack to accidental impact.
- To ensure room for connectors and cables as well as space around the ventilation ports, ensure 2U of clearance above the unit.
- Before mounting, turn off the power to the V-800HD and detach the power cord and all connection cable.
- Use all threaded holes (at 4 locations on each side, for a total of 8) to secure the unit to the rack using screws. (Screws for rack-mounting are not included.)
- When mounting the unit in the rack, use due caution to ensure that your fingers do not get caught or pinched between a rack-mount angle and the rack.

## About the Input Template

The included input template indicates the factory-default correspondences between cross-points and input channels. Use it attached at the location shown below.

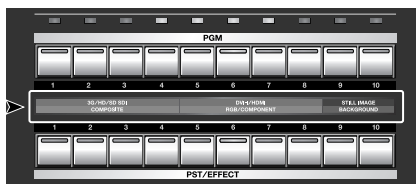

## Troubleshooting

### **Nothing is displayed on the multi-view monitor.**

Does the connected monitor support a resolution and refresh rate of 1920 x 1080/60 Hz (progressive)? Nothing is displayed if the monitor is not compatible. Also, nothing is displayed if the monitor does not support HDCP signals.

### **Composite input is not output.**

Is the source at the connected channel set to composite? In the factory-default state, SDI input is assigned to channels 1 through 4. The assignment must be changed to composite input (p. 21).

### **Analog RGB input is not output.**

Is the source at the connected channel set to analog RGB? In the factory-default state, DVI/HDMI input is assigned to channels 5 through 8. The assignment must be changed to analog RGB input (p. 23).

\* The same operation is also necessary when using a conversion cable to make an analog component connection.

### **DVI input is not output.**

Is the switch at the connector set to the correct position ([DVI-A] or [DVI-D])? The signal cannot be detected if this is not set correctly.

### **Nothing is output from the SD OUT connector, SDI OUT connectors, or RGB/COMPONENT OUT connector.**

Has the setting for inputting HDCP signals been made? When [HDCP] at the System menu is set to [ON], output from the SD OUT connector, SDI OUT connectors, and RGB/COMPONENT OUT connector stops.

\* Note, however, that output from the DVI-D/HDMI OUT connectors and output to the multi-view monitor continues.

### **No still image can be assigned to an output fade.**

Is the still image assigned to channel 10? A still image cannot be assigned to channel 10 and output fade at the same time. When assigning a still image to an output fade, change the channel-10 assignment to a color background.

### **Compositing with DSK is not possible.**

Is External Key (p. 38) on? When using DSK, set this to off. Select [M ode] in Key menu and turn it to [Self key].

### **A USB memory device cannot be used.**

Has the USB memory device been formatted on the V-800HD? A USB memory device that has not been formatted on this product cannot be used. Also, operation has been tested for commonly available USB memory devices, but operation of all USB memory devices is not assured. Depending on the manufacturer and type of the USB memory device, correct operation may not be possible.

### **Still-image data cannot be imported.**

Is the data of a format and size that the V-800HD can recognize (p. 46)? Also, data cannot be recognized unless the file name contains no more than eight single-byte alphanumeric characters and the file extension (.bmp) is present.

### **Switching is not complete even when the video fader is moved.**

Perform calibration of the video fader. Move the video fader all the way and calibrate .T execute calibration, select [Video Fader Calibrate] in System menu.

### **Startup takes a long time.**

Startup takes longer when still images have been loaded into internal memory. Delete still image data from internal memory (p. 47).

### **The panel indicators are too bright/dark.**

Carry out dimmer adjustment. At the System menu, raise or lower the value of the [LED Dimmer] value. Even if you raise/lower this value, the brightness of the LEDs around [VALUE] dial etc. will be unchanged.

# Dimensions

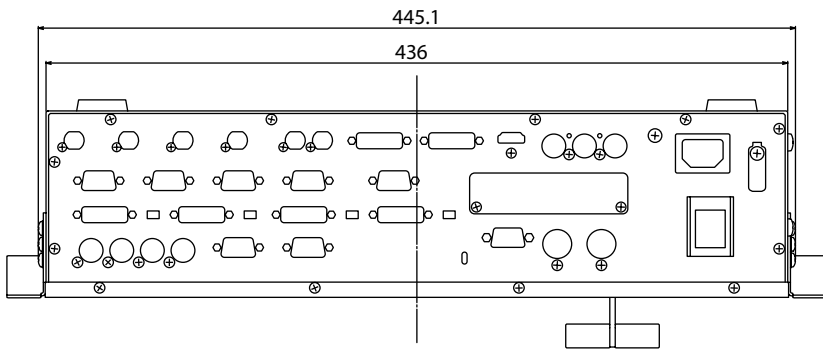

Unit : mm

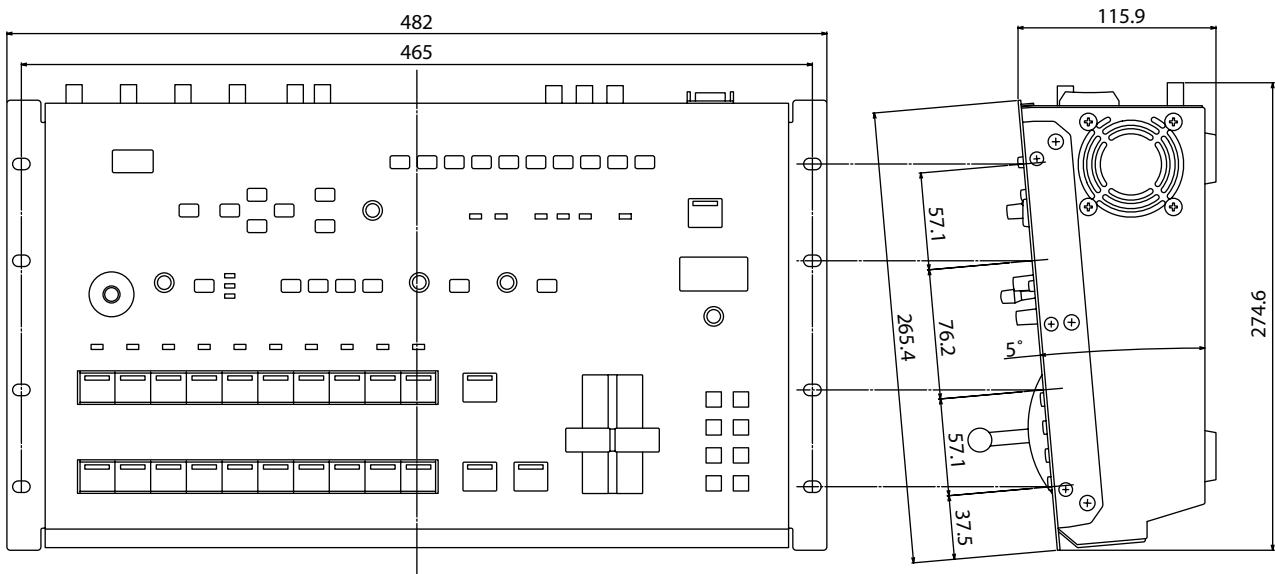

# V-800HD Version 1.50 Added Functions

The following features were added to V-800HD version 1.50.

For information about version 1.50 software, download from the following Roland website.

<http://www.rolandsystemsgroup.net/>

## **Supports 3G-SDI Level B Mapping Structure**

- The V-800HD ver. 1.5 supports level B mapping structure of 3G-SDI (1080p50Hz, 1080p59.94Hz).
- The 3G-SDI mapping structure of the input signal is detected automatically.
- The mapping structure of 3G-SDI output signal can be selected using the menu.

Menu Items	Setting Value
Output -> Format Main -> 3G-SDI Mapping	Level A, Level B

## **Sync with Input Video Signal**

- The V-800HD ver. 1.50 can synchronize with SDI input as reference.
- You can select a reference SDI input.

Menu Items	Setting Value
System -> Reference	Internal, External, Input SDI 1, ... Input SDI 4

- The output vsync of the V-800HD synchronizes with the input signal when the value of System -> Reference is Input SDI 1, ... Input SDI 4. In this case, the system latency is minimized. If you want to synchronize the input/output fields, execute the settings below.

Turn the Field Sync Processing of System to ON	Although the processing time increases, the input/output fields match automatically.
Adjust the value of Reference Line Adjust in System	Although the input/output phases differ, you can minimize the latency keeping the synchronization of input/output fields.

## **Field Sync Processing**

- While the V-800HD input/output interlaced signals, synchronization of fields is possible.

Menu Items	Setting Value	Explanation
System -> Field Sync Processing	ON	Enables the field sync processing. The fields of input/output match and this improves the image quality. However, the processing time increases.
	OFF	

## **A/B Mode Switching**

- You can select A/B mode for video switching.

Menu Items	Setting Value
System -> Panel Operation	PGM/PST, A/B

- PGM/PST is the default mode.
- Regardless to the PGM section or PST/EFFECT section of cross-points, PGM is determined by the video fader position. The indicator of the PGM output channel lights in red. The indicator of the PST output channel lights in green.
- While you are compositing images, the indicator of background channel lights in red. The indicator of foreground channel lights in green.



## **AUX Output of the Input Signal**

- You can directly send the input channel signal to the AUX bus. However, you cannot use DSK while you are selecting input signal
- Use menu to select the channel to be sent to AUX bus.

Menu Items	Setting Value
Output -> AUX Source	Mixer Input, Mixer Output, DSK Source, DSK Output, Input CH.1, ... Input CH.10

## **Selection of the Recalling Parameter**

- You can select the parameters to recall when you operate the MEMORY buttons.

Menu Items	Setting Value	Explanation
System -> Memory Recall Parameters	ALL	This recalls all the parameters (same as previous version)
	Cross-point	This recalls the parameters below only. - Channel selection - Key setup - PinP setup - DSK setup - Wipe setup - Input connector selection

## **Automatic Memory Save**

- If this is turned on, the current status of the V-800HD is saved to memory 1-1 automatically. The status is loaded at next booting and the status returns.

Menu Items	Setting Value
System -> Auto Memory	ON, OFF

- The auto saving is carried out when you operate any menu cursor. Auto saving does not work when cross-point buttons or video fader is operated.

## **Expanded Color Correction Range**

- The range of color correction is expanded.

Menu Items	Setting Value
Output -> Format Main -> Color Correction	
Brightness	-128 - +127
Contrast	-128 - +127
Saturation	-128 - +127

## **Fine Adjustment of Chroma Key HUE**

- The extraction color was fixed to blue or green in previous version. Now it's possible to fine adjust the color.

Menu Items	Setting Value
Key -> Hue	
Fine	-128 - +127
Width	-128 - +127

- Width is same as Hue adjustment of previous version.

### **Supports Multi-view monitor not compatible with HDCP**

- As the multi-view monitor, now you can connect HDCP non-compatible product.
- However, of HDCP of the V-800HD is turned on, the multi-view screen is filled with plain blue. It can display the menu screen only.

### **Version Number Display**

- You can check the version number in System menu of the V-800HD.

**NOTE**

The memory saved settings is not compatible with the previous version. At the first booting after update, factory reset is executed automatically.



<b>A</b>	
AUTO .....	15
<b>C</b>	
chroma key .....	37
Clock Source .....	24
Component .....	19, 22
Composite .....	19–20
Compositing .....	14, 35
cord hook .....	12
Cross-Points .....	14, 49
CUT .....	15
<b>D</b>	
DSK .....	15, 39
DVI .....	19, 22
<b>E</b>	
External Key .....	38
<b>F</b>	
Factory Reset .....	50
Final Output .....	34
Freeze .....	34
<b>H</b>	
HDCP .....	29
HDMI .....	19, 22
<b>I</b>	
INPUT STATUS .....	14
<b>L</b>	
Labels .....	42
luminance key .....	37
<b>M</b>	
Main Output .....	27
MEMORY .....	15, 43
Menu .....	51
menu .....	10
MIDI .....	16
Multi-view Monitor .....	9
<b>O</b>	
OUTPUT FADE .....	15, 34
<b>P</b>	
PGM Section .....	9
Picture-in-Picture .....	35
PVW Section .....	9
<b>R</b>	
REFERENCE .....	17
RGB .....	22
RS-232C .....	16
<b>S</b>	
Scaling .....	14
SDI .....	19–20
Setup .....	14
Sharing .....	24
Source Monitors .....	9
Still-image .....	46
<b>T</b>	
TALLY .....	16
Tally .....	25
TRANSITION .....	15
Transition Effects .....	31
<b>U</b>	
USB .....	14, 44
<b>V</b>	
Video Fader .....	15
<b>W</b>	
WIPE PATTERN .....	15

For EU Countries



This product complies with the requirements of EMCD 2004/108/EC and LVD 2006/95/EC.

For the USA

### FEDERAL COMMUNICATIONS COMMISSION RADIO FREQUENCY INTERFERENCE STATEMENT

This equipment has been tested and found to comply with the limits for a Class A digital device, pursuant to Part 15 of the FCC Rules. These limits are designed to provide reasonable protection against harmful interference when the equipment is operated in a commercial environment. This equipment generates, uses, and can radiate radio frequency energy and, if not installed and used in accordance with the instruction manual, may cause harmful interference to radio communications. Operation of this equipment in a residential area is likely to cause harmful interference in which case the user will be required to correct the interference at his own expense.

This device complies with Part 15 of the FCC Rules. Operation is subject to the following two conditions:

- (1) this device may not cause harmful interference, and
- (2) this device must accept any interference received, including interference that may cause undesired operation.

To assure continued FCC emission limit compliance, use only shielded interface cables when connecting to other device. Any unauthorized changes or modifications not expressly approved by the party responsible for compliance could void the user's authority to operate the equipment.

For Canada

### NOTICE

This Class A digital apparatus meets all requirements of the Canadian Interference-Causing Equipment Regulations.

### AVIS

Cet appareil numérique de la classe A respecte toutes les exigences du Règlement sur le matériel brouilleur du Canada.

For C.A. US (Proposition 65)

### WARNING

This product contains chemicals known to cause cancer, birth defects and other reproductive harm, including lead.

For China

## 有关产品中所含有害物质的说明

本资料就本公司产品中所含的特定有害物质及其安全性予以说明。

本资料适用于 2007 年 3 月 1 日以后本公司所制造的产品。

### 环保使用期限



此标志适用于在中国国内销售的电子信息产品，表示环保使用期限的年数。所谓环保使用期限是指在自制造日起的规定的期限内，产品中所含的有害物质不致引起环境污染，不会对人身、财产造成严重的不良影响。环保使用期限仅在遵照产品使用说明书，正确使用产品的条件下才有效。不当的使用，将会导致有害物质泄漏的危险。

### 产品中有毒有害物质或元素的名称及含量

部件名称	有毒有害物质或元素					
	铅(Pb)	汞(Hg)	镉(Cd)	六价铬(Cr(VI))	多溴联苯(PBB)	多溴二苯醚(PBDE)
外壳(壳体)	×	○	○	○	○	○
电子部件(印刷电路板等)	×	○	×	○	○	○
附件(电源线、交流适配器等)	×	○	○	○	○	○

○：表示该有毒有害物质在该部件所有均质材料中的含量均在 SJ/T11363-2006 标准规定的限量要求以下。

×：表示该有毒有害物质至少在该部件的某一均质材料中的含量超出 SJ/T11363-2006 标准规定的限量要求。

因根据现有的技术水平，还没有什么物质能够代替它。

**For EU Countries**



- UK** This symbol indicates that in EU countries, this product must be collected separately from household waste, as defined in each region. Products bearing this symbol must not be discarded together with household waste.
- DE** Dieses Symbol bedeutet, dass dieses Produkt in EU-Ländern getrennt vom Hausmüll gesammelt werden muss gemäß den regionalen Bestimmungen. Mit diesem Symbol gekennzeichnete Produkte dürfen nicht zusammen mit dem Hausmüll entsorgt werden.
- FR** Ce symbole indique que dans les pays de l'Union européenne, ce produit doit être collecté séparément des ordures ménagères selon les directives en vigueur dans chacun de ces pays. Les produits portant ce symbole ne doivent pas être mis au rebut avec les ordures ménagères.
- IT** Questo simbolo indica che nei paesi della Comunità europea questo prodotto deve essere smaltito separatamente dai normali rifiuti domestici, secondo la legislazione in vigore in ciascun paese. I prodotti che riportano questo simbolo non devono essere smaltiti insieme ai rifiuti domestici.  
Ai sensi dell'art. 13 del D.Lgs. 25 luglio 2005 n. 151.
- ES** Este símbolo indica que en los países de la Unión Europea este producto debe recogerse aparte de los residuos domésticos, tal como esté regulado en cada zona. Los productos con este símbolo no se deben depositar con los residuos domésticos.
- PT** Este símbolo indica que nos países da UE, a recolha deste produto deverá ser feita separadamente do lixo doméstico, de acordo com os regulamentos de cada região. Os produtos que apresentem este símbolo não deverão ser eliminados juntamente com o lixo doméstico.
- NL** Dit symbool geeft aan dat in landen van de EU dit product gescheiden van huishoudelijk afval moet worden aangeboden, zoals bepaald per gemeente of regio. Producten die van dit symbool zijn voorzien, mogen niet samen met huishoudelijk afval worden verwijderd.
- DK** Dette symbol angiver, at i EU-lande skal dette produkt opsamles adskilt fra husholdningsaffald, som defineret i hver enkelt region. Produkter med dette symbol må ikke smides ud sammen med husholdningsaffald.
- NO** Dette symbolet indikerer at produktet må behandles som spesialavfall i EU-land, iht. til retningslinjer for den enkelte regionen, og ikke kastes sammen med vanlig husholdningsavfall. Produkter som er merket med dette symbolet, må ikke kastes sammen med vanlig husholdningsavfall.
- SE** Symbolen anger att i EU-länder måste den här produkten kasseras separat från hushållsavfall, i enlighet med varje regions bestämmelser. Produkter med den här symbolen får inte kasseras tillsammans med hushållsavfall.
- FI** Tämä merkintä ilmaisee, että tuote on EU-maissa kerättävä erillään kotitalousjätteistä kunkin alueen voimassa olevien määräysten mukaisesti. Tällä merkinnällä varustettuja tuotteita ei saa hävittää kotitalousjätteiden mukana.
- HU** Ez a szimbólum azt jelenti, hogy az Európai Unióban ezt a terméket a háztartási hulladéktól elkülönítve, az adott régióban érvényes szabályozás szerint kell gyűjteni. Az ezzel a szimbóllal ellátott termékeket nem szabad a háztartási hulladék közé dobni.
- PL** Symbol oznacza, że zgodnie z regulacjami w odpowiednim regionie, w krajach UE produktu nie należy wyrzucać z odpadami domowymi. Produktów opatrzonych tym symbolem nie można utylizować razem z odpadami domowymi.
- CZ** Tento symbol udává, že v zemích EU musí být tento výrobek sbírán odděleně od domácího odpadu, jak je určeno pro každý region. Výrobky nesoucí tento symbol se nesmí vyhazovat spolu s domácím odpadem.
- SK** Tento symbol vyjadruje, že v krajinách EÚ sa musí zber tohto produktu vykonávať oddelene od domového odpadu, podľa nariadení platných v konkrétnej krajine. Produkty s týmto symbolom sa nesmú vyhazovať spolu s domovým odpadom.
- EE** See sümbol näitab, et EL-i maades tuleb see toode olemprügist eraldi koguda, nii nagu on igas piirkonnas määratletud. Selle sümboliga märgitud tooteid ei tohi ära visata koos olmeprügiga.
- LT** Šis simbolis rodo, kad ES šalyse šis produktas turi būti surenkamas atskirai nuo buitinių atliekų, kaip nustatyta kiekviename regione. Šiuo simboliu paženklinėti produktai neturi būti išmetami kartu su buitiniems atliekomis.
- LV** Šis simbols norāda, ka ES valstīs šo produktu jāievāc atsevišķi no mājsaimniecības atkritumiem, kā noteikts katrā reģionā. Produkts ar šo simbolu nedrīkst izmest kopā ar mājsaimniecības atkritumiem.
- SI** Ta simbol označuje, da je treba proizvod v državah EU zbirati ločeno od gospodinjskih odpadkov, tako kot je določeno v vsaki regiji. Proizvoda s tem znakom ni dovoljeno odlagati skupaj z gospodinjskimi odpadki.
- GR** Το σύμβολο αυτό υποδηλώνει ότι στις χώρες της Ε.Ε. το συγκεκριμένο προϊόν πρέπει να συλλέγεται χωριστά από τα υπόλοιπα οικιακά απορρίμματα, σύμφωνα με όσα προβλέπονται σε κάθε περιοχή. Τα προϊόντα που φέρουν το συγκεκριμένο σύμβολο δεν πρέπει να απορρίπτονται μαζί με τα οικιακά απορρίμματα.

**For EU Countries**



This product is intended for use in the following Electromagnetic environments:  
E1: residential, E2: commercial and light industrial, E3: urban outdoors, E4: controlled EMC environment, ex. recording studio (broadcasting studio) which are specified in EN55103-1 and EN55103-2.





\* 5 1 0 0 0 2 9 1 0 1 - 0 3 \*