

LA8 Amplified Controller

user manual

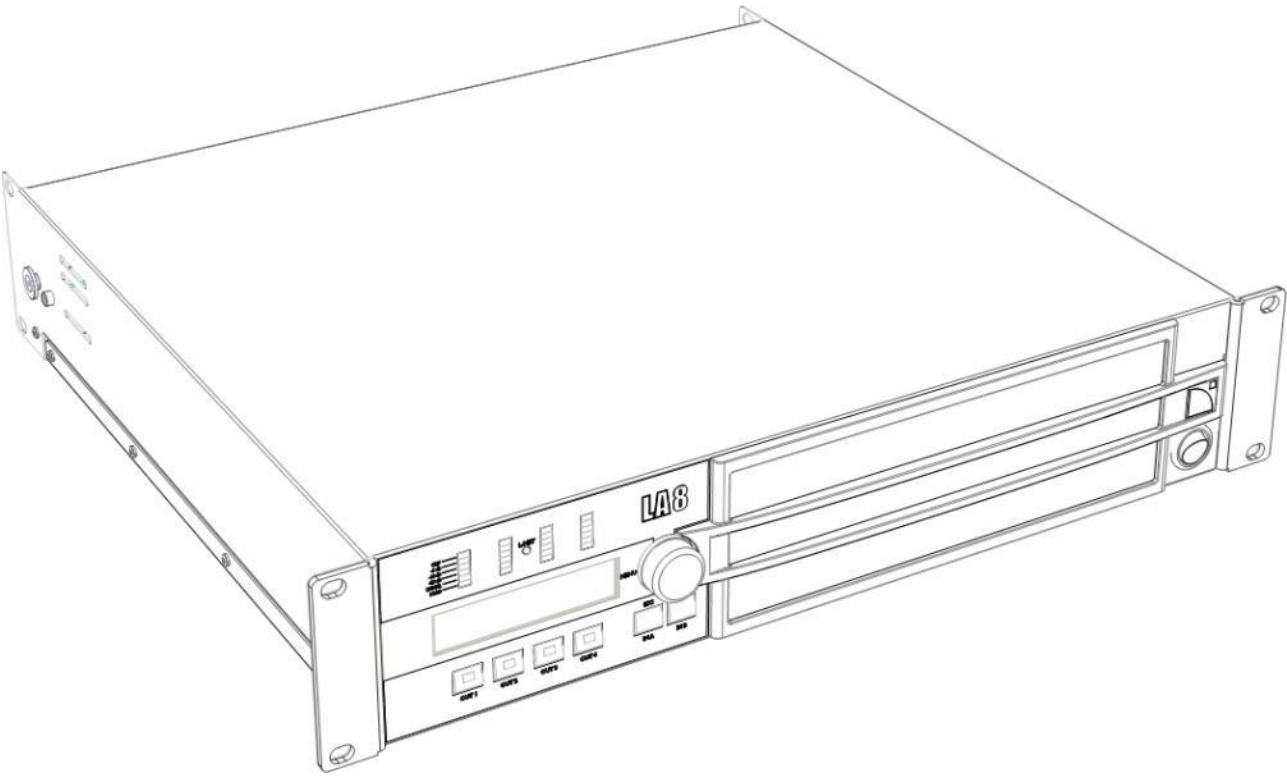

version 12.0



LA8 Amplified Controller user manual

version 12.0

SAFETY INSTRUCTIONS

1. Read this manual

2. Follow all SAFETY INSTRUCTIONS as well as DANGER and OBLIGATION warnings

3. Never incorporate equipment or accessories not approved by L-Acoustics®

4. Read all the related PRODUCT INFORMATION documents before exploiting the system

The product information document is included in the shipping carton of the related system component.

5. Environments

Use the product only in E1, E2, E3, or E4 environments according to EN55103-2 standard.

6. Radio interference

A sample of this product has been tested and complies with the limits for the EMC (Electro Magnetic Compatibility) directive. These limits are designed to provide reasonable protection against harmful interference from electrical equipment. However, there is no guarantee that interference will not occur in a particular installation.

7. Power cord caution

Do not use the product if the power cord is broken or frayed.

Protect the power cord from being walked upon or pinched - particularly at the plugs and the point where the power cord exits from the apparatus.

8. Mains supply

Only connect the LA8 (CE type) or LA8US (US type) to an AC power outlet rated 230 V, 16 A, 50-60 Hz or 120 V, 30 A, 50-60 Hz.

Only connect the LA8JP (Japan model) to an AC power outlet rated 100 V, 30 A, 50 - 60 Hz or 200 V, 15 A, 50-60 Hz.

9. Three-phase circuit

Verify that each phase works, in particular the neutral one.

Balance the loads between the three phases.

Never try to reproduce a 230 V circuit connecting an LA8 or an LA8US to two live wires of a 120 V three-phase circuit.

Never try to reproduce a 200 V circuit connecting an LA8JP to two live wires of a 100 V three-phase circuit.

10. Electrical generator

You must power on the generator before powering on the amplified controllers.

Verify that the amplified controllers are turned off before powering on the generator.

11. Thermal circuit breaker

Always interconnect a thermal circuit breaker between the product and the mains.

The circuit breaker current rating depends on the mains voltage rating as follows:

16 A for 230 V or 30 A for 120 V (LA8 or LA8US), 15 A for 200 V or 30 A for 100 V (LA8JP).

12. Grounding

To plug the controller to mains only use an outlet fitted with a pin tied to ground.

Do not defeat the ground pin of the outlet as it connects the controller to earth. If the local outlet is obsolete, consult an electrician.

The product is fitted with a grounding-type plug. Do not defeat the ground wire connecting the plug's female contact to the product's chassis.

13. Plug replacement

If the AC plug on the power supply cord of this product does not match the local outlet, it must be replaced by an appropriate one. This operation should only be performed by qualified service personnel. Verify that the cut-off plug is withdrawn from use, as it can cause severe electrical shock if connected to an AC outlet.

14. Lightning storm

During lightning storms, disconnect the product from the mains. Switching the product off does not disconnect it from the mains. To do this, remove the plug from the mains outlet.

15. Interconnections

When connecting the product to other equipment, mute all output channels. Carefully read the user manual of the other equipment and follow the instructions when making the connections. Do not connect a speaker output in parallel or series with any other amplifier output. Do not connect the speaker outputs to any other voltage source, such as a battery, mains source, or power supply, regardless of whether the product is turned on or off.

16. Over power risks

The product is very powerful and can be potentially dangerous to both loudspeakers and humans alike. Even reducing the gain it is still possible to reach very high output power if the input signal level is high enough.

17. Operating temperature

The product operates at a room temperature between 0 °C and +50 °C.

18. Ventilation

Openings in the product chassis are for ventilation. They prevent the product from overheating and thus ensure reliable operation. These openings must not be blocked or covered. The product must be installed in accordance with the instructions given in this manual.

19. Heat

Do not operate the product near any heat source, such as radiators or other devices.

20. Water and moisture

To prevent fire or shock hazard, do not expose the product to rain or moisture. Do not use the product near water. Do not operate the product while wet.

21. Interference with external objects and/or liquids

Never push objects of any kind into the product through openings as they may touch dangerous voltage points or short out parts that could result in a fire or electric shock. Never spill liquid of any kind on the product.

22. Cleaning

Unplug the product from the mains before cleaning. Do not use liquid or aerosol cleaners. Clean only with dry cloth.

23. Mounting instructions



Do not place the product on an unstable cart, stand, tripod, bracket, or table. The product may fall and be seriously damaged, and may cause serious human injury.

Any mounting of the product should follow the manufacturer's instructions given in this manual, and should use accessories recommended by the manufacturer.

LA8 Amplified Controller user manual

version 12.0

24. Conditions which require immediate service

Refer all servicing to qualified service personnel.

Servicing is required when the product has been damaged in any way such as:

- Power supply cord or plug is damaged,
- Liquid has been spilled or an object has fallen into the product,
- The product has been exposed to rain or moisture,
- The product was dropped or the housing is damaged,
- The product does not operate normally.

25. Servicing and replacement parts

Do not attempt to service this product as removing covers may expose to dangerous voltage or other hazards.

The use of unauthorized replacement parts may result in injury and/or damage through fire, electric shock, or other electricity-related hazards.

All service and repair work must be carried out by an L-Acoustics® authorized dealer.

26. Shipping

Use the original packaging for shipping the product, unless it is mounted in a rack with the front and rear panels fixed to the rack, as described in this manual.

SYMBOLS INDICATED ON THE PRODUCT



The product is potentially life threatening if open.
Never attempt to remove the back cover.

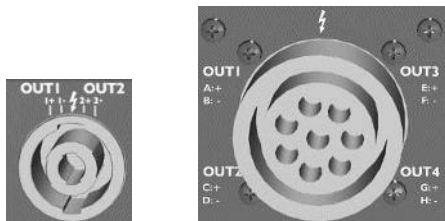

The lightning flashes symbols next to the SpeakON® and CA-COM® connectors indicate that the product can generate high output voltages that are potentially life threatening.

Always use ready-made leads to connect the product to speakers. Never touch any exposed speaker wires while the product is operating without first disconnecting the wires from the product.

SYMBOLS

The following symbols are used in this document:



DANGER

This symbol indicates a potential risk of harm to an individual or damage to the product. It can also notify the user about instructions that must be strictly followed to ensure safe installation or operation of the product.



ELECTRICAL HAZARD

This symbol indicates a potential risk of electrical injury. It can also notify the user about instructions that must be strictly followed to ensure safe installation or operation of the product.



OBLIGATION

This symbol notifies the user about instructions that must be strictly followed to ensure proper installation or operation of the product.



EQUIPMENT

This symbol indicates the equipment, tools, and spare parts required to perform a procedure.



INFORMATION

This symbol notifies the user about complementary information or optional instructions.

WELCOME TO L-ACOUSTICS®

Thank you for choosing the L-Acoustics® **LA8** amplified controller.

This document contains essential information on using the product properly. Carefully read this document in order to become familiar with the product.

As part of a continuous evolution of techniques and standards, L-Acoustics® reserves the right to change the specifications of its products and the content of its document without prior notice.

Please check the L-Acoustics® web site on a regular basis to download the latest document and software updates: l-acoustics.com.

LA8 Amplified Controller user manual

version 12.0

CONTENTS

1	PRESENTATION	8
2	SYSTEM COMPONENTS	9
2.1	Powering and driving system	9
2.2	Loudspeaker enclosures and cables	9
2.3	Rigging element	9
2.4	Software application	10
3	LA8 AMPLIFIED CONTROLLER	11
3.1	Main features	11
3.1.1	Front and rear panels	11
3.1.2	Simplified block diagram	12
3.2	Signal processing and amplification	12
3.2.1	Analog input	12
3.2.2	AES/EBU digital input	13
3.2.3	DSP architecture	14
3.2.4	Amplifier section and power supply	15
3.2.5	Speaker output	15
3.3	Monitoring and control	15
3.3.1	User interface	15
3.3.2	L-NET and remote control network	15
4	INSTALLATION	16
4.1	Mounting	16
4.2	Cooling	17
4.3	Connecting to AC mains	17
4.3.1	AC mains specifications	17
4.3.2	Three-phase circuit	17
4.3.3	Circuit breaker	17
4.3.4	Electrical generator	18
4.3.5	Power plug	18
4.3.6	Power consumption	18
4.3.7	Example of heat calculation	19
4.4	Audio and network cabling	19
4.4.1	Connection panels	19
4.4.2	Analog audio cabling	20
4.4.3	AES/EBU digital audio cabling	21
4.4.4	Loudspeaker cabling	23
4.4.5	L-NET cabling	25



5	OPERATION	26
5.1	Powering on, powering off, standby mode	26
5.2	Display	27
5.2.1	Main screen	27
5.2.2	LED meters	28
5.2.3	L-NET LED	28
5.3	User interface	29
5.3.1	Quick access	29
5.3.2	Main menu	32
5.3.3	Access rights, PIN code	33
5.4	LOAD PST	35
5.5	STORE PRESET	36
5.6	DELETE PRESET	37
5.7	PRESET PARAMETERS	38
5.8	CLEAR GRP PARAMS	40
5.9	INPUT SETTINGS	41
5.9.1	INPUT MODE	41
5.9.2	FALLBACK MODE	43
5.9.3	AES/EBU GAIN	44
5.10	MONITORING & INFO	45
5.10.1	SPK HANDLING (%)	45
5.10.2	OUT CH TEMP (%)	45
5.10.3	FIRMWARE	46
5.10.4	PRESET LIBRARY	46
5.10.5	MAC ADDRESS	46
5.11	OPTIONS	47
5.11.1	NETWORK ADDRESS	48
5.11.2	DELAY UNIT	49
5.11.3	SCREEN CONTRAST	49
5.11.4	RESET TO FACTORY DEFAULT SETTINGS?	49
	APPENDIX A: PROTECTION SYSTEMS	50
	APPENDIX B: APPROVALS	53
	APPENDIX C: SPECIFICATIONS	54

LA8 Amplified Controller

user manual

version 12.0

1 PRESENTATION

At the heart of the L-Acoustics® integrated system approach, the LA4 and LA8 amplified controllers offer cutting edge loudspeaker amplification, DSP, network control, and comprehensive system protection in a single ergonomic package.

Based on similar platforms, the exceptional and ground-breaking performance level delivered by the LA4 and LA8 units allow full optimization of the resources of all L-Acoustics® systems and deliver outstanding audio quality combined with the best possible transducer protection.

The LA4 and LA8 share the following characteristics:

- A 2U lightweight format for high amplified density.
- A four-channel high efficiency amplifier section fed by two inputs.
- A DSP section featuring advanced filter algorithms and an exclusive L-DRIVE protection system for the transducers allowing optimum system performance.
- An on-board preset library to cover all the principal L-Acoustics® loudspeaker system configurations.
- An intuitive and ergonomic user interface, fully accessible from the front panel for standalone operation.
- Two I/O Ethernet ports for networking up to 253 LA4 and LA8 units, remote-monitored by LA Network Manager software (Windows® compatible).

And the specific features of each unit are the following:

- The LA4 delivers up to 4 x 1000 watt into 4 ohm.
- The LA8 delivers up to 4 x 1800 watt into 4 or 2.7 ohm.
- An AES/EBU input card is integrated to the LA8 for digital audio implementation. This feature is available as an option on the LA4.
- The LA8 includes all current factory presets while the LA4 only includes presets of LA4 type.
- The output connectors are SpeakON® for the LA4 and CA-COM®/SpeakON® for the LA8.

The unique ensemble of on-board features and the addition of peripherals are all offered in a secured and standardized environment. This approach simplifies system setting and operation with the benefit of superior and predictable audio results across the entire product range.

Driving four amplified output channels through a DSP offers a wide range of options when it comes to sound system configuration. The LA4 and LA8 on-board preset libraries allow the sound engineer a high degree of flexibility in choosing the enclosure models and the system configuration for a specified application.

The factory preset libraries are derived from 6 basic system templates:

- 3-way active mono, quad-amplified
- cardioid subwoofer mono
- 2-way active stereo
- passive stereo
- hybrid active/subwoofer mono
- hybrid passive/subwoofer stereo



2 SYSTEM COMPONENTS

The system approach developed by L-Acoustics® consists in offering a global solution that guarantees the highest and most predictable level of performance at any step of loudspeaker system deployment: modeling, installation, and operation. A complete L-Acoustics® system includes enclosures, amplified controllers, cables, rigging system and software applications. The main components of an L-Acoustics® system that includes the LA8 are the following:

2.1 Powering and driving system

LA8	Amplified controller with DSP, preset library and networking capabilities
LA-RAK	Touring rack containing three LA8, for power, audio and network distribution.

2.2 Loudspeaker enclosures and cables

 Refer to the **user manuals** of the loudspeaker systems for detailed instructions about the enclosures and their connection to the LA amplified controllers.

2.3 Rigging element

 Refer to the **rigging manuals** of the loudspeaker systems for detailed instructions about the rigging of the enclosures.

LA8 Amplified Controller user manual

version 12.0

2.4 Software application

Soundvision Proprietary acoustical and mechanical 3D modeling software.

LA Network Manager Remote control and monitoring of amplified controllers



Using L-Acoustics® software

Refer to the **Soundvision help** and the **LA Network Manager tutorial**.

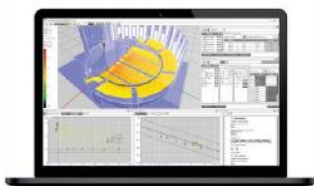

Soundvision



LA Network Manager



LA-RAK



LA8

Figure 1: Main components involved in loudspeaker system design and drive

3 LA8 AMPLIFIED CONTROLLER

3.1 Main features

3.1.1 Front and rear panels

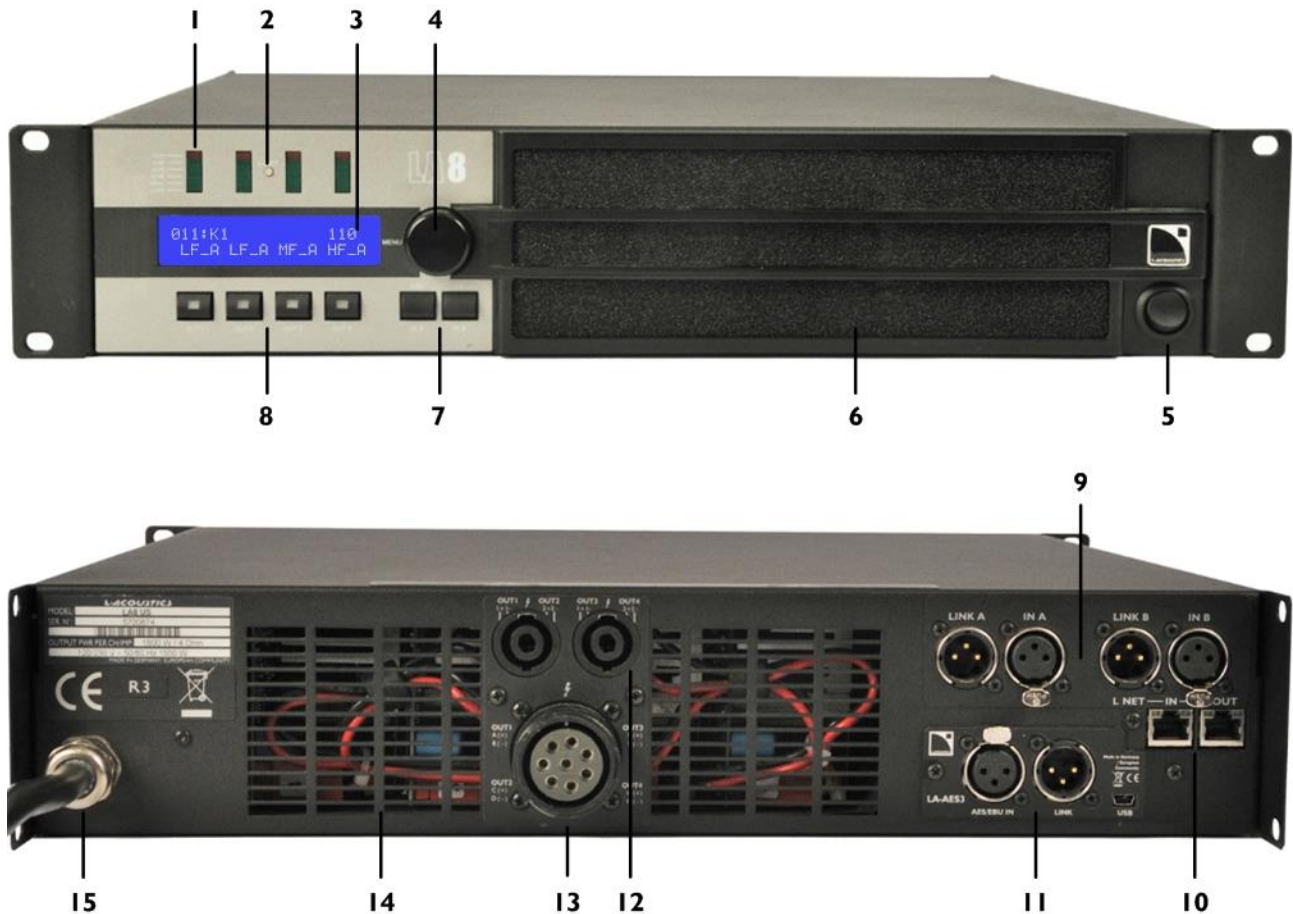

Figure 2: LA8 front and rear panels

- | | |
|---|--|
| 1. LED meters:
CLIP level
audio level (-25, -10, -5 dB)
SIGNAL presence
LOAD presence | 7. input selection/menu keys |
| 2. L-NET network control LED | 8. output selection keys |
| 3. LCD screen | 9. analog audio IN/LINK connectors (XLR) |
| 4. nav./edit encoder wheel | 10. L-NET network IN/OUT connectors (RJ45) |
| 5. power switch | 11. digital audio IN/LINK connectors (XLR) |
| 6. ventilation foam filter | 12. SpeakON® output connectors |
| | 13. CA-COM® output connector |
| | 14. ventilation grill |
| | 15. A/C power cord |

LA8 Amplified Controller

user manual

version 12.0

3.1.2 Simplified block diagram

The core of the LA8 is a DSP engine driving four channels of amplification from two inputs. The LA8 also features a flash memory for preset storage and management, high performance A/D-D/A converters for audio signals, an auto-sensing SMPS (Switched Mode Power Supply), a front panel user interface, and a Fast Ethernet device for network remote control.

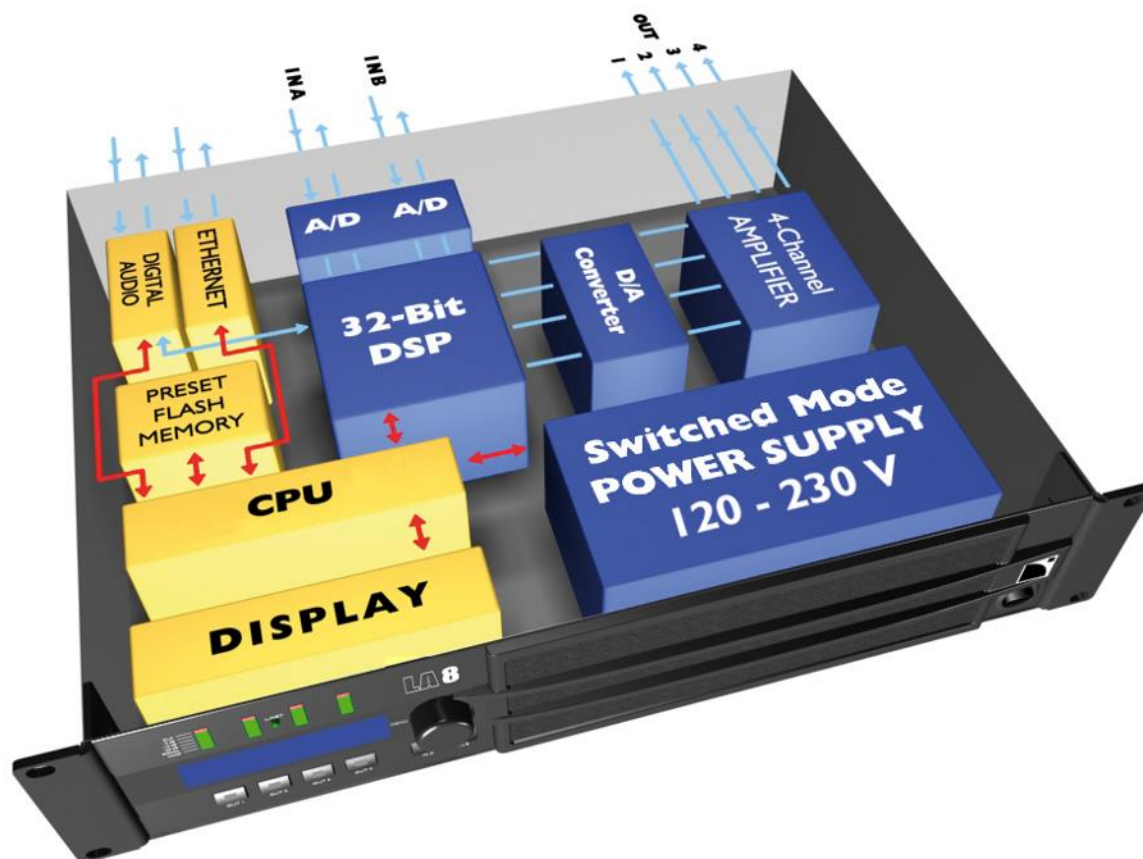

Figure 3: LA8 simplified block diagram

3.2 Signal processing and amplification

3.2.1 Analog input

The LA8 can be fed with two balanced analog audio signals using the appropriate XLR input ports (see Figure 2). Each of the analog input ports is ESD protected and equipped with one XLR3 female connector.

The analog input panel also features two XLR link ports passively connected to the input ports. It allows transmitting the input signals to daisy-chained amplified controllers. Each of the analog link ports is ESD protected and equipped with one XLR3 male connector.

To be processed by the DSP, the analog signal needs to be converted into a digital signal. For this purpose, the LA8 amplified controller is fitted with two cascaded 24-bit A/D converters with a sampling rate of 96 kHz allowing an encoding dynamic range of 130 dB.

3.2.2 AES/EBU digital input

The LA8 can be fed with one AES/EBU digital audio signal carrying two audio channels, thanks to the LA-AES3 card. The card features an XLR input port (see Figure 2), an active XLR link port, and a Sample Rate Converter (SRC).

The AES/EBU input port is ESD protected and equipped with one XLR3 female connector (transformer balanced). It allows the LA8 to receive two digital audio channels coming from a digital mixing desk or a digital audio network bridge compliant with the AES/EBU (AES3) or electrical S/PDIF (IEC 60958 Type II) digital audio standards.

The AES/EBU link port is ESD protected and equipped with one XLR3 male connector (transformer balanced). It allows transmitting the input signal to daisy-chained amplified controllers.

The SRC embedded in the LA-AES3 board has been selected to support a wide range of input formats (16-24 bits/44.1-192 kHz). It converts any of them to the 24 bits/96 kHz internal format used by the amplified controller. The SRC is a high-quality hardware component (140 dB dynamic range, THD+N<-120 dBfs, strong input jitter attenuation) and provides constant propagation delay regardless of the input sampling frequency. There is no external synchronization mode. The amplified controller's clock always runs using its high-precision internal quartz at 96 kHz. It ensures low jitter and high audio quality while preventing phase shift, as required for line source systems.

Digital domain benefits

Keeping the signal in the digital domain using the LA-AES3 board will provide the following benefits (with any digital mixing desk or any audio network) compared to the analog signal distribution:

- Better audio quality by removing one D/A - A/D cycle.
- Better dynamics thanks to the digital links' immunity to ground loops.
- Optimized level chain by removing the risk of level misalignment between console and amplified controllers.
- Digital signal refreshed at each amplified controller in a daisy-chain.
- Improved maximum cable length. The LA-AES3 has been tested with up to **305 m/1000 ft** of 3 models of AES/EBU rated cables: Belden® 1696A, Klotz Cables® OT234H, and Sommer Cable® SC BINARY 234 (single cuts, digital source signal running at $F_s = 48$ kHz).

LA8 Amplified Controller user manual

version 12.0

3.2.3 DSP architecture

The proprietary algorithms allow optimum performance and protection of each individual transducer of the L-Acoustics® systems for an even more natural, transparent, and realistic sound experience.

- The DSP engine is a 32-bit floating point DSP at 96 kHz sampling rate offering an enhanced dynamic range since it does not generate calculation clips like a fixed point DSP.
- A dedicated engineering approach combining IIR and FIR filters generates perfectly linearized phase curves and significantly improved impulse responses.
- The 2 x 4 matrix architecture offers flexibility for various system configurations.
- The L-DRIVE transducer protection system offers advanced protection by monitoring both excursion and temperature of the transducer.
- With a complete factory preset library and the possibility of creating additional user presets, the flash memory offers a quick access to all the usual L-Acoustics® speaker system configurations (refer to the **LA-PRESET GUIDE**).

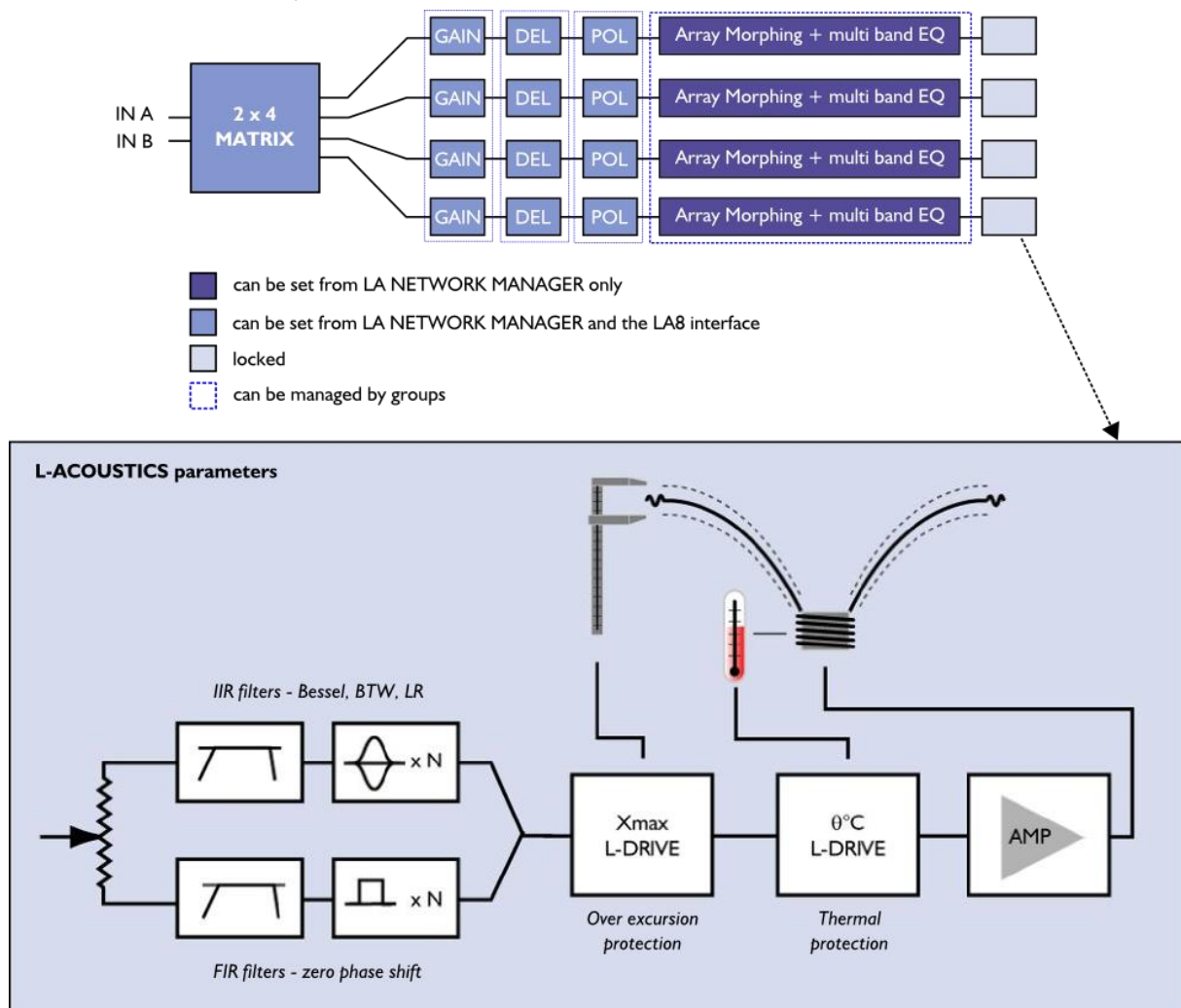

Figure 4: Audio path parameters



3.2.4 Amplifier section and power supply

The LA8 amplifier section uses a Class D technology supporting the very wide dynamic range found in live audio productions. The 4 channels can deliver up to 4 x 1800 watt into 4 or 2.7 ohm yielding perfect power matching to each individual L-Acoustics® loudspeaker system.

The auto-sensing SMPS (Switched Mode Power Supply) offers better stability by associating two symmetrical power supplies.

3.2.5 Speaker output

The LA8 features two 4-point SpeakON® and one 8-point CA-COM® connector for loudspeaker outputs.

3.3 Monitoring and control

3.3.1 User interface

The front panel user interface provides (see Figure 2):

- Real-time monitoring functionalities via the LED display (signals presence and level) and the LCD screen (system parameters).
- Instant access to navigation and parameters control using the encoder wheel and the six keys (for the 2 input and 4 output channels).



Operating instructions

Refer to section 0 for detailed operating instructions.

3.3.2 L-NET and remote control network

The design of complex systems is made possible by the integration of the L-NET Ethernet-based network. Thanks to its high speed data transfer protocol of 100 Mbit/sec, up to 253 units (LA4 and LA8) can be controlled and monitored in real-time from LA Network Manager software.

Multiple network topologies such as daisy-chain, star, and hybrid are quickly and easily configurable for full flexibility in the required system architecture. The computer running LA Network Manager and the units are connected to each other using industry standard CAT5e U/FTP cables (or higher category) fitted with RJ45 connectors. Each amplified controller connects to the network via the I/O Ethernet sockets located on its rear panel.



Operating instructions

Refer to the **LA Network Manager video tutorial** for detailed operating instructions.

LA8 Amplified Controller user manual

version 12.0

4 INSTALLATION

4.1 Mounting

The LA8 is two rack units high (2U) and can be mounted in an EIA-standard 19" rack (see Figure 5). The four points on the front panel are for rack mounting. Use four screws and washers to mount the controller to the rack front rails.

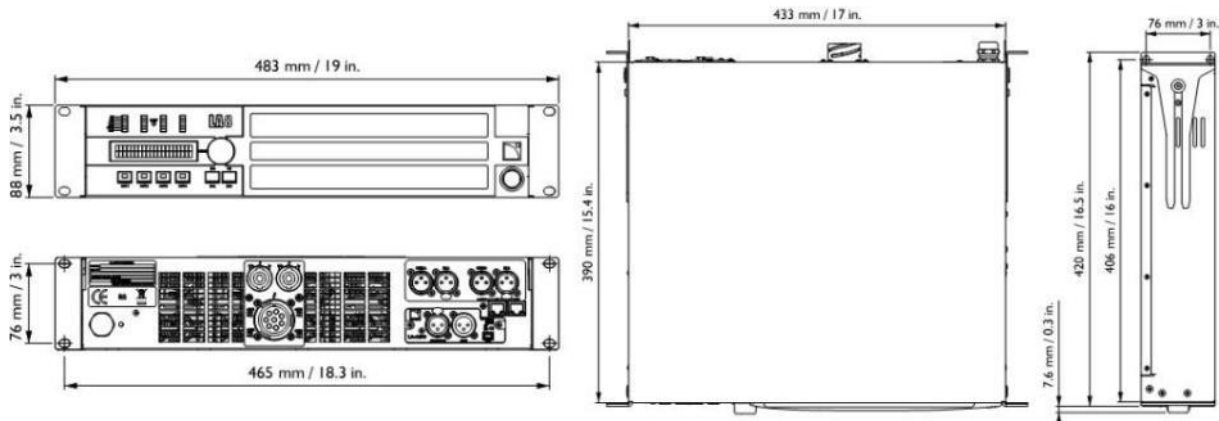

Figure 5: LA8 dimensions



Risk of damaging the controller during transport

During transport or while on tour it is essential that the controller is rear supported in addition to the front panel mounting.

Use the rear rack support brackets provided with the controller as shown in Figure 6.

Any mechanical damage to the controller used in portable applications without rear support will not be covered by warranty.

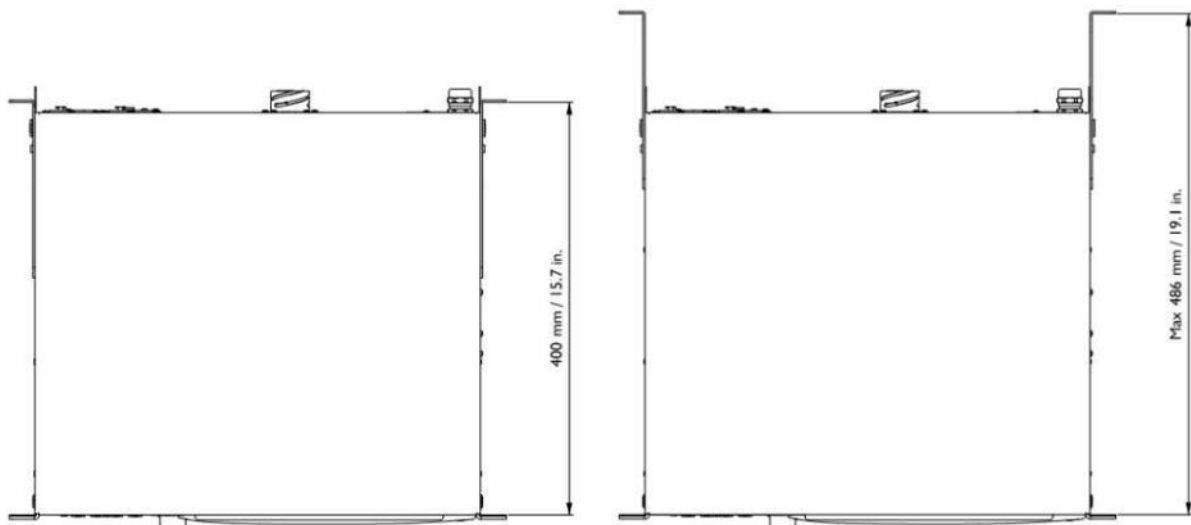

Figure 6: LA8 with rear rack support brackets



LA-RAK touring rack

The L-Acoustics® LA-RAK touring rack is available for three LA8 with all power and signal connection facilities (refer to the **LA-RAK user manual**).

4.2 Cooling

To maintain a low and even operating temperature the LA8 contains two fans providing front to rear airflow.

Instructions for proper ventilation

Do not block the front and rear ventilation grills on a controller.

Ensure that the front filter is clean and dust free.

If the controller is rack-mounted:

- Do not block the ventilation grills with front or back panels or doors. If not possible, use a forced ventilation system.
- When stacking more than one controller in a rack, mount them directly on top of each other or close any open space in the rack with blank panels.

4.3 Connecting to AC mains

4.3.1 AC mains specifications

 Only connect the LA8 (CE type) or LA8US (US type) to an AC power outlet rated 230 V, 16 A, 50 - 60 Hz or 120 V, 30 A, 50-60 Hz.

Only connect the LA8JP (Japan type) to an AC power outlet rated 100 V, 30 A, 50 - 60 Hz or 200 V, 15 A, 50-60 Hz.

To plug the controller to a mains only use an outlet fitted with a pin tied to ground.

Do not defeat the ground pin of the outlet as it connects the controller to earth.

If the local mains does not conform to the power requirements or is unsure consult an electrician.

The following table gives the LA8 power data in nominal use (4 Ω , 1/8 of maximum output power; refer to section 4.3.6):

Table 1: LA8 Power supply data in nominal use

Voltage (V)*	Frequency (Hz)	Current (A)	Power consumption (W)
120 / 230 (LA8, LA8US)	50 - 60	21 / 11	1500
100 / 200 (LA8JP)	50 - 60	25 / 13	1500

* If the mains voltage value increases up to more than 142 V the amplified controller will automatically switch to the 230 or 200 V mode.

If the mains voltage value decreases down to less than 132 V the amplified controller will automatically switch to the 120 or 100 V mode.

4.3.2 Three-phase circuit

 Verify that each phase works, in particular the neutral one.

Balance the loads between the three phases.

Never try to reproduce a 230 V circuit connecting an LA8 or LA8US to two live wires of a 120 V three-phase circuit.

Never try to reproduce a 200 V circuit connecting an LA8JP to two live wires of a 100 V three-phase circuit.

4.3.3 Circuit breaker

 Always interconnect a thermal circuit breaker between the controller and the mains.

The circuit breaker current rating depends on the mains voltage rating as follows:

16 A for 230 V or 30 A for 120 V (LA8, LA8US), 15 A for 200 V or 30 A for 100 V (LA8JP).

LA8 Amplified Controller

user manual

version 12.0

4.3.4 Electrical generator



You must power on the generator before powering on the amplified controllers.
Verify that the amplified controllers are turned off before powering the generator on.

Planning the power of the generator in kVA

Take the nominal values of the LA8, I and U. Look for the $\cos \varphi$ of the generator and its recommended operating range. Then apply the following formula: $I \times U / (\cos \varphi \times \text{range})$.

For instance, for LA8 in Europe, $I = 16 \text{ A}$ and $U = 230 \text{ V}$. With a typical generator, $\cos \varphi = 0.8$ and $\text{range} = 70 \%$. Then the generator must be capable of delivering $16 \times 230 / (0.8 \times 0.70) = 6.5 \text{ kVA}$.

4.3.5 Power plug

- The LA8 is supplied with a CEE 7/7 power plug (16 A / 250 V grounded).
- The LA8US is supplied with a NEMA L5-30P power plug (30 A / 125 V grounded).
- The LA8JP is supplied with the power plug selected by the Japanese distributor.



Plug connection

Strictly apply the specific safety regulations of the country of use.

Verify that the plug conforms to the specific voltage and current rating given in Table 1.

Do not disable the ground connection of the supplied AC power cord using an adaptor or any other methods.

A new fixed power panel with larger gauge wiring is quite often required to connect the LA8US so as to meet the 30 A specification.

If the power plug does not match the local power outlet, it can be cut off and wired to a suitable plug (refer to the **LA8 maintenance manual – level 1**).

4.3.6 Power consumption

The LA8 power requirements depend on the load impedance and the signal level as indicated in the following table:

Table 2: LA8 mains input power and current draw

Maximum output power			Mains input power and current draw			
Load	Number of driven channels	Power per channel	1/3 output power (-5 dB)	1/8 output power (-9 dB)	IDLE	Standby
4 Ω	4	1800 W	22 A / 3100 W	11 A / 1500 W	0.5 A / 115 W	< 0.1 A / 12 W
8 Ω	4	1100 W	15 A / 1950 W	10 A / 1300 W		

The current values are given for a mains rated at 230 V. Multiply by 2 for 120 V, 1.15 for 200 V, and 2.3 for 100 V.

If the voltage outside a plus or minus 10 % range, the maximum power is no longer guaranteed.



Output power references

A third of the maximum output power corresponds to the worst case scenario of a program source using highly compressed music or pink noise with amplifier driven to clip level.

An eighth of the maximum output power corresponds to a loud music program with a small dynamic range and 9 dB of headroom (IEC standard power rating).

4.3.7 Example of heat calculation

Connect a 4 Ω load to each output channel of the LA8: each channel can now deliver a power of up to 1800 W.

Consider a standard use at 1/8 of full power (9 dB headroom): the power delivered per channel is then $1800 / 8 = 225$ W, leading to a total power of $4 \times 225 = 900$ W for the LA8.

According to Table 2 the LA8 power consumption is 1500 W: the heat power produced is then $1500 - 900 = 600$ W (difference between power consumption and output power).

4.4 Audio and network cabling

4.4.1 Connection panels

The LA8 rear side features four connection panels (see Figure 7): ANALOG for analog audio distribution, AES/EBU for digital audio distribution, SPEAKER output, and L-NET for remote control with LA Network Manager software.

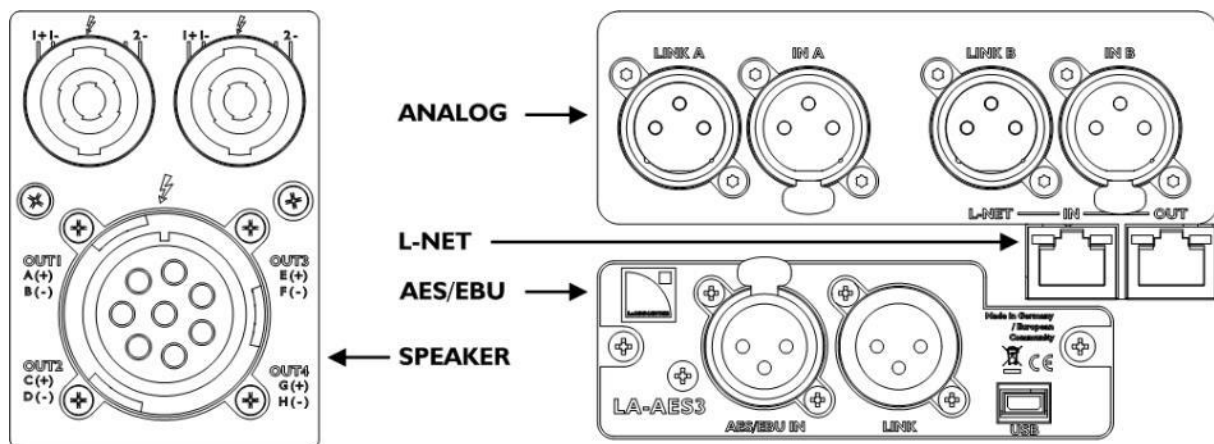

Figure 7: LA8 rear connection panels

LA8 Amplified Controller user manual

version 12.0

4.4.2 Analog audio cabling

The analog XLR connectors on the LA8 are wired according to IEC 268: pin 1= shield, pin 2= + signal, pin 3= - signal.

Two 3-point female XLR input connectors (IN A and IN B) are provided for the LA8 to receive two analog signals.

The headroom of the input circuits is high enough to accept the maximum output level from virtually any line level signal source (up to 22 dBu).

In a daisy-chain layout two 3-point male XLR connectors (LINK A and LINK B) feed the input signals to the next unit in the signal chain (see Figure 8). Both LINK connectors are passively wired in parallel on channels A and B (see Figure 9). The input impedance is high enough (22 k Ω , balanced) to allow multiple parallel input connections.

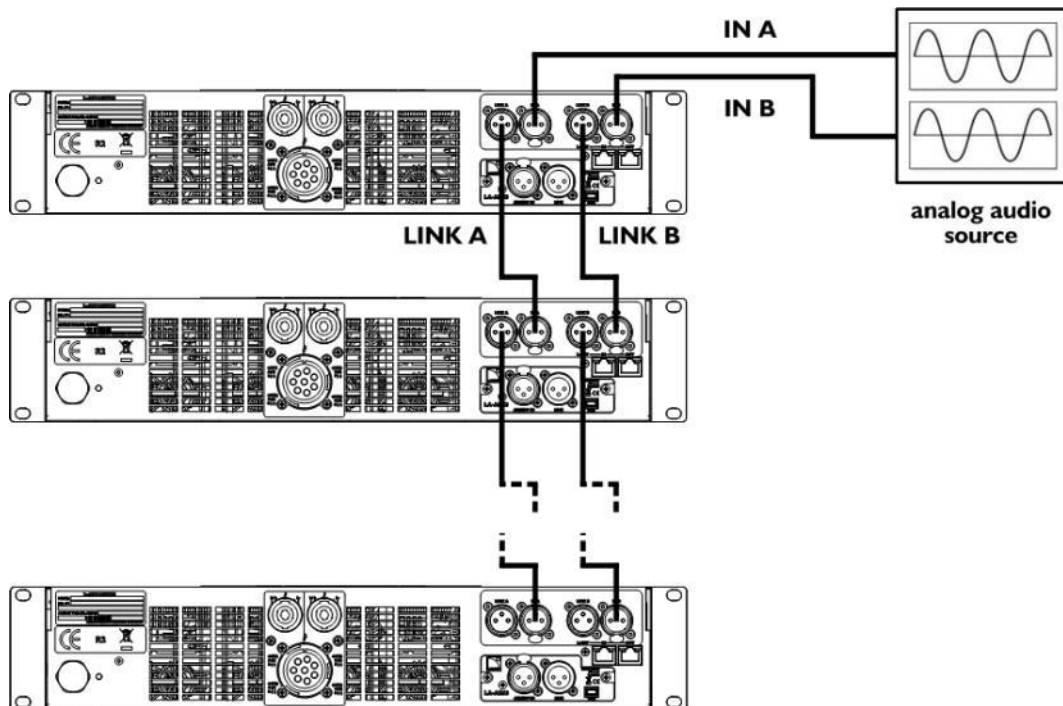

Figure 8: Daisy chaining analog audio

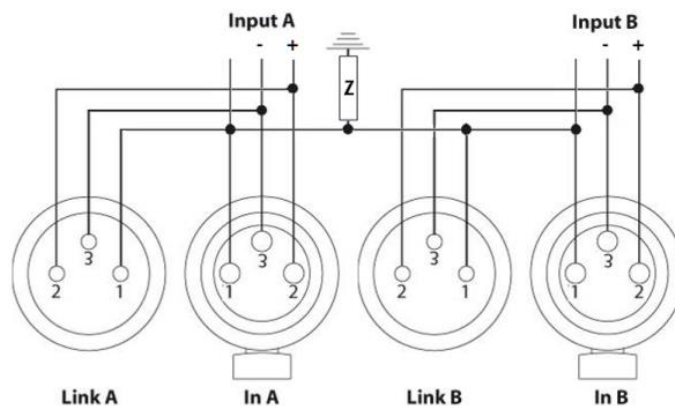

Figure 9: Analog input panel wiring



Balanced cables

Symmetrical (balanced) shielded cables are highly recommended as balanced signals are less sensitive to AC hum and radio interference.

Unbalanced lines may add noise especially over long cable runs.

4.4.3 AES/EBU digital audio cabling

Both AES/EBU XLR connectors on the LA8 are transformer balanced and wired according to IEC 268.

The 3-point female XLR input connector (IN) is provided for the amplifier to receive one AES/EBU (AES3) or electrical S/PDIF (IEC 60958 Type II) signal.

In a daisy-chain layout the 3-point male XLR connector (LINK) feeds the input signals to the next unit in the signal chain (see Figure 10). The LINK connector is electronically buffered to allow daisy-chaining any number of amplified controllers. It also features a failsafe relay to ensure wiring continuity in case of amplified controller shutdown (see Figure 11).

i Cables for AES/EBU digital audio

AES3 specifies that the nominal characteristic impedance of cables used for AES/EBU digital audio transmission shall be $110 \Omega \pm 20\%$, and closer tolerances allow for increased transmission reliability over long lengths or higher sampling rates.

Therefore, it is highly recommended to use high-quality AES/EBU rated cables only, although certain cables designed for balanced analog audio prove to be acceptable at 48 kHz sampling rate over short distances.

It is recommended to use single cuts of cable between AES/EBU outputs and inputs. Using several pieces reduces performances. If it is not possible to use single cuts, it is required to use the same model of cable between two AES/EBU interfaces.

In case an amplified controller shuts down, the failsafe relay makes a passive connection between the AES/EBU IN port and the LINK port to maintain continuity. However the signals are no longer refreshed for the next amplified controller, so that the input cable and the link cable must be considered as a unique input cable with regard to the maximum supported length.

In case of transmission losses, try to reduce the sampling frequency of the digital audio source. Moreover, as a general rule, avoid using sources rated beyond 96 kHz, as the maximum possible cable length is reduced, while the additional information is cancelled by SRC to 96 kHz.

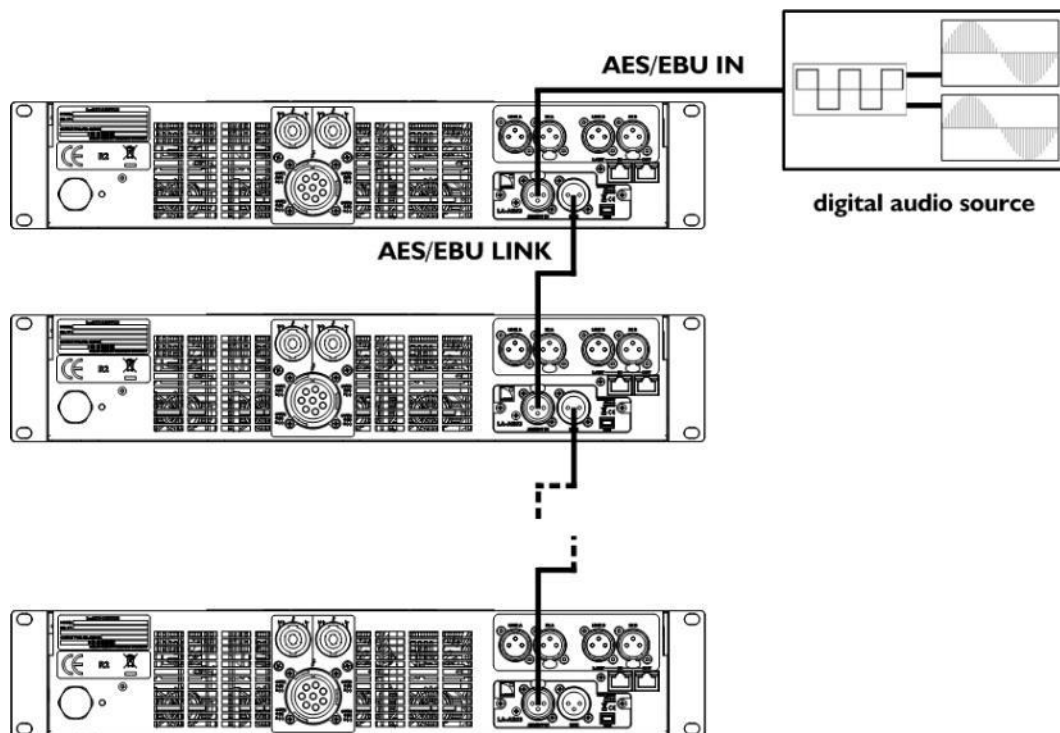

Figure 10: Daisy-chaining digital audio

LA8 Amplified Controller user manual

version 12.0

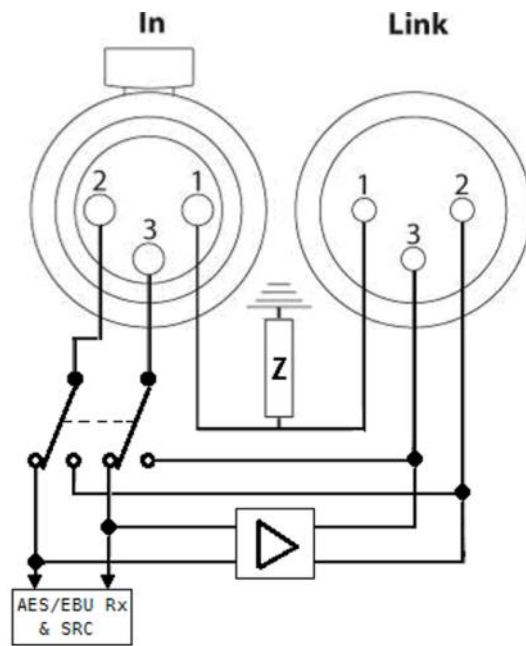

Figure 11: Digital input panel wiring

4.4.4 Loudspeaker cabling



There is a risk of damaging the speakers.

The DO2W, DOFILL and DOSUB PA-COM® cables are not compatible with the LA8.
 All other L-Acoustics® PA-COM® cables can be used.
 Refer to the **LA8 PACOM CABLES technical bulletin** for more details.



Loudspeaker system connection

Before connecting a loudspeaker system refer to the applicable **user manuals** for further instructions.

Two 4-point SpeakON® and one 8-point CA-COM® connectors on the rear panel of the LA8 are for loudspeaker connection. They are wired as follows (see Figure 12):

Left SpeakON® connector		Right SpeakON® connector	
Pin 1+	Out 1+	Pin 1+	Out 3+
Pin 1-	Out 1-	Pin 1-	Out 3-
Pin 2+	Out 2+	Pin 2+	Out 4+
Pin 2-	Out 2-	Pin 2-	Out 4-

CA-COM® connector			
Pin A	Out 1+	Pin E	Out 3+
Pin B	Out 1-	Pin F	Out 3-
Pin C	Out 2+	Pin G	Out 4+
Pin D	Out 2-	Pin H	Out 4-

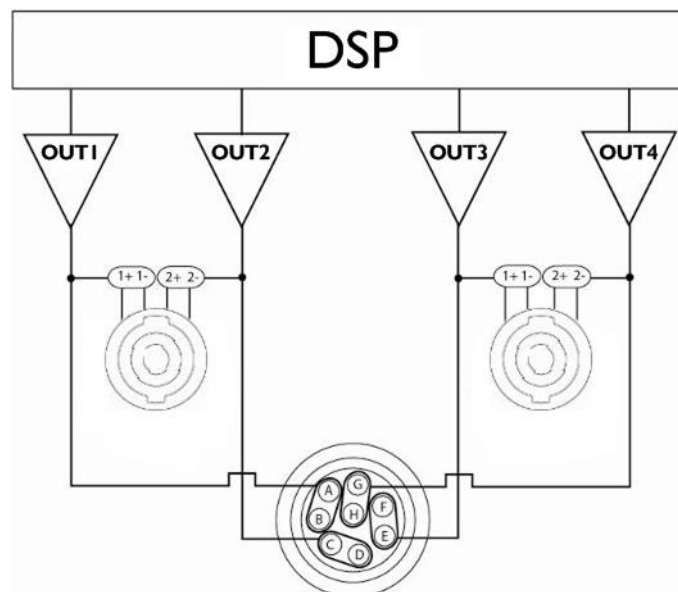

Figure 12: Output audio paths

LA8 Amplified Controller user manual

version 12.0

The table below describes the maximum number of enclosures a single LA8 amplified controller can drive.

Table 3: Maximum number of enclosures per LA8

Technology	Loudspeaker enclosure	Max number of connections per output *	Max number of enclosures per controller
Coaxial	5XT	6	24
	8XT	3	12
	Passive 12XT	2	8
	Active 12XT	3	6
	115XT HiQ	2	4
	112XT	3	6
	115XT	3	6
	MTD108a	3	12
	MTD112b	2	8
	Active MTD115b	2	4
	Passive MTD115b	2	8
	X8	2	12
	X12	2	8
	X15 HiQ	2	4
Constant Curvature WST	ARCS® Wide/Focus	2	8
	ARCS® II	2	4
	ARCS	3	6
Variable Curvature WST	KIVA / KILO	3	12
	Kara®	3	6
	Kudo®	3	3
	K2	3	3
	K1®	2	2
	K1-SB	1	4
	V-DOSC	2	2
	dV-DOSC	3	6

Technology	Loudspeaker enclosure	Max number of connections per output *	Max number of enclosures per controller
Subwoofers	SB15m	2	8
	SB18	2	8
	SB28	1	4
	SB118	2	8
	SB218	1	4
	dV-SUB	1	4

* For passive loudspeakers, the value corresponds to the number of enclosures in parallel on the output.
For active loudspeakers, the value corresponds to the number of sections in parallel on the output.

4.4.5 L-NET cabling

The LA8 can be remote controlled over an Ethernet network (called L-NET) using LA Network Manager software (refer to the **LA Network Manager video tutorial**). To connect the LA8 to L-NET use the Ethernet RJ45 connectors on the LA8 rear panel (see Figure 7).

L-NET cables specifications

Connect the computer and the amplified controllers to the L-NET network using straight-through Ethernet cables of CAT5e U/FTP category (or higher) and of 100 m/328 ft maximum length.

Exception: If the Auto MDI/MDIX functionality is not available on a switch used to build a star or hybrid topology, use a crossover cable between the switch and each controller.

Do not create loops in the network setup

Network and cable specifications

The L-NET network is rated at 100 Mbps.

A straight-through cable has pin 1 of one side connected to pin 1 of the other side, pin 2 to pin 2, etc.

A crossover cable has pin pairs 1-2 and 3-6 crossed.

The type of a cable can be directly identified comparing the wire colors between its two RJ45 connectors.

CAT5e U/FTP stands for a category 5, unshielded cable with foiled twisted pairs.

Using lower category cables or CAT5e "patch" cables will result in connection issues.

The maximum length for a typical CAT5e U/FTP cable is 100 m/328 ft.

This value is indicative and can vary depending on the quality of the cable.

LA4X amplified controllers should always be placed before LA4 and LA8 amplified controllers in daisy-chain networks.

LA4 and LA8 amplified controllers are equipped with former generation 100 Mb/s Ethernet ports that cannot communicate with Ethernet ports of different capabilities, creating detection issues in LA Network Manager.

LA8 Amplified Controller user manual

version 12.0

5 OPERATION

5.1 Powering on, powering off, standby mode

- ▶ Press the power switch up to power the LA8 on (see Figure 13).
The LA8 goes through a 9-second start-up sequence coming with **Initializing Controller** displayed on the LCD screen and all LED lit for test.
The LA8 will be ready for use when the main screen is displayed (refer to section 5.3.2).

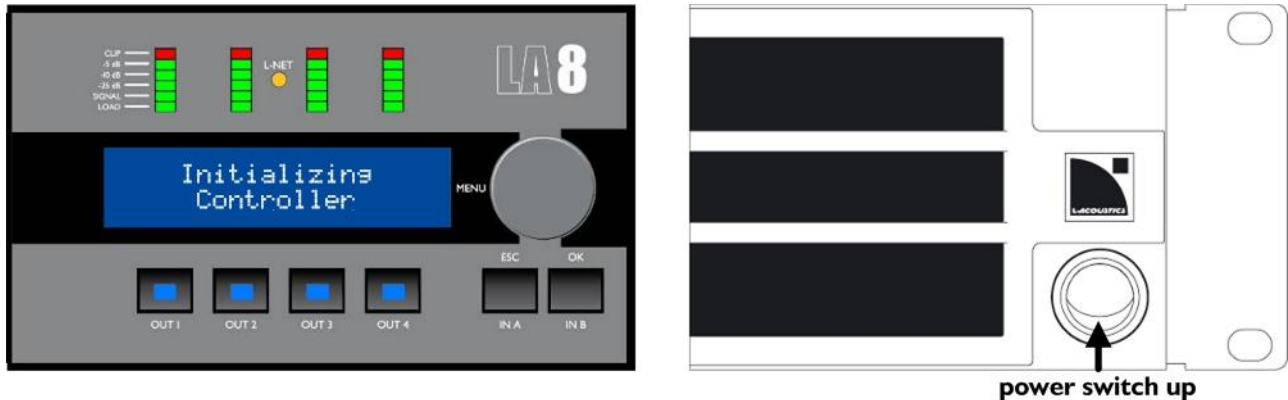

Figure 13: Start-up sequence

- ▶ Press the power switch down to power the LA8 off (see Figure 14). The LA8 goes through a shutdown sequence coming with **Waiting SMPS** displayed on the LCD screen and the four **LOAD** LED lit until complete shutdown.

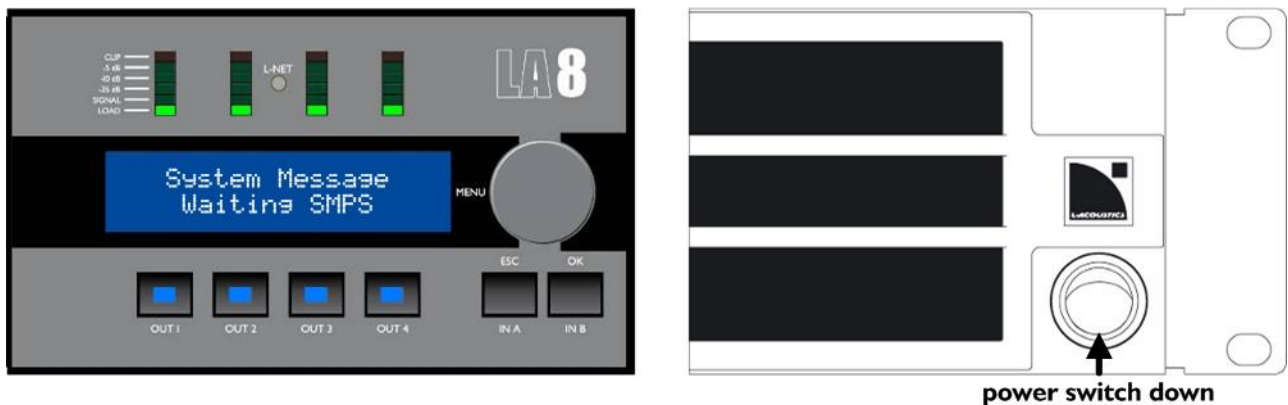

Figure 14: Shutdown sequence

- i Power loss**
If the power has been lost the controller will shut down but all parameters will be restored to same state as before shutting down when the controller switches on again.

- ⚡ Disconnection from mains**
The On/Off switch does not disconnect the amplified controller from mains.

- i Standby mode**
To reduce the electrical consumption and lock the front panel interface, the controller can be put in standby mode from LA Network Manager (refer to the **LA Network Manager video tutorial**).
Standby Mode will be displayed on the LCD screen while the controller is in standby mode.
It is possible to cancel the standby mode from LA Network Manager or from the LA8 front panel interface (▶ push and hold the encoder wheel for one second).

5.2 Display

5.2.1 Main screen

Once the start-up sequence has fully cycled (refer to section 5.1), the LCD displays the main screen:

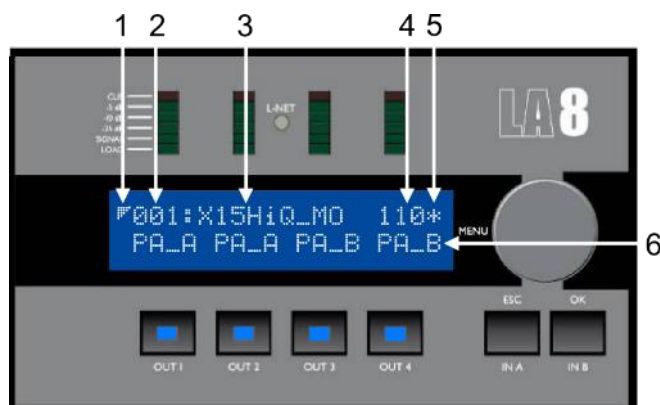

Figure 15: Main screen

1. Low latency symbol
Indicates loaded preset is a low latency preset (refer to the **LA Network Manager video tutorial**).
2. Preset memory number (001 to 255): memory space containing the current preset
The preset can be a user preset or come from an on-board preset library (refer to section 5.3.3).
3. Preset name as in the preset library or as entered by the user (if stored as a user preset).
4. Last number in the IP address (1 to 254)
Identifies the controller within the L-NET network (refer to section 5.2.3).
5. Star sign: indicates that parameters have been modified after the preset was last stored (refer to section 5.5).
6. Output name and input selection, placed above each output key, written in the **xx_y** format where:
 - **xx** indicate the type of transducer section or enclosure to be connected to the output channel:
 - LF** low frequency transducer section part of a 2 or 3-way loudspeaker enclosure
 - MF** mid frequency transducer section part of a 3-way loudspeaker enclosure
 - HF** high frequency transducer section part of a 2 or 3-way loudspeaker enclosure
 - PA** passive loudspeaker enclosure
 - SB** subwoofer enclosure installed with front face pointing towards the audience
 - SR** subwoofer enclosure installed with front face pointing towards the direction opposite from the audience (part of a cardioid configuration)
 - **y** indicates the input selection of the output channel (input channel or input channels combination selected to drive this output channel):
 - A** IN A
 - B** IN B
 - +** sum of IN A and IN B (A+B)
 - difference between IN A and IN B (A-B)

LA8 Amplified Controller user manual

version 12.0

5.2.2 LED meters

Four LED meters are located on the front panel above the LCD screen (see Figure 16).

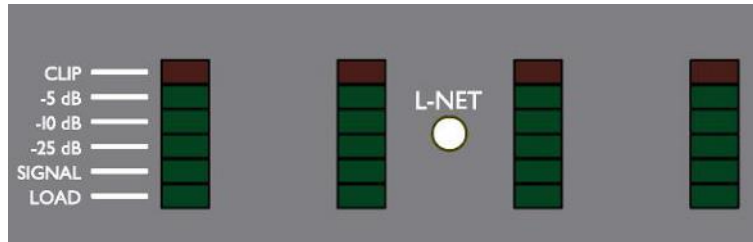

Figure 16: The four LED meters

By default the LED meters monitor the state of the four output channels via six LED:

LOAD lit when a load is connected and when the output module delivers a minimum of 0.8 A.

SIGNAL lit when a signal is detected at the corresponding output of the amplified controller and when the output voltage reaches 100 mV.

-25 dB

-10 dB lit when the output voltage reaches respectively 25 dB, 10 dB and 5 dB below the maximum level.

-5 dB

CLIP lit when the output voltage reaches the maximum level.

5.2.3 L-NET LED

The **L-NET** LED is lit in green (see Figure 17) when the LA8 is part of a network of controllers and driven by LA Network Manager software (refer to the **LA Network Manager video tutorial**).



Front panel commands

The front panel commands remain accessible if the **L-NET** LED is lit.

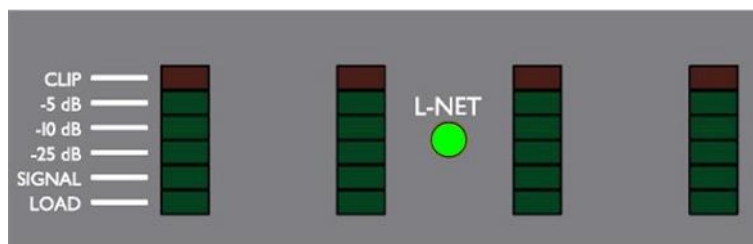

Figure 17: L-NET LED lit in green



The L-NET LED can also be lit in red or orange:

- Red indicates a protection system is activated (refer to APPENDIX A: PROTECTION SYSTEMS).
- Orange during the start-up sequence (refer to section 5.1) to test the two possible colors at once (green+red = orange).

5.3 User interface

5.3.1 Quick access

The LA8 offers quick access functions for control (front panel locking, mute, and gain), identification and monitoring (display of input level, input selection, input mode, and group information).

Lock/Unlock control

- ▶ To lock the front panel (even the mute function) and prevent unintentional operation press and hold the **IN A** and **IN B** keys simultaneously until **Display Locked** is displayed on the LCD screen.
- ▶ To unlock press and hold the **IN A** and **IN B** keys simultaneously until **Display Unlocked** is displayed on the LCD screen.

Mute control

- ▶ Tap one of the four output keys holding it less than 0.3 sec to mute or unmute the corresponding output channel.

The **MUTE OUT** page is displayed for 2 seconds.

The quick access mute control is available at all times and positions in the menu tree. The key is lit in blue when the corresponding output channel is muted and not lit when unmuted.

-  Outputs are muted in all factory presets. The gain can be set before unmuting.



Figure 18: Unmuting OUT 1

Gain control

Gain can be controlled in quick access mode simultaneously for all output channels fed by the same input following these steps:

- ▶ From the main screen press and hold the chosen output key. The LCD displays the gain values of all channels having the same routing as the selected channel.
- ▶ Turn the encoder wheel to set the gain values and simply release the key to return to the main screen.

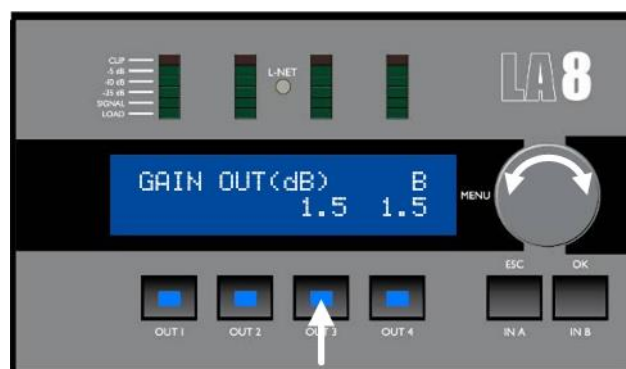

Figure 19: Setting the OUT 3 gain

LA8 Amplified Controller user manual

version 12.0

i Additional information about gain control

Quick access gain control is only available from the main screen.

Gain values can be set by 0.1 dB step (▶turn the encoder wheel) or by 1 dB step (▶ simultaneously press and turn the encoder wheel).

Examples of output channels routed to the same input (see Figure 20):

Pressing **OUT1** will select OUT1, OUT3 and OUT4 (containing A).

Pressing **OUT2** will select OUT2, OUT3 and OUT4 (containing B).

Pressing **OUT3** or **OUT4** will select all channels (containing A and B).

Individual gain settings are available from the **PRESET PARAMETERS** menu (refer to section 5.7).



Figure 20: Multiple routings

Identification

If the controller is online with LA Network Manager, it can be identified among other units in the workspace (refer to the **LA Network Manager video tutorial**).

- ▶ Press and hold the encoder wheel from the main screen to launch the Identification.
The controller flashes in yellow in LA Network Manager.

While pressing, the L-NET LED and the output keys flash. The controller also displays **IDENTIFICATION** and the IP address of the unit (see Figure 21).



Figure 21: Launching the Identification function

Input level, input selection, input mode and group information

- ▶ Press and hold the **ESC** or **OK** key from the main screen.
The LED meter and the top line of the LCD screen display information about input channels **IN A** and **IN B**, respectively from left to right, see Figure 22.
The bottom line of the LCD screen indicates the group assignment of output channels OUT 1, OUT 2, OUT 3 and OUT 4, respectively from left to right, see Figure 22.

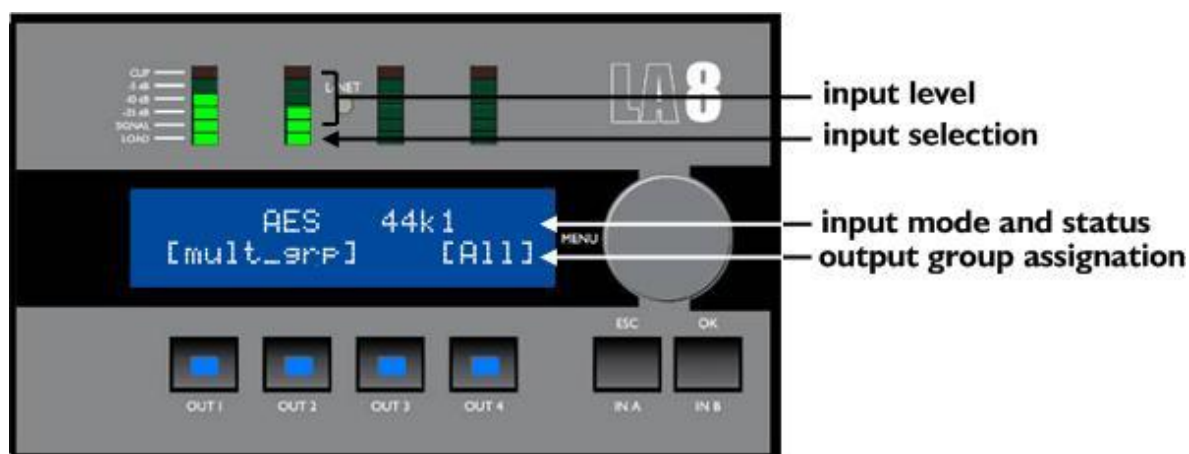

Figure 22: Pressing ESC or OK

The LED **SIGNAL** to **CLIP** indicate the level of the signal on the corresponding input channel. For example in Figure 22, the signal of channel IN A has a level of -10 dB and the signal of channel IN B has a level of -20 dB.

i Input voltage values

The **SIGNAL** LED is lit when the input voltage reaches -38 dBu (analog audio source) or -60 dBfs (digital audio source).

The **CLIP** LED is lit when the input voltage reaches 22 dBu (analog audio source) or -0.1 dBfs (digital audio source).

Reminder: -38 dBu = 10 mV and 22 dBu = 9.8 V.

The **LOAD** LED is lit if the corresponding input channel is part of the input selection of at least one output channel (refer to section 5.2.1). For example in Figure 22, both channel IN A and IN B are selected.

The top line of the LCD screen indicates the input mode and status of the input channels (refer to section 5.9.1). For example in Figure 22, IN A and IN B receive an AES/EBU signal of 44.1 kHz.

The bottom line of the LCD screen indicates the group assignment of the corresponding output channel (refer to section 5.8). For example in Figure 22, channels OUT 1 and OUT 2 are linked by brackets, it means that they are assigned to the same group or set of groups (if an output channel is assigned to several groups, the group name is **mult_grp**), OUT 3 is not assigned to any group and OUT 4 is assigned to a group named **All**.

LA8 Amplified Controller user manual

version 12.0

5.3.2 Main menu

The main menu gives access to the pages described in the following table. Please refer to the appropriate sections for detailed instructions.

LA Network Manager software

All parameters in each amplified controller can also be set from LA Network Manager software (refer to the **LA Network Manager video tutorial**).

Table 4: Main menu description

Page	Functionalities	Section
LOAD PST USER	load a user preset (memories 1-10)	5.4
LOAD PST FACTORY	load a factory preset (memories 11-199)	
STORE PRESET	save the current preset (including the current settings) as a user preset (memories 1-10)	5.5
DELETE PRESET	delete a user preset (memories 1-10)	5.6
PRESET PARAMETERS	set the gain, delay, polarity, and routing parameters	5.7
CLEAR GRP PARAMS	remove the group parameters defined in LA Network Manager software (name, gain, delay, and contour EQ)	5.8
INPUT SETTINGS	set the input mode, fallback mode and AES/EBU gain	5.9
MONITORING & INFO	display real-time measured values: RMS output voltage and output temperature (in percentage of the maximum values) display the firmware and factory preset library versions display the controller's MAC address	5.10
OPTIONS	set the controller's IP address set the delay unit and LCD screen contrast reset all parameters to factory defaults	5.11

To select a menu page follow these steps (see Figure 23):

- ▶ Press and release the encoder wheel.
- ▶ Turn the encoder wheel clockwise or counterclockwise to scroll through the page names.
- ▶ Press the **OK** key or the encoder wheel to select a page or press the **ESC** key to return to the main screen.

i On the LCD screen two types of arrow cursors indicate how to navigate through the menus (see Figure 23):

Position cursors (on the left)

- ↓ Start of a menu. Other functionalities can be displayed turning the encoder wheel clockwise.
- ↕ Middle of a menu. Other functionalities can be displayed turning the encoder wheel clockwise or counterclockwise.
- ↑ End of a menu. Other functionalities can be displayed turning the encoder wheel counterclockwise.

Selection cursors (on the right)

- ↔ Another menu level or function can be accessed pressing the **OK** key or the encoder wheel.
Press the **ESC** key to return to the previous menu.
- ← No additional menu level or function exist.
Turn the encoder wheel to access another menu or press the **ESC** key to return to the previous menu.



Figure 23: Main menu

5.3.3 Access rights, PIN code

The functionalities indicated in the following table can be locked or protected by a 4-digit PIN code defined from LA Network Manager (refer to the **LA Network Manager video tutorial**):

Table 5: Functionalities locked or protected by PIN code

Functionality	Locked / PIN code protected
Quick access to gains on keys OUT1 to OUT4	Locked
LOAD PST FACTORY	PIN code protected
STORE PRESET	PIN code protected
DELETE PRESET	Locked
PRESET PARAMETERS (all parameters)	PIN code protected
CLEAR GRP PARAMS	PIN code protected
NETWORK ADDRESS	PIN code protected
RESET TO FACTORY DEFAULT SETTINGS?	Locked

LA8 Amplified Controller user manual

version 12.0

When the protection is enabled, each time one tries to use a protected functionality, the LCD screen displays **ACCESS LOCKED** or **ENTER PIN** (see Figure 24).



Figure 24: Lock and PIN code protection messages

In the first case, the functionality cannot be accessed. Press the **ESC** key to abort.

In the second case, access the functionality entering the PIN code as follows (see Figure 25):

- ▶ Press and hold the **OUT1** key, or press the **ESC** key to abort.
- ▶ Turn the encoder wheel to select the first digit of the PIN code.
- ▶ Release the **OUT1** key.
- ▶ Repeat the procedure for keys **OUT2** to **OUT4** and their associated digits.
- ▶ Press the **OK** key.

*If the controller displays **ENTER PIN: ? ? ? ?**, it means that the PIN code is wrong. Repeat the procedure to make corrections, or press the **ESC** key to abort.*

Else, the functionality is displayed and can be accessed until you leave the current menu.

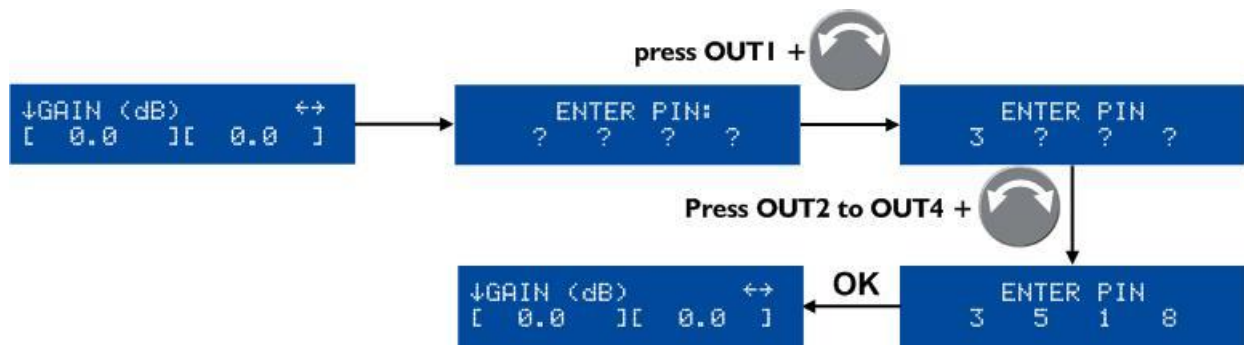

Figure 25: Entering a PIN code

i Disabling the protection

The lock / PIN code protection can only be disabled from LA Network Manager by entering the password defined for the specific amplified controller (refer to the **LA Network Manager video tutorial**).

5.4 LOAD PST

A preset can be loaded from the following menu pages:

Table 6: LOAD PST pages

Page	Memory range	Contents
LOAD PST USER	1 - 10 (read and write)	User presets stored by the user (refer to section 5.5).
LOAD PST FACTORY	11 - 199 (read only)	Factory preset library created by L-Acoustics® and automatically installed during firmware update (refer to the LA Network Manager video tutorial).

To load a preset follow these steps (see Figure 26):

- ▶ From the main menu select **LOAD PST USER** or **LOAD PST FACTORY**.
If the controller displays **NO PRESETS AVAILABLE!** when you select **LOAD PST USER** it means that all user memories are empty. Press the **ESC** key to abort. — **END** —
Else, continue the procedure.
- ▶ Turn the encoder wheel to scroll through the presets.
- ▶ Press the **OK** key or the encoder wheel to select a preset (or **ESC** to abort).
The controller displays **ARE YOU SURE?**.
- ▶ Press the **OK** key or the encoder wheel to validate (or **ESC** to abort).
If the controller is not assigned to a group (refer to section 5.8) or is connected to L-NET (refer to section 5.2.3) the preset is activated and the main screen is displayed.
If the controller displays **CLEAR GROUP PARAM?** it means that it has been assigned to a group (refer to section 5.8) but it is no longer connected to L-NET (refer to section 5.2.3). Press the **OK** key to clear the group parameters or press the **ESC** key to keep the group parameters active.

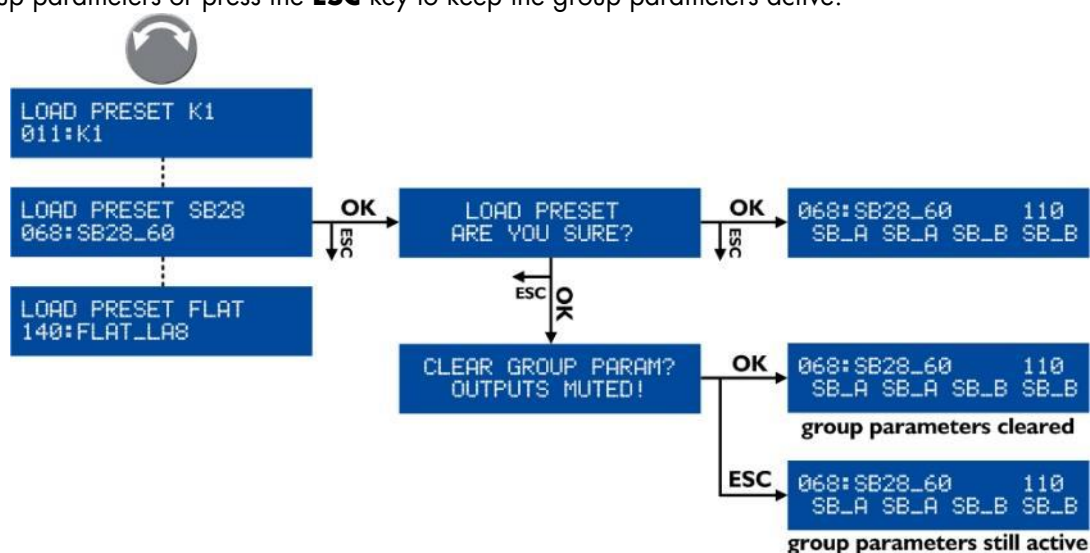

Figure 26: Loading a preset (example with a factory preset)

i Complements about the LOAD screen

The upper line of the screen displays the preset family allowing coarse selection while the bottom line displays the preset name allowing preset selection within a family.

If the name of the displayed preset has been modified (user presets only):

- ▶ Press and hold the encoder wheel to display the original name.

When returning to the main screen, the preset names containing more than 11 characters are not fully displayed and are followed by ellipsis (...).

- ▶ Turn the encoder wheel to display the full name for 2 seconds.

LA8 Amplified Controller user manual

version 12.0

5.5 STORE PRESET

The **current preset** and the possible setting modifications can be stored to a **user memory (1-10)**.

i Modifications flag
The modifications of the preset parameters are indicated by a star sign (on the top right corner of the LCD screen) until the preset has been stored to a user memory or set to its initial settings.

! There is a risk of losing the preset parameter modifications
Preset parameter modifications (refer to section 5.7) are not automatically saved to the current preset: they will be lost if the preset is reloaded prior to storing it (e.g. while the star sign is displayed). However, the current state is saved when the controller is shut down.

To store a preset follow these steps (see Figure 27):

- ▶ From the main menu select **STORE PRESET**.
- ▶ Turn the encoder wheel to scroll through the user memories.
- ▶ Press the **OK** key or the encoder wheel to select a user memory (or **ESC** to abort).
If the controller displays **OVERWRITE?** it means that a preset is already stored in the selected user memory.
- ▶ Press the **OK** key or the encoder wheel to validate (or **ESC** to abort).
- ▶ If necessary enter a new preset name (**16** characters max) as follows:
 - a. Turn the encoder wheel to select the first character.
 - b. Press the encoder wheel to go to the next character.
 - c. Repeat these steps until the new name has been entered.

i Pressing the encoder wheel from the 16th character makes the cursor return to the first character so that it is possible to apply the procedure a new time for possible corrections.
- ▶ Press the **OK** key to validate (or **ESC** to abort).
The preset is stored and the main screen is displayed.

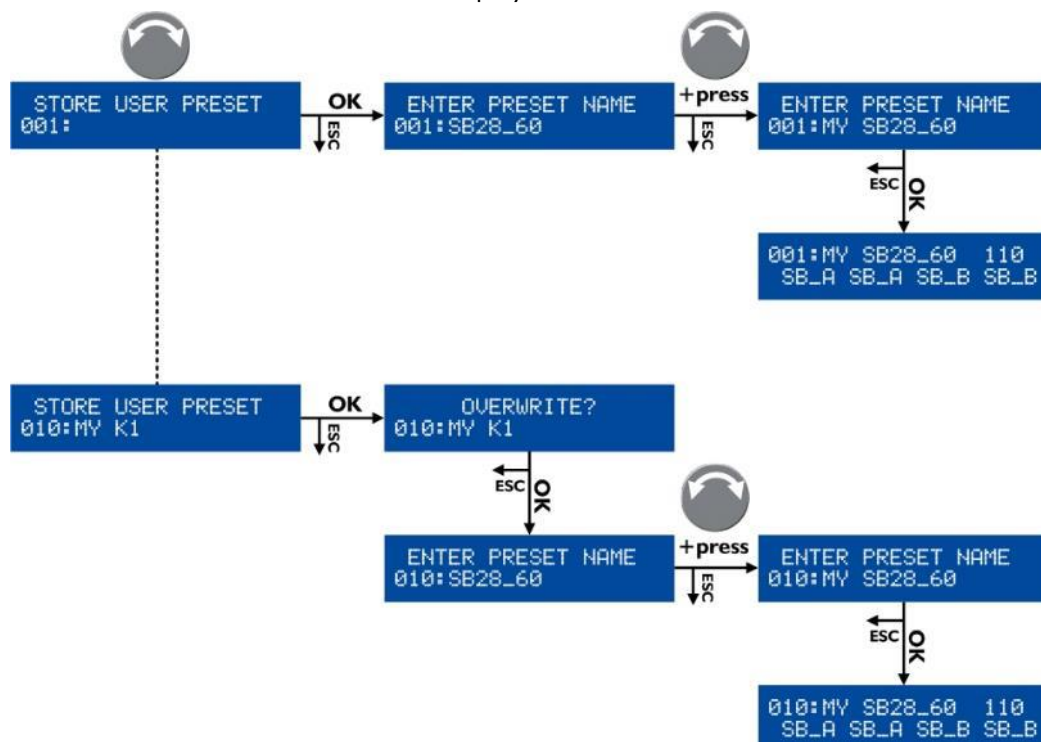

Figure 27: Storing a preset

5.6 DELETE PRESET

A user preset contained in a user memory (**1-10**) can be deleted following these steps (see Figure 28):

- ▶ From the main menu select **DELETE PRESET**.
If the controller displays **NO PRESETS AVAILABLE!** it means that all user memories are empty.
Press the **ESC** key to abort. — **END** —
Else, continue the procedure.
- ▶ Turn the encoder wheel to scroll through the user presets.
- ▶ Press the **OK** key or the encoder wheel to select a preset (or **ESC** to abort).
The controller displays **ARE YOU SURE?**.
- ▶ Press the **OK** key or the encoder wheel to validate (or **ESC** to abort).
If the main screen is displayed it means that the selected preset has been deleted.
If the controller displays **CANNOT DELETE THE CURRENT PRESET** it means that the selected preset is the current preset thus it is not possible to delete it.
Press the **ESC** key to abort.



Figure 28: Deleting a user preset

LA8 Amplified Controller user manual

version 12.0

5.7 PRESET PARAMETERS

The preset parameters (gain, delay, polarity, and routing) of the current preset can be set individually for each output channel or channel set (refer to the following INFORMATION note).

i Channel set

In certain presets, some channels are interdependent and form what is called a channel set. Within a channel set the user preset parameters are common to all channels.

On the LCD screen the channel sets are indicated by brackets displayed above the corresponding output channel keys. For example Figure 29 shows on the left a preset composed of two channel sets (LF/HF-LF/HF) for 2-way active loudspeakers, and on the right a preset composed of one 4-channel set (SR/SB/SB/SB) for 4 subwoofers in cardioid configuration.

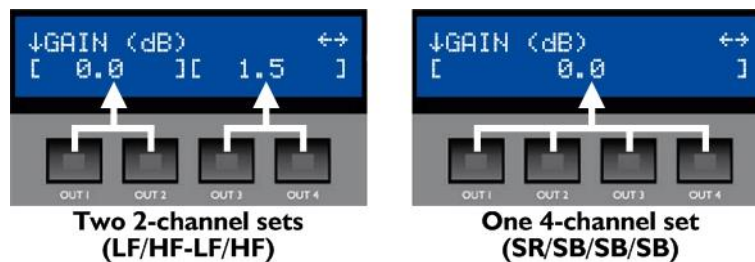

Figure 29: Channel sets

To set the preset parameters follow these steps (see Figure 30):

- ▶ From the main menu select **PRESET PARAMETERS**.
- ▶ Turn the encoder wheel to select a preset parameter.
- ▶ Press and hold the chosen output key (or any output key of a channel set) and turn the encoder wheel to select a value (or press **ESC** to abort).
- ▶ Release the key.
- ▶ Repeat the procedure for each value to be set.
- ▶ Press **ESC** to return to the main menu.

i If necessary all preset parameters (including the preset name) can be reset to default values following these steps (see Figure 30):

- ▶ Turn the encoder wheel to select **RESET PRESET**.
- ▶ Press the **OK** key or the encoder wheel two times (or **ESC** to abort).

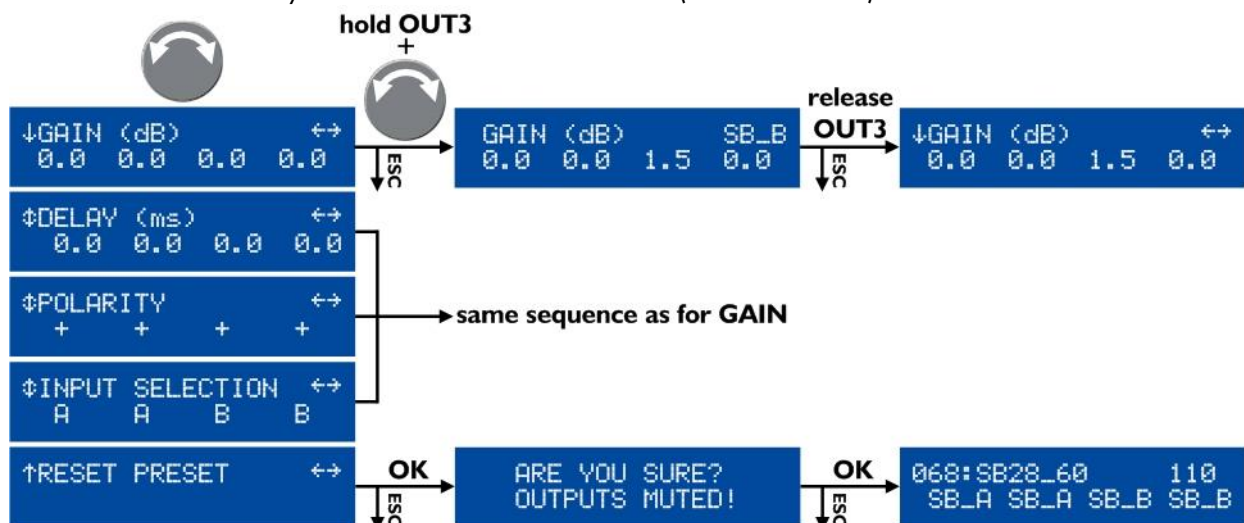

Figure 30: Setting the preset parameters

i Value ranges

Gain values are adjustable between **-60 dB** and **+15 dB**.

Delay values are adjustable from **0** to **680 ms** (65280 samples / 233.5 m / 765.9 ft at 20 °C).

Refer to section 5.11.2 for delay unit setting.

i Value setting resolution

▶ Turn the encoder wheel to obtain fine resolution (last digit).

▶ Press and turn the encoder wheel to obtain coarse resolution (second to last digit).

i Total delay

The total delay is the sum of the group delays (set in LA Network Manager) and the output channel delay.

The total delay cannot exceed **680 ms**.

i Preset parameters saving

Preset parameter modifications apply immediately but are not automatically saved to the current preset (they will be lost if the preset is reloaded). Use the **STORE PRESET** function to save the current preset along with settings to a user memory (refer to section 5.5).

LA8 Amplified Controller user manual

version 12.0

5.8 CLEAR GRP PARAMS

The group parameters (name, gain, delay, and contour EQ) defined in LA Network Manager (refer to the **LA Network Manager video tutorial**) can be cleared.

i Group and preset parameters

The group parameters apply to a set of amplified controllers that are part of a group while the preset parameters apply to a single amplified controller (refer to section 5.7).

CLEAR GRP PARAMS only clears the group parameters and does not clear the preset parameters.

To clear the group parameters follow these steps (see Figure 31):

- ▶ From the main menu select **CLEAR GRP PARAMS**.
- ▶ Press the **OK** key or the encoder wheel (or **ESC** to abort).
*If the controller displays **L-NET ACTIVE. CANNOT CLEAR** it means that the operation is not allowed since the controller is driven by LA Network Manager. Press the **ESC** key to abort. — END —*
*If the controller displays **NO GROUP DEFINED. CANNOT CLEAR** it means that the operation is not possible as no group is defined. Press the **ESC** key to abort. — END —*
*If the controller displays **ARE YOU SURE? OUTPUTS MUTED!** it means that the operation can be continued and that all outputs will be muted in the process. Continue the procedure.*
- ▶ Press the **OK** key or the encoder wheel (or **ESC** to abort).
If the main screen is displayed it means that all group parameters are now reset and all outputs are muted.

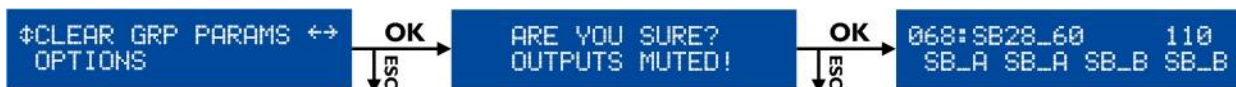

Figure 31: Clearing the group parameters

i Group parameters persistence

The group parameters remain active even if the controller is disconnected from the computer running LA Network Manager (controller in the standalone mode) and they are not preset dependent (they will remain the same even if a new preset is loaded).

Therefore, when getting a controller for a standalone application that has been previously used within a network, L-Acoustics® recommends using **CLEAR GRP PARAM** to clear all group parameters as they cannot be seen and accessed via the front panel user interface.

i Group information

It is possible to verify if a controller is part of a group and to identify its name pressing and holding the **IN A** or **IN B** key from the main screen (refer to section 5.3.1).

5.9 INPUT SETTINGS

5.9.1 INPUT MODE

This function allows selecting the physical input connector according to the audio source feeding the amplified controller:

- An analog audio source connects to the **IN A** and/or **IN B** inputs of the ANALOG panel (see Figure 7).
In this case activate the analog inputs selecting the **ANALOG** input mode.
- A digital audio source connects to the **AES/EBU IN** input of the AES/EBU panel (see Figure 7).
In this case, activate the digital inputs selecting the **AES/EBU** input mode.

To select the input mode follow these steps (see Figure 32):

- ▶ From the main menu select **INPUT SETTINGS** and press the **OK** key or the encoder wheel.
- ▶ Turn the encoder wheel to select **INPUT MODE** and press the **OK** key or the encoder wheel.
- ▶ Turn the encoder wheel to select **ANALOG** or **AES/EBU**.
- ▶ Press the **OK** key or the encoder wheel to validate the setting (or **ESC** to abort).



Figure 32: Selecting the input mode

In Figure 32 the AES/EBU input mode has been enabled. **LOCK 44k1** is a status message indicating that the AES/EBU input mode is active and that the digital audio source provides signals of sampling frequency of 44.1 kHz.

The LOCK status is obtained under the following conditions: a digital audio source is connected to the AES/EBU input, the signal delivered by the source has a format supported by the controller's digital audio card, and no loss or fault is being detected during data transfer.

If these conditions are not fulfilled the status will turn to **LOCK-WARN** or **UNLOCK**. The LOCK-WARN status (see Figure 33 left) indicates that the incoming digital signal has a sampling frequency out of the nominal range that does not lead to sound cut. On the contrary, the UNLOCK status (see Figure 33 right) indicates a faulty digital signal leading to sound cut.



Figure 33: LOCK-WARN and UNLOCK statuses

LA8 Amplified Controller user manual

version 12.0

Sound cut can be avoided using the FALLBACK MODE on the **AES/EBU IN** input and a backup audio source connected to the analog inputs (refer to section 5.9.2). In case of **UNLOCK** status the analog input will automatically be selected, leading to one of the screens of Figure 34. **AN.FBACK** indicates that the amplified controller has switched to analog fallback. The text displayed on the right (**UNLOCK**, **LOCK-WARN**, or **LOCK 44k1**) informs the user about the status of the AES/EBU audio source.



Figure 34: FALLBACK statuses

When the LOCK status has been recovered, the user can manually reactivate the AES/EBU input applying the sequence described in Figure 35.

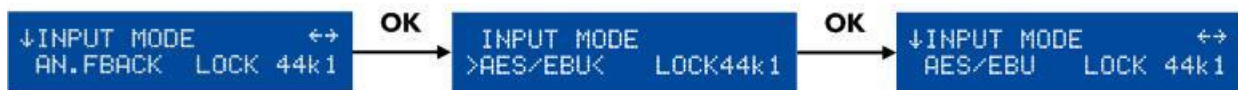

Figure 35: Reactivating the AES/EBU IN input

5.9.2 FALLBACK MODE

An automatic fallback option can be enabled or disabled. When enabled, and when the AES/EBU input mode is selected, the amplified controller will automatically switch from digital to analog input in case of digital signal failure (no clock, loss of lock, CRC error, bipolar encoding error, data slip). This option prevents sound cut.

After the digital signal has returned to normal state, reverting to digital input is not automatic and must be done manually by the user. This can be done simultaneously for all concerned amplified controllers from LA Network Manager software.

Precautions for using the automatic fallback option

Before enabling the automatic fallback option, some precautions have to be taken in order to avoid sound cut or level differences in case of switch from digital to analog input:

The analog inputs must be connected to an audio source playing the same program as the digital audio source connected to the AES/EBU input.

The level of the digital audio source connected to the AES/EBU input must be aligned to the level of the analog audio source using the **AES/EBU GAIN** control (refer to section 5.9.3).

Two FALLBACK MODE settings are available, as described in the following table:

Table 7: FALLBACK MODE settings

OFF	Automatic fallback option disabled. The sound will be cut off in case of digital signal failure, but it will automatically be recovered when the signal has returned to normal state.
ON	Automatic fallback option enabled. The ANALOG inputs will automatically be selected in case of digital signal failure on the AES/EBU inputs. Revert to AES/EBU is not automatic and must be done manually by the user.

To select the fallback mode follow these steps (see Figure 36):

- ▶ From the main menu select **INPUT SETTINGS** and press the **OK** key or the encoder wheel (or **ESC** to abort).
- ▶ Turn the encoder wheel to select **FALLBACK MODE**.
- ▶ Press the **OK** key or the encoder wheel to enter the page (or **ESC** to abort).
- ▶ Turn the encoder wheel to select the chosen setting.
- ▶ Press the **OK** key or the encoder wheel to validate the setting (or **ESC** to abort).



Figure 36: Selecting the fallback mode

Invalid audio (validity bit)

A validity bit at non-audio value will not trigger the automatic fallback. Instead the signal will be muted.

LA8 Amplified Controller

user manual

version 12.0

5.9.3 AES/EBU GAIN

The AES/EBU input ports include a gain module, common to all ports, which can be set from -12 dB to +12 dB by 0.1 dB steps. It must be used when the fallback mode is enabled, a digital audio source is connected to AES/EBU input and an analog audio source is connected to the ANALOG inputs. The AES/EBU GAIN allows aligning the digital audio source level to the analog level value so as to ensure seamless fallback switch from AES/EBU to analog inputs in case of fallback mode activation (refer to section 5.9.3).

The AES/EBU GAIN must be set according to the analog audio source's calibration (based on manufacturer's specs or user measurements) and the amplified controller's analog inputs calibration (0 dBfs for an input signal of +22 dBu). The three following examples illustrate the most common cases:

- If the analog audio source is calibrated at +18 dBu for 0 dBfs, set the AES/EBU GAIN to -4 dB.
- If the analog audio source is calibrated at +24 dBu for 0 dBfs, set the AES/EBU GAIN to +2 dB.
- If the analog audio source is calibrated at +22 dBu for 0 dBfs or if the fallback option is disabled, set the AES/EBU GAIN to +0 dB.

To set the AES/EBU GAIN follow these steps (see Figure 37):

- ▶ From the main menu select **INPUT SETTINGS** and press the **OK** key or the encoder wheel (or **ESC** to abort).
- ▶ Turn the encoder wheel to select **AES/EBU GAIN**.
- ▶ While holding the **ESC**, **OK** or **OUT1** key, turn the encoder wheel to select an input gain value and release the key.

The setting applies in real-time when turning the encoder wheel.



Value setting resolution

- ▶ Turn the encoder wheel to obtain a 0.1-step resolution.
- ▶ Press and turn the encoder wheel to obtain a 1-step resolution.

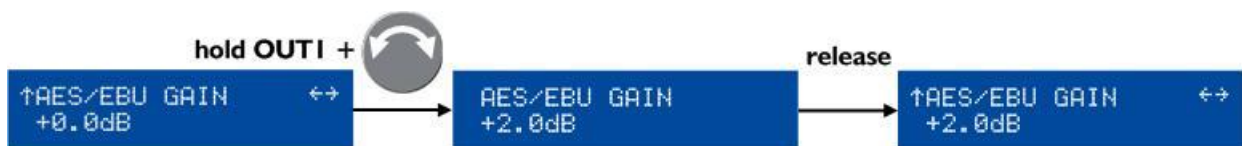

Figure 37: Setting the AES/EBU GAIN

5.10 MONITORING & INFO

This menu provides real-time measurements to monitor the output channels and provides the versions of embedded software. In more details, the **MONITORING & INFO** menu allows to:

- Display in real-time the RMS output voltage and output temperature for each output channel. The output voltage is given in percentage of the maximum value supported by the particular transducer section connected. The temperature is given in percentage of the operating range.
- Display the firmware and factory preset library versions.
- Display the controller's MAC address.

Figure 38 shows all pages of the **MONITORING & INFO** menu. Each one is detailed in sections from 5.10.1 to 5.10.5.

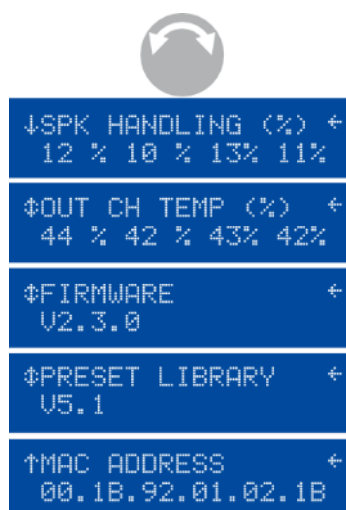

Figure 38: MONITORING & INFO menu page

5.10.1 SPK HANDLING (%)

This page displays the RMS voltage measured at each individual amplifier circuit output as a percentage of the maximum voltage supported by the particular speaker section connected to it.

For example, in Figure 38 the RMS voltage of channels **OUT 1** to **OUT 4** is respectively 12, 10, 13, and 11 % of the maximum values.

5.10.2 OUT CH TEMP (%)

This page displays the temperature of each individual amplifier channel circuit as a percentage of the maximum operating temperature: 85°C = 100 %.

For example, in Figure 38 the temperature of channels **OUT 1** to **OUT 4** is respectively 44, 42, 43, and 42 %.

LA8 Amplified Controller user manual

version 12.0

5.10.3 FIRMWARE

This page displays the version of LA8 firmware in use in the controller.

For example, Figure 38 shows LA8 firmware version **2.3.0**.

Press the encode wheel to display the full version number and the build date (format is YYYYMMDD).

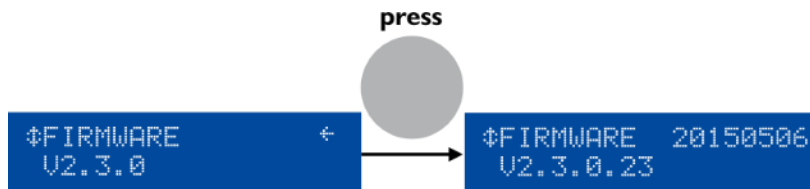

Figure 39: Displaying the full firmware version number and build date



Network

Always ensure that all LA8 amplified controllers used in a given network run the same firmware version.

5.10.4 PRESET LIBRARY

This page displays the version of the preset library in use in the controller.

For example, Figure 38 shows preset library version **5.1**.

Press the encoder wheel to display the full version number.

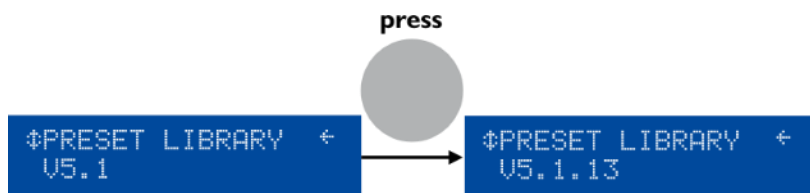

Figure 40: Displaying the full preset library version number



PRESET LIBRARY description

Refer to the **PRESET GUIDE** for full description of the factory presets.

5.10.5 MAC ADDRESS

This page displays the MAC (Media Access Control) address of the amplified controller. This address (unique to each controller) is the equivalent of a serial number and identifies the controller internationally. It is set by the manufacturer and cannot be modified.

For example, in Figure 38 the MAC address is **00:1B:92:01:02:1B**.

5.11 OPTIONS

This menu allows setting the amplified controller's general parameters. These parameters are the following:

- IP address.
- delay unit (ms, meters, feet or samples).
- LCD screen contrast.

An additional function allows resetting the amplified controller to its factory default state.

Figure 41 shows all pages of the **OPTIONS** menu. Each one is detailed in sections from 5.11.1 to 5.11.4.

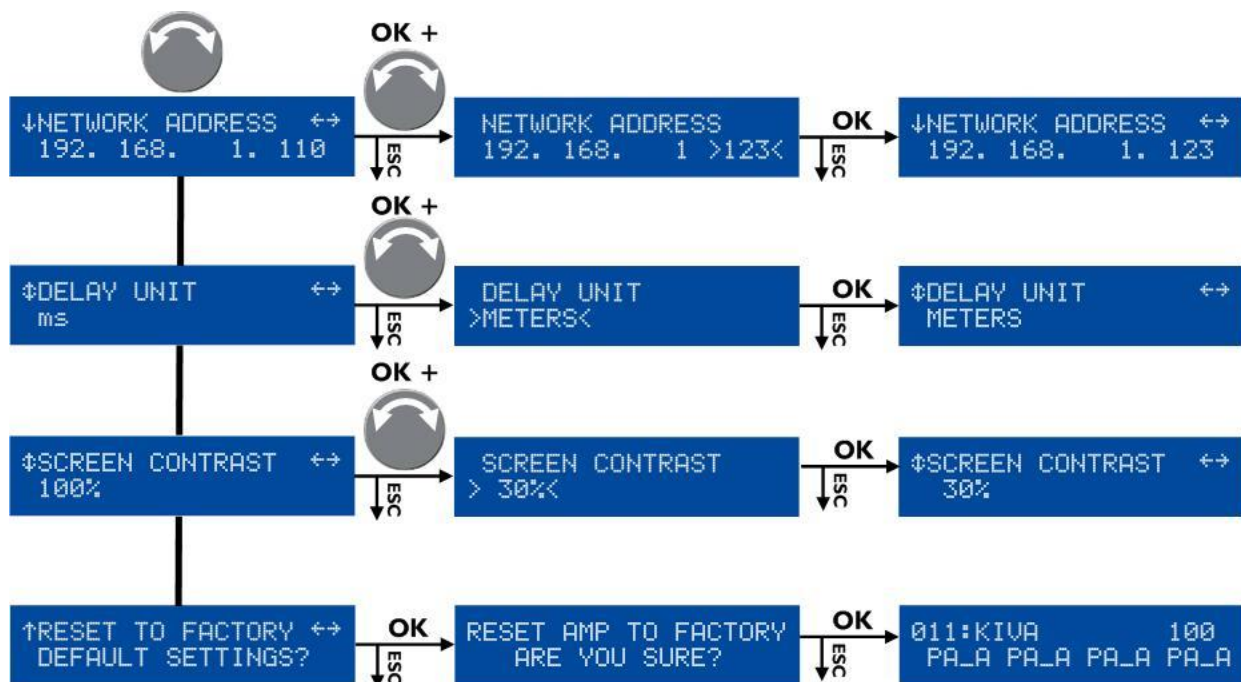

Figure 41: OPTIONS menu page

LA8 Amplified Controller user manual

version 12.0

5.11.1 NETWORK ADDRESS

Remote control of amplified controllers requires setting up a private local area Ethernet network to interconnect up to 253 units with a single control computer (and possible additional devices such as Ethernet switches). It is called L-NET and uses a proprietary communication protocol based on TCP/IPv4 called L-COM. The IP addresses on the units are class C addresses and must be set manually. The default subnet for L-NET is 192.168.1.0.



IP address setting

Each unit must be given an IP address that is not already in use by another device on the network.

For practical reasons, it is suggested to start numbering the units at **192.168.1.1** and then **192.168.1.2**, **192.168.1.3**, etc. and manually set the control computer on **192.168.1.254**.



An IP address is a unique identifier for a network device on a given IP network. In IPv4 networking, it is made of 4 bytes. In class C private local area IP subnets, the three first bytes are the network prefix and the last byte is the device identifier on the subnet. Regarding device identifiers, two numbers are reserved: 0 for designating the subnet, and 255 to communicate with all devices of the subnet (aka the IP broadcast address).

To select the IP address of a controller, follow these steps:

- ▶ From the main menu select **OPTIONS** and press the **OK** key or the encoder wheel (or **ESC** to abort).
- ▶ Press the **OK** key or the encoder wheel to enter the **NETWORK ADDRESS** page (or **ESC** to abort).
- ▶ Turn the encoder wheel to select a value for the last byte.



Value setting resolution

- ▶ Turn the encoder wheel to obtain a 1-step resolution.
 - ▶ Press and turn the encoder wheel to obtain a 10-step resolution.
- ▶ Press the **OK** key to validate the setting (or **ESC** to abort).

For example, in Figure 41 the IP address has been modified from **192.168.1.110** to **192.168.1.123**.



Subnet modification

According to the network administration requirements the default subnet (192.168.1.0) can be modified entering new values for the three first bytes as follows:

- ▶ Long-click on the key located just below the number to modify until it is selected.
- ▶ Turn the encoder wheel to select a new value and press the **OK** key to validate.
- ▶ Repeat the procedure for all numbers to modify.



5.11.2 DELAY UNIT

Delay values can be displayed in **ms** (milliseconds), **SAMPLES**, **METERS** or **FEET**. The values in meters or feet are given for a temperature of 20 °C.

To select the delay unit follow these steps:

- ▶ From the main menu select **OPTIONS** and press the **OK** key or the encoder wheel (or **ESC** to abort).
- ▶ Turn the encoder wheel to select **DELAY UNIT**.
- ▶ Press the **OK** key or the encoder wheel to enter the page (or **ESC** to abort).
- ▶ Turn the encoder wheel to select the chosen setting.
- ▶ Press the **OK** key or the encoder wheel to validate the setting (or **ESC** to abort).

For example, in Figure 41 the delay unit has been modified from **ms** to **METERS**.

5.11.3 SCREEN CONTRAST

To set the LCD screen contrast follow these steps:

- ▶ From the main menu select **OPTIONS** and press the **OK** key or the encoder wheel (or **ESC** to abort).
- ▶ Turn the encoder wheel to select **SCREEN CONTRAST**.
- ▶ Press the **OK** key or the encoder wheel to enter the page (or **ESC** to abort).
- ▶ Turn the encoder wheel to select a value between **0** and **100 %**.
- ▶ Press the **OK** key or the encoder wheel to validate the setting (or **ESC** to abort).

For example, in Figure 41 the screen contrast has been modified from **100 %** to **30 %**.

5.11.4 RESET TO FACTORY DEFAULT SETTINGS?

To reset the amplified controller to its factory default settings follow these steps (see Figure 41):

- ▶ From the main menu select **OPTIONS** and press the **OK** key or the encoder wheel (or **ESC** to abort).
- ▶ Turn the encoder wheel to select **RESET TO FACTORY DEFAULT SETTINGS?**

The controller displays **RESET AMP TO FACTORY, ARE YOU SURE?**

- ▶ Press the **OK** key or the encoder wheel to confirm (or **ESC** to abort).
The start-up sequence is launched (refer to section 5.1). When complete, the main screen is displayed with the default preset memory (011) and IP address (100), indicating that the amplified controller has returned to its factory default settings and that all user memories have been deleted.

Disconnect the controller from LA Network Manager

It is recommended to disconnect the controller from LA Network Manager before using **RESET TO FACTORY DEFAULT SETTINGS?**

In the contrary case, if a virtual unit is present in the workspace at IP address 100 with a preset of same family as preset 011, its parameters will automatically be loaded to the controller after reset and restart.

LA8 Amplified Controller user manual

version 12.0

APPENDIX A: PROTECTION SYSTEMS

The LA8 electronic vital parts are continuously monitored by the embedded operating system to optimize the power resources while ensuring safety even under extreme conditions. Each time a protection system is activated, a warning message blinks on screen and the **L-NET** LED also blinks in red.



Remote monitoring

In LA Network Manager the activation of a protection system is indicated by an event message (refer to the **LA Network Manager video tutorial**).

Mains

Mains voltage

The LA8 amplified controller uses an auto-sensing SMPS (Switched Mode Power Supply) compatible with mains input nominal voltages of 120 / 230 V $\pm 10\%$ (LA8, LA8US) or 100/200 V $\pm 10\%$ (LA8JP). The mains voltage is continuously monitored for under and over-voltage as well as for failure in alternating cycles.

If the mains voltage reaches a value 30 % below nominal or 10 % above nominal, or if it skips about two cycles, the SMPS is switched off and the outputs are muted.

The controller displays **Waiting SMPS**, see the figure on the right.

A soft start sequence will automatically be engaged as soon as the mains voltage returns to nominal state.

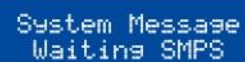

System Message
Waiting SMPS

If the mains voltage reaches a value between 30 % and 20 % below nominal, the outputs are muted and the controller displays **Fuseprotect**, see the figure on the right.

Normal operation will resume as soon as the mains voltage returns to nominal state.

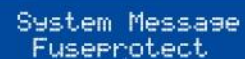

System Message
Fuseprotect

Mains current

The SMPS is continuously monitored for current peaks and over-current.

The average mains current can peak temporarily at values several times higher than the nominal value supported by the internal fuse of the controller.

If the current peaks too frequently, the amplitude of the output signals are attenuated by 1 to 6 dB in order to prevent the SMPS fuse from blowing.

The controller displays **Fuseprotect**, see the figure on the right.

The protection will automatically be disengaged as soon as the mains current returns to supported conditions.

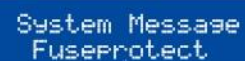

System Message
Fuseprotect

If an over-current is detected the SMPS is switched off and the controller displays **Waiting SMPS**, see the figure on the right.

A soft start sequence will automatically be engaged when the SMPS returns to nominal state.



System Message
Waiting SMPS

Output channels

Output channel temperature

The fans associated to the heat sinks operate permanently, but as long as the temperature remains below 40 °C they run at their slowest speed and can hardly be heard. The highest detected temperature controls the speed of the fans. Above 40 °C the speed is increased until it reaches its maximum value.

If a temperature of more than **85 °C** is detected at output channel **x**, the signal delivered at this output channel is attenuated and the controller displays **High Temperature Chx**, see the figure on the right.

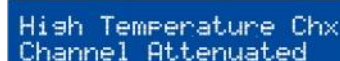

If the temperature exceeds **96 °C**, channel **x** is muted and the controller displays **Over Temperature Chx**, see the figure on the right.

In both cases the protection will automatically be disengaged when the temperature returns to nominal state.



Output channel DC voltage

The output channels are continuously monitored for sustained presence of DC voltage above a threshold of 3 V.

If a sporadic DC voltage is detected at output channel **x** this channel is muted and the controller displays **DC on Channel x**, see the figure on the right. The channel will automatically be unmuted when returning to nominal state.

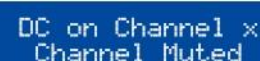

If a persistent DC voltage is detected at output channel **x** this channel is disabled and the controller displays **DC on Channel x**, see the figure on the right.

After the issue has been solved, the controller must be restarted manually to reactivate channel **x**.

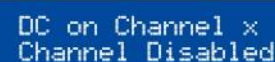

Output channel current

The output channels are continuously monitored for unexpected current values (error).

If an external error is detected at output channel **x** (typically due to a short-circuit in a cable) this channel is muted and the controller displays **Error on Channel x**, see the figure on the right.

The channel will automatically be unmuted as soon as the issue is solved.

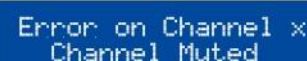

If an internal error is detected at output channel **x** (typically due to a cross-conduct in the power stage) this channel is disabled and the controller displays **Error on Channel x**, see the figure on the right.

For safety reasons all other channels are also disabled.

The controller must be sent to an L-Acoustics® representative for maintenance.

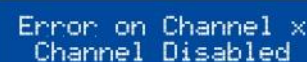

Speakers

The L-DRIVE transducer protection system provides a dual analysis of both signal intensity and voltage in real time and RMS. Under extreme conditions, when component membranes reach the over-exursion zone or if the coil ensemble temperature reaches a critical point, L-DRIVE is activated and acts as a power regulator.

As a result, the amount of power delivered at any channel is adjusted to the dynamic and thermal capacity of each individual transducer.

LA8 Amplified Controller user manual

version 12.0

Other system messages

If the amplified controller detects a connection attempt from a version of **LA Network Manager** that is not compatible with the unit firmware (typically because the version of **LA Network Manager** is too old to manage the latest firmware features), the amplified controller displays **Invalid L-NET client**.

A blue rectangular box with white text that reads "System Message" on the first line and "Invalid L-NET client" on the second line.

```
System Message
Invalid L-NET client
```

Update **LA Network Manager** to version 2.3.0.0 minimum.

APPENDIX B: APPROVALS

EC declaration of conformity

L-Acoustics

13 rue Levacher Cintrat
Parc de la Fontaine de Jouvence
91462 Marcoussis Cedex
France

states that the LA8 is in conformity with the provisions of:

2006/95/EC: Low Voltage Directive

2004/108/EC: Electro-Magnetic Compatibility Directive

Applied standards:

EN 60065:2002+A1:2006+A11:2008+A2:2010+A12:2011 Safety requirements for audio, video and similar electronic apparatus

EN55103-1: 2009+A1:2012 Electromagnetic compatibility - Product family standard for audio, video, audio-visual and entertainment lighting control apparatus for professional use - Part 1: Emissions

EN55103-2: 2009 Electromagnetic compatibility - Product family standard for audio, video, audio-visual and entertainment lighting control apparatus for professional use - Part 2: Immunity

CE marking date: 2008

Issued in Marcoussis, France

01/12/2012



Genio KRONAUER, Electronics Director

Additional approvals

The LA8 amplified controller holds the following certificates:
CCC and cTUVus



LA8 Amplified Controller

user manual

version 12.0

APPENDIX C: SPECIFICATIONS

GENERAL

Output power EIA (1% THD, 1 kHz, all channels driven)	8 Ω	4 x 1100 W RMS	4 x 1300 W peak				
	4 or 2.7 Ω	4 x 1800 W RMS	4 x 2500 W peak				
Max output voltage	150 V (Peak voltage, no load)						
Circuitry	Class D						
Digital Signal Processor (DSP)	SHARC 32 bit, floating point, 96 kHz sampling rate						
Frequency range	20 Hz-20 kHz (±0.15 dB at 8 Ω)						
Distortion THD+N	< 0.05 % (20 Hz-10 kHz, 8 Ω, 11 dB below rated power)						
Output dynamic range	107 dB (20 Hz-20 kHz, 8 Ω, A-weighted)						
Amplification gain	32 dB						
Noise level	-67 dBV (20 Hz-20 kHz, 8 Ω, A-weighted)						
Channel separation	> 85 dB (at 1 kHz)						
Damping factor	> 600 (8 Ω, 1 kHz and below)						
Mains input power and current draw (all channels driven)	Maximum output power		Mains input power and current draw				
	Load	Nb. of driven channels	Power per channel	1/3 Output Power (-5 dB)	1/8 Output Power (-9 dB)	IDLE	Standby
	4 Ω	4	1800 W	22 A / 3100 W	11 A / 1500 W	0.5 A / 115 W	< 0.1 A / 12 W
8 Ω	4	1100 W	15 A / 1950 W	10 A / 1300 W			
Current values given for a mains rated at 230 V. Multiply by 2 for 120 V, 1.15 for 200 V and 2.3 for 100 V. If the voltage outside a plus or minus 10 % range the maximum power is no longer guaranteed.							
Mains ratings	LA8 & LA8US		120/230 V AC (±10 %), 50-60 Hz				
	LA8JP		100/200 V AC (±10 %), 50-60 Hz				
Operating temperature	Room temperature		from 0 °C to +50 °C				
	Inside controller		from 0 °C to +85 °C				
Circuits protection	temperature monitoring of transformers and heat-sinks inrush-current limitation mains supply failure and over-voltage detection output DC protection output over current protection						
Transducers protection	L-DRIVE thermal and over excursion protection						
Fans	2 fans, temperature-controlled speed						
Fans noise (free field, 1m)	At minimum speed		24 dBA				
	At maximum speed		42 dBA				
Indicators	4 meters including Load, Signal, Level and Clip LED L-NET presence LED 4 mute LED						
Output Connectors	2 x 4-point SpeakON®		OUT1/2 and OUT3/4				
	1 x 8-point CA-COM®		OUT1 to OUT4				
L-NET connectors	2 x Fast Ethernet RJ45 (in/out)						



ANALOG INPUT

Connectors	Input	2 Neutrik® female XLR3, IEC 268, ESD protected
	Link	2 Neutrik® male XLR3, IEC 268, ESD protected
Input impedance	22 kΩ (balanced)	
Max input level	22 dBu (balanced, THD 1 %)	
Latency	3.84 ms	
	1.19 ms with low latency presets	
Digital conversion	two cascaded 24 bit A/D converters (130 dB dynamic range)	

DIGITAL INPUT

Connectors	Input	1 Neutrik® female XLR3, IEC 268, ESD protected
	Link	1 Neutrik® male XLR3, IEC 268, ESD protected, electronically buffered, failsafe relay
	USB	1 Mini-B type female USB, reserved for future applications
Supported input formats	Standard	AES/EBU (AES3) or electrical S/PDIF (IEC 60958 Type II)
	Sampling frequency (Fs)	44.1, 48, 64, 88.2, 96, 128, 176.4, or 192 kHz
	Word length	16, 18, 20, or 24 bits
Input gain	Adjustable from -12 dB to +12 dB by 0.1 dB steps	
Latency	3.84 ms (upon user selection, independent of the input sampling frequency)	
	1.19 ms with low latency presets (independent of the input sampling frequency)	
Sample Rate Converter (SRC)	Sampling frequency	96 kHz (SRC referenced to the amplified controller internal clock)
	Word length	24 bits
	Dynamic range	140 dB
	Distortion (THD+N)	< -120 dBfs
	Bandpass ripple	±0.05 dB (20 Hz-40 kHz, 96 kHz)
AES/EBU to ANALOG fallback	Switchover conditions	no clock loss of lock CRC error bipolar encoding error or data slip
	Constant delay	yes (upon user selection, independent of input Fs)
	Constant level	yes (upon user setting of AES/EBU in gain, independent of input Fs)
	Revert to AES/EBU	manual user selection

LA8 Amplified Controller

user manual

version 12.0

PHYSICAL DATA

Dimensions
(H x W x D) 88 (2U) x 483 x 420 mm / 3.5 (2U) x 19 x 16.5 in

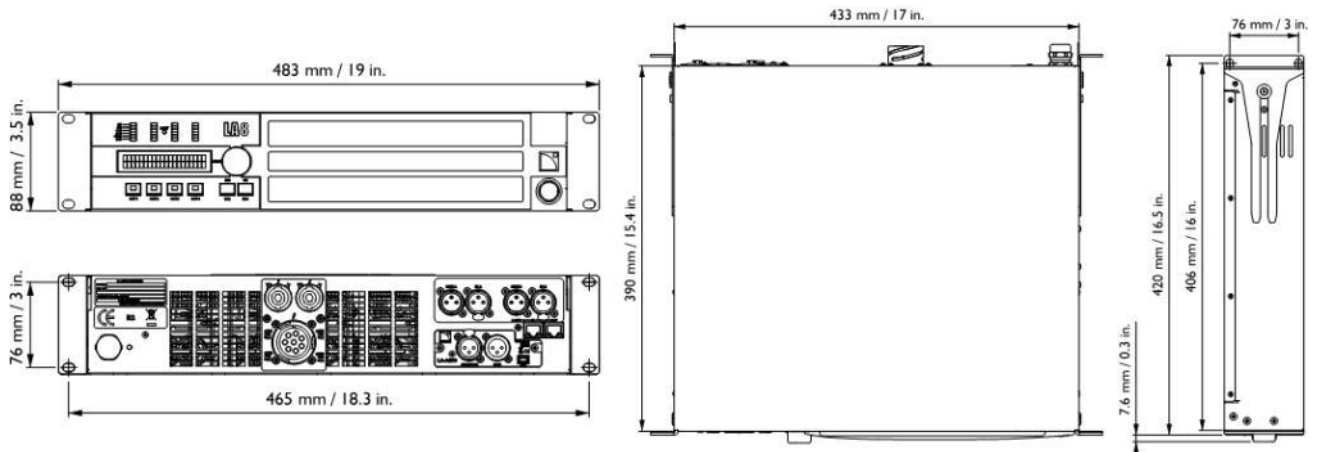

Weight 12.2 kg / 26.9 lb

Finish black and anthracite gray



Document reference: LA8_UM_EN_12.0

Distribution date: February 3, 2016

© 2016 L-Acoustics®. All rights reserved.

**No part of this publication may be reproduced or transmitted in any form
or by any means without the express written consent of the publisher.**