

<b>TABLE OF CONTENTS</b>	<b>Safety</b>	
	General instructions .....	2
	Warnings and installation precautions .....	2
	General information .....	3
	<b>1 Introduction</b>	
	1.1 Description .....	4
	1.2 Technical specifications .....	4
	1.3 Operating elements and connections .....	6
	<b>2 Installation</b>	
	2.1 Mounting .....	7
	<b>3 Functions and settings</b>	
	3.1 Operation .....	8
	3.2 Basic setup .....	8
	3.3 Recharge .....	8
	3.4 Menu structure .....	9
	3.5 Auto Show .....	10
	3.6 Show speed .....	10
	3.7 Static color .....	10
	3.8 Sound mode .....	11
	3.9 Microphone sensitivity .....	11
	3.10 Manual color .....	11
	3.11 IR setup .....	11
	3.12 Wireless setup .....	11
	3.13 Dimmer mode .....	12
	3.14 Linking .....	12
	3.15 DMX mode .....	12
	3.16 DMX addressing .....	12
	3.17 Connection of the DMX line .....	14
	3.18 Construction of the DMX termination .....	14
	3.19 DMX control .....	15
	<b>4 Maintenance</b>	
	4.1 Maintenance and cleaning the unit .....	16
	4.2 Fuse replacement .....	16
	<b>Warranty</b>	

---

<b>Packing content</b>	<ul style="list-style-type: none"> <li>• SMARTBAT</li> <li>• Power cable</li> <li>• Weatherproof cover</li> <li>• User manual</li> </ul>
------------------------	--

---



**WARNING!** Before carrying out any operations with the unit, carefully read this instruction manual and keep it with care for future reference. It contains important information about the installation, usage and maintenance of the unit.



## SAFETY

### General instruction

- The products referred to in this manual conform to the European Community Directives and are therefore marked with  $\text{CE}$ .
- Supply voltage of this product is DC24V; never connect directly to AC220V. Leave servicing to skilled personnel only. Never make any modifications on the unit not described in this instruction manual, otherwise you will risk an electric shock.
- Connection of the power adapter must be made to a power supply system fitted with efficient earthing (Class I appliance according to standard EN 60598-1). It is, moreover, recommended to protect the supply lines of the units from indirect contact and/or shorting to earth by using appropriately sized residual current devices.
- The connection to the main network of electric distribution must be carried out by a qualified electrical installer. Check that the voltage correspond to those for which the unit is designed as given on the electrical data label.
- This unit is not for home use, only professional applications.
- Never use the fixture under the following conditions:
  - in places subject to vibrations or bumps;
  - in places subject to excessive humidity.
- Make certain that no inflammable liquids, water or metal objects enter the fixture.
- Do not dismantle or modify the fixture.
- All work must always be carried out by qualified technical personnel. Contact the nearest sales point for an inspection or contact the manufacturer directly.
- If the unit is to be put out of operation definitively, take it to a local recycling  plant for a disposal which is not harmful to the environment.

### Warnings and installation precautions

- If this device will be operated in any way different to the one described in this manual, it may suffer damage and the guarantee becomes void. Furthermore, any other operation may lead to dangers like short circuit, burns, electric shock, etc.
- Before starting any maintenance work or cleaning the projector, cut off power from the main supply.
- Always additionally secure the projector with the safety rope. When carrying out any work, always comply scrupulously with all the regulations (particularly regarding safety) currently in force in the country in which the fixture's being used.
- Install the fixture in a well ventilated place.
- Keep any inflammable material at a safe distance from the fixture.
- Shields, lenses or ultraviolet screens shall be changed if they have become damaged to such an extent that their effectiveness is impaired.
- The lamp (LED) shall be changed if it has become damaged or thermally deformed.
- Never look directly at the light beam. Please note that fast changes in lighting, e. g. flashing light, may trigger epileptic seizures in photosensitive persons or persons with epilepsy.
- Do not touch the product's housing when operating because it may be very hot.

---

**GENERAL INFORMATION****Shipments and claims**

The goods are sold "ex works" and always travel at the risk and danger of the distributor. Eventual damage will have to be claimed to the freight forwarder. Any claim for broken packs will have to be forwarded within 8 days from the reception of the goods.

**Warranty and returns**

The guarantee covers the fixture in compliance with existing regulations. You can find the full version of the "General Guarantee Conditions" on our web site [www.musiclights.it](http://www.musiclights.it). Please remember to register the piece of equipment soon after you purchase it, logging on [www.musiclights.it](http://www.musiclights.it). The product can be also registered filling in and sending the form available on your guarantee certificate. For all purposes, the validity of the guarantee is endorsed solely on presentation of the guarantee certificate. Music & Lights will verify the validity of the claim through examination of the defect in relation to proper use and the actual validity of the guarantee. Music & Lights will eventually provide replacement or repair of the products declining, however, any obligation of compensation for direct or indirect damage resulting from faultiness.

## - 1 - INTRODUCTION

### 1.1 DESCRIPTION

SMARTBAT is a portable battery-powered uplighter designed as accent luminaire for all kind of events. SMARTBAT is equipped with a lithium battery pack and a built-in WiFi module for cable-free operation. The ultra-compact and lightweight design makes this projector truly portable and rechargeable countless times without "memory effect". The internal battery has an autonomy for 12 hours in color change mode and up to 8 hours in full output, while the charging time is only 5 hours. The light source is composed of 4x10W high-power RGBW LEDs / fullcolor for a color calibration in the full-spectrum and the extractable foot allows you to adjust the angle of the beam to assist tracking operations. The transmission of the DMX signal is via WiFi technology, the transmission unit WIFIBOX is compatible with any DMX controller or through the application SMARTCOLORS available for any Android or IOS smartphone.

### 1.2 TECHNICAL SPECIFICATIONS

#### Light source and optics

- 4x10W RGBW/FC LED
- Lux @ 3 m: 950
- Energy-saving LEDs featuring more vivid colours and lower power consumption compared to traditional lamps
- Colour synthesis: RGBW/FC color mixing (>16 million colours) for a limitless colour range
- White temperature presets: 3200K~10000K
- Beam angle: 15°
- Field angle: 30°
- LEDs average life span: >50'000 h

#### Electronics and features

- Several DMX selectable configurations (4, 6, 10 channels) for advanced or basic controlling:
  - 4 channels: RGBW
  - 6 channels: dimmer, RGBW, strobe
  - 10 channels: dimmer, RGBW, macro, strobo, auto programs, programs speed, dimmer curve
- WDMX: Built-in Wifi receiver
- IR controller: infra-red sensor controlled by remote
- 4 char LED display user interface for auto programs execution, static colour mode, creation of custom shows
- 4 different dimming curves available
- Master/Slave mode for stand-alone operations of more units
- Linear and "stepless" transition between DMX values
- Flicker free operations (400Hz)
- Silent operations, due to natural cooling of the peculiar chassis and to absence of fans

#### Structure and Power supply

- Protection: IP44
- Sturdy die-cast aluminium body conceived for long-time durability and demanding applications
- Tempered glass front panel
- Battery: 24V, Lithium
- Battery autonomy: 12 hours (color change mode), 8 hours (permanent white full-on)
- Recharge time: 5 hours max
- LED battery status indicator

- Load/Storage battery switch
- Dmx connections: XLR 3p Input/Output
- Ergonomic carrying handle for transportation and positioning
- Adjustable foot support for tilt regulation (up to 20°)
- Power unit: 100-240V 50/60Hz
- Working temperature: 0/+35°
- Weight: 3,4 kg
- Dimensions (WxHxD): 137.8x184x145 mm

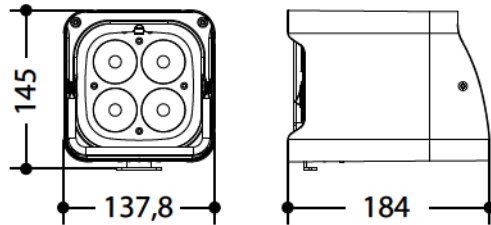

Fig.1

**Photometric data**

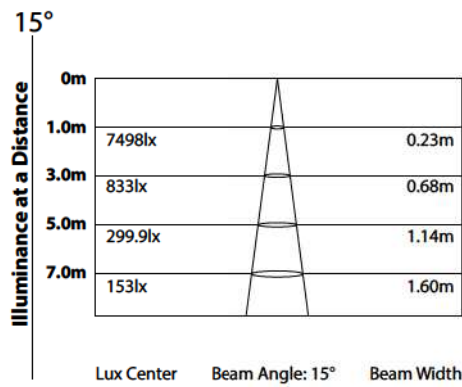
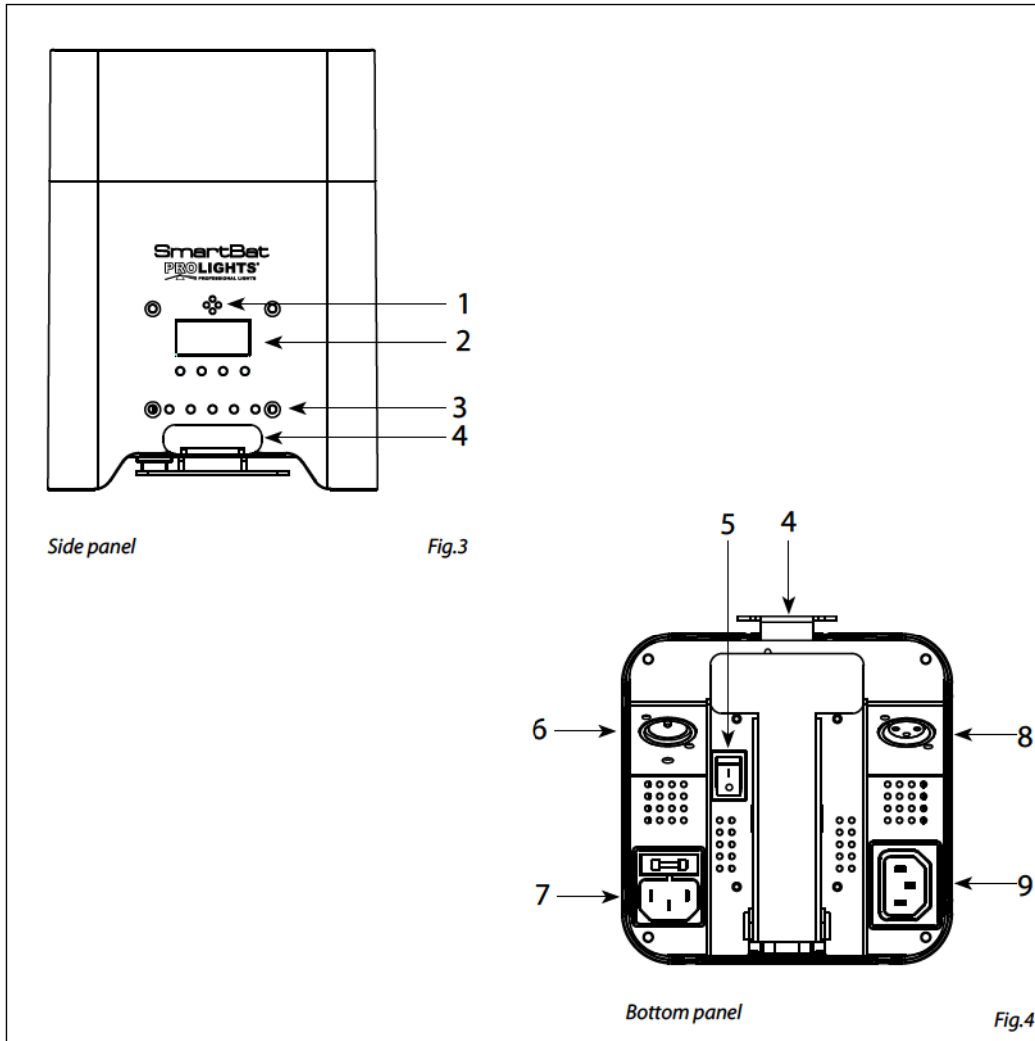

Fig.2

## 1.3 OPERATING ELEMENTS AND CONNECTIONS



1. MICROPHONE to control the show by the external audio signal.
2. CONTROL PANEL with display and 4 button used to access the control panel functions and manage them.
3. POWER STATUS:  
RED: charging the battery.  
GREEN: battery charge.
4. Adjustable foot support for tilt regulation (up to 20°).
5. ON/OFF SWITCH
6. DMX IN (3-pole XLR):  
1 = ground, 2 = DMX -, 3 = DMX +.
7. DMX OUT (3-pole XLR):  
1 = ground, 2 = DMX -, 3 = DMX +.
8. POWER IN mains plug for connection to a socket (100-240V 50/60Hz) via the supplied mains cable. The support for the mains fuse is located near the mains plug. Only replace a blown fuse by one of the same type.
9. POWER OUT: connect to supply power to the next unit.

## - 2 - INSTALLATION

### 2.1 MOUNTING

SMARTBAT may be set up on a solid and even surface. The unit can also be mounted upside down to a cross arm. For fixing, stable mounting clips are required. The mounting place must be of sufficient stability and be able to support a weight of 10 times of the unit's weight.

When carrying out any installation, always comply scrupulously with all the regulations (particularly regarding safety) currently in force in the country in which the fixture's being used.

#### IMPORTANT

Always additionally secure the projector with the safety rope from falling down. For this purpose, fasten the safety rope at a suitable position so that the maximum fall of the projector will be 20 cm.

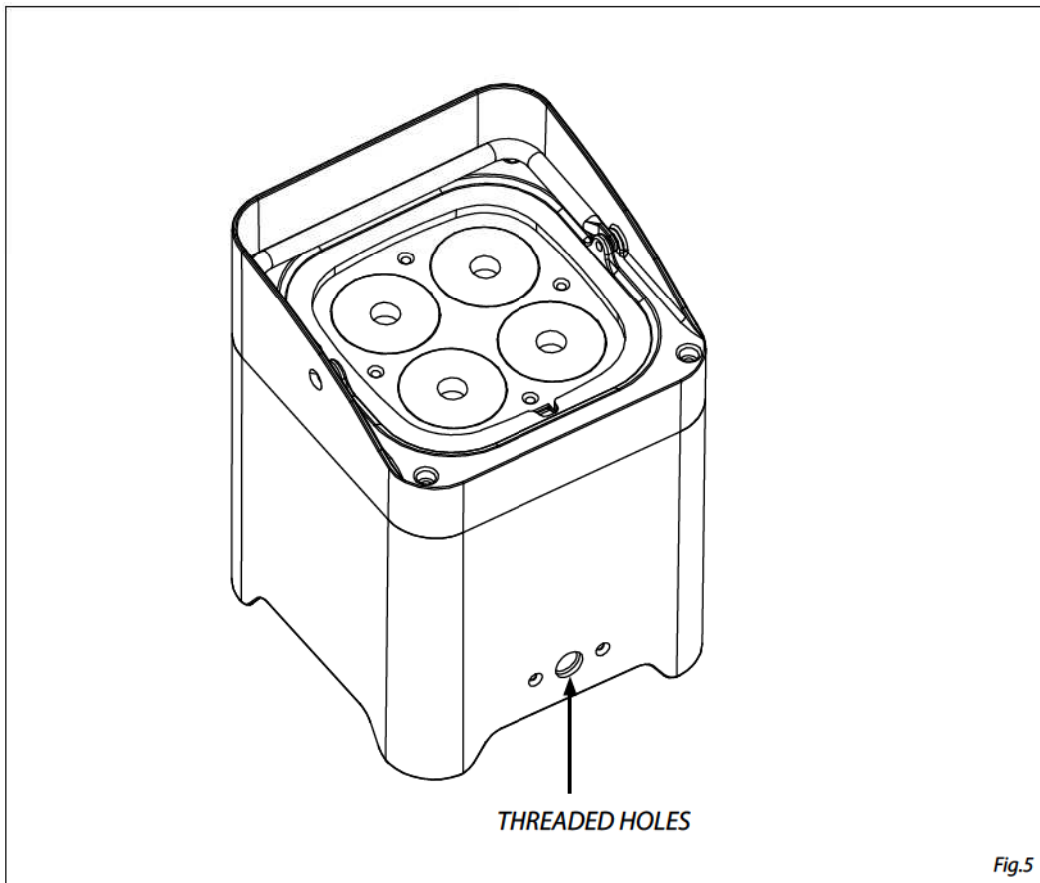

## - 3 - FUNCTIONS AND SETTINGS

### 3.1 OPERATION

Switch on the SMARTBAT with the power switch. The unit is ready for operation and can be operated via a DMX controller or it independently performs its show program in succession. After operation, switch off the unit with the power switch.

### 3.2 BASIC SETUP

The SMARTBAT has a LED display and 4 buttons for access to the functions of the control panel (fig. 6).

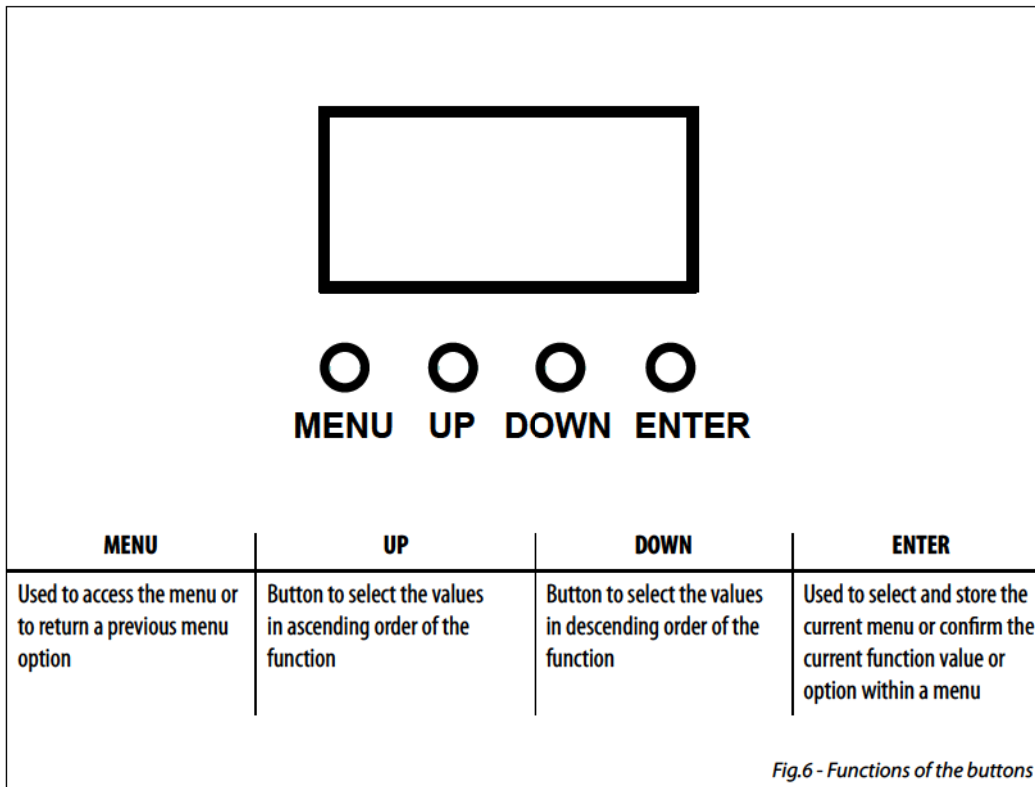

### 3.3 RICHARGE

To recharge SMARTBAT, plug the power cable into a mains socket (100-240V ~ / 50-60Hz).

NOTE - The charging time are 5 h and autonomy is 8h



## 3.4 MENU STRUCTURE

	MENU (LEVEL 1)	(LEVEL 2)	(LEVEL 3)
1	4 CH	d1 ~ d512	
2	6 CH	d1 ~ d512	
3	10 CH	d1 ~ d512	
4	C--	C1 C2 C3 C4 C5 C6 C7 C8 C9 C10 C11 C12 C13 C14 C15	
5	P--	P1 P2 P3 P4	
6	S--	S1 ~ S100	
7	Snd		
8	Sens	u0 ~ u100	
9	U--	r0 ~ r255 g0 ~	

		g255 b0 ~ b255 wo ~ w255	
10	dim	OFF dim1 dim2 dim3	
11	SET	ON OFF	
12	S-tr	drAS drCH  dtAS dtCH	drAU dr 1 ~ dr16 dtAU dt 1 ~ dt16

### 3.5 AUTO SHOW

This fixture has a built-in automatic program. To access this, please see the below instructions:

- Press the button MENU so many times until shows [P-].
- Press the button ENTER to confirm.
- Using UP/DOWN button, select one of the programs [P1 - P4].
- Press the button ENTER save the setting.

### 3.6 SHOW SPEED

To set the show speed refer to the following steps:

- Press the button MENU so many times until shows [S-].
- Using UP/DOWN button, select one of the programs [S1 - S100].
- Press the button ENTER save the setting.

### 3.7 STATIC COLOR

This fixture has the ability to accept custom static color settings. Access these chases via the control panel on the back of the fixture.

- Press the button MENU so many times until shows [C-].
- Press the button ENTER to confirm.
- Using UP/DOWN button, select one of the programs [C1 - C15].
- Press the button ENTER save the setting.

### 3.8 SOUND MODE

To set the sound mode refer to the following steps:

- Press the MENU button so many times until the display shows [Snd].
- Press the ENTER button for save the setting.

### 3.9 MICROPHONE SENSITIVITY

To set the microphone sensitivity refer to the following steps:

- Press the button MENU so many times until shows [Sens].
- Using UP/DOWN button, select one of the programs [u1 - u100].
- Press the button ENTER save the setting.

### 3.10 MANUAL COLOR

This mode allows to combine the colors red, green, blue and white (r, g, b).

- Press the button MENU so many times until the display shows [U-], then press the button ENTER.
- Select the color (r, g, b) through the buttons UP/DOWN.
- Press the button ENTER to confirm.
- Using UP/DOWN button, select the desired color value [000 - 255].
- Press ENTER button to continue to the next color.
- Continue until the desired mix is obtained.
- Press the MENU button to go back or to meet the waiting time to exit the setup menu.

### 3.11 IR SETUP

To start up the IR receiver refer to the following steps:

- Press the MENU button so many times until the display shows [Set].
- Press the ENTER button to confirm.
- Press the UP/DOWN button, select one of the programs [ON] or [OFF].
- Press the ENTER button for save the setting.

NOTE - Make sure to point the controller directly at the receiver on the product.

### 3.12 WIRELESS SETUP

For the auto transmit mode:

- Press the MENU button so many times until the display shows [S-tr].
- Press the ENTER button to confirm.
- Press the UP/DOWN button and select [dtAS].
- Press the ENTER button to confirm.
- Press the ENTER button again to confirm [dtAU].

For the auto receive mode:

- Press the MENU button so many times until the display shows [S-tr].
- Press the ENTER button to confirm.
- Press the UP/DOWN button and select [drAS].
- Press the ENTER button to confirm.
- Press the ENTER button again to confirm [drAU].

For the manual transmit mode:

- Press the MENU button so many times until the display shows [S-tr].

- Press the ENTER button to confirm.
- Press the UP/DOWN button and select **[dtCH]**.
- Press the ENTER button to confirm.
- Press the UP/DOWN button, select one of the transmitting signal **[dt 1 - dt 16]**.
- Press the ENTER button for save the setting.

For the manual receive mode:

- Press the MENU button so many times until the display shows **[5-tr]**.
- Press the ENTER button to confirm.
- Press the UP/DOWN button and select **[drCH]**.
- Press the ENTER button to confirm.
- Press the UP/DOWN button, select one of the transmitting signal **[dr 1 - dr 16]**.
- Press the ENTER button for save the setting.

### 3.13 DIMMER

- Enter in Dimmer mode to select specific dimming curve, press the button MENU so many times until shows **[DIM]**, and press the button ENTER to confirm.
- Press the button UP/DOWN to select **[OFF - DIM1 - DIM2 - DIM3]**.
- Press ENTER button to store.
- Press the MENU button to go back or to meet the waiting time to exit the setup menu.

### 3.14 LINKING

1. Connect the DMX OUT of the master unit via 3-pole XLR cable to the DMX IN of the first slave unit.
2. Connect the DMX OUT of the first slave unit to the DMX IN of the second slave unit, etc. until all units are connected in a chain.

### 3.15 DMX MODE

- Press the button MENU so many times until shows, **[CH4]**, **[CH6]** or **[CH10]** and press the button ENTER to confirm.
- Press the button UP/DOWN to select the desired DMX address **[d001 - d512]**. Press and hold to scroll quickly. Press ENTER button to store.

The tables on page 15 indicate the operating mode and DMX value. The SMARTBAT is equipped with 3 pole XLR connections.

### 3.16 DMX ADDRESSING

To able to operate the SMARTBAT with a light controller, adjust the DMX start address for the first a DMX channel. If e. g. address 33 on the controller is provided for controlling the function of the first DMX channel, adjust the start address 33 on the SMARTBAT.

The other functions of the light effect panel are then automatically assigned to the following addresses. At the next page an example with the start address 33 is shown below:

Number of DMX channels	Start address (example)	DMX Address occupied	Next possible start address for unit No. 1	Next possible start address for unit No. 2	Next possible start address for unit No. 3
4	33	33-36	37	41	45
6	33	33-38	39	45	51
10	33	33-42	43	53	63

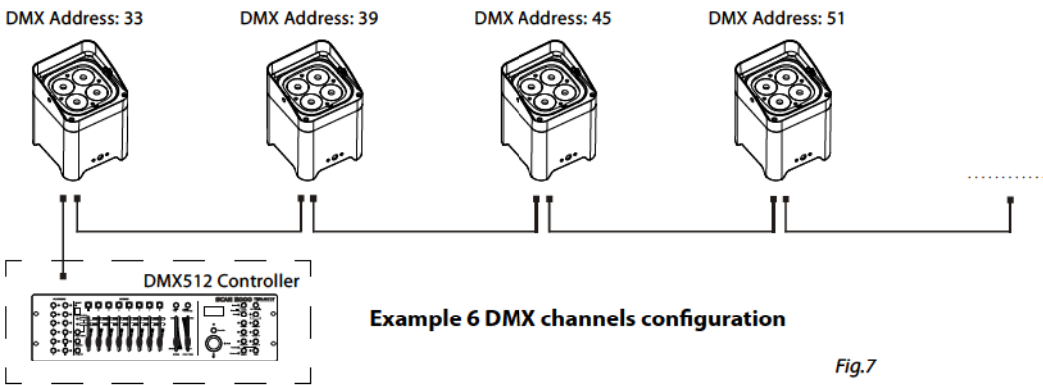

### 3.17 CONNECTION OF THE DMX LINE

DMX connection employs standard XLR connectors. Use shielded pair-twisted cables with  $120\Omega$  impedance and low capacity.

The following diagram shows the connection mode:

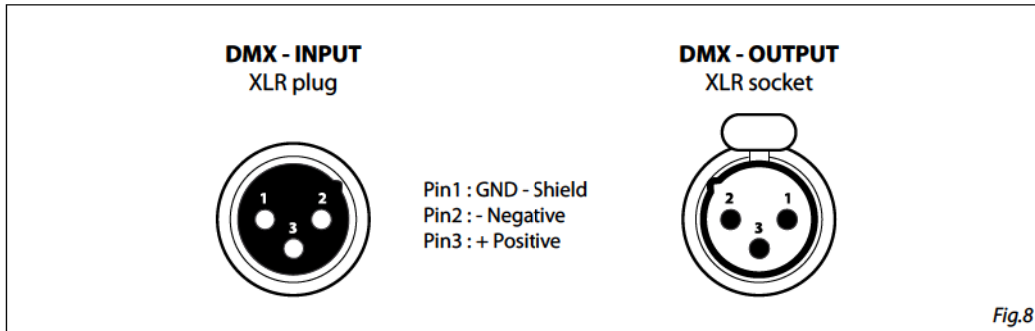

#### ATTENTION

The screened parts of the cable (sleeve) must never be connected to the system's earth, as this would cause faulty fixture and controller operation.

Over long runs can be necessary to insert a DMX level matching amplifier.

For those connections the use of balanced microphone cable is not recommended because it cannot transmit control DMX data reliably.

- Connect the controller DMX input to the DMX output of the first unit.
- Connect the DMX output to the DMX input of the following unit. Connect again the output to the input of the following unit until all the units are connected in chain.
- When the signal cable has to run longer distance is recommended to insert a DMX termination on the last unit.

### 3.18 CONSTRUCTION OF THE DMX TERMINATION

The termination avoids the risk of DMX 512 signals being reflected back along the cable when they reach the end of the line: under certain conditions and with certain cable lengths, this could cause them to cancel the original signals.

The termination is prepared by soldering a  $120\Omega$   $1/4 W$  resistor between pins 2 and 3 of the 5-pin male XLR connector, as shown in figure.

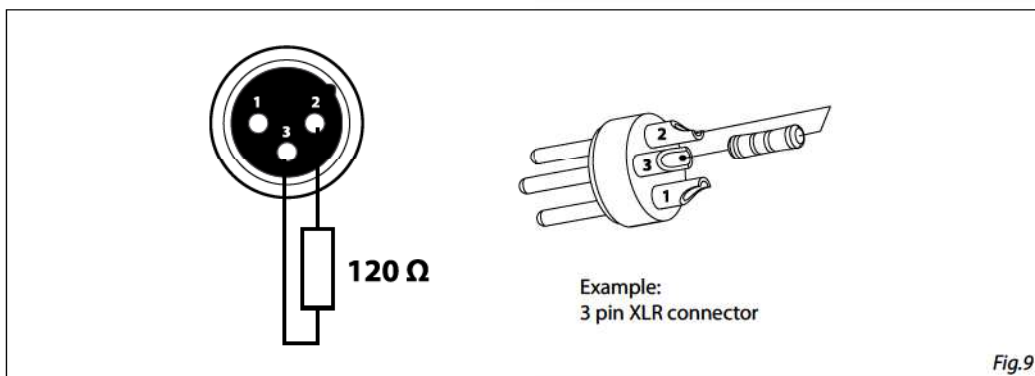

## 3.19 DMX CONTROL

MODE 10 Ch	FUNCTION	DMX Value
1	<b>DIMMER</b> 0~100%	000 - 255
2	<b>RED</b> 0~100%	000 - 255
3	<b>GREEN</b> 0~100%	000 - 255
4	<b>BLUE</b> 0~100%	000 - 255
5	<b>WHITE</b> 0~100%	000 - 255
6	<b>COLOR COLOR + COLOR TEMPERATURE</b>	
	No Function	000-010
	R 100% G 0~100% B 0	011-030
	R 100%~0 G 100% B 0	031-050
	R 0 G 100% B 0~100%	051-070
	R 0 G 100%~0 B 100%	071-090
	R 0~100% G 0 B 100%	091-110
	R 100% G 0 B 100%~0	111-130
	R 100% G 0~100% B 0~100%	131-150
	R 100%~0 G 100%~0 B 100%	151-170
	R 100% G 100% B 100% W 100%	171-200
	Color temperature 1	201-205
	Color temperature 2	206-210
	Color temperature 3	211-215
	Color temperature 4	216-220
Color temperature 5	221-225	
Color temperature 6	226-230	
Color temperature 7	231-235	
Color temperature 8	236-240	
Color temperature 9	241-245	
Color temperature 10	246-250	
Color temperature 11	251-255	
7	<b>STROBE</b>	
	No Function Strobe slow to fast	000 - 010 011 - 255
8	<b>AUTO/SOUND PROGRAMS</b>	
	No Function	000-010
	Auto Program 1	011-060
	Auto Program 2	061-120
	Auto Program 3	121 - 180
Auto Program 4	181 - 240	

MODE 10 Ch	FUNCTION	DMX Value
8	Sound show	241 - 255
9	<b>AUTO SPEED</b> Speed slow to fast	000 - 255
10	<b>DIM MODE</b>	
	Preset dimmer speed from display menu	000-051
	Dimmer speed mode off	052-101
	Dimmer speed mode1 (fast speed)	102-152
Dimmer speed mode2 (middle speed)	153-203	
Dimmer speed mode3 (slow speed)	204-255	

MODE 4 Ch	FUNCTION	DMX Value
1	<b>RED</b> 0~100%	000 - 255
2	<b>GREEN</b> 0~100%	000 - 255
3	<b>BLUE</b> 0~100%	000 - 255
4	<b>WHITE</b> 0~100%	000 - 255

MODE 6 Ch	FUNCTION	DMX Value
1	<b>DIMMER</b> 0~100%	000 - 255
2	<b>RED</b> 0~100%	000 - 255
3	<b>GREEN</b> 0~100%	000 - 255
4	<b>BLUE</b> 0~100%	000 - 255
5	<b>WHITE</b> 0~100%	000 - 255
6	<b>STROBE</b> No Function Strobe slow to fast	000 - 010 011 - 255

## - 4 - MAINTENANCE

### 4.1 MAINTENANCE AND CLEANING THE UNIT

- Make sure the area below the installation place is free from unwanted persons during setup.
- Switch off the unit, unplug the main cable and wait until the unit has cooled down.
- All screws used for installing the device and any of its parts should be tightly fastened and should not be corroded.
- Housings, fixations and installation spots (ceiling, trusses, suspensions) should be totally free from any deformation.
- The main cables must be in impeccable condition and should be replaced immediately even when a small problem is detected.
- It is recommended to clean the front at regular intervals, from impurities caused by dust, smoke, or other particles to ensure that the light is radiated at maximum brightness. For cleaning, disconnect the main plug from the socket. Use a soft, clean cloth moistened with a mild detergent. Then carefully wipe the part dry. For cleaning other housing parts use only a soft, clean cloth. Never use a liquid, it might penetrate the unit and cause damage to it.

### 4.2 FUSE REPLACEMENT

1. Remove the safety cap by a screwdriver.
2. Replace the blown fuse with a fuse of the exact same type and rating.
3. Install the safety cap, and reconnect power.

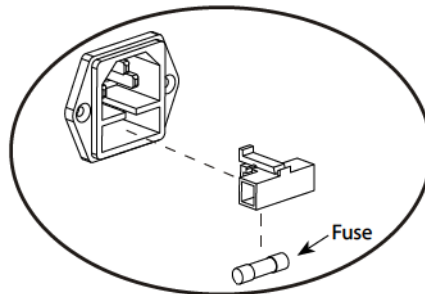

Fig.10



**Il prodotto è coperto da garanzia in base alle vigenti normative. Sul sito [www.musiclights.it](http://www.musiclights.it) è possibile consultare il testo integrale delle "Condizioni Generali di Garanzia".**

**Estratto dalle**

**Condizioni Generali di Garanzia**

- Si prega, dopo l'acquisto, di procedere alla registrazione del prodotto sul sito [www.musiclights.it](http://www.musiclights.it). In alternativa il prodotto può essere registrato compilando e inviando il modulo riportato sul retro.
- Sono esclusi i guasti causati da imperizia e da uso non appropriato dell'apparecchio.
- La garanzia non ha più alcun effetto qualora l'apparecchio sia stato manomesso.
- La garanzia non prevede la sostituzione dell'apparecchio.
- Sono escluse dalla garanzia le parti esterne, le lampade, le manopole, gli interruttori e le parti asportabili.
- Le spese di trasporto e i rischi conseguenti sono a carico del possessore dell'apparecchio.
- A tutti gli effetti la validità della garanzia è avallata unicamente dalla presentazione del certificato di garanzia.

**The guarantee covers the unit in compliance with existing regulations. You can find the full version of the "General Guarantee Conditions" on our web site [www.musiclights.it](http://www.musiclights.it).**

**Abstract**

**General Guarantee Conditions**

- Please remember to register the piece of equipment soon after you purchase it, logging on [www.musiclights.it](http://www.musiclights.it). The product can be also registered filling in and sending the form available on your guarantee certificate.
- Defects caused by inexperience and incorrect handling of the equipment are excluded.
- The guarantee will no longer be effective if the equipment has been tampered.
- The guarantee makes no provision for the replacement of the equipment.
- External parts, lamps, handles, switches and removable parts are not included in the guarantee.
- Transport costs and subsequent risks are responsibility of the owner of the equipment.
- For all purposes, the validity of the guarantee is endorsed solely on presentation of the guarantee certificate.

**Music & LIGHTS®**

**CERTIFICATO DI GARANZIA  
GUARANTEE CERTIFICATE**



Place Stamp Here  
Affrancare

Spett.le  
**Music&Lights S.r.l.**  
Via Appia Km 136.200  
04020 Itri (LT) Italy

MODEL / MODELLO

SERIAL N° / SERIE N°

Purchased by / Acquistato da

SURNAME / COGNOME

NAME / NOME

ADDRESS / VIA

N.

CITY / CITTÀ

ZIP CODE / C.A.P.

PROV.

Dealer's stamp  
and signature

Timbro e firma  
del Rivenditore

Purchasing date  
Data acquisto

FORM TO BE FILLED IN AND MAILED / CEDOLA DA COMPILARE E SPEDIRE

MODEL / MODELLO

SERIAL N° / SERIE N°

Purchased by / Acquistato da

SURNAME / COGNOME

NAME / NOME

ADDRESS / VIA

N.

CITY / CITTÀ

ZIP CODE / C.A.P.

PROV.

Dealer's stamp  
and signature

Timbro e firma  
del Rivenditore

Purchasing date  
Data acquisto

FORM TO BE FILLED IN AND KEPT / CEDOLA DA COMPILARE E CONSERVARE



**MUSIC & LIGHTS S.r.l.**

Via Appia, km 136,200 - 04020 Itri (LT) - ITALY  
Phone +39 0771 72190 - Fax +39 0771 721955  
www.musiclights.it - email: info@musiclights.it  
ISO 9001:2008 Certified Company

**PROLIGHTS** è un brand di proprietà della Music & Lights S.r.l.      **PROLIGHTS** is a brand of Music & Lights S.r.l. company.      ©2014 Music & Lights S.r.l.

