

# V

**V-Series**

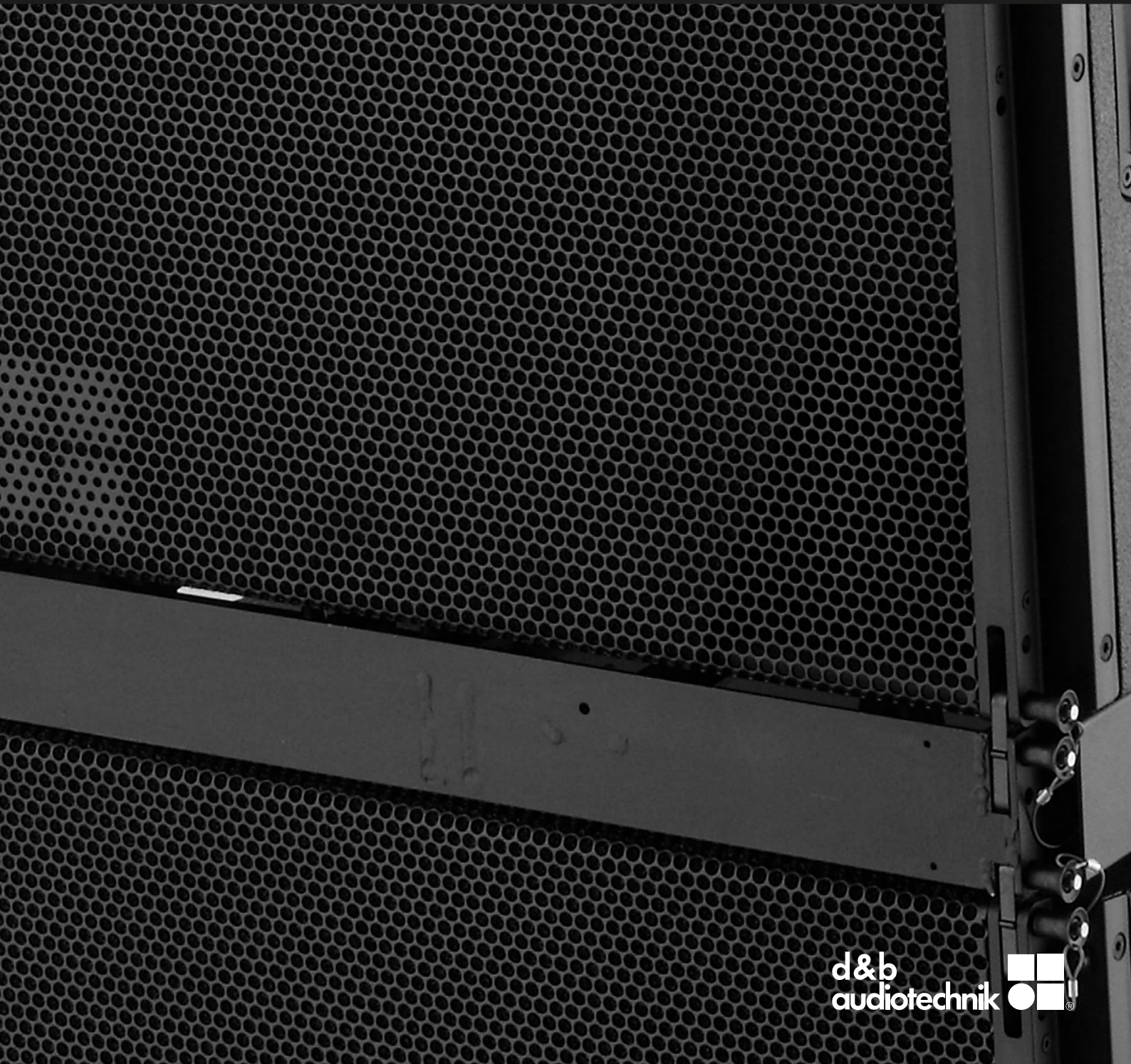

**d&b**  
audiotechnik 



<b>The d&amp;b System reality</b> .....	4
<b>The V-Series</b> .....	6
<b>The V7P and Vi7P loudspeakers</b> .....	10
<b>The V10P and Vi10P loudspeakers</b> .....	11
<b>The V-GSUB and Vi-GSUB</b> .....	12
<b>The V7P, V10P and V-GSUB transport accessories</b> .....	13
<b>The V8 and Vi8 loudspeakers</b> .....	14
<b>The V12 and Vi12 loudspeakers</b> .....	15
<b>The V and Vi subwoofers</b> .....	16
<b>The Vi Weather Resistant and Special Colour options</b> .....	17
<b>The V7P/Vi7P, V10P/Vi10P and V-GSUB/Vi-GSUB mounting accessories</b> .....	18
<b>The V7P/Vi7P, V10P/Vi10P and V-GSUB/Vi-GSUB mounting examples</b> .....	19
<b>The V8, V12 and V-SUB rigging system</b> .....	20
<b>The V8, V12 and V-SUB rigging examples</b> .....	21
<b>The Vi8, Vi12 and Vi-SUB rigging accessories and examples</b> .....	22
<b>The V8, V12 and V Flying frame cases and carts</b> .....	23
<b>The d&amp;b ArrayCalc simulation software</b> .....	24
<b>The d&amp;b Remote network</b> .....	25
<b>The d&amp;b amplifiers</b> .....	26
<b>The operation with d&amp;b amplifiers</b> .....	28
<b>The V-Series frequency responses</b> .....	29
<b>The d&amp;b amplifier output modes</b> .....	30
<b>The V-Series cables and adapters</b> .....	32
<b>The V-Series configuration examples</b> .....	34
<b>The V-Series product overview</b> .....	42

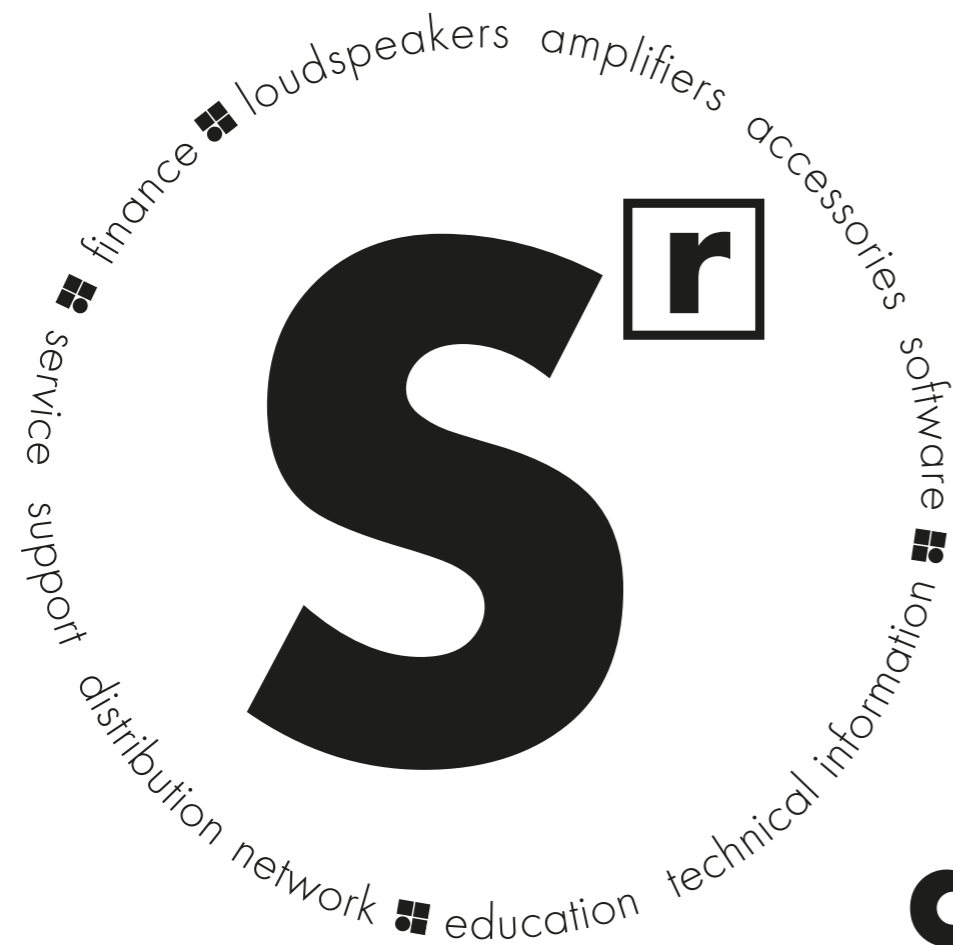

# d&b System reality

As the name implies a d&b audiotechnik system is not just a loudspeaker. Nor is it merely a sum of the components: loudspeakers, amplifiers, accessories and software. Right from the outset the d&b audiotechnik approach was to build integrated sound reinforcement systems that actually are more

than the combination of parts: an entirety where each fits all. Every element is tightly specified, precisely aligned and carefully integrated to achieve maximum efficiency. For ease of use, all the user-definable parameters are integrated, allowing the possibility of adjustment, either via remote control surfaces or directly on the

amplifiers. Neutral sound characteristics leave the user all the freedom needed to realise whatever the brief. At the same time d&b offers integrated finance, service and support, a knowledgeable distribution network, education and training as well as technical information, so the same optimal acoustic result

is achieved consistently by every system anywhere, at any time. In reality: the d&b System reality.

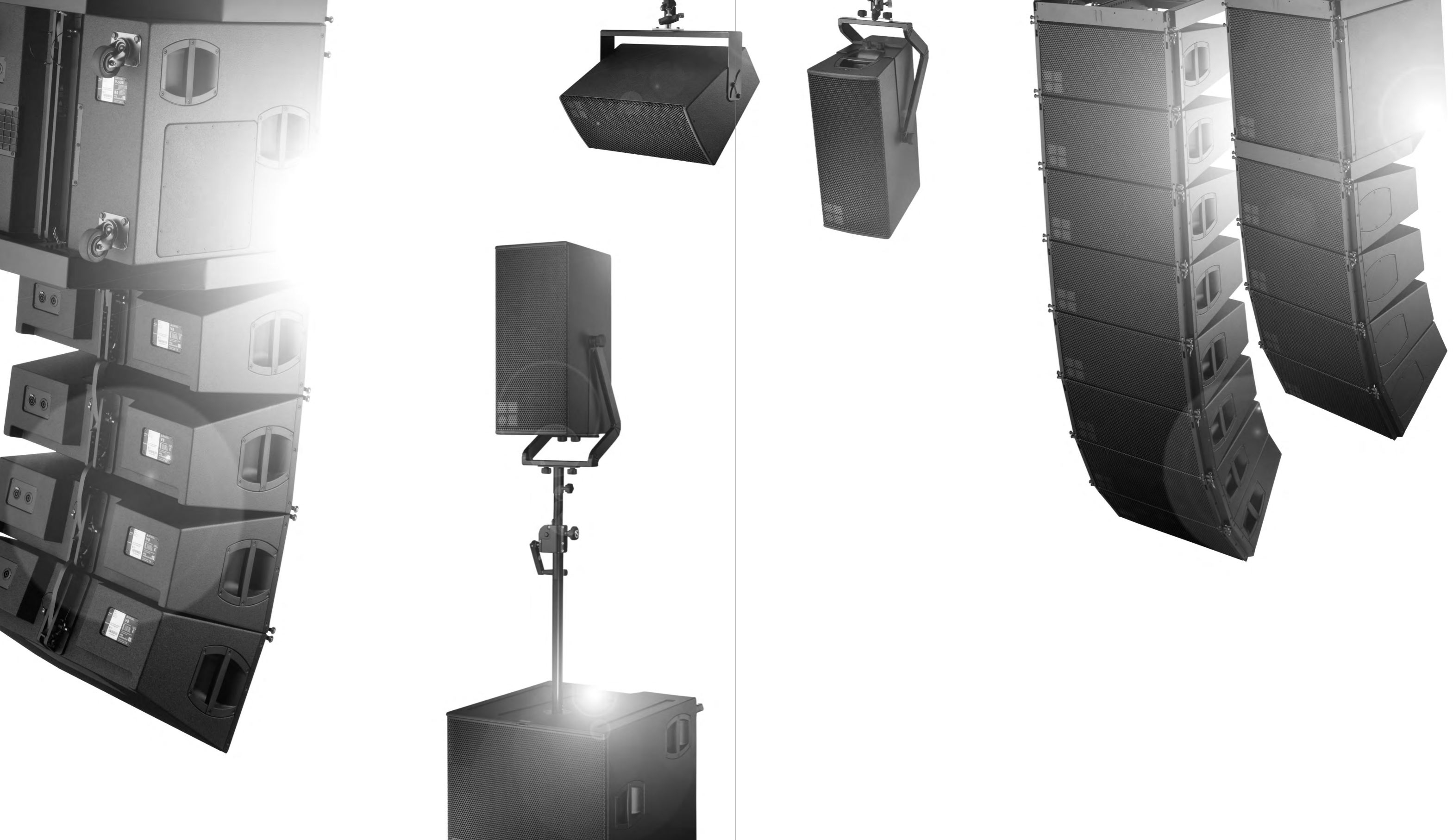

The V-Series comprises both line array solutions and point source systems; both offer minimal size and weight in combination with outstanding control of dispersion behaviour and convincing high sound pressure levels. With its crystal clear and detailed audio performance, smooth and even frequency response over distance, high dynamic bandwidth and power and headroom capabilities all make the V-Series a good choice

for any medium to large sound reinforcement applications, for any sound genre. The line array system features an integrated rigging system ensuring speedy deployment providing a quick and easily configurable array solution for all intended applications. This flexible system can be used stand-alone, or is the ideal complement to the larger J-Series in terms of sound character, headroom, dispersion and arrayability for outfills, as

a centre cluster or delays. The high output point source loudspeakers are the answer for any sound reinforcement system that demand high sound pressure levels from a single box solution. The V loudspeakers are designed for a wide range of applications with a clear perspective to provide mobile, flexible, configurable solutions to the most arduous sound reinforcement situations. The Vi loudspeakers differ only slightly in cabinet

construction and mounting hardware. They are intended for permanently installed performance spaces where the specification is rider driven. Both the Vi cabinets and mounting hardware can be properly colour matched to interior designs and are weather protected for climatically hostile environments.

# The V-Series

The 3-way passive **V7P** and **Vi7P** point source loudspeakers produce a constant directivity dispersion of  $75^\circ \times 40^\circ$  (h x v) with exceptional vertical constant directivity dispersion control nominally being maintained down to 350 Hz. This is achieved using a symmetrical dipolar driver arrangement for the two 10" LF neodymium drivers, with a centrally mounted horn-loaded 8" MF driver and a coaxial 1.4" exit HF compression driver mounted on a constant directivity horn. The **V10P** and **Vi10P** point source loudspeakers feature the same driver configuration, but produce a wider  $110^\circ$  horizontal dispersion pattern. Both loudspeakers feature a rotatable HF horn which enables deployment in either orientation. The advanced bass reflex and venting design combined with a large cabinet volume increases the LF performance of these compact cabinets, with a frequency response extending from 59 Hz to 18 kHz.

The **V-GSUB** and **Vi-GSUB** are actively driven cardioid subwoofers that require only one amplifier channel. These subwoofers share the same acoustical and visual design as the V-SUB and Vi-SUB, but are intended for ground stacked applications only.

The **V8** and **Vi8** line array loudspeakers produce an  $80^\circ$  constant directivity dispersion pattern in the horizontal plane. They utilize a passive 3-way design featuring two 10" neodymium LF drivers, one hornloaded 8" MF driver, two 1.4" exit HF compression drivers with 2.5" voicecoils mounted to a dedicated wave shaping device and a passive crossover network. The **V12** and **Vi12** line array modules, which are acoustically and mechanically compatible with the V8 and Vi8 respectively, differ only in the  $120^\circ$  horizontal coverage. All components are arranged symmetrically around the centre axis of the cabinet to produce a perfect symmetrical dispersion pattern. Due to the dipolar arrangement of the LF drivers, a broadband, horizontal dispersion control is maintained down to approximately 250 Hz.

The **V** and **Vi-SUB** are compact high performance cardioid subwoofers powered by a single amplifier channel. They share the same width as the V8/Vi8 and V12/Vi12 loudspeakers and are equipped with compatible flying fittings. The V and Vi-SUB house two long excursion neodymium drivers in an integrated cardioid setup to avoid unwanted energy behind the system.



**V7P, V10P loudspeaker**



**Vi7P, Vi10P loudspeaker**



**V-GSUB**



**Vi-GSUB**



**V8, V12 loudspeaker**



**Vi8, Vi12 loudspeaker**



**V subwoofer**



**Vi subwoofer**

All V loudspeakers are finished with a PCP (Polyurea Cabinet Protection) coating that provides mobile systems with protection against impact and resistance to the adverse effects on cabinets caused by changing ambient outdoor conditions. The Vi cabinets feature an impact resistant paint finish; Weather Resistant and Special Colour options are available. A selection of transport solutions are available for the V loudspeakers.

The d&b software offering aides the entire system setup process, from the simulation and planning of the loudspeaker systems, to the remote control and monitoring of the system functions during the event, followed by service functionality to verify system performance prior to de-rigging. The **ArrayCalc** simulation software allows the virtual optimization of loudspeaker line arrays, point source and column loudspeakers as well as subwoofers and their adjustment to venue conditions. The complete system configuration simulated in ArrayCalc is assimilated by the **R1 Remote control software** into an intuitive graphical user interface to manage the amplifiers, and loudspeakers, from anywhere in the venue. Service functions enable firmware updates of the amplifiers as and when these are available.

d&b amplifiers are specifically designed for use with d&b loudspeakers, and are at the heart of the d&b system approach. These devices contain extensive Digital Signal Processing capabilities to provide comprehensive loudspeaker management and specific switchable filter functions to precisely target the system response for a wide variety of applications. The four channel **D80** amplifier is intended for both mobile and installation applications requiring the highest Sound Pressure Levels. The installation specific four channel **30D** amplifier is intended for permanent integration within venues which require medium to high Sound Pressure Levels. These amplifiers all provide extensive user-definable equalization containing two 16-band equalizers with parametric, notch, shelving and asymmetric filters as well as delay capabilities of up to 10 seconds.



**D80 amplifier**



**30D amplifier**

# The V7P and Vi7P loudspeakers

## V7P and Vi7P loudspeakers

The 3-way passive V7P and Vi7P loudspeakers feature two 10" drivers in a dipole arrangement with a horn loaded 8" MF driver and a 1.4" exit compression driver mounted onto a rotatable CD horn. The Vi7P is the installation version of the V7P loudspeaker and differs only in cabinet construction, finish and mounting hardware. The innovative horn design for the centrally mounted 8" MF driver produces a remarkable sensitivity resulting in an exceptional performance in the vocal range. An advanced bass-reflex and venting design delivers an extended LF output with full bandwidth capabilities.

These high performance point source loudspeakers provide a broad variety of deployment possibilities, especially when used as a stand-alone full range system, or combined with other elements from the V-Series, either ground stacked or flown. The HF horn can be rotated by 90° to enable horizontal orientation. The loudspeaker cabinets are constructed from marine plywood, the V7P has an impact and weather protected PCP (Polyurea Cabinet Protection) finish, while the Vi7P has an impact resistant paint finish. The front of the loudspeaker cabinets are protected by a rigid metal grill. The V7P cabinet incorporates a pair of handles. M10 threaded inserts are provided for attaching d&b rigging hardware.

### System data

Frequency response (-5 dB standard) .....	59 Hz - 18 kHz
Frequency response (-5 dB CUT mode).....	100 Hz - 18 kHz
Max. sound pressure (1 m, free field) <sup>1</sup> .....	
with D12/30D/D20 .....	139 dB
with D80 .....	142 dB
Input level (100 dB SPL/1 m).....	-17 dBu

### Loudspeaker data

Nominal impedance .....	8 ohms
Power handling capacity (RMS/peak 10 ms) .....	500/2000 W
Nominal dispersion angle (h x v) .....	75° x 40°
Components .....	2 x 10" driver with neodymium magnet
.....	1 x 8" driver with neodymium magnet
.....	1 x 1.4" exit compression driver
.....	passive crossover network
Connections V7P .....	2 x NLT4 F/M
.....	optional 2 x NL4 or 2 x EP5
Connections Vi7P.....	2 x NL4 and screw terminal block
Weight V7P / Vi7P.....	33 kg (75 lb)

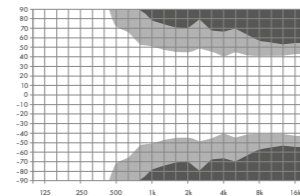

V7P and Vi7P horizontal dispersion characteristics<sup>2</sup>

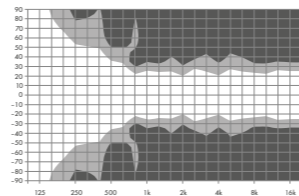

V7P and Vi7P vertical dispersion characteristics<sup>2</sup>

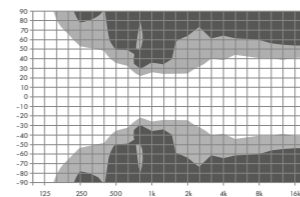

V7P and Vi7P horizontal dispersion characteristics/horizontal setup, horn rotated<sup>2</sup>

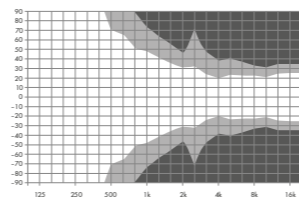

V7P and Vi7P vertical dispersion characteristics/horizontal setup, horn rotated<sup>2</sup>

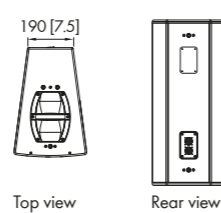
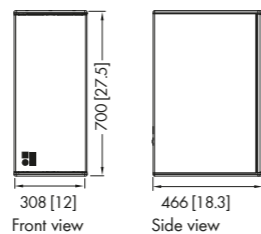

V7P cabinet dimensions in mm [inch]

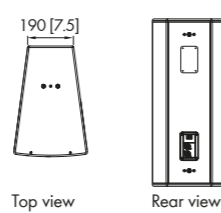
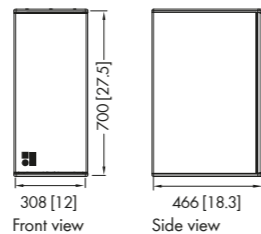

Vi7P cabinet dimensions in mm [inch]

<sup>1</sup> Broadband measurement, pink noise, crest factor 4, peak measurement, linear weighting  
<sup>2</sup> Dispersion angle vs frequency plotted using lines of equal sound pressure (isobars) at -6 dB and -12 dB

# The V10P and Vi10P loudspeakers

## V10P and Vi10P loudspeakers

The 3-way passive V10P and Vi10P loudspeakers feature two 10" drivers in a dipole arrangement with a horn loaded 8" MF driver and a 1.4" exit compression driver mounted onto a rotatable CD horn. The Vi10P is the installation version of the V10P loudspeaker and differs only in cabinet construction, finish and mounting hardware. The innovative horn design for the centrally mounted 8" MF driver produces a remarkable sensitivity resulting in an exceptional performance in the vocal range. An advanced bass-reflex and venting design delivers an extended LF output with full bandwidth capabilities.

These high performance point source loudspeakers provide a broad variety of deployment possibilities, especially when used as a stand-alone full range system, or combined with other elements from the V-Series, either ground stacked or flown. The HF horn can be rotated by 90° to enable horizontal orientation. The loudspeaker cabinets are constructed from marine plywood, the V10P has an impact and weather protected PCP (Polyurea Cabinet Protection) finish, while the Vi10P has an impact resistant paint finish. The front of the loudspeaker cabinets are protected by a rigid metal grill. The V10P cabinet incorporates a pair of handles. M10 threaded inserts are provided for attaching d&b rigging hardware.

### System data

Frequency response (-5 dB standard) .....	59 Hz - 18 kHz
Frequency response (-5 dB CUT mode).....	100 Hz - 18 kHz
Max. sound pressure (1 m, free field) <sup>1</sup> .....	
with D12/30D/D20 .....	138 dB
with D80 .....	141 dB
Input level (100 dB SPL/1 m) .....	-17 dBu

### Loudspeaker data

Nominal impedance .....	8 ohms
Power handling capacity (RMS/peak 10 ms) .....	500/2000 W
Nominal dispersion angle (h x v) .....	110° x 40°
Components .....	2 x 10" driver with neodymium magnet
.....	1 x 8" driver with neodymium magnet
.....	1 x 1.4" exit compression driver
.....	passive crossover network
Connections V10P .....	2 x NLT4 F/M
.....	optional 2 x NL4 or 2 x EP5
Connections Vi10P .....	2 x NL4 and screw terminal block
Weight V10P / Vi10P .....	33 kg (75 lb)

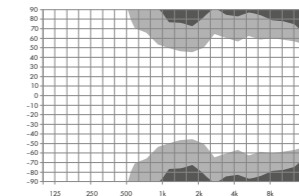

V10P and Vi10P horizontal dispersion characteristics<sup>2</sup>

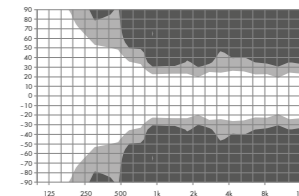

V10P and Vi10P vertical dispersion characteristics<sup>2</sup>

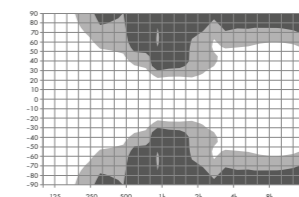

V10P and Vi10P horizontal dispersion characteristics/horizontal setup, horn rotated<sup>2</sup>

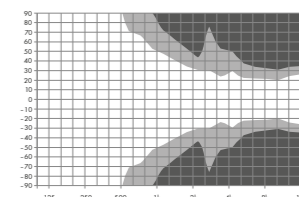

V10P and Vi10P vertical dispersion characteristics/horizontal setup, horn rotated<sup>2</sup>

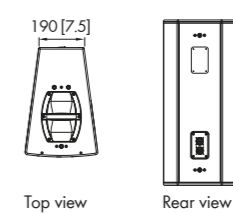
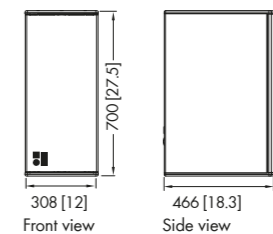

V10P cabinet dimensions in mm [inch]

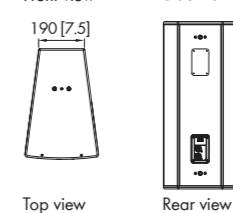
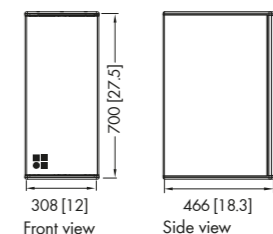

Vi10P cabinet dimensions in mm [inch]

<sup>1</sup> Broadband measurement, pink noise, crest factor 4, peak measurement, linear weighting  
<sup>2</sup> Dispersion angle vs frequency plotted using lines of equal sound pressure (isobars) at -6 dB and -12 dB

# The V-GSUB and Vi-GSUB

## V-GSUB and Vi-GSUB

The V-GSUB and Vi-GSUB are actively driven high performance cardioid subwoofers powered by a single amplifier channel. The V-GSUB and Vi-GSUB are intended for ground stacked applications only, and share the same acoustical and visual design as the V-SUB and Vi-SUB, which feature integrated rigging equipment. The Vi-GSUB is the installation version of the V-GSUB. They house two long excursion neodymium drivers, an 18" driver in a bass-reflex design facing to the front and a 12" driver in a two chamber bandpass design radiating to the rear. The cardioid dispersion pattern resulting from this arrangement avoids unwanted energy behind the system that reduces the excitation of the reverberant field at low frequencies and provides the greatest accuracy of low frequency reproduction. The cabinet is constructed from marine plywood and has an impact and weather protected PCP (Polyurea Cabinet Protection) finish. The front of the loudspeaker cabinet is protected by a rigid metal grill backed by an acoustically transparent foam. The V-GSUB top panel has a recess in the form of the footprint of a V7P/ V10P enclosure to prevent cabinet movement when stacking one TOP loudspeaker. The enclosure features two runners to protect the bottom panel from scratching. Two correspondingly shaped recesses are incorporated into the top panel of each V-GSUB cabinet to accept these runners, preventing cabinet movement when stacked. Each side of the V-GSUB panel incorporates two handles whilst the top panel has an M20 high stand flange inserted.

## System data

Frequency response (-5 dB standard) .....37 Hz - 115 Hz  
 Frequency response (-5 dB 100 Hz mode)..... 37 Hz - 95 Hz  
 Max. sound pressure (1 m, free field)<sup>1</sup> .....  
 with D12/30D/D20 ..... 133 dB  
 with D80 ..... 137 dB

## Loudspeaker data

Nominal impedance .....8 ohms  
 Power handling capacity (RMS/peak 10 msec) .....800/3200 W  
 Components ..... 1 x 18" driver  
 ..... 1 x 12" driver  
 Connections V-GSUB..... 2 x NLT4 F/M  
 ..... optional 2 x NL4 or 2 x EP5  
 Connections Vi-GSUB..... 2 x NL4 and screw terminal block  
 Weight V-GSUB/Vi-GSUB.....61/58 kg (135/128 lb)

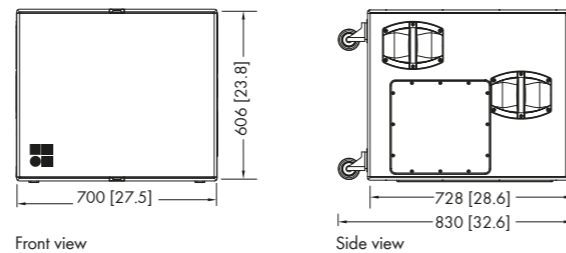

Front view

Side view

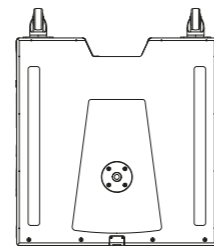

Top view

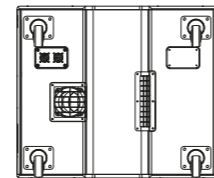

Rear view

V-GSUB cabinet dimensions in mm [inch]

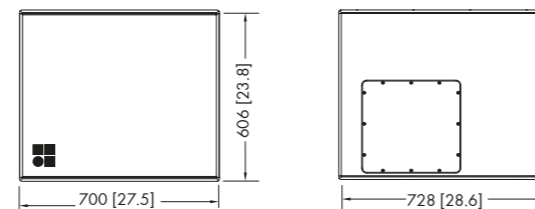

Front view

Side view

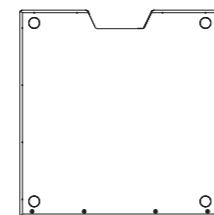

Top view

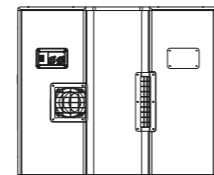

Rear view

Vi-GSUB cabinet dimensions in mm [inch]

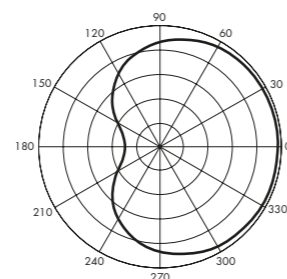

Cardioid polar pattern

# The V7P, V10P and V-GSUB transport accessories

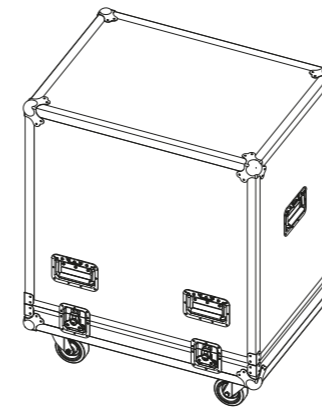

**E7466**  
**Touring case 2 x V7P/V10P**  
 Dimensions (H x W x D):  
 970 x 800 x 600 mm  
 38.2 x 31.5 x 23.6 inch  
 Net weight: 43 kg (94.8 lb)

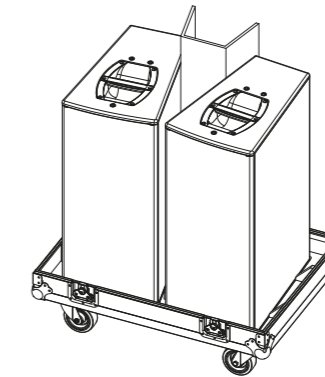

**E7926**  
**V-GSUB Transport lid**

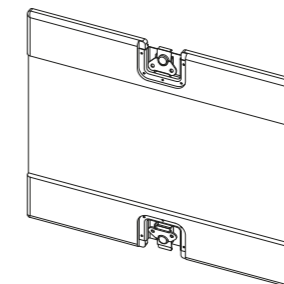
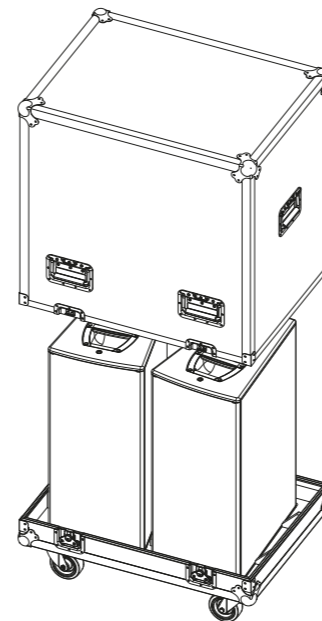

# The V8 and Vi8 loudspeakers

## V8 and Vi8 loudspeakers

The V8 and Vi8 are line array loudspeakers, the Vi8 is the installation version of the V8 loudspeaker. They are 3-way passive designs featuring two 10" LF drivers, one hornloaded 8" MF driver and two 1.4" exit HF compression drivers with 2.5" voicecoils mounted to a dedicated waveshaping device. The symmetrical dipolar arrangement of the neodymium LF drivers around the centrally mounted coaxial MF and HF components allows a smooth overlap of the adjacent frequency bands in the crossover design. This results in an exceptional 80° horizontal constant directivity dispersion control nominally being maintained down to 250 Hz.

The mechanical and acoustical design enables flown vertical arrays of up to twenty four loudspeakers to be suspended using vertical splay angles between 0° to 14° with a 1° resolution. It can be used in columns of purely V8 or Vi8 loudspeakers or combined with V12/Vi12s and/or with V-SUB/Vi-SUBs. The cabinet is constructed from marine plywood and has an impact and weather protected PCP (Polyurea Cabinet Protection) finish. The front of the loudspeaker cabinet is protected by a rigid metal grill backed by an acoustically transparent foam. Each side panel of the V8 cabinet incorporates a handle while two additional recessed grips are provided at the rear bottom of both the V8 and Vi8.

### System data

Frequency response (-5 dB standard) ..... 67 Hz - 18 kHz  
 Frequency response (-5 dB CUT mode)..... 100 Hz - 18 kHz  
 Max. sound pressure (1 m, free field)<sup>1</sup> .....  
 with D12/30D/D20 ..... 139 dB  
 with D80 ..... 142 dB

### Loudspeaker data

Nominal impedance ..... 8 ohms  
 Power handling capacity (RMS/peak 10 msec) ..... 500/2000 W  
 Nominal dispersion angle (horizontal) ..... 80°  
 Splay angle settings ..... 0° - 14°  
 ..... 1° increment  
 Components ..... 2 x 10" driver  
 ..... 1 x 8" driver  
 ..... 2 x 1.4" exit compression driver  
 ..... passive crossover network  
 Connections V8 ..... 2 x NLT4 F/M  
 ..... optional 2 x NL4 or 2 x EP5  
 Connections Vi8 ..... 2 x NL4  
 Weight ..... 34 kg (75 lb)

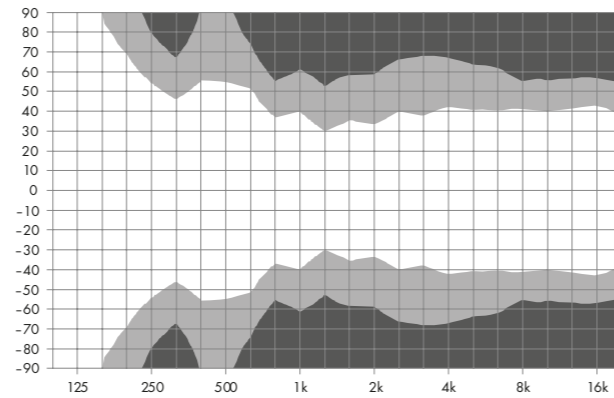

V8 and Vi8 horizontal dispersion characteristics<sup>2</sup>

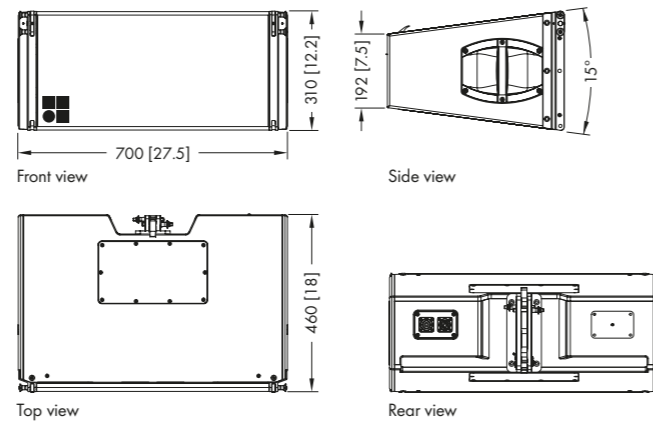

V8 cabinet dimensions in mm [inch]

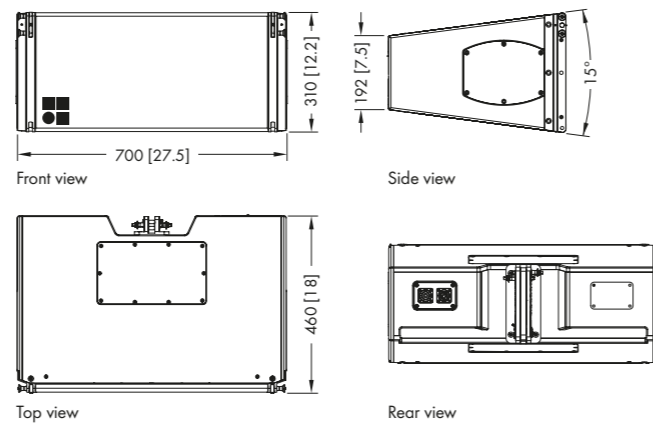

Vi8 cabinet dimensions in mm [inch]

<sup>1</sup> Broadband measurement, pink noise, crest factor 4, peak measurement, linear weighting  
<sup>2</sup> Dispersion angle vs frequency plotted using lines of equal sound pressure (isobars) at -6 dB and -12 dB

# The V12 and Vi12 loudspeakers

## V12 and Vi12 loudspeakers

The V12 and Vi12 are line array loudspeakers, the Vi12 is the installation version of the V12 loudspeaker. They are 3-way passive designs featuring two 10" LF drivers, one hornloaded 8" MF driver and two 1.4" exit HF compression drivers with 2.5" voicecoils mounted to a dedicated waveshaping device. The symmetrical dipolar arrangement of the neodymium LF drivers around the centrally mounted coaxial MF and HF components allows a smooth overlap of the adjacent frequency bands in the crossover design. This results in an exceptional 120° horizontal constant directivity dispersion control nominally being maintained down to 250 Hz.

The mechanical and acoustical design enables flown vertical arrays of up to twenty four loudspeakers to be suspended using vertical splay angles between them of 0° to 14° with a 1° resolution. It can be used in columns of purely V12 or Vi12 loudspeakers or combined with V8/Vi8s and/or with V-SUB/Vi-SUBs. The cabinet is constructed from marine plywood and has an impact and weather protected PCP (Polyurea Cabinet Protection) finish. The front of the loudspeaker cabinet is protected by a rigid metal grill backed by an acoustically transparent foam. Each side panel of the V12 cabinet incorporates a handle while two additional recessed grips are provided at the rear bottom of both the V12 and Vi12.

### System data

Frequency response (-5 dB standard) ..... 67 Hz - 18 kHz  
 Frequency response (-5 dB CUT mode)..... 100 Hz - 18 kHz  
 Max. sound pressure (1 m, free field)<sup>1</sup> .....  
 with D12/30D/D20 ..... 139 dB  
 with D80 ..... 142 dB

### Loudspeaker data

Nominal impedance ..... 8 ohms  
 Power handling capacity (RMS/peak 10 msec) ..... 500/2000 W  
 Nominal dispersion angle (horizontal) ..... 120°  
 Splay angle settings ..... 0° - 14°  
 ..... 1° increment  
 Components ..... 2 x 10" driver  
 ..... 1 x 8" driver  
 ..... 2 x 1.4" exit compression driver  
 ..... passive crossover network  
 Connections V12 ..... 2 x NLT4 F/M  
 ..... optional 2 x NL4 or 2 x EP5  
 Connections Vi12 ..... 2 x NL4  
 Weight ..... 34 kg (75 lb)

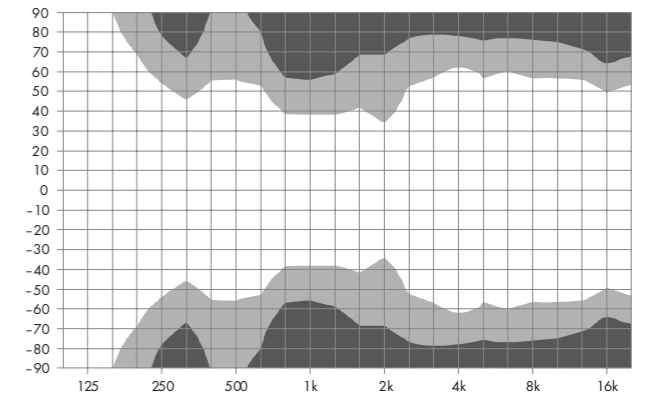

V12 and Vi12 horizontal dispersion characteristics<sup>2</sup>

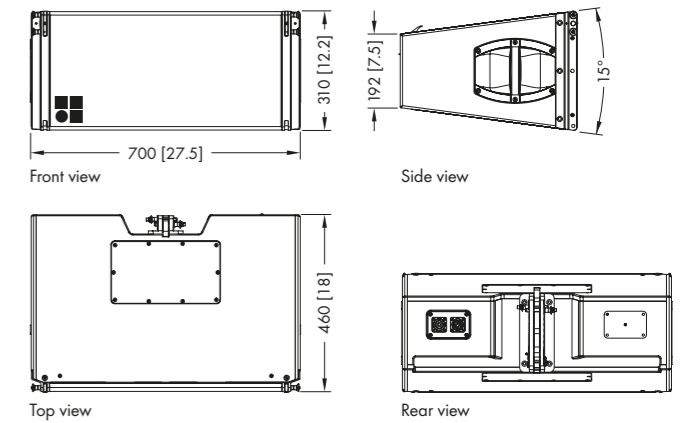

V12 cabinet dimensions in mm [inch]

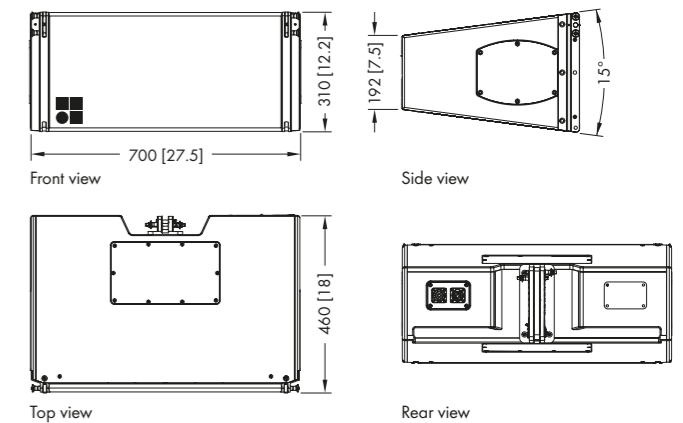

Vi12 cabinet dimensions in mm [inch]

<sup>1</sup> Broadband measurement, pink noise, crest factor 4, peak measurement, linear weighting  
<sup>2</sup> Dispersion angle vs frequency plotted using lines of equal sound pressure (isobars) at -6 dB and -12 dB



# The V and Vi subwoofers

## V and Vi subwoofers

The V-SUB and Vi-SUB are actively driven high performance cardioid subwoofers powered by a single amplifier channel. The V-SUB and Vi-SUB feature integrated rigging equipment, and share the same acoustical and visual design as the V-GSUB and Vi-GSUB, which are intended for ground stacked applications only. The Vi-SUB is the installation version of the V subwoofer. They house two long excursion neodymium drivers, an 18" driver in a bass-reflex design facing to the front and a 12" driver in a two chamber bandpass design radiating to the rear. The cardioid dispersion pattern resulting from this arrangement avoids unwanted energy behind the system that reduces the excitation of the reverberant field at low frequencies and provides the greatest accuracy of low frequency reproduction.

The V and Vi subwoofers can be used to supplement V8/Vi8 and V12/Vi12 loudspeakers in various combinations, ground stacked or flown, either integrated on top of a V8/V12 or Vi8/Vi12 array or as a separate column.

The cabinet is constructed from marine plywood and has an impact and weather protected PCP (Polyurea Cabinet Protection) finish. The front of the loudspeaker cabinet is protected by a rigid metal grill backed by an acoustically transparent foam. Each side of the V-SUB panel incorporates two handles whilst the top panel has an M20 high stand flange inserted.

## System data

Frequency response (-5 dB standard).....	37 - 120 Hz
Frequency response (-5 dB 100 Hz mode).....	37 - 95 Hz
Max. sound pressure (1 m, free field) <sup>1</sup> .....	
with D12/30D/D20 .....	133 dB
with D80 .....	137 dB

## Loudspeaker data

Nominal impedance.....	8 ohms
Power handling capacity (RMS/peak 10 msec) .....	800/3200 W
Splay angle settings .....	0° and 2.5°
Components.....	1 x 18" driver
.....	1 x 12" driver
Connections V-SUB .....	2 x NLT4 F/M
.....	optional 2 x NL4 or 2 x EP5
Connections Vi-SUB.....	2 x NL4
Weight V-SUB/Vi-SUB .....	64/62 kg (141/137 lb)

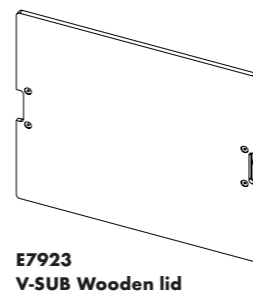
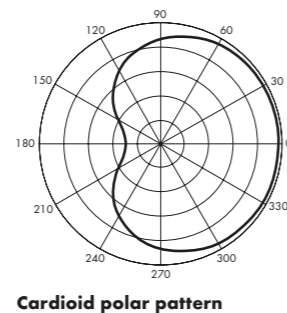
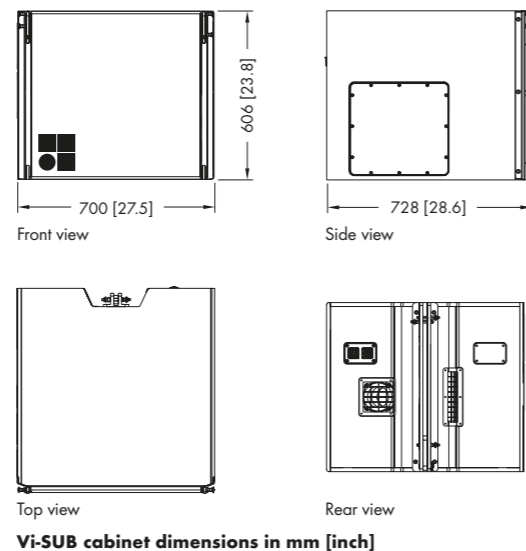
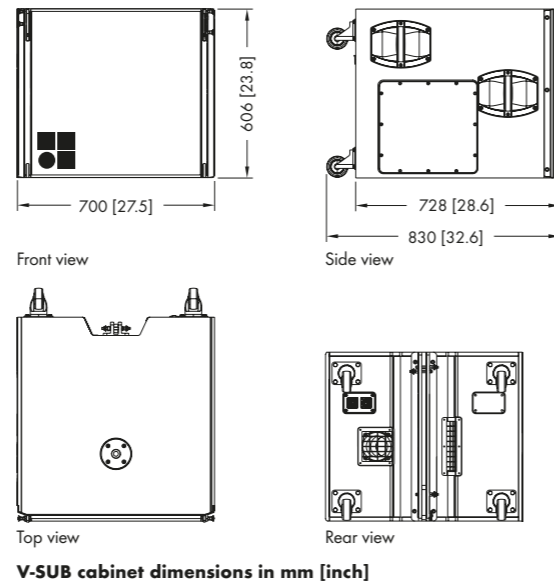

# The Vi Weather Resistant and Special Colour options

The Vi cabinets and appropriate accessories are also available with a Weather Resistant or Special Colour option. Both options can be combined.

## Weather Resistant (WR) option

The WR option enables operation of loudspeakers in changing ambient conditions, however it is not intended to enable permanent, unprotected operation of loudspeakers outdoors. Cabinets being used outdoors even with the WR option should always be aimed either horizontally or with a downward tilt. An additional cover should be positioned over the loudspeakers. Vi loudspeakers with the Weather Resistant option are supplied with a fixed cable. PG cable type H-07-RN-F 2 x 2.5 mm<sup>2</sup>/AWG 13 with a length of 5.5 m (18 ft) as standard or length as required.

## Special Colour (SC) option

The paint finish of all loudspeaker cabinets and most accessories can be executed in almost all RAL colours in accordance with the RAL colour table. All rigging fittings at the rear of the cabinet, front links and locking pins remain in black. Other paint finishes such as metallic are available on request. The acoustically transparent foam fitted behind the rigid metal grill is also painted with the requested RAL colour.

# The V7P/Vi7P, V10P/Vi10P and V-GSUB/Vi-GSUB mounting accessories

## Safety approval

d&b loudspeakers and accessories are designed for setup and use within situations requiring compliance with the provisions and directives of the DGUV regulation 17 (formerly BGV C1).

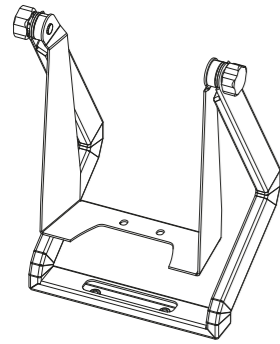

**Z5383**  
VP Mounting bracket

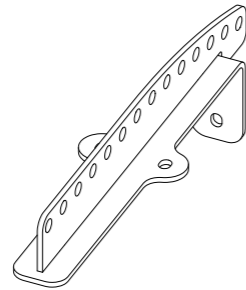

**Z5384**  
VP Flying adapter

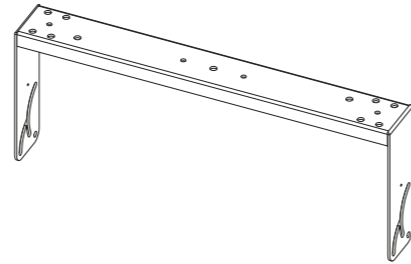

**Z5388**  
VP Horizontal bracket



**Z5550**  
M20 Stand adapter



**Z5012**  
Pipe clamp

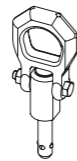

**Z5049**  
Flying pin 8mm

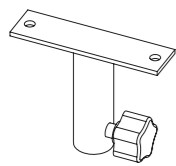

**Z5024**  
Loudspeaker stand adapter

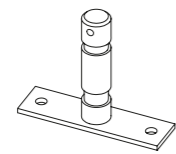

**Z5010**  
TV spigot with fixing plate

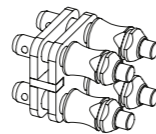

**Z5551**  
VP Flying adapter link

# The V7P/Vi7P, V10P/Vi10P and V-GSUB/Vi-GSUB mounting examples

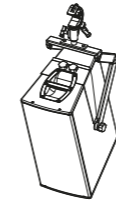

**V7P/V10P with Z5383 VP Mounting bracket Z5010 TV spigot with fixing plate Z5012 Pipe clamp**

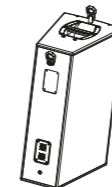

**V7P/V10P<sup>1</sup> with Z5012 Flying pin 8mm**



**V7P/V10P with Z5383 VP Mounting bracket Z5010 TV spigot with fixing plate Z5024 Loudspeaker stand adapter**

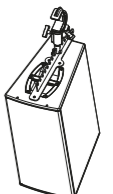

**V7P/V10P with Z5384 VP Flying adapter Z5015 TV spigot for Flying adapter 02 Z5012 Pipe clamp**

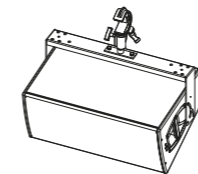

**V7P/V10P with Z5388 VP Horizontal bracket Z5010 TV spigot with fixing plate Z5012 Pipe clamp**



**V7P/V10P with Z5384 VP Flying adapter Z5015 TV spigot for Flying adapter 02 Z5012 Pipe clamp Z5551 VP Flying adapter link**

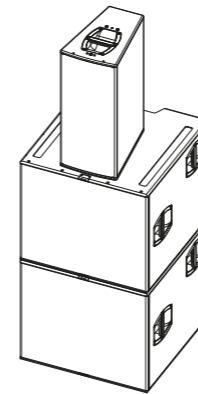

**V7P/V10P with V-GSUB**

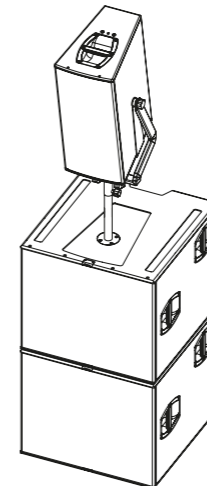

**V7P/V10P with Z5550 M20 Stand adapter**

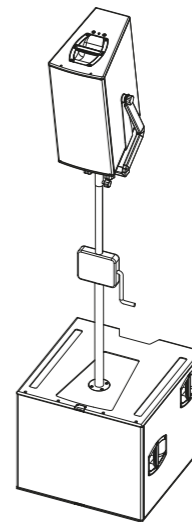

**V7P/V10P with Z5383 VP Mounting bracket Z5010 TV spigot with fixing plate Z5024 Loudspeaker stand adapter Z5013 Loudspeaker stand winder M20**

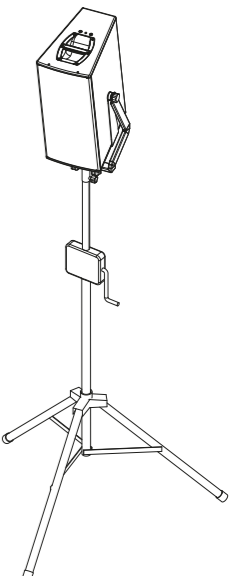

**V7P/V10P with Z5383 VP Mounting bracket Z5010 TV spigot with fixing plate Z5024 Loudspeaker stand adapter Z5009 Loudspeaker stand with winder**

<sup>1</sup> This example is not valid for Vi loudspeakers

# The V8, V12 and V-SUB rigging system

## Safety approval

d&b loudspeakers and accessories are designed for setup and use within situations requiring compliance with the provisions and directives of the DGUV regulation 17 (formerly BGV C1).

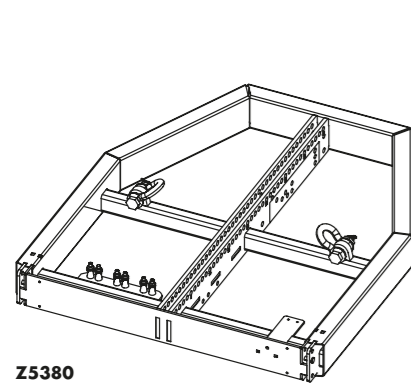

**Z5380  
V Flying frame**  
For a maximum of twenty four V8/V12 loudspeakers or fourteen V subwoofers

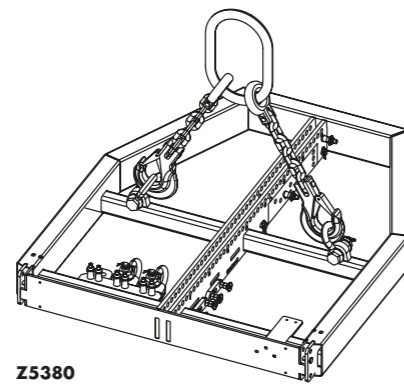

**Z5380  
V Flying frame**  
Supplied with  
1 x Z5382 V Safety chainset  
2 x V Load adapter  
1 x V Load adapter for Rota clamp  
2 x Front links

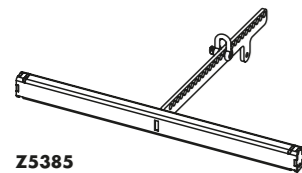

**Z5385  
V Flying adapter**  
For a maximum of four V8/V12 loudspeakers; supplied with 1t Shackle



**Z5381  
V Hoist connector chain**



**Z5382  
V Safety chainset**

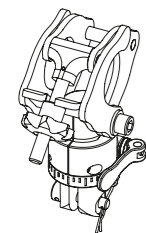

**Z5147  
Rota clamp**  
WLL: 500 kg/1100 lb;  
for a tube diameter up to  
51 mm/2"



**Z5386  
V Stack adapter**

# The V8, V12 and V-SUB rigging examples

These rigging examples are for illustration only. For further information please refer to the T1 385 d&b Line array design as well as the V-Series Rigging manual, both of which are available for download at [www.dbaudio.com](http://www.dbaudio.com).

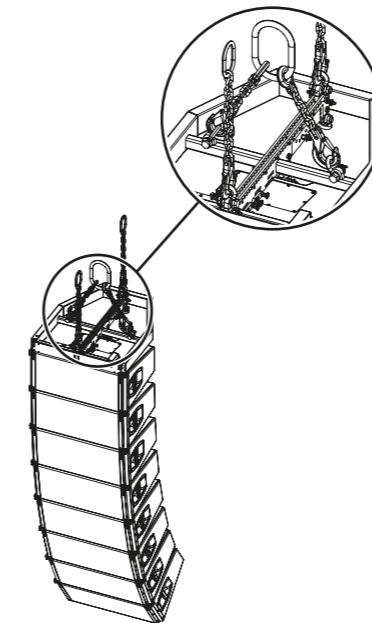

**V8/V12 array with  
Z5380 V Flying frame  
2 x Z5381 V Hoist  
connector chains  
Z5382 V Safety chainset**

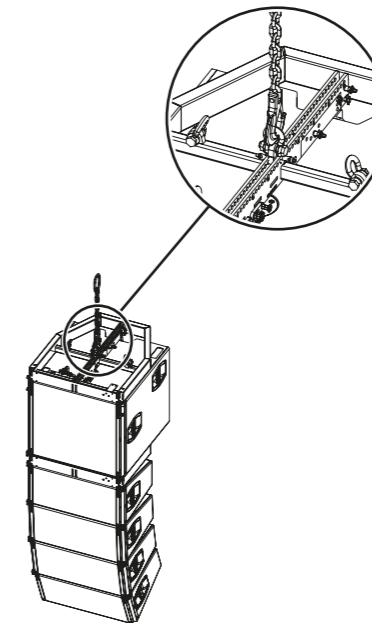

**V-Series mixed array with  
Z5380 V Flying frame  
Z5381 V Hoist connector  
chain**

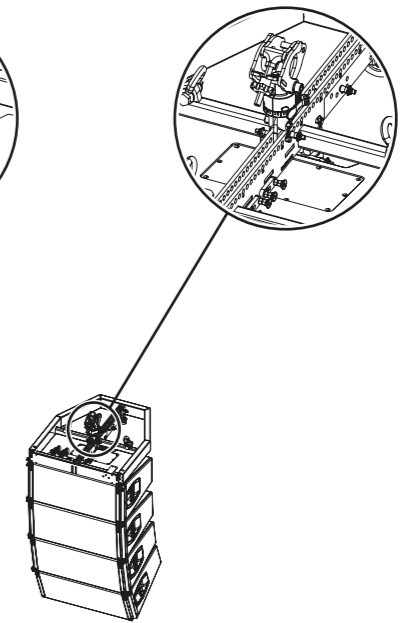

**V8/V12 array with  
Z5380 V Flying frame  
Z5147 Rota clamp**

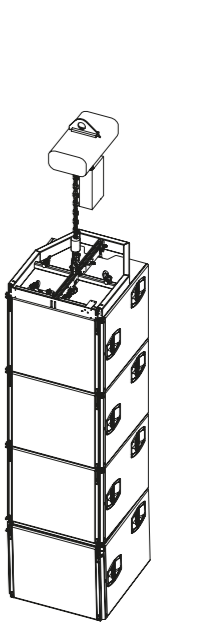

**V-SUB column with  
Z5380 V Flying frame**

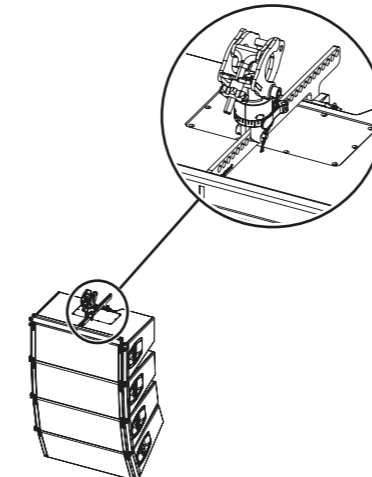

**V8/V12 array with  
Z5385 V Flying adapter  
Z5147 Rota clamp**

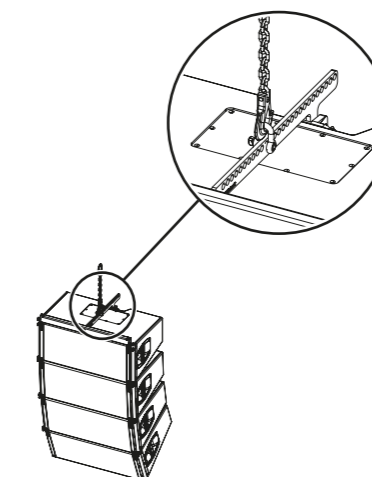

**V8/V12 array with  
Z5385 V Flying adapter  
E6507 1t Shackle**

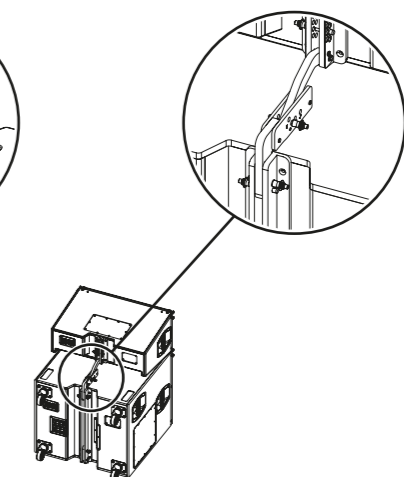

**V-Series ground stack with  
Z5386 V Stack adapter**

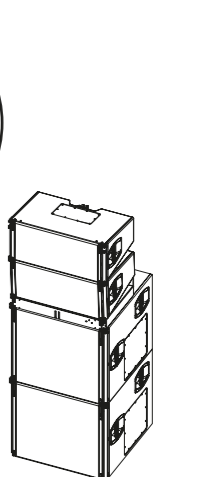

**V-Series ground stack with  
Z5380 V Flying frame**

# The Vi8, Vi12 and Vi-SUB rigging accessories and examples

## Safety approval

d&b loudspeakers and accessories are designed for setup and use within situations requiring compliance with the provisions and directives of the DGUV regulation 17 (formerly BGV C1).

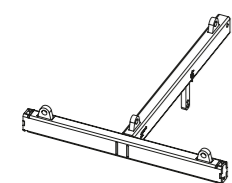

**Z5387.000**  
**Vi Mounting frame top**  
For a maximum load equivalent to four Vi8/Vi12 loudspeakers (136 kg/400 lbs)

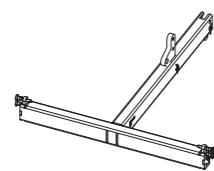

**Z5387.001**  
**Vi Mounting frame bottom**

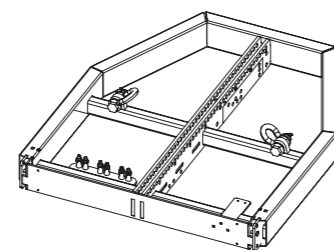

**Z5380**  
**V Flying frame**  
For a maximum of twenty four V8/V12/Vi8/Vi12 loudspeakers or fourteen V/Vi subwoofers

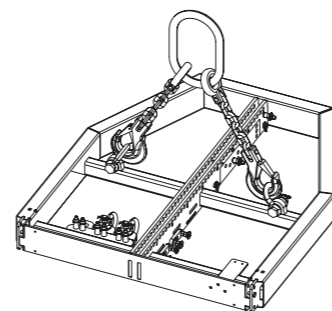

**Z5380**  
**V Flying frame**  
Supplied with  
1 x 5382 V Safety chainset  
2 x V Load adapter  
1 x V Load adapter for Rota clamp  
2 x Front links



**Z5381**  
**V Hoist connector chain**



**Z5382**  
**V Safety chainset**



**E6507**  
**1t Shackle**

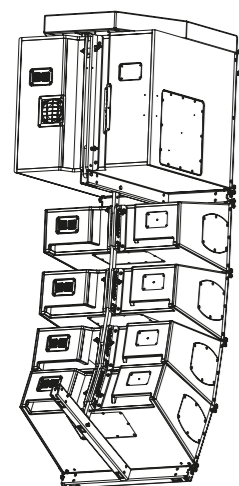

**Vi array with Z5380 V Flying frame**  
**Z5387.001 Vi Mounting frame bottom (2 pcs)**

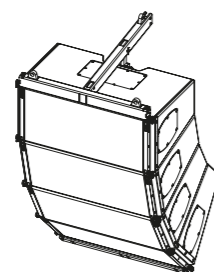

**Vi8/Vi12 array with Z5387.000 Vi Mounting frame top**

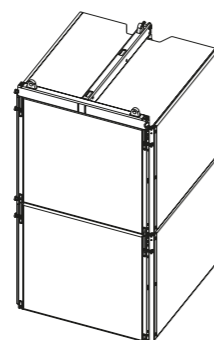

**Vi-SUB column with Z5387.000 Vi Mounting frame top**

# The V8, V12 and V Flying frame cases and carts

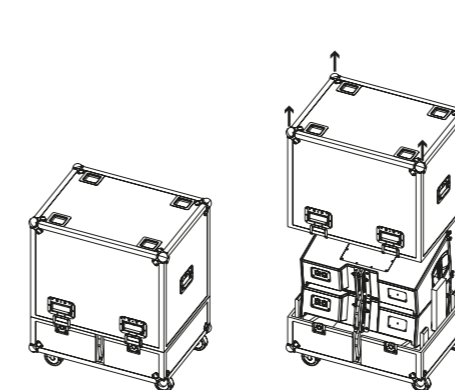

**E7462**  
**Touring case 2 x V8/V12**  
Dimensions (H x W x D):  
900 x 800 x 600 mm  
35.4 x 31.5 x 23.6 inch  
Net weight: 40 kg (88 lb)

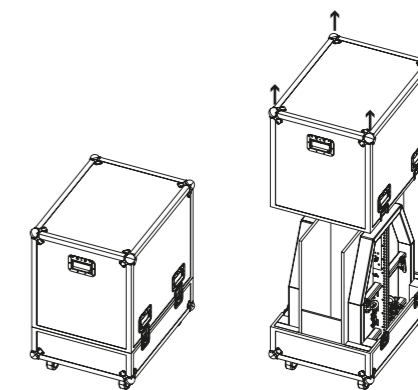

**E7465**  
**Touring case 2 x V Flying frame**  
Dimensions (H x W x D):  
970 x 800 x 600 mm  
38.2 x 31.5 x 23.6 inch  
Net weight: 52 kg (120 lb)

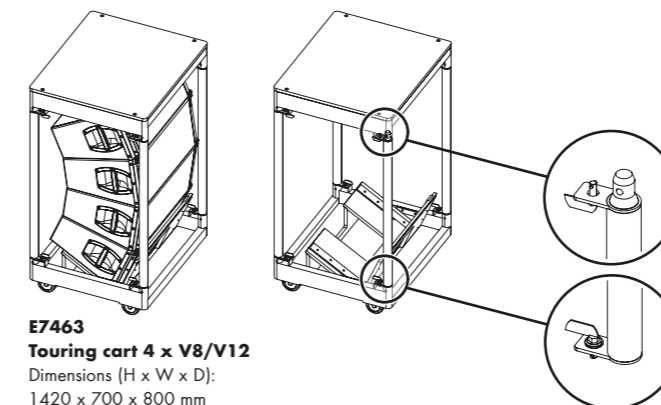

**E7463**  
**Touring cart 4 x V8/V12**  
Dimensions (H x W x D):  
1420 x 700 x 800 mm  
56 x 27.5 x 31.5 inch  
Total weight: 190 kg (420 lb)  
Maximum top load: 100 kg (220 lb)

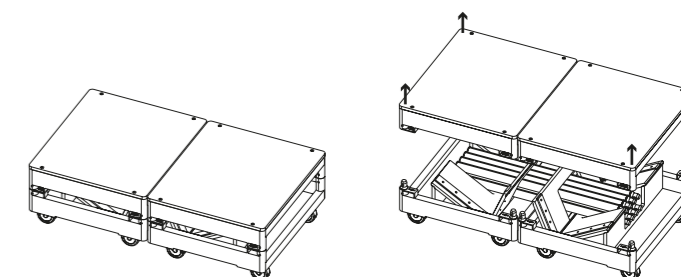

**E7464**  
**Touring cart 8 x V8/V12**  
Dimensions (H x W x D):  
1420 x 1400 x 800 mm  
56 x 55 x 31.5 inch  
Total weight: 360 kg (800 lb)  
Maximum top load: 200 kg (440 lb)

# The d&b ArrayCalc simulation software

The d&b ArrayCalc simulation software is the simulation tool for d&b line arrays, column and point source loudspeakers as well as subwoofers. This is a comprehensive toolbox for all tasks associated with acoustic design, performance prediction, alignment, rigging and safety parameters. For safety reasons d&b line arrays must be designed using the d&b ArrayCalc simulation software. d&b ArrayCalc is available as a native stand-alone application for both Microsoft Windows<sup>1</sup> (Win7 or higher) and Mac OS X<sup>2</sup> (10.6 or higher) operating systems. Listening planes can be defined in the venue tab, creating a three dimensional representation of any audience area in a given venue. All sources can be time aligned, additionally the phase response of a flown system and a ground stacked SUB array can be calculated at a definable reference point. The level distribution resulting from the interaction of all active sources can be mapped onto the previously defined audience areas in a three-dimensional view, which can also be zoomed, rotated and exported as a graphics file. The Remote ID for all devices can be managed in the amplifier tab. EASE and DXF data export capabilities are also available.

The ArrayProcessing function applies powerful filter algorithms to optimize the tonal (spectral) and level (spatial) performance of a line array column over the audience area defined by its mechanical vertical coverage angle. Within the d&b ArrayCalc simulation software, spectral and level performance targets over the listening areas can be defined while specific level drops or offsets can be applied to certain areas, to assign reduced level zones. ArrayProcessing applies a combination of FIR and IIR filters to each individual cabinet in an array to achieve the targeted performance, with an additional latency of only 5.9 ms. This significantly improves the linearity of the response over distance as well as seamlessly correcting for air absorption. In addition, ArrayProcessing employs the same frequency response targets for all d&b line arrays, to ensure all systems share a common tonality. This provides consistent sonic results regardless of array length or splay settings. The resulting coverage is enhanced with spectral consistency and defined level distribution, achieving more linear dispersion and total system directivity to cover longer distances or steep listening areas effectively. The R1 Remote control software uses the data defined in ArrayCalc to generate an intuitive graphical user interface including complete details of the simulated system, including loudspeakers, amplifiers, remote IDs, groups, ArrayProcessing data and all configuration information. This workflow removes the need to manually transfer data from one software program to the other.

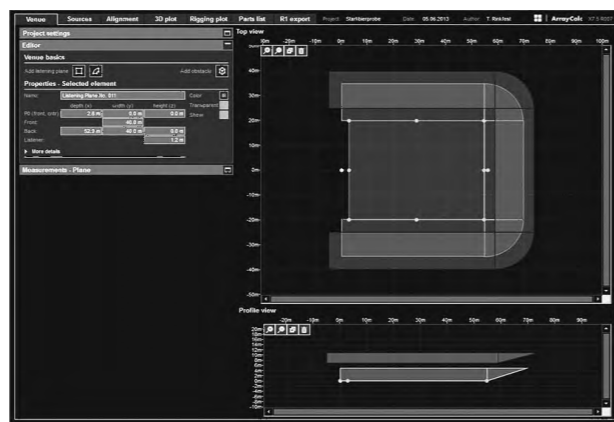

Venue editor

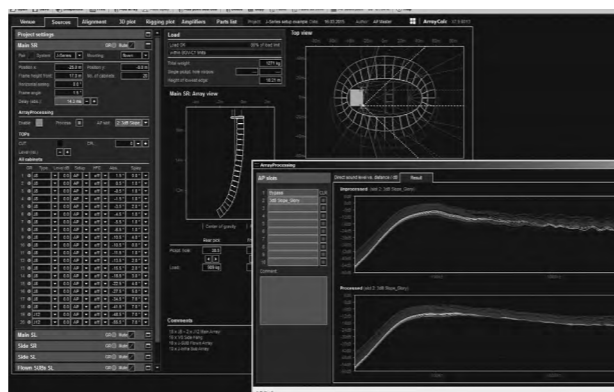

ArrayProcessing

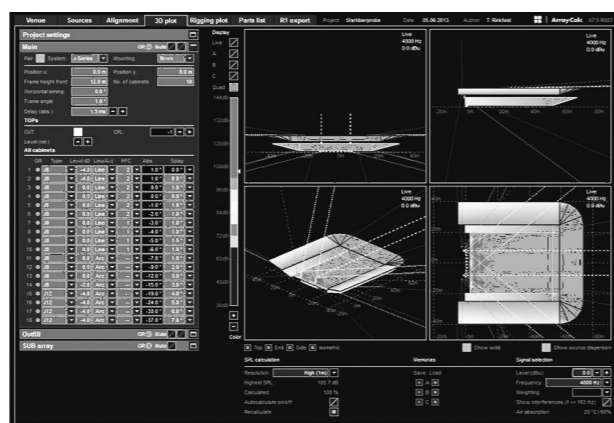

3D Plot quad

# The d&b Remote network

The remote control capability of the d&b Remote network enables central control and monitoring of a complete d&b loudspeaker system from anywhere in the network, be it from a computer in the control room, at the mix position, or on a wireless tablet in the auditorium. This central access to all functions through the d&b Remote network, to controls as well as detailed system and device diagnostics information, unlocks the full potential of the d&b system approach. In a typical user workflow, the d&b Remote network takes settings optimized in the ArrayCalc simulation software and applies these to all the amplifiers within the network. The importation of settings from ArrayCalc allows the system configuration to be quickly accomplished, providing more time for verification and fine tuning.

All features, functions and controls available on the front panel of d&b amplifiers may be remotely controlled and/or monitored using R1 Remote control software. This allows each channel of the amplifier to be controlled and enables the creation of groups of loudspeakers. When grouped together, a button or fader can control the overall system level, zone level, equalization and delay, power ON/OFF, MUTE, as well as loudspeaker specific function switches such as CUT/HFA/HFC and CPL. An offline mode is provided for preparation in advance of an event, without the amplifiers being present or connected.

For mobile applications, d&b System check verifies that the system performs within a predefined condition. Extensive facilities for storing and recalling system settings are provided allowing these to be repeated, as and when required. Project files can be easily adjusted for use with a different set of equipment at another location.

In installation projects system integrators can configure the d&b Remote network to offer access to different levels of control, tailored to the operational demands. For example, power ON/OFF for daily use, or more complex functionality for detailed control. Password protection is available to restrict access. Input and Load monitoring allow installation operators to ensure optimum performance at all times.

R1 Remote control software enables d&b amplifiers to be remotely controlled using both Ethernet and CAN-Bus in parallel. The software is optimized for use with touch screen, mouse and keyboard and runs on both Microsoft Windows<sup>1</sup> (Win7 or higher) and Mac OS X<sup>2</sup> (10.6 or higher) operating systems. Further information is provided in the d&b Amplifier and Software brochure which is available for download at [www.dbaudio.com](http://www.dbaudio.com).

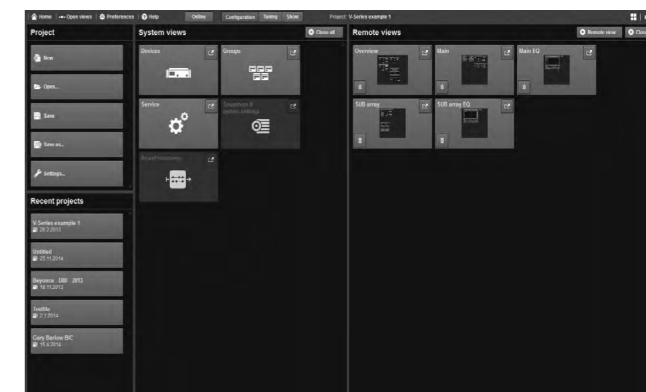

Home



Remote in Configuration mode



Open views

<sup>1</sup> Microsoft Windows is a registered trademark or trademark of Microsoft Corporation in the United States and/or other countries  
<sup>2</sup> Mac OS is a trademark of Apple Inc., registered in the U.S. and other countries

# The d&b amplifiers

The d&b amplifiers are designed specifically to power d&b loudspeakers and are the beating heart of the d&b System reality. As such, they incorporate Digital Signal Processing for comprehensive loudspeaker management, switchable filter functions, remote capabilities and user-definable controls, to fulfil the exact needs of each application. Every loudspeaker configuration combines comprehensive system limiting, and equalization and crossover settings to ensure consistent results and optimal performance. d&b amplifiers offer

different output configurations for different loudspeaker setups, including Dual Channel mode, for passive setups, Mix TOP/SUB mode, in which two channels are driven through a single output connector, and 2-Way Active mode, which also sends the output of two channels down one connector to drive appropriate loudspeakers actively. The d&b switch functions provide selected filters to precisely tailor a wide variety of setups to their applications. Examples of these switch functions are the CSA (Cardioid Subwoofer Array)

and HFC (High Frequency Compensation) modes. CSA increases low frequency directivity control by minimising energy transmission towards the rear while HFC compensates for air absorption for loudspeakers covering far field listening positions. In addition to these functions, d&b amplifiers offer a comprehensive set of specific filters such as CUT, a cut mode for TOP loudspeakers when used with d&b subwoofers; CPL, to compensate for the coupling effect between loudspeakers in close proximity to other loudspeakers or hard objects and HFA

mode, to attenuate the high frequencies of a loudspeaker to mimic the effect of far field listening. These devices offer extended, user-definable equalization and delay capabilities, eliminating the need for external processing devices in the signal chain. All d&b amplifiers integrate with the d&b Remote network to enable the remote control and management of systems from anywhere within a network. Further information is provided in the d&b Amplifier and Software brochure which is available for download at [www.dbaudio.com](http://www.dbaudio.com).

## Comparison of the d&b amplifiers

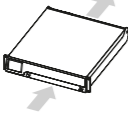
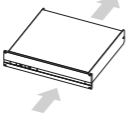
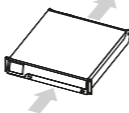
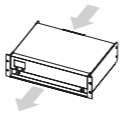
	D80	30D	D20	D12
User interface	Encoder/colour TFT touchscreen	LED indicators	Encoder/colour TFT touchscreen	Encoder/LC display
Output channels	4	4	4	2
Input channels	4 x AES or 4 x analog or 2 x AES and 2 x analog	4 x AES and 4 x analog	4 x AES or 4 x analog or 2 x AES and 2 x analog	2 x AES or 2 x analog
Latency	0.3 msec	0.3 msec	0.3 msec	0.3 msec
User equalizers (per channel)	2 x 16-band	2 x 16-band	2 x 16-band	4-band
Delay	10 sec/3440 m	10 sec/3440 m	10 sec/3440 m	340 msec/116.9 m
Maximum output power (THD+N < 0.5%, 12 dB crest factor)	4 x 2000 W into 8 ohms 4 x 4000 W into 4 ohms	4 x 800 W into 8 ohms 4 x 1600 W into 4 ohms	4 x 800 W into 8 ohms 4 x 1600 W into 4 ohms	2 x 800 W into 8 ohms 2 x 1600 W into 4 ohms
Output routing	Dual Channel, Mix TOP/SUB 2-Way Active	Dual Channel, Mix TOP/SUB 2-Way Active	Dual Channel, Mix TOP/SUB 2-Way Active	Dual Channel, Mix TOP/SUB 2-Way Active
Output connectors	NL4/EP5 plus central NL8	Phoenix Euroblock	NL4 plus central NL8	NL4/EP5/NL8
GPIO connector, 5 ports	No	Phoenix Euroblock	No	No
Cable compensation	LoadMatch	LoadMatch	LoadMatch	SenseDrive
Power supply	Autosensing switched mode power supply with active PFC	Universal range switched mode power supply with active PFC	Universal range switched mode power supply with active PFC	Autosensing switched mode power supply
Mains voltage	100 - 127/208 - 240 V, 50 - 60 Hz	100 - 240 V, 50 - 60 Hz	100 - 240 V, 50 - 60 Hz	115/230 V or 100/200 V, 50 - 60 Hz
Weight (kg/lb)	19/42	10.6 / 23.4	10.8/23.8	13/28.7
Dimensions	2 RU x 19" x 530 mm	2 RU x 19" x 435 mm	2 RU x 19" x 460 mm	3 RU x 19" x 353 mm
Remote	OCA via Ethernet/CAN	OCA via Ethernet/CAN	OCA via Ethernet/CAN	CAN
Airflow				

# The operation with d&b amplifiers

## Amplifier controller setups

### Arc and Line mode

The Arc mode is intended for line array loudspeakers when used in curved array sections. The Line mode is used for long throw array sections with three or more consecutive splay settings of 0°, 1° or 2°. Compared to the Arc mode, the mid/high range is reduced to compensate for the extended near field.

### CUT mode

Set to CUT, the cabinet low frequency level is reduced and it is now configured for use with the d&b V or J subwoofers.

### HFC mode

Selecting the HFC (High Frequency Compensation) mode compensates for loss of high frequency energy due to absorption in air when loudspeakers are used to cover far field listening positions. HFC has two settings which should be used selectively, HFC1 for cabinets covering distances larger than 30 m (100 ft) and HFC2 for those covering distances larger than 60 m (200 ft). This can be used to achieve the correct sound balance between close and remote audience areas allowing all amplifiers driving the array to be fed from the same signal source. Thus the whole array performs with comparable headroom.

### HFA mode

In HFA mode (High Frequency Attenuation), the HF response of the system is rolled off. HFA provides a natural, balanced frequency response when a unit is placed close to listeners in near field or delay use. HFA begins gradually at 1 kHz, dropping by approximately 3 dB at 10 kHz. This roll off mimics the decline in frequency response experienced when listening to a system from a distance in a typically reverberant room or auditorium.

### CPL function

The CPL (Coupling) function compensates for coupling effects between the cabinets of an array. CPL begins gradually around 2 kHz, with the maximum attenuation below 100 Hz. As coupling effects increase with the length of the line array, the CPL circuit can be set to dB attenuation values between 0 and -9.

## 100 Hz mode

The 100 Hz mode limits the upper operating frequency of the subwoofer to 100Hz, complementing top cabinets in full range mode.

## Recommended amplifiers for mobile applications

	V7P	V10P	V-GSUB	V8	V12	V-SUB
<b>D80</b>	x	x	x	x	x	x

## Recommended amplifiers for installation applications

	Vi7P	Vi10P	Vi-GSUB	Vi8	Vi12	Vi-SUB
<b>D80</b>	x	x	x	x	x	x
<b>30D</b>	x	x	x	x	x	x

## Maximum loudspeakers per amplifier channel

	V7P Vi7P	V10P Vi10P	V-GSUB Vi-GSUB	V8 Vi8	V12 Vi12	V-SUB Vi-SUB
	2	2	2	2	2	2

## Available controller settings

	V7P Vi7P	V10P Vi10P	V-GSUB Vi-GSUB	V8 Vi8	V12 Vi12	V-SUB Vi-SUB
<b>Arc/Line</b>				x	x	
<b>CUT</b>	x	x		x	x	
<b>HFC</b>				x	x	
<b>HFA</b>	x	x				
<b>CPL</b>	x	x		x	x	
<b>100 Hz</b>			x			x

# The V-Series frequency responses

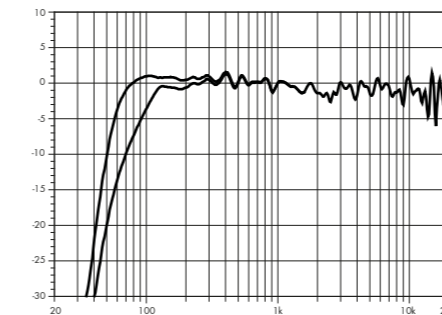

V7/Vi7P standard and CUT (single cabinet)

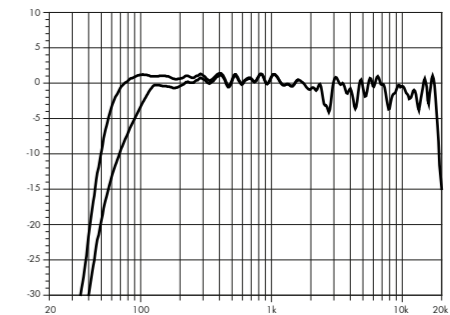

V10/Vi10P standard and CUT (single cabinet)

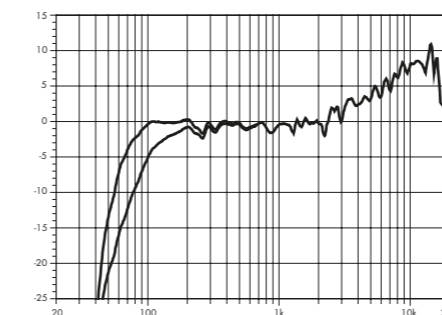

V8/Vi8 standard and CUT (single cabinet)

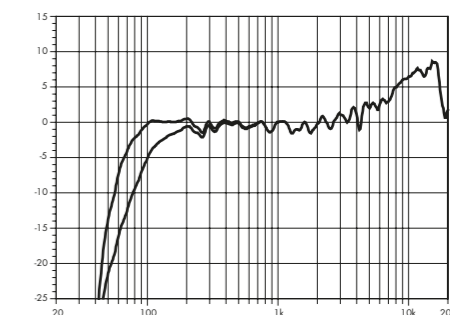

V12/Vi12 standard and CUT (single cabinet)

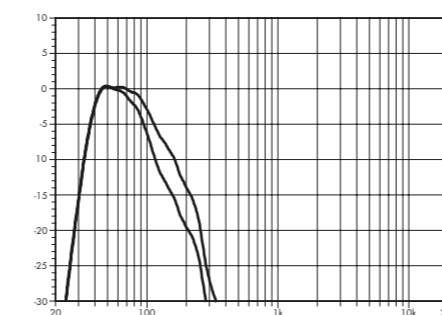

V-SUB/Vi-SUB and V-GSUB/Vi-GSUB standard and 100 Hz

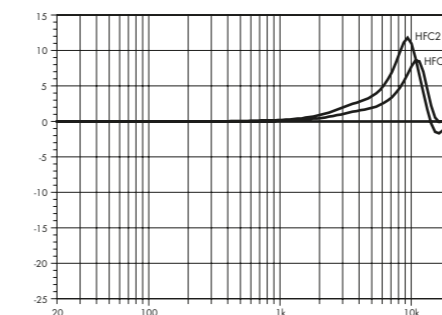

Correction of HFC

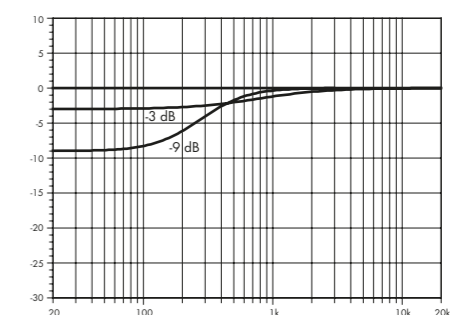

Correction of CPL

# The d&b amplifier output modes

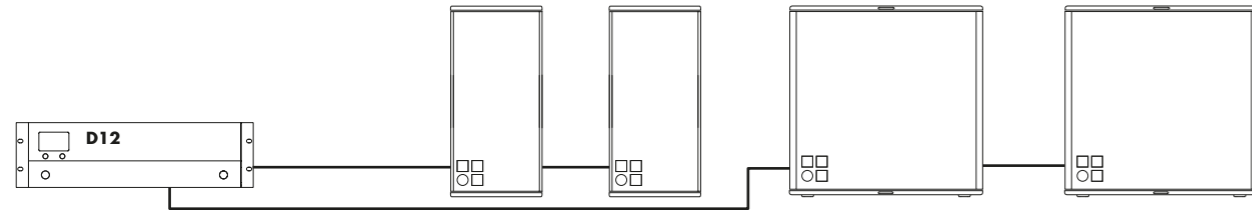

**D12 amplifier in Dual Channel mode for V7P, V10P, Vi7P, Vi10P, V8, V12, Vi8, Vi12 as well as V-GSUB, Vi-GSUB, V-SUB and Vi-SUB**

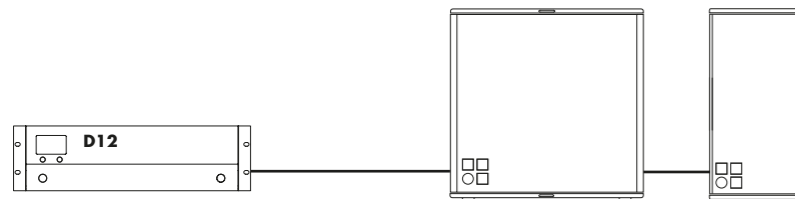

**D12 amplifier in Mix TOP/SUB mode for V7P, V10P, Vi7P, Vi10P, V8, V12, Vi8, Vi12 as well as V-GSUB, Vi-GSUB, V-SUB and Vi-SUB**

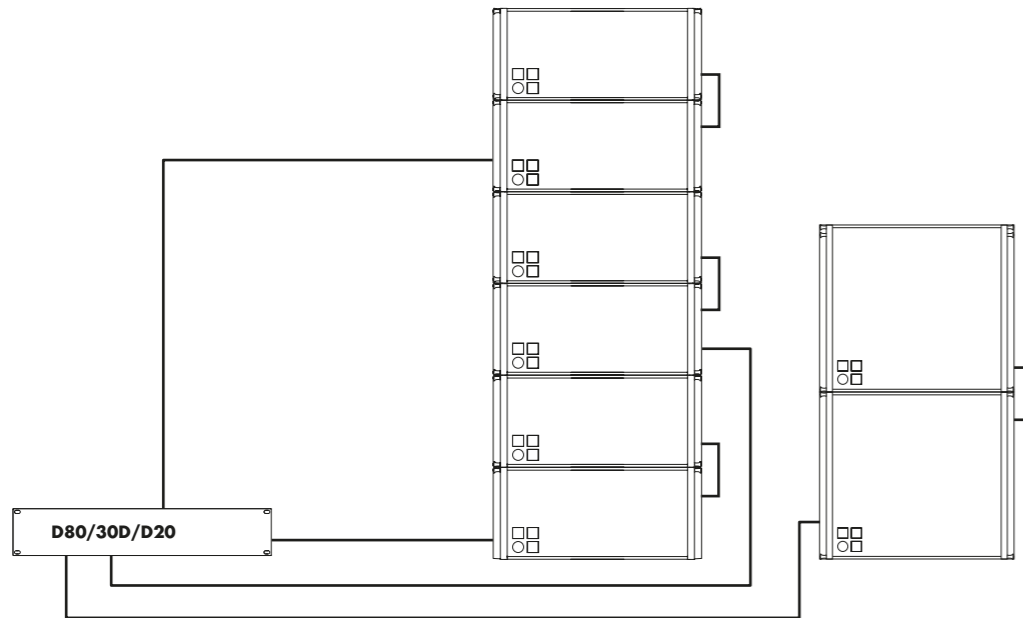

**D80/30D/D20 amplifier in Dual Channel mode for V7P, V10P, Vi7P, Vi10P, V8, Vi8, V12, Vi12 as well as V-GSUB, Vi-GSUB, V-SUB and Vi-SUB**

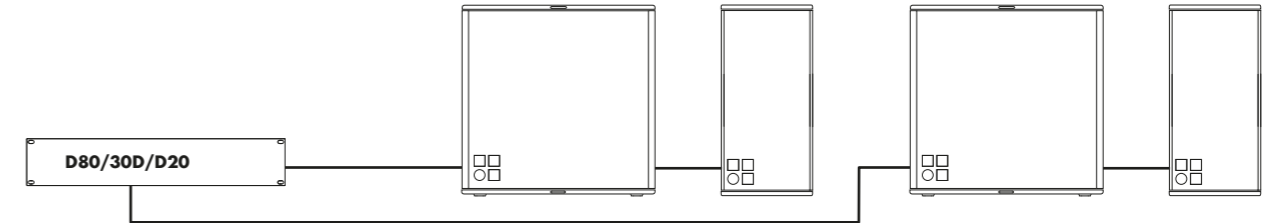

**D80/30D/D20 amplifier in Mix TOP/SUB mode for V7P, V10P, Vi7P, Vi10P, V8, V12, Vi8, Vi12 as well as V-GSUB, Vi-GSUB, V-SUB and Vi-SUB**

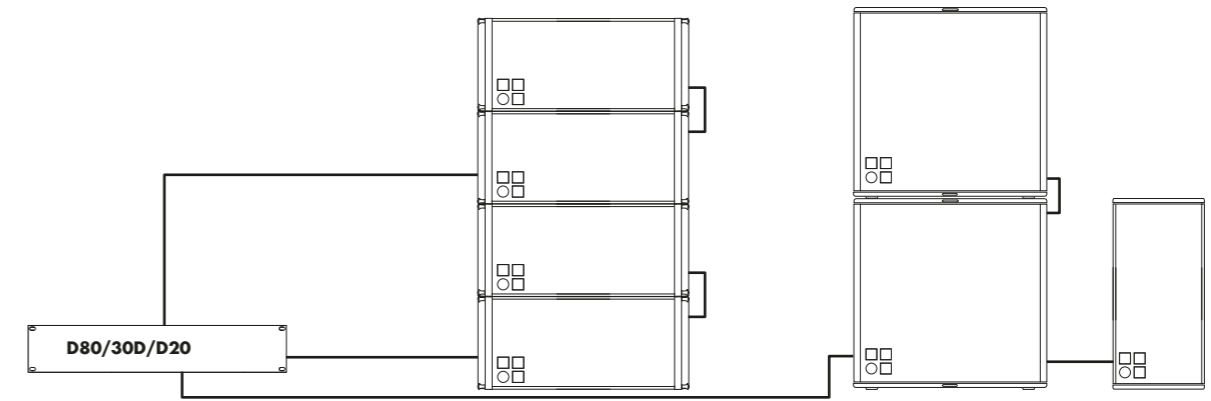

**D80/30D/D20 amplifier in a mixed configuration of Dual Channel and Mix TOP/SUB mode for V7P, V10P, Vi7P, Vi10P, V8, V12, Vi8, Vi12 as well as V-GSUB, Vi-GSUB, V-SUB and Vi-SUB**



# The V-Series cables and adapters

## Amplifiers in Dual Channel mode

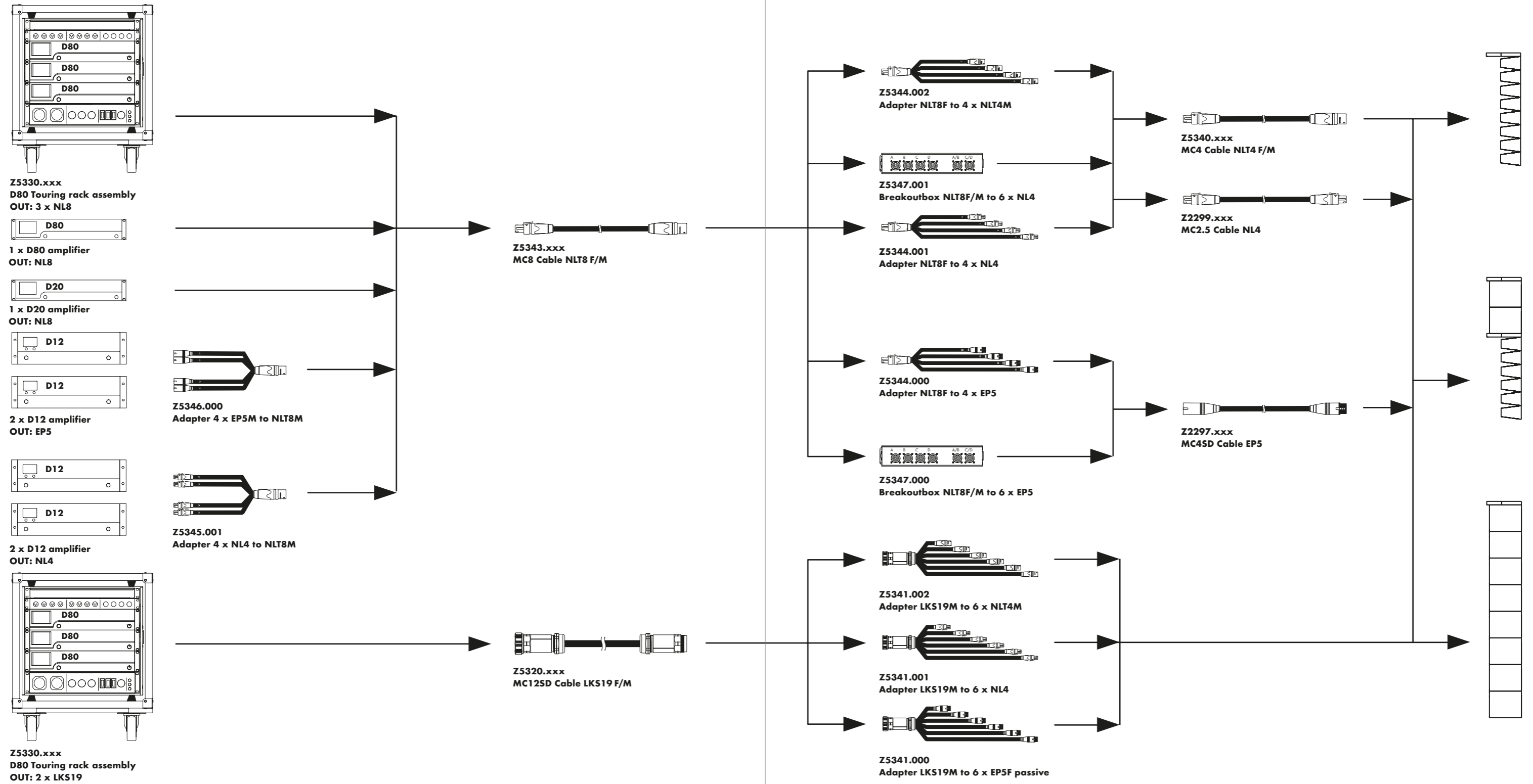

# The V-Series configuration examples

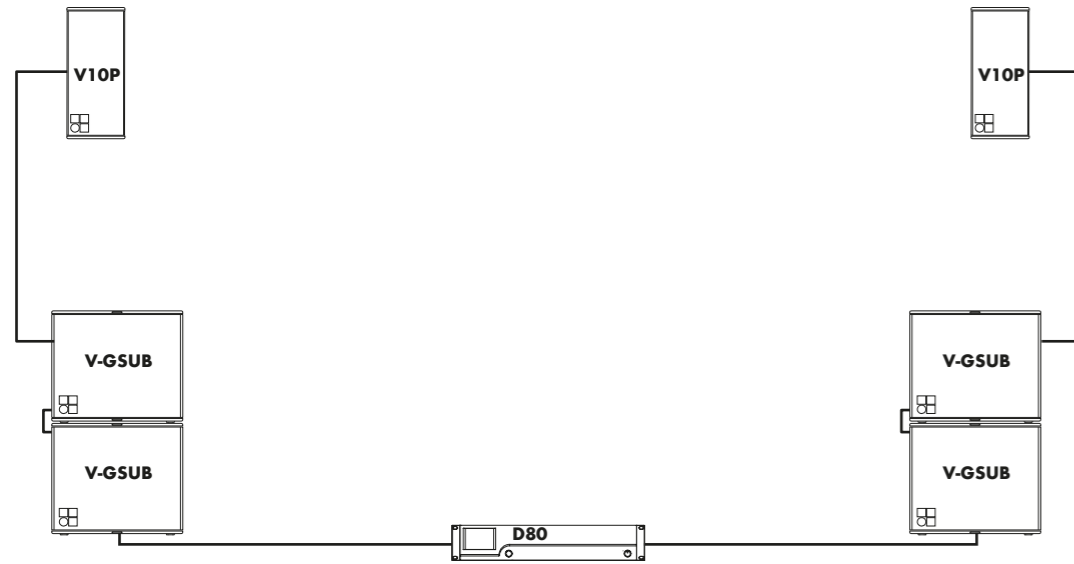

V-Series L/R configuration comprising V10Ps and V-GSUBs with a D80 amplifier in Mix TOP/SUB mode

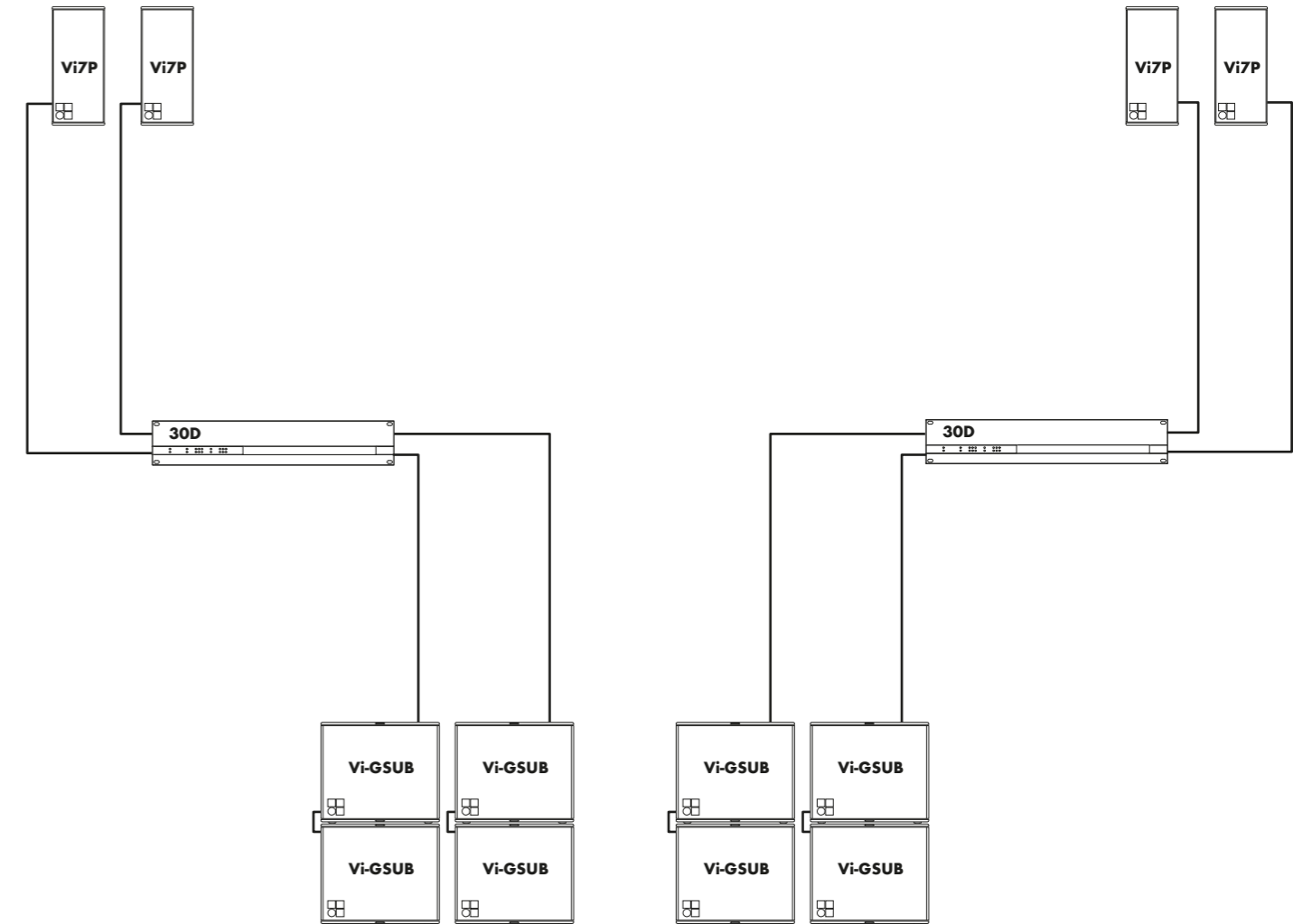

Vi7P loudspeakers in a distributed point source system and ground stacked Vi-GSUBs, with 30D amplifiers in Dual Channel mode

# The V-Series configuration examples

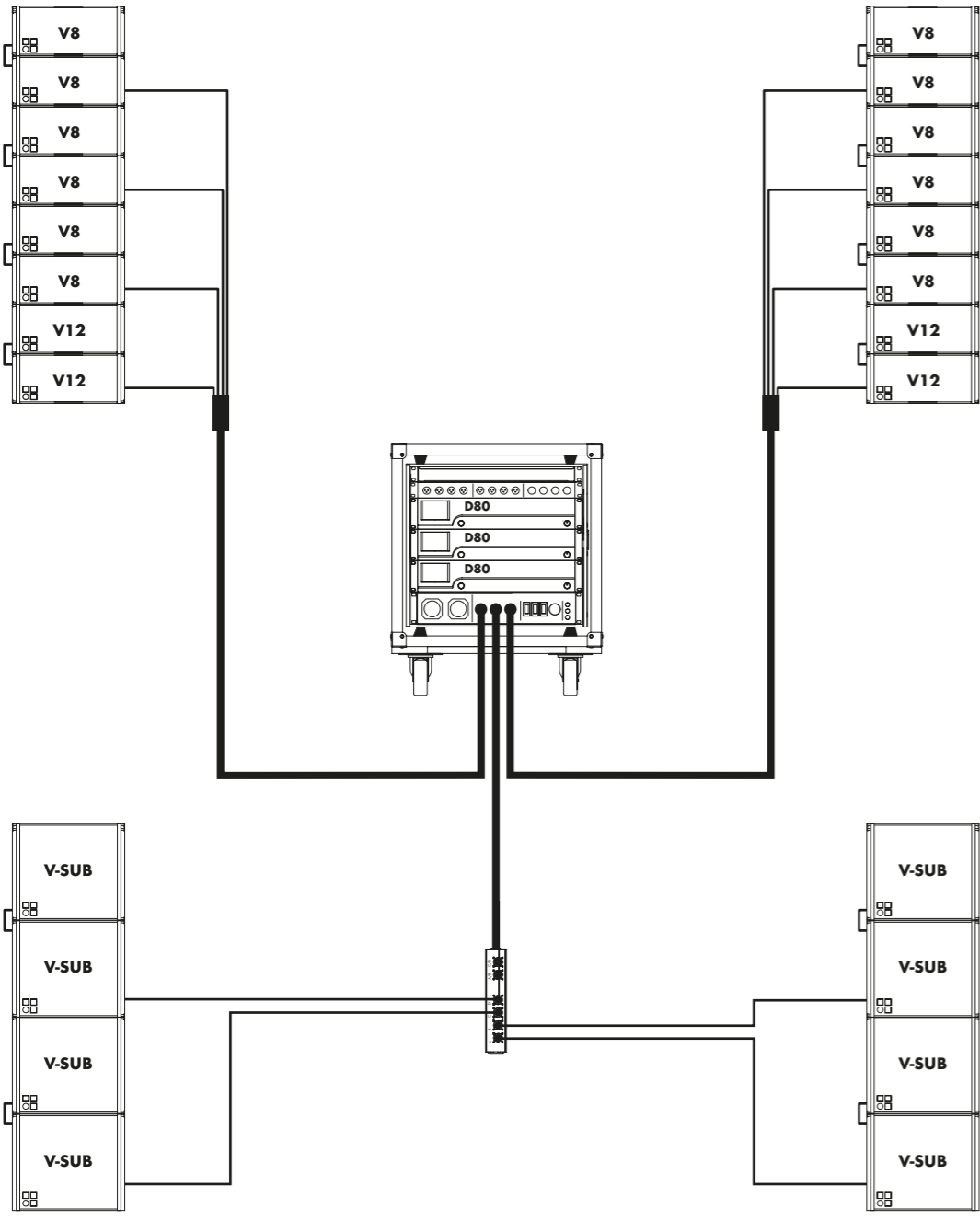

V-Series L/R configuration with V8/V12 flown line array and ground stacked V-SUBs with D80 Touring rack

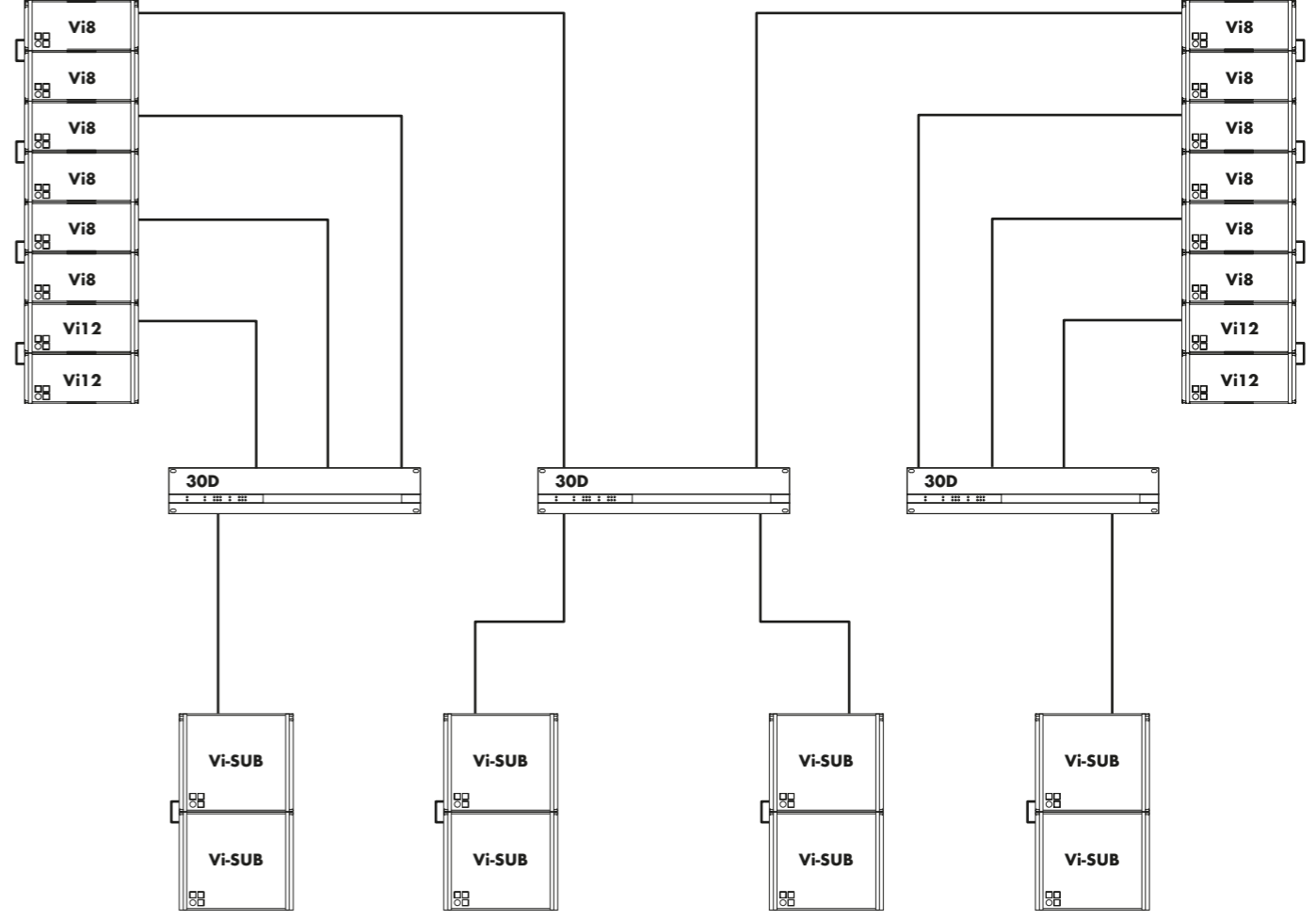

Vi line array in L/R configuration with flown Vi8/Vi12s with ground stacked Vi-SUBs with 30D amplifiers in Dual Channel mode

# The V-Series configuration examples

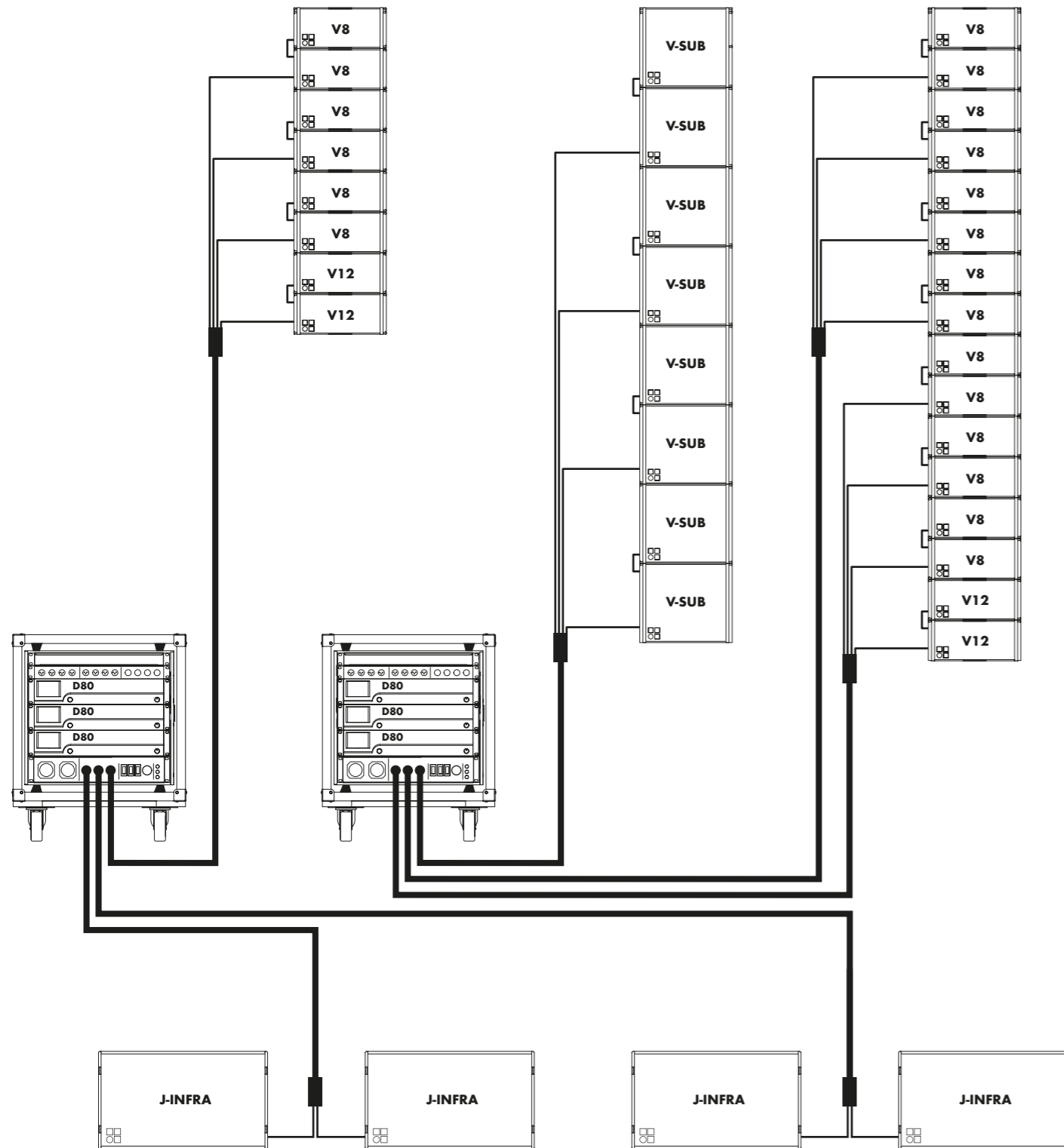

V8/V12 and V-SUB main arrays, V8/V12 outfills and ground stacked J-INFRAs with D80 Touring racks<sup>1</sup>

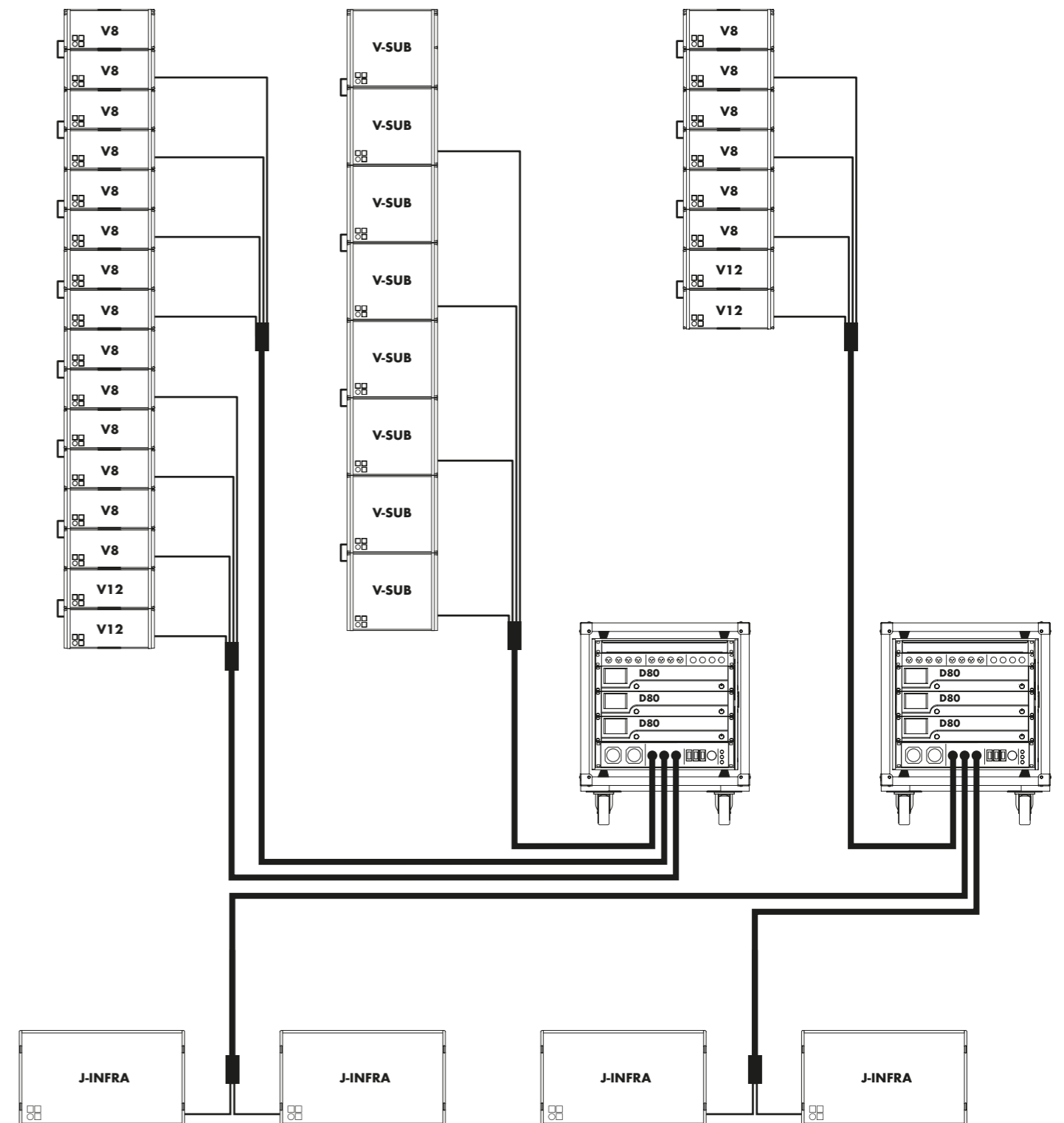

# The V-Series configuration examples

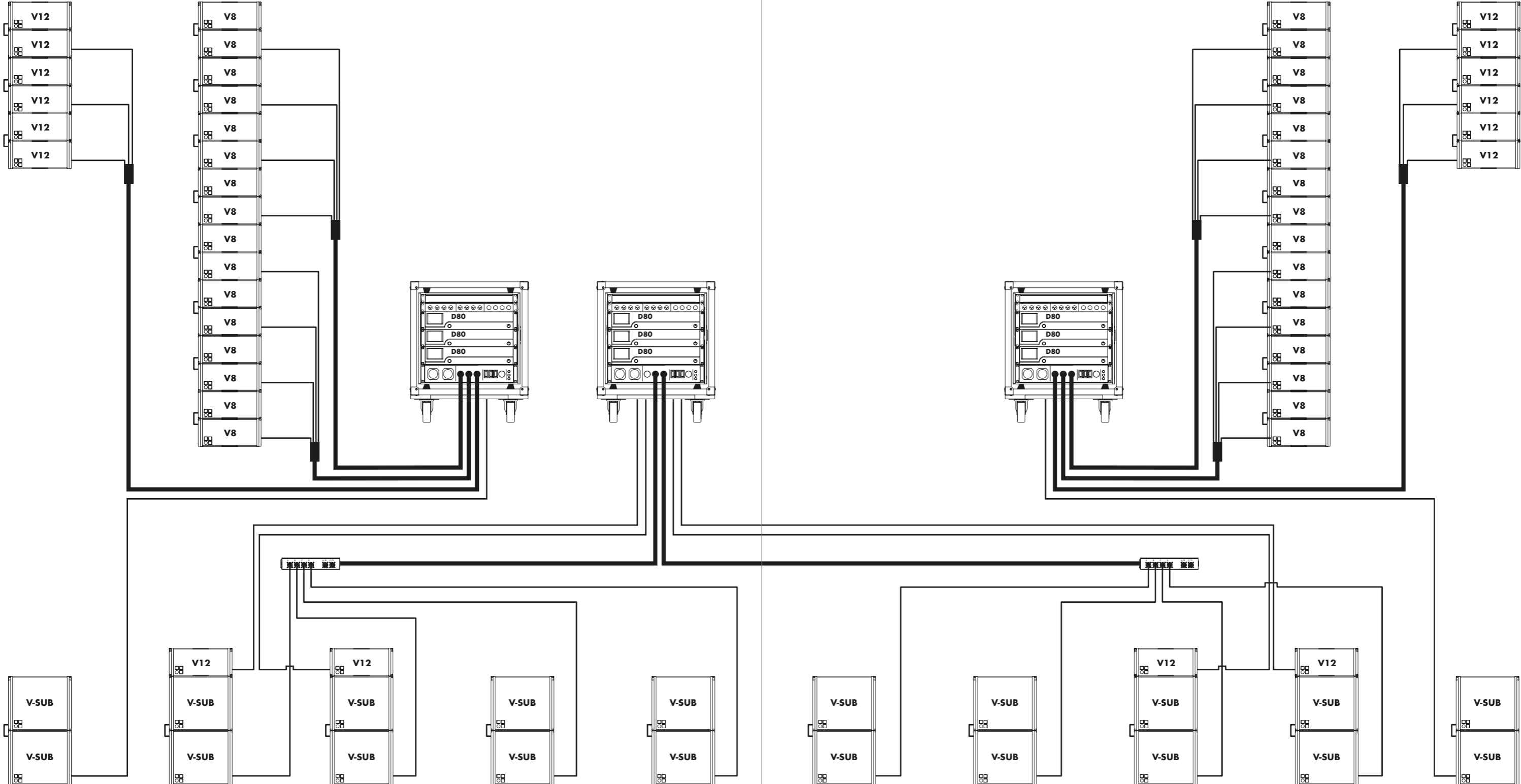

V-Series configuration comprising V8 mains and V12 outfill arrays along with ground stacked V-SUBs and V12 as nearfills with D80 Touring racks'

# The V-Series product overview

<b>V loudspeakers</b>	Z0704.xxx Z0705.xxx Z0515.xxx Z0516.xxx Z0518.xxx Z0519.xxx	<b>V7P Loudspeaker</b> <b>V10P Loudspeaker</b> <b>V8 Loudspeaker</b> <b>V12 Loudspeaker</b> <b>V Subwoofer</b> <b>V-GSUB</b>	Z5550.000 Z5010.000 Z5012.500 Z5049.000 Z5013.000 Z5009.000 Z5024.000	<b>M20 Stand adapter</b> <b>TV spigot with fixing plate</b> <b>Pipe clamp for TV spigot</b> <b>Flying pin 8mm</b> <b>Loudspeaker stand winder M20</b> <b>Loudspeaker stand with winder</b> <b>Loudspeaker stand adapter</b>	
<b>Loudspeaker connector options</b>	Zxxxx.000 Zxxxx.001 Zxxxx.002	<b>EP5</b> connector <b>NL4</b> connector <b>NLT4 F/M</b> connector	<b>Remote network</b>	Z3010.000 Z6118.000 Z6124.000 Z6116.000 Z6122.000 Z6123.000	<b>R1 Remote control software</b> <sup>4</sup> <b>R60 USB to CAN interface</b> <b>R70 Ethernet to CAN interface</b> <b>RJ 45 M Terminator</b> <b>Bopla mounting clamp</b> <b>Bopla mounting clamp upright</b>
<b>Vi loudspeakers</b>	Z0724.001 Z0725.001 Z0535.001 Z0536.001 Z0538.001 Z0520.001	<b>Vi7P Loudspeaker NL4</b> connector <b>Vi10P Loudspeaker NL4</b> connector <b>Vi8 Loudspeaker NL4</b> connector <b>Vi12 Loudspeaker NL4</b> connector <b>Vi Subwoofer NL4</b> connector <b>Vi-GSUB NL4</b> connector <b>WR Weather Resistant option</b> <sup>1</sup> <b>SC Special Colour option</b> <sup>2</sup>	<b>Amplifiers</b>	Z2710.xxx Z2770.xxx Z2600.xxx Z2750.xxx	<b>D80 Amplifier</b> <sup>5</sup> <b>30D Amplifier</b> <sup>6</sup> <b>D12 Amplifier</b> <sup>5</sup> <b>D20 Amplifier NL4</b> <sup>5</sup>
<b>Cases</b>	E7462.000 E7465.000 E7466.000	<b>Touring case 2 x V8/V12</b> <b>Touring case 2 x V Flying frame</b> <b>Touring case 2 x V7P/V10P</b>	<b>Amplifier rack assemblies</b>	Z5310.000 Z5310.001 Z5330.001 Z5330.xxx	<b>D12 Touring rack assembly EP5</b> <sup>7</sup> <b>D12 Touring rack assembly NL4</b> <sup>7</sup> <b>D80 Touring rack assembly, CEE 32A 5P</b> <sup>7</sup> <b>D80 Touring rack assembly, Nema L21-30 (120V devices)</b> on request <sup>7</sup>
<b>Carts</b>	E7463.000 E7464.000	<b>Touring cart 4 x V8/V12</b> <b>Touring cart 8 x V8/V12</b>	<b>Amplifier racks</b>	E7480.000 E7468.000 E7419.000 E7420.000	<b>D20 Touring rack 2 RU 19"</b> SD, shock mounted, handles <b>D80 Touring rack 2 RU, 19"</b> SD, shock mounted, handles <b>Touring rack 3 RU, 19"</b> DD, shock mounted, handles, window <b>Touring rack 6 RU, 19"</b> DD, shock mounted, handles, window, wheels
<b>Lids</b>	E7923.000 E7926.000	<b>V-SUB Wooden lid</b> <b>V-GSUB Wooden lid</b>	<b>Cables and adapters</b>	Z5343.xxx Z5346.000 Z5345.001 Z5320.xxx Z5344.002 Z5344.001 Z5344.000 Z5347.001 Z5347.000 Z5340.xxx Z2299.xxx Z2297.xxx Z5341.002 Z5341.001 Z5341.000	<b>MC8 Cable NLT8 F/M</b> <b>Adapter 4 x EP5M to NLT8M</b> <b>Adapter 4 x NL4 to NLT8M</b> <b>MC12SD Cable LKS19 F/M</b> <b>Adapter NLT8F to 4 x NLT4M</b> <b>Adapter NLT8F to 4 x NL4</b> <b>Adapter NLT8F to 4 x EP5</b> <b>Breakoutbox NLT8 F/M to 6 x NL4</b> <b>Breakoutbox NLT8 F/M to 6 x EP5</b> <b>MC4 Cable NLT4 F/M</b> <b>MC2.5 Cable NL4</b> <b>MC4SD Cable EP5</b> <b>Adapter LKS19 M to 6 x NLT4M</b> <b>Adapter LKS19 M to 6 x NL4</b> <b>Adapter LKS19M to 6 x EP5</b>
<b>V/Vi accessories</b>	Z5380.000 Z5381.000 Z5382.000	<b>V Flying frame</b> <sup>3</sup> (supplied with Z5382 V Safety chainset) <b>V Hoist connector chain</b> <b>V Safety chainset</b>			
<b>V accessories</b>	Z5385.000 Z5386.000 Z5147.000	<b>V Flying adapter</b> <b>V Stack adapter</b> <b>Rota clamp</b>			
<b>Vi accessories</b>	Z5387.000 Z5387.001 E6507.000	<b>Vi Mounting frame top</b> <sup>3</sup> <b>Vi Mounting frame bottom</b> <sup>3</sup> <b>1t Shackle</b>			
<b>VP accessories</b>	Z5383.000 Z5384.000 Z5388.000 Z5551.000	<b>VP Mounting bracket</b> <sup>3</sup> <b>VP Flying adapter</b> <sup>3</sup> <b>VP Horizontal bracket</b> <sup>3</sup> <b>VP Flying adapter link</b>			

<sup>1</sup> WR only for Vi loudspeakers, on request

<sup>2</sup> SC only for Vi loudspeakers, on request

<sup>3</sup> SC on request

<sup>4</sup> available as a download at [www.dbaudio.com](http://www.dbaudio.com)

<sup>5</sup> the complete list of mobile amplifier versions is available in the D Amplifier and Software brochure

<sup>6</sup> the complete list of installation amplifier versions is available in the xD Installation Amplifier and Software brochure

<sup>7</sup> further information is available in the D Amplifier and Software brochure

