

# M

**M6**  
**Manual 1.2 en**

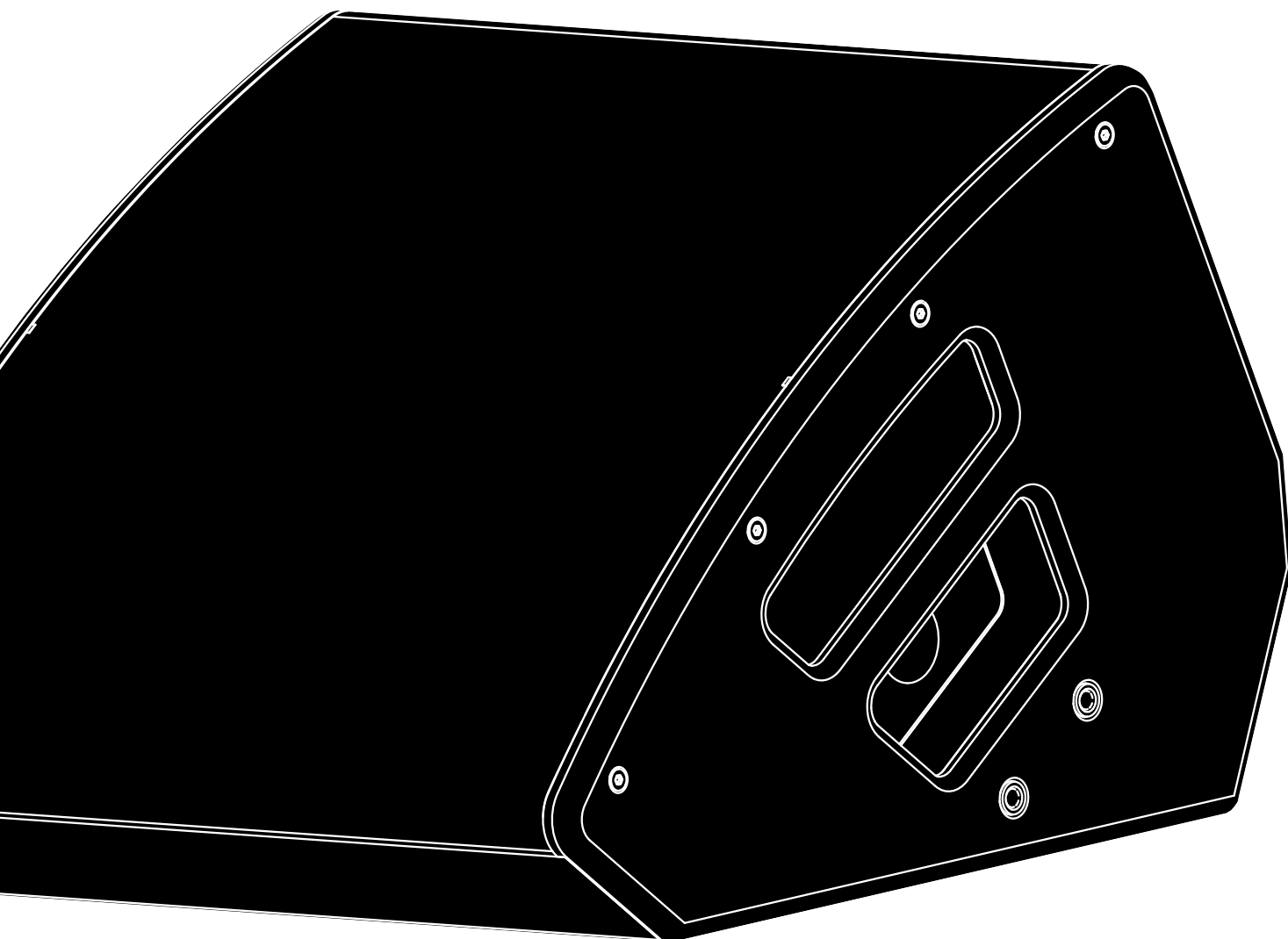

## **General information**

M6 Manual

Version: 1.2 en, 11/2021, D2605.EN .01

Copyright © 2021 by d&b audiotechnik GmbH & Co. KG; all rights reserved.

**Keep this document with the product or in a safe place so that it is available for future reference.**

We recommend you to regularly check the d&b website for the latest version of this document.

When reselling this product, hand over this document to the new owner.

If you supply d&b products, please draw the attention of your customers to this document. Enclose the relevant documents with the systems. If you require additional documents for this purpose, you can order them from d&b.

d&b audiotechnik GmbH & Co. KG  
Eugen-Adolf-Str. 134, D-71522 Backnang, Germany  
T +49-7191-9669-0, F +49-7191-95 00 00

<b>1</b>	<b>Safety precautions</b> .....	<b>4</b>
<b>2</b>	<b>M6 loudspeaker</b> .....	<b>5</b>
2.1	Product description.....	5
2.2	Connections.....	5
2.3	Operation.....	6
2.3.1	Controller settings.....	7
2.3.2	Operation with E-PAC.....	8
2.4	Dispersion characteristics.....	9
2.5	Technical specifications.....	10
<b>3</b>	<b>Manufacturer's declarations</b> .....	<b>11</b>
3.1	Conformity of loudspeakers.....	11
3.2	WEEE Declaration (Disposal).....	11

## **Potential risk of personal injury**

Never stand in the immediate vicinity of loudspeakers driven at a high level. Professional loudspeaker systems are capable of causing a sound pressure level detrimental to human health. Seemingly non-critical sound levels (from approx. 95 dB SPL) can cause hearing damage if people are exposed to it over a long period.

In order to prevent accidents when deploying loudspeakers on the ground or when flown, please take note of the following:

- When setting up the loudspeakers or loudspeaker stands, make sure they are standing on a firm surface. If you place several systems on top of one another, use straps to secure them against movement.
- Only use accessories which have been tested and approved by d&b for assembly and deployment. Pay attention to the correct application and maximum load capacity of the accessories as detailed in our specific "Mounting instructions" or in our "Rigging manuals".
- Ensure that all additional hardware, fixings and fasteners used for deployment are of an appropriate size and load safety factor. Pay attention to the manufacturers' instructions and to the relevant safety guidelines.
- Regularly check the loudspeaker housings and accessories for visible signs of wear and tear, and replace them when necessary.
- Regularly check all load bearing mounting devices.

## **Potential risk of material damage**

Loudspeakers produce a static magnetic field even if they are not connected or are not in use. Therefore make sure when erecting and transporting loudspeakers that they are nowhere near equipment and objects which may be impaired or damaged by an external magnetic field. Generally speaking, a distance of 0.5 m (1.5 ft) from magnetic data carriers (floppy disks, audio and video tapes, bank cards, etc.) is sufficient.

## 2 M6 loudspeaker

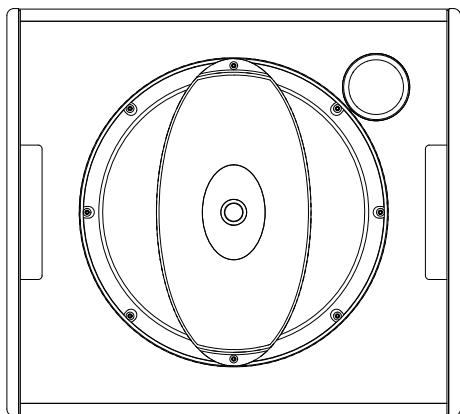

**M6 loudspeaker**

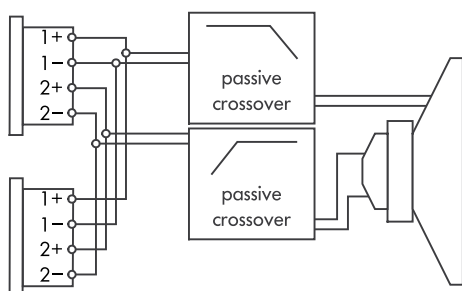

**NLT4 F/M connector wiring**

### 2.1 Product description

The M6

M6 is a high performance stage monitor employing an integrated 12/1.3" exit coaxial driver design with neodymium magnet and constant directivity horn loading. Its dispersion of 50° x 80° (hor. x vert.) provides an accurately defined coverage area on stage. Used upright the M6 serves as a powerful front PA speaker (80° x 50°) for various applications.

The M6 is a two-way design with a built-in passive crossover network. It can optionally be operated in two-way active mode just by changing the configuration of the applicable amplifier without any modifications to the loudspeaker. Its frequency response extends from 65 Hz to above 17 kHz.

The cabinet is constructed from marine plywood and has an impact resistant paint finish. The front of the loudspeaker cabinet is protected by a rigid metal grill in front of an acoustically transparent foam. Each side panel incorporates a handle while four M10 threaded inserts allow connection to different rigging devices and brackets. A pole mount is incorporated in one side panel to accept a loudspeaker stand. Two runners recessed in the bottom panel prevent cabinet movement and protect the bottom panel against scratching.

### 2.2 Connections

The cabinet is fitted with NLT4 F/M connectors. All four pins of both connectors are wired in parallel using the pin assignments 1+/1- (LF) and 2+/2- (HF). Using one connector as the input, the second connector allows for direct connection to a second cabinet.

The cabinet can be supplied with NL4 M or EP5 connectors as an option.

	LF +	LF -	HF +	HF -	n.c.
<b>NLT4 F/M NL4 M</b>	1+	1-	2+	2-	-
<b>EP5</b>	1	2	3	4	5

## 2.3 Operation

### NOTICE!

Only operate d&b loudspeakers with a correctly configured d&b amplifier, otherwise there is a risk of damaging the loudspeaker components.

#### Applicable d&b amplifiers:

D80/D40/D20/D12/D6/40D/30D/10D.

Application	Setup	Cabinets per channel
<b>M6</b> passive	M6 (Dual Channel or Mix TOP/SUB mode)	2
Application	Setup	Cabinets per pair of amplifier channels
<b>M6</b> active	M6 (2-Way Active mode)	2

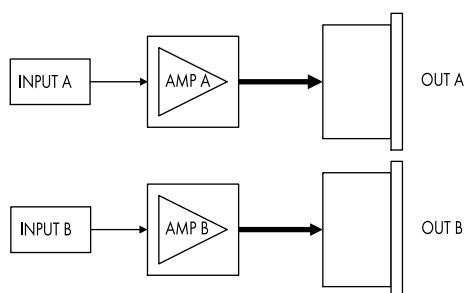

**Input/Output routing "Dual channel"\***

\* Schematic diagram

#### Passive operation ("Dual channel" mode)

Selecting "Dual channel" mode with the M6 setup enables up to two M6 cabinets to be driven by the respective channel.

In "Dual channel" mode each amplifier channel drives all output pins of its respective output connector thus driving the cabinet's HF and LF sections via their passive crossover networks. Pins 1+/2+ of the NL4 output connector (EP5: 1/3) carry the positive and pins 1-/2- (EP5: 2/4) carry the negative components of the signal.

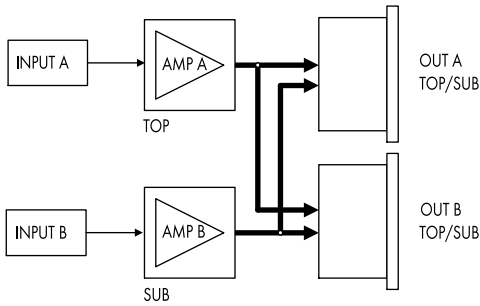

**Input/Output routing "Mix TOP/SUB"**  
\* Schematic diagram

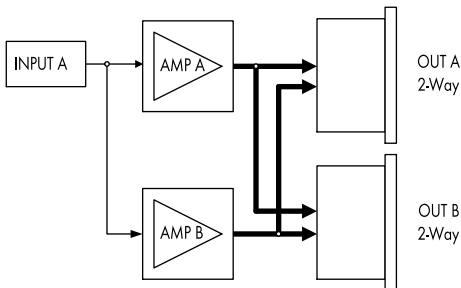

**Input/Output routing "2-Way Active"**  
\* Schematic diagram

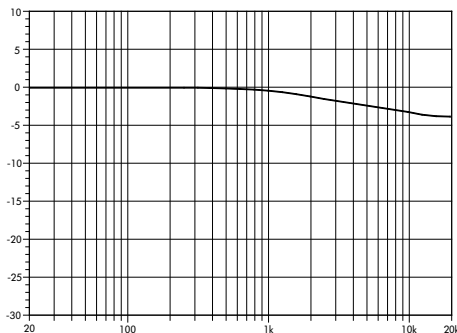

**Frequency response correction in HFA mode**

**Passive operation ("Mix TOP/SUB" mode)**

With its standard connector wiring the M6 requires 4 wires to be driven and therefore cannot be used in "Mix TOP/SUB" mode. However, for permanent passive use with dedicated 2-wire cabling the M6 setup is also available in "Mix TOP/SUB" mode.

For passive operation with a 2-wire loudspeaker cable, pins 1+/- and 2+/- have to be bridged on the loudspeaker side of the cable as shown in the graphic below.

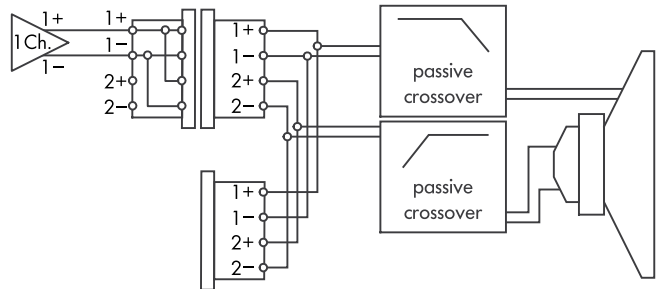

**2-wire cabling diagram**

**Active operation ("2-Way Active" mode)**

Selecting "2-Way Active" mode with the M6 setup enables up to two M6 cabinets to be driven actively by the respective amplifier.

In "2-Way Active" mode separate LF and HF signals are routed to the amplifier channels. Pins 1+/1- of both NL4 output connectors (EP5: pins 1/2) carry the LF signal, pins 2+/2- (EP5: 3/4) carry the HF signal.

For D80 and D12 amplifiers, the output connector pin assignment is set automatically when "2-Way Active" mode is selected. For all other applicable amplifiers, a dedicated socket for active operation is available.

The input signal can be fed either to INPUT A or to INPUT B and is routed (linked) to both amplifier channels internally.

**2.3.1 Controller settings**

For acoustic adjustment the functions CUT, HFA and CPL can be selected.

**CUT mode**

Set to CUT, the low frequency level is reduced. The cabinet is now configured for use with actively driven d&b subwoofers.

**HFA mode**

In HFA mode (High Frequency Attenuation), the HF response of the system is rolled off. HFA provides a natural, balanced frequency response when a cabinet is placed close to listeners in near field or delay use.

High Frequency Attenuation begins gradually at 1 kHz, dropping by approximately 3 dB at 10 kHz. This roll off mimics the decline in frequency response experienced when listening to a system from a distance in a typically reverberant room or auditorium.

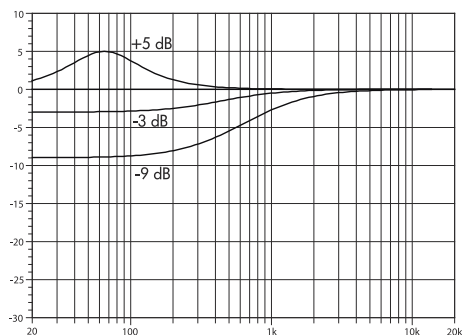

**Frequency response correction of the CPL function**

### CPL function

The CPL (Coupling) function compensates for coupling effects between the cabinet and close boundary surfaces or when the cabinet is used as a stage monitor. CPL begins gradually around 1 kHz, with the maximum attenuation below 400 Hz. To achieve a balanced frequency response, the CPL function can be set to dB attenuation values between 0 and -9.

Positive CPL values create an adjustable low frequency boost (0 to +5 dB) and can be set when the system is used in full range mode without subwoofers.

For a single cabinet in free space conditions a value of +3 dB is recommended.

### 2.3.2 Operation with E-PAC

Selecting M6 mode enables the E-PAC to drive one M6 loudspeaker. LO IMP mode configures the E-PAC to drive a maximum of two M6 loudspeakers with a 6 dB reduction in input level to the loudspeakers.

For acoustic adjustment the CUT and HFA modes are available. The characteristics are described in the previous section.



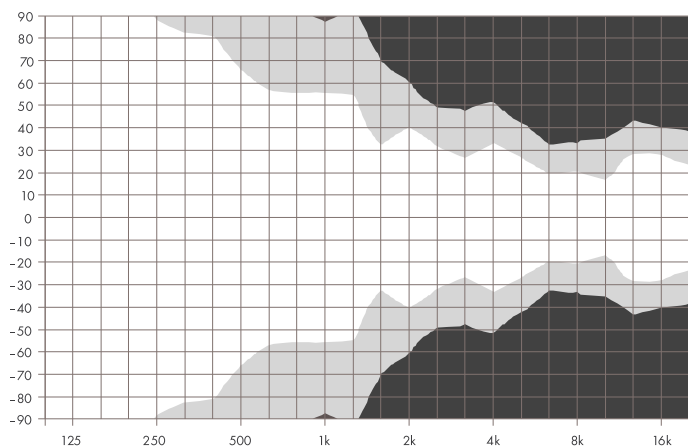

**Isobar diagram M6 horizontal, monitor setup  
(vertical, front-of-house setup)**

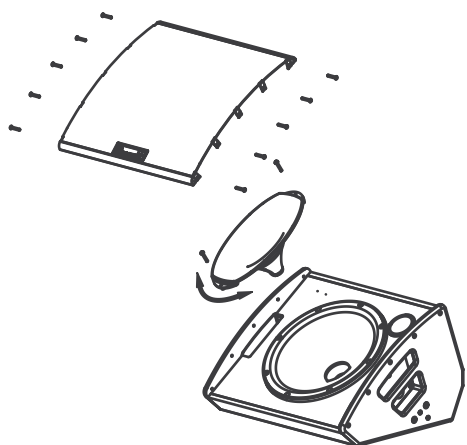

**Altering the HF horn dispersion**

## 2.4 Dispersion characteristics

The graphs below show dispersion angle over frequency of a single M6 cabinet plotted using lines of equal sound pressure (isobars) at -6 dB and -12 dB. The characteristics refer to monitor operation. When used as a front-of-house system, the horizontal dispersion corresponds to the vertical plot and vice versa.

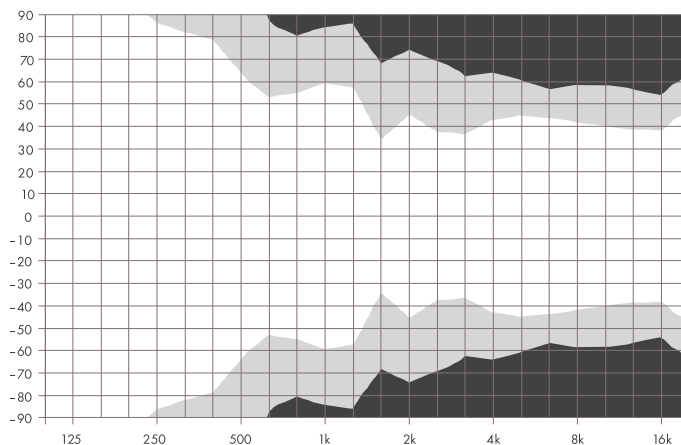

**Isobar diagram M6 vertical, monitor setup  
(horizontal, front-of-house setup)**

### Altering the HF horn dispersion

The HF horn can be rotated through 90° for dedicated installation applications.

**Tools required:** Torx wrench (#TX25).

Proceed as follows:

1. Disconnect the loudspeaker.
2. Undo the 10 screws holding the front grill and remove the front grill.
3. Undo the screws holding the horn flange and the two opposite screws at the 12" driver for the desired orientation.
4. Rotate the horn to the desired orientation.
5. Refit all screws and tighten them using a torque setting of 2 N·m.
6. Refit the front grill and tighten all screws using a torque setting of 4 N·m.

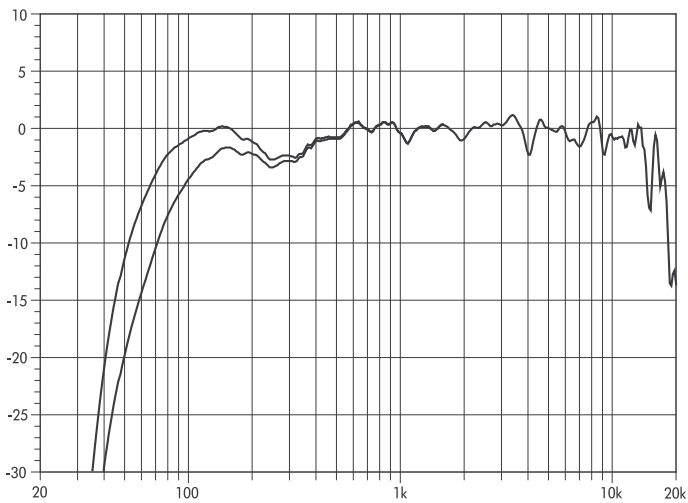

**M6 frequency response, standard and CUT modes**

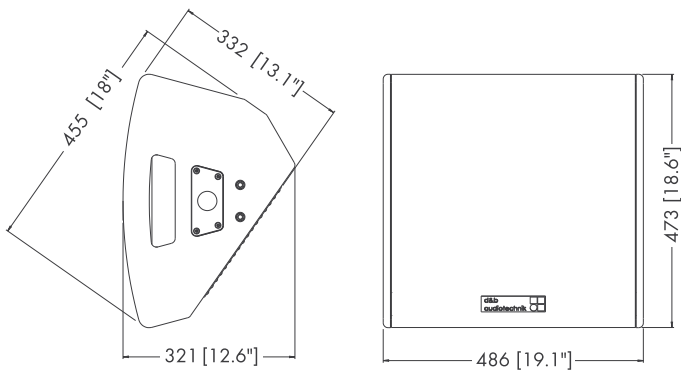

**M6 cabinet dimensions in mm [inch]**

## 2.5 Technical specifications

### M6 system data

Frequency response (-5 dB standard) .....	65 Hz - 17 kHz
Frequency response (-5 dB CUT mode) .....	95 Hz - 17 kHz
Max. sound pressure (single cabinet, 1 m, free field) .....	
with D6/10D/E-PAC passive mode .....	132 dB
with 10D active mode .....	133 dB
with D80/D40/D20/D12/40D/30D passive mode .....	135 dB
with D80/D40/D20/D12/40D/30D active mode .....	138 dB
.....(SPLmax peak, pink noise test signal with crest factor of 4)	

### M6 loudspeaker

Nominal impedance .....	8 ohms
Power handling capacity (RMS / peak 10 ms) .....	400/1600 W
Nominal dispersion angle (hor. x vert., monitor setup) .....	50° x 80°
Components .....	12" LF driver with neodymium magnet
.....coaxial 1.3" exit compression driver with 3" coil and CD horn	
.....	Passive crossover network
Connections .....	2 x NLT4 F/M
.....	(optional 2 x EP5)
Pin assignment .....	NLT4 F/M: 1+: LF+/1 -: LF-   2+: HF+/2 -: HF-
.....	EP5: 1: LF+   2: LF-   3: HF+   4: HF-   5: n.c.
Weight .....	16 kg (35 lb)

### 3.1 Conformity of loudspeakers

This declaration applies to:

#### **d&b Z0820 M6 loudspeaker**

manufactured by d&b audiotechnik GmbH & Co. KG.

All product variants are included, provided they correspond to the original technical version and have not been subject to any later design or electromechanical modifications.

We herewith declare that said products are in conformity with the provisions of the respective directives including all applicable amendments.

Detailed and applicable declarations are available on request and can be ordered from d&b or downloaded from the d&b website at [www.dbaudio.com](http://www.dbaudio.com).

WEEE-Reg.-Nr. DE: 13421928

### 3.2 WEEE Declaration (Disposal)

Electrical and electronic equipment must be disposed of separately from normal waste at the end of its operational lifetime.

Please dispose of this product according to the respective national regulations or contractual agreements. If there are any further questions concerning the disposal of this product, please contact d&b audiotechnik.

