

DC Resistivity

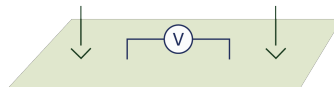

DC Resistivity Survey

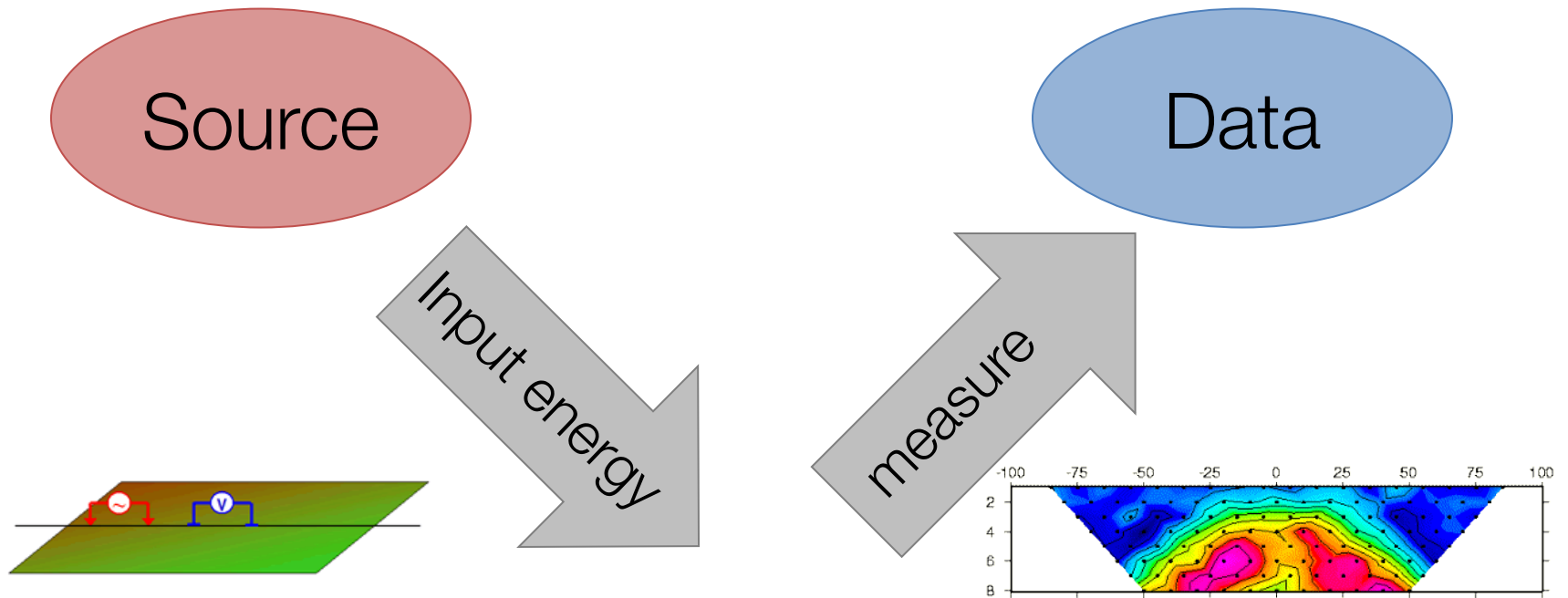

ρ

$$\rho = 1/\sigma$$

ρ : resistivity

σ : electrical conductivity

Motivation

Minerals

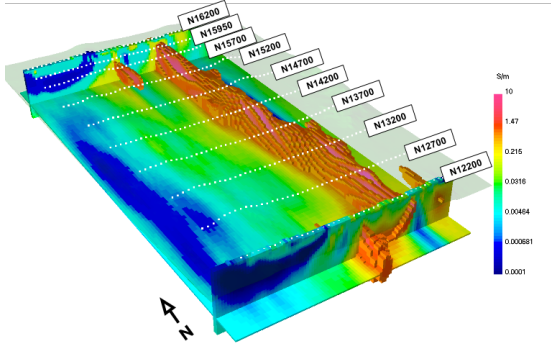

Water inflow in mine



Oil and Gas

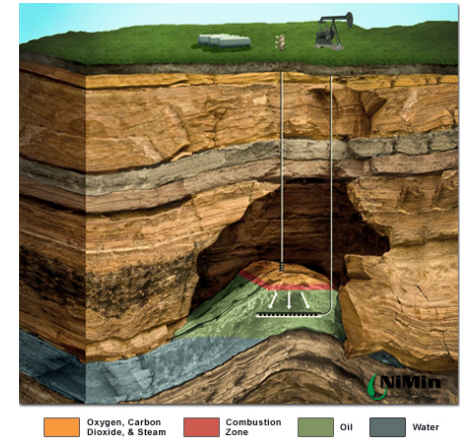

Geotechnical

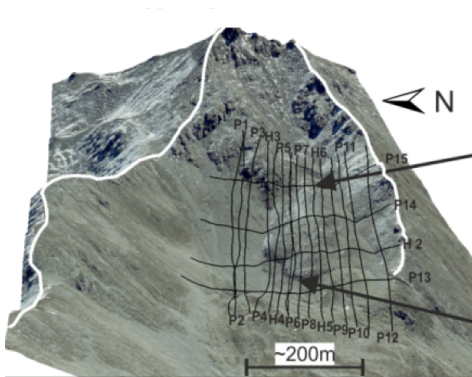

Groundwater

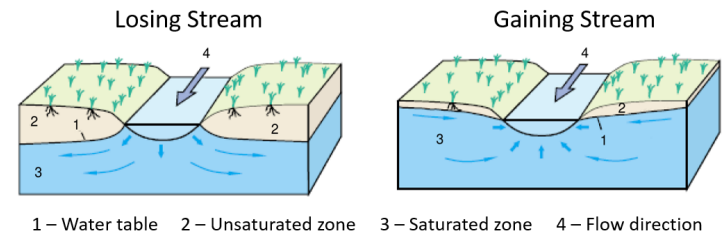

Electrical conductivity

- DC resistivity is sensitive to:
 - σ : Conductivity [S/m]
 - ρ : Resistivity [Ωm]
 - $\sigma = 1/\rho$
- Varies over many orders of magnitude
- Depends on many factors:
 - Rock type
 - Porosity
 - Connectivity of pores
 - Nature of the fluid
 - Metallic content of the solid matrix

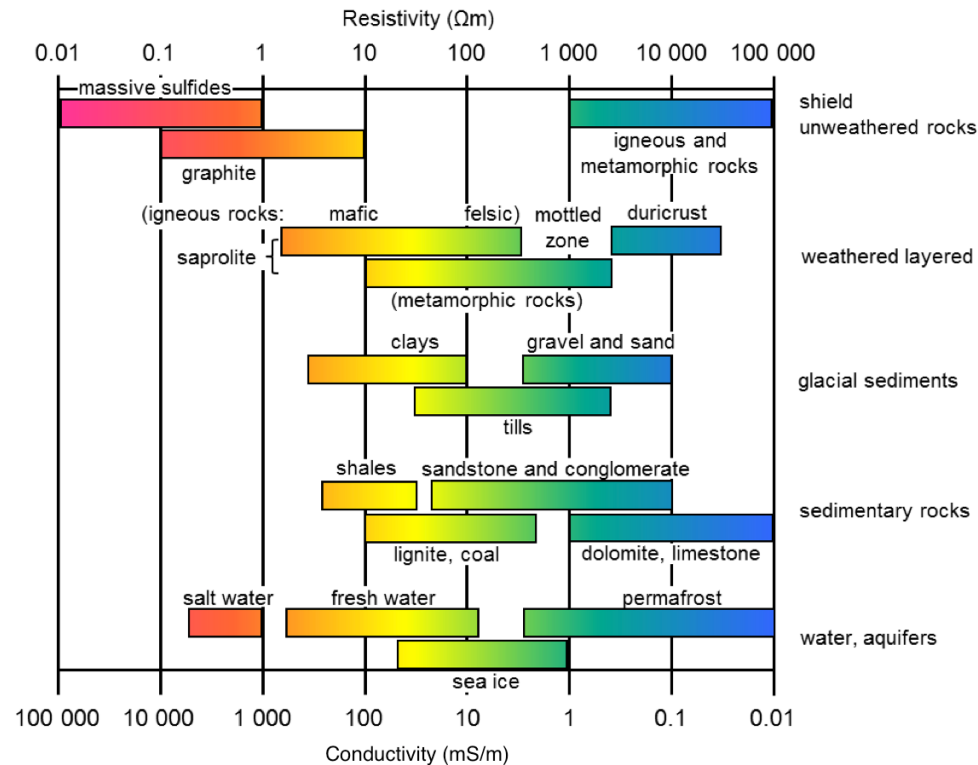

Outline

- Basic experiment
- Currents, charges, potentials and apparent resistivities
- Soundings, profiles and arrays
- Data, pseudosections and inversion
- Sensitivity
- Survey Design
- Case History – Mt Isa
- Case History – Dam Monitoring
- Effects of background resistivity

Basic Experiment

- **Target:**
 - Ore body. Mineralized regions less resistive than host

Elura Orebody Electrical resistivities

<i>Rock Type</i>	<i>Ohm-m</i>
Overburden	12
Host rocks	200
Gossan	420
Mineralization (pyritic)	0.6
Mineralization (pyrrhotite)	0.6

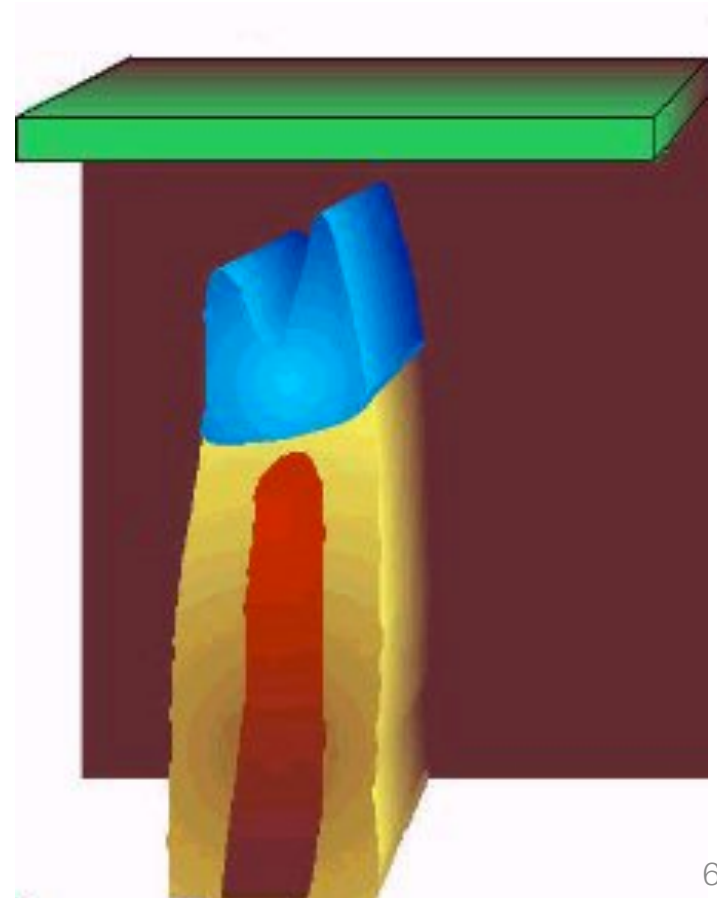

Basic Experiment

- **Target:**
 - Ore body. Mineralized regions less resistive than host
- **Setup:**
 - Tx: Current electrodes
 - Rx: Potential electrodes

Elura Orebody Electrical resistivities

Rock Type	Ohm-m
Overburden	12
Host rocks	200
Gossan	420
Mineralization (pyritic)	0.6
Mineralization (pyrrhotite)	0.6

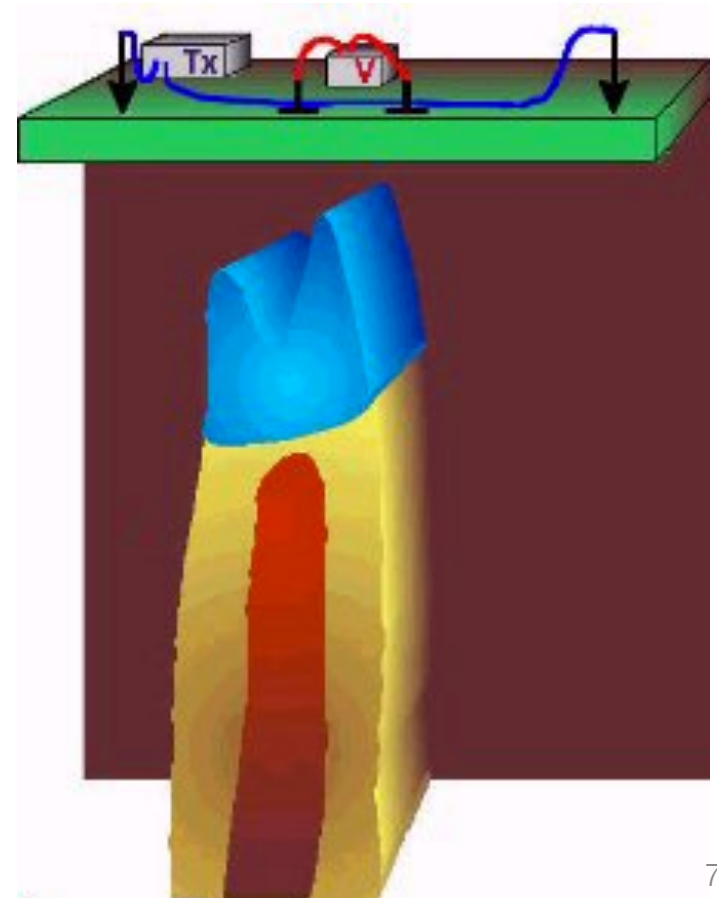

Basic Experiment

- **Target:**
 - Ore body. Mineralized regions less resistive than host
- **Setup:**
 - Tx: Current electrodes
 - Rx: Potential electrodes
- **Currents:**
 - Preferentially flow through conductors

Elura Orebody Electrical resistivities

Rock Type	Ohm-m
Overburden	12
Host rocks	200
Gossan	420
Mineralization (pyritic)	0.6
Mineralization (pyrrhotite)	0.6

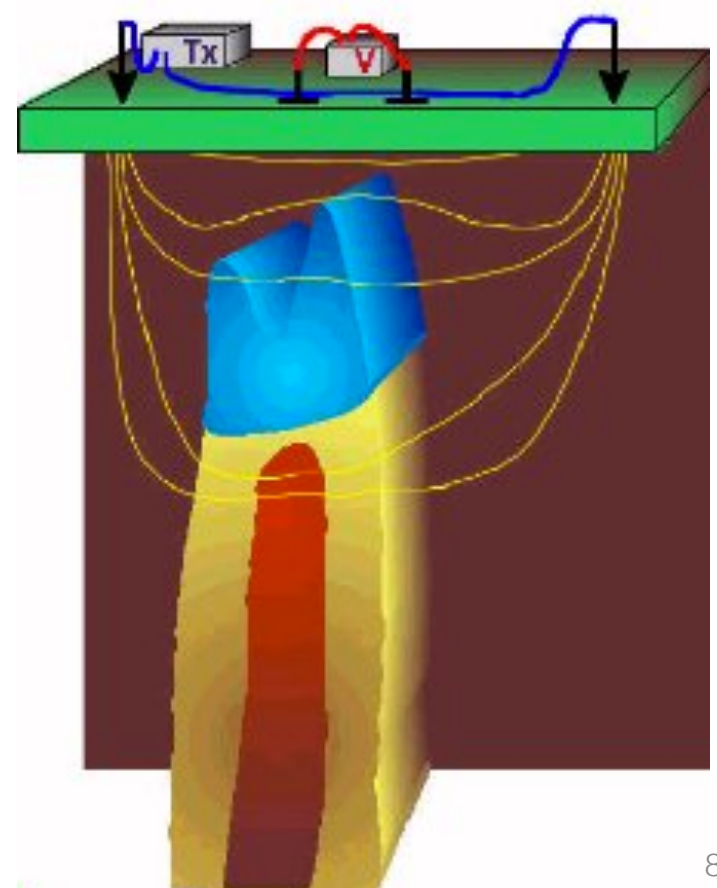

Basic Experiment

- **Target:**
 - Ore body. Mineralized regions less resistive than host
- **Setup:**
 - Tx: Current electrodes
 - Rx: Potential electrodes
- **Currents:**
 - Preferentially flow through conductors
- **Charges:**
 - Build up at interfaces

Elura Orebody Electrical resistivities

Rock Type	Ohm-m
Overburden	12
Host rocks	200
Gossan	420
Mineralization (pyritic)	0.6
Mineralization (pyrrhotite)	0.6

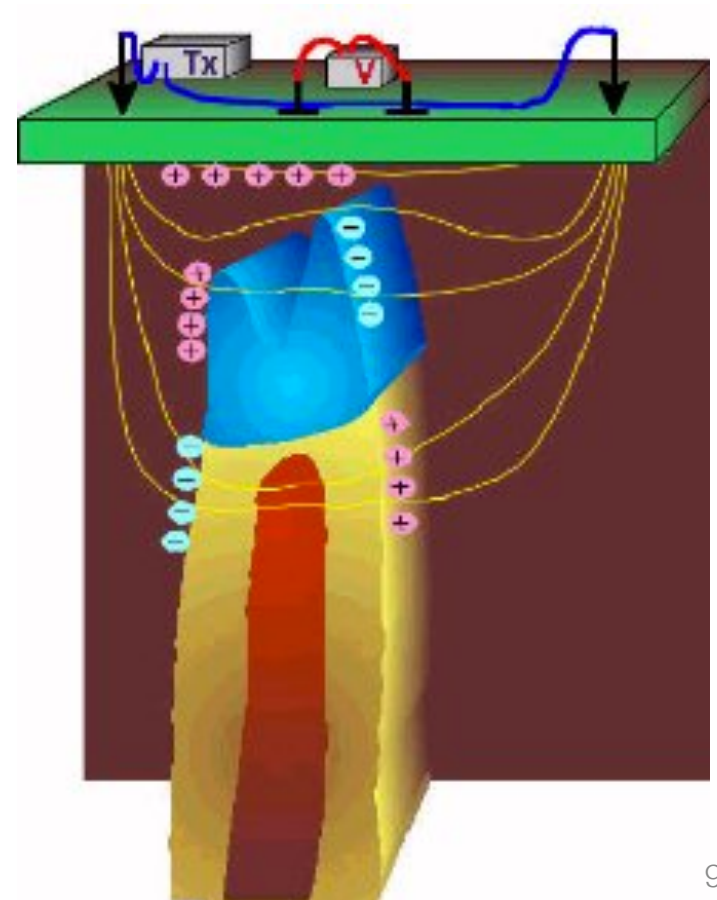

Basic Experiment

- **Target:**
 - Ore body. Mineralized regions less resistive than host
- **Setup:**
 - Tx: Current electrodes
 - Rx: Potential electrodes
- **Currents:**
 - Preferentially flow through conductors
- **Charges:**
 - Build up at interfaces
- **Potentials:**
 - Associated with the charges are measured at the surface

Elura Orebody Electrical resistivities

Rock Type	Ohm-m
Overburden	12
Host rocks	200
Gossan	420
Mineralization (pyritic)	0.6
Mineralization (pyrrhotite)	0.6

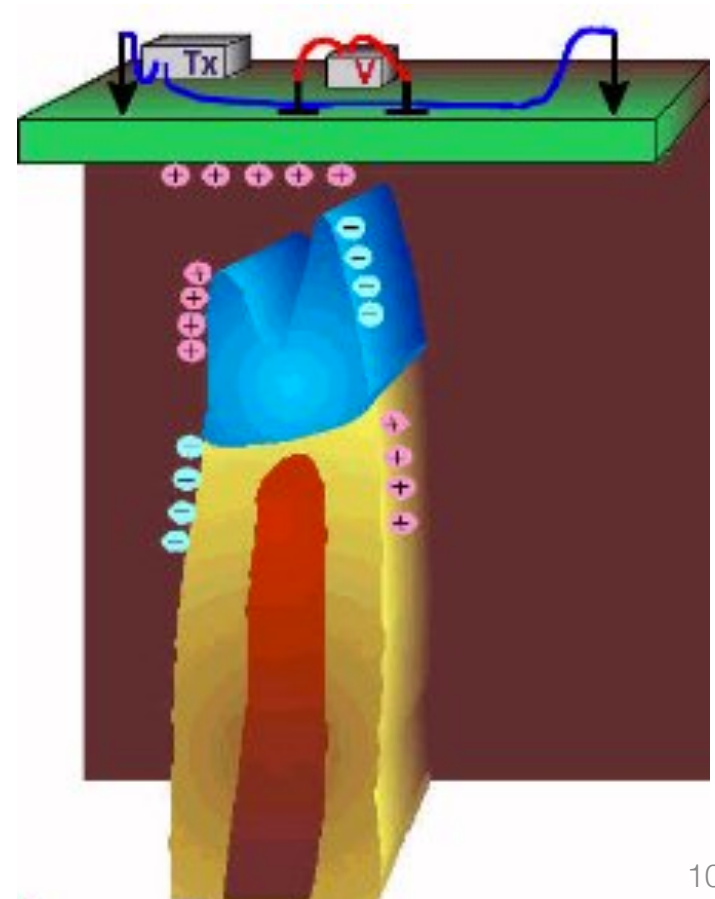

How do we obtain resistivity?

Steady State Maxwell equations

	Full	Steady State
Faraday	$\nabla \times \vec{e} = -\frac{\partial \vec{b}}{\partial t}$	$\nabla \times \vec{e} = 0 \quad \vec{e} = -\nabla V$
Ampere	$\nabla \times \vec{h} = \vec{j} + \frac{\partial \vec{d}}{\partial t} + \vec{j}_s$	$\nabla \cdot \vec{j} = -\nabla \cdot \vec{j}_s$
Ohm's Law	$\vec{j} = \sigma \vec{e}$	

Put it together

$$\nabla \cdot \sigma \nabla V = I \delta(r)$$

Potential in a homogeneous halfspace

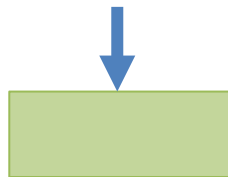

$$V = \frac{I}{2\pi\sigma} \frac{1}{r}$$

$$V = \frac{\rho I}{2\pi r}$$

Currents and potentials: halfspace

$$V = \frac{\rho I}{2\pi r}$$
$$\rho = \frac{2\pi r V}{I}$$

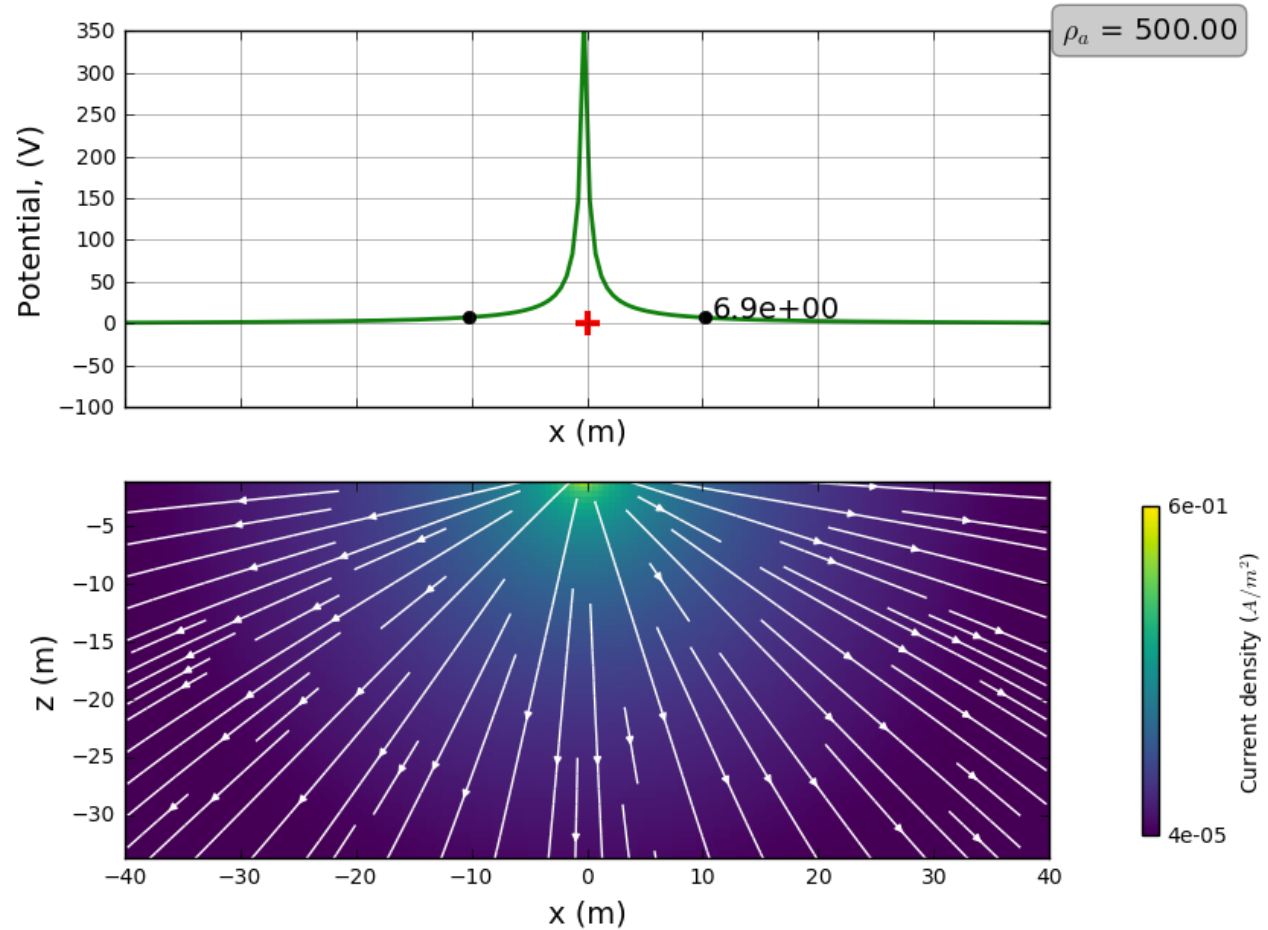

Currents and potentials: 4-electrode array

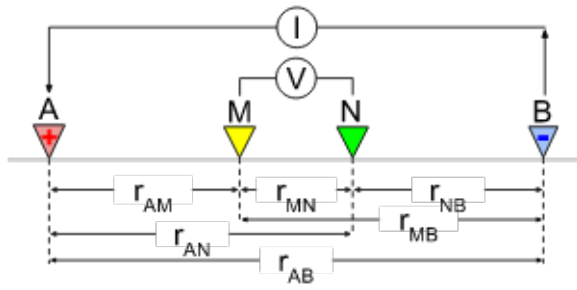

$$\Delta V_{MN} = \rho I \underbrace{\frac{1}{2\pi} \left[\frac{1}{AM} - \frac{1}{MB} - \frac{1}{AN} + \frac{1}{NB} \right]}_G$$

Resistivity

$$\rho = \frac{\Delta V_{MN}}{IG}$$

Halfspace ($500 \Omega m$)

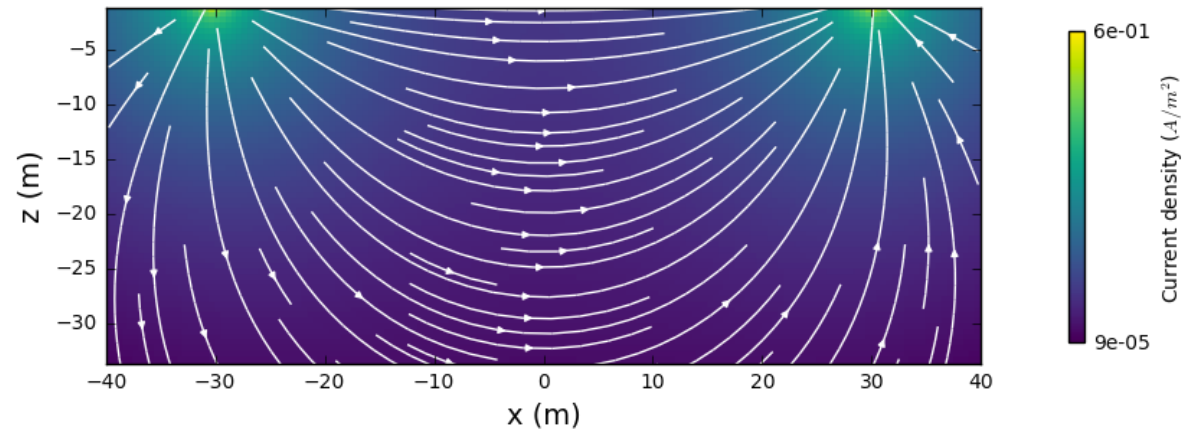
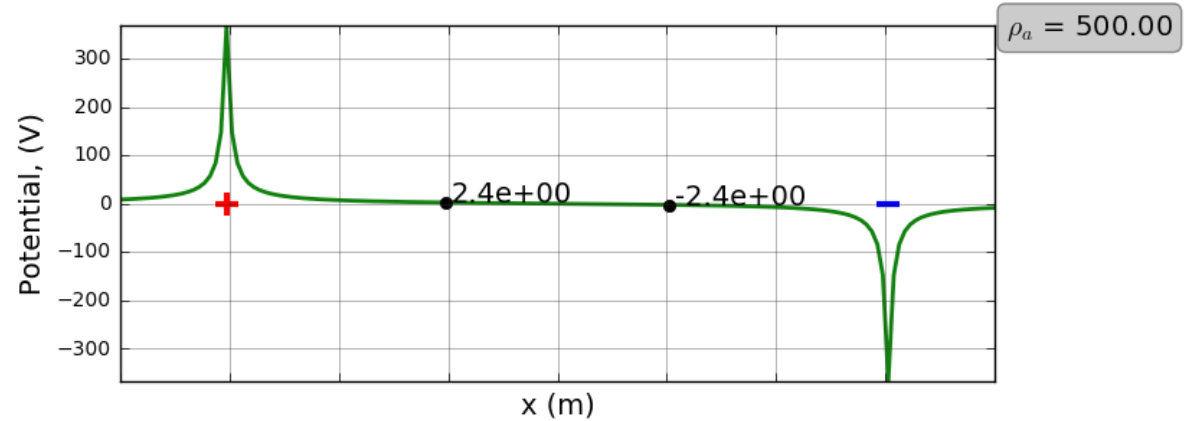

Currents and Apparent Resistivity

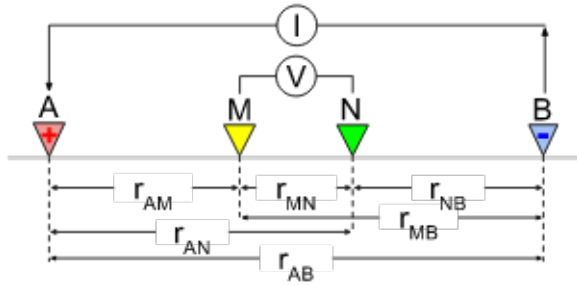

$$\Delta V_{MN} = \rho I \underbrace{\frac{1}{2\pi} \left[\frac{1}{AM} - \frac{1}{MB} - \frac{1}{AN} + \frac{1}{NB} \right]}_G$$

Apparent resistivity

$$\rho_a = \frac{\Delta V_{MN}}{IG}$$

Conductive overburden ($100 \Omega m$)

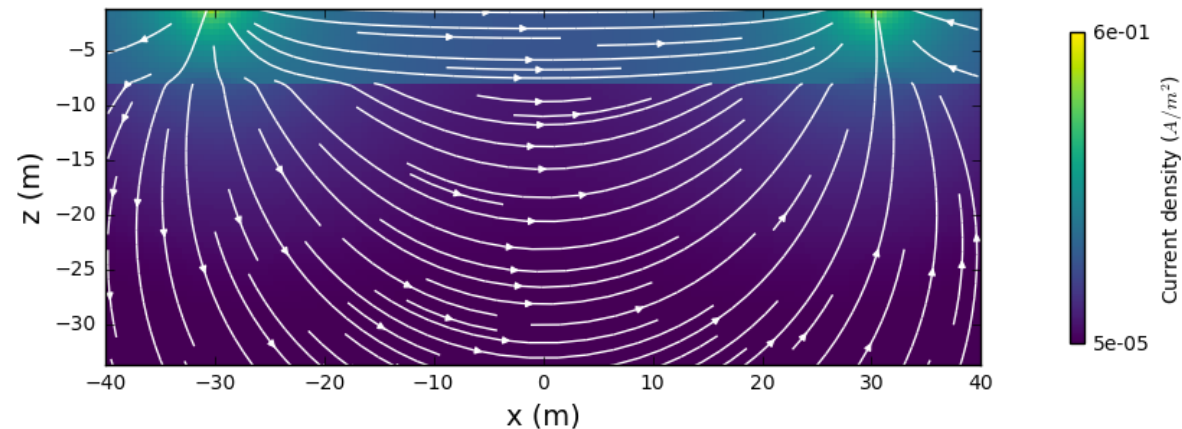
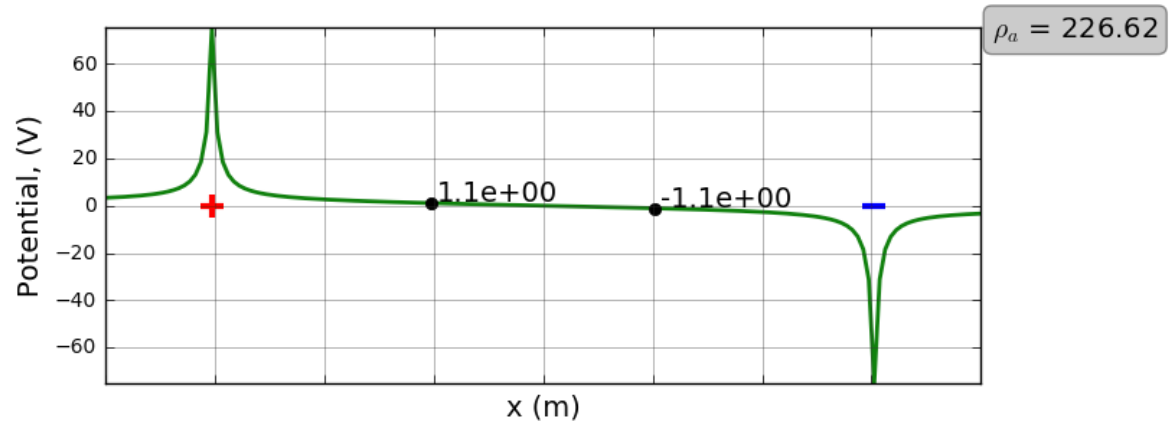

Why interactive apps?

- Visualization aids understanding
- Learn through interaction
 - ask questions and investigate
- Open source:
 - Free to use
 - Welcome contributions!

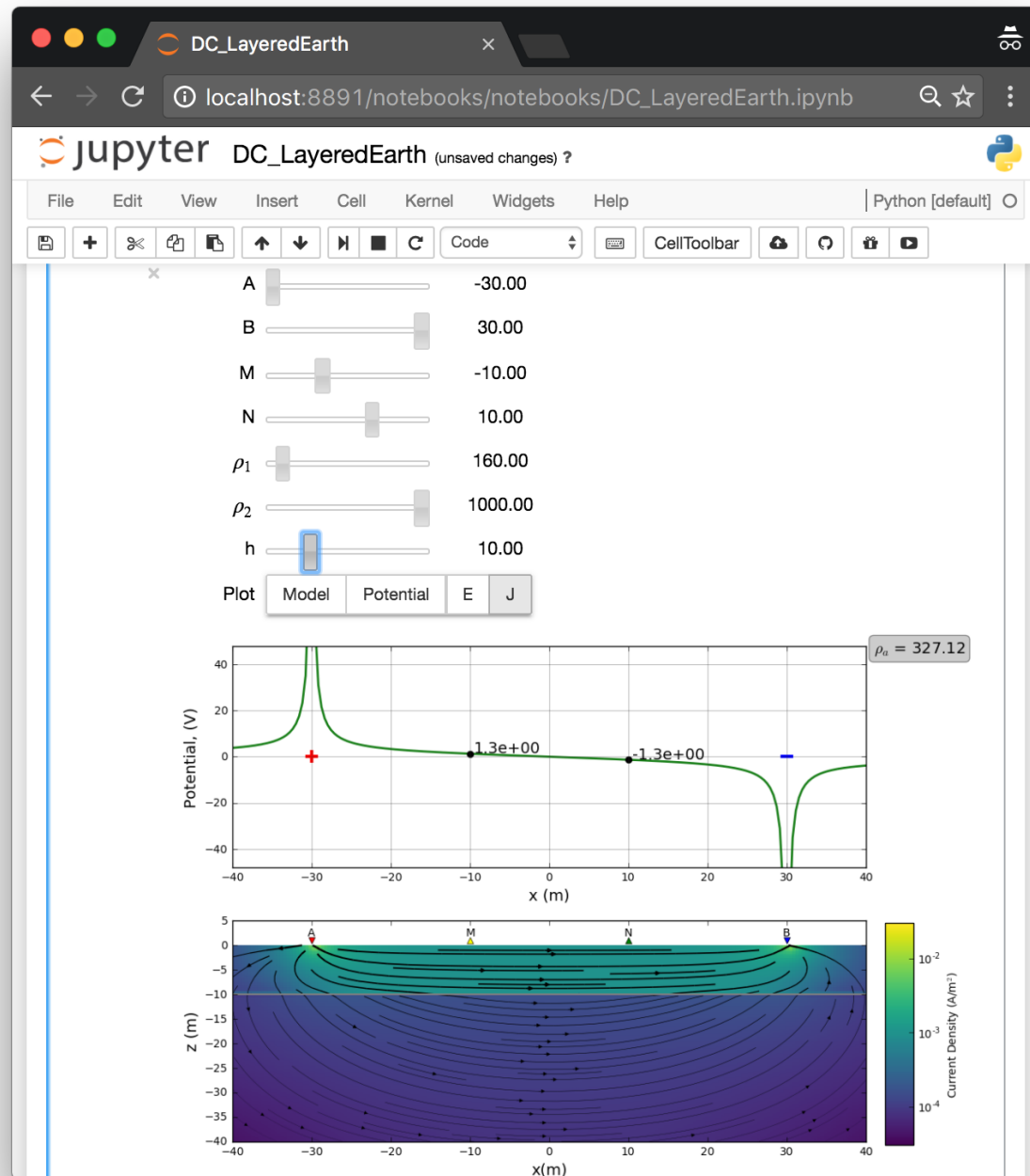

Soundings and Arrays

Geometry

Wenner

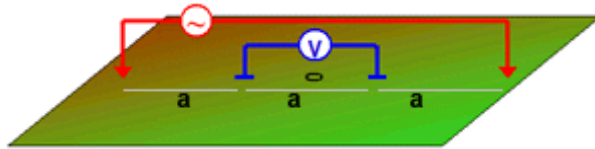

Schlumberger

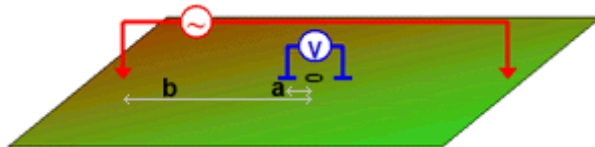

4 electrode Array

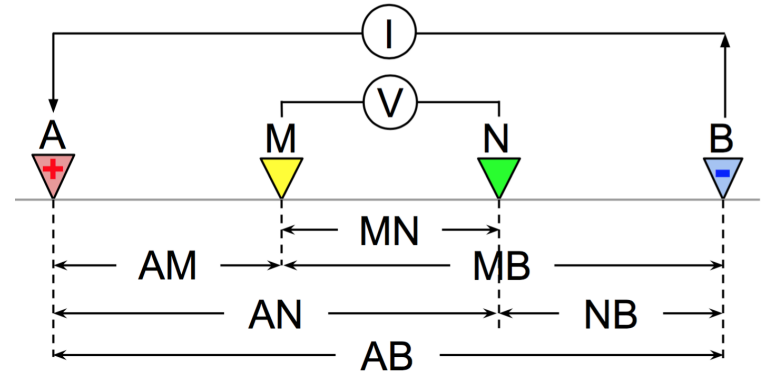

Sounding

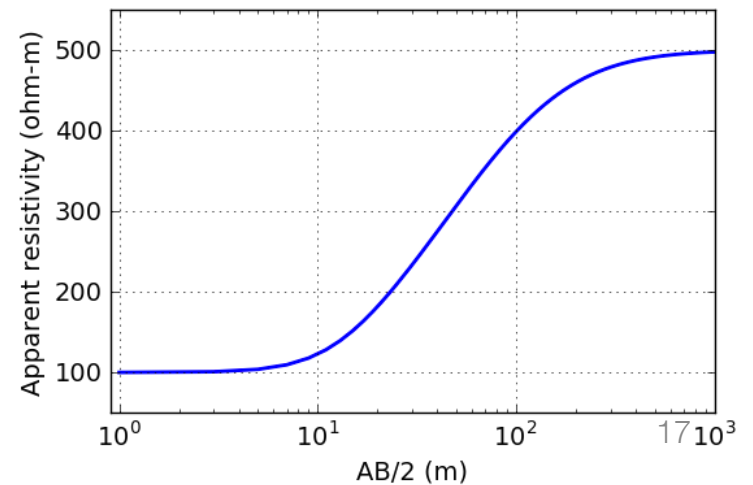

Soundings

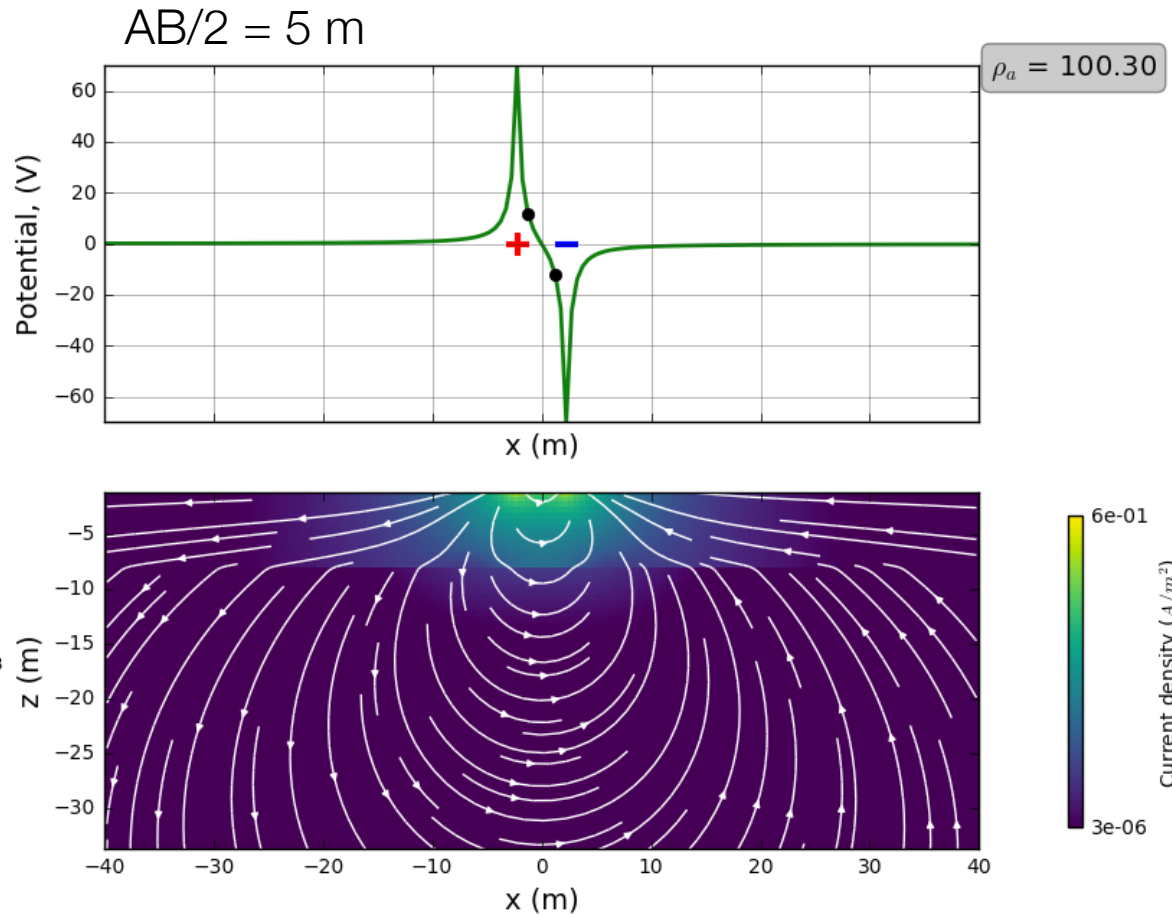
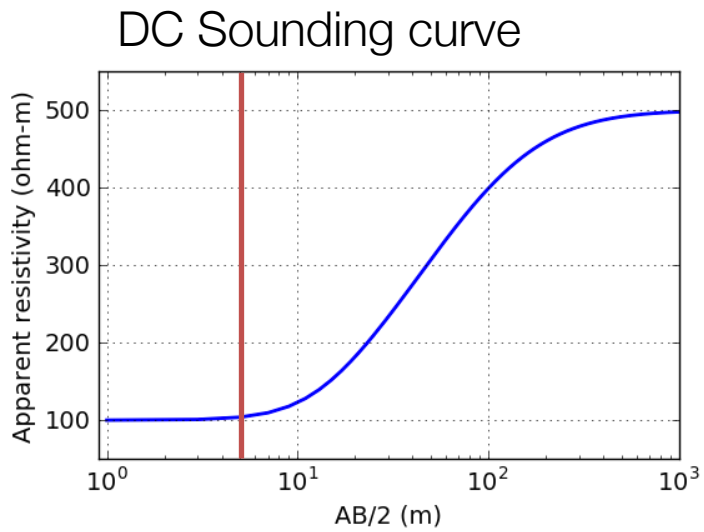

Soundings

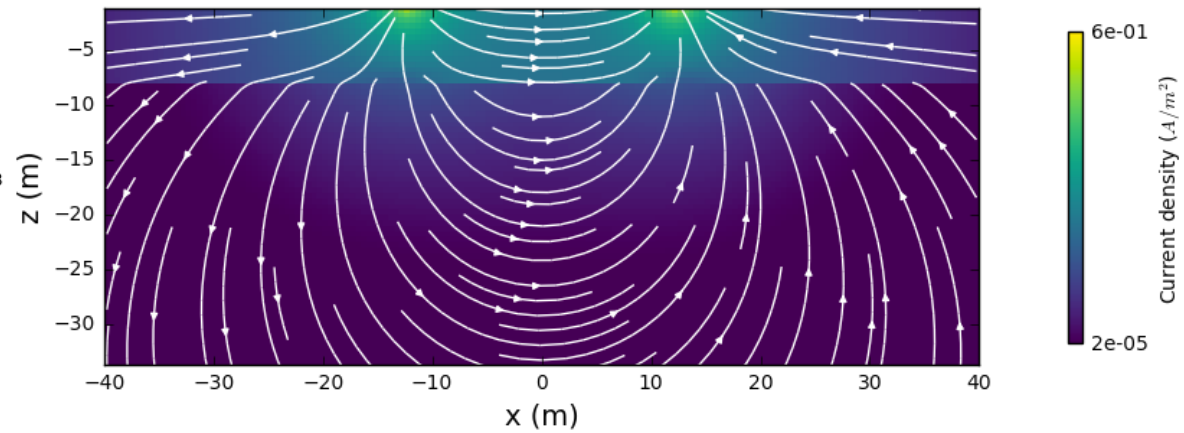
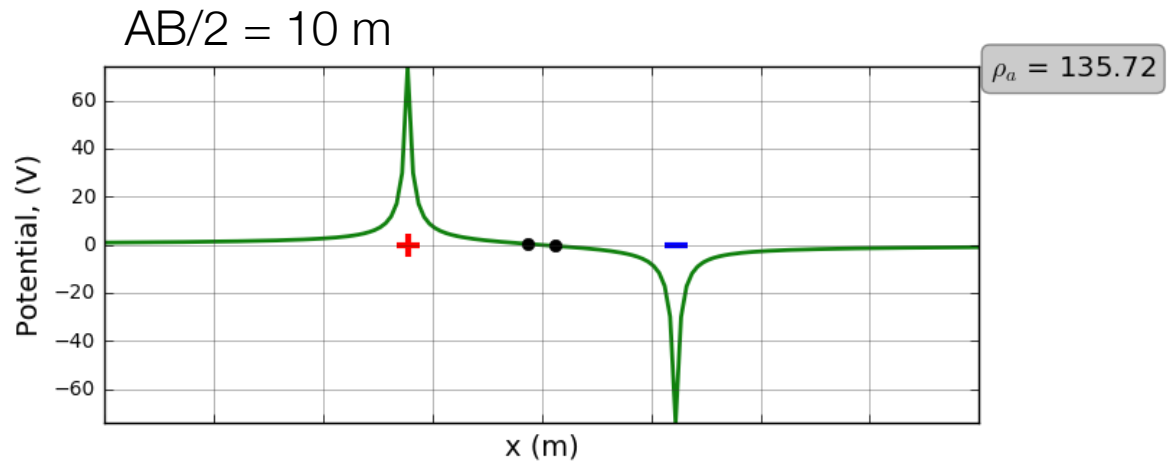
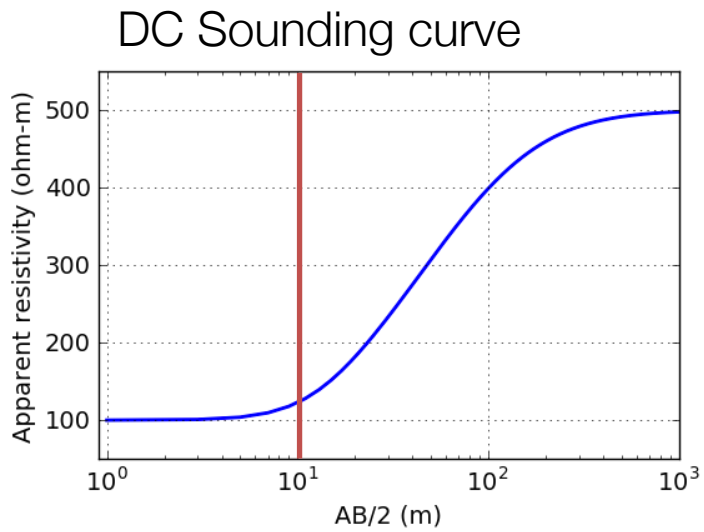

Soundings

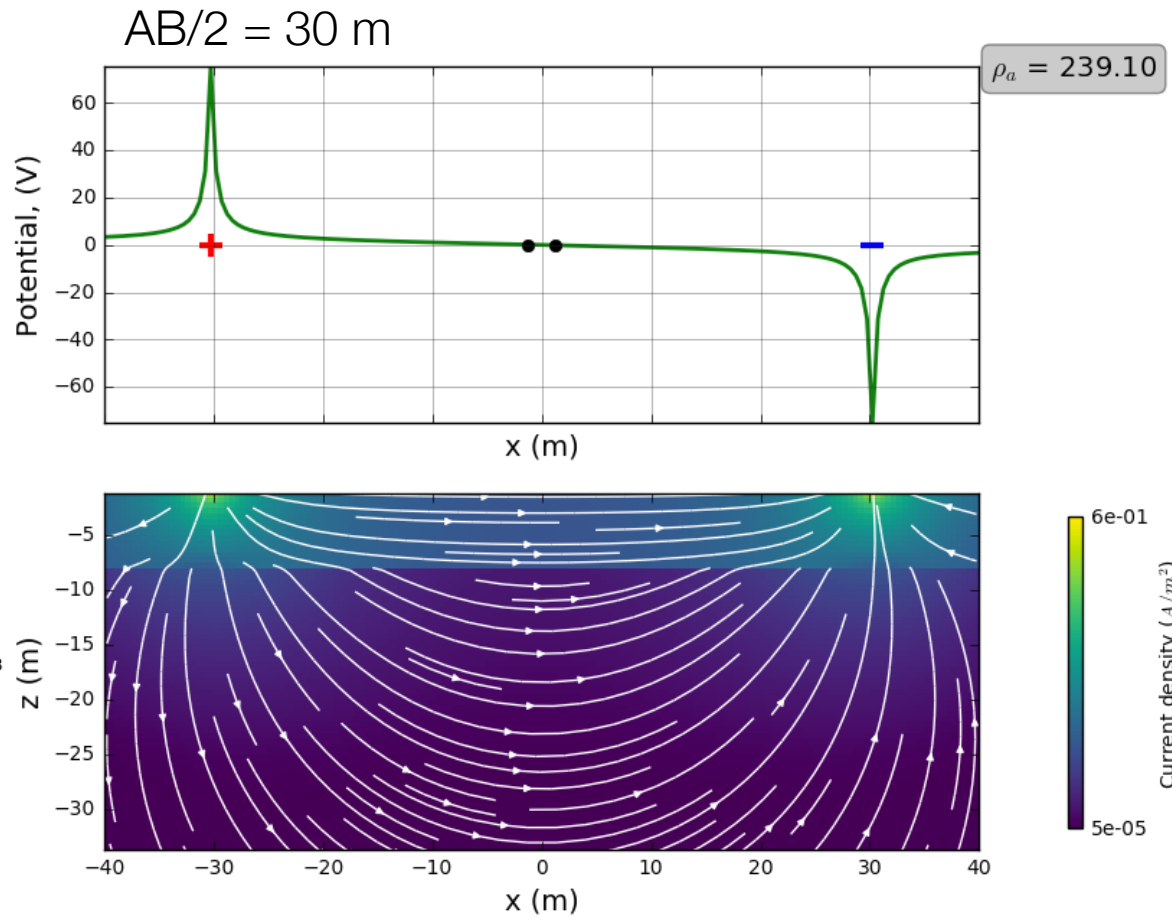
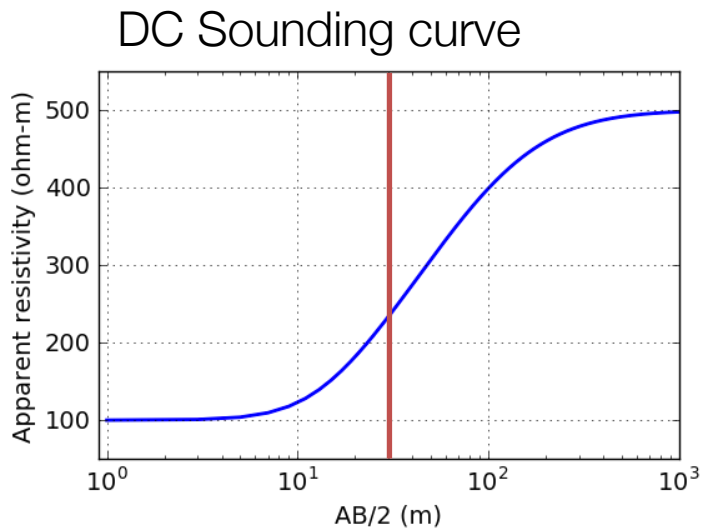

Summary: soundings

Schlumberger array

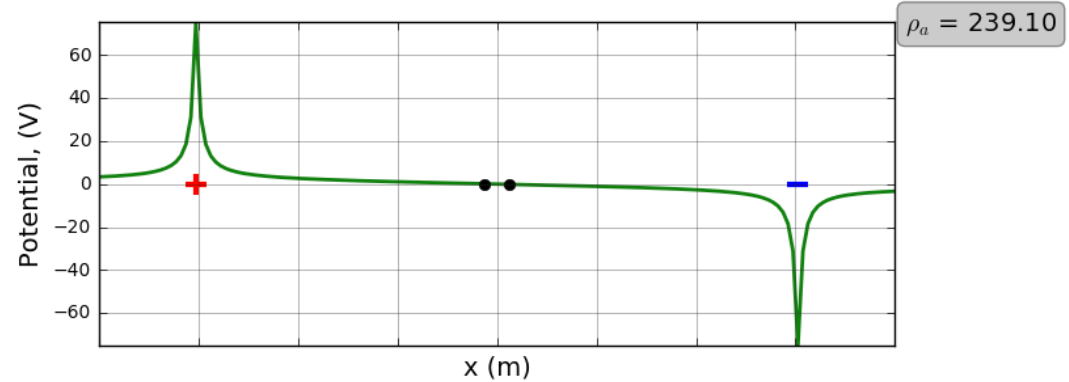
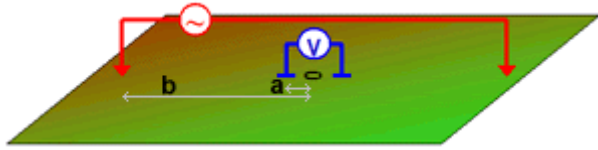

DC Sounding curve

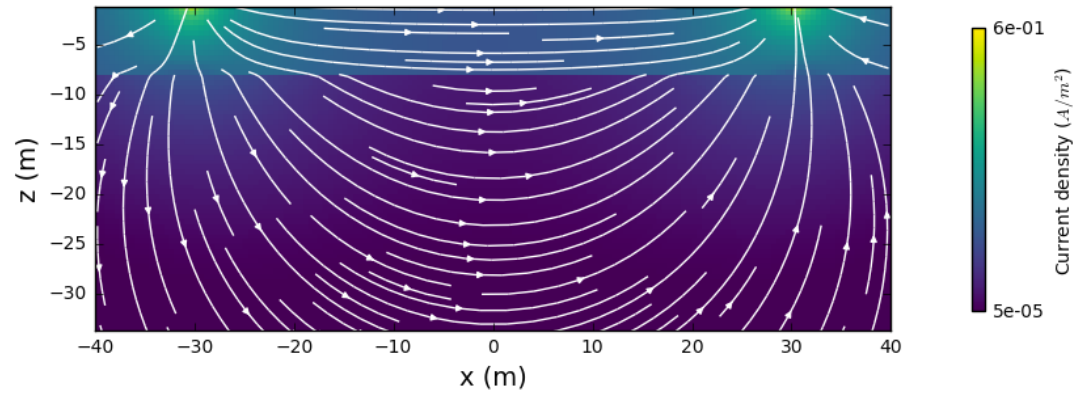
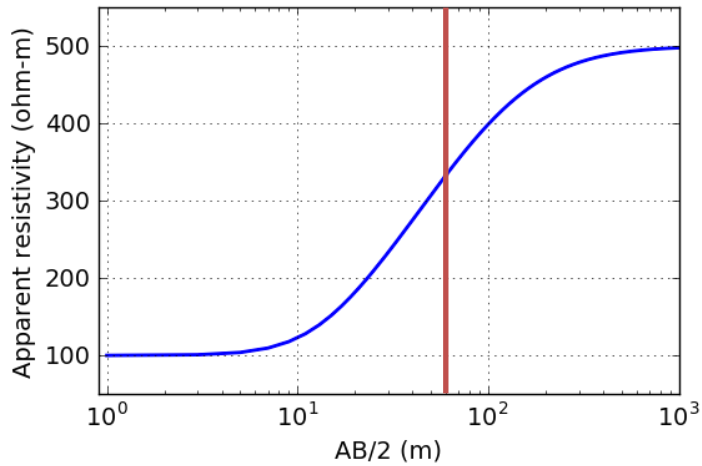

Scale length of array must be large to see deep

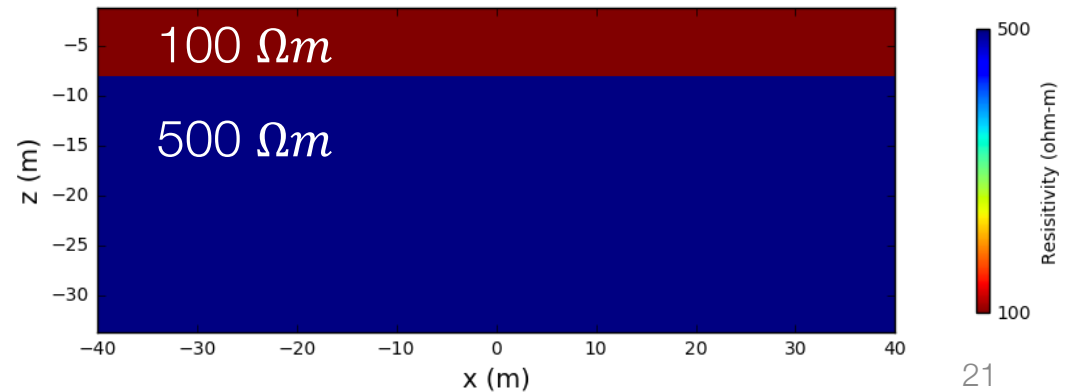

Inversion

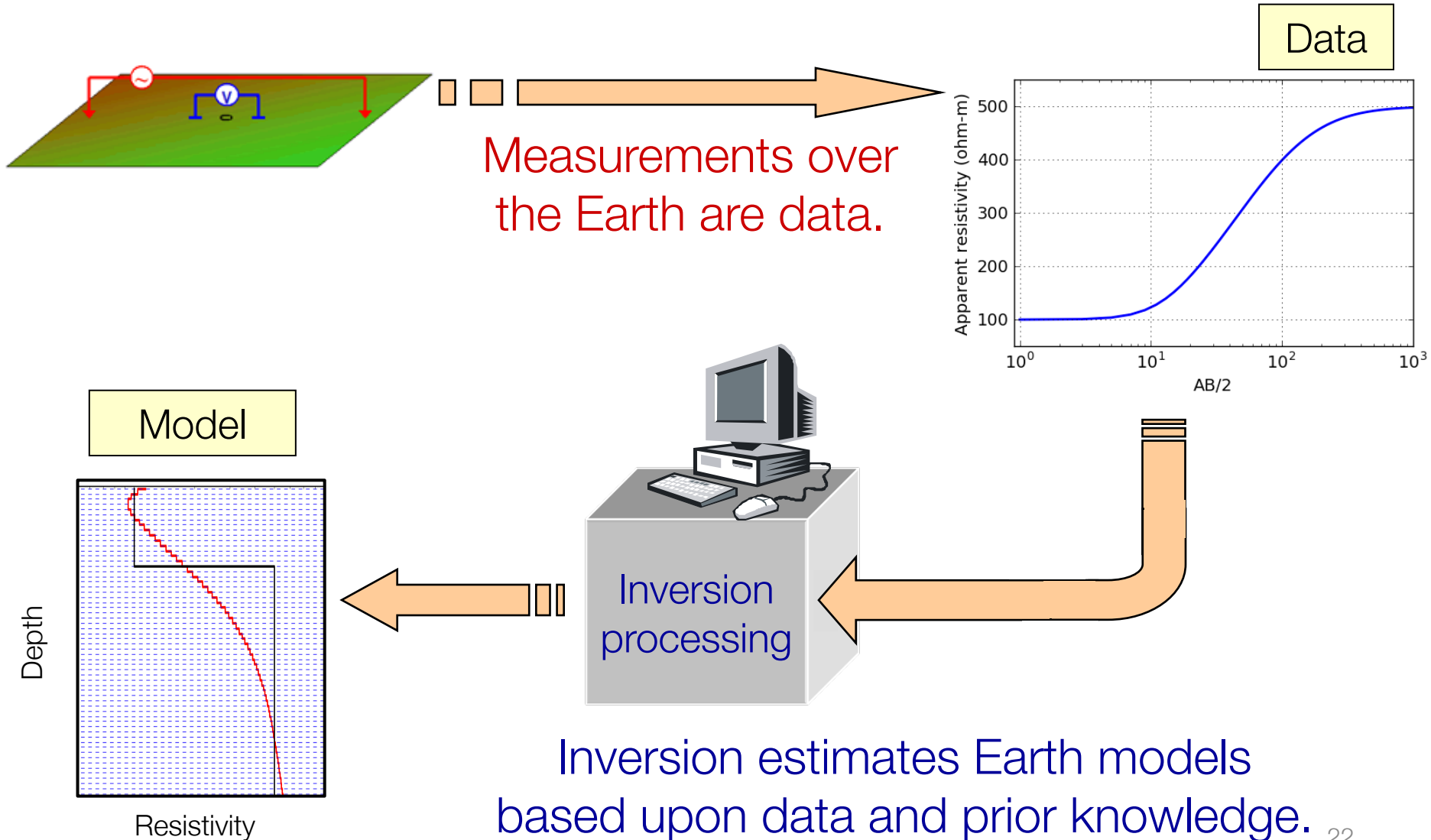

Inversion estimates Earth models based upon data and prior knowledge.

DCR for a confined body

- Useful to formally bring in the concept of charges

Normal component of current density is continuous

$$J_{1n} = J_{2n}$$
$$\sigma_1 E_{1n} = \sigma_2 E_{2n}$$

Conductivity contrast

$$\sigma_1 \neq \sigma_2$$

- Electric field discontinuous
- Charge build-up

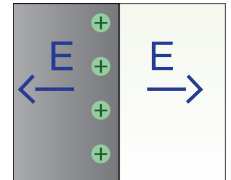

$$\mathbf{E} = \frac{Q}{4\pi\epsilon_0|\mathbf{r} - \mathbf{r}'|^2}\hat{\mathbf{r}}$$

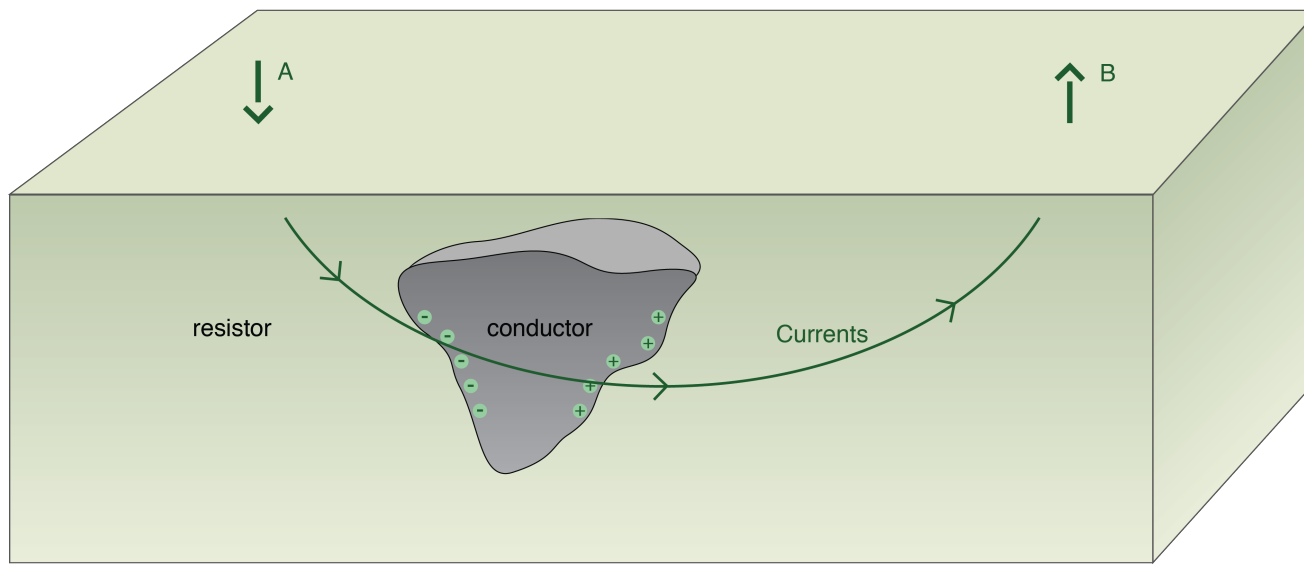

Currents, charges, and potentials

Total currents: J

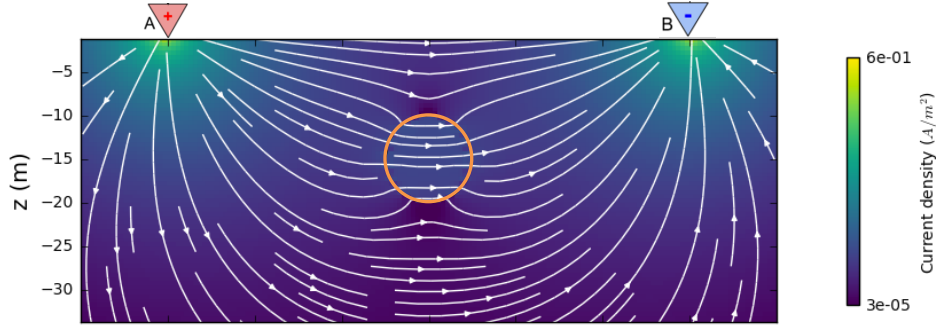

Secondary currents: J_s

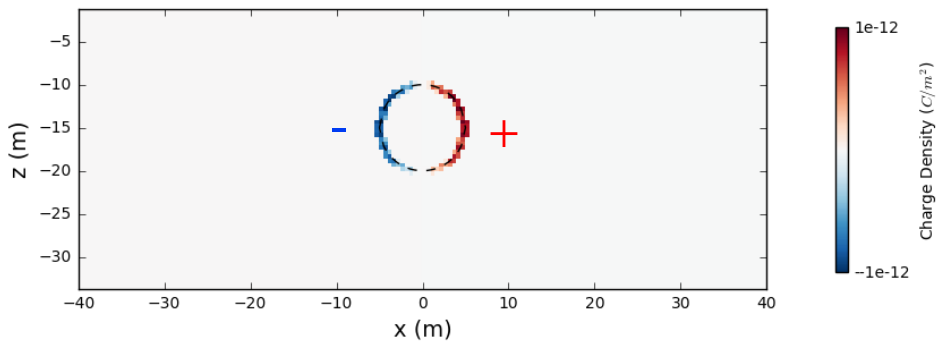
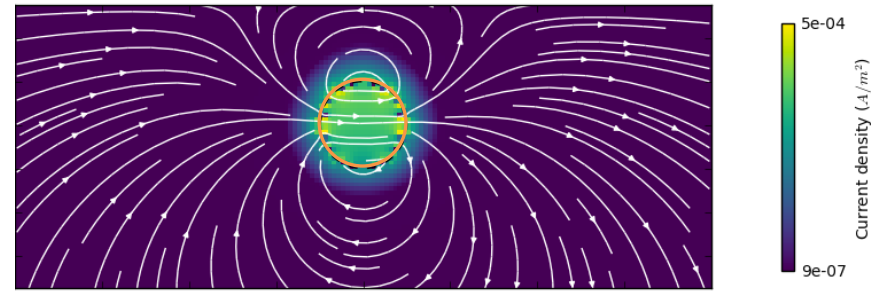

Secondary charges: Q_s

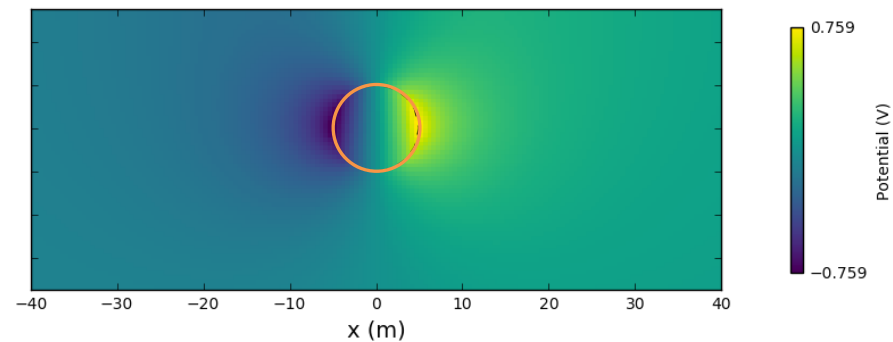

Secondary potential: ϕ_s

Measurements of DC data: gradient array

Potential profile

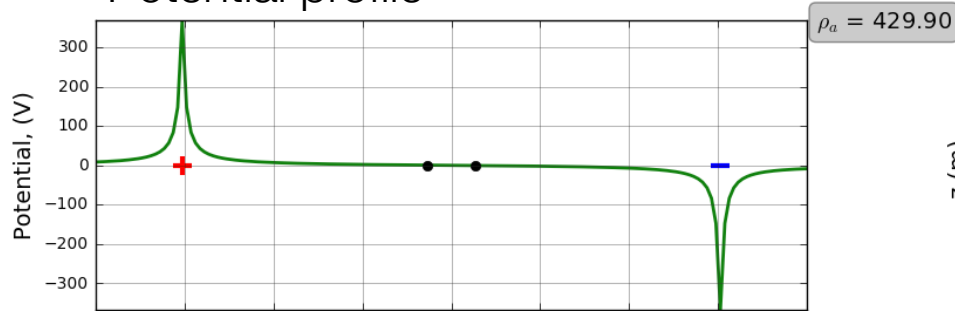

Resistivity model

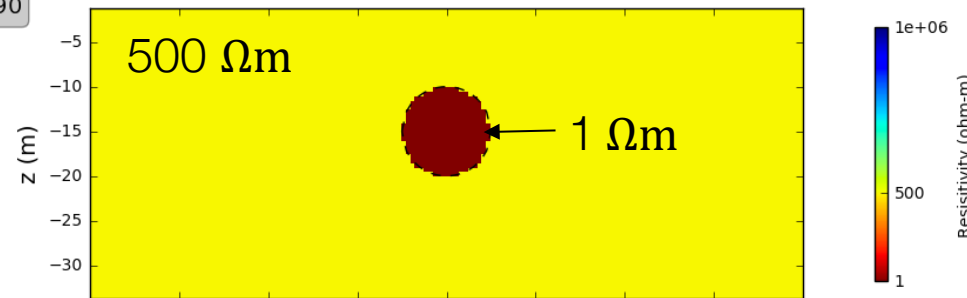

$\rho_a = 430$

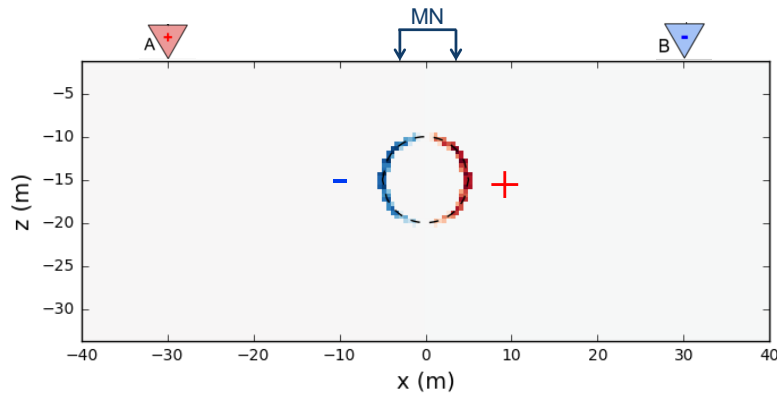

Secondary charges: Q_s

$\rho_a = 430$

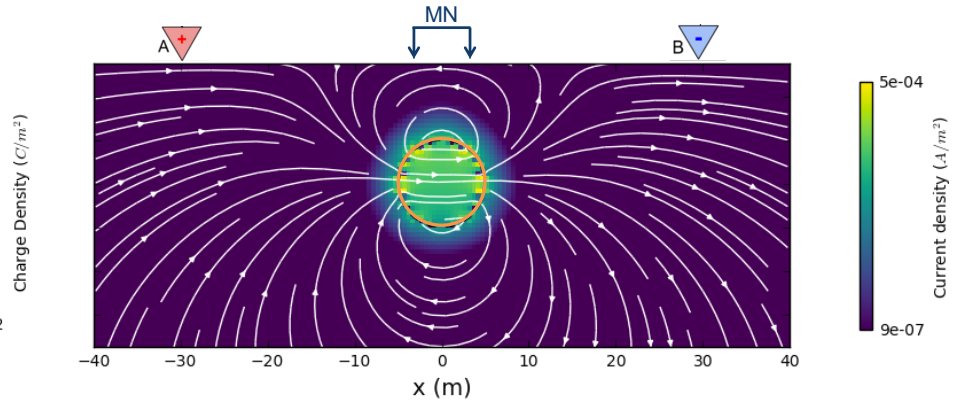

Secondary currents: J_s

Measurements of DC data: gradient array

Potential profile

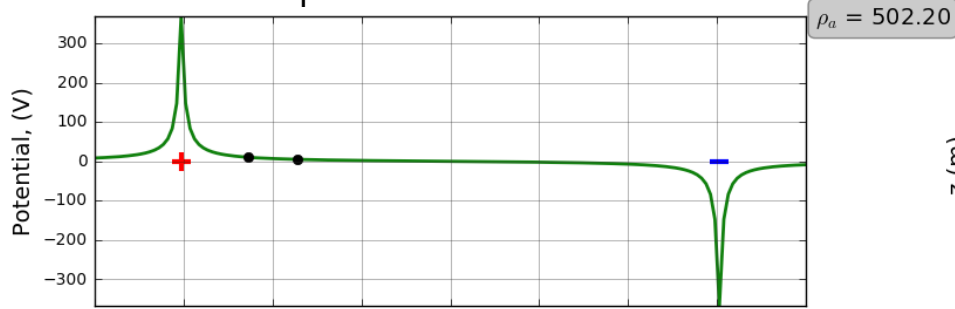

Resistivity model

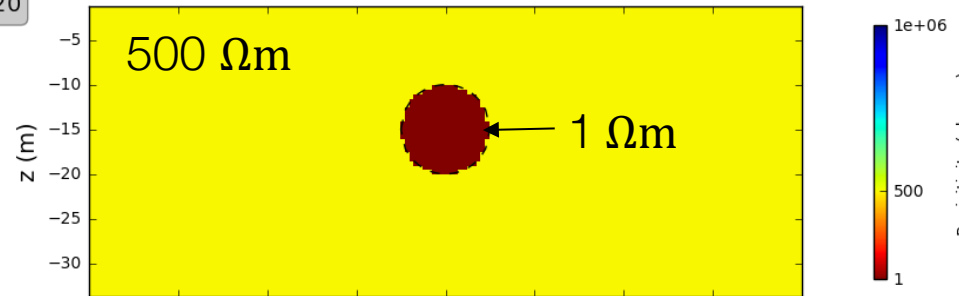

$\rho_a = 502$

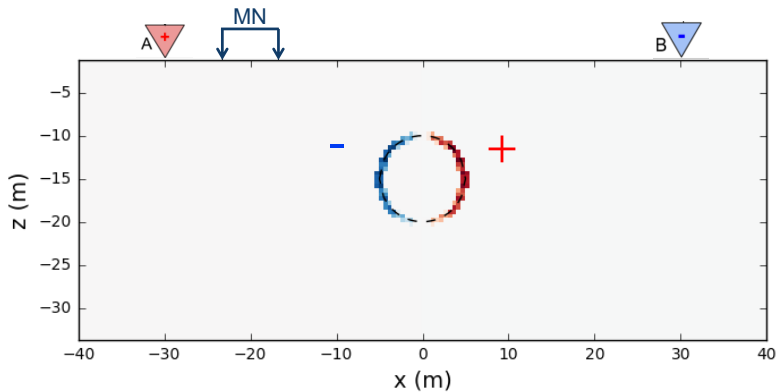

Secondary charges: Q_s

$\rho_a = 502$

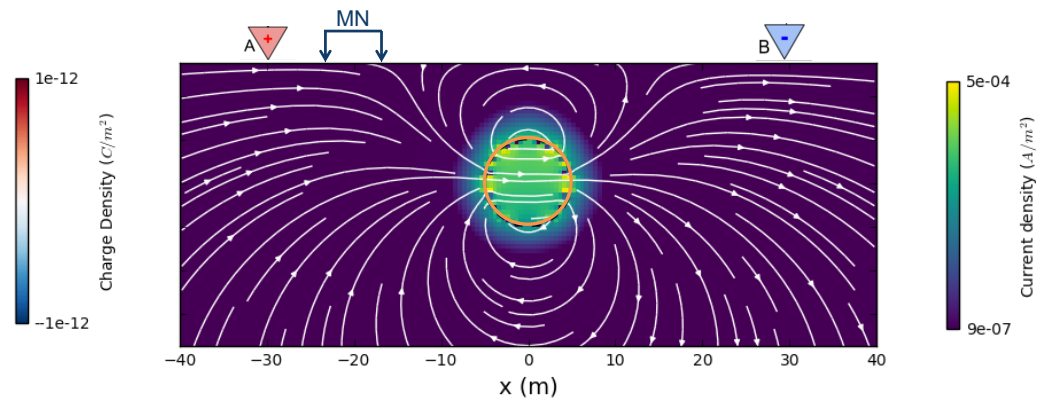

Secondary currents: J_s

Measurements of DC data: gradient array

Potential profile

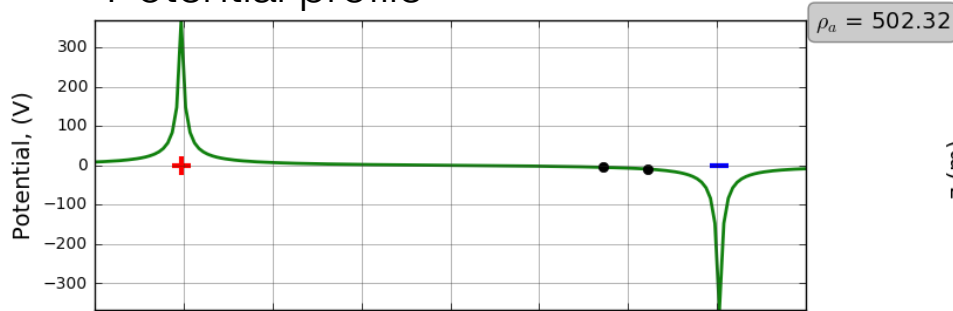

Resistivity model

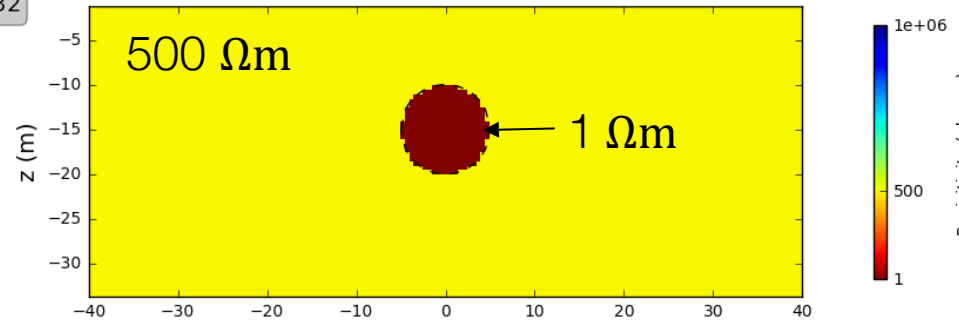

$\rho_a = 502$ $\rho_a = 430$ $\rho_a = 502$

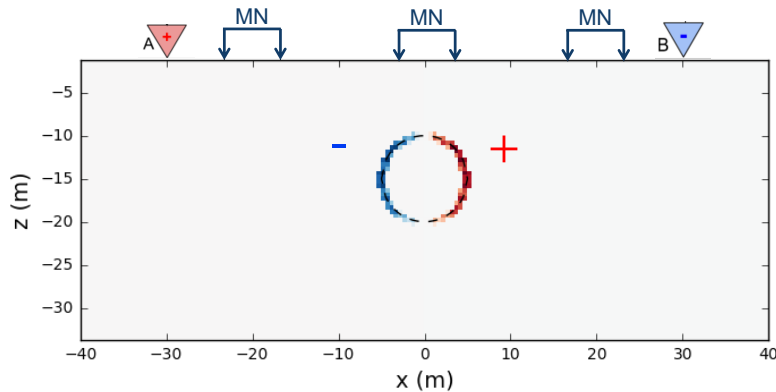

$\rho_a = 502$ $\rho_a = 430$ $\rho_a = 502$

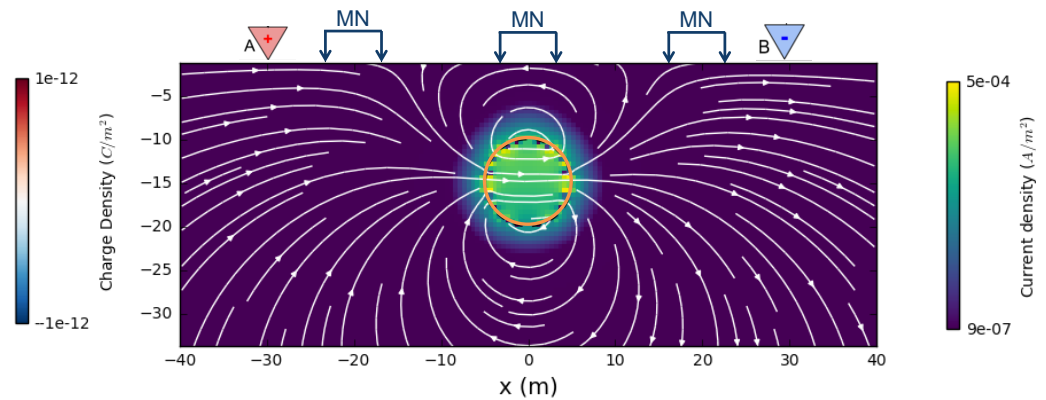

Profiling

Fixed geometry: Move laterally

Short offset, $a=4\text{m}$



Long offset, $a=20\text{m}$

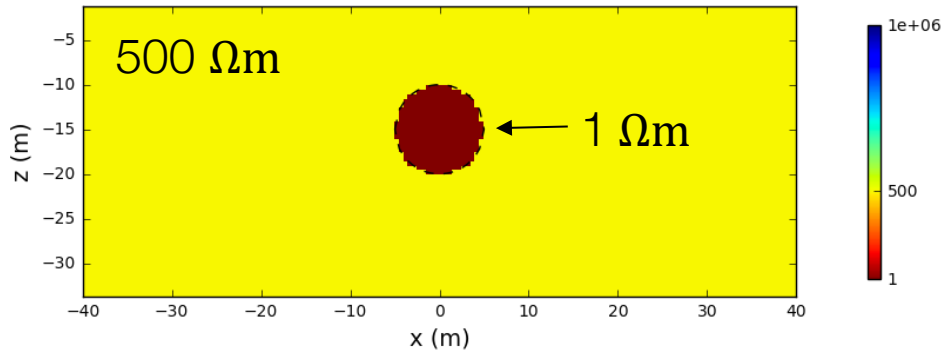
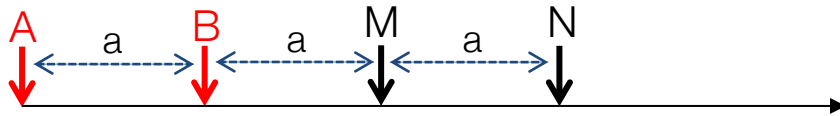

Short offset: $a = 4\text{ m}$

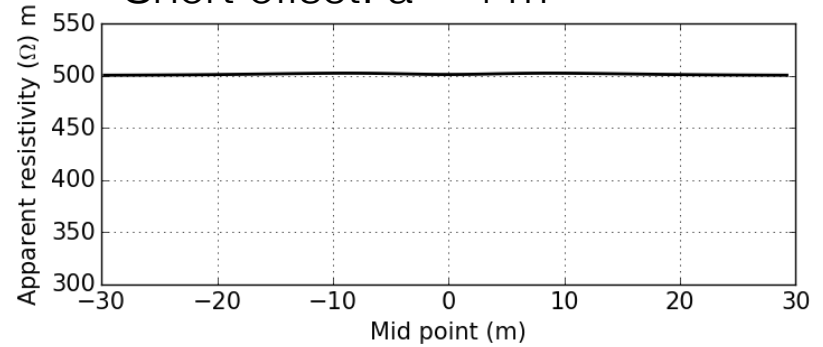

Long offset: $a = 20\text{ m}$

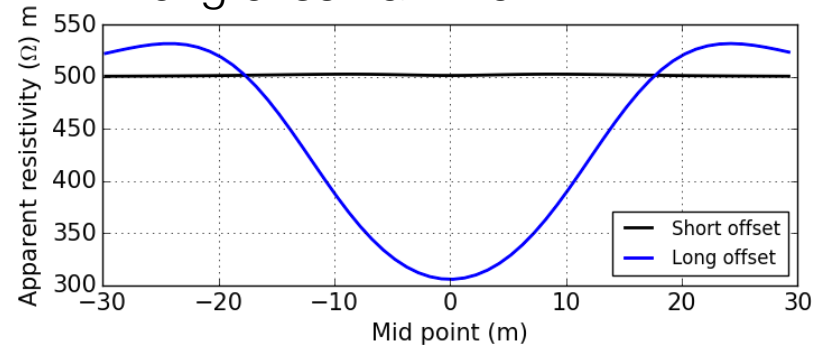

Depth of investigation depends upon offset or array length

Summary: Soundings and Profiles

Sounding

Expand

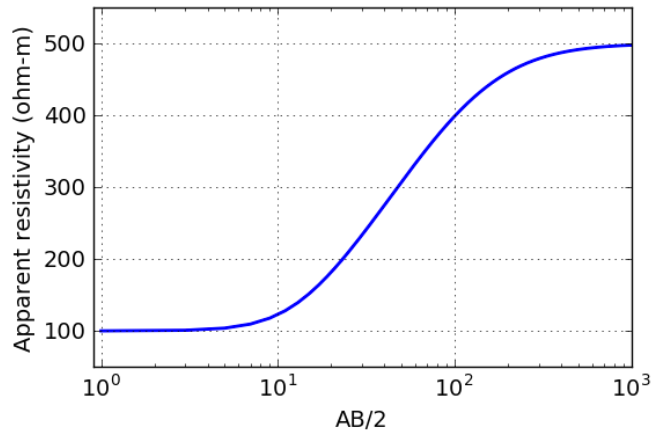
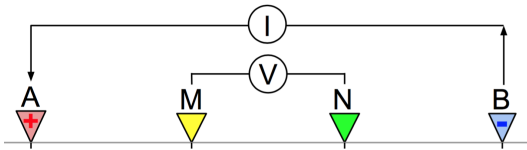

Profiling

Translate

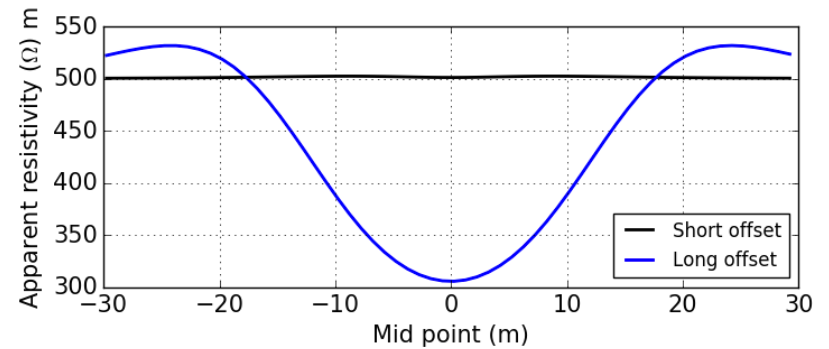
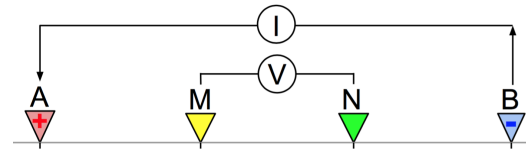

Basic Survey Setups

Wenner

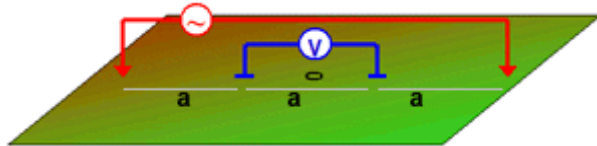

Pole-Pole

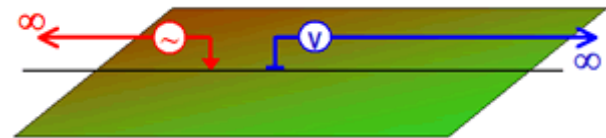

Schlumberger

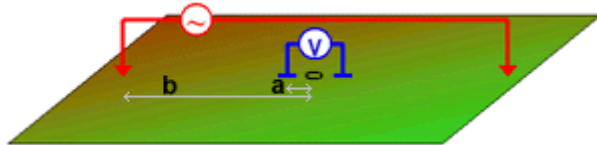

Pole-Dipole

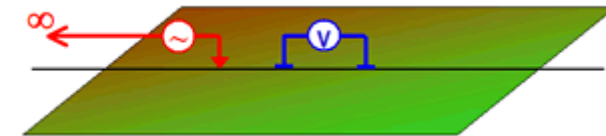

Gradient

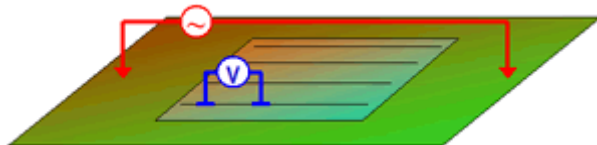

Dipole-Dipole

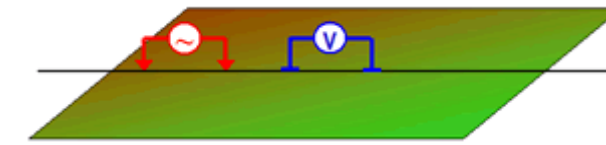

DC resistivity data

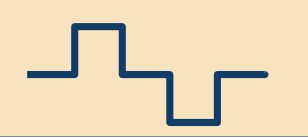
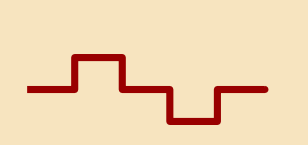
Source (Amps)	
Potential (Volts)	

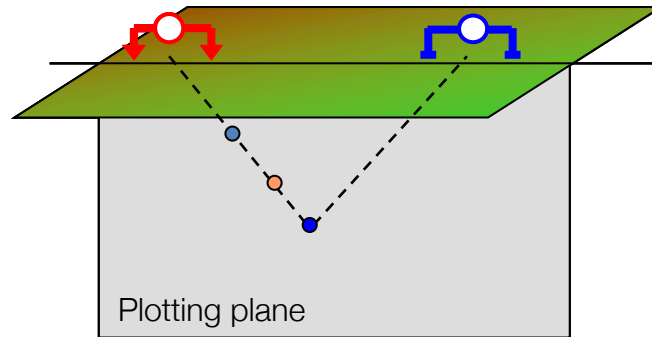

Each data point is an apparent resistivity:

$$\rho_a = \frac{2\pi\Delta V}{IG}$$

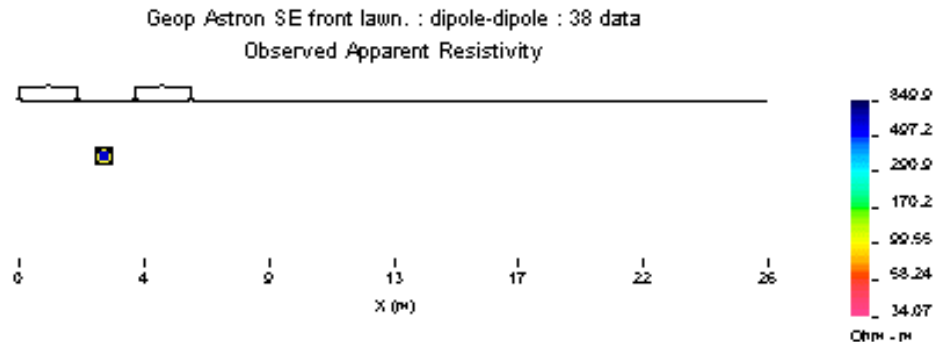

Example pseudosections

1) A single buried conductive block

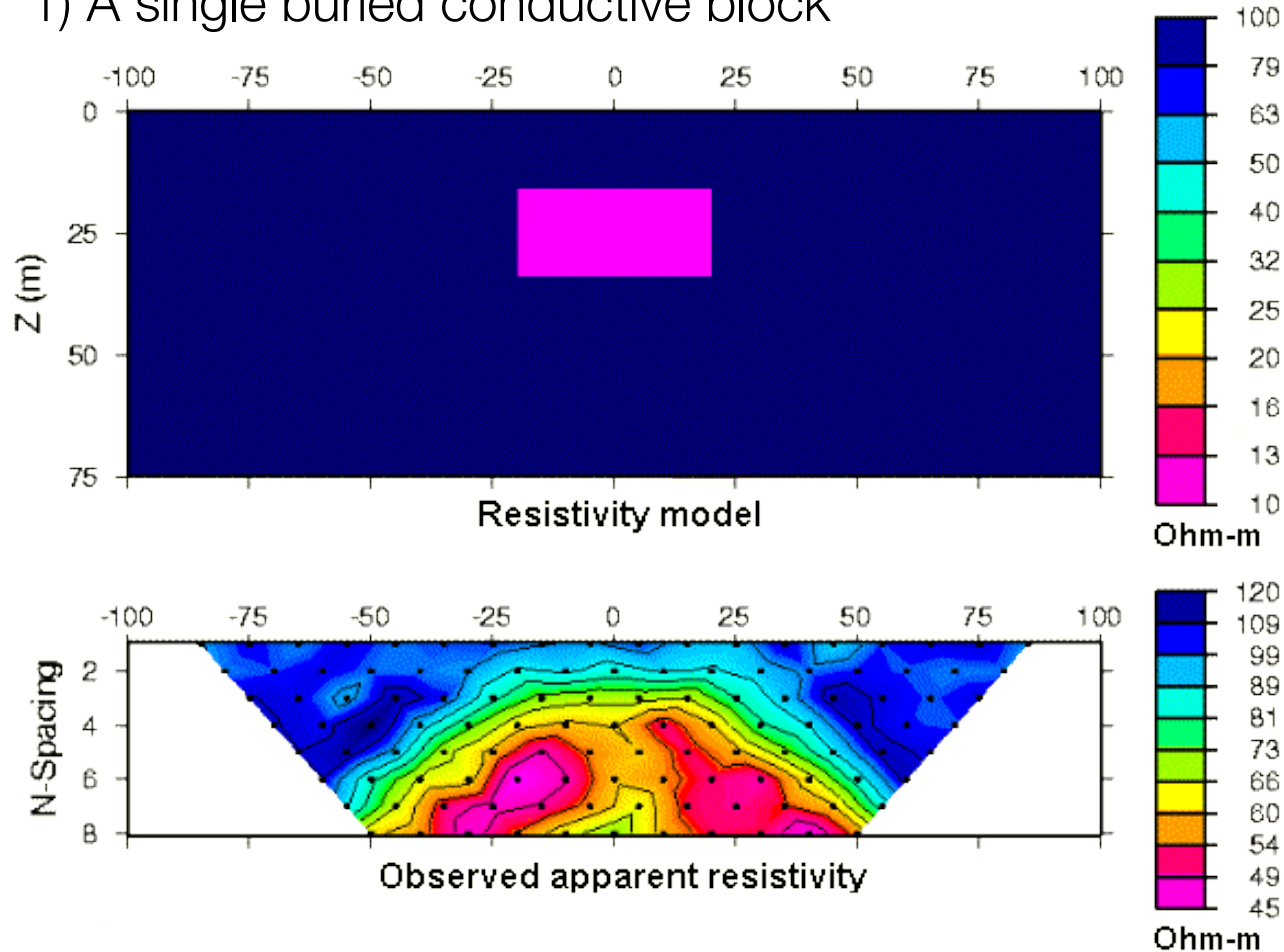

- Pole-dipole; $n=1,8$; $a=10\text{m}$; $N=316$

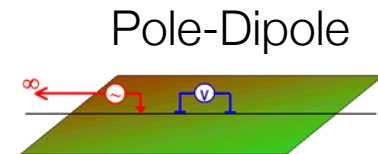

Example pseudosections

2) The conductive block with geologic noise.

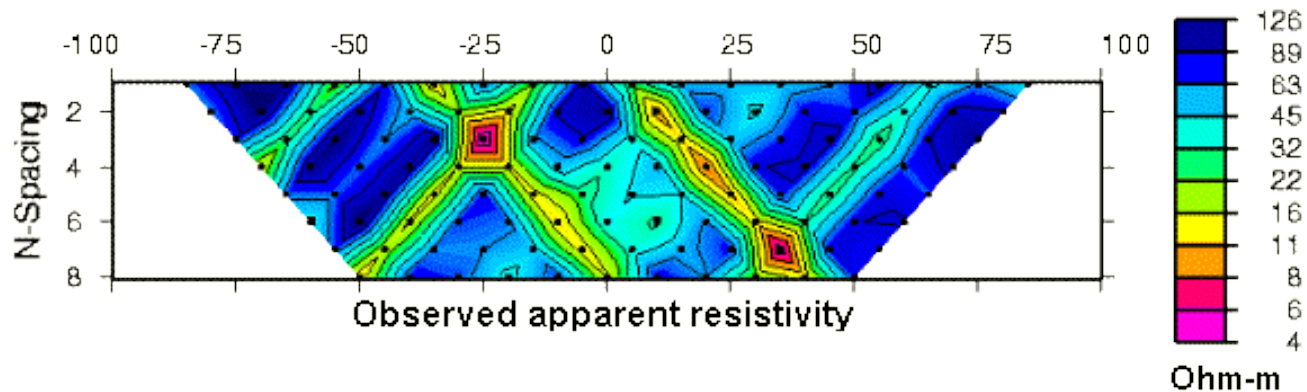
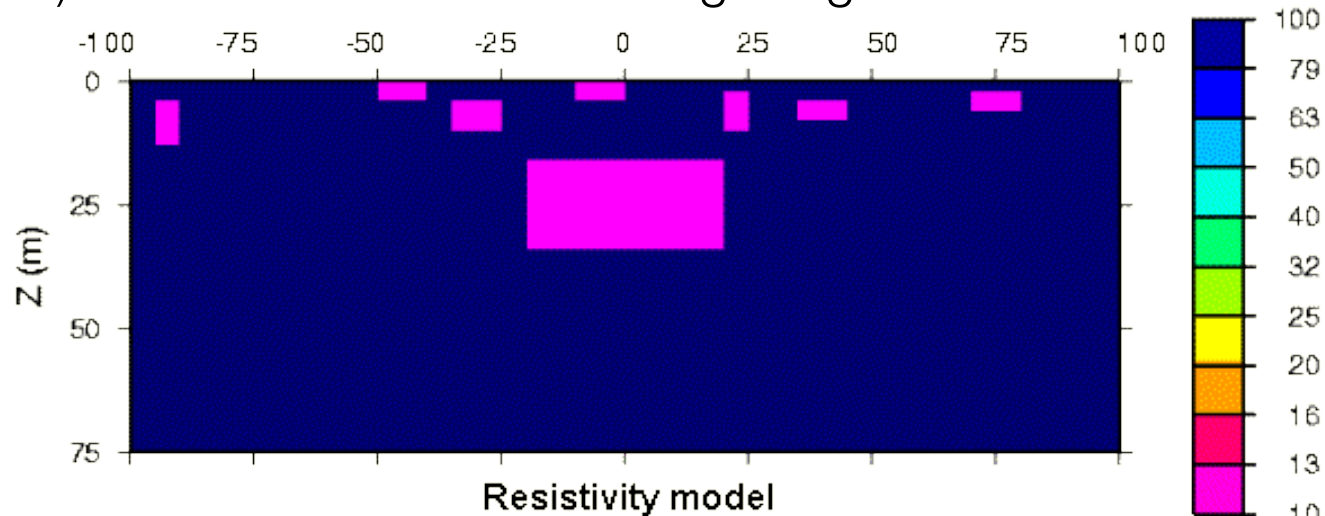

- Pole-dipole; $n=1,8$; $a=10\text{m}$; $N=316$

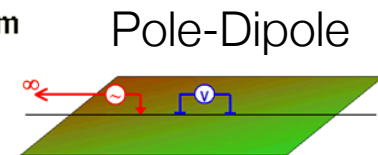

Example pseudosections

3) The “UBC-GIF model”

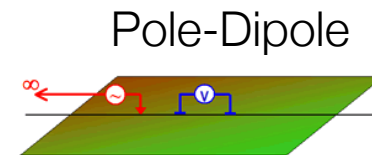
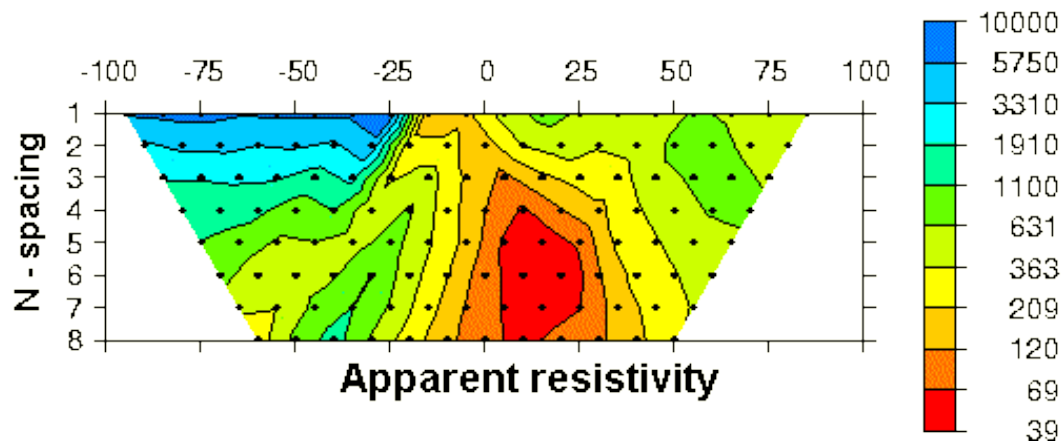
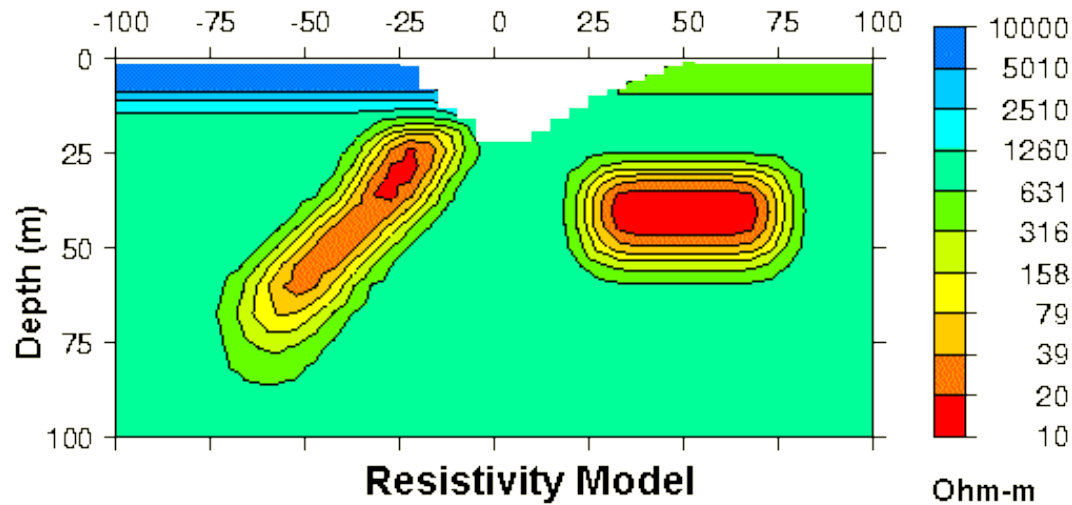

Inversion

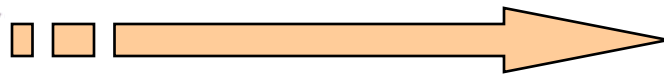
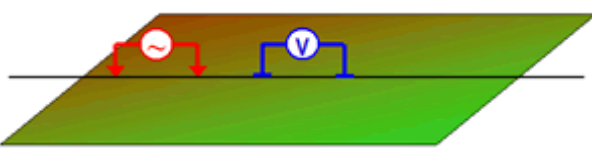

Data

Measurements over the Earth are data.

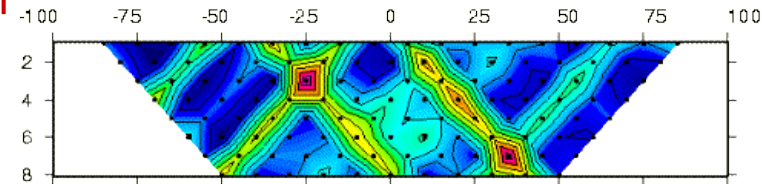

Observed apparent resistivity
Dipole dipole, $a=10\text{m}$, $n=1, \dots, 8$, 5% noise added.

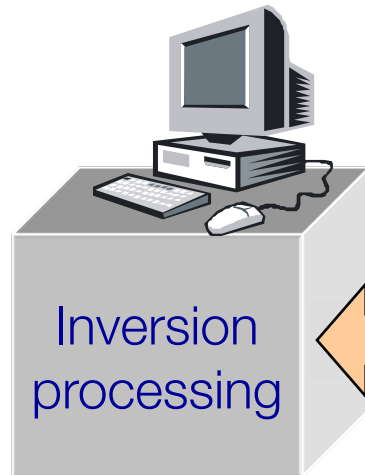
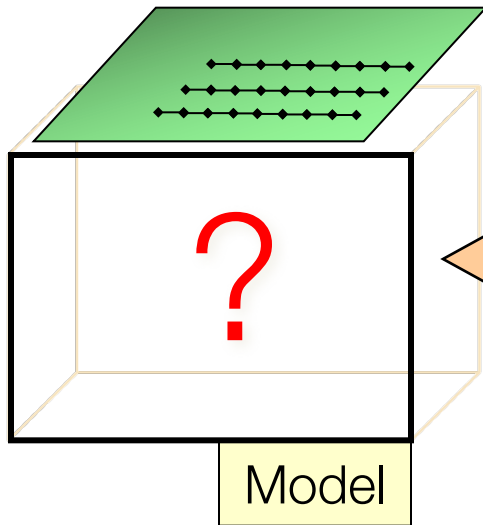

Inversion estimates Earth models based upon data and prior knowledge.

Example 1: buried prism

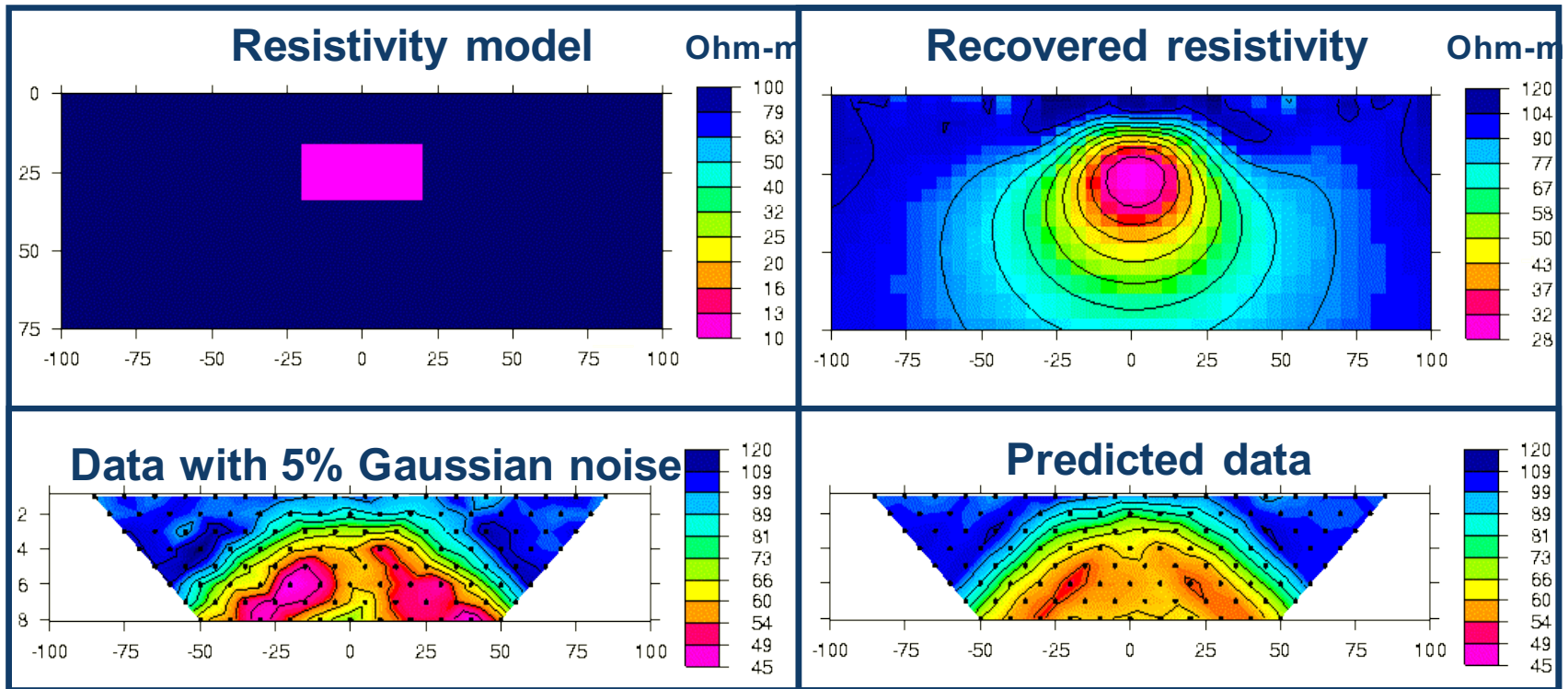

- Pole-dipole; $n=1,8$; $a=10\text{m}$; $N=316$; $(\alpha_s, \alpha_x, \alpha_z)=(.001, 1.0, 1.0)$

Example 2: prism with geologic noise

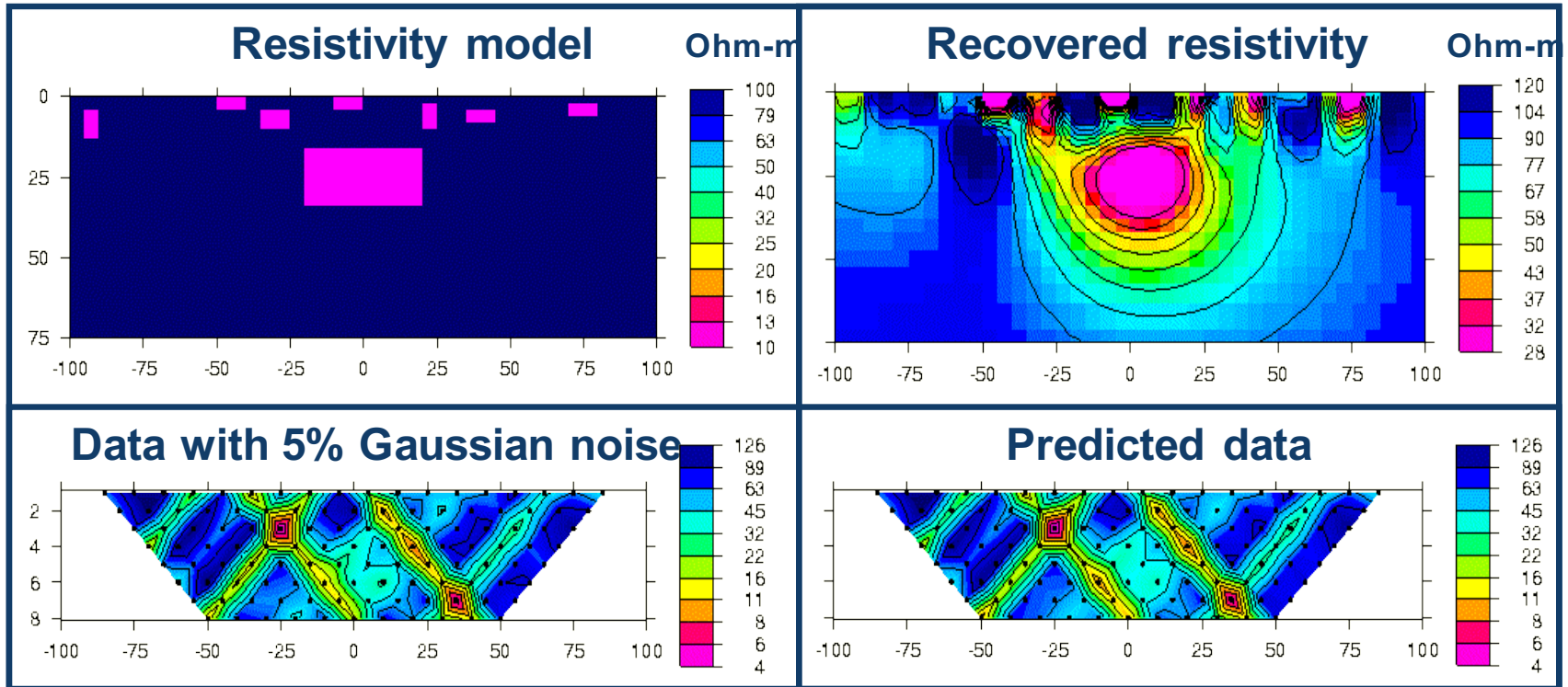

- Pole-dipole; $n=1,8$; $a=10\text{m}$; $N=316$; $(\alpha_s, \alpha_x, \alpha_z)=(.001, 1.0, 1.0)$

Example 3: UBC-GIF model

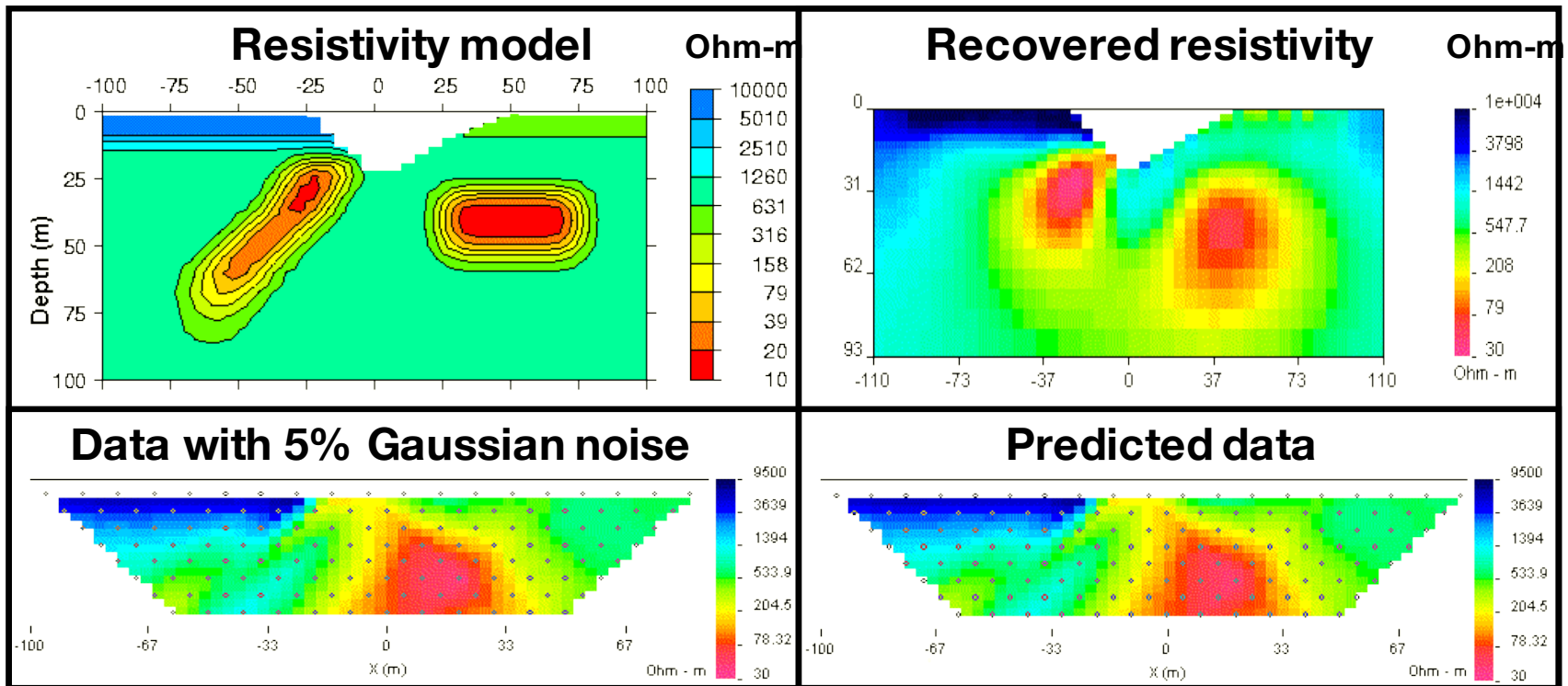

- Pole-dipole; $n=1,8$; $a=10\text{m}$

The world is 3D

- Target
 - Size, shape, depth
- Background
 - Variable resistivity
- Questions
 - Where to put currents? 2D acquisition? 3D?
 - Where to make measurements?
 - Which measurements?
 - Effects of topography?
- These are survey design questions
- Crucial element is the **sensitivity**

Host



Ore body

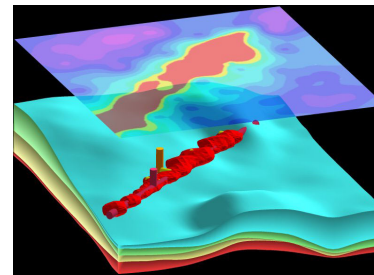

Topography

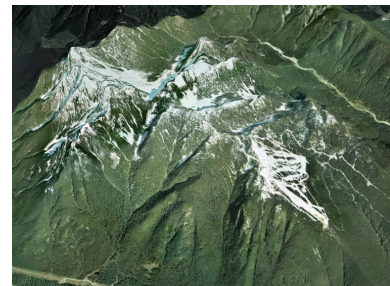

Water underground



Sensitivity

Sensitivity Function

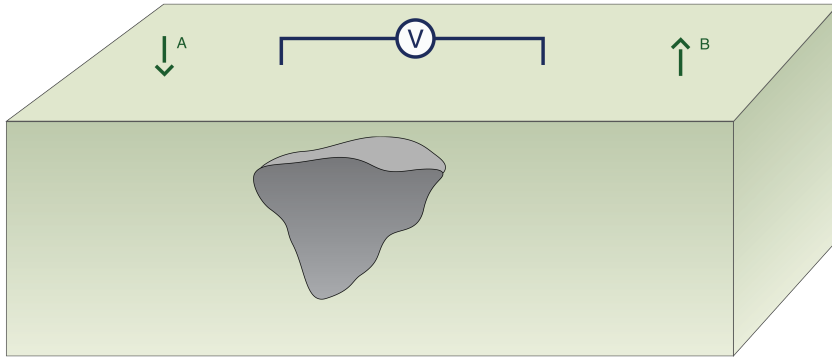

Is the measured potential *sensitive* to the target?

Quantified by the sensitivity

$$G = \frac{\Delta d}{\Delta p} = \frac{\text{change in data}}{\text{change in model}}$$

- Collect the data that are sensitive to the target
 - Need to **excite** the target
 - Need to have sensor **close** to the target

Exciting the target

Resistivity model

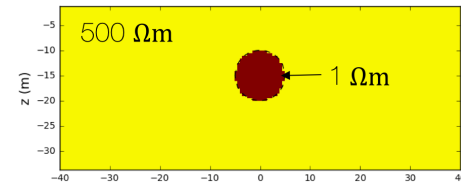

Total currents: \mathbf{J}

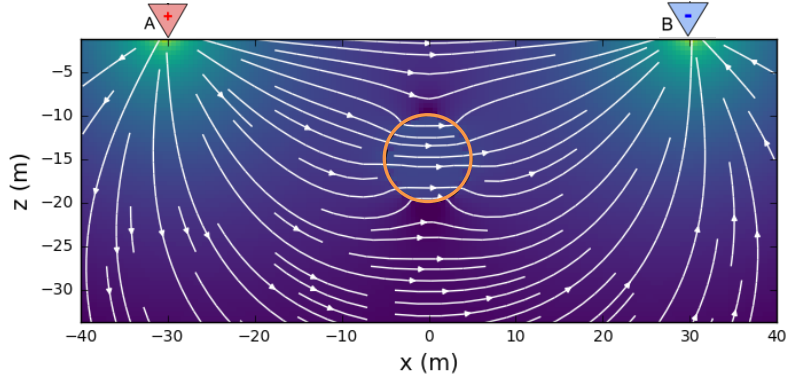

Secondary currents: \mathbf{J}_s

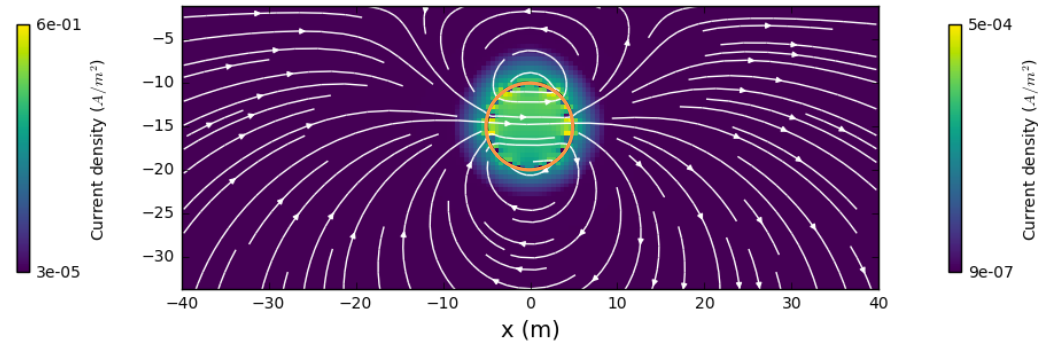

Secondary charges: Q_s

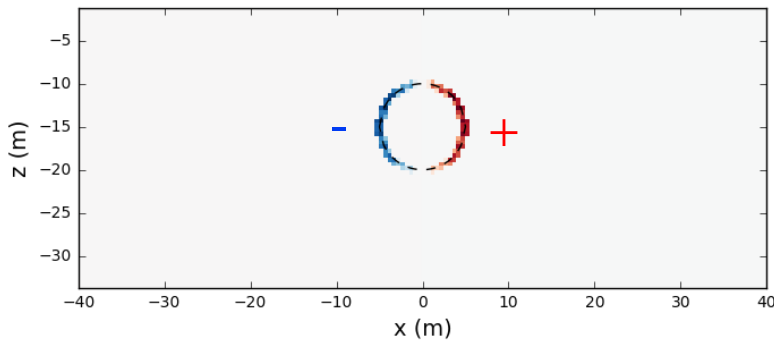

Secondary potential: ϕ_s

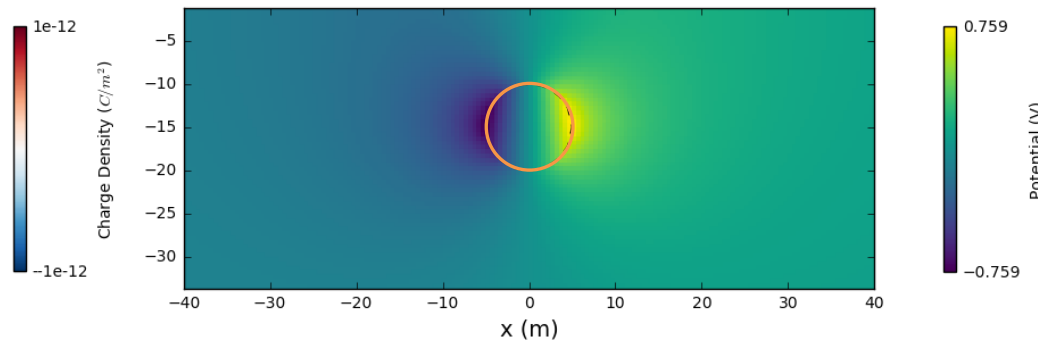

Measurements

Resistivity model

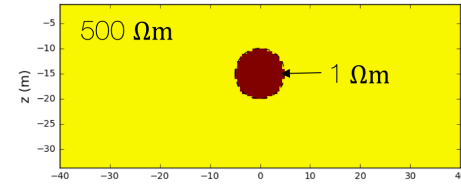

Secondary charges: Q_s

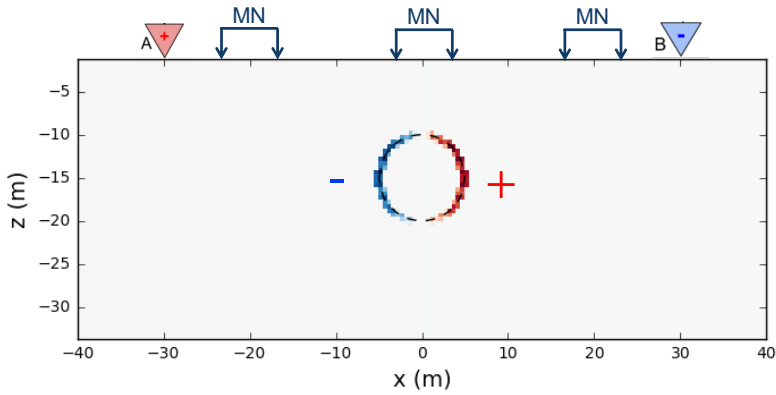

Potential profile

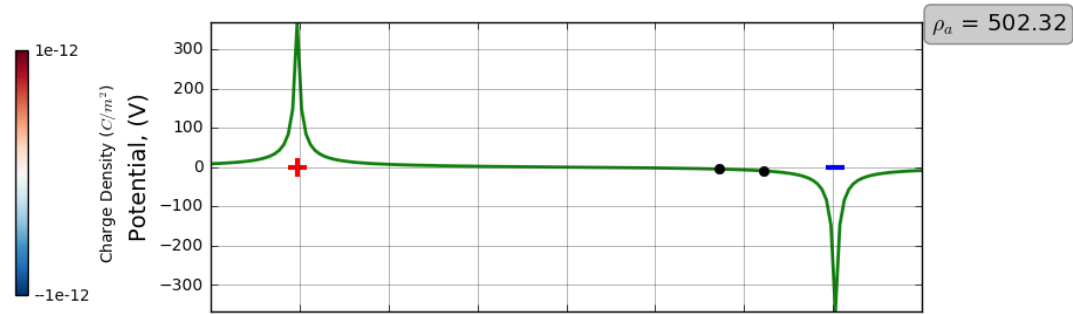

Secondary potential: ϕ_s

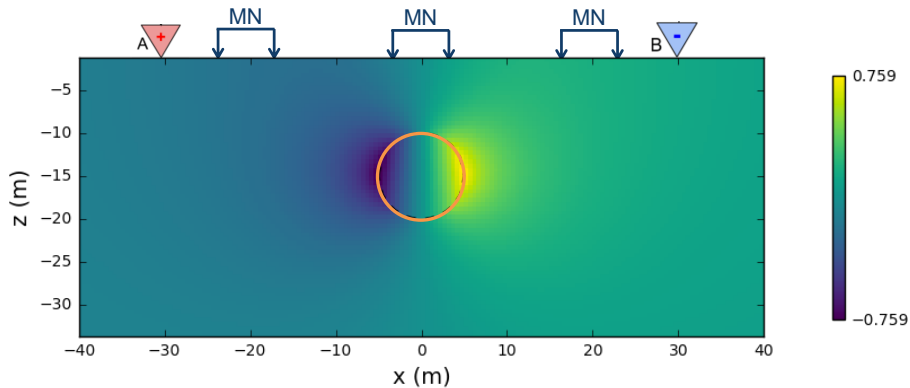

Total potential: ϕ

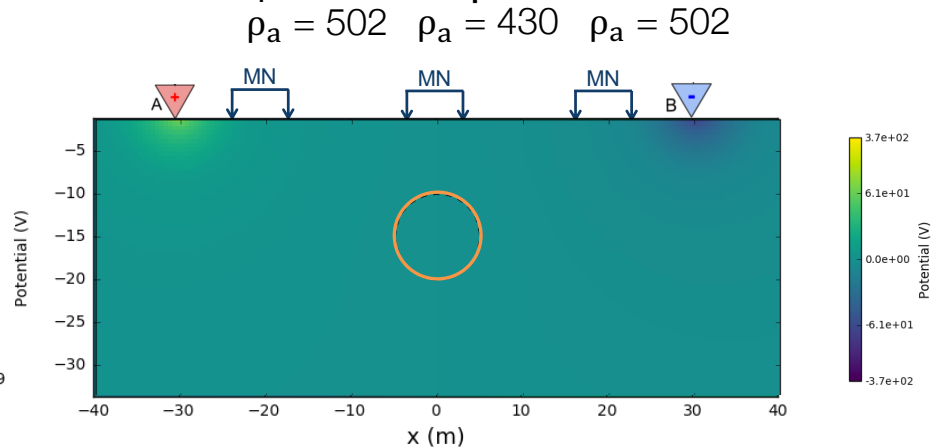

Coupling

- Thin plate – different orientations
→ different data

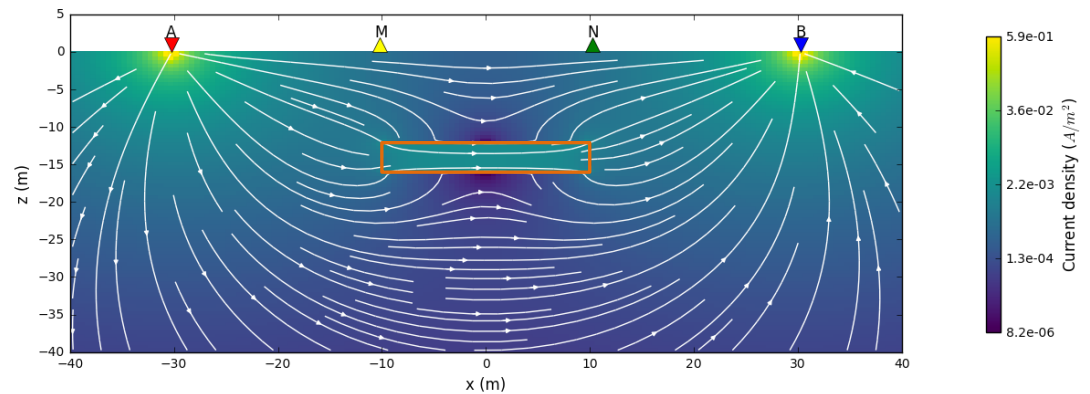
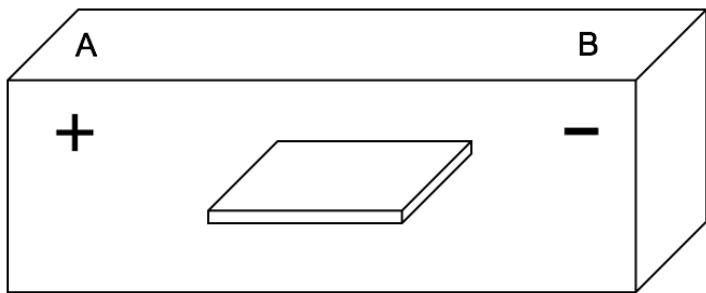
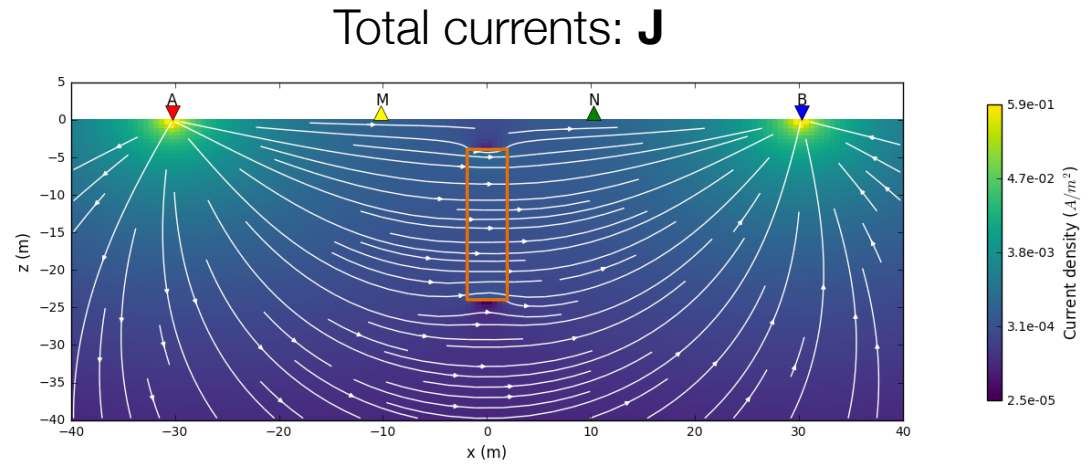
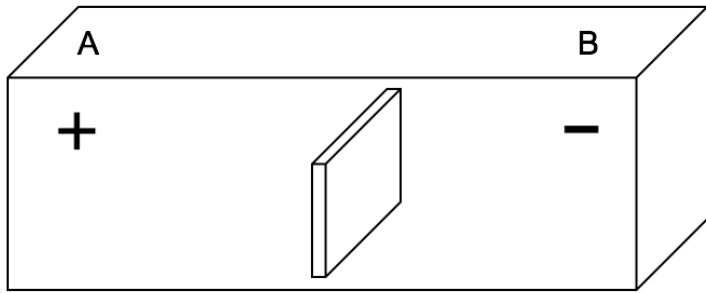

Conductive vs. Resistive Target

Conductive Target

Total currents: \mathbf{J}

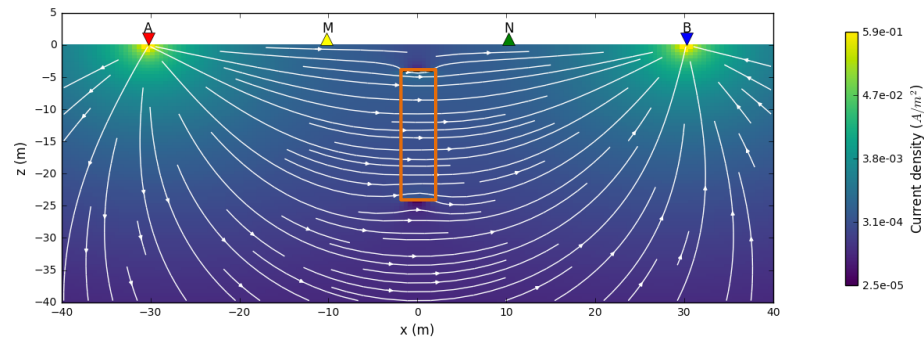

Resistive Target

Total currents: \mathbf{J}

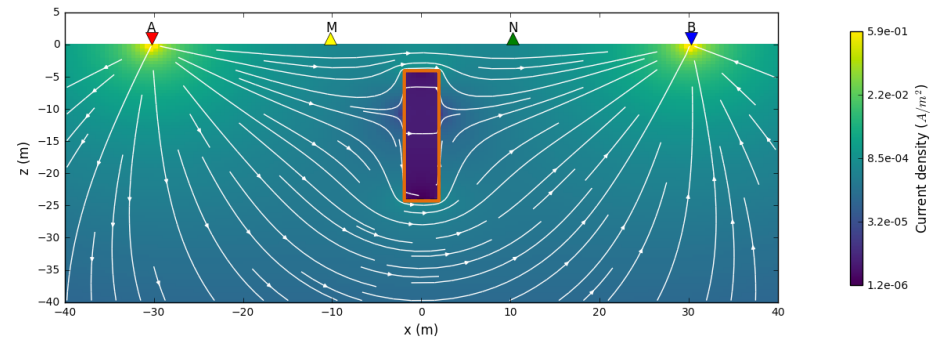

Secondary charges: Q_s

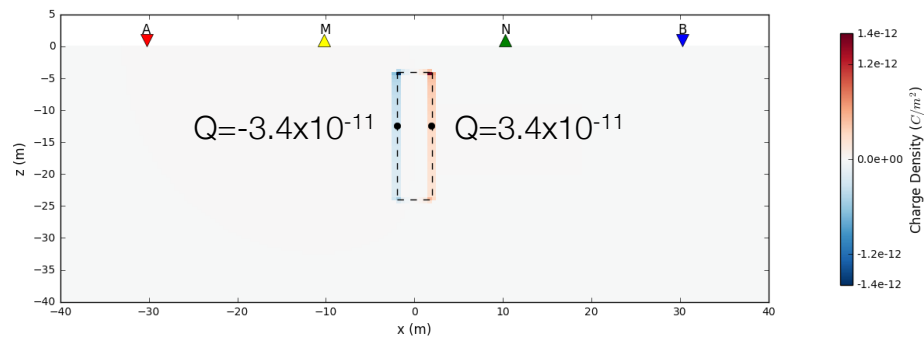

Secondary charges: Q_s

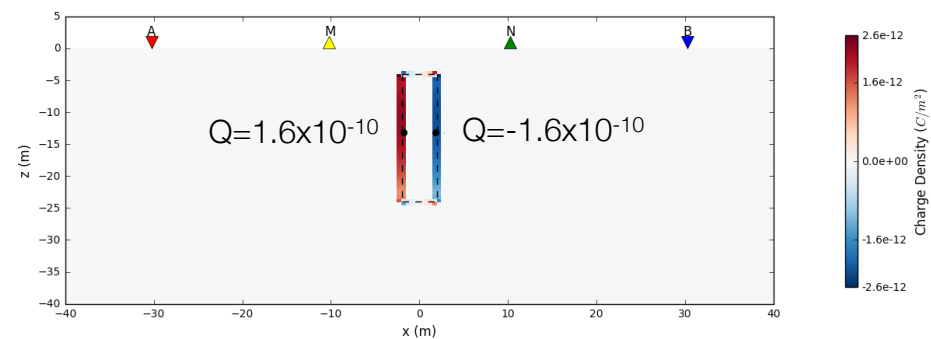

Summary: Sensitivity

- “Excite” the target
 - Drive currents to target
 - Need good coupling with target
- Measuring a datum
 - Proximity to target
 - Electrode orientation and separation
- Background resistivity is important

Total currents: \mathbf{J}

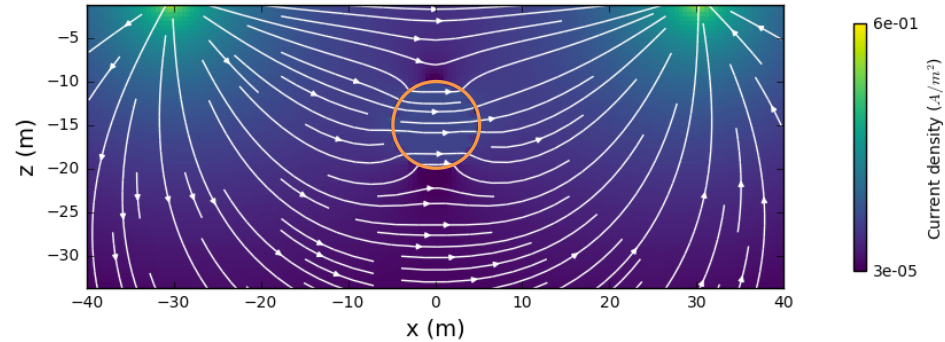

Secondary Charges: Q

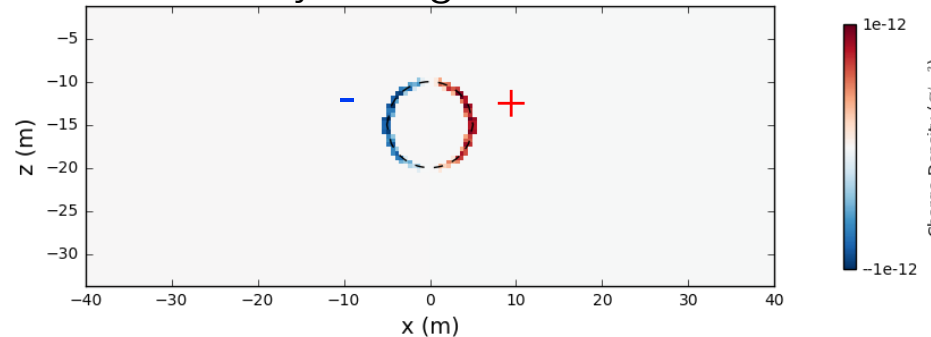

Total potential: ϕ

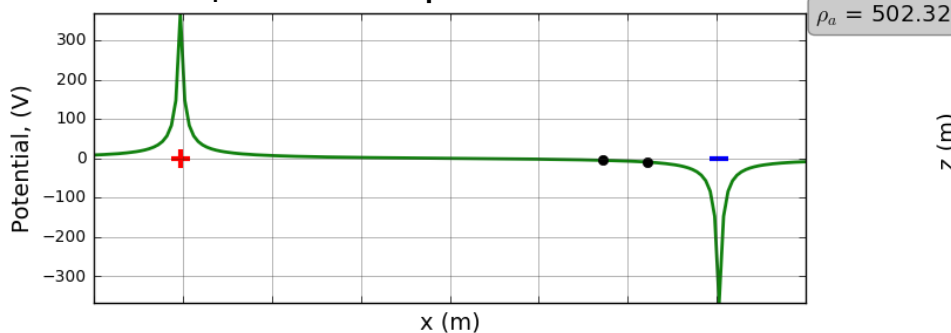

Secondary potential: ϕ_s

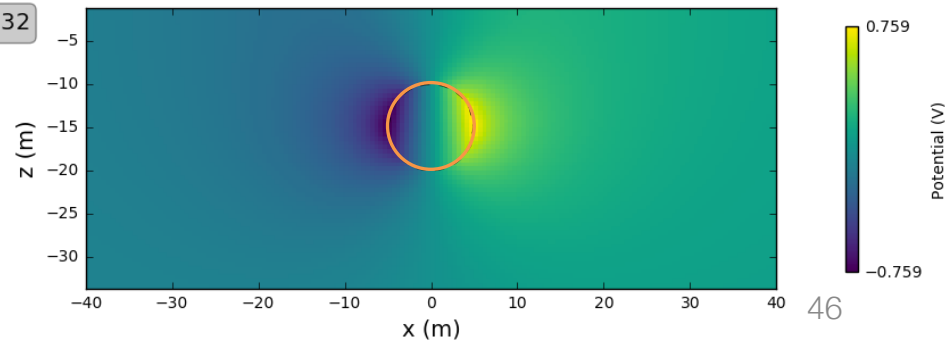

Survey Design: Questions

- What is objective?
 - Layered earth (1D)
 - do a sounding
 - Target body (2D)
 - profile, sounding perpendicular to geology
 - Target body (3D)
 - need 3D coverage
- What is the background resistivity?
- What are the noise sources?
fences, power lines, ...

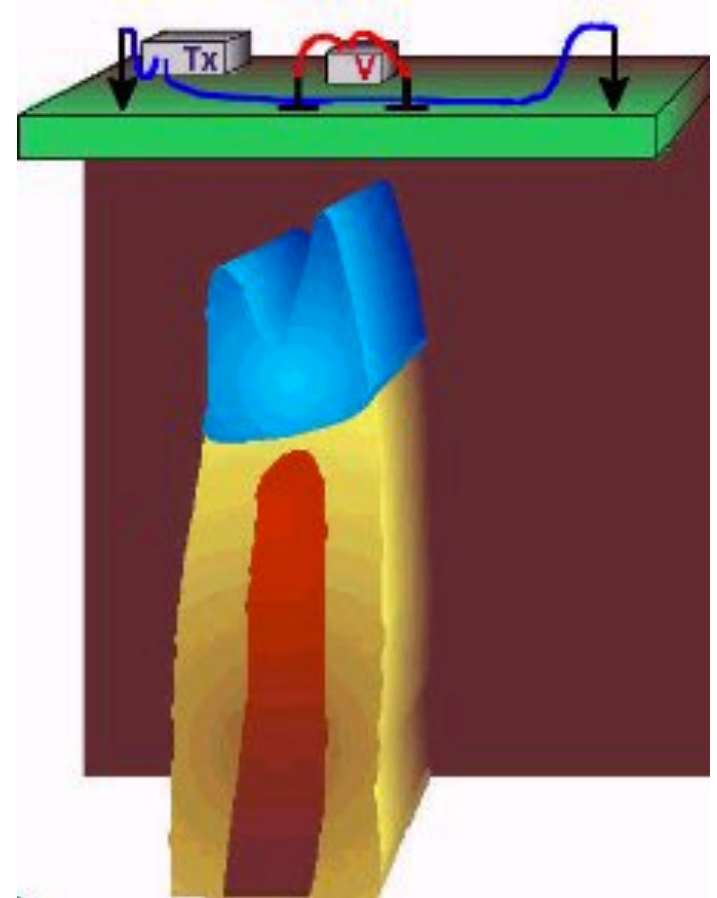

Survey Design: in general

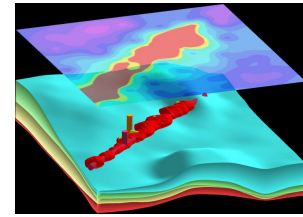

- Numerical simulation – can we **see** the target?
- Steps:
 - Define a geologic model
 - Assign physical properties
 - Select a survey
 - Simulate with (V) and without (V_p) target
- Best practice
 - Assign uncertainties to simulated data
 - Invert with code you will use for the field data

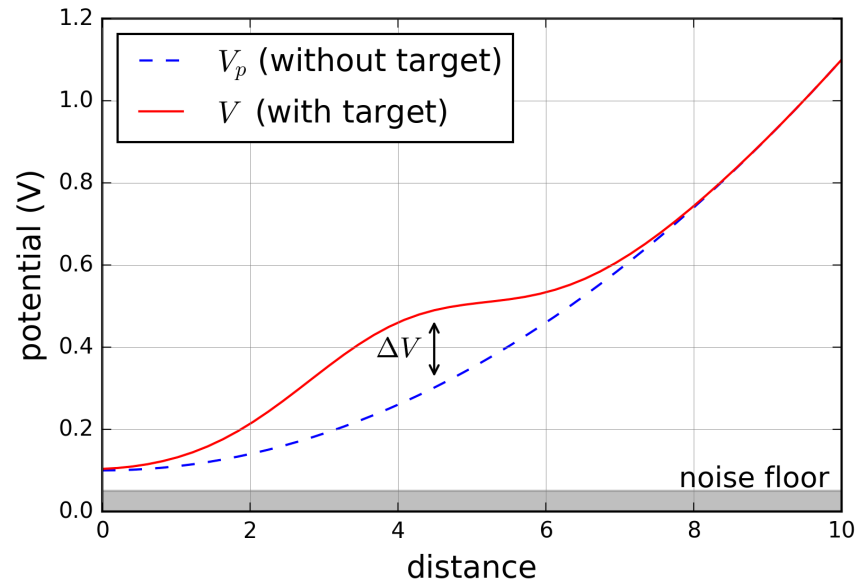

Signal from target

$$\Delta V = V - V_p$$

Need

$$\Delta V > \textit{floor}$$

$$\frac{\Delta V}{V_p} > \%|V|$$

Outline

- Basic experiment
 - Currents, charges, potentials and apparent resistivities
 - Soundings, profiles and arrays
 - Data, pseudosections and inversion
 - Sensitivity
 - Survey Design
-
- Case History – Mt Isa
 - Case History – Dam Monitoring
 - Effects of background resistivity

Mt. Isa

Mt. Isa (Cluny prospect)

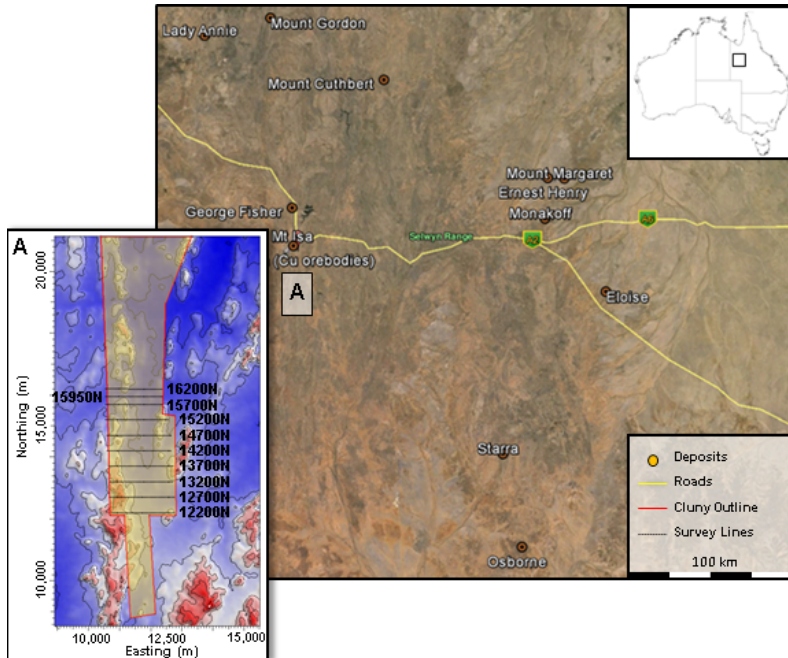

Seven Steps

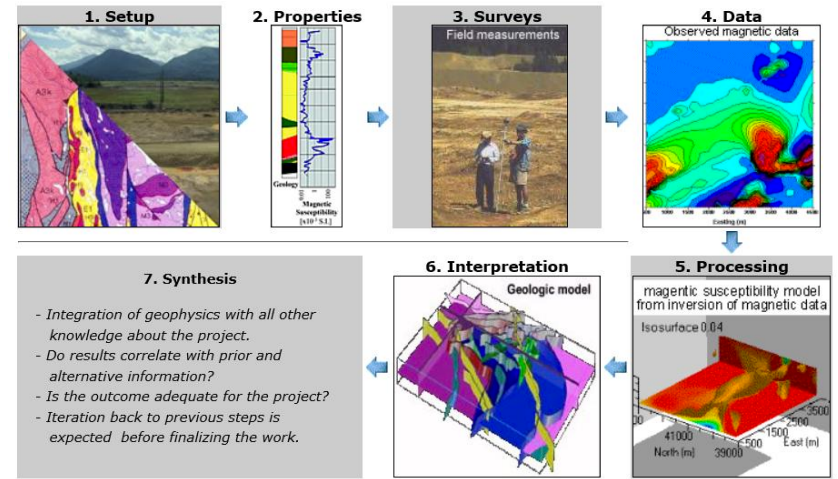

Setup

Mt. Isa (Cluny prospect)

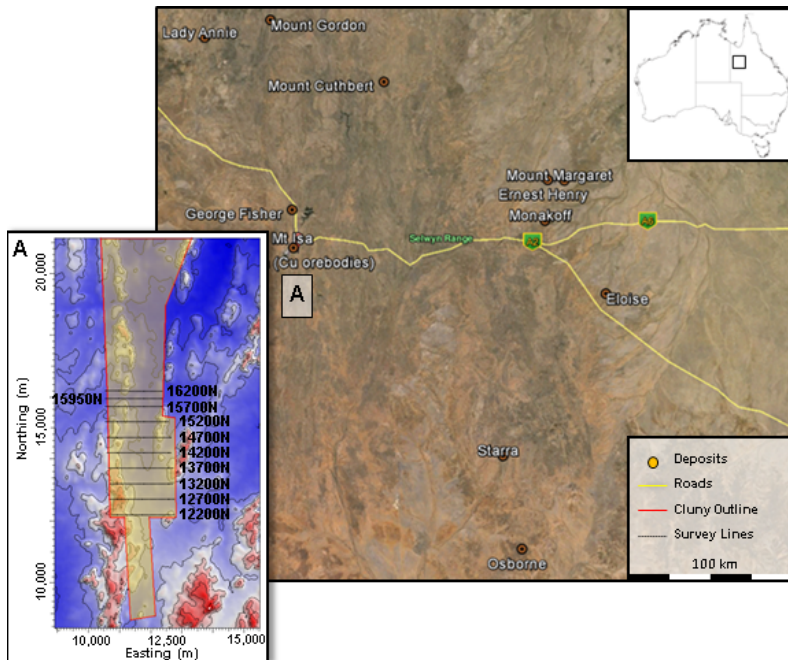

Geologic model

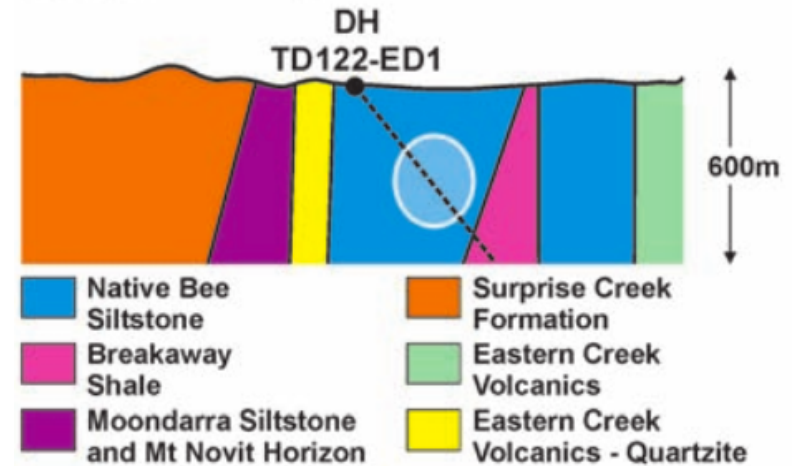

Question

- Can conductive units, which would be potential targets within the siltstones, be identified with DC data?

Properties

Geologic model

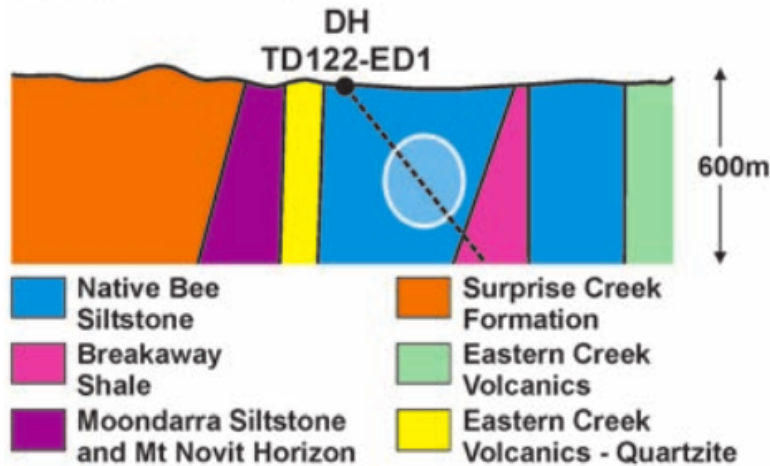

Surface topography

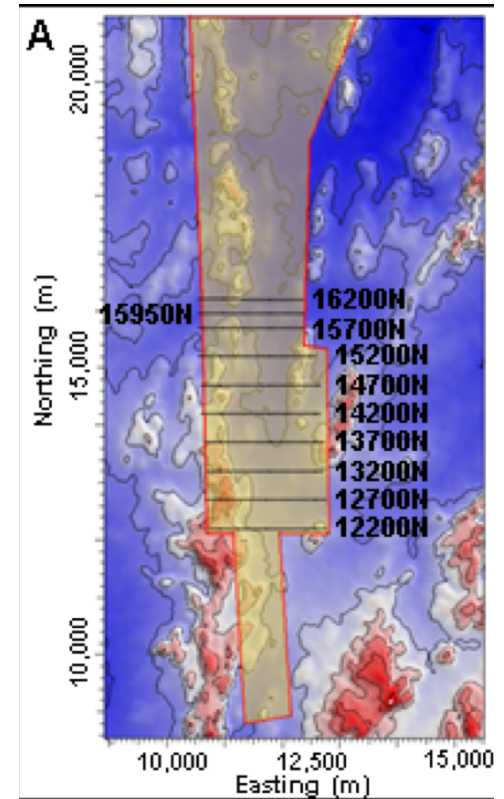

Rock Unit	Conductivity
Native Bee Siltstone	Moderate
Moondarra Siltstone	Moderate
Breakaway Shale	Very High
Mt Novit Horizon	High
Surprise Creek Formation	Low
Eastern Creek Volcanics	Low

Survey and Data

- Eight survey lines
- Two survey configurations.

Surface topography

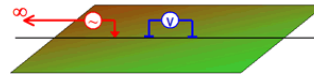
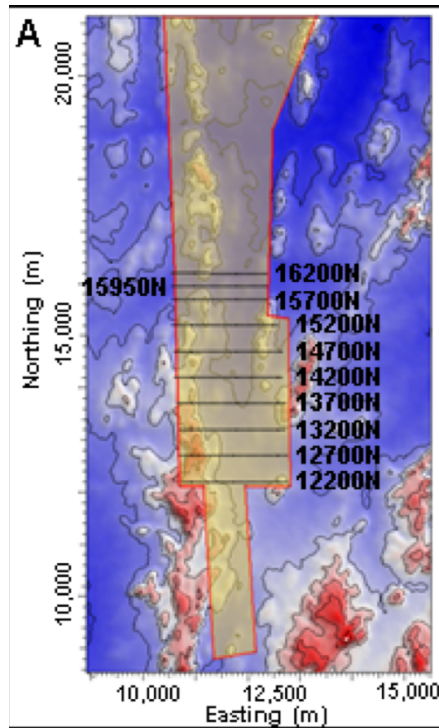

Data set #1:

Apparent resistivity,
pole - dipole.

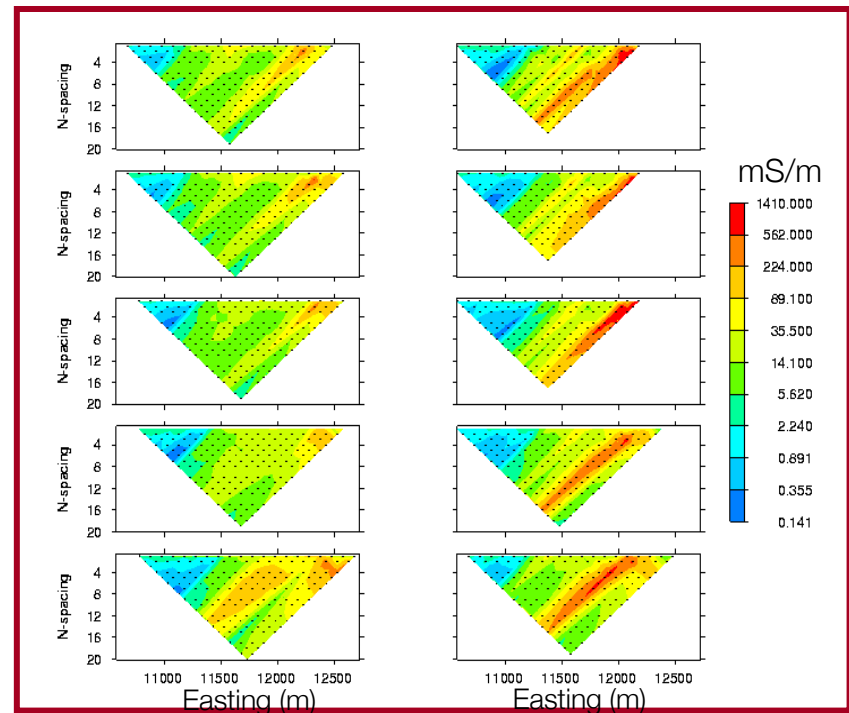

Survey and Data

- Eight survey lines
- Two survey configurations.

Data set #2:

Apparent resistivity,
dipole - pole

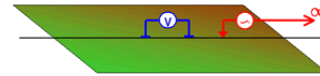

Surface topography

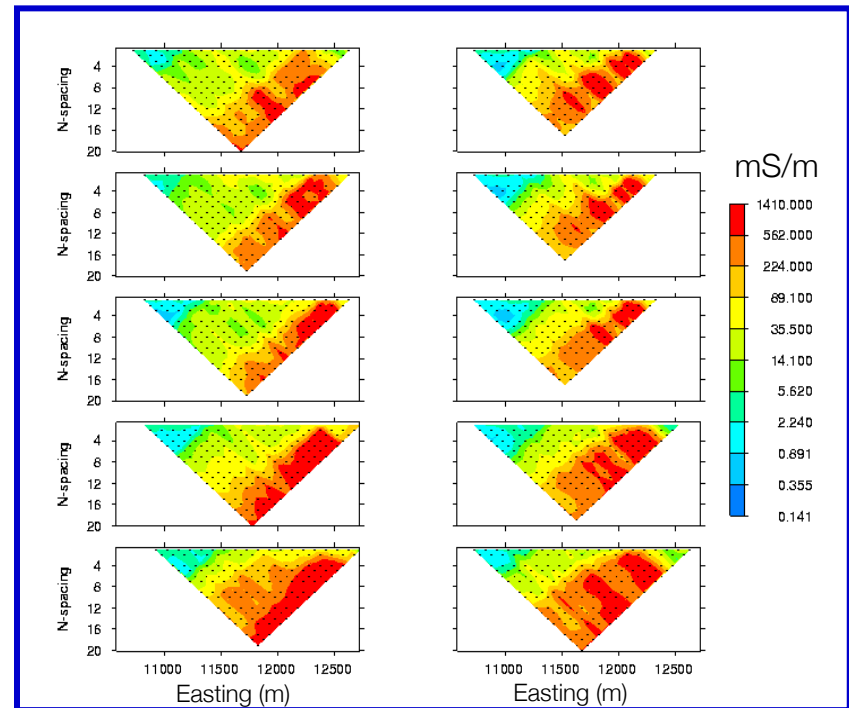
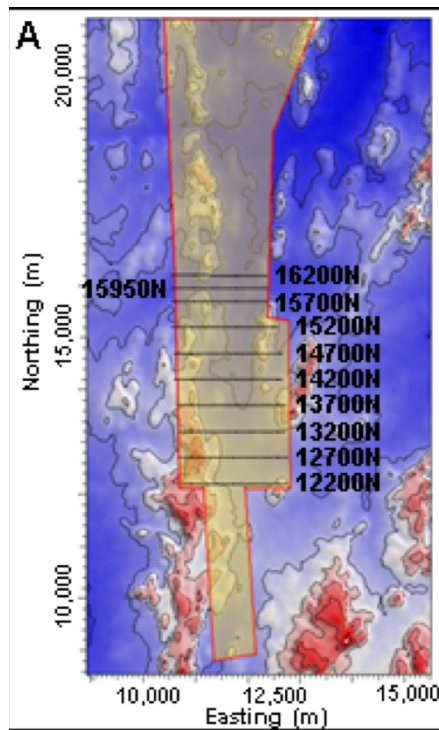

Processing and interpretation

3D resistivity model

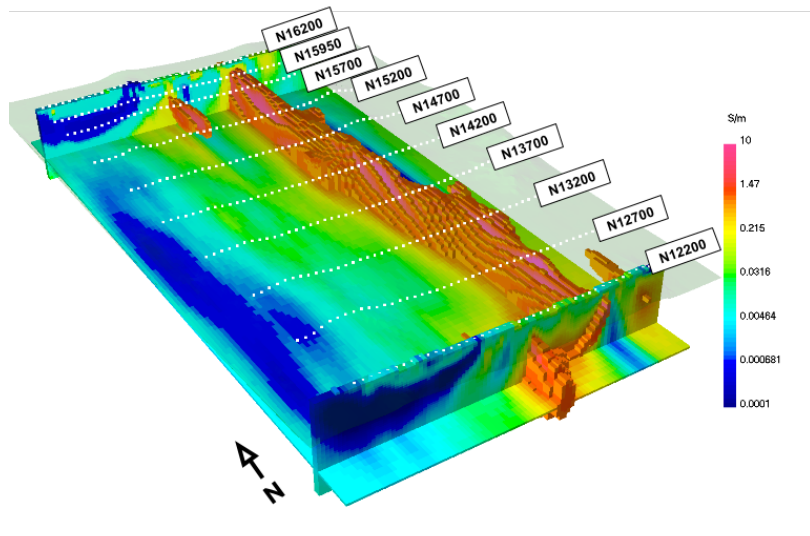

Animation

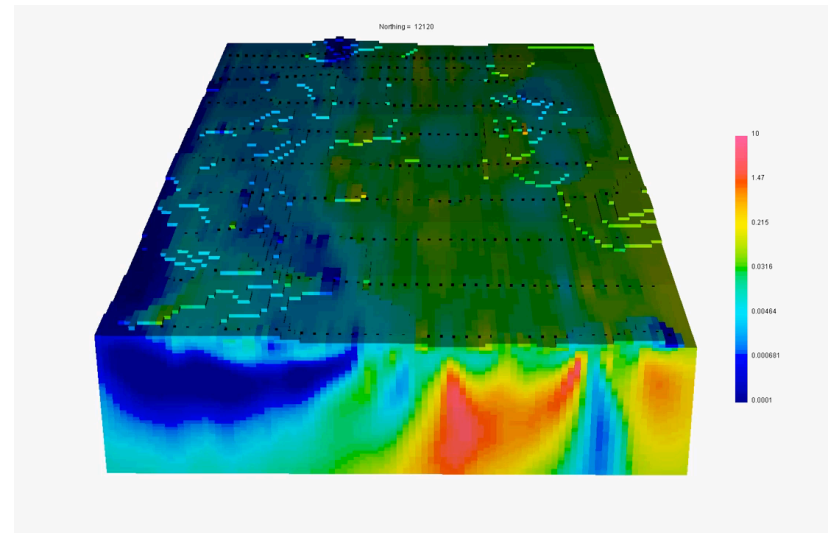

Synthesis

- Identified a major conductor \rightarrow black shale unit
- Some indication of a moderate conductor

3D resistivity model

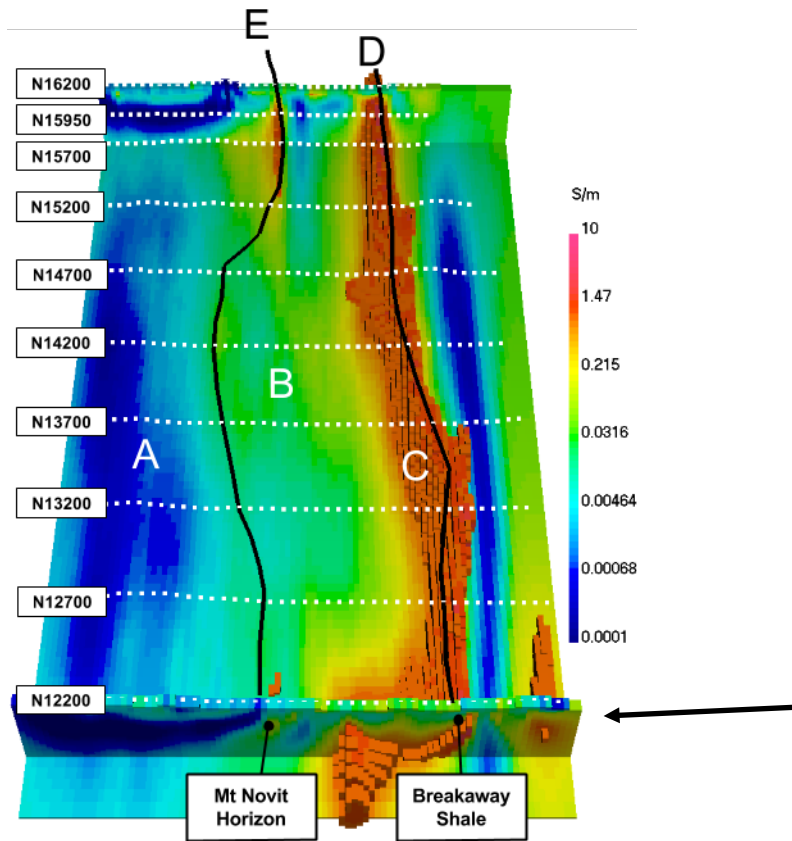

Geologic section

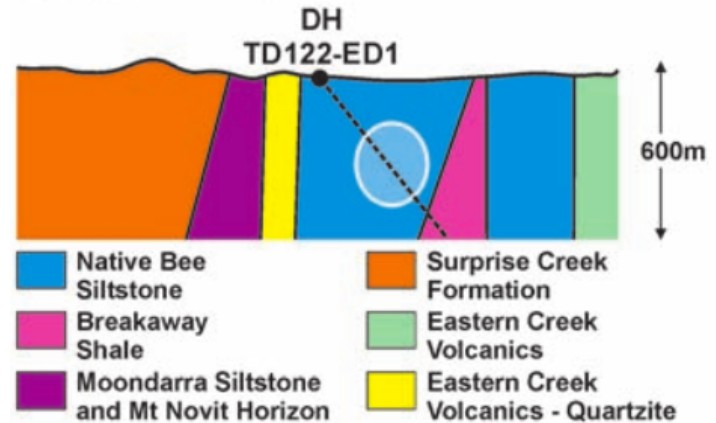

Resistivity section

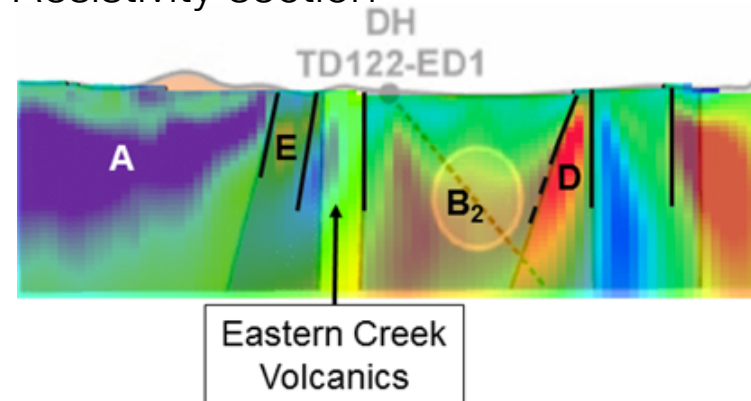

Case History: Monitoring an embankment dam Rhône river, France

Boleve and Revil., 2009

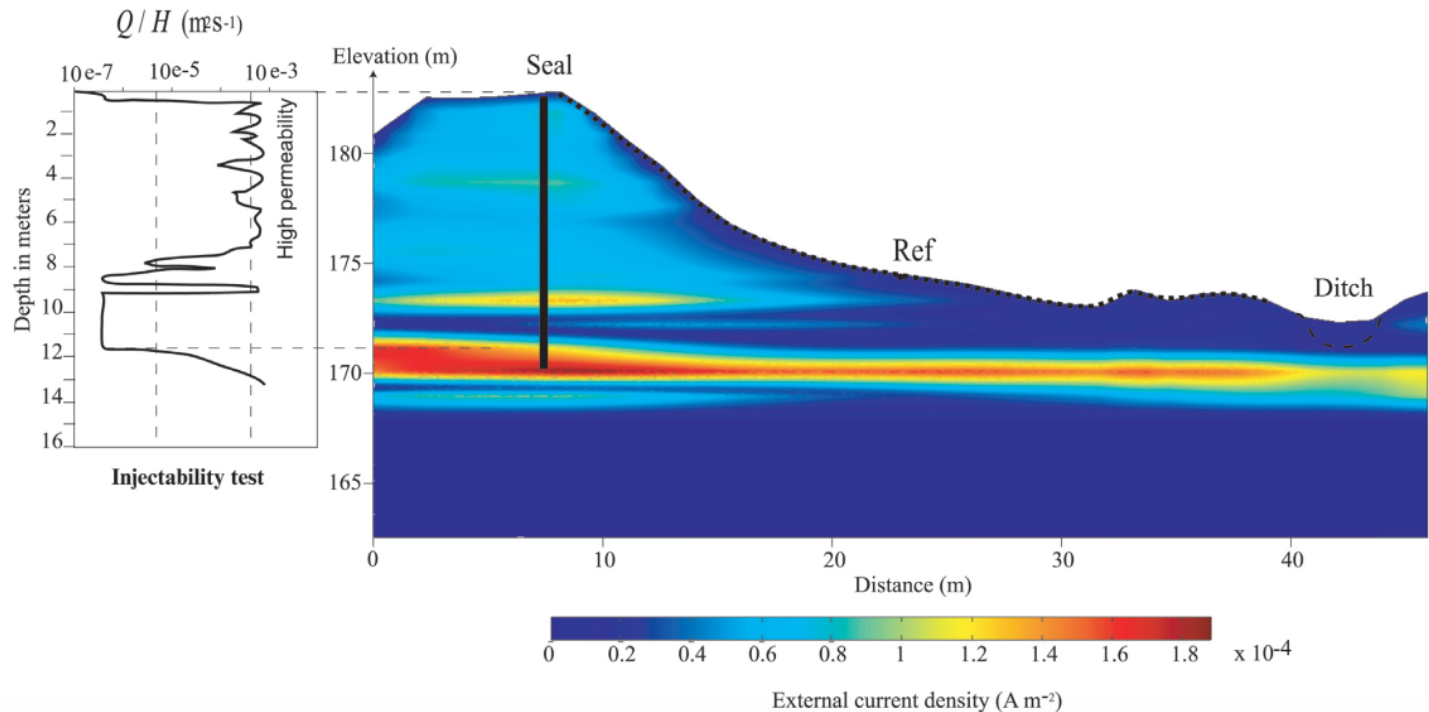

Physics of streaming potential

Fluid flow

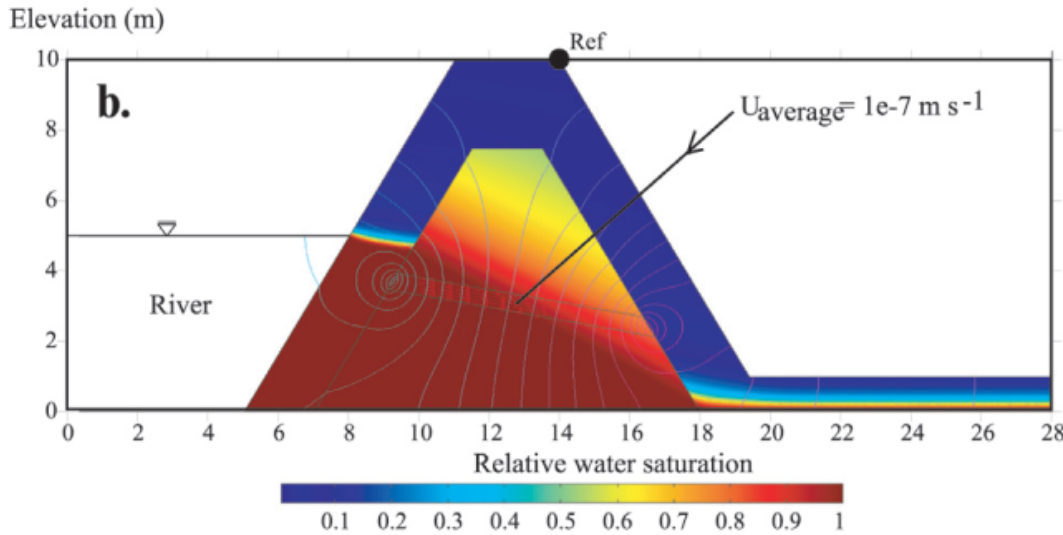

Steady-state, unsaturated flow

$$\vec{u} = K \nabla h$$

$$\nabla \cdot \vec{u} = 0 \quad \text{With B.C.}$$

$$K = k_r(S_w, \dots) K_s$$

\vec{u} : fluid velocity [m/s]

h : hydraulic head [m]

K : hydraulic conductivity [m/s]

S_w : saturation

K_s : hydraulic conductivity at $S_w=1$

k_r : relative permeability

Materials

K_s (m s⁻¹)

Sand

1.10⁻⁵

Clay

1.10⁻⁹

Leaking area

1.10⁻⁶

Physics of streaming potential

Streaming potential

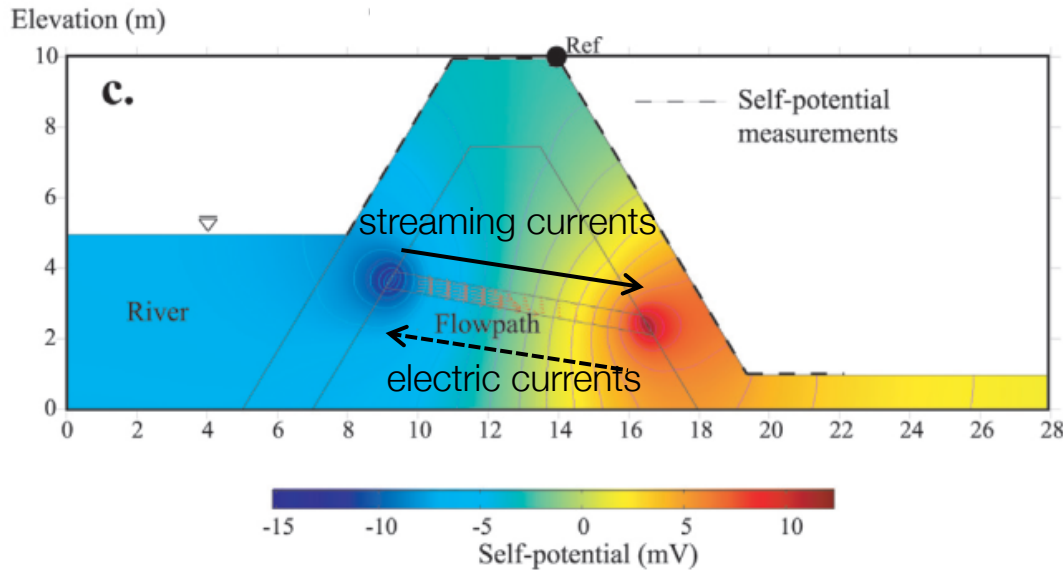

Streaming currents

$$\nabla \cdot \vec{j} = 0$$

$$\vec{j} = \vec{j}_e + \vec{j}_s$$

$$\vec{j}_e = -\sigma \nabla \phi \quad \vec{j}_s = \frac{Q_v}{S_w} \vec{u}$$

$$\nabla \cdot \sigma \nabla \phi = \nabla \cdot \vec{j}_s$$

Materials	σ (S m ⁻¹)	\bar{Q}_v (C m ⁻³)	K_s (m s ⁻¹)
Sand	$3.3 \cdot 10^{-3}$	0.5	$1 \cdot 10^{-5}$
Clay	$1 \cdot 10^{-2}$	500	$1 \cdot 10^{-9}$
Leaking area	$1 \cdot 10^{-2}$	500	$1 \cdot 10^{-6}$

Q_v : excess electrical charge per unit pore volume [C/m³]

Physics of streaming potential

Streaming potential

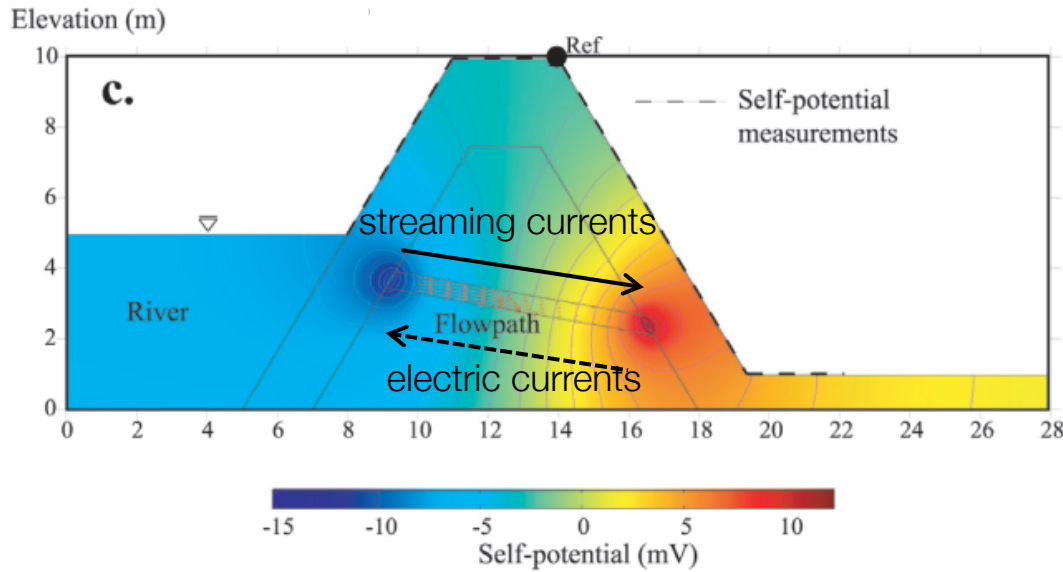

Streaming currents

$$\nabla \cdot \vec{j} = 0$$

$$\vec{j} = \vec{j}_e + \vec{j}_s$$

$$\vec{j}_e = -\sigma \nabla \phi \quad \vec{j}_s = \frac{Q_v}{S_w} \vec{u}$$

$$\nabla \cdot \sigma \nabla \phi = \nabla \cdot \vec{j}_s$$

Measured streaming potential difference: $\phi - \phi_{ref}$

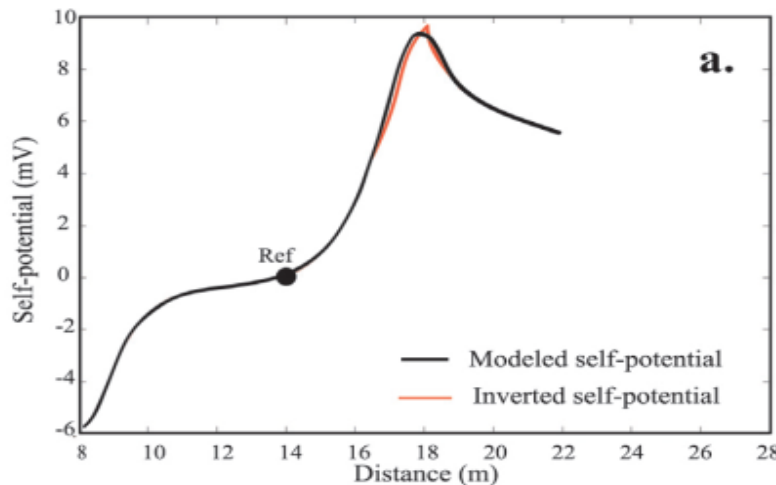

Setup

Embankment dam in southeast France along the Rhone River

a.



b.

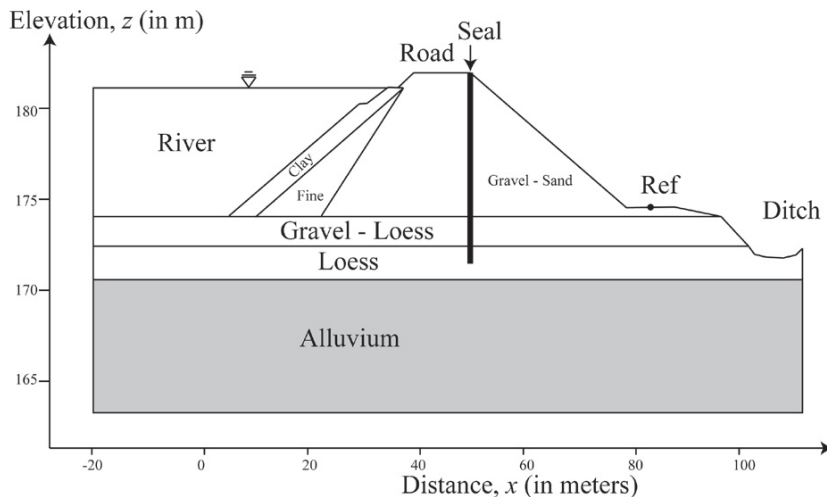

- Unconsolidated materials:
 - sand + gravels
- Riverside impermeable layer
 - cemented clay and silt
- Expected water seepage
 - leakage water collected in a ditch
- Piezometers
 - measure water level
 - every ~150m
- Vertical sealing
 - cement + bentonite
 - 12 m height and 12cm width

Can we image the preferential seepage zone, and determine velocity?

Properties

Geologic section

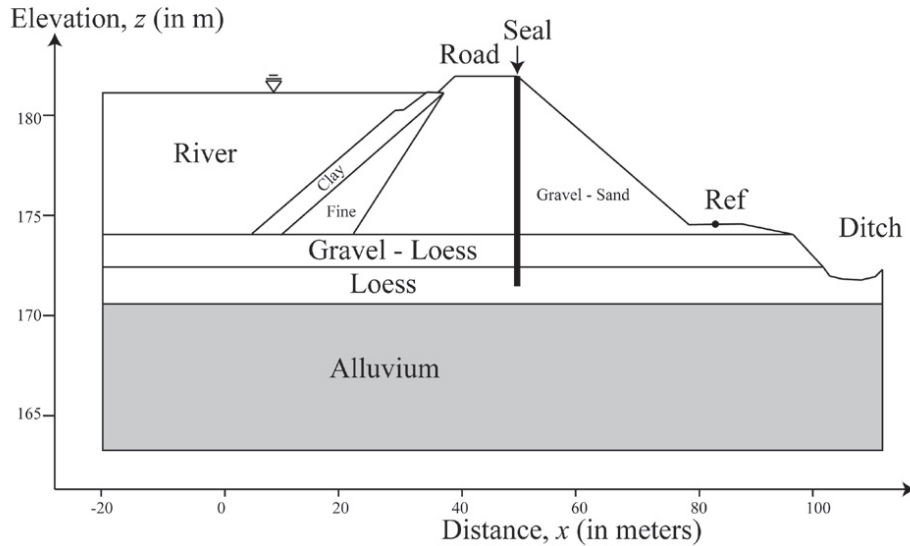

Physical property table

Materials	K_s (m s ⁻¹)	σ (S m ⁻¹)	\bar{Q}_v (C m ⁻³)
Loess	1.10^{-5}	3.10^{-3}	10
Gravel and loess	1.10^{-4}	$1.25.10^{-3}$	0.1
Gravel and sand	1.10^{-4}	$3.3.10^{-3}$	10
Silt	1.10^{-13}	$2.5.10^{-2}$	100
Cemented clay	1.10^{-18}	5.10^{-2}	1.10^6

- Low permeability zone
 - Cemented clay & silt
 - Seal
- High permeability zone
 - Gravels
- High electrical conductivity
 - Silt and clays
- High Q_v
 - Cemented clay

Survey

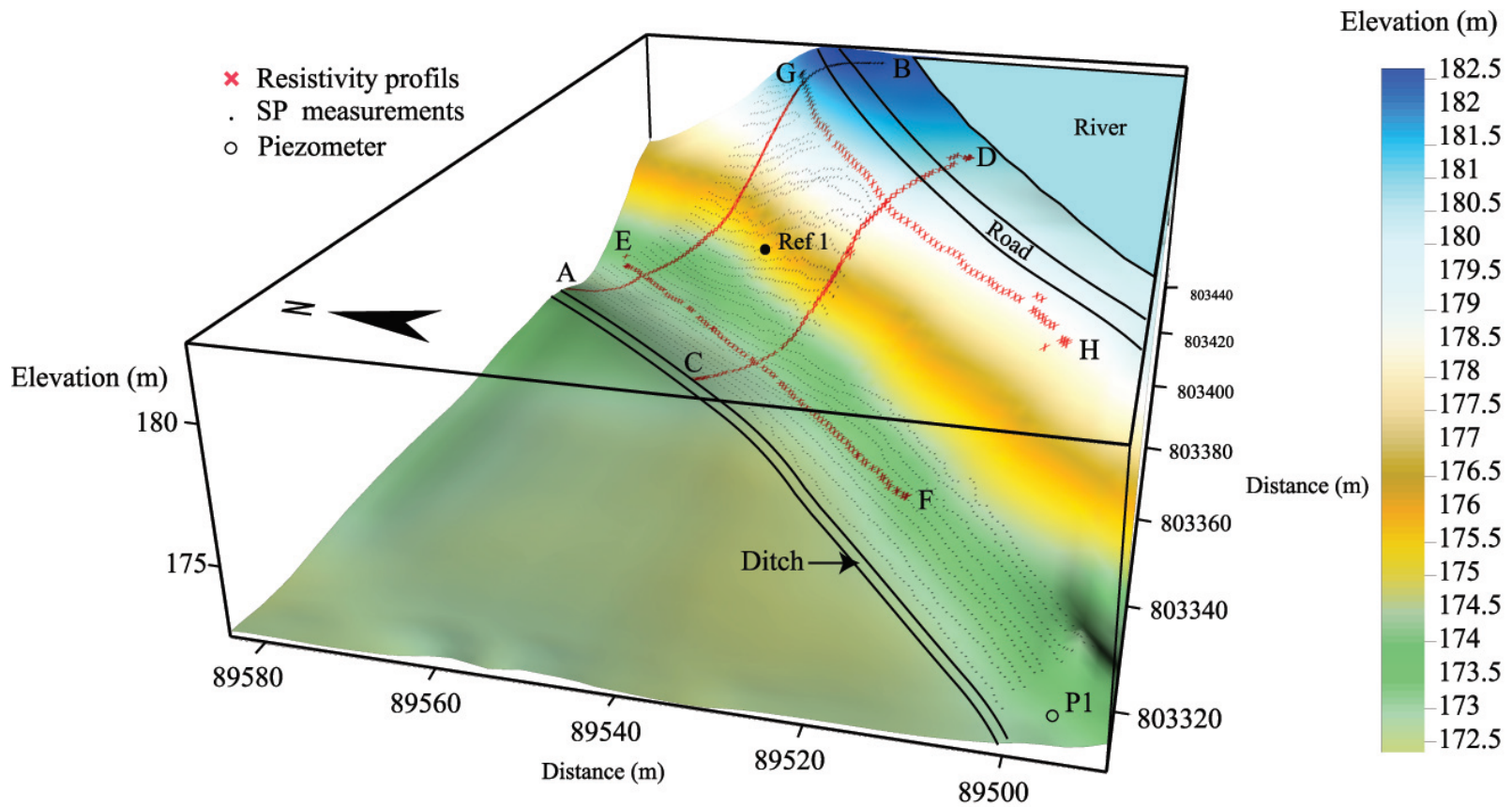

- DC survey

- 4 profile lines
- Wenner array

- SP survey (2 days)

- 2007/09/18: 1169 data
- 2007/09/19: 2076 data

Data

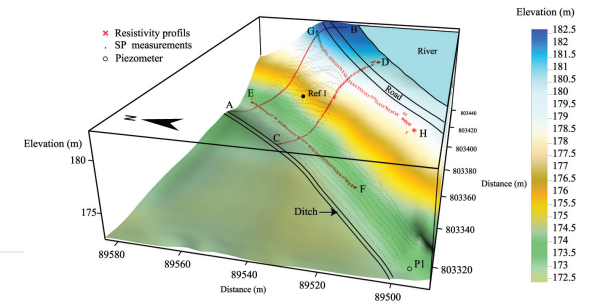

- SP maps on two different days

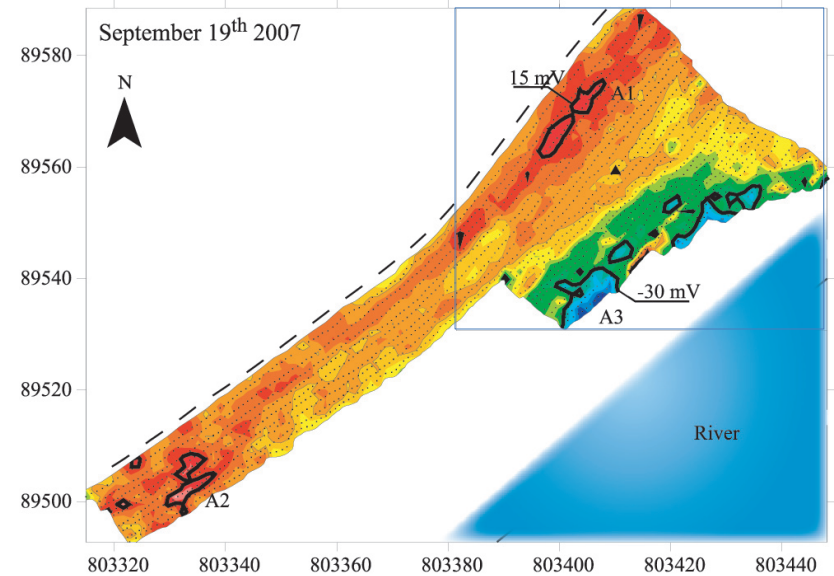
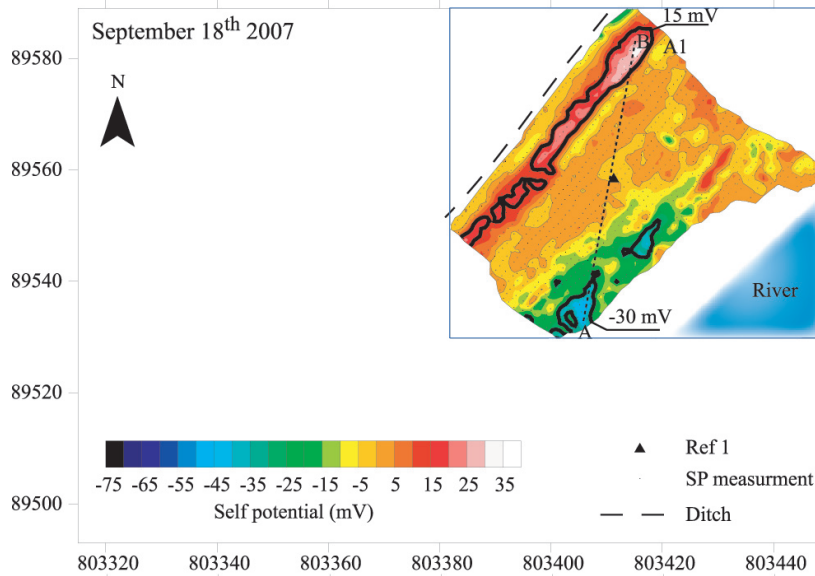

- A3 (riverside): negative SP anomalies
- A1 and A2 (near ditch): positive SP anomalies

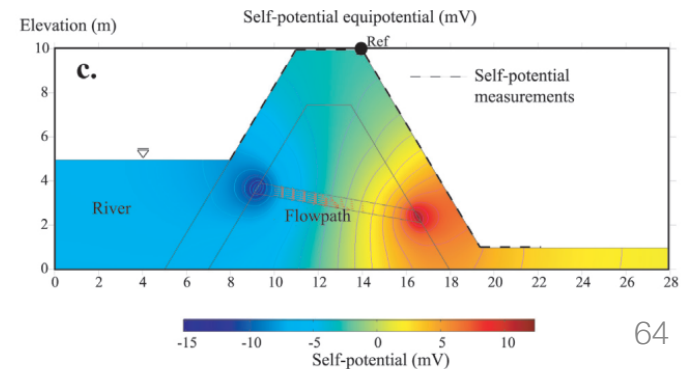

Processing

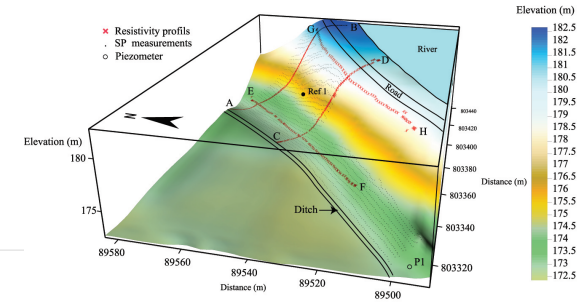

- SP maps on two different days

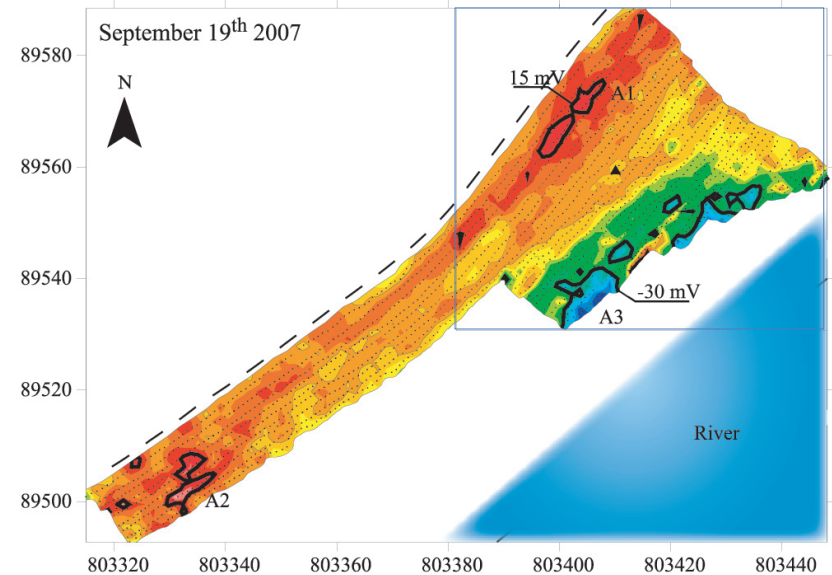
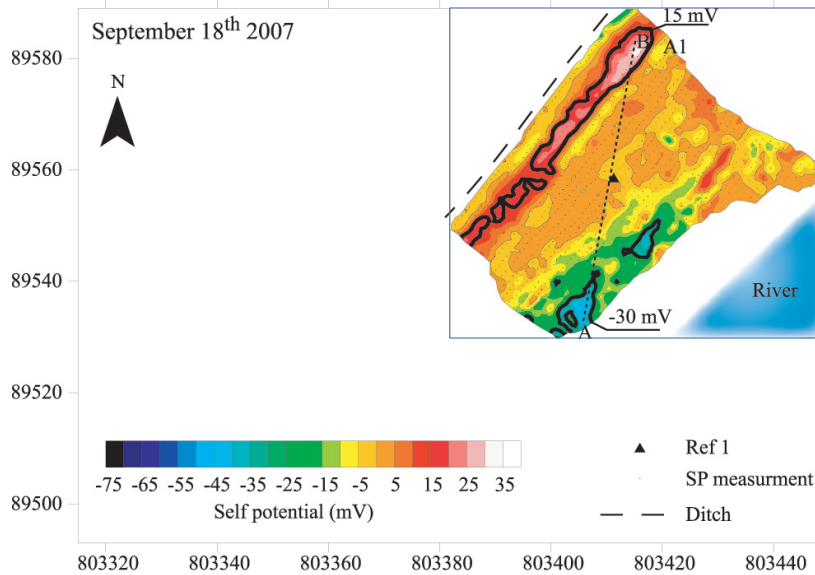

- Goal: recover streaming currents

$$\nabla \cdot \sigma \nabla \phi = \nabla \cdot \vec{j}_s$$

data → ϕ
streaming currents → \vec{j}_s
conductivity → σ

Obtain conductivity from DC ⁶⁵

Processing

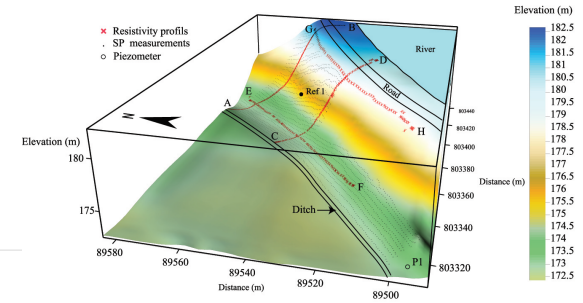

- Resistivity from DC Inversions

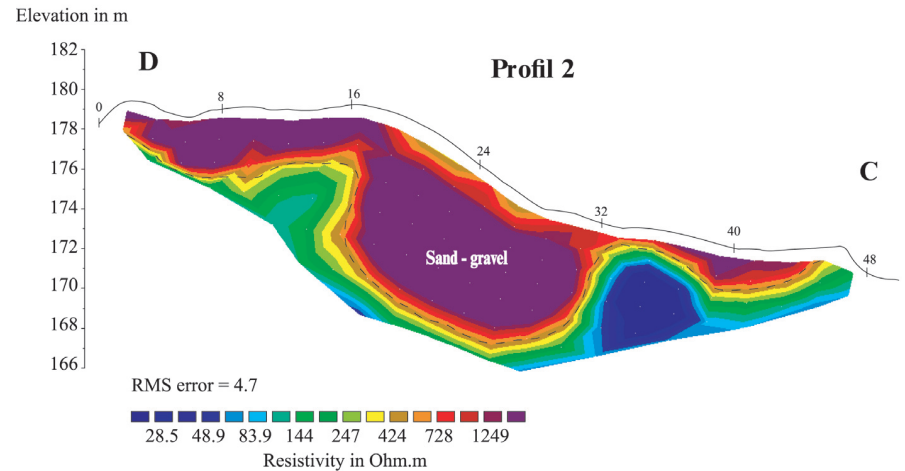
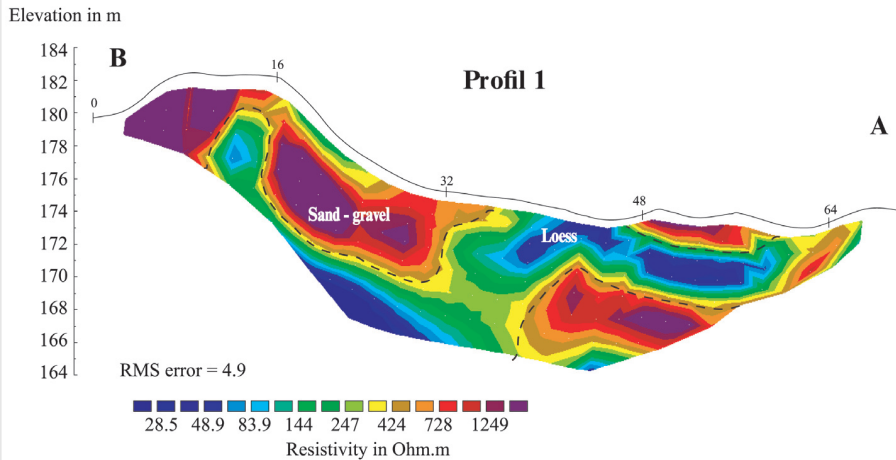

- Goal: recover streaming currents

$$\nabla \cdot \sigma \nabla \phi = \nabla \cdot \vec{j}_s$$

↑ data
↑ streaming currents
↑ conductivity

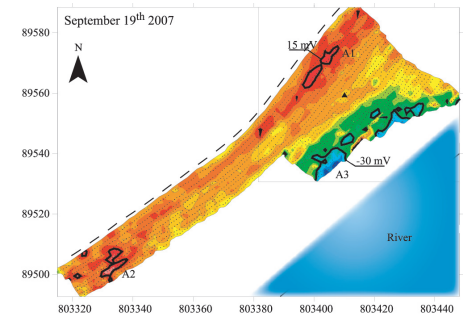

Invert SP data to recover \vec{j}_s

Processing and inversion

- Invert SP data to recover \vec{j}_s

$$\nabla \cdot \sigma \nabla \phi = \nabla \cdot \vec{j}_s$$

- \vec{j}_s is a vector
- Depth weighting ($\sim 1/z^3$) is used (similar to magnetic inversion)

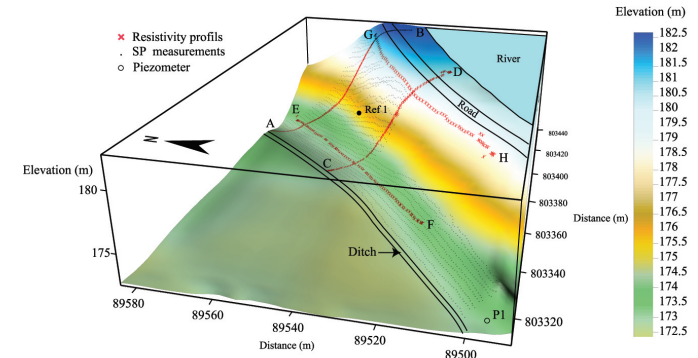

SP data

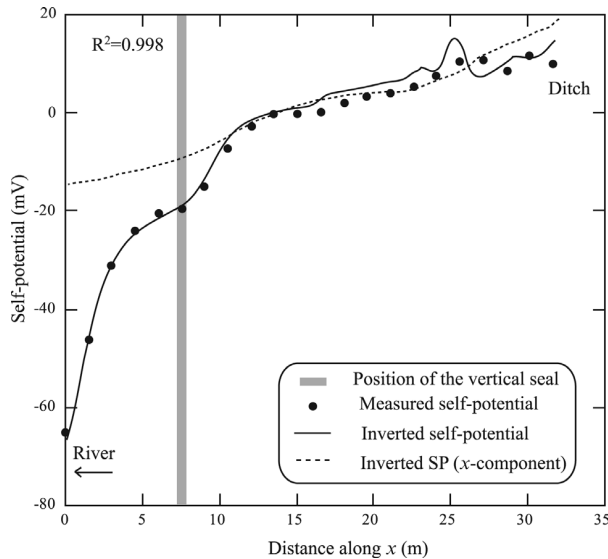

Recovered streaming current (magnitude) $|\vec{j}_s|$

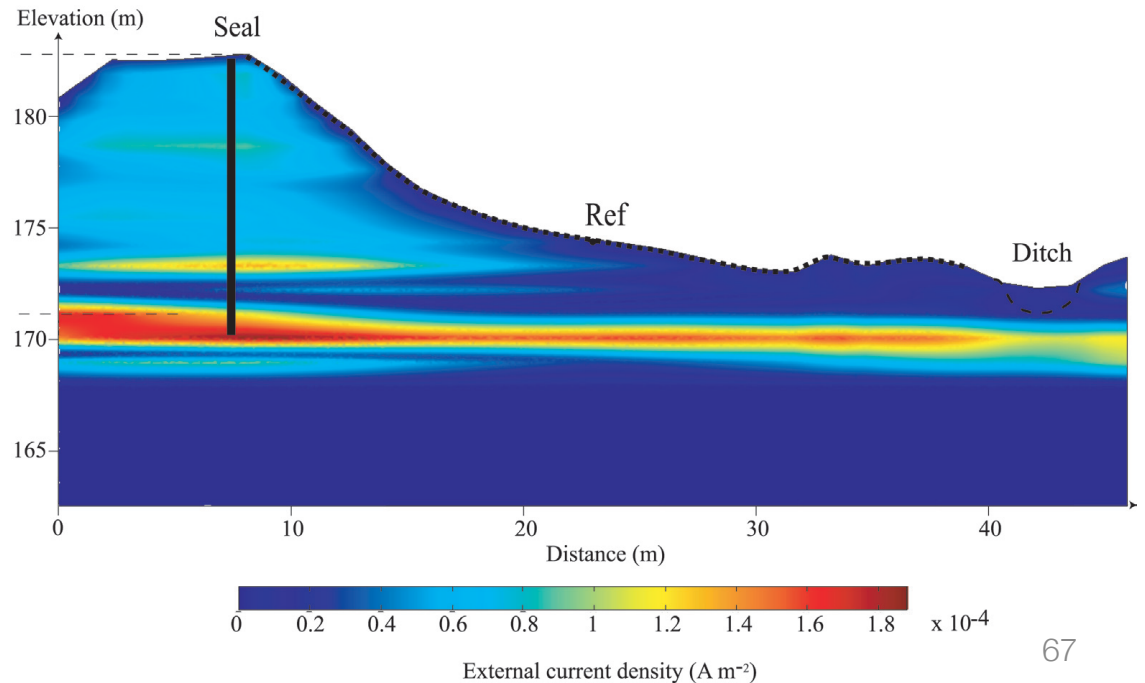

Processing and interpretation

How do we obtain seepage velocity, \vec{u} ?

$$\vec{u} = \frac{\vec{j}_s}{Q_v}$$

Recovered streaming current (magnitude) $|\vec{j}_s|$

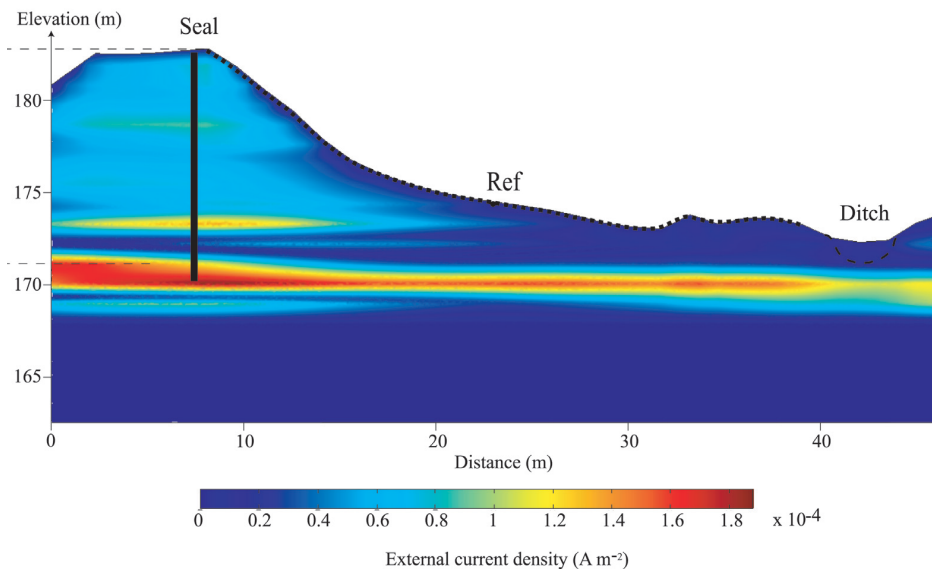

Q_v vs. k

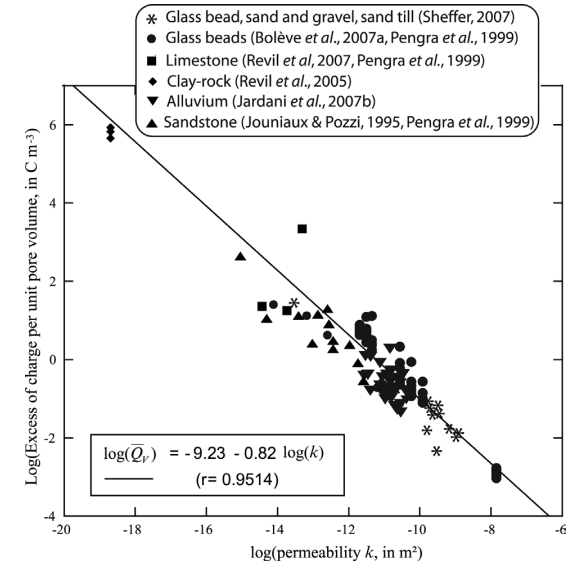

How do we get hydraulic permeability, k ?

Interpretation and Synthesis

How do we obtain seepage velocity, \vec{u} ?

$$\vec{u} = \frac{\vec{j}_s}{Q_v}$$

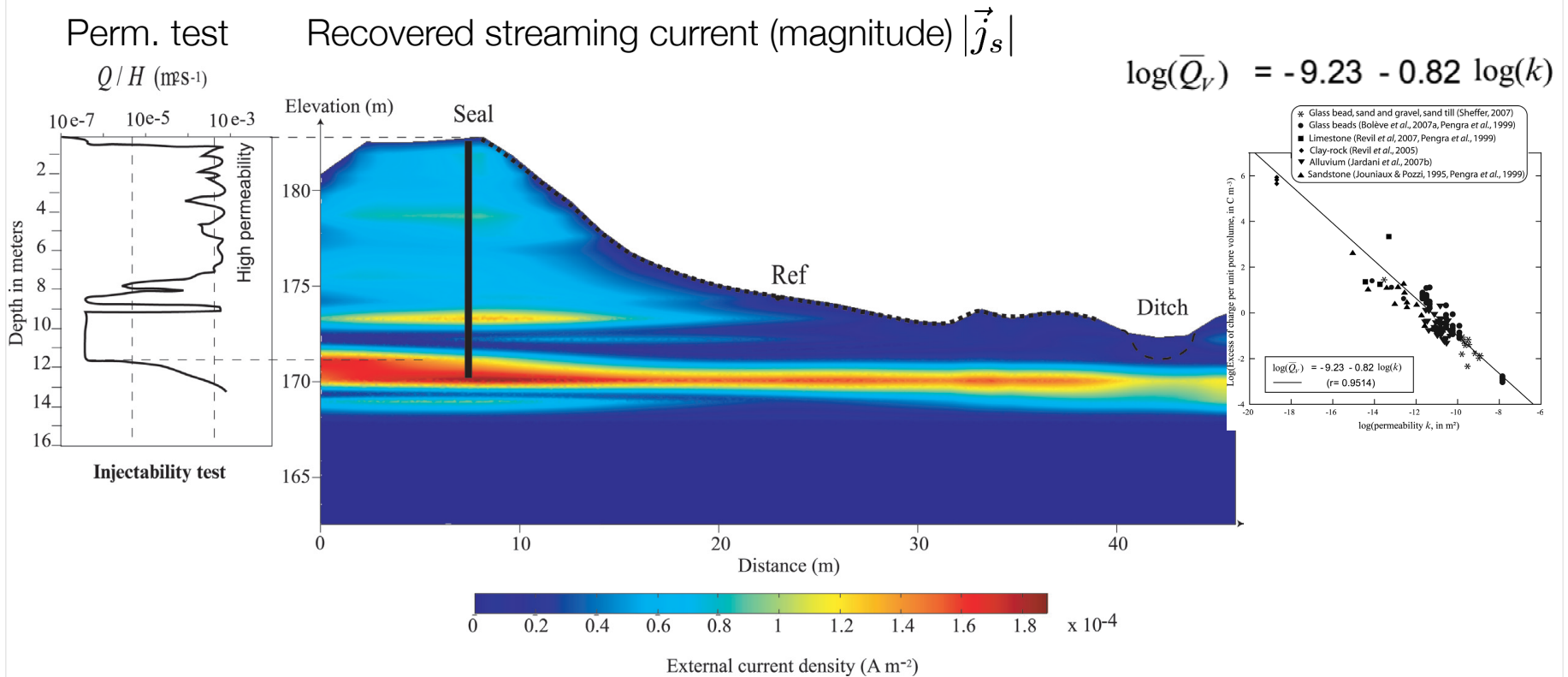

Fluid velocity: 3×10^{-3} m/s

Flow rate: 3 litres /s

Outline

- Basic experiment
- Currents, charges, potentials and apparent resistivities
- Soundings, profiles and arrays
- Data, pseudosections and inversion
- Sensitivity
- Survey Design
- DC app
- Case History – Mt Isa

- Effects of background resistivity

Effects of background resistivity

Resistivity models (thin resistive layer)

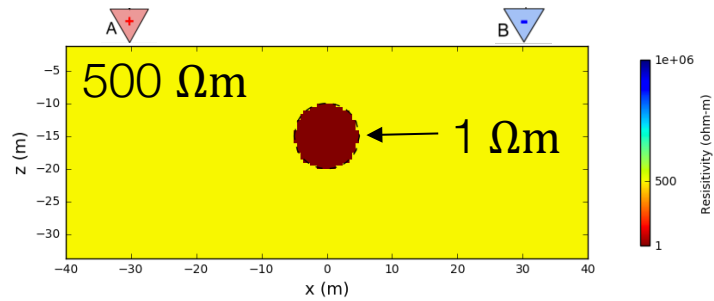

Currents and measured data at MN

$\rho_a = 430 \Omega\text{m}$

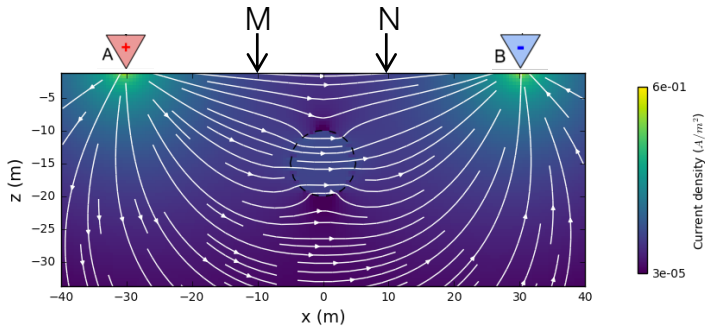

Effects of background resistivity

Resistivity models (thin resistive layer)

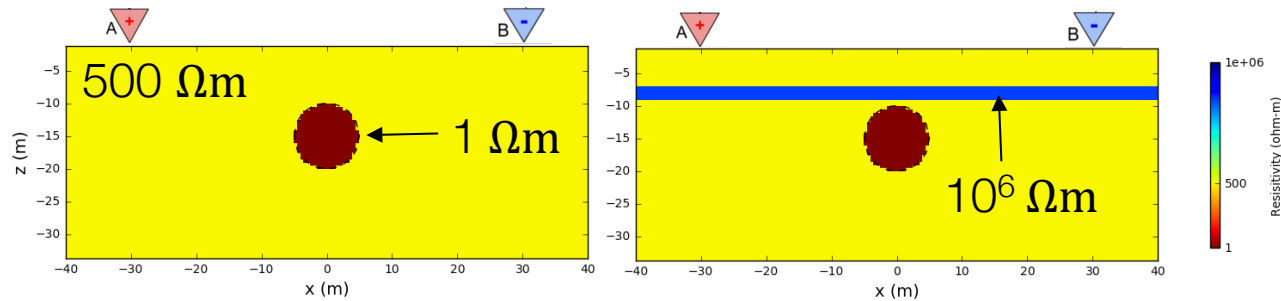

Currents and measured data at MN

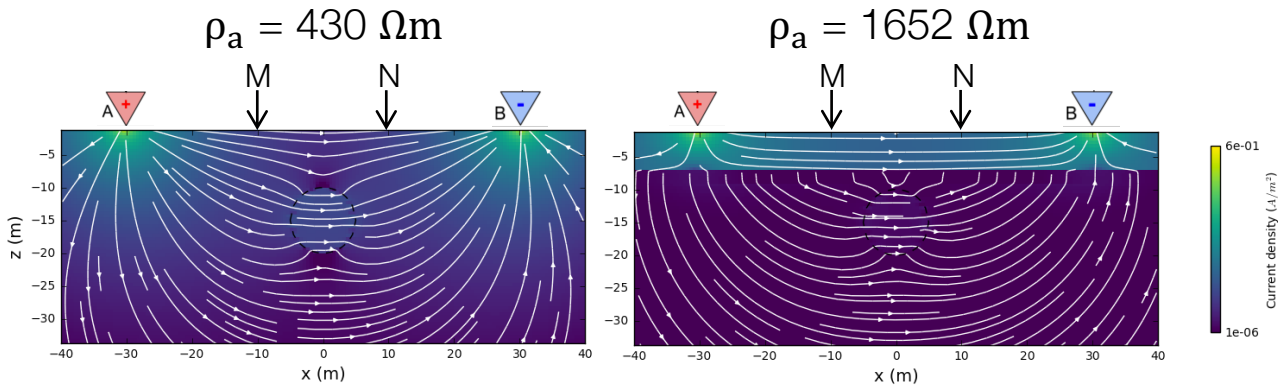

Effects of background resistivity

Resistivity models (thin resistive layer)

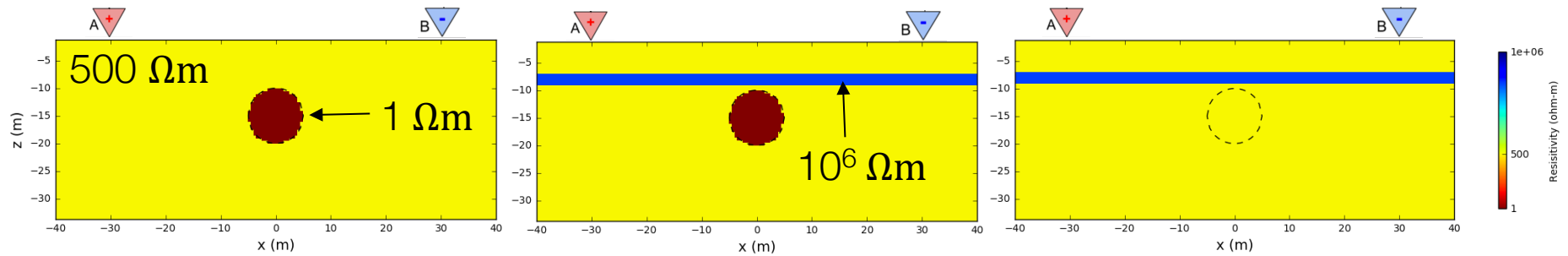

Currents and measured data at MN

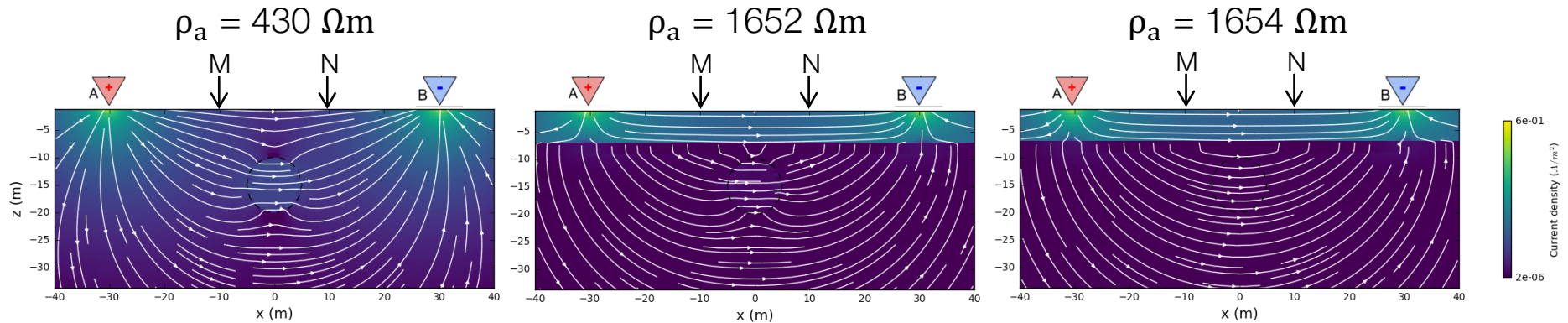

Effects of background resistivity

Resistivity models (thin conductive layer)

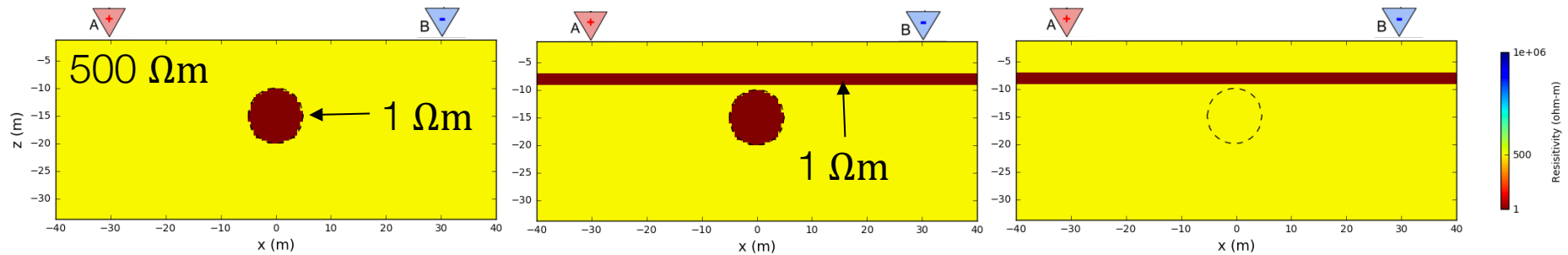

Currents and measured data at MN

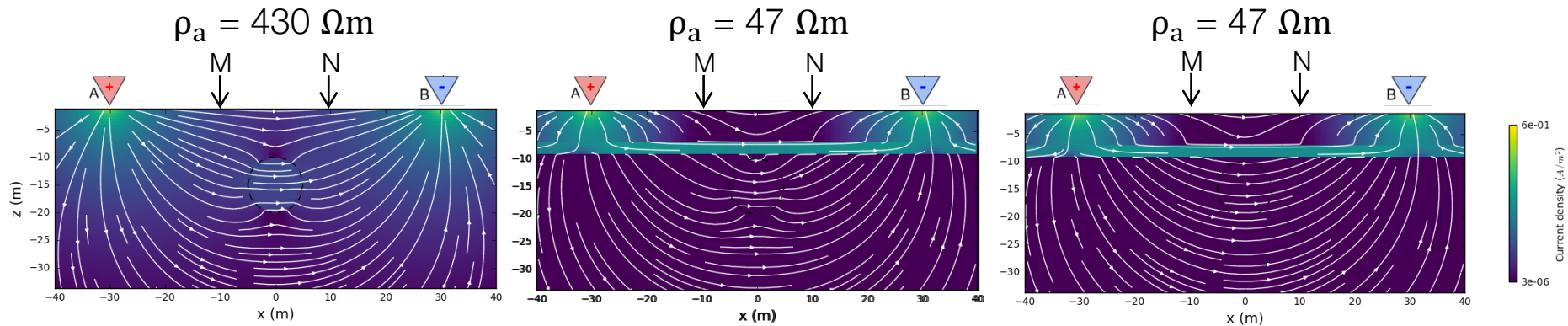

End of DCR

Next up



DC Resistivity



EM Fundamentals

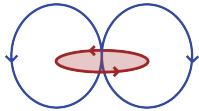

Inductive Sources

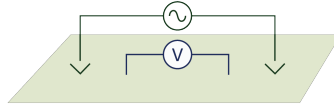

Grounded Sources



Natural Sources

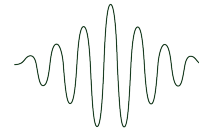

GPR

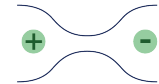

Induced Polarization



The Future

Lunch: Play with apps