

Ainm: _____

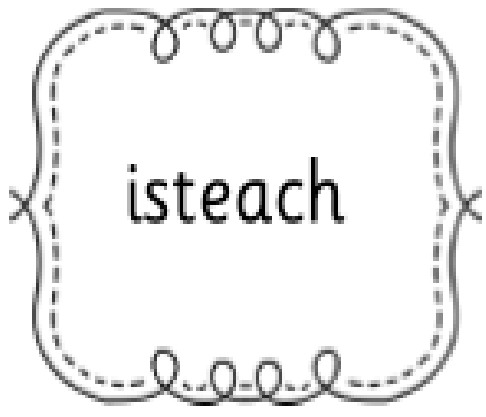
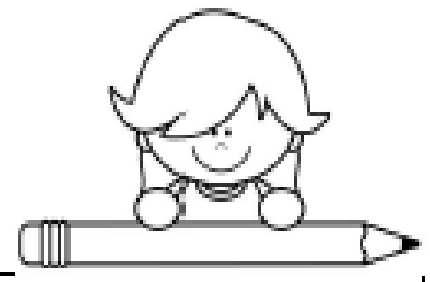

Scríobh é
i s t e a c h

Céard iad na litreacha atá in easnamh?

i _ t _ a c h	i _ t _ a _ h	_ s t _ a _ h
---------------	---------------	---------------

Clorclaigh an focal isteach

níl	isteach	chuaigh
isteach	isteach	liom

Chuaigh mé isteach sa teach.

Ainm: _____

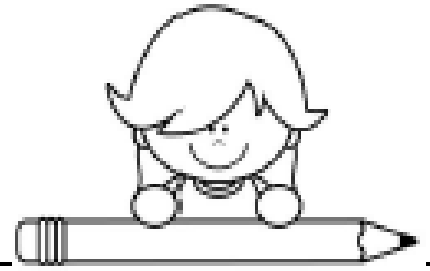

Scríobh é

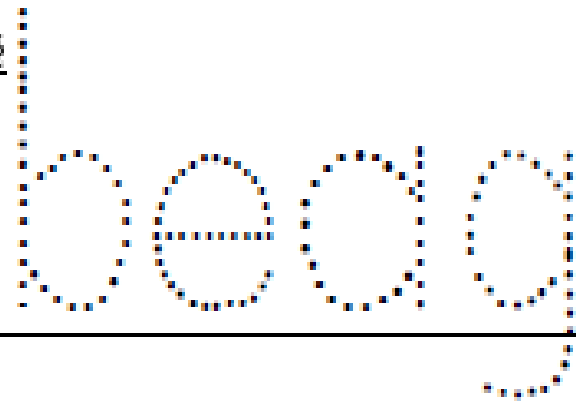

Cen litir atá in easnamh?

b _ ag	_ eag	be _ g
--------	-------	--------

Giorclaigh an focal beag.

beag	beag	liom
beag	liom	ní

Tá an cat beag.

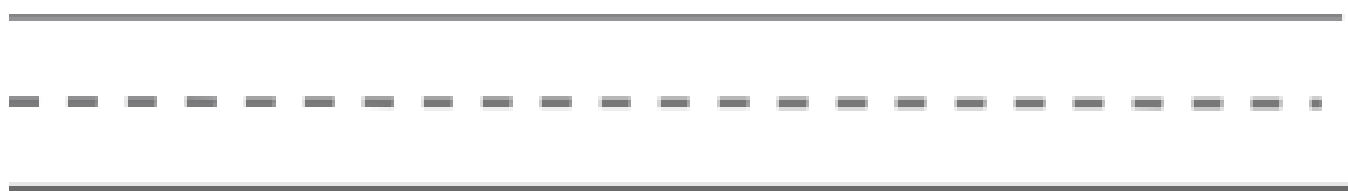

Ainm: _____

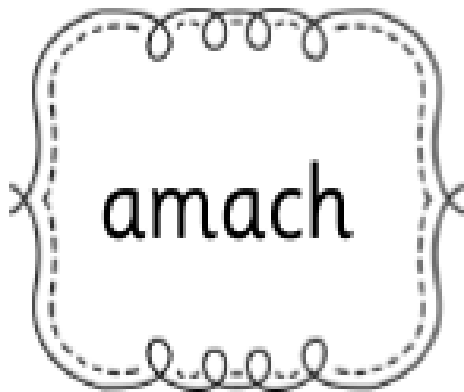
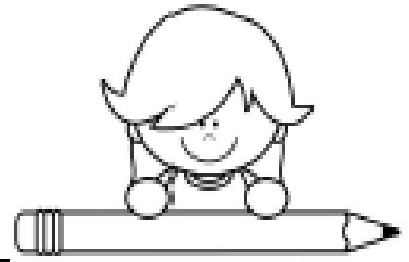

Scríobh é

a m a c h

Céard iad na litreacha atá in easnamh?

am__ch

_m_ch

a_a_h

Ciorclaigh an focal amach.

siad

le

amach

amach

amach

mamáí

Tá mé ag dul amach.

Ainm: _____

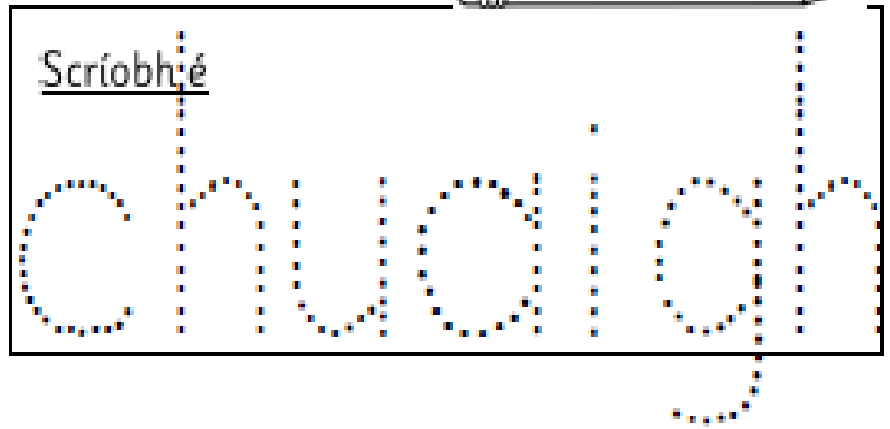
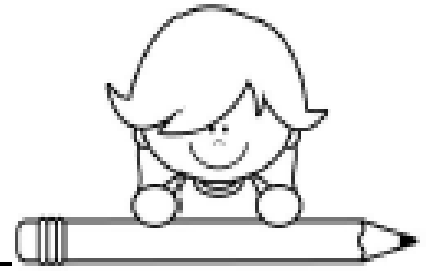

Cén litir atá in easnamh?

c _ u _ igh

c _ u _ i _ h

_ hu _ i _ h

Cloclaigh an focal chuaigh

chuaigh

na

chuaigh

go

daidí

chuaigh

Chuaigh mé ar scoil inné.

Cuardach Focal

s	f	c	h	e	p	m	s
g	l	t	u	d	o	a	e
o	i	s	i	a	d	i	o
r	i	t	h	i	n	t	m
i	o	m	m	d	h	h	u
s	f	d	é	í	g	n	a

An bhfuil tú ábalta na focail seo a fháil
sa Chuardach Focal thuas?

sí is siad mé seo
daidí go rith na maith

Focail Mheasctha–1

Tá na focail thíos measctha.

An dtig leat iad a oibriú amach? Tugtar an túsleitir duit.

bíh → b h í

ís → s _

disa → s _ _ _

eso → s _ _

og → g _

an → n _

si → i _

ém → m _

dídia → d _ _ _ _

thir → r _ _ _

tahim → m _ _ _ _

Meaitseáil na Focail

Focail
11–20

Meaitseáil gach focal thíos. Cuir ciorcal thart ar an fhreagra cheart. Tá an chéad cheann déanta duit.

bhi	→	bih	ibh	bhi	bbhi
sí	→	is	is	si	sí
siad	→	sdai	siaid	siad	said
seo	→	seo	soe	eas	soo
go	→	og	go	oog	óg
na	→	an	ná	na	ann
is	→	is	si	sí	is
mé	→	má	mí	ém	mé
daidi	→	dodai	daidi	daida	ddaí
rith	→	rthi	rith	rrith	rith
maith	→	mathi	mthia	mthai	maith

Focail in Abairtí

sí	siad	seo	go	na
is	mé	daidí	rith	maith

Léigh gach focal atá sa bhosca thuas agus ansin cuir gach ceann in abairt.

1. (sí)

.....

2. (siad)

.....

3. (seo)

.....

4. (go)

.....

5. (na)

.....

6. (is)

.....

7. (mé)

.....

8. (daidí)

.....

9. (rith)

.....

10. (maith)

.....

Ciorclaigh na focail a thosaíonn le "c"

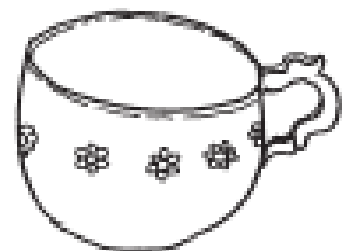
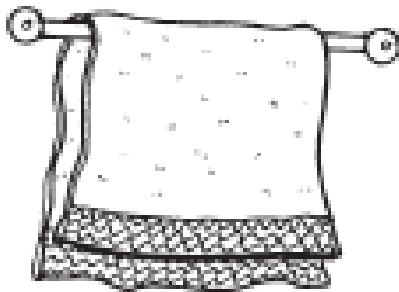
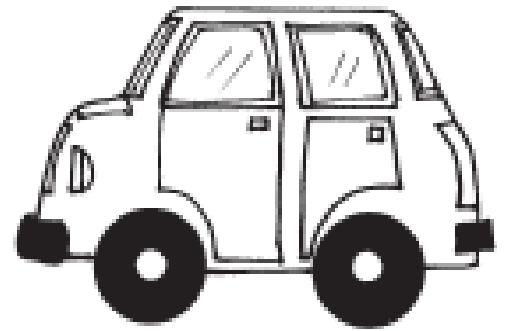
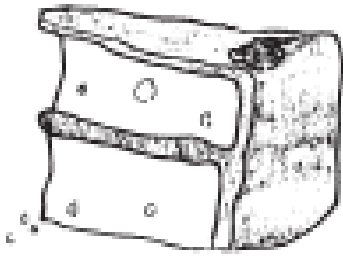

Ciorclaigh na focail a thosaíonn le "g"

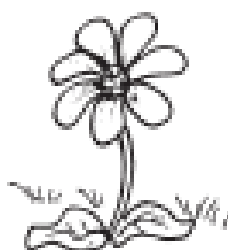
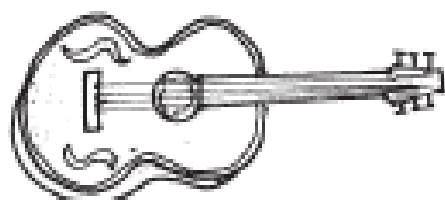
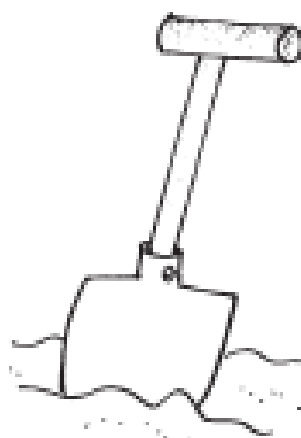
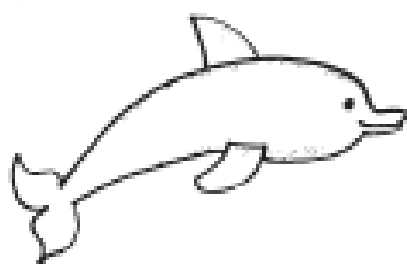
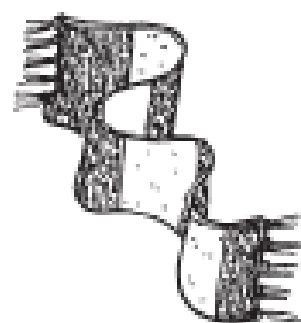
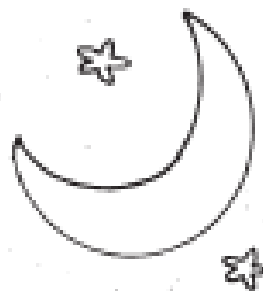
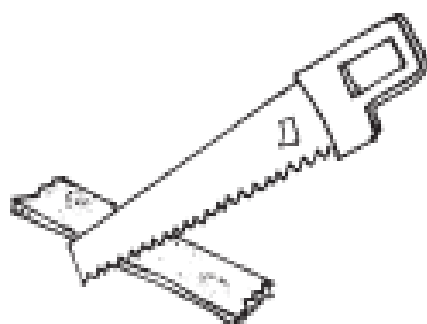
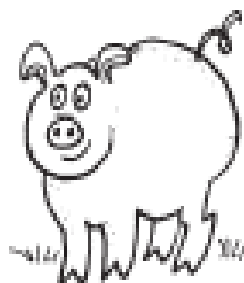
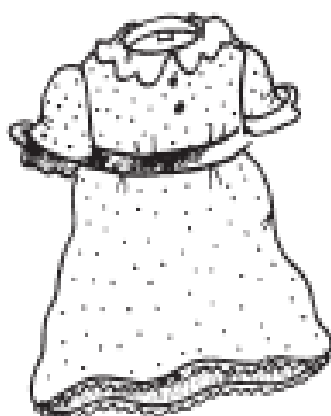

Ciorclaigh na focail a thosaíonn le "l"

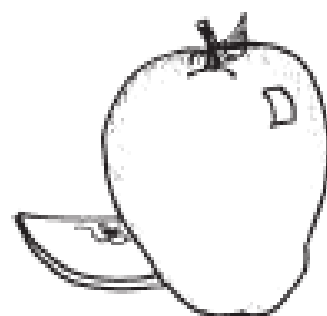
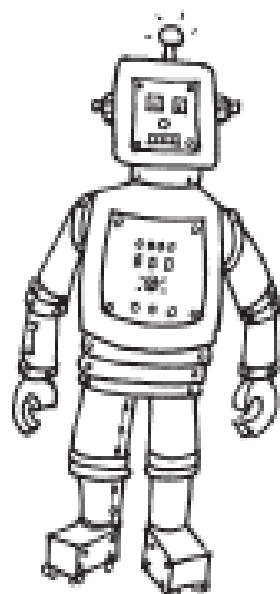
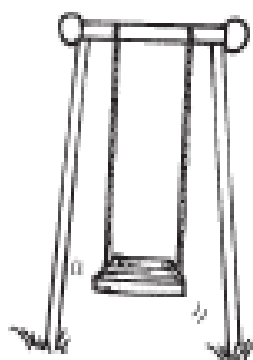
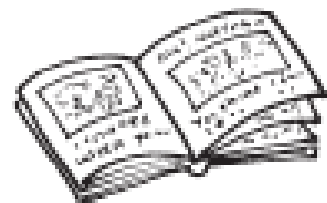
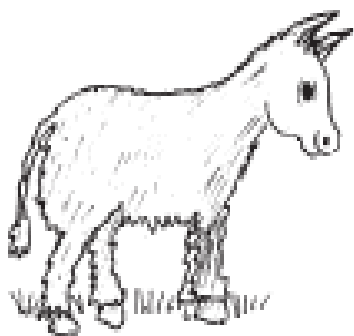
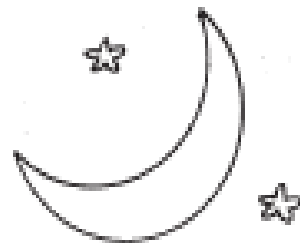
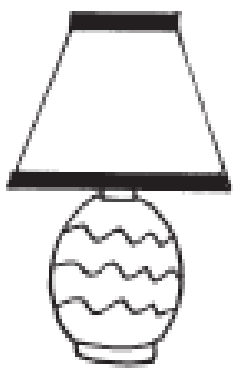

Answers- Circle the words that begin with "c"

císte	cake
stoca	sock
carr	car
tuáille	towel
hata	hat
bábóg	doll
capall	horse
piotsa	pizza
Cupán	cup
Fainne	ring
Tarracóir	tractor
Cáis	Cheese

Answers- Circle the words that begin with "g"

gúna	dress
muc	pig
cat	cat
gearr	cut
gealach	moon
scairf	scarf
deilf	dolphin
spád	spade
geansaí	jumper
giotár	guitar
bláth	flower
gabhar	goat

Answers- Circle the words that begin with "l"

lampa	lamp
lón	lunch
ubh	egg
lacha	duck
gealach	moon
asal	donkey
bróga	shoes
liathróid	ball
luascán	swing
róbó	robot
úll	apple

A	c	a	e	h
B	v	n	b	l
C	a	w	e	c
D	d	l	t	i
E	b	m	x	e
F	e	o	f	p
G	h	g	r	s
H	v	a	h	r
I	c	a	i	p
J	t	y	o	j
K		x	d	u
L	o	l	a	t
M	b	m	n	w

N	u	j	m	n
O	h	g	o	s
P	p	t	r	h
Q	q	a	t	p
R	w	r	u	x
S	s	t	r	a
T	g	l	q	t
U	t	u	k	f
V	u	j	v	y
W	x	p	o	w
X	y	x	r	h
Y	w	p	t	y
Z	z	r	u	x