



Geometry

My name _____

A vertical white bar containing a line for the student's name and two decorative icons at the bottom: a blue arrow pointing right and a blue semi-circle.

Copyright © 2009 3P Learning. All rights reserved.

First edition printed 2009 in Australia.

A catalogue record for this book is available from 3P Learning Ltd.

ISBN 978-1-921860-02-7

Ownership of content The materials in this resource, including without limitation all information, text, graphics, advertisements, names, logos and trade marks (Content) are protected by copyright, trade mark and other intellectual property laws unless expressly indicated otherwise.

You must not modify, copy, reproduce, republish or distribute this Content in any way except as expressly provided for in these General Conditions or with our express prior written consent.

Copyright Copyright in this resource is owned or licensed by us. Other than for the purposes of, and subject to the conditions prescribed under, the Copyright Act 1968 (Cth) and similar legislation which applies in your location, and except as expressly authorised by these General Conditions, you may not in any form or by any means: adapt, reproduce, store, distribute, print, display, perform, publish or create derivative works from any part of this resource; or commercialise any information, products or services obtained from any part of this resource.

Where copyright legislation in a location includes a remunerated scheme to permit educational institutions to copy or print any part of the resource, we will claim for remuneration under that scheme where worksheets are printed or photocopied by teachers for use by students, and where teachers direct students to print or photocopy worksheets for use by students at school. A worksheet is a page of learning, designed for a student to write on using an ink pen or pencil. This may lead to an increase in the fees for educational institutions to participate in the relevant scheme.

Published 3P Learning Ltd

For more copies of this book, contact us at: www.3plearning.com/contact

Designed 3P Learning Ltd

Although every precaution has been taken in the preparation of this book, the publisher and authors assume no responsibility for errors or omissions. Neither is any liability assumed for damages resulting from the use of this information contained herein.

Series A – Geometry

Contents

Topic 1 – 2D space (pp. 1–14)

Date completed

- lines and curves _____
- closed shapes, open lines _____
- matching shapes with everyday objects _____
- circles _____
- squares _____
- rectangles _____
- triangles _____
- properties _____
- explore _____

Topic 2 – 3D space (pp. 15–22)

- language _____
- everyday objects _____
- explore _____

Topic 3 – Position (pp. 23–28)

- language _____
- directions _____

Series Author:

Rachel Flenley

2D space – lines and curves

These are **straight lines**.

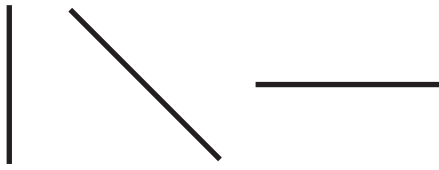

These are **curves**.





- 1  Draw 5 different straight lines. Draw 5 different curves.

straight lines

curves

- 2  Trace over the **straight lines** in red. Trace over the **curves** in green.



- 3   On a big piece of paper draw 3 straight lines and 3 curves. Swap your paper with a partner's and draw more lines and curves to turn them into pictures.

2D space – closed shapes, open lines

Shapes are **closed**. Their lines **always** join up.

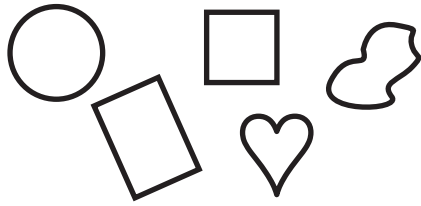

These **are** shapes.



These **are not** shapes.
They are just lines.

1  Colour the **shapes**. Trace over the **lines**.

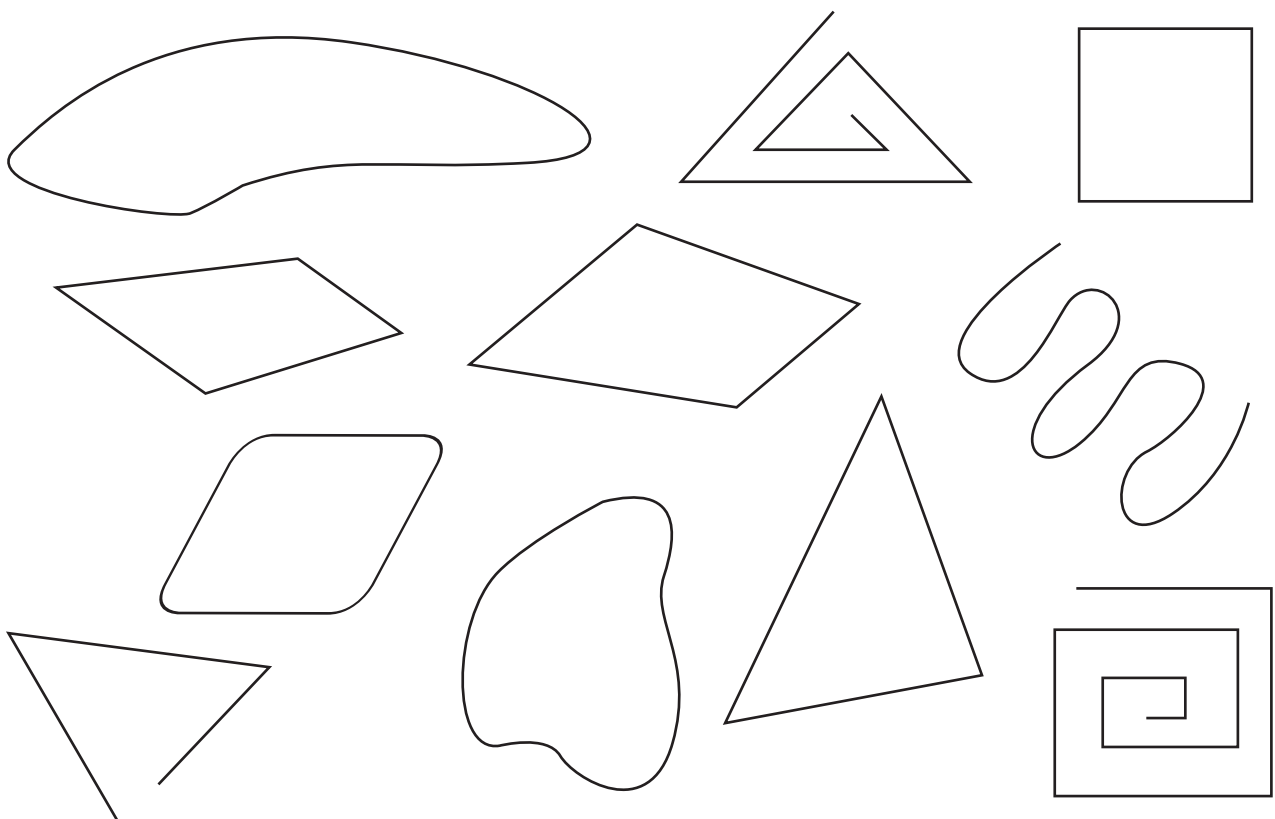

2   Draw either a line or a shape for your partner.



Ask your partner, 'Line or shape?'











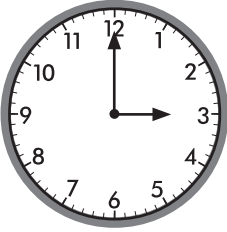
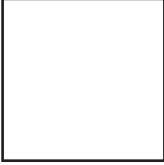
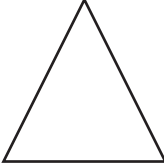
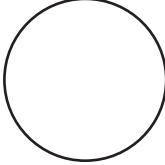

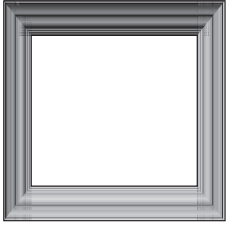
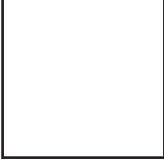
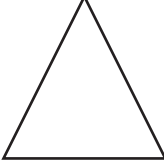
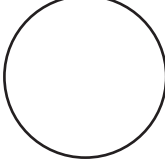
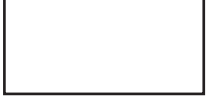

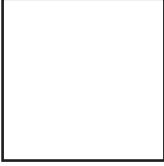
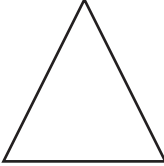
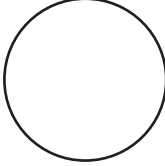
Give them a counter if they are right.

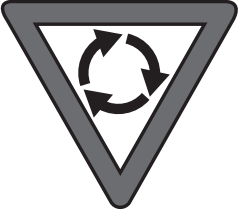
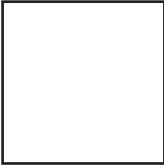
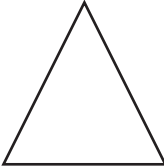
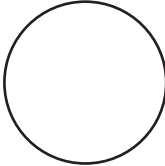
Swap.

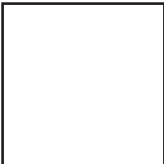
Play until you both have 5 counters.

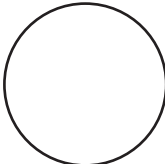
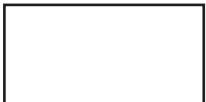
2D space – matching shapes with everyday objects

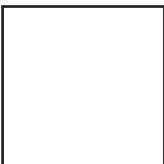
1  Colour the matching shape.

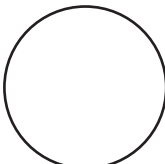
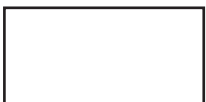

2D space – circles

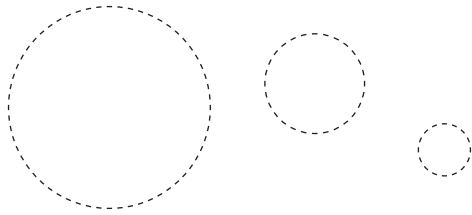

1    Say, trace and draw.

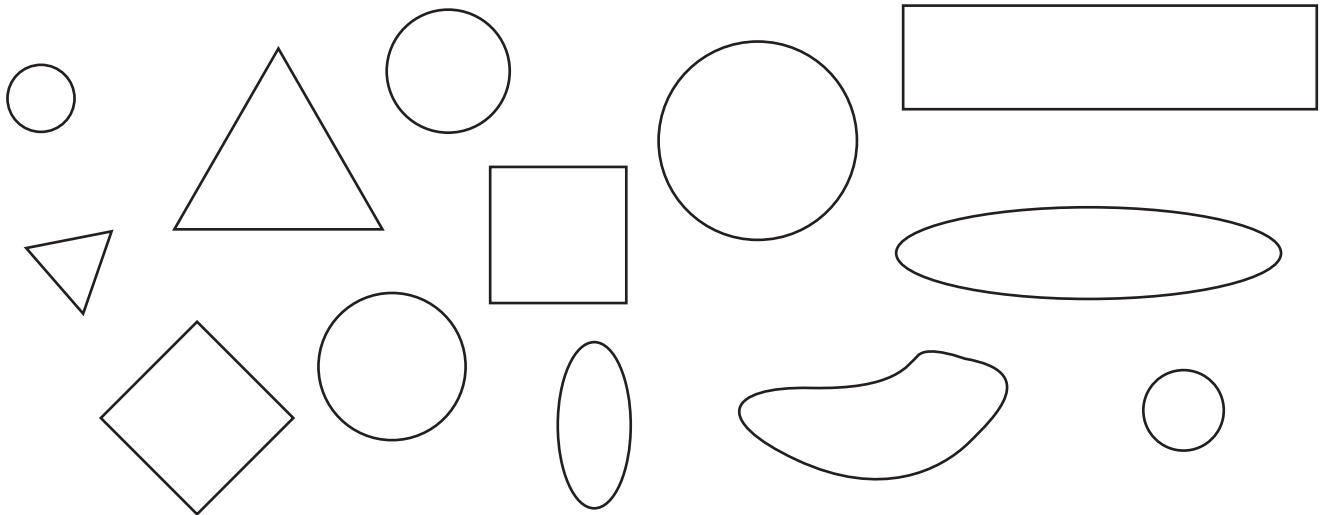

circle

2  Colour all the circles red.



3    Go on a circle hunt with a partner. Every time you find a circle, draw it below.

We found circles on our circle hunt.

2D space – squares

- 1    Say, trace and draw.

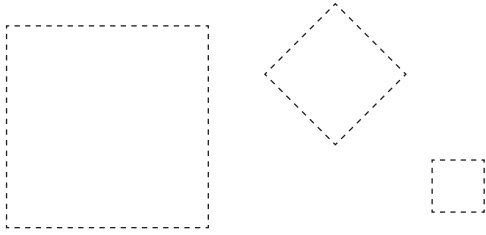

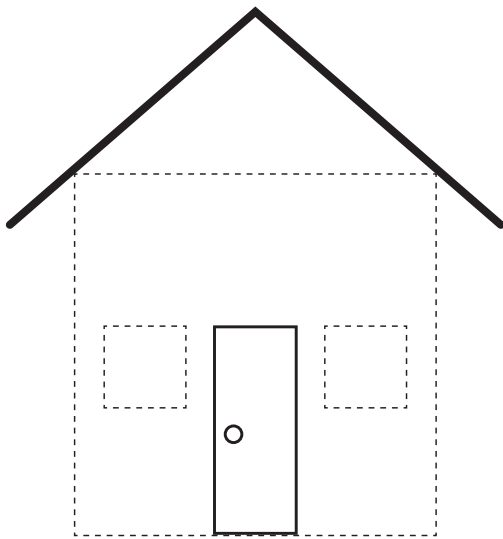

square

- 2  Trace over the squares.



Draw a bear made of squares.

- 3   Look at the black square.
We have put squares around it to make a bigger square.

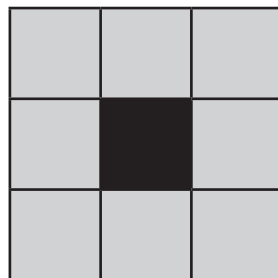

Make this yourself using square blocks.
Now, can you make it bigger again? Can you keep going?
How big can you make your square?

2D space – rectangles



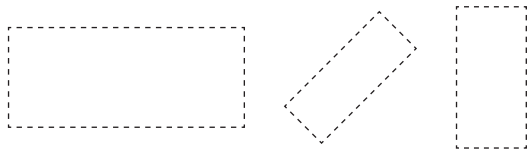

1    Say, trace and draw.

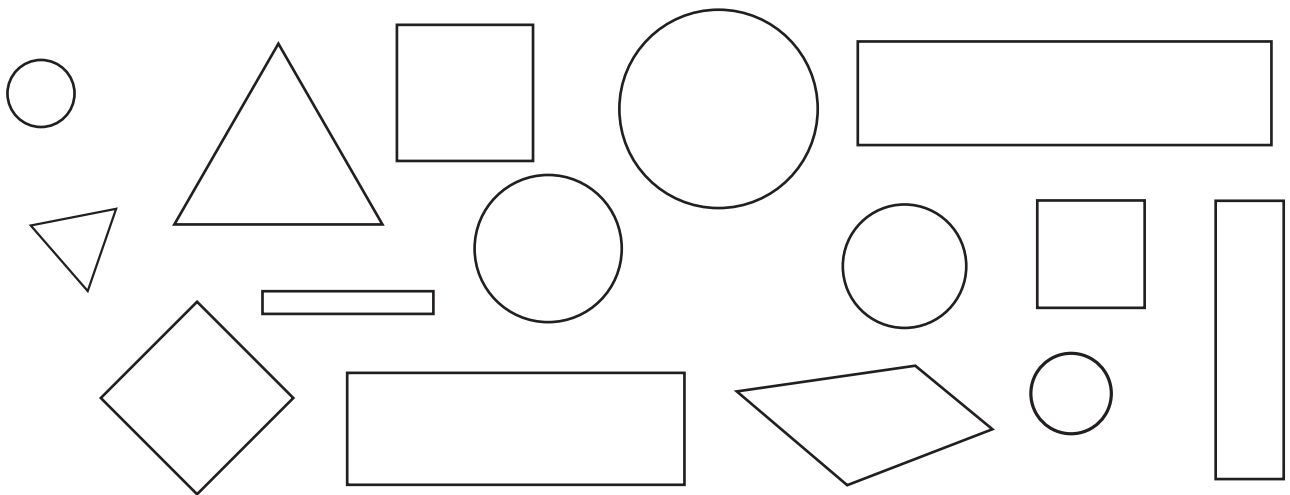

rectangle

2  Colour all the rectangles green.



3   Cut out your rectangular brick below. Write your name on it and decorate it with rectangles. Build a class wall with all the bricks. How many bricks are in your wall? What shape is your wall?



2D space – triangles

1    Say, trace and draw.

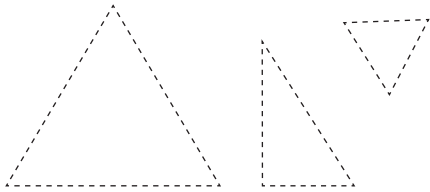

triangle

2  Loop all the triangles.

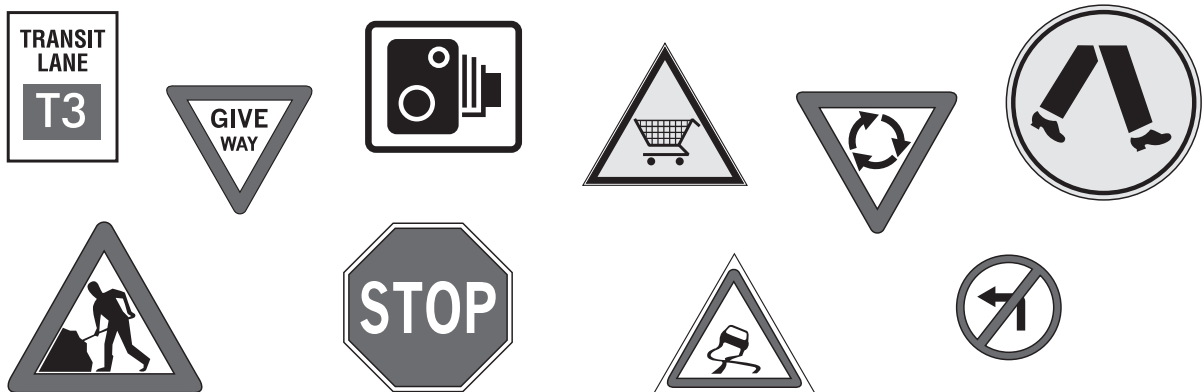

3  Draw a triangle below and turn it into your own sign.
Share your sign with your class.

2D space – properties

All shapes have sides.
Some shapes have corners as well.

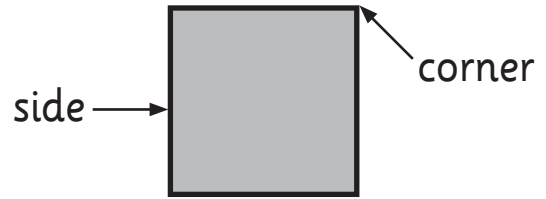

You will need:  attribute blocks

What to do:

Find these blocks.

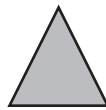
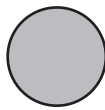
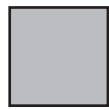

Count how many sides and corners on each shape. Record them.

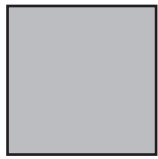

A **square** has sides and corners.

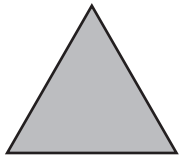

A **triangle** has sides and corners.

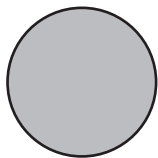

A **circle** has sides and corners.







A **rectangle** has sides and corners.

2D space – explore

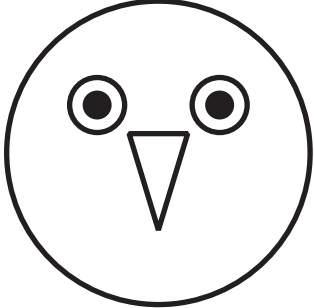
1  What shapes can you see? Colour them.





I can see



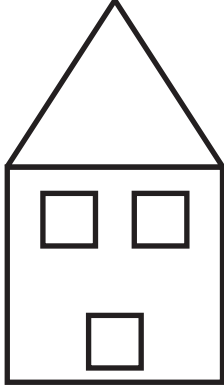







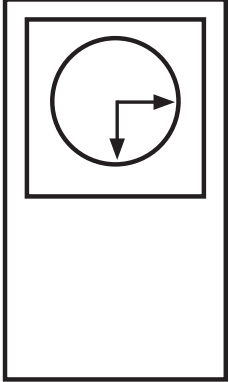

I can see











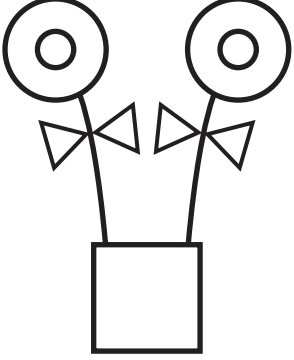

I can see









I can see



2   Draw your own shape picture using    .
Swap with a partner and colour the shapes you can see in their picture.

I can see







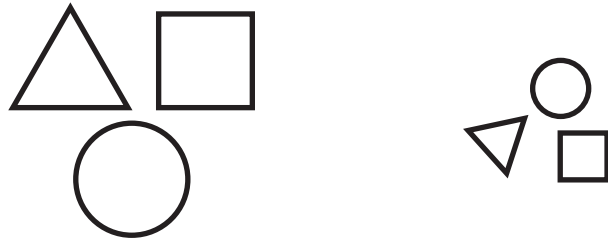

2D space – explore

How have we sorted these shapes?



Can you think of another way we could sort them?

You will need:



a partner



attribute blocks

What to do:

Take turns sorting the blocks.

Ask your partner to tell you how they think you sorted the blocks.

Are they right?

Swap jobs.

I think you put all the shapes with straight sides here, and all the shapes with curved sides there.

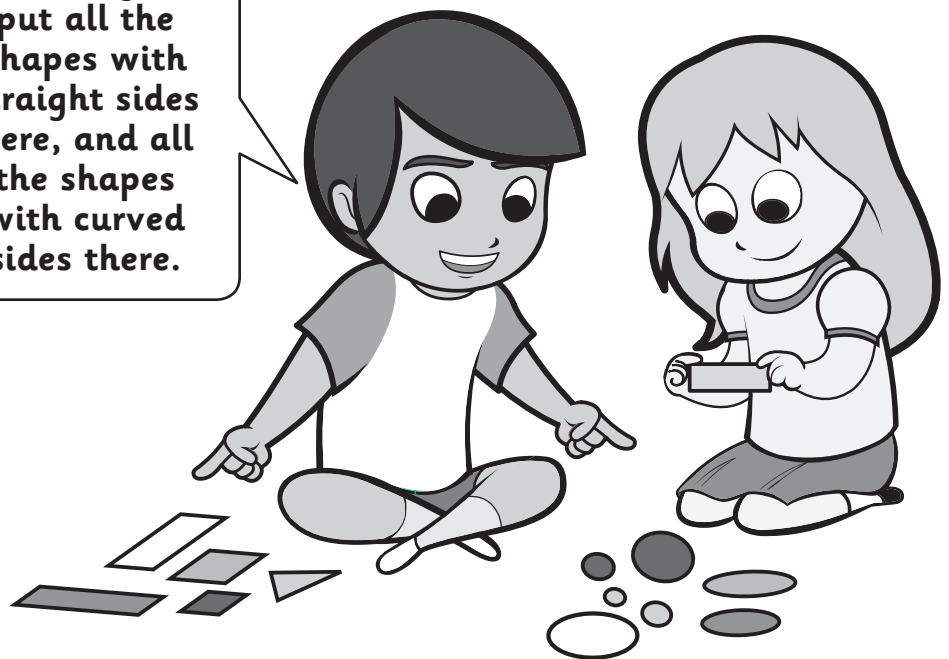



What to do next:

Sort them another way.

2D space – explore

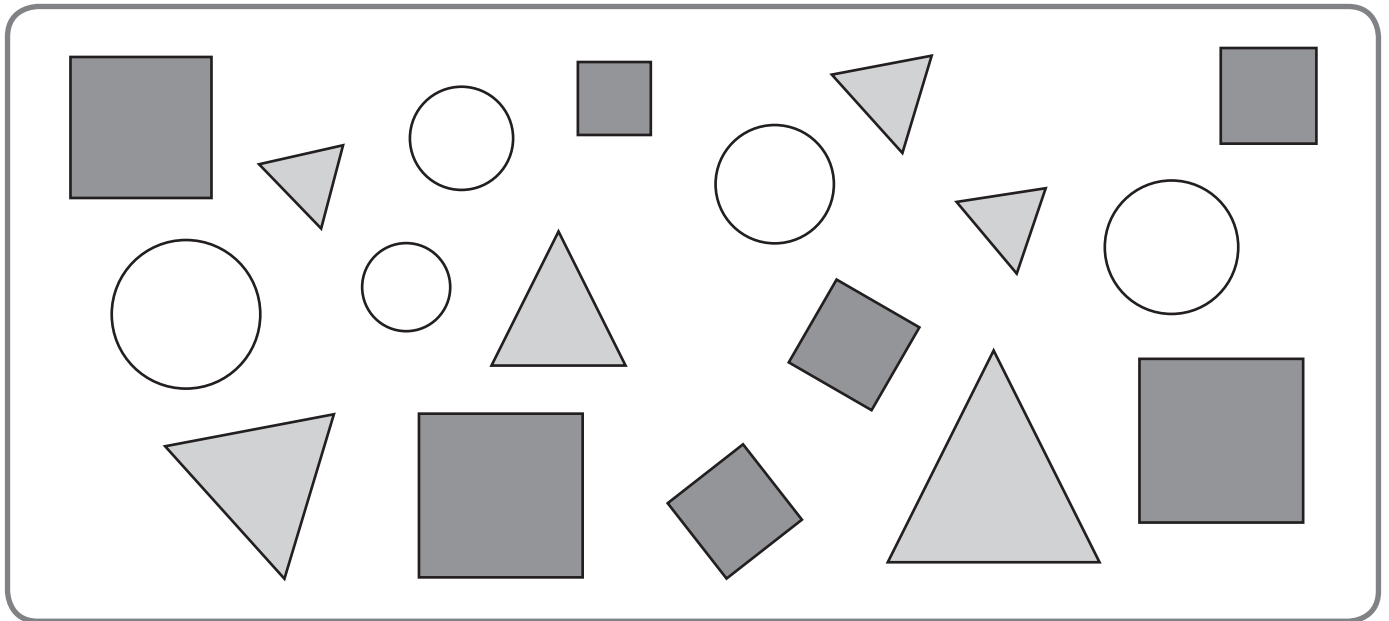
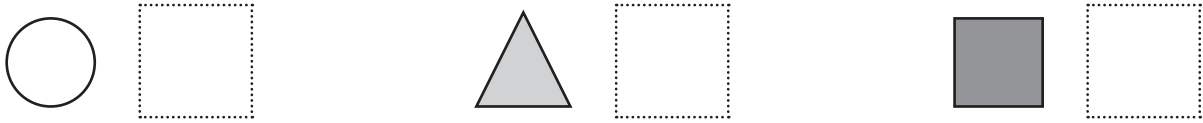
1  How many of each shape are there?



2   Draw some more circles, squares and triangles in the box below. Ask a partner to write **t** in the triangles, **c** in the circles and **s** in the squares.



2D space – explore

You will need:  attribute blocks

What to do:

Look at the picture. Count how many of each shape.

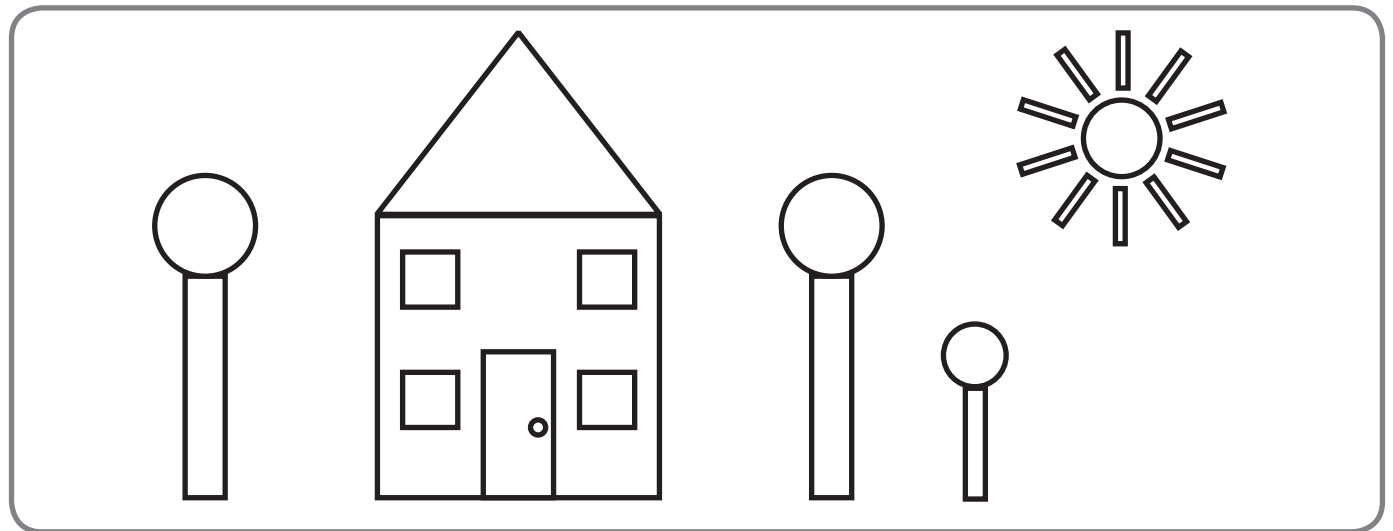

What to do next:

Create your own picture using attribute blocks.
Count and record how many of each block you used.

I used ...

2D space – explore

You will need:  a partner  scissors



What to do:

Cut out the shape cards. Combine your cards with your partner's cards and turn them face down.

Take turns turning over 2 cards. If the shapes match, you keep them. It is OK if they are different sizes or in different positions.

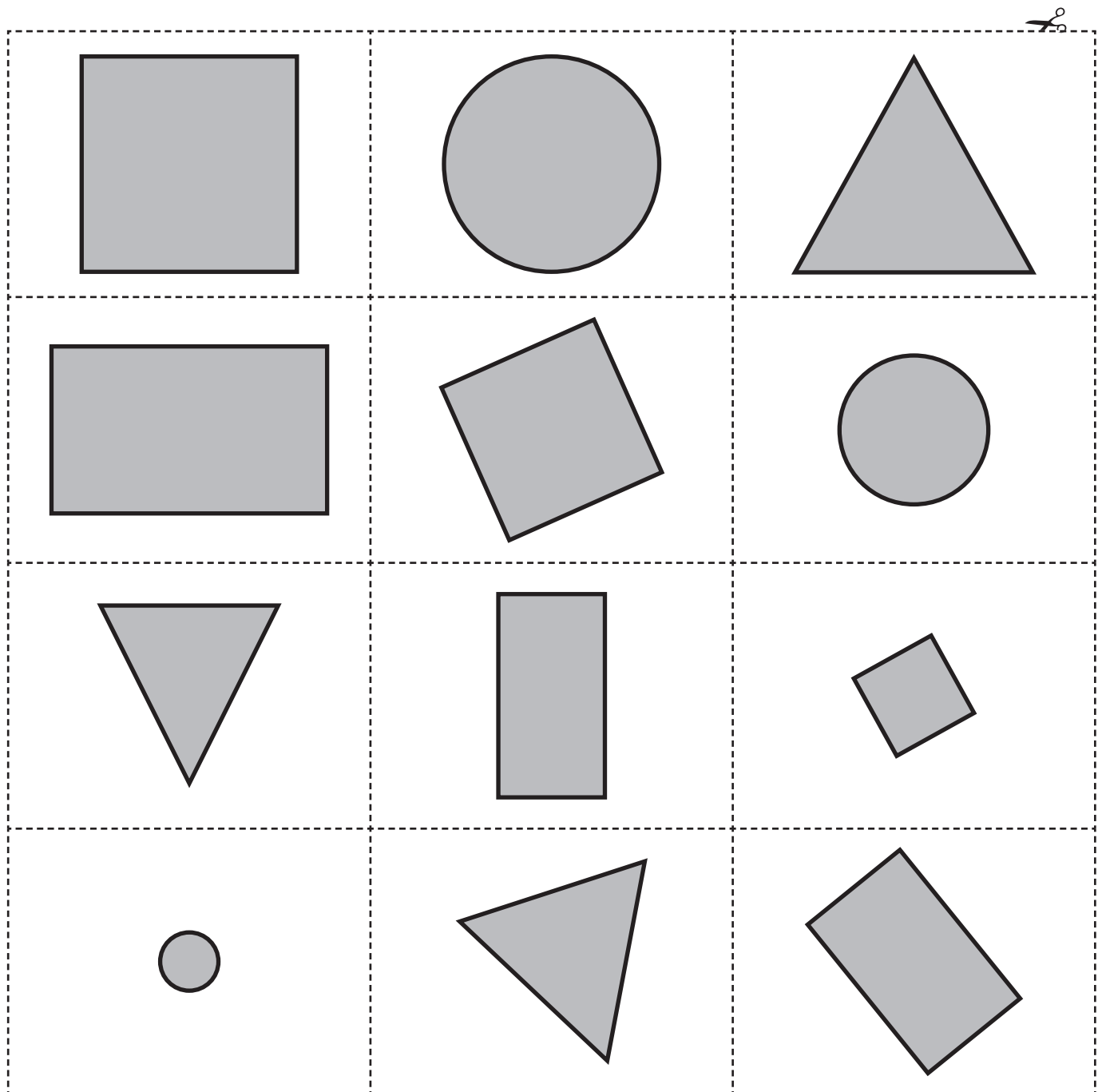

2D space – explore

You will need:  2 paper squares in different colours  glue stick

What to do:

Ask your teacher to make 5 cm cuts in one square like this and to cut the other square into 5 cm strips.

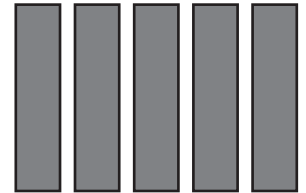
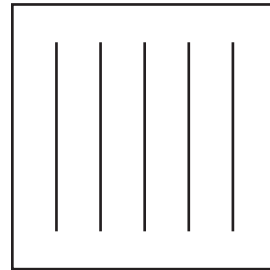

Weave your strips through the square, going over and under. Glue each strip at both ends or paste your weaving onto a square of black cardboard.

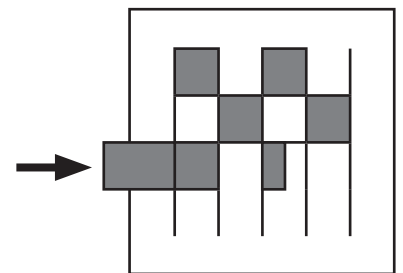

What to do next:

Join your weaving with those of your classmates to make a great big rug.

Talk with your teacher and classmates to answer these questions.

What shape is the rug?

How many big squares are in the rug?

How many small squares might there be?

You will need:  partners  a bag      3D shapes

What to do:

Ask your teacher to secretly put a shape into the bag.

Take turns reaching into the bag and describing the shape you feel. You can talk about its corners, its faces, what it reminds you of, or how different parts of it feel.

Ask your teacher to record the words you use on a big chart.

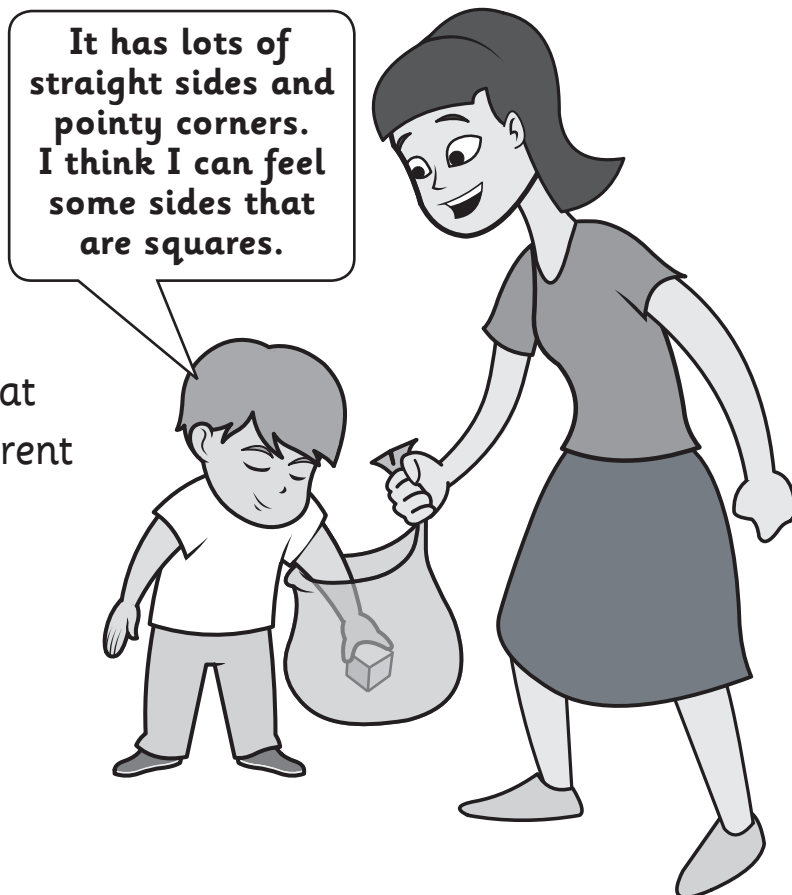

What to do next:

Ask your teacher to read these mystery clues. Use the shapes to help you. Can you name the shapes?

I have no corners or edges.
I feel smooth.
I can roll.

I am a _____

You find many of me in food cupboards.
I have straight sides.
I have corners.
My faces are rectangles.

I am a _____

3D space – language

You will need:  markers  paper  glue stick
 a cardboard box

3D shapes have **faces**.

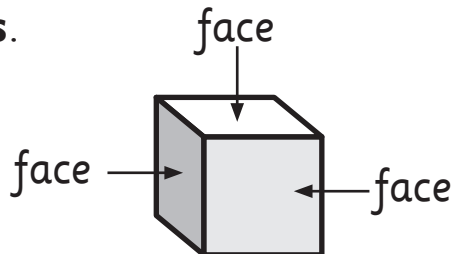

What to do:

Look at your box. Use your paper and markers to draw a face for each face of your box. Glue them on.

Count and number the faces on your box.

How many faces does it have?

How many faces does someone else's box have?



3D space – language

- 1  Write or tell someone what you call these shapes.
Draw an everyday object that is the same shape.

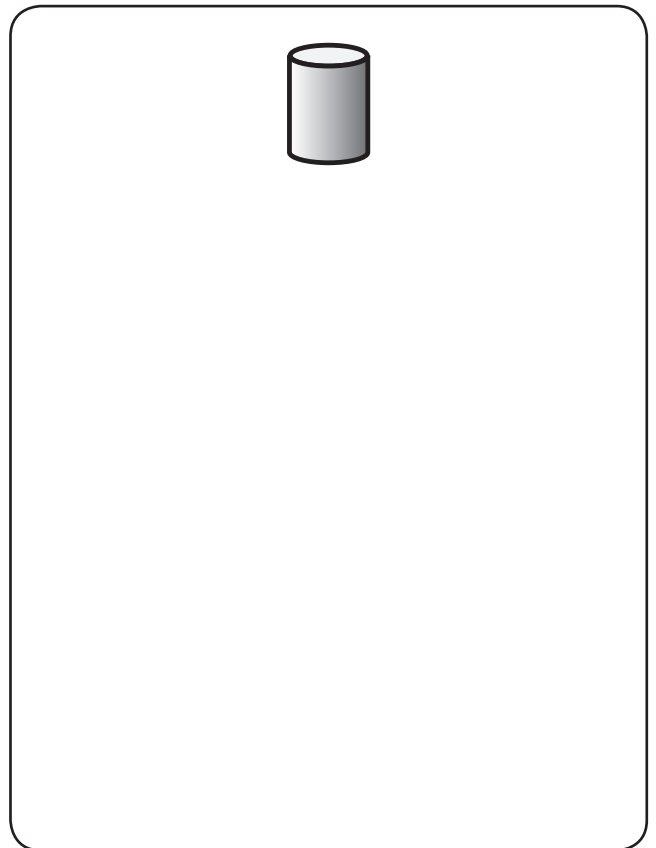
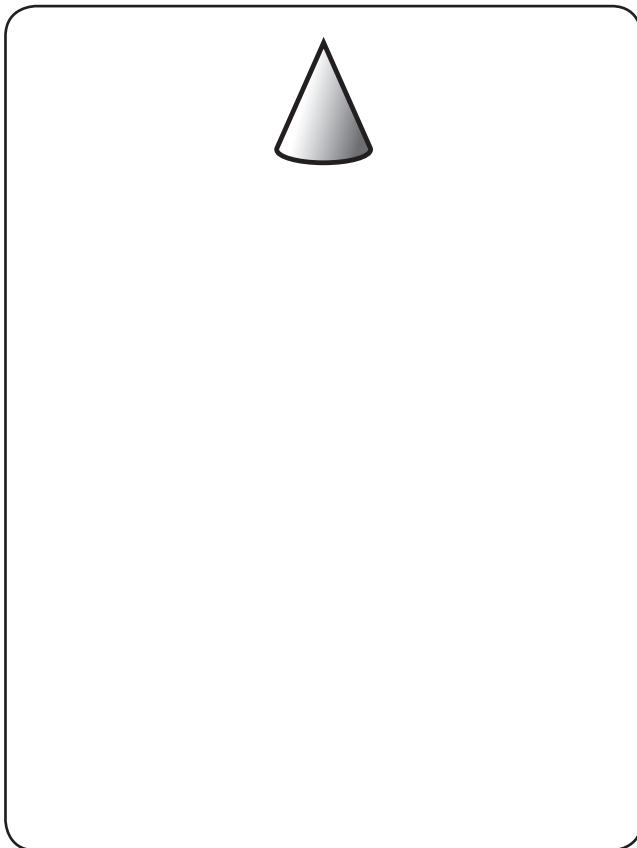
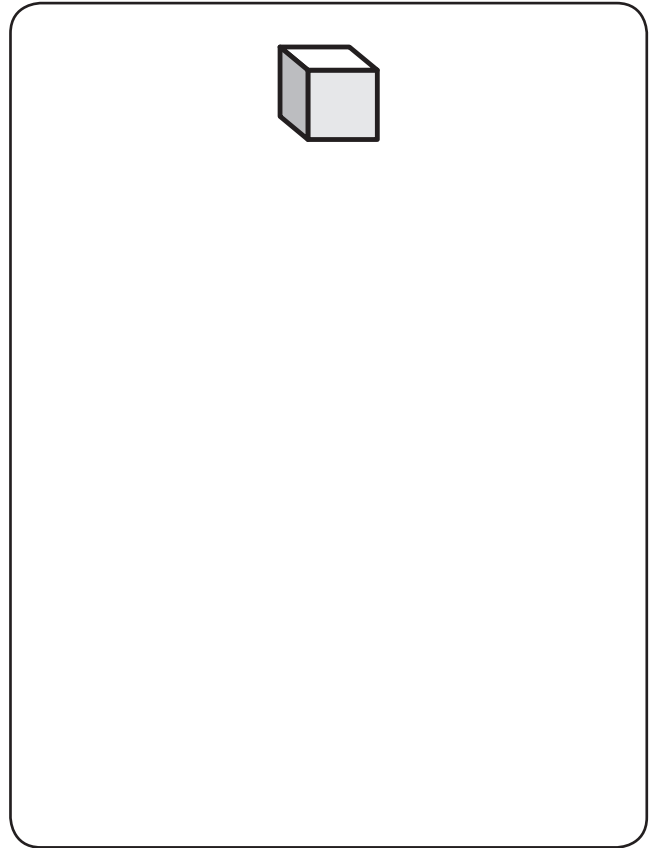
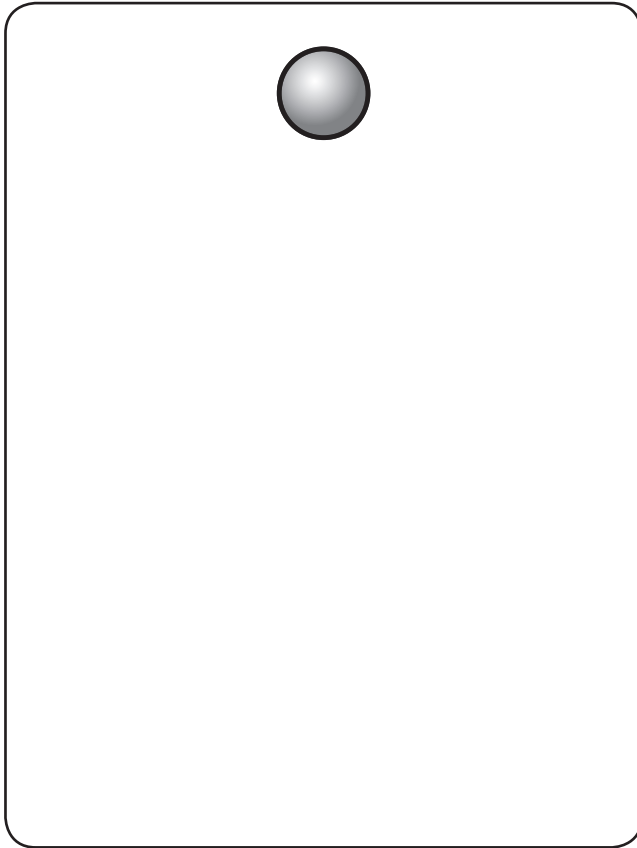

3D space – everyday objects

You will need:  scissors  glue stick  a copy of page 19

What to do:



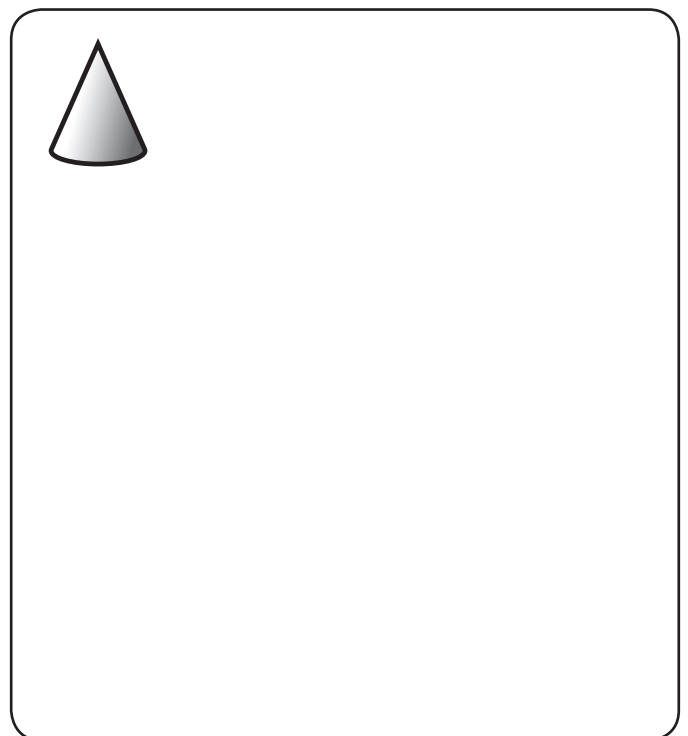
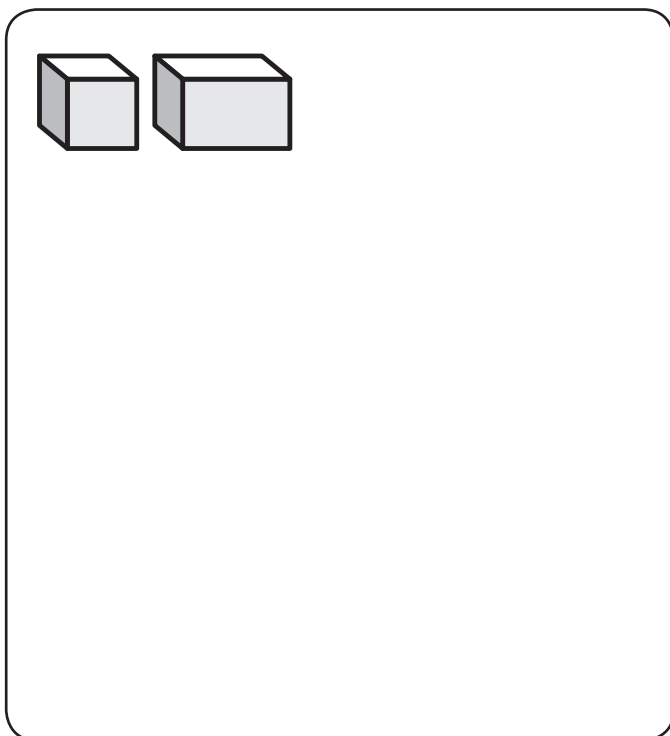
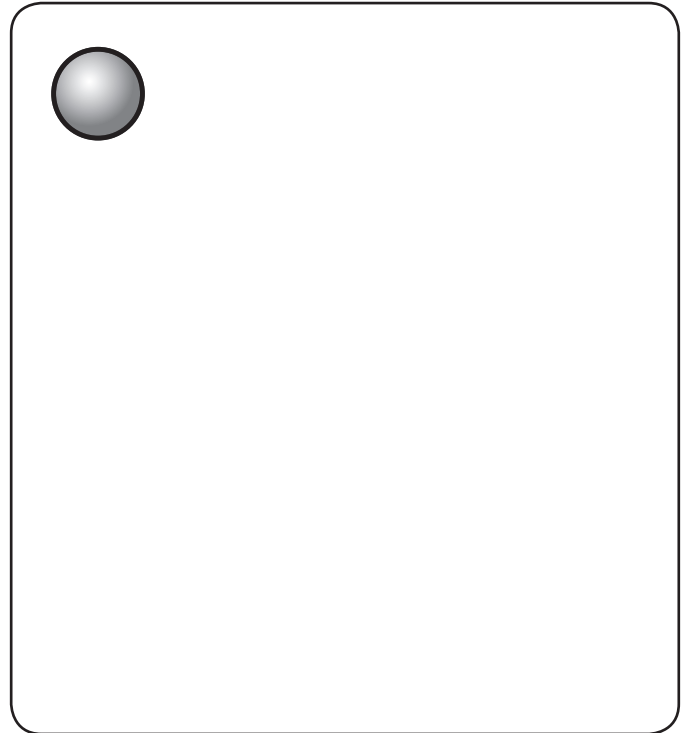
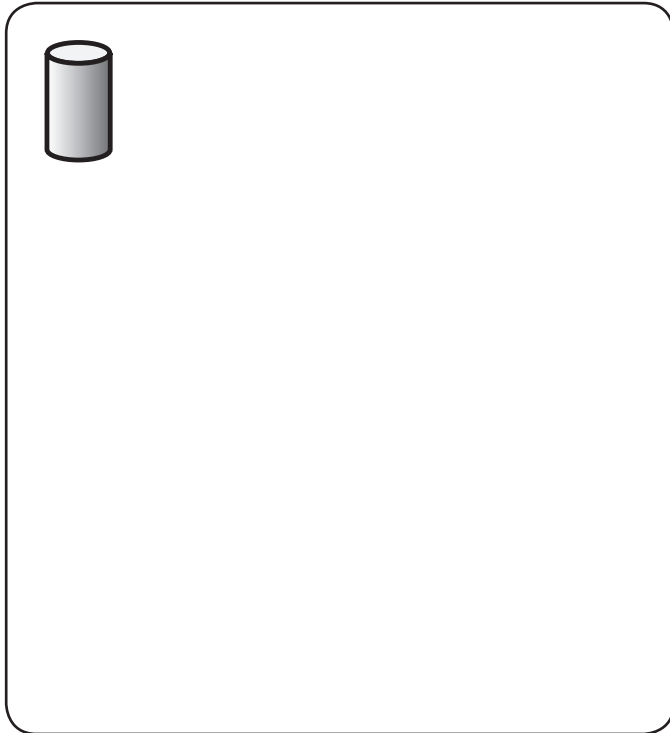



Cut out the pictures of the everyday objects on page 19. Sort and paste them into the right boxes below.



3D space – everyday objects



3D space – explore

You will need:  a partner      3D shapes
 blocks and a plank

What to do:

Build a slide out of your blocks and plank.
A big, hardback book will also work as a slide.

Which shapes will roll?

Which shapes will slide?

Test them out to see.

Colour the right word.

I think it
will roll.

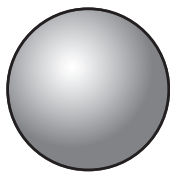

roll

slide

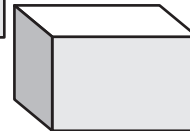
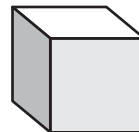

roll

slide

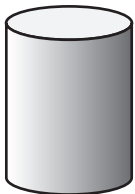

roll

slide

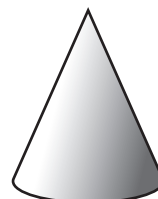





roll

slide

What to do next:

Will some shapes do both? Circle them if they do. Tell someone why you think that is.

3D space – explore



You will need:  a partner      3D shapes

What to do:

Which blocks stack well?

Test them out.

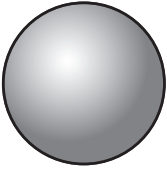
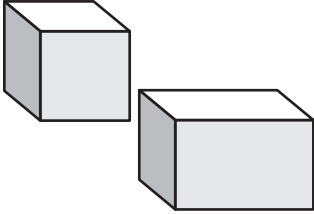
Tick the blocks that stack. Cross the blocks that don't.

 <input type="checkbox"/>	 <input type="checkbox"/>	 <input type="checkbox"/>	 <input type="checkbox"/>
---	---	--	---

What to do next:

Choose the block you think will be best for building a tower.

Build it. How high can you go? Draw a picture of your tower.

3D space – explore

You will need:



smock



paint



paper



a cardboard box

What to do:

Look at the faces on your box. What shapes do you think they are?

Carefully paint one face of your box and then print it onto your paper. Do the same for all of the box faces.

What shapes are there?

Does your box have different shaped faces or are they all the same?

Ask your teacher to write your findings on your paper.

.....

What to do next:

Choose a different box or a cylinder and find out what kind of faces it has.

Position – language

The star is

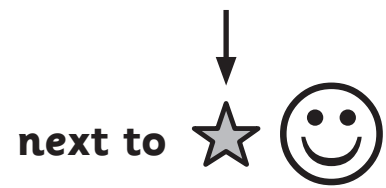
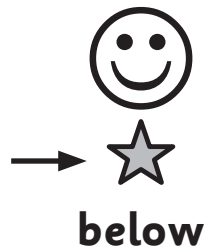
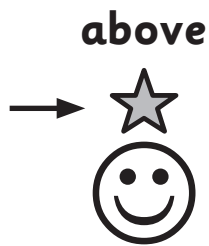

1  Draw an 

above the girl



below the girl



next to the girl



2  Draw:

- yourself **in the middle** of the box
- a friend **next to** you
- a plane **above** you
- a worm **below** you



Position – language

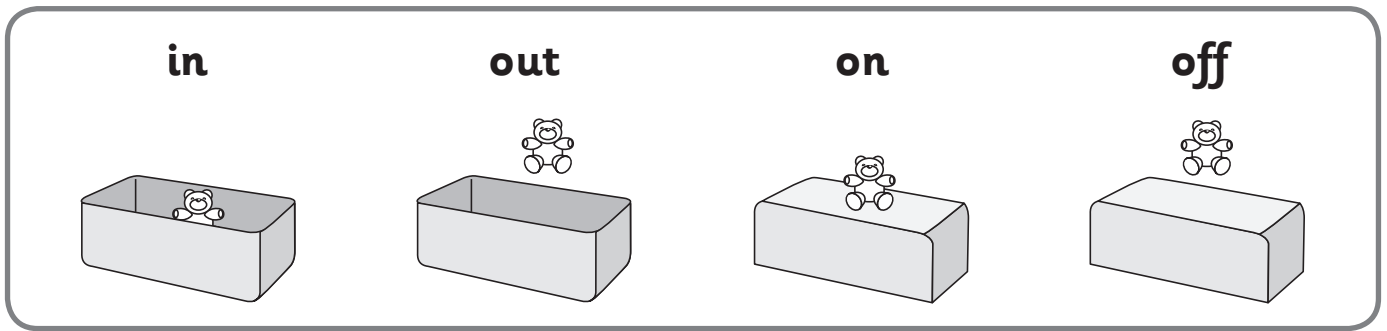

You will need:



a partner



your lunchbox



a teddy or an animal counter



scissors

What to do:

Cut out the words. Mix them up and put them face down.

Take turns picking a card. Use your lunchbox and put your teddy in the right place. If your partner thinks you have done the right thing, you can keep the card. Play until all the cards are gone.

What to do next:

Ask your teacher if you can go out to the playground with your class. Ask your teacher to tell you to get **on**, **off**, **in** or **out** of something. Watch out, their instructions will be fast!

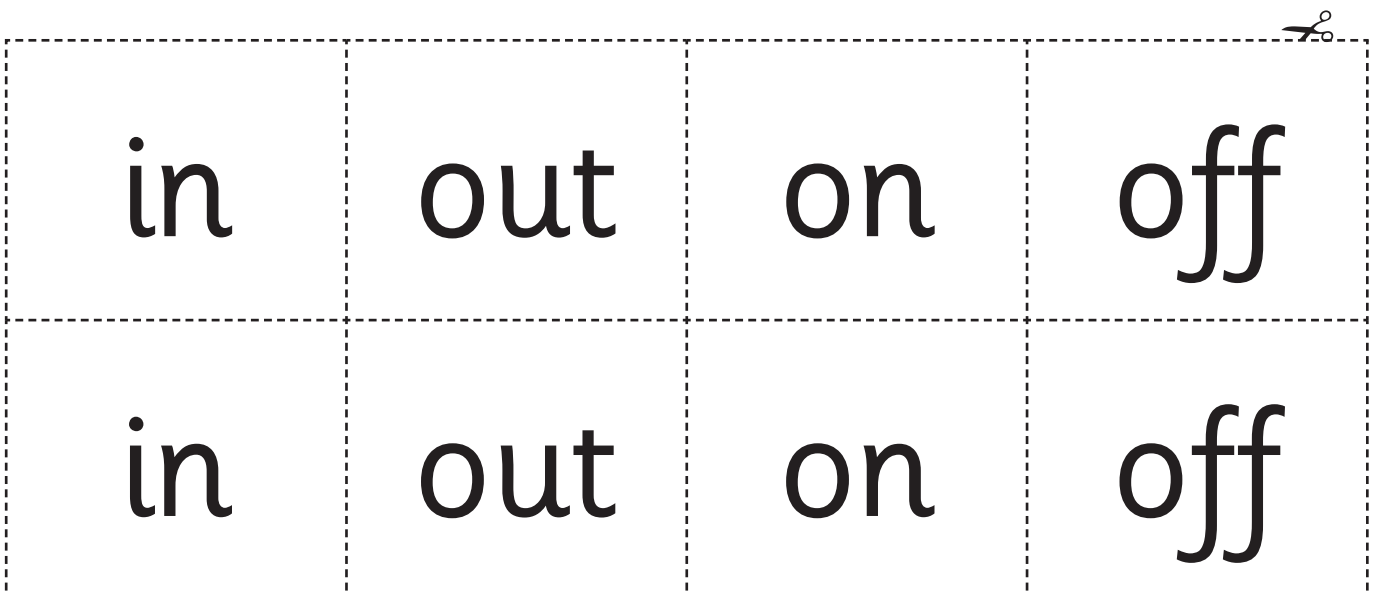

Position – language

You will need:  a partner  scissors



What to do:

Cut out the cards. Put them in a pile, face down.

Take turns taking a card and telling your partner **where the star is** compared to the other object.

You could start your sentence with 'The star is ...'. If your partner agrees that your sentence makes sense, take the card.

Play until all the cards are gone.

What to do next:

You could play again, this time saying where the star is **not**.

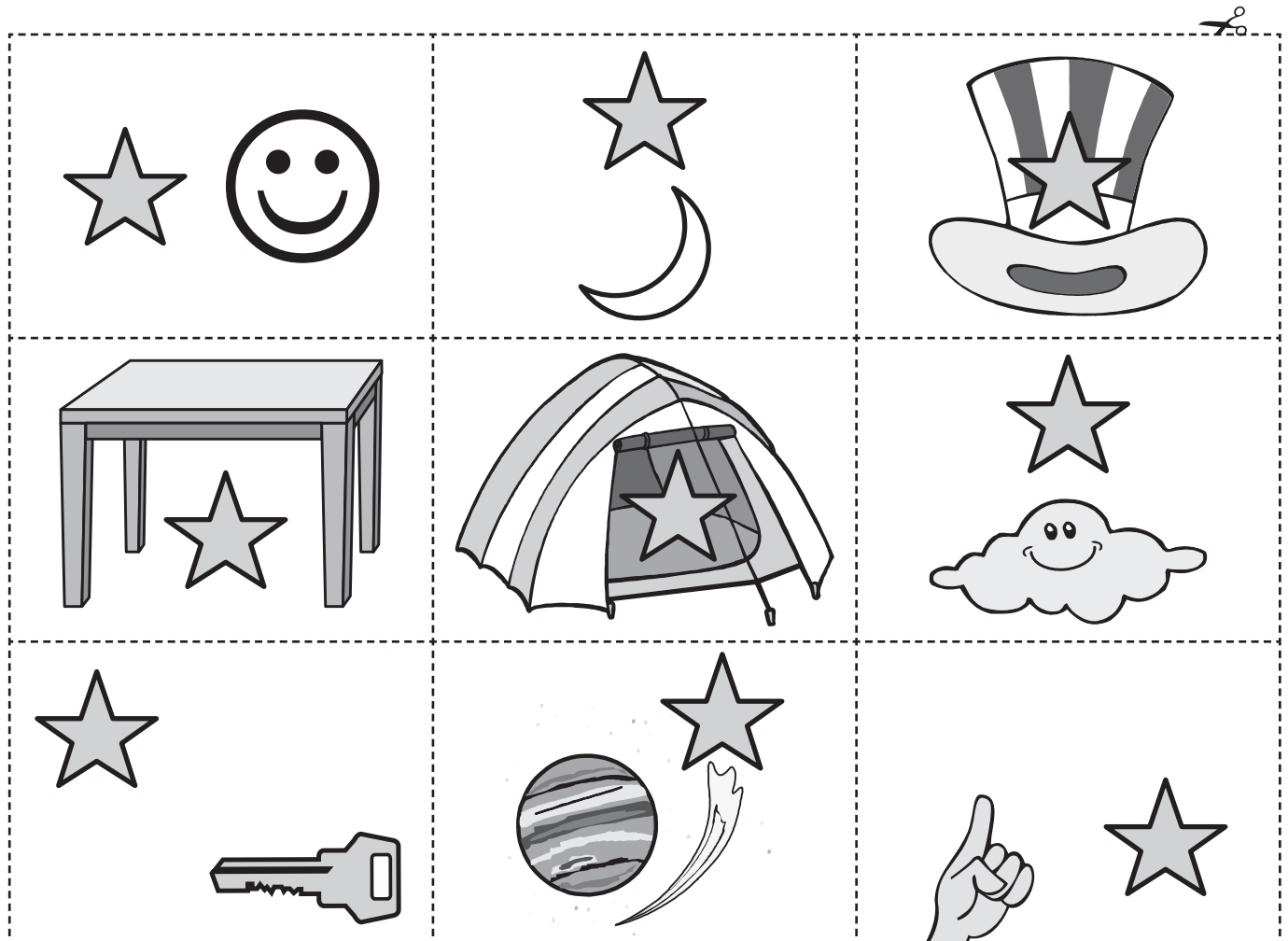

Position – language

1  Ask your teacher to read these instructions to you. Watch out, the picture will be a bit crazy!

- Draw a pig in **the middle** of the box.
- Draw clouds **underneath** the pig.
- Draw a tree **above** the pig.
- Draw a snake **next to** the pig.
- Draw a hat **on** the snake.
- Draw a sun **underneath** the snake.
- Draw a mouse **far away** from the snake.



Position – language

You will need:  your teacher or a helper

What to do:

The words below all tell us about **position** – where something is.

Your teacher will use these position words to tell you where to stand or how to move. They might say, ‘Stand **next to** a chair’, or ‘Go **under** the table and **around** my chair’.

They will tick off the words you understand.

under <input type="checkbox"/>	over <input type="checkbox"/>	around <input type="checkbox"/>
above <input type="checkbox"/>	below <input type="checkbox"/>	along <input type="checkbox"/>
in front <input type="checkbox"/>	behind <input type="checkbox"/>	beside <input type="checkbox"/>
next to <input type="checkbox"/>	between <input type="checkbox"/>	side by side <input type="checkbox"/>
towards <input type="checkbox"/>	away from <input type="checkbox"/>	inside <input type="checkbox"/>
close to <input type="checkbox"/>	outside <input type="checkbox"/>	apart <input type="checkbox"/>

What to do next:

Find a partner and play the same game with each other.

Position – directions

What words do we use when we give directions to someone?

You will need:  a partner  another team

What to do:

You are going to direct people to get to a particular place. Decide with your partner where this is. It could be the library, the office or another classroom.

Practise going there with your partner and decide on the directions you will give people. You might say things like:

‘Go **straight** down the hallway. Just **before** Mrs Lee’s room, **turn** and go **out** the door ...’

Find another team and give them the directions. Were your directions right or did you have to change them a bit as you went?



What to do next:

Talk with others about all the different words we can use when we give directions. Ask your teacher to record them for you.