

# Helping Out with Maths in the Evening

Key Stage 1



# Table of Contents

<b>100 Square Un-numbered</b>	<b>03</b>
<b>100 Square Numbered</b>	<b>04</b>
<b>Counting On/Back</b>	<b>05</b>
<b>Higher Level Partitioning</b>	<b>06</b>
<b>Rounding &amp; Adjusting Strategy</b>	<b>07 - 08</b>
<b>What Strategy is Best?</b>	<b>09</b>
<b>Place Value</b>	<b>10 - 12</b>
<b>Addition</b>	<b>13 - 14</b>
<b>Subtraction</b>	<b>15 - 20</b>
<b>Spinners</b>	<b>21</b>
<b>Time to Combine</b>	<b>22</b>
<b>Off the Decade</b>	<b>23</b>
<b>Hop on from 30</b>	<b>24</b>
<b>Up and Over the Bridge 57</b>	<b>25</b>
<b>Up and Over the Bridge 42</b>	<b>26</b>
<b>TUTU Adding Bridges / TUTU Takeaway</b>	<b>27</b>
<b>A bunch of 5's</b>	<b>28</b>
<b>Useful websites/Links</b>	<b>29</b>



# 100 Square Un-numbered

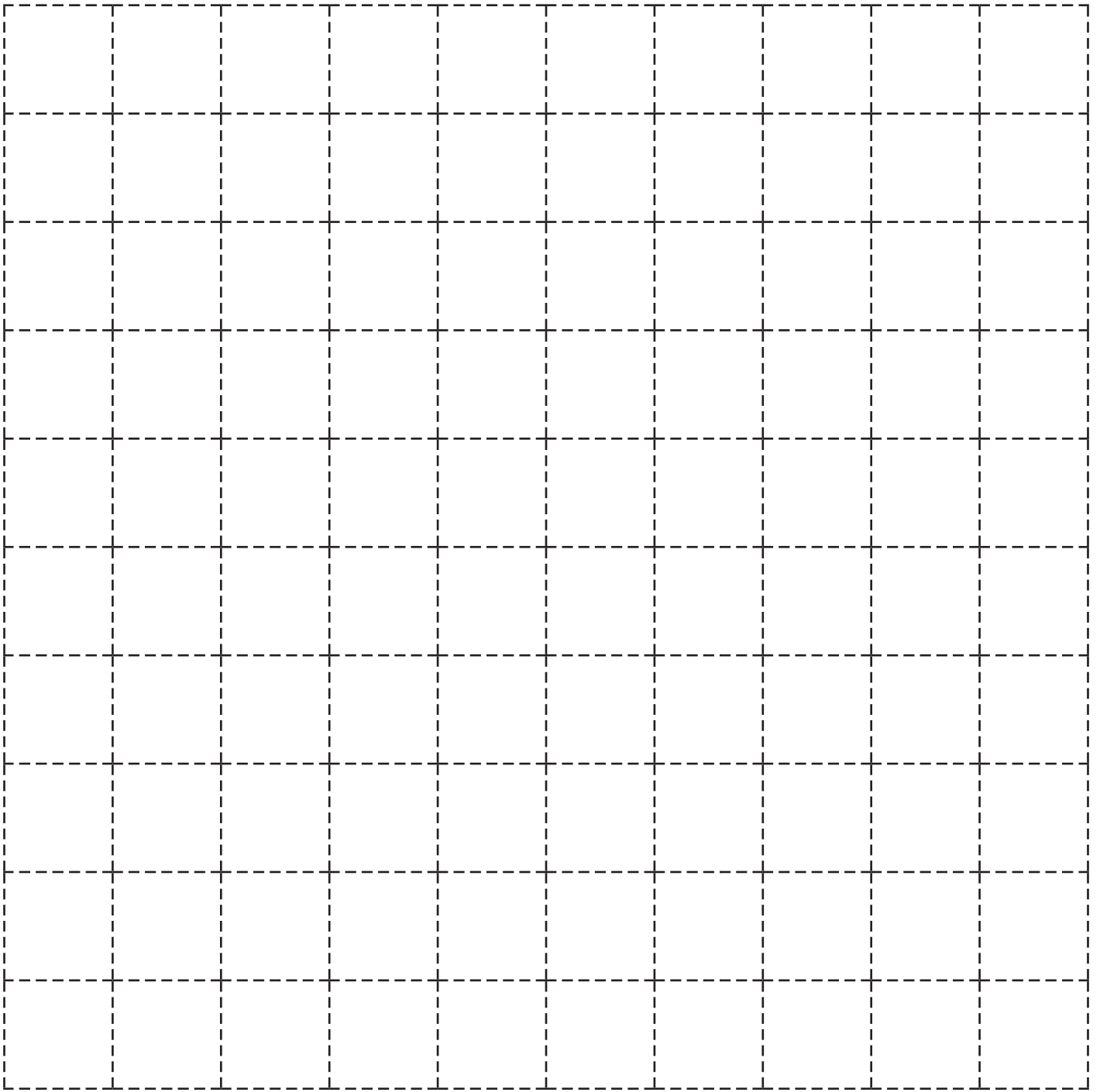

# 100 Square Numbered

1	2	3	4	5	6	7	8	9	10
11	12	13	14	15	16	17	18	19	20
21	22	23	24	25	26	27	28	29	30
31	32	33	34	35	36	37	38	39	40
41	42	43	44	45	46	47	48	49	50
51	52	53	54	55	56	57	58	59	60
61	62	63	64	65	66	67	68	69	70
71	72	73	74	75	76	77	78	79	80
81	82	83	84	85	86	87	88	89	90
91	92	93	94	95	96	97	98	99	100



# Counting On/Back using empty number line

Typical questions to ask your child:

1. What number is this?
2. Point/Show me e.g. 90

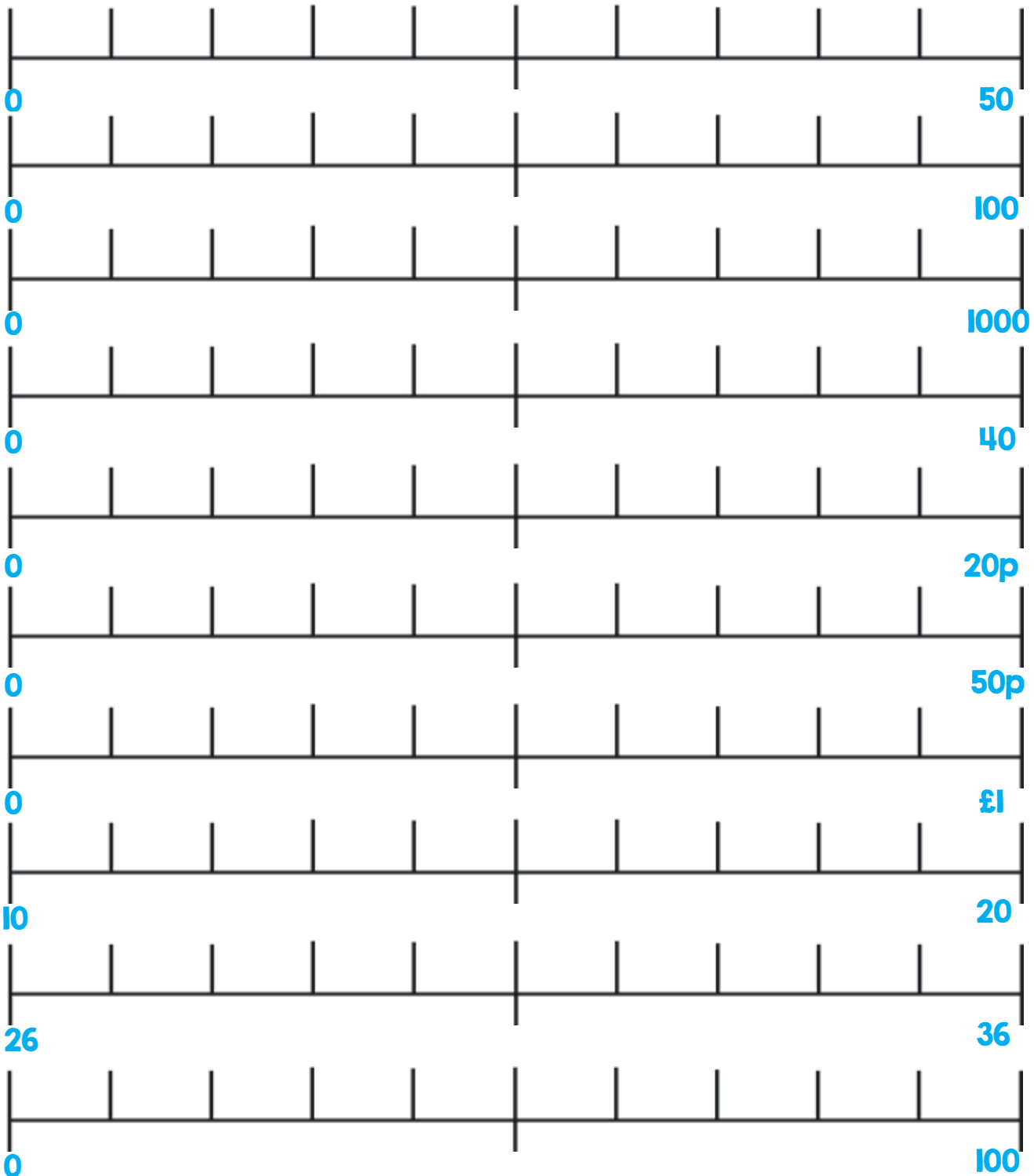

3. Use different starting numbers e.g. 10-20, 36-46
4. Count in 4s (4x tables)
5. Show me 37p. How much more to make 50p? £1 etc.



# High Level Partitioning

## Example 1

$7 + 5 = ?$

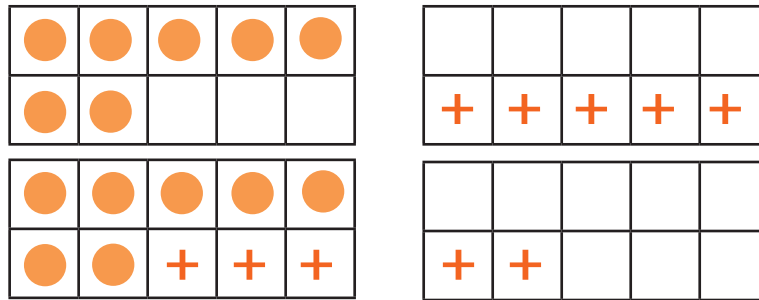

$7 + 5 = 12$   
 $7 + 3 + 2 = 12$

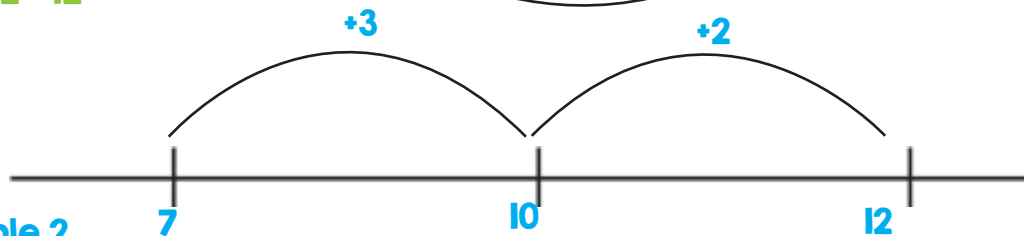

## Example 2

$37 + 5 = ?$

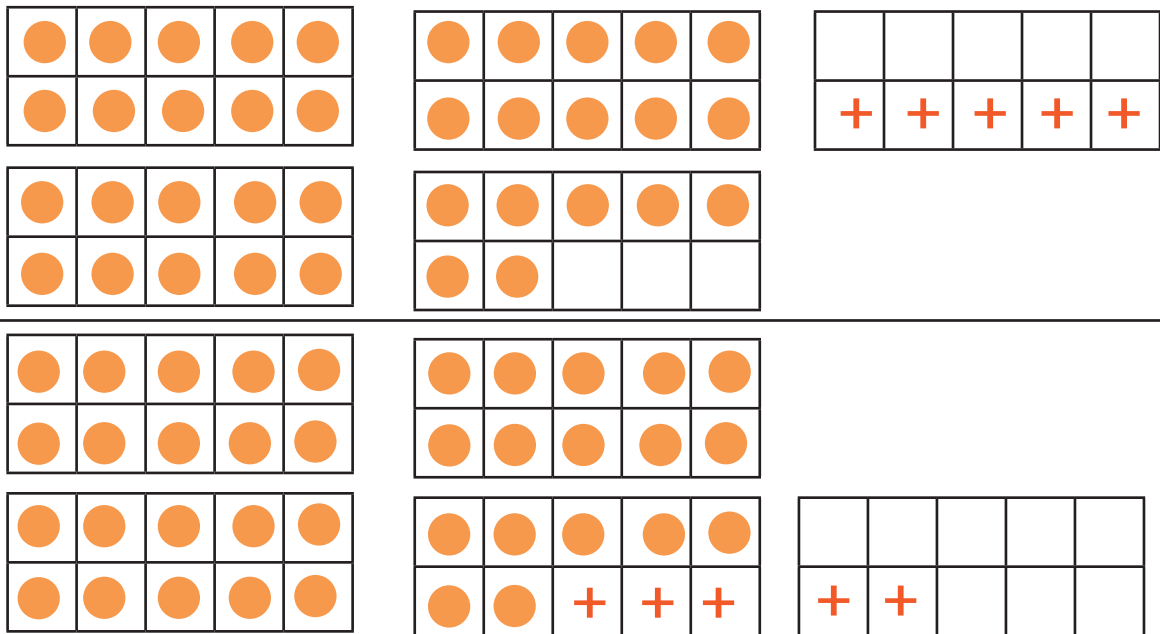

$37 + 5 = 42$   
 $37 + 3 + 2 = 42$

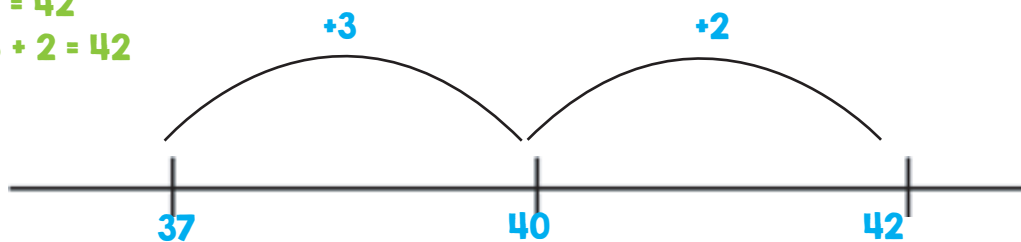

# Rounding and Adjusting Strategy

Sometimes it is easier to adjust when adding or subtracting numbers. This is often the “forgotten” strategy. All you need to do is draw an empty number line

## I. Adding 'near 10' to a number

### Example 1

$$16 + 9 = 25$$
$$16 + 10 - 1 = 25$$

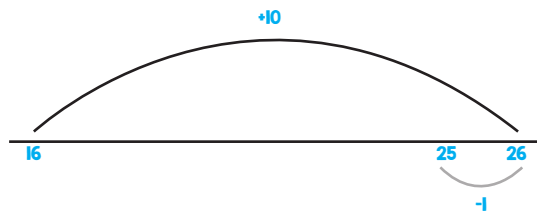

### Example 2

$$29 + 8 = 37$$
$$29 + 10 - 2 = 37$$

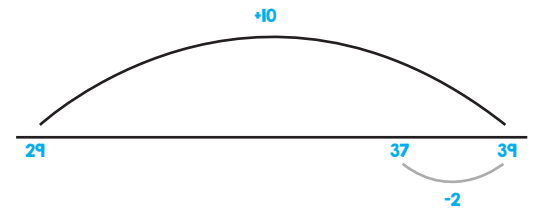

### Example 3

$$88 + 7 = 95$$
$$88 + 10 - 3 = 95$$

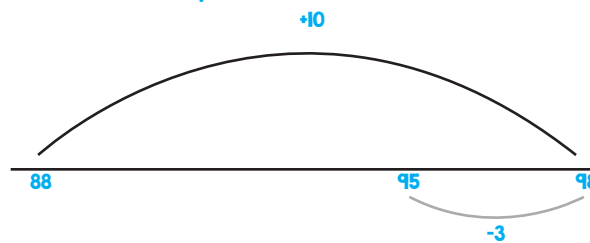

# Rounding and Adjusting Strategy

## I. Subtracting to a 'near 10' from a number

### Example 1

$$34 - 9 = 25$$
$$34 - 10 + 1 = 25$$

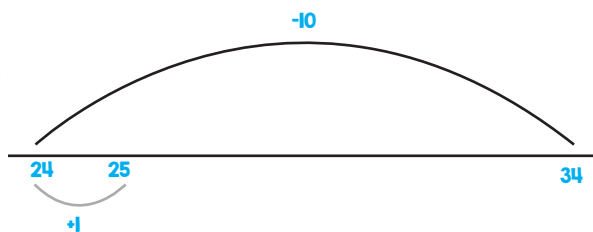

### Example 2

$$71 - 7 = 64$$
$$71 - 10 + 3 = 64$$

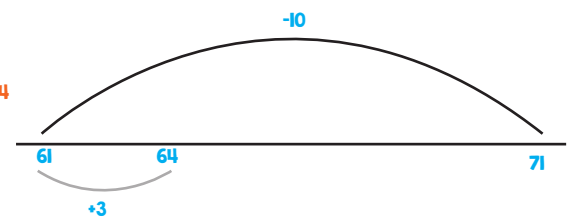

### Example 3

$$105 - 8 = 97$$
$$105 - 10 + 2 = 97$$

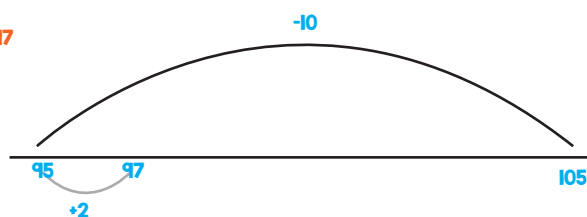

# Rounding and Adjusting Strategy

## 1. Adding to a 'near multiple of 10'

**Example 1**  
 $43 + 29 = 72$

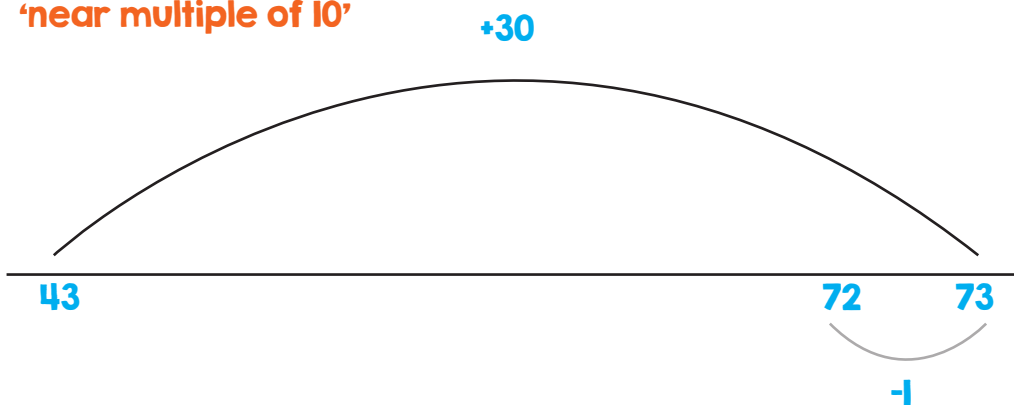

**Example 2**  
 $55 + 37 = 92$

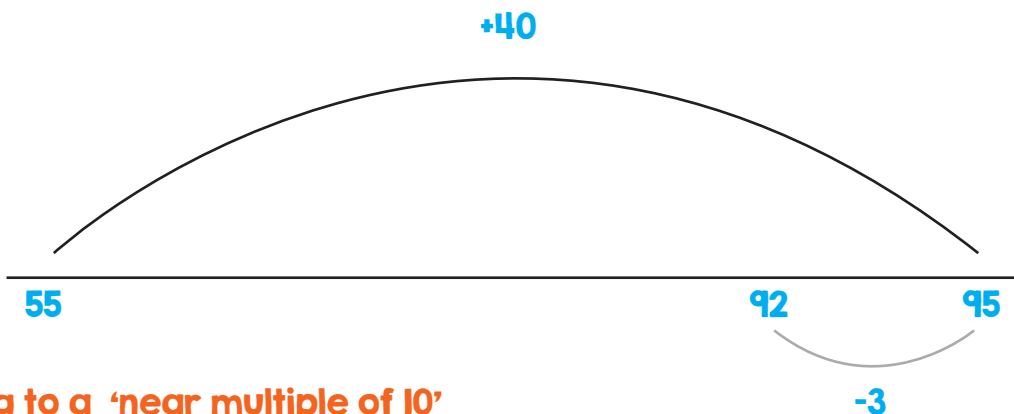

## 2. Subtracting to a 'near multiple of 10'

**Example 1**  
 $94 - 19 = 75$

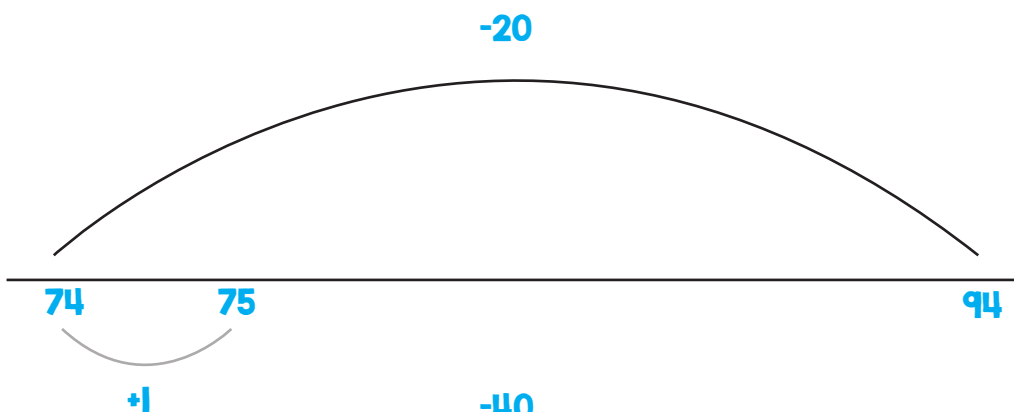

**Example 2**  
 $87 - 38 = 49$   
 $87 - 40 + 2 = 49$

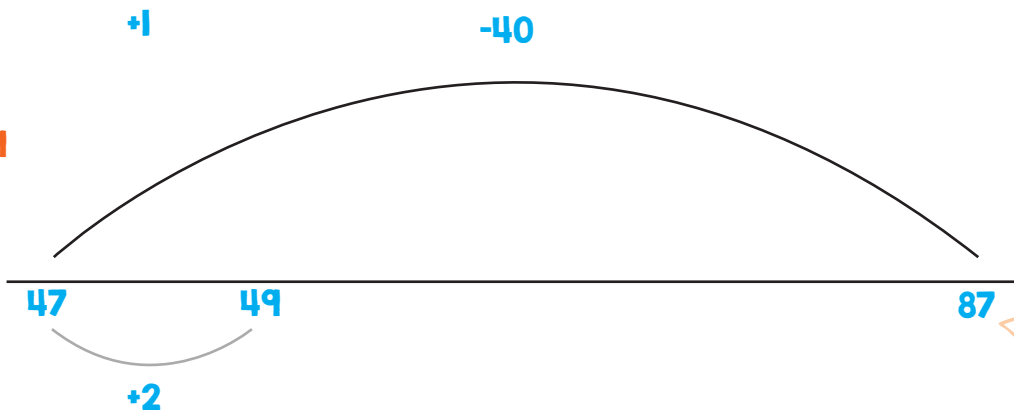



# Which Strategy is Best?

When pupils have worked through a variety of mental strategies e.g;

- Counting on/back
- Rounding/adjusting
- Combining
- Partitioning etc.

They can use the most efficient/practical one (or very often the one they feel most comfortable with). This final example shows a variety of ways to do the same problem mentally.

## Problem:

For his break, Charlie buys a banana at 36p and a bottle of water at 48p. How much does he owe the shop?

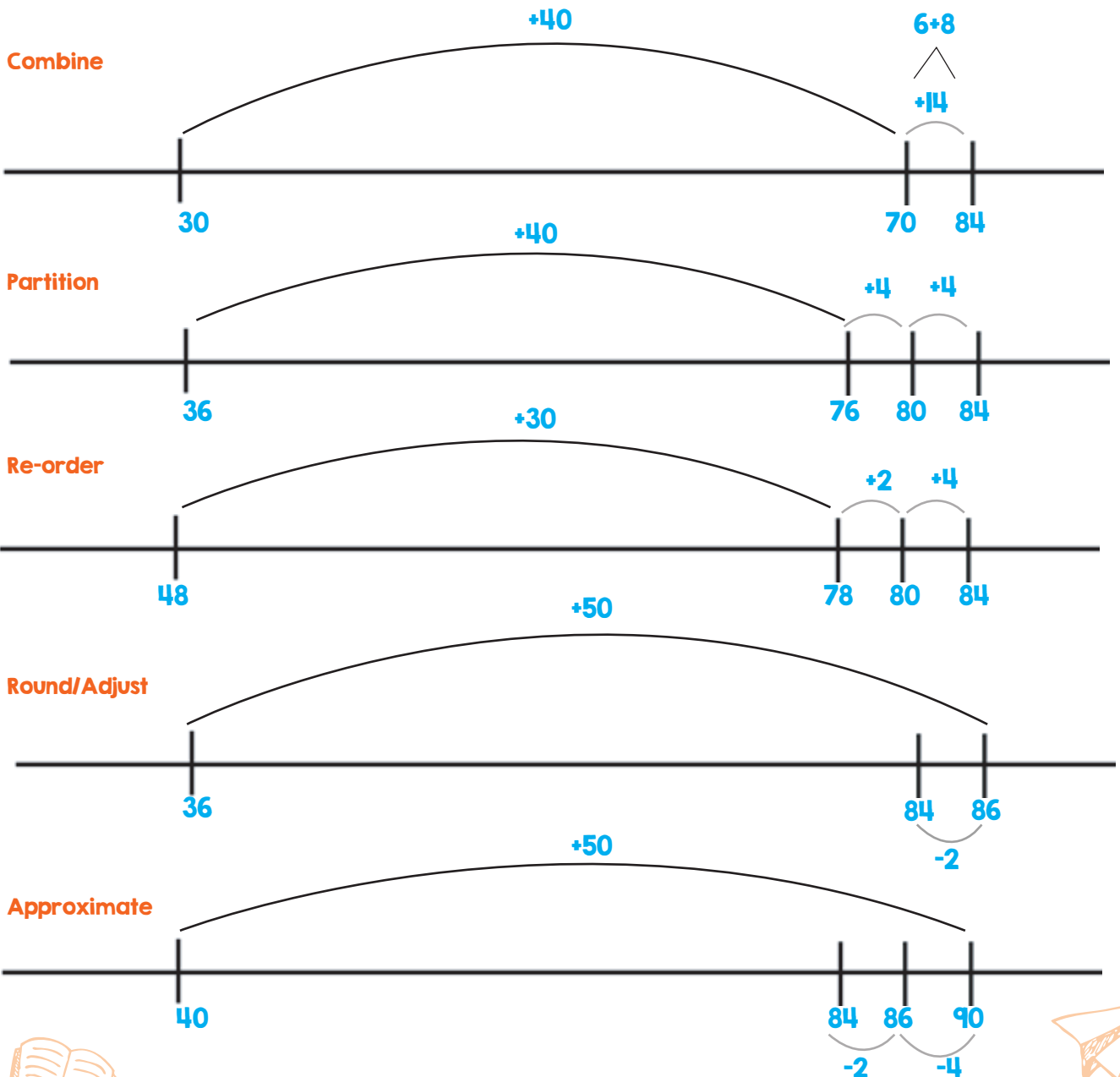

# Place Value

## Things I Need for Place Value

### Materials:

- Place Value Kit OR
- Page 4 (KSI Booklet) Laminated

### Useful Websites:

<http://nlvm.usu.edu/>

- Google NLVM
- Click on 'Browse Resources'
- Click on 'NLVM Activities'
- Number and Operations
- PreK2
- Base Blocks

<http://www.topmarks.co.uk/>

- Whiteboard Resources - Maths
- KSI - Place Value
- DIENES and Coins
- Place Value Charts
- 'Group the Blocks and Identify'

- Google oswego maths or OCSD Maths
- "Dog Bone" or "Give the dog a bone"

1 Go to website address: <http://nlvm.usu.edu/> or Google NVLM

- a. Number and Operations - PreK2
- b. Base Blocks

a) Give your child plenty of practice making up 2 digit numbers (Tens/Units) e.g. 37, 43, 72 etc. using the laminated version of Page 6 (Blank 100 Square) or Place Value Kit or Page 6 of KSI Booklet (Laminated).

Tip: Encourage the child to draw a line between T/U e.g. 37 is 3 Tens Strips and 7 Dots with dry wipe marker on a 4<sup>th</sup> Strip (see below diagram).



b) Encourage the child to do the same with 'real' money e.g. 10ps and 1ps - 37p = x3 10ps and x7 1ps



# Place Value

c) 1 Google NLVM (Base Block) and get your child to show you e.g. 37 a different way (using a different number of T/U). Look at the answer below.

E.g. **T**      **U**      37 is 3 Tens 7 Units  
       3      7

**T**      **U**      37 is 2 Tens 17 Units  
   2      17

d) Give your child the chance to practise some of these with their Place Value Strips (Page 4 of KSI Booklet or Place Value Kit) e) Now try this using 10ps/1ps



37p =



37p =



f) Get your child to make 100 (use 3 columns) then move 100 square over to Tens column.

H                      T                      U

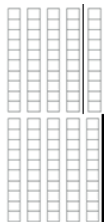

g) Ask What Happens?

h) How many tens?



# Place Value

- i). Get your child to move one of the Tens into Units columns. What happens?  
How many Tens (9) and how many units (10)?

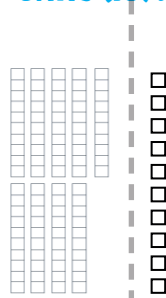

100 = 9 Tens, 10 Units

- j). Get your child to show you 10 strips of 10 (Page 4 of KSI Booklet or Place Value Kit).

- k). Get your child to do the same using with the laminate of Page 4 of KSI Booklet using a dry wipe marker to fill in Units e.g. 100 = 9 Tens 10 Units.

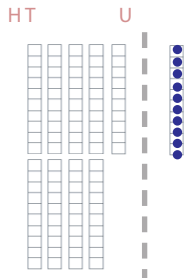

- l). Now do the same with money i.e. £1 = (10 x 10p) or (9 x 10p) + (10 + 1p)

£1 =



OR

£1 =



# Addition

## Things I Need for Addition

### Materials:

- Place Value Kit or Page 4 of KSI Booklet (Laminated)

### Useful Websites:

<http://www.topmarks.co.uk/>

- Whiteboard Resources - Maths - KSI
- Addition of 2/3 digit numbers
- 100 Hunt plus 10
- Bingo Addition
- Dartboard Addition
- Spinners

## Adding to a Ten

a) Get your child to make up any 2 digit number they wish e.g. 58 using the Place Value Kit or Page 4 of the KSI Booklet (Laminated)

b) Ask them: What is the next decade (Ten)? Answer: 60 - Ask the child: How many more to get to next decade? Answer: 2

c) Draw it out using an Empty Number Line (ENL) - see below

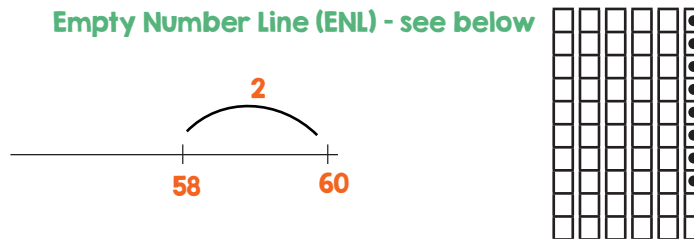

E.g. 2. 22. What is the next decade? (30). How many more to get 30?

Answer: 8.



d) Give them plenty of practice with different numbers. e.g.

- 45 to 50
- 22 - 30
- 64 - 70
- 39 - 40
- 71 - 80
- 93 - 100
- 87 - 90

## Adding from a Ten

a) Get your child to put out some multiples of 10 (10, 20, 30, 40, 50, 60, 70, 80, 90) within 100 using the Place Value Kit or Page 4 (KSI Booklet Laminated)

b) You pick a number between 1-10 and ask them to add (+) it on using another Ten Strip and the marker.

E.g.  $30 + 4 = 34$

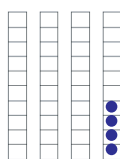

d) Repeat this using different examples each time; (using Place Value Kit and Empty Number Line)

E.g.  $40+7$ ,  $90+3$  etc

c) Ask them to show you this on an ENL.

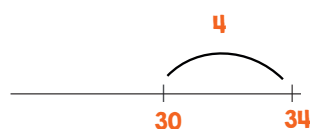

# Addition

## Adding Multiples of Ten

a) Ask your child to make up any 2 digit number with the **Place Value Kit** or **Page 5 KSI Booklet (Laminated)** e.g. 48.

b) Show this on an **ENL** please.

c) You suggest multiples of 10 to add to it e.g. (10, 20, 30, 40...).

d) Your child puts these out and tells you how many is there altogether.  
E.g.  $48+40$

e) Show using an ENL.

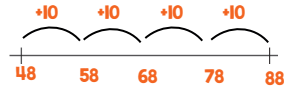

OR

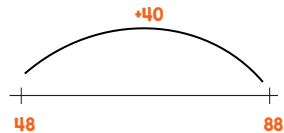

Go to [Google NLVM - Browse Resources - NLVM Activities - Number and Operations - PreK2 - Base Blocks Addition.](#)

a) Give your child practice in adding TU/TU

b) If the Units are more than 10 when added you can click a rectangle around 10 and drag it over to Tens column and drop it in e.g.

T	U
3	8
4	6
8	4

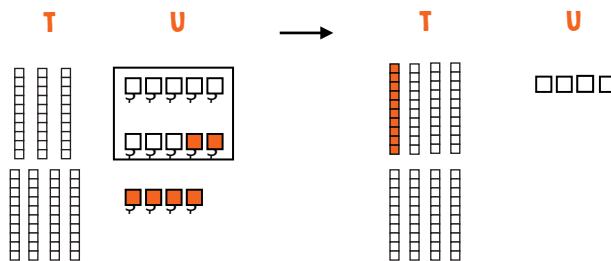

c) Get your child to show this using **ENL**.

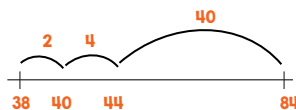

d) Give your child practice using sums of your own set out like this:

T	U	(Roughly)
5	7	(60)
+	3	8
9	5	100

E.g.

**Tip:** Start with units.  $7 + 8 = 15$ . Keep your 5 Units and bring the Ten over 5 Tens + 3 Tens + 1 Ten = 9 Tens

Always do a rough sum e.g.  $57 + 38$  is nearly  $60 + 40 = 100$ .



# Subtraction

## Things I Need for Subtraction

### Materials:

- Place Value Kit or Page 4 of KSI Booklet (Laminated)

### Useful Websites:

<http://enlvm.usu.edu/>

- Click on 'Browse Resources'
- Click on 'NLVM Activities'
- Number and Operations
- PreK2
- Base Blocks - Subtraction

<http://www.topmarksmaths.co.uk>

- Whiteboard Resources - Maths
- KSI - Addition/Subtraction
- Base Block Subtraction
- Spinners

## Subtracting Within 20

a) Get your child to answer any subtraction (taking away) number facts within 20.

E.g.  $11-7$ ,  $13-5$ ,  $15-9$ ,  $19-7$ ,  $15-5$  etc.

b) Get them to draw the sum on an Empty Number Line (ENL).

Example 1:  $11-7$

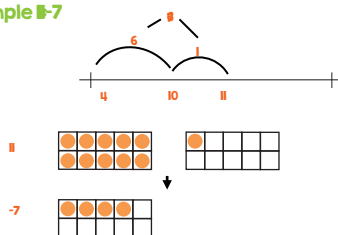

Example 2:  $15-9$

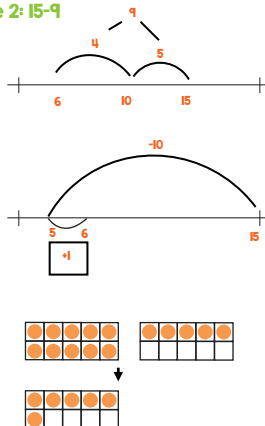

Tip: Try to make sure your child is not counting back in 1s.

## Subtract to a Ten

a) Get your child to make up any 2 digit number the like. E.g. 63 using the Place Value Kit or Page 4 of KSI Booklet (Laminated).

b) Ask them: What is the last decade number (Ten)? Answer: 60 How many did you need to subtract (take away) to get to that Ten? Answer: 3

c) Ask your child to draw this out using an Empty Number Line.

E.g. 1:  $63-3$

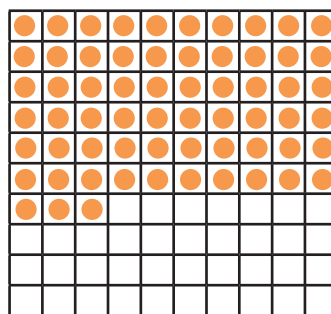

E.g. 2:  $28-8$

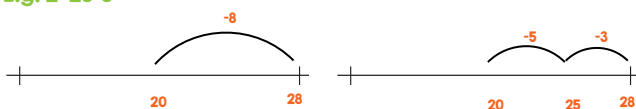

d) Give them plenty of practice with different 2 digit numbers

E.g.

- 87 to 80
- 41 to 40
- 34 to 30
- 92 to 90
- 59 to 50
- 76 to 70



# Subtraction

## Subtract from a Ten

- a) Ask your child to put out some multiples of 10 (20, 30, 40, 50, 60, 70, 80, 90) e.g. 30 using the page 4 of KSI Booklet (Laminated)
- b) Get them to put dots on each square of the last 10.

E.g. 30

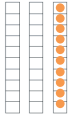

- c) Then ask them to choose any number they want from 1-10 e.g. 6
- d) Ask them to remove 6 dots from their last 10 strip and tell you what is left i.e. 2 Tens 4 Units & 24.
- e) Get your child to show you this on an Empty Number Line (ENL).

Example: 30-6

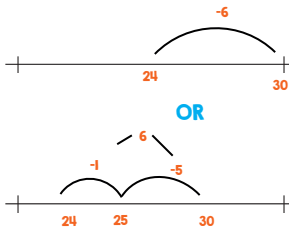

- f) Repeat this using different examples each time.

E.g. 60-4, 90-8, 20-1, 40-7 etc.

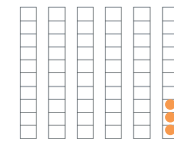

- b) Get them to show this on an ENL



- c) You suggest a suitable multiple of 10 to take away from this e.g. 30 (10, 20, 30...).
- d) Ask your child to take away this number. e.g. 30
- e) How many are left?



# Subtraction

## Subtracting Multiples of Ten

- a) Ask your child to make any 2 digit number they want with the Place Value Kit or Page 4 of KSI Booklet (Laminated) e.g. 53.

**Tip:** Make sure they are removing Ten Strips.





# Subtraction

a) Ask your child to set out the digit number 2 Tens 4 Units or 24 using their Place Value Kit or Page 4 KSI Booklet (laminated) on Post It labels using T(Tens) and U(Units).

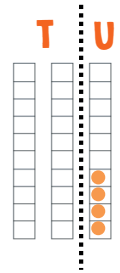

b) From your digit cards using a “Post It” label 3 in the Units and “Post It” label 1 in the Tens (see (c)).

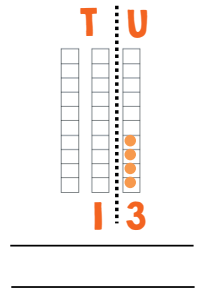

c) Ask your child to start with Units and say 4-3 (Top takeaway bottom) (rub out 3 dots) leaves 1. Then go to the Tens and ask your child to say 2 Tens - 1 Ten (top take away bottom) leaves 1 ten. **Answer = 11.**

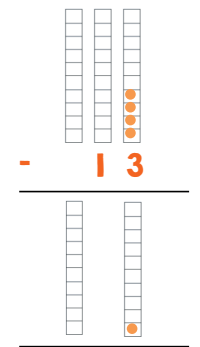

d) Get your child to do this sum using an ENL. E.g.

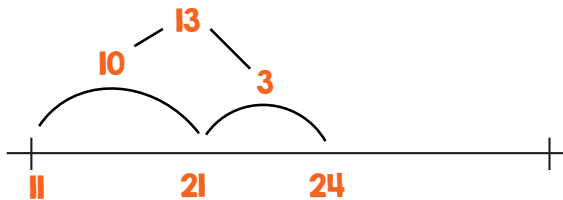

e) Repeat 5a,b, c for other subtraction sums like the one above.



# Subtraction

a) Ask your child to set the number 35 out using their Place Value Kit or Page 4 of KSI Booklet (Laminated) and “Post It” labels using T(Tens) and U(Units).

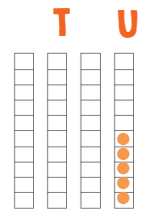

b) From your digit cards using a “Post It” label 6 in the Units and “Post It” label 1 in the Tens.

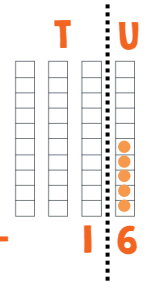

c) Ask your child why this is slightly more difficult? (Because in Units column 5-6 cannot do).

d) Get your child to show 35 a different way using a different number of T/U. (Like the work done in Place Value Cards).

T U  
 i.e. 3 5 → 3 Tens 5 Units  
 2 15 → 2 Tens 15 Units

e) Now with the sum looking like this;

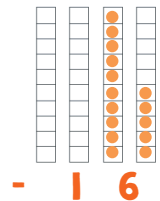

f) Ask your child to start with Units 15-6 (remove or rub out 6 dots from 15 dots leaving 9 Units). Then 2 Tens - 1 Ten = 1 Ten. Answer=19.

g) Get your child to show the sum using ENL.

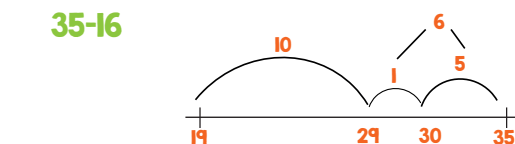

OR

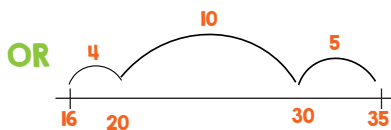
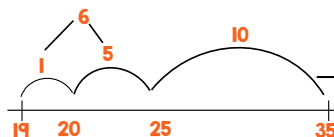

- Mark 16 on ENL
- Mark 35 on ENL
- Count on from 16 to next 10 (2) = 4
- Count on from 20 to 30 = 10
- Count on from 30 to 35 = 5
- Add 4 + 10 + 5 = 19

h) Go to ENLVM-Number and Operations - PreK 2 - Base Blocks Subtraction. Give your child practice in subtracting TU-TU. If you need to exchange a Ten - Click on it and drag it into Units column and note what happens. Then drag the Red Units onto the Blue Units to take away.

Tip 1: Make sure your child checks the answer by drawing it out on an ENL.

Tip 2: Always ask your child to give you a rough answer (approximate) before they start.

Tip 3: Hopefully through time your child shouldn't need the practical materials.



# Subtraction

## Subtracting H/T/U

a) What about e.g.

$$\begin{array}{r} 100 \\ -16 \\ \hline \\ \hline \end{array}$$

b) Get your child to take out 100 square from the Place Value Kit or Page 4 of KSI Booklet (Laminated).

c) Change 100 Squares into 10 Ten Strips

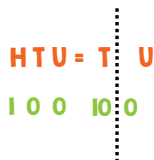

d) Then change a Ten Strip into 10 Units

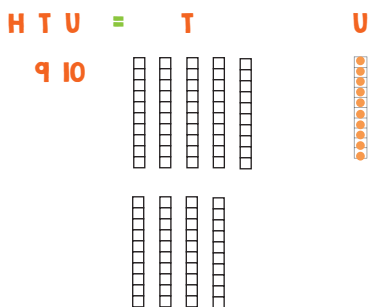

e) Now the sum should look like this;

H	T	U	
0	9	10	
-	1	6	
			!
	8	4	

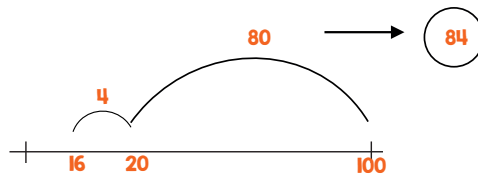

f) Still get your child to do it mentally;

OR

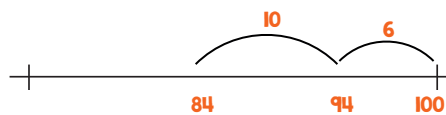

# Subtraction

## Subtracting Money

a) Where numbers are close together or easier to count on, encourage your child to do this. Doing it as a sum will take a lot longer.

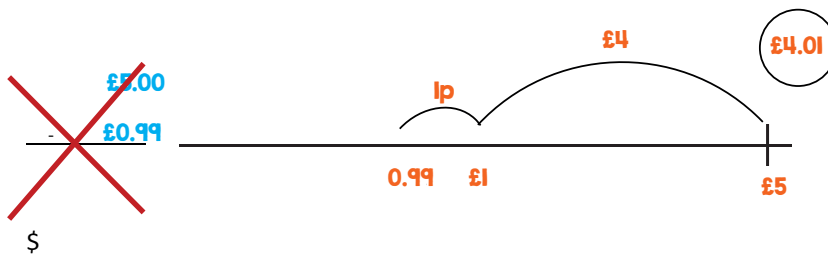
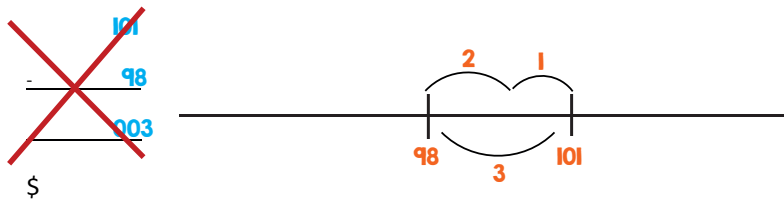

# Spinners

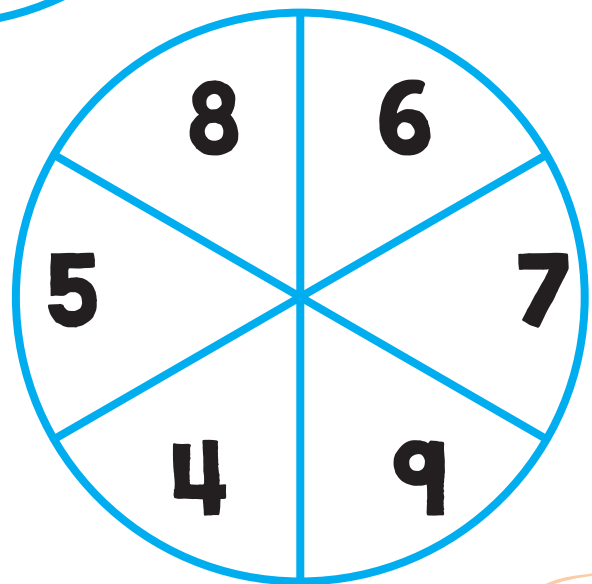
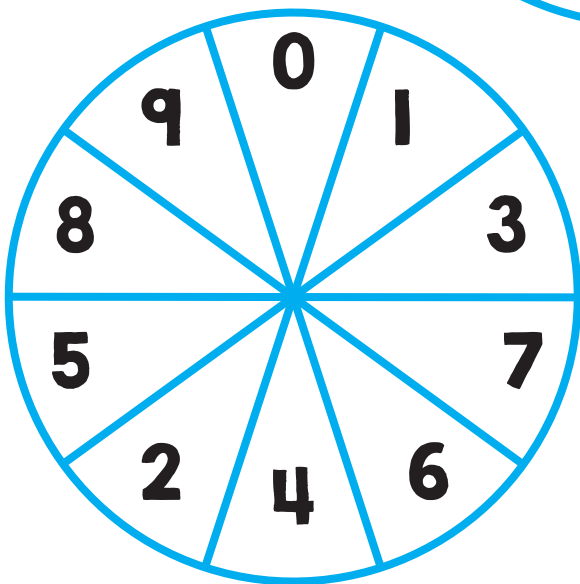
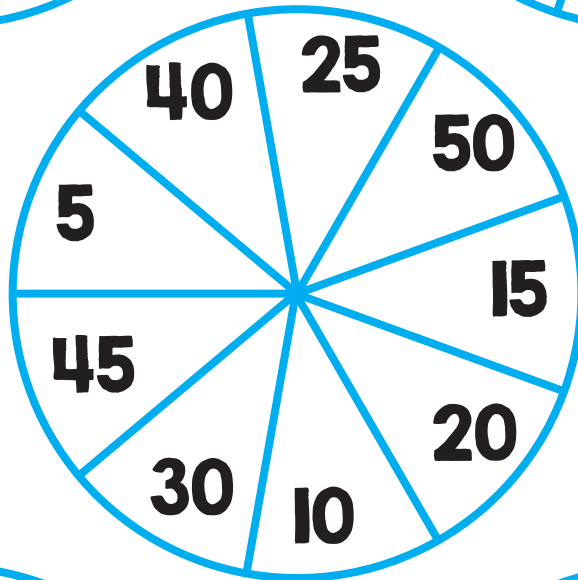
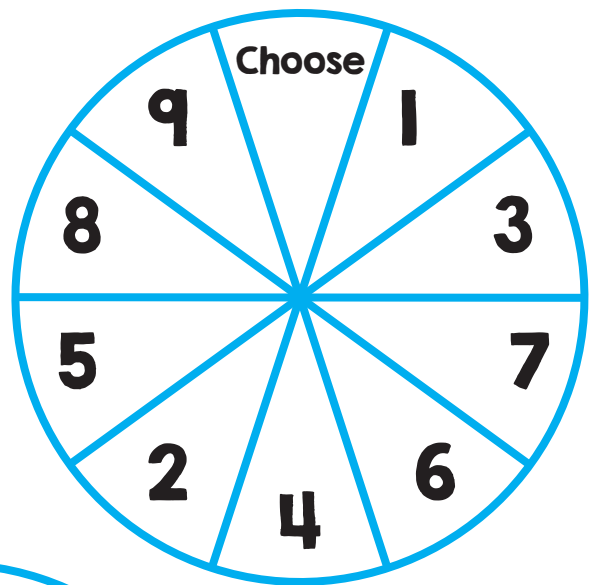
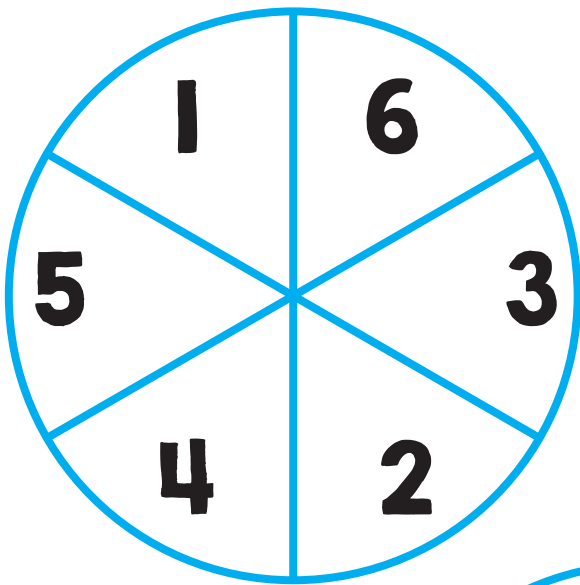

# Time to Combine

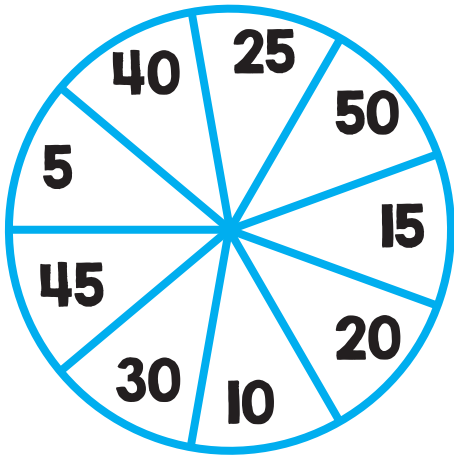

20	50	15	40	10	55	30	45
40	30	35	20	15	30	20	10
50	45	10	55	50	10	40	35

**Materials:** game board, spinner, two kinds of markers, pencils and paper clip.

## Directions:

1. Rotate the spinner to create a number representing the number of minutes past the hour (Example: If it lands on a 20, the number of minutes past the hour would be 20).
2. Decide how many minutes would be needed to reach the next hour. Since there are 60 minutes in an hour, decide how many more it would take to equal 60. (EG. If a 20 is spun, a marker would be placed on 40 since  $20 + 40 = 60$ , and 20 minutes past the hour is 40 minutes until the next hour).
3. Place the marker on the game board that represents the missing amount. The winner is the first player with 3 markers in a row, horizontally, vertically or diagonally.

## “Jumping to 50” Spinner

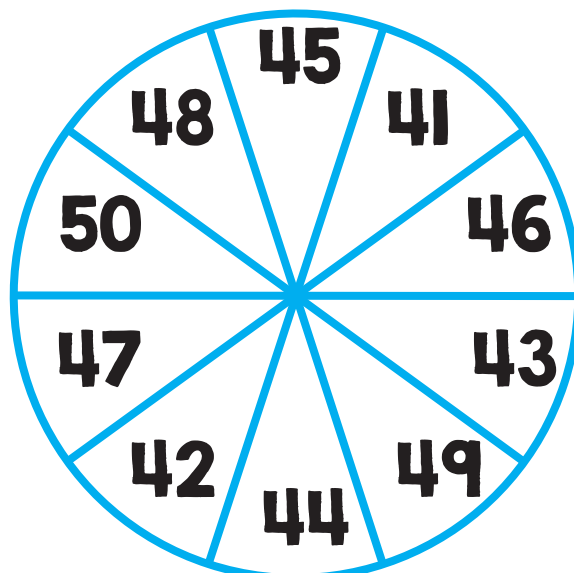

## Off the decade

51	71	26	42	2	16
5	14	36	63	74	65
34	56	75	54	25	43
1	12	32	21	3	33
41	73	44	35	61	23

Roll two dice. Use these numbers to make a 2-digit number. Eg. if you roll a 1 and a 3 you could make 13 or 31. Add 10 to, or subtract 10 from that number.

Get player to draw out the answer on an empty number line (ENL) Eg.  $31 + 10$

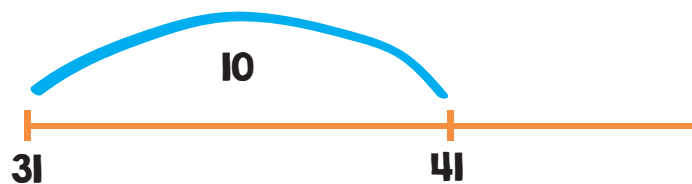

Find it on the grid and cover the answer with one of your counters. First player to get 4 counters in a line wins.



# 30

## Hop on From 30

# 30

32	36	34	35	37
34	37	38	32	39
39	36	33	34	36
34	35	31	39	35
31	38	35	33	37

# 30

**Aim:** Cover three in a row with your counters.

**Materials:** Board game, two kinds of counters, dice or spinner 1-9

**How to play:**

1. Player one rolls or spins to determine the amount to add to 30.
2. Player says the addition number sentence and places the counter on the answer.

**Get player to draw out the answer on an ENL**

**Eg.  $30 + 4$**

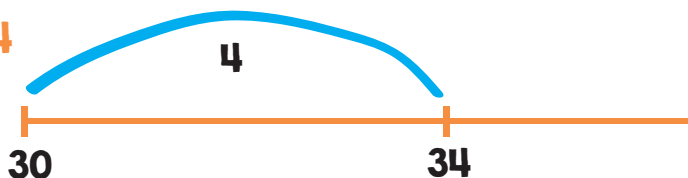

3. The next player rolls or spins, adds, and places the counter on the answer.
4. Players take turns until one player has 3 counters in a row.





## Up and Over the Bridge 57

57

61	65	63	62	64
65	66	62	65	63
66	64	61	66	62
63	66	62	64	65
64	61	65	63	61

57

**Aim:** Cover three in a row with your counters.

**Materials:** Board game, two kinds of counters, cube or spinner 4-9

**How to play:**

1. Player one rolls or spins to determine the amount to add to 57.
2. Player says the addition number sentence and places the counter on the sum.

Get player to draw out the answer on an ENL

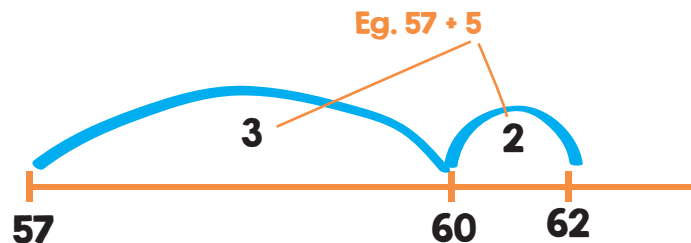

3. The next player rolls or spins, adds, and places the counter on the sum.
4. If the sum is already occupied, the player may spin or roll again.
5. Players take turns until one player has 3 counters in a row.



## Back Over the Bridge 42

42

38	36	34	35	37
34	37	38	33	38
37	36	33	34	36
34	35	37	38	35
33	38	35	36	37

42

**Aim:** Cover three in a row with your counters.

**Materials:** Board game, two kinds of counters, cube or spinner 4-9

**How to play:**

1. Player one rolls or spins to determine the amount to subtract from 42.
2. Player says the subtraction number sentence and places the counter on the answer.

Get player to draw out the answer on an ENL

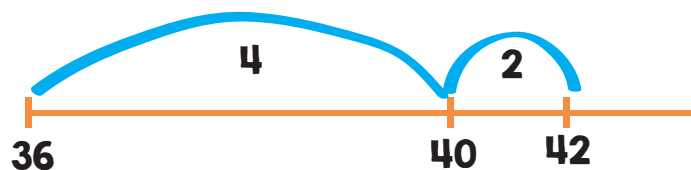

3. The next player rolls or spins, subtracts, and places the counter on the answer.
4. Players take turns until one player has 3 counters in a row.



# TUTU Adding Bridges

50	71	61	73	94
82	62	85	83	52
71	61	73	94	82
62	85	83	50	71
61	73	94	82	62

**Aim: Cover three in a row with your counters.**

**Materials:** Board game: Two kinds of counters or dry white markers and two blank dice.

Mark Dice 1 ( 27, 48, 39, 27, 48, 39 )

Mark Dice 2 ( 23, 46, 34, 23, 46, 34 )

**How to play:**

1. Player one rolls Dice 1 and Dice 2 eg. 48 & 34..

2. Player 1 works out answer using an ENL.

Get player to draw out the answer on an ENL

E.g.  $48 + 34$



Refer to page 9 for other typical strategies

3. Player 1 covers number 82 on the board.

4. Player 2 takes a turn and repeats.

5. Players take turns until one player has 3 counters in a row Horizontally, Vertically or Diagonally.

# TUTU Takeaways

54	39	48	16	45
27	54	39	48	16
45	27	54	39	48
16	45	27	54	39
48	16	45	27	54

# 72

# 72

**Aim: Cover three in a row with your counters.**

**Materials:** Board game: Two kinds of counters or dry white markers and one blank dice.

Mark Dice ( 24, 33, 45, 56, 18, 27 )

**How to play:**

1. Player 1 rolls Dice and takes away from 72.

2. Player 1 works out answer using an ENL.

Get player to draw out the answer on an ENL

E.g.  $72 - 45$



Refer to page 9 for other typical strategies except this time subtract instead of add.

3. Player 1 covers number 27 on the board.

4. Player 2 takes a turn and repeats.

5. Players take turns until one player has 3 counters in a row Horizontally, Vertically or Diagonally.

# 72



## A Bunch of 5's

35	15	30	0	25
10	40	5	35	45
25	45	20	40	15
30	10	45	20	40
20	35	15	30	25

**How play:** (Use a 0-9 spinner or number generator).

1. Multiply the number you roll or spin by 5. Use a marker to cover that number.
2. Winner is the player who covers 3 in a row.



# Useful Websites/Links

Website Address	Details
<a href="http://nlvm.usu.edu/en/nav/vlibrary.html">http://nlvm.usu.edu/en/nav/vlibrary.html</a>	Go to PreK2 Base Blocks Base Blocks Addition Base Blocks Subtraction
<a href="http://www.topmarks.co.uk">www.topmarks.co.uk</a>	Go to Whiteboard Resources Go to Maths KSI - loads of activities in all areas of maths OR Go to Parents Resources
<a href="http://www.clounagh.org">www.clounagh.org</a>	
<a href="http://www.ictgames.com">www.ictgames.com</a>	
<a href="http://www.mathsisfun.co.uk">www.mathsisfun.co.uk</a>	
<a href="http://www.counton.org">www.counton.org</a>	
<a href="http://www.mad4maths.com">www.mad4maths.com</a>	
Google oswego maths - OCSD Maths	Dog bone
<a href="http://www.taw.org">www.taw.org</a> (Interactive Teaching Programme)	Place Value Number Grid
Google nruhmaths	Problem solving Trial/Improvement etc.

## Games

- Jigsaws (number)
- Interactive jigsaws in Top marks
- Go to - Parents
- Go to - Maths Games
- Playing Cards
- Money Games
- Ludo
- Snakes/Ladders
- Connect 4
- Dominoes
- Draughts
- Simple Sudoku

## Helping out at Home

### Out and About

- Plan your trip around the shops
- Recognising new coins 20p, 50p, £1, £2
- Change from 10p, 20p, 50p, £1 - adding/ subtracting
- Exchanging coins for least amount
- Sequence shopping from lightest to heaviest



### In the Kitchen

- Read analogue/digital clock
- Sharing out dinner (e.g. pizzas etc)/fractions
- Reading scales on kettle, weighing scales -working out how much to fill, get to 1kg etc
- Non uniform measuring - Baking: how many spoonfuls of flour weigh 100g etc.



### Around the House

- Talk about different shapes, squares, rectangles, triangles, circles etc.
- Estimate lengths, widths, heights etc.

Other useful materials , activities and games can be found on [www.clounagh.org](http://www.clounagh.org) and Developing Number Knowledge (Sage publications).

Timothy Doyle | NUMERACY/MATHS CONSULTANT | 078 0816 0443  
[www.mathsimprovementni.co.uk](http://www.mathsimprovementni.co.uk) | [timothy@mathsimprovementni.co.uk](mailto:timothy@mathsimprovementni.co.uk)