

# Essentials

DENTAL 2019/20

[www.ustomed.de](http://www.ustomed.de)

High-Quality Dental and Surgical Instruments  
for Dentists, Oral-Maxillofacial Surgeons,  
Implantologists, Periodontists and Orthodontists.



Competence in Instruments  
MADE IN GERMANY



Skilled and experienced surgical  
mechanics create top-quality instruments

# MADE BY HAND

Technical Competence  
with a long Family Tradition

Using selected raw materials and highly advanced machinery

# FOR USE BY HAND

Quality that you can see and feel

Many different instruments developed in close collaboration with  
internationally renowned universities and opinion leaders



Member of the German Dental Manu-  
facturers (VDDI)



Certified by DQS according to:  
DIN EN ISO 13485  
MDSAP



Competence in Instruments  
MADE IN GERMANY





!

### USTOMED:

Dental Instruments from Tuttlingen, the world-wide most important cluster for medical technology. USTOMED develops, designs, produces and distributes instruments for Dentists and , Oral-Maxillofacial Surgeons.

### Keeping up -to-date:

A vast network and cooperations with internationally-known operators, universities and Key Opinion Leaders enables us to see new methods and standards earlier and react with developing solutions immediately.

You will profit from long-term experiences, excellent customer service and an incredible competence in the fields of instrument maintenance, sterilization and organization.

### 3 Great Reasons

USTOMED Instruments was founded over 45 years ago.!

Our portfolio contains over **2.500 Products** for different fields in dentistry.

We have already equipped over **3.500 dental offices** world-wide!







USTOMED - CATERING & LOBBY



USTOMED - EDUCATION



# ADVANCED-EDUCATION-OFFICE

The affiliated dental office, focusing on Implantology and Periodontology, enables the perfect symbiosis of research, advanced education and the practical development of products. In cooperation with well-known international opinion leaders and implant companies, numerous training events are held every year.



01	<i>SCALPELS AND PERIOTOMES</i>	P.	7-10
02	<i>SCISSORS</i>	P.	11-18
03	<i>MICRO-INSTRUMENTS</i>	P.	19-28
04	<i>TWEEZERS</i>	P.	29-36
03	<i>NEEDLE HOLDERS</i>	P.	37-46
06	<i>WOUND AND CHEEK RETRACTORS</i>	P.	47-58
07	<i>ELEVATORS</i>	P.	59-62
08	<i>SUCTION TUBES AND MEASURING INSTRUMENTS</i>	P.	63-66
09	<i>SINUS CURETTES</i>	P.	67-70
10	<i>AUGMENTATION</i>	P.	71-96
11	<i>ROOT ELEVATORS, LUXATORS AND DESMOTOMES</i>	P.	97-104
12	<i>CONTAINER SYSTEMS AND WASH TRAYS</i>	P.	105-111



# 01

## SCALPELS AND PERIOTOMES

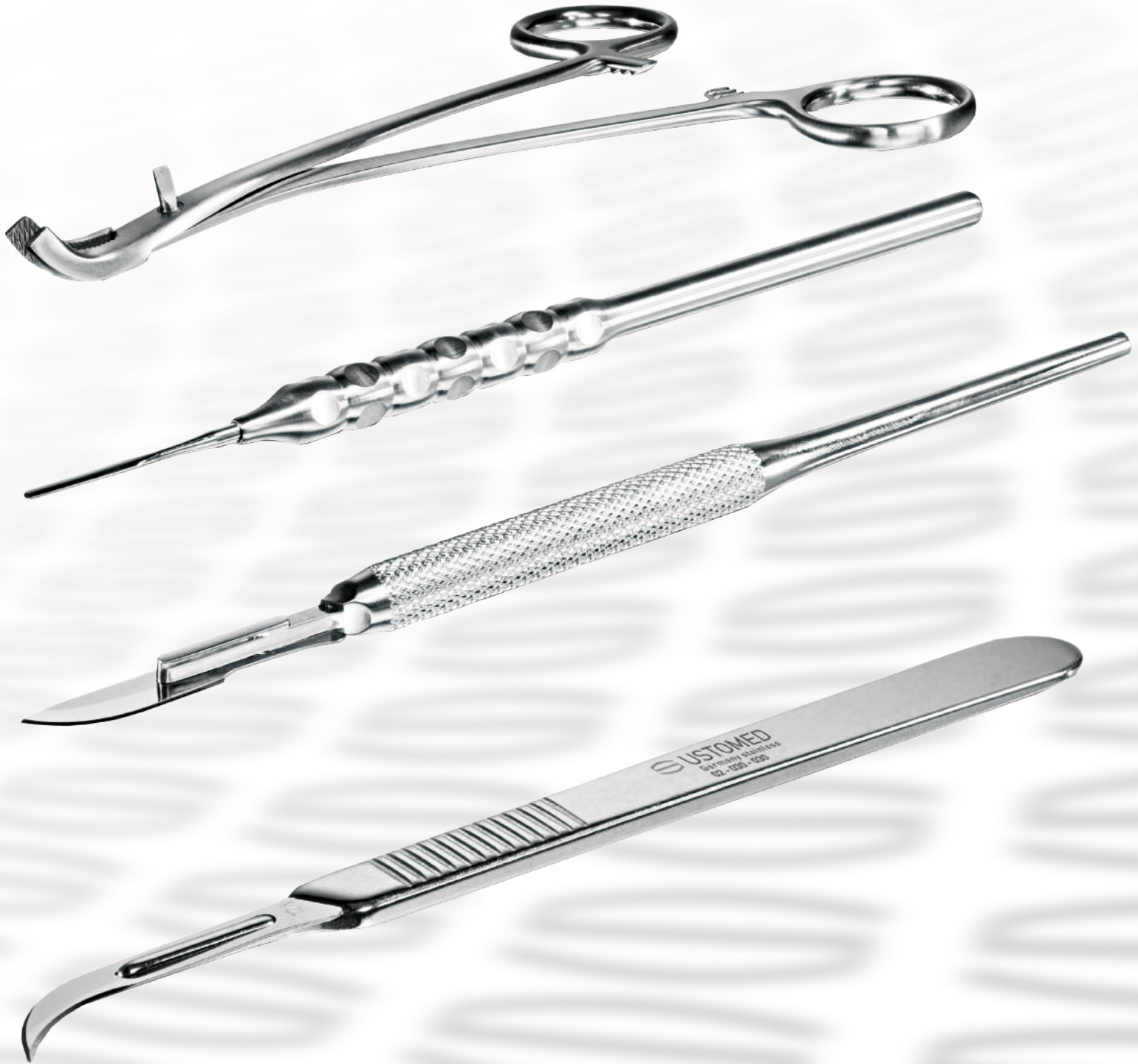

# 01

## Scalpels and Periotomes

**INFO:**

Also available with  
a smooth handle  
02-030-150 G



1/1

**02-030-030**

Blade Holder, No. 3

125mm



1/1

**02-030-150**

Blade Holder, round-shaped

150mm



**02-040-010**

Scalpel Blades Fig. 10  
sterile, 100 pcs.



**02-040-011**

Scalpel Blades Fig. 11  
sterile, 100 pcs.



**02-040-012**

Skalpellklingen Fig. 12  
Steril, 100 Stck.



**02-040-015**

Scalpel Blades Fig. 15  
sterile, 100 pcs.



**02-040-124**

Scalpel Blades Fig. 12d  
sterile, 100 pcs.



**02-040-153**

Scalpel Blades Fig. 15c  
sterile, 100 pcs.



**INFO:**  
for standard blades



1/1

**85-817-360**

Universal-Blade Holder,  
turnable  
165mm



1/1

**02-038-140**

Micro-Blade holder,  
ergon. grip  
140mm



**02-044-063**

Micro-Blades  
Fig. 63  
sterile, 25 pcs.



**02-044-067**

Micro-Blades  
Fig. 67  
sterile, 25 pcs.



**02-044-069**

Micro-Blades  
Fig. 69  
sterile, 25 pcs.



**02-042-069**

Super-Micro-Blades  
Fig. 69, bendable  
sterile, 6 pcs.

# 01

## Scalpels and Periotomes



02-790-000

Periotome, Fig. 1, complete

170mm



02-791-000

Periotome, Fig. 2, complete

140mm



02-790-001

Periotome Blade, only  
Fig. 1, straight



02-791-001

Periotome Blade, only  
Fig. 2, angled



# 02

## SCISSORS



# 02 Scissors

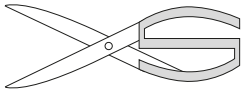

## STANDARD:

Standard Cut

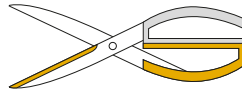

## SUPERCUT (SC):

Special Cut with toothing in one scissor blade in order to prevent sliding of gum and suture material

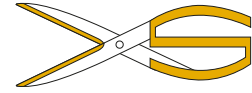

## TUNGSTEN CARBIDE (TC):

Special Hard-Metal Inlays increasing life time and sharpness, of the Instrument



1/1

**METZENBAUM**  
dissect. Scissors, straight



1/1

**METZENBAUM DELICAT**  
dissect. Scissors, straight



1/1

**REYNOLDS**  
dissect. Scissors, curved



03-070-145  
145mm Standard



03-070-145 SC  
145mm Supercut



04-320-145  
145mm TC



03-080-145  
145mm Standard



03-080-145 SC  
145mm Supercut



04-322-145  
145mm TC



03-155-145  
145mm Standard



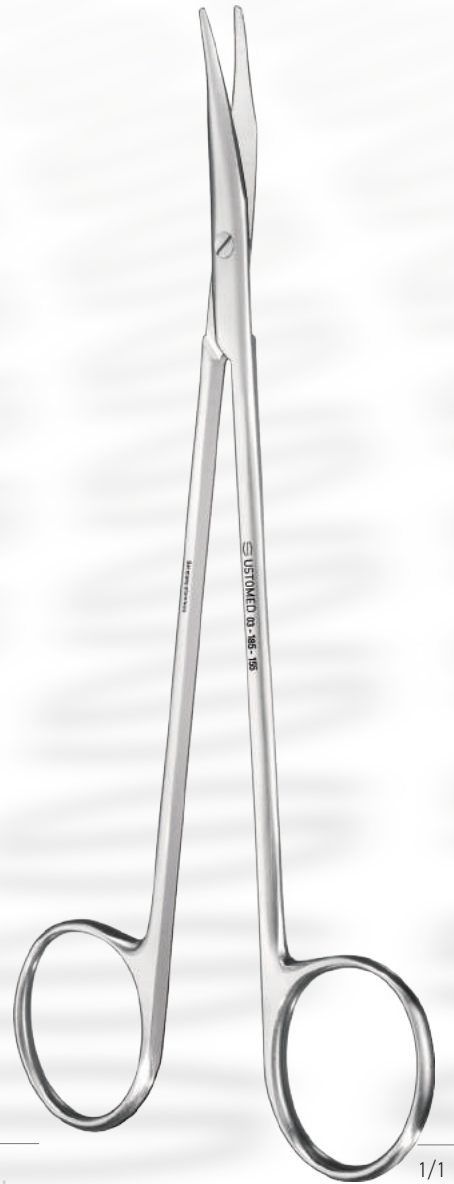



**METZENBAUM**  
dissect. Scissors, curved

**METZENBAUM DELICAT**  
dissect. Scissors, curved

**JAMESON**  
dissect. Scissors, curved

 03-071-145  
145mm Standard

 03-081-145  
145mm Standard

 03-185-155  
155mm Standard

 03-071-145 SC  
145mm Supercut

 03-081-145 SC  
145mm Supercut

 04-325-145  
145mm TC

 04-327-145  
145mm TC

# 02

## Scissors



1/1

*KELLY*  
Gum and Suture Scissors



03-630-160  
160mm, straight.



03-630-180  
180mm, straight.



1/1

*KELLY*  
Gum and Suture Scissors



03-631-160  
160mm, curved



03-631-160 SC  
160mm, curved, Supercut



1/1

*KELLY*  
Gum and Suture Scissors



03-631-180  
180mm, curved



03-631-180 SC  
180mm, curved, Supercut





1/1

*JOSEPH*  
Gum and Suture Scissors

 03-440-140  
140mm, straight.

 03-440-140 SC  
140mm, straight, Supercut



1/1

*JOSEPH*  
Gum and Suture Scissors

 03-441-140  
140mm, curved

 03-441-140 SC  
140mm, curved, Supercut



1/1

*JOSEPH*  
Gum and Suture Scissors

 04-441-140  
140mm, curved, TC

 04-440-140  
140mm, straight, TC

# 02 Scissors

**INFO:**

The fine tips give these scissor blades a very slender shape and allow an optimal view of the operating environment. The toothed cutting blades are particular suitable for cutting sutures.

extra large rings





**Fox**  
Gum and Suture Scissors

**Fox**  
Gum and Suture Scissors

Gum and Suture Scissors

 03-420-130  
130mm, smooth, straight.

 03-421-130  
130mm, smooth, curved.

 03-327-130  
130mm, curved.

 03-412-130  
130mm, toothed, straight.

 03-417-130  
130mm, toothed, curved.

 03-327-130 SC  
130mm, curved., Supercut

 04-420-130  
130mm, straight., TC



 03-417-130 SC  
130mm, curved, Supercut.

 04-421-130  
130mm, curved., TC





*LA GRANGE*  
Gum and Suture Scissors

-  03-401-105  
115mm
-  03-401-105 SC  
115mm, Supercut



Gum and Suture Scissors

-  03-320-115  
115mm, straight
-  03-320-115 SC  
115mm, straight, Supercut
-  04-520-115  
115mm, straight, TC



Gum and Suture Scissors

-  03-321-115  
115mm, curved
-  03-321-115 SC  
115mm, curved, Supercut
-  04-521-115  
115mm, curved, TC

# 02 Scissors



*SPENCER*  
Ligature Scissors

 03-720-090  
90mm

 03-720-130  
130mm



*BEEBEE*  
Wire/Plate Scissors

 03-744-105  
105mm, straight, sharp tip

 03-746-105  
105mm, straight, toothed

 03-748-105  
105mm, straight, blunt tip



*BEEBEE*  
Wire/Plate Scissors

 03-745-105  
105mm, curved, sharp tip

 03-747-105  
105mm, curved, toothed

 03-749-105  
105mm, curved, blunt tip.



# 03

## MICRO-INSTRUMENTS



# 03

## Micro-Instruments

**INFO:**

The round-shaped handle enables a much easier twisting of the instrument in the hand.



1/1

**WESTCOTT**  
Gum Scissors

05-045-115  
115mm, curved

05-149-110  
110mm, sharp tip

05-151-110  
110mm, blunt tip



1/1

**USTOMED**  
Gum and Sture Scissors

05-621-145  
145mm, straight, sharp tip



1/1

**BARRQUER**  
Micro-Scissors

05-809-145  
145mm, curved, round handles

05-809-180  
180mm, curved, round handles





**INFO:**  
 The very slim and curved cutting edges are particularly well suited for the de-epithelialization and connective-tissue corrections.



**INFO:**  
 The additionally rounded Cooley grip enables a very atraumatic holding of the tissue.



**INFO:**  
 The ultra-fine diamond-coated tips enables a pinpoint thread of the suture needles.  
 Ideal for suture material from 5.0-8.0.  
 The specially-rounded edges of the tips prevent suture materials from tearing at the knot.

USTOMED I'MOTION  
 Micro-Scissors

05-803-180  
 180mm

USTOMED I'MOTION  
 Micro-Tweezers

09-280-180  
 180mm, straight,  
 Cooley-grip

 USTOMED I'MOTION  
 Micro-Needle Holder

20-752-180  
 180mm, straight, diamond-  
 coated tips  
 20-753-180  
 180mm, curved, diamond-  
 coated tips

# 03

## Micro-Instruments



straight



curved



CASTROVIEJO  
Micro-Needle Holder TC

20-680-180  
180mm, straight

20-681-180  
180mm, curved



CASTROVIEJO  
Micro-Needle Holder TC

20-680-140  
140mm, straight

20-681-140  
140mm, curved





straight

1/1



curved

1/1



straight

1/1



**CASTROVIEJO**  
Micro-Needle Holder TC

- 20-722-130  
130mm
- 20-722-160  
160mm
- 20-722-180  
180mm



**BARRAQUER**  
Micro-Needle Holder TC

- 20-710-140  
140mm, straight
- 20-711-140  
140mm, curved



**BARRAQUER**  
Micro-Needle Holder TC

- 20-710-180  
180mm, straight
- 20-711-180  
180mm, curved

# 03

## Micro-Instruments



**INFO:**  
Perfect for holding suture materials

1/1



curved version  
09-267-180

1/1



highly magnified

1/1



**USTOMED**  
Micro-Tweezers

09-230-180  
anatomical,  
diamond-coated  
180mm

**USTOMED**  
Micro-Tweezers

09-265-180  
surgical  
180mm

**DeBAKEY**  
Micro-Tweezers

09-270-180  
atraumatic  
180mm



**CARBON-COATING**  
 The special plasma-carbon coating increases the surface-durability of the working tips and ensures a glare-free work under the microscope.

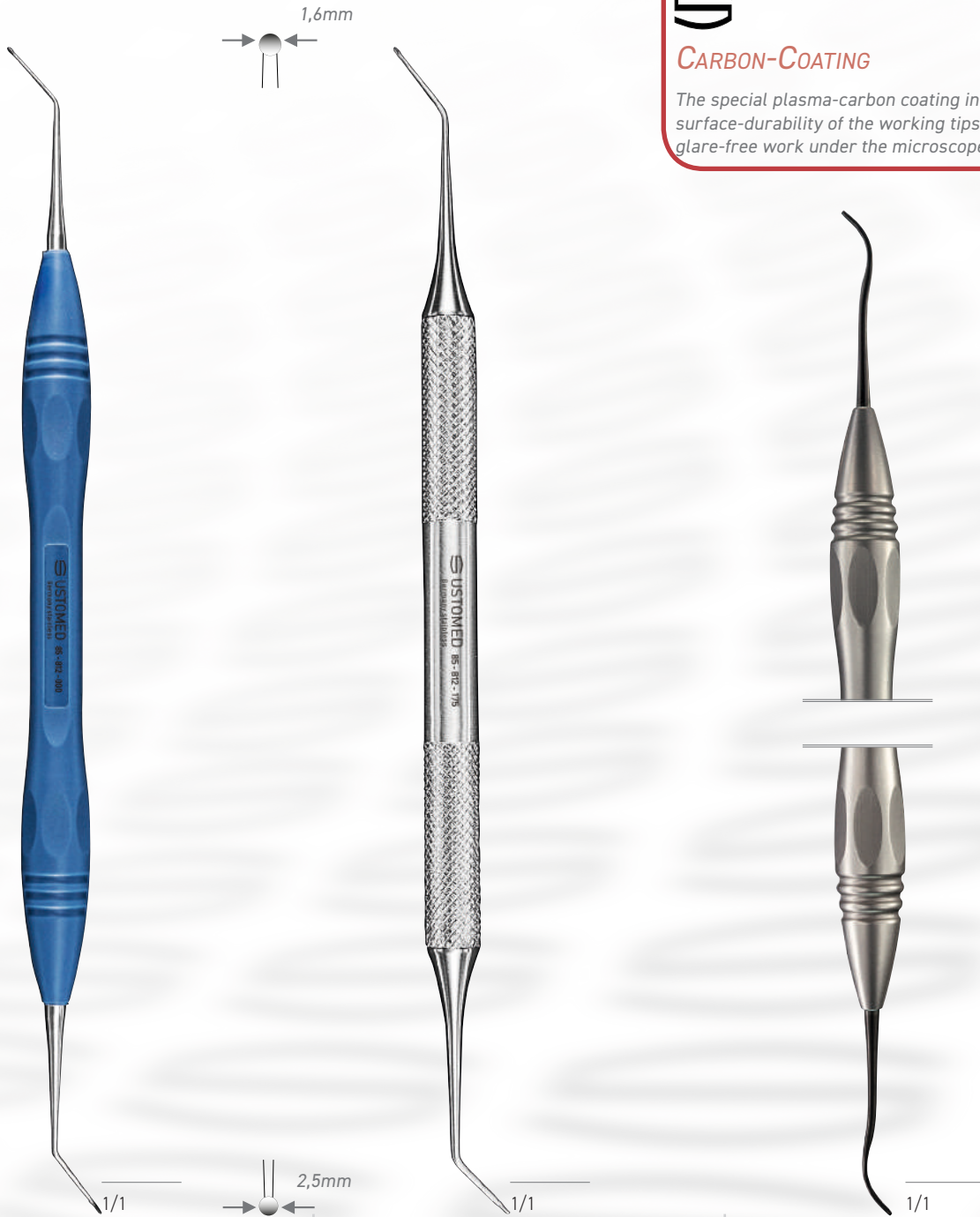

*USTO-SOFT GRIFF*  
 Papillae Elevator

85-812-000  
 atraumatic  
 175mm

*USTOMED*  
 Papillae Elevator

85-812-175  
 atraumatic  
 175mm

*ZUCHELLI*  
 Papillae Elevator

85-814-175  
 175mm

# 03

## Micro-Instruments



*NORTH-CAROLINA*  
Perio Probe  
85-691-115  
CP15, Probe  
190mm



*USTO-SOFT GRIIP*  
Perio Dissector  
85-808-000  
Mod.W.  
185mm



*USTOMED*  
Perio Dissector  
85-808-175  
Mod.W.  
170mm





 **KASAJ**  
Tunneling Knife.  
85-818-001  
200mm



 **KASAJ**  
Tunneling Knife.  
85-818-002  
190mm



 **MODELL-B.**  
Tunneling Knife.  
85-816-170  
Micro B.  
170mm

# 03

## Micro-Instruments



1/1

*USTO-SOFT GRIP*  
Raspatory

85-816-000

Mod.B.

175mm



1/1

*USTOMED*  
Raspatory

85-816-175

Mod.B.

175mm



1/1

*USTOMED*  
Tunneling Knife

85-818-175

175mm



# 04

## TWEEZERS



# 04

## Tweezers



*USTOMED*  
Anatomical Tweezers

08-036-145  
130mm

08-036-160  
160mm

08-036-180  
180mm



*GERALD*  
Anatomical Tweezers

08-100-175  
175mm



*GERALD*  
Anatomical Tweezers

08-103-175  
175mm





1/1

COLLEGE Anatomical Tweezers

- 10-825-150  
130mm
- 10-825-160  
160mm
- 10-825-180  
180mm



diamond-coated

1/1



COLLEGE Anatomical Tweezers

- 10-827-150  
150mm, diamond-coated

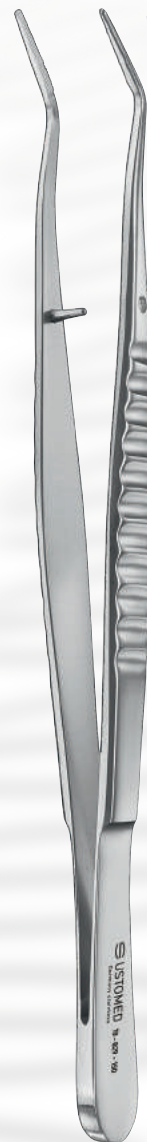

with contra angle

1/1

COLLEGE Anatomical Tweezers

- 10-829-150  
150mm, with contra angle

# 04

## Tweezers



1/1

*COLLEGE*  
Tweezers

10-801-150  
150mm, anatomical

10-803-150  
150mm, plain



1/1

*MERIAM*  
Tweezers

10-841-160  
160mm, grooved

10-843-160  
160mm plain



1/1

*MERIAM*  
Tweezers

10-845-155  
155mm, modified





**FLAGG**  
Tweezers

10-831-160  
160mm, grooved

10-833-160  
160mm, plain



**GERALD**  
Surgical Tweezers

08-301-175  
175mm, straight

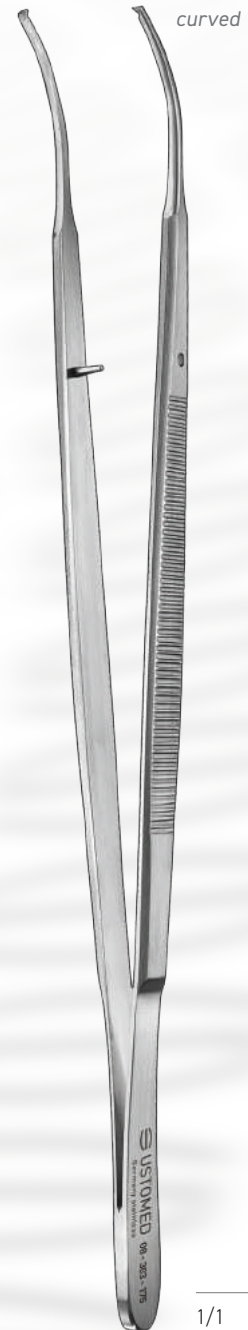

**GERALD**  
Surgical Tweezers

08-303-175  
175mm, curved

# 04

## Tweezers



1/1

### Surgical Tweezers

08-235-145  
145mm, delicate

08-235-160  
160mm, delicate

08-235-180  
180mm, delicate



1/1

### ADSON Tweezers

08-060-120  
120mm, anatomical

08-261-120  
120mm, surgical



1/1

### USTOMED I'MOTION COOLEY Micro-Tweezers

09-280-180  
180mm, atraumatic,  
Cooley-grip

#### INFO

More Details on page 21..





**INFO:**  
Perfect for holding suture materials

1/1



curved version possible:

1/1



highly magnified

1/1



**USTOMED**  
Micro-Tweezers

09-230-180  
180mm, anatomical,  
diamond-coated

**USTOMED**  
Micro-Tweezers

09-265-180  
180mm, surgical, straight

09-267-180  
180mm, surgical, curved

**DeBAKEY**  
Micro-Tweezers

09-270-180  
180mm, atraumatic

# 04

## Tweezers

Photo Copyright Dr. Ponte

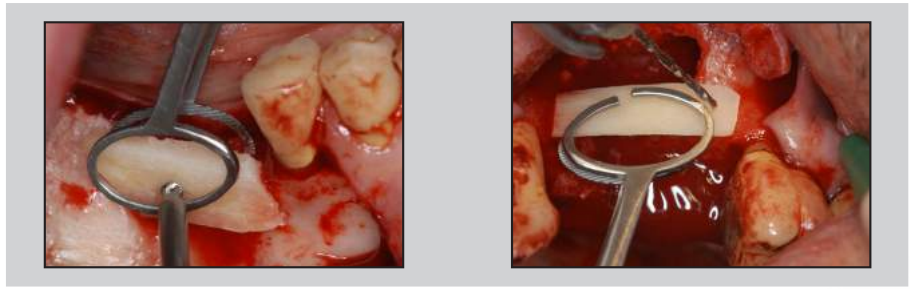

1/1

*Graft Tweezers*  
with opening for sutures

10-871-160  
160mm



1/1

*PONTÉ*  
Bone Block Tweezers

10-875-160  
160mm  
standard



1/1

*PONTÉ*  
Bone Block Tweezers

10-877-160  
180mm  
small



# 05

## NEEDLE HOLDERS



# 05

## Needle Holders

### INFO

Overview on suture material sizes per Needle Holder on page 46.



 **HALSEY**  
Needle Holder TC

20-120-130  
130mm

 **BABY-CRILE-WOOD**  
Needle Holder TC

20-160-150  
150mm





 **CRILE-WOOD**  
Needle Holder TC

20-164-150  
150mm

20-164-180  
180mm

20-164-205  
205mm

# 05

## Needle Holders



1/1



1/1



*MAYO-HEGAR*  
Needle Holder TC

20-220-160  
160mm

20-220-180  
180mm

20-220-200  
200mm



*MICRO-RYDER*  
Needle Holder TC

20-320-130  
130mm

20-320-150  
150mm

20-320-180  
180mm





1/1



1/1



**LANGENBECK**  
Nadelhalter HM

20-392-160  
160mm

20-392-180  
180mm

20-392-200  
200mm



**TOENNIS**  
Nadelhalter HM

20-398-180  
180mm

# 05

## Needle Holders



 **MATHIEU**  
Needle Holder TC

20-452-140  
140mm

20-452-170  
170mm

20-452-200  
200mm

 **LICHTENBERG**  
Needle Holder TC

20-470-170  
170mm





**USTOMED I'MOTION**  
Micro-Needle Holder

20-752-180  
180mm, diamond-coated, straight

20-753-180  
180mm, diamond-coated, curved



**CASTROVIEJO**  
Needle Holder TC

20-722-130  
130mm

20-722-160  
160mm

20-722-180  
180mm

# 05

## Needle Holders

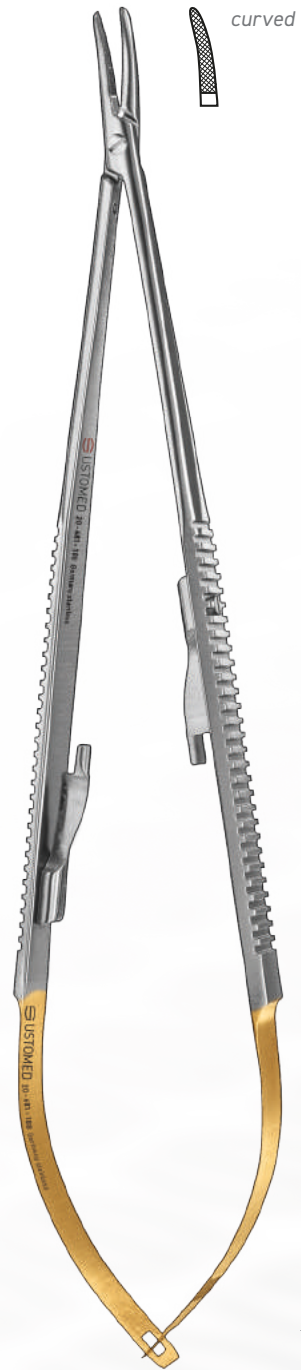

**CASTROVIEJO**  
Micro-Needle Holder TC

20-680-140  
140mm, straight

20-680-180  
180mm, curved



**CASTROVIEJO**  
Micro-Needle Holder TC

20-681-140  
140mm, curved

20-681-180  
180mm, curved





 **BARRAQUER**  
Micro-Needle Holder TC

20-710-140  
140mm, straight

20-710-180  
180mm, curved



 **BARRAQUER**  
Micro-Needle Holder TC

20-711-140  
140mm, curved

20-711-180  
180mm, curved

# 05

## Needle Holders

### Matrix - Needle Holders and Suture Material Sizes:

	3/0	4/0	5/0	6/0	7/0	8/0
20-120-130	✓	✓	✓	✗	✗	✗
20-160-150	✗	✓	✓	✗	✗	✗
20-164-150	✓	✓	✓	✗	✗	✗
20-164-180	✓	✓	✓	✗	✗	✗
20-164-205	✓	✓	✓	✗	✗	✗
20-220-160	✓	✓	✗	✗	✗	✗
20-220-180	✓	✓	✗	✗	✗	✗
20-220-200	✓	✓	✗	✗	✗	✗
20-320-130	✗	✗	✓	✓	✗	✗
20-320-150	✗	✗	✓	✓	✗	✗
20-320-180	✗	✗	✓	✓	✗	✗
20-392-160	✓	✓	✓	✗	✗	✗
20-392-180	✓	✓	✓	✗	✗	✗
20-392-200	✓	✓	✗	✗	✗	✗
20-398-180	✓	✓	✗	✗	✗	✗
20-452-140	✓	✓	✗	✗	✗	✗
20-452-170	✓	✓	✗	✗	✗	✗
20-452-200	✓	✓	✗	✗	✗	✗
20-470-170	✓	✓	✗	✗	✗	✗
20-680-140	✗	✗	✓	✓	✓	✗
20-681-140	✗	✗	✓	✓	✓	✗
20-680-180	✗	✗	✓	✓	✓	✗
20-681-180	✗	✗	✓	✓	✓	✗
20-710-140	✗	✗	✓	✓	✓	✗
20-711-140	✗	✗	✓	✓	✓	✗
20-710-180	✗	✗	✓	✓	✓	✗
20-711-180	✗	✗	✓	✓	✓	✗
20-722-130	✗	✗	✓	✓	✓	✗
20-722-160	✗	✗	✓	✓	✓	✗
20-722-180	✗	✓	✓	✓	✗	✗
20-752-180	✗	✗	✓	✓	✓	✓
20-753-180	✗	✗	✓	✓	✓	✓



# 06

## WOUND AND CHEEK RETRACTORS



# 06

## Wound/Cheek Retractors



*KILNER*  
Tissue Retractor  
24-421-150

150mm



*GILLIES*  
Tissue Retractor  
24-425-001

180mm



*GILLIES*  
Tissue Retractor  
24-425-002

180mm



*GUTHRIE*  
Tissue Retractor  
24-469-002

130mm



*JOSEPH*  
Tissue Retractor  
24-573-002

160mm



7mm  
24-573-007



10mm  
24-573-010



# 06

## Wound/Cheek Retractors



Wound Retractor  
24-021-001  
single tip  
160mm

Wound Retractor  
24-021-002  
dual tip  
160mm

Wound Retractor  
24-023-001  
single tip  
160mm



Wound Retractor  
 24-023-002  
 dual tip  
 160mm



Wound Retractor  
 24-031-002  
 dual tip  
 160mm



Wound Retractor  
 24-033-002  
 dual tip  
 160mm

# 06

## Wound/Cheek Retractors



3/4

*NENTWIG*  
Zygomatic Retractor  
24-191-230

230mm

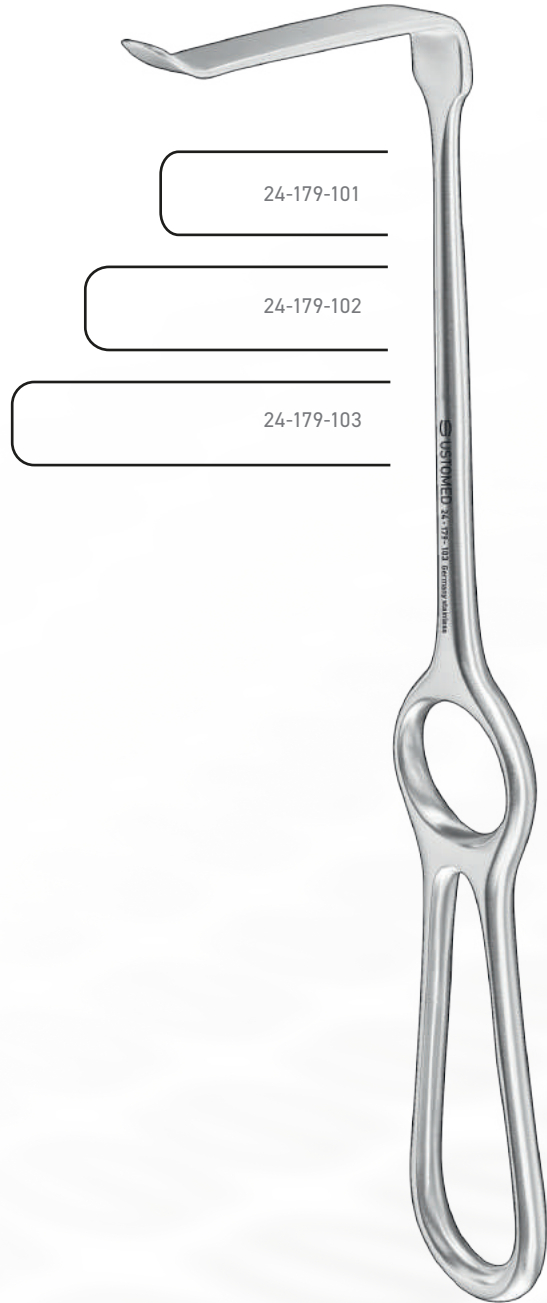

3/4

*KOCHER*  
Wound Retractor

240mm



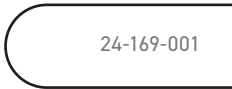

24-169-001



24-169-002



24-169-003



24-169-004



24-169-005

1/1



24-179-000

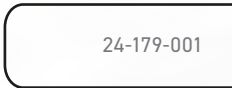

24-179-001



24-179-002

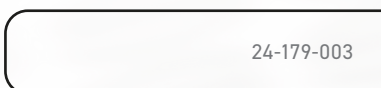

24-179-003

1/1

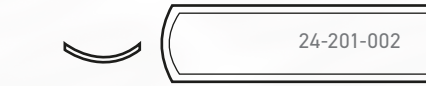

24-201-002

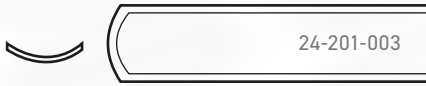

24-201-003

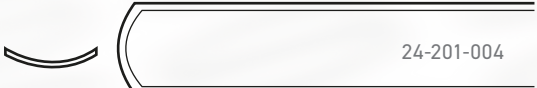

24-201-004

1/1



1/2

LANGENBECK  
Wound Retractor

210mm



1/2

KOCHER  
Wound Retractor

210mm



1/2

OBWEGESER  
Wound Retractor

240mm

# 06

## Wound/Cheek Retractors



Silicone-Mouth Wedge  
for children

48-091-001

Size 1

Silicone-Mouth Wedge  
for adults

48-091-002

Size 2



1/1



for children  
only 48-149-001

1/1



for adults  
only 48-149-002

1/1

*USTOMED*  
Universal Mouth Gag, complete  
48-149-000

130mm



# 06

## Wound/Cheek Retractors



*LASTER*  
Special Wound Retractor  
for upper third molars

---

24-203-105

110mm

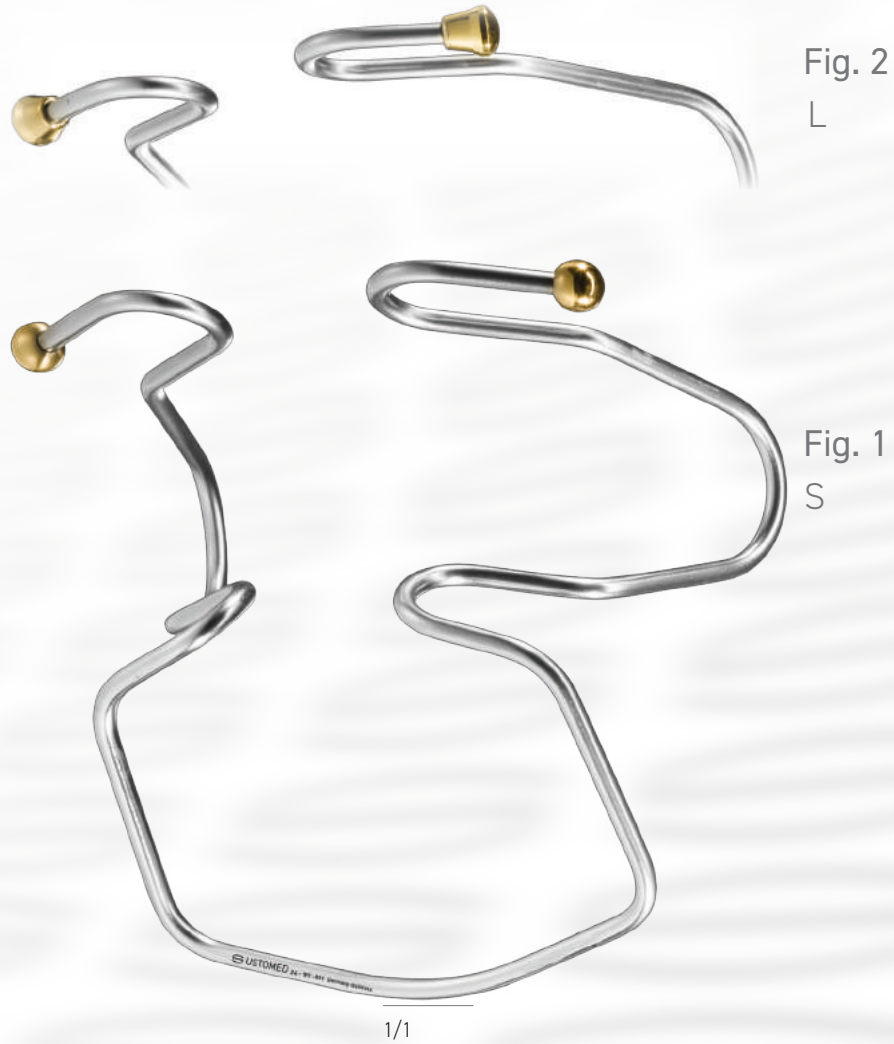

*HILGER*  
Mouth Clamp

24-197-001, Fig. 1  
24-197-002, Fig. 2

# 06

## Wound/Cheek Retractors

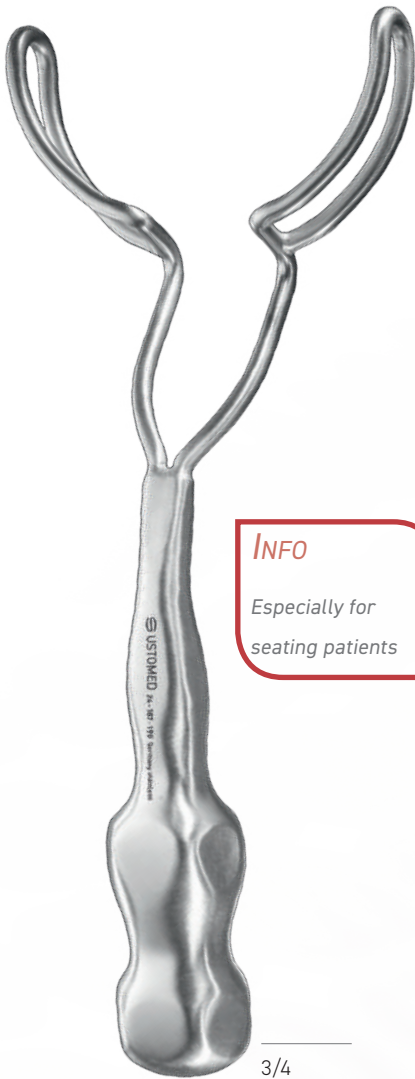
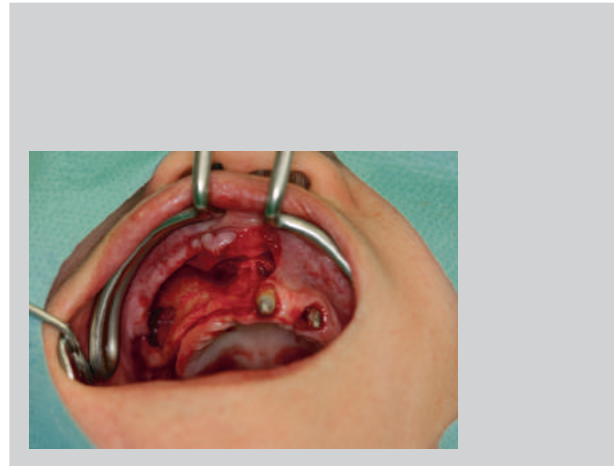

**INFO**  
Especially for  
seating patients

3/4

*USTOMED*  
Universal Vestibule Retractor  
24-187-190  
straight  
190mm

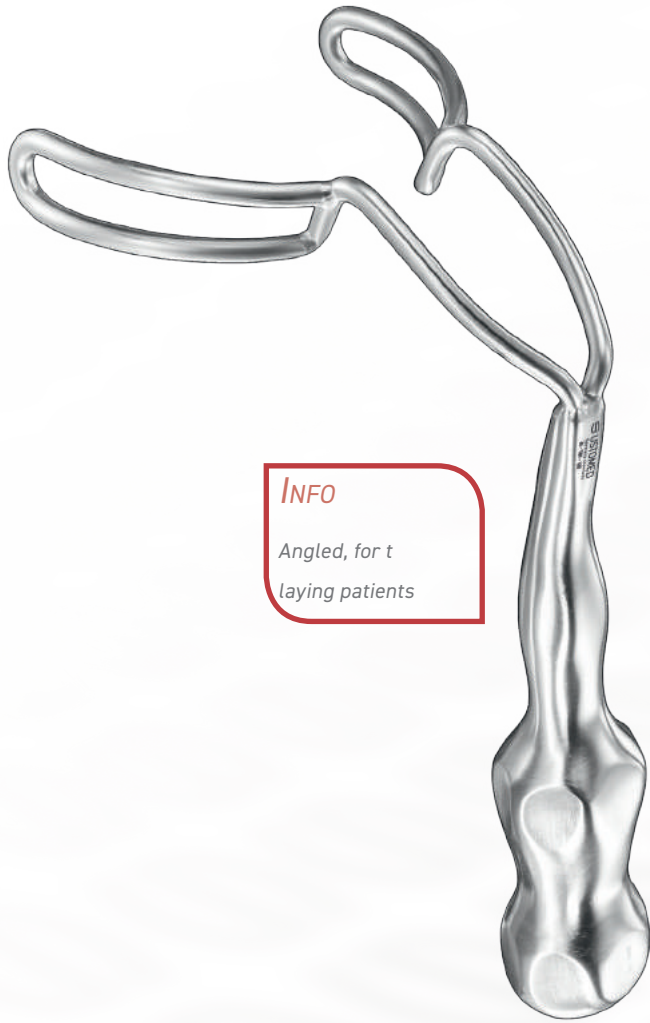

**INFO**  
Angled, for t  
laying patients

3/4

*USTOMED*  
Universal Vestibule Retractor  
24-189-180  
angled  
180mm



# 07

## ELEVATORS AND RASPATORIES



# 07

## Elevators and Raspatories



*FREER*  
Elevator  
27-451-180

180mm



*PRICHARD*  
Raspatory  
27-459-175

175mm



*GLICKMAN*  
Raspatory  
27-711-024

165mm





*USTOMED*  
Raspatory  
27-717-175

175mm



*WILLIGER*  
Raspatory  
27-741-160

160mm



*WILLIGER*  
Raspatory  
27-745-160

160mm



# 07

## Elevators and Raspatories



*WILLIGER*  
Raspatory  
27-743-130

130mm



*OBWEGESER*  
Raspatory  
27-749-006

175mm



7mm  
27-749-007



9mm  
27-749-009



11mm  
27-749-011

# 08

## SUCTION TUBES AND MEASURING INSTRUMENTS



# 08

## Suction Tubes and Measuring Instruments



Filters  
38-505-003  
3 pcs/pack



1/1



Bone Trap  
Stainless Suction Attachment  
38-505-000

110mm



**INFO**  
 Ø 1,5mm inner diameter  
 Ø 2,5mm outer diameter



Suction Tube  
 38-519-015  
 metall  
 180mm

**INFO**  
 with Luer lock

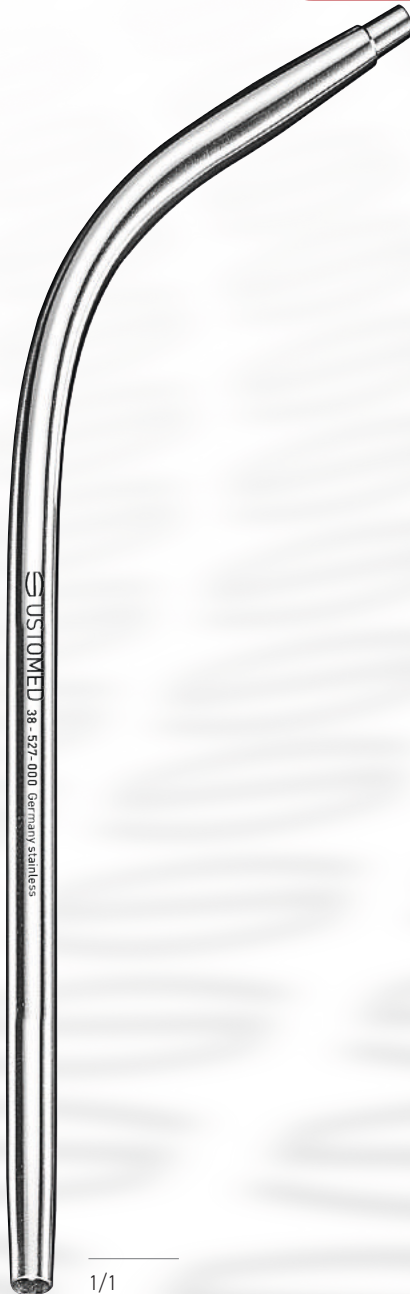

*KHOURY*  
 Suction Tube  
 38-527-000  
 metall  
 170mm

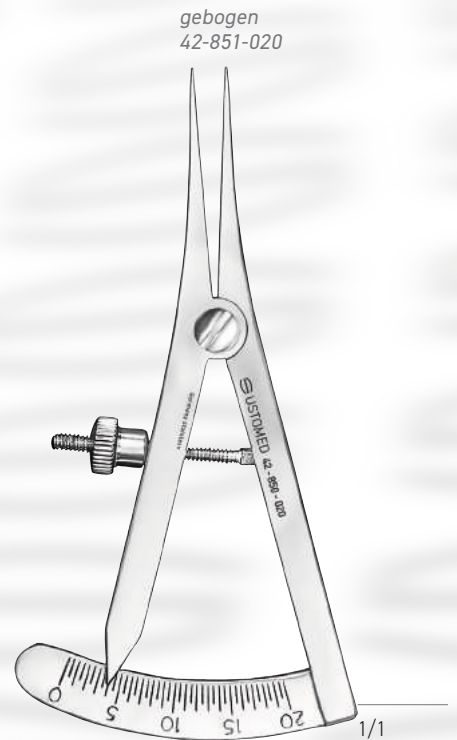

*CASTROVIEJO*  
 Compass  
 42-850-020  
 85mm

*SUCTION TUBE*  
METALL

39-517-002  
180mm, 2mm diameter

39-517-003  
180mm, 3mm diameter

39-517-004  
180mm, 4mm diameter

39-517-005  
180mm, 5mm diameter



09

SINUS CURETTES

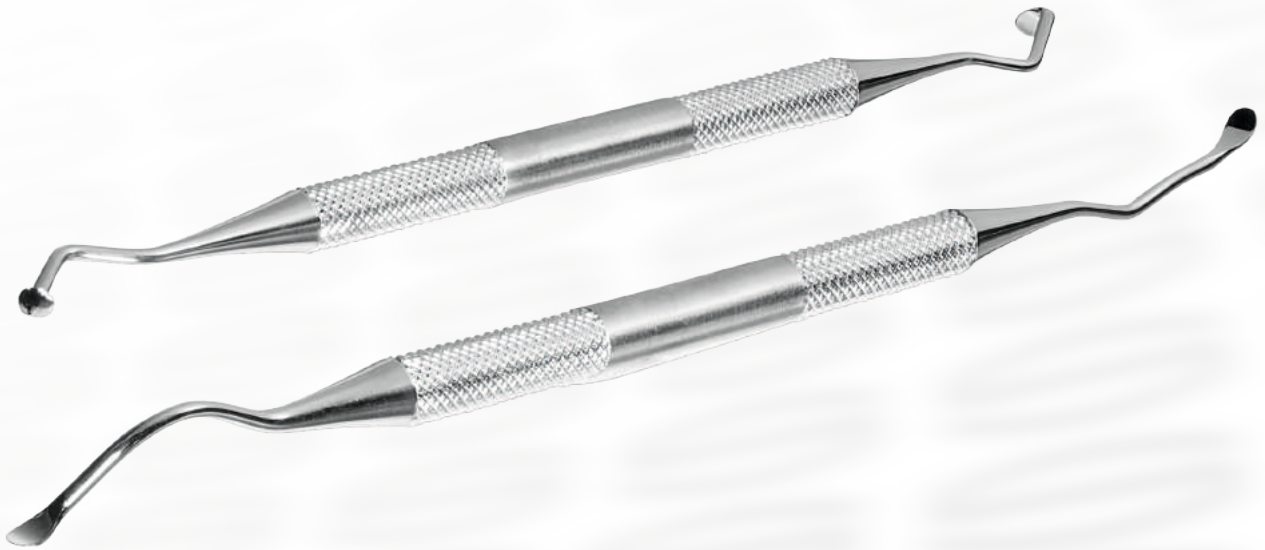



# 09

## Sinus Currettes



1/1

*Hotz*  
Sinus Curette Fig. 1

46-695-001

185mm



1/1

*Hotz*  
Sinus Curette Fig. 2

46-695-002

190mm



1/1

*Khoury*  
Sinus Curette Fig. 3

46-695-003

180mm



*KHOURY*  
Sinus Curette Fig. 4  
46-695-004  
180mm



*HOTZ*  
Sinus Curette Fig. 5  
46-695-005  
205mm



*NENTWIG*  
Sinus Curette Fig. 1  
46-699-001  
Usto-Soft-Grip  
180mm

# 09

## Sinus Currettes



1/1

**NENTWIG**  
Sinus Curette Fig. 2

46-699-002  
Usto-Soft-Grip  
190mm



1/1

**NENTWIG**  
Sinus Curette Fig. 3

46-699-003  
Usto-Soft-Grip  
190mm



1/1

**NENTWIG**  
Sinus Curette Fig. 4

46-699-004  
Usto-Soft-Grip  
190mm



# 10

## AUGMENTATION



# 10

## Augmentation



*MINI-LAMBOTTE*  
Osteotome  
67-554-004 S

130mm



*MINI-LAMBOTTE*  
Osteotome  
67-554-006 S

130mm



*MINI-LAMBOTTE*  
Osteotome  
67-554-008 S

130mm





*MINI-LAMBOTTE*  
Osteotome  
67-555-004 S

130mm

*MINI-LAMBOTTE*  
Osteotome  
67-555-006 S

130mm

*MINI-LAMBOTTE*  
Osteotome  
67-555-008 S  
67-555-010 S

130mm



# 10

## Augmentation

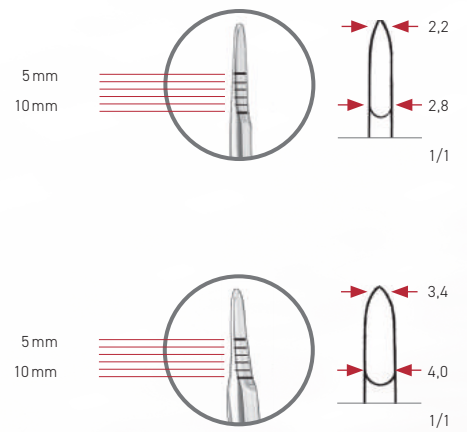
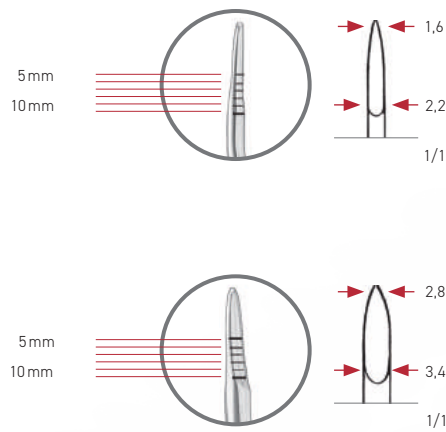

Condensing: preparation of the implant site when bone structure is compromised



*NENTWIG*  
Bone Spreader Set, bayonet  
67-559-444  
Set incl. 4 instruments  
175mm

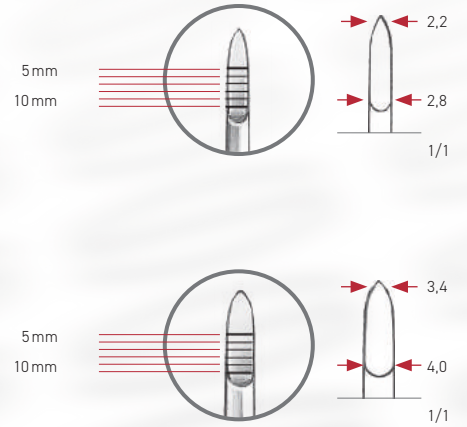
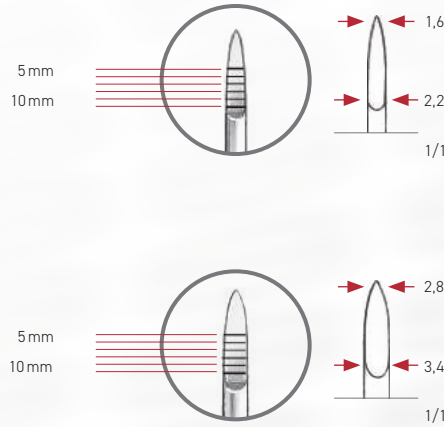

Localized spreading of the narrow ridge



*NENTWIG*  
Bone Spreader Set, straight  
67-558-444  
Set incl. 4 instruments  
175mm

# 10

## Augmentation

**INFO**

exchangeable  
teflon inlays



1/1

Mallet

67-636-210

185mm, 210g



1/1

Mallet

67-660-150

165mm, 150g



1/1

*NENTWIG*  
Mallet

67-638-300

200mm, 240g





1/1

*OMBREDANNE*  
Mallet  
67-670-240

260mm, 720g



Photo Copyright Dr. Ponte



1/1

*USTOMED*  
Bone Squasher  
67-680-000

round

# 10

Augmentation

## USTOMED Bone Mill







Cutting Cylinder S  
67-682-012



Cutting Cylinder M  
67-682-013

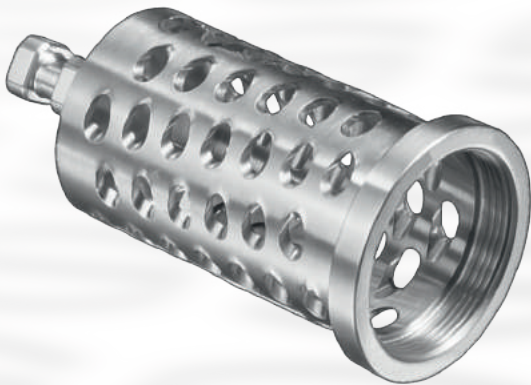

Cutting Cylinder L  
67-682-014



Collection Container  
67-682-020



# 10

## Augmentation



Bone-Grinder Forceps

67-678-170

170mm



*USTOMED*  
Combination Instrument  
67-691-003

200mm



*DEGIDI*  
Plugger  
67-693-012

190mm

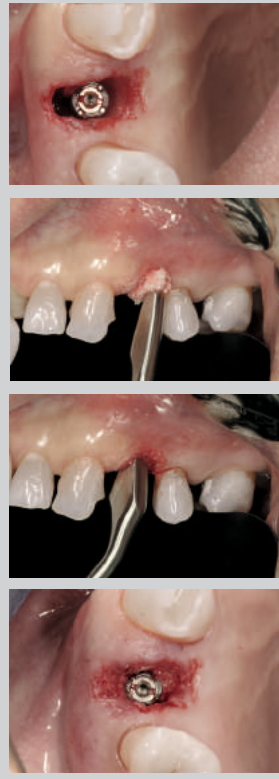

*DEGIDI*  
Plugger  
67-693-034

190mm

# 10

## Augmentation

### Trephine-Burs for Contra-Angle Handpieces

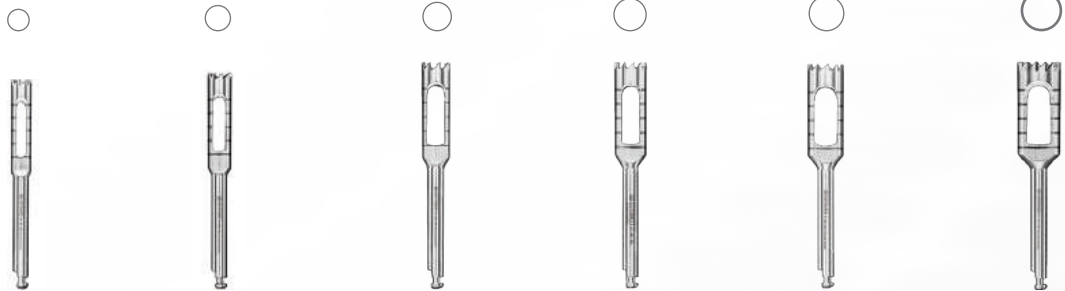
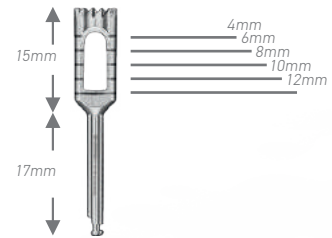

67-890-025    67-890-030    67-890-035    67-890-040    67-890-045    67-890-050

Outer $\varnothing$	3,0	3,5	4,0	4,5	5,0	6,0
Inner $\varnothing$	2,5	3,0	3,5	4,0	4,5	5,0

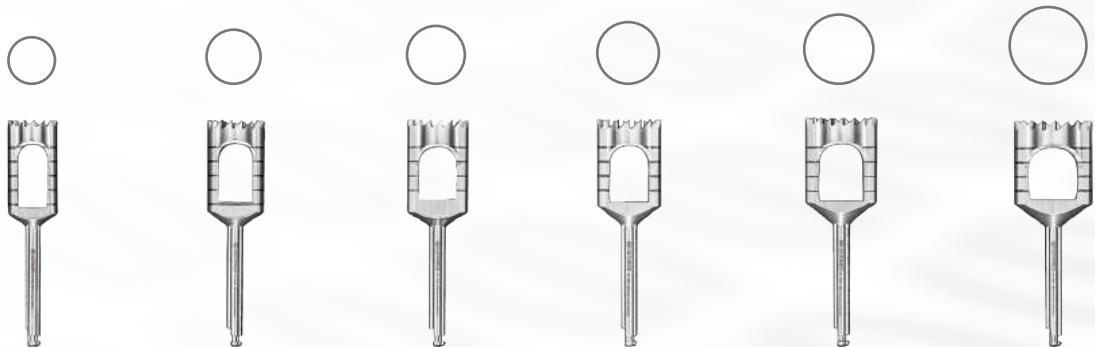

67-890-060    67-890-070    67-890-075    67-890-080    67-890-090    67-890-100

Outer $\varnothing$	7,0	8,0	8,5	9,0	10,0	11,0
Inner $\varnothing$	6,0	7,0	7,5	8,0	9,0	10,0



Trepan-Bohrer für Handstück

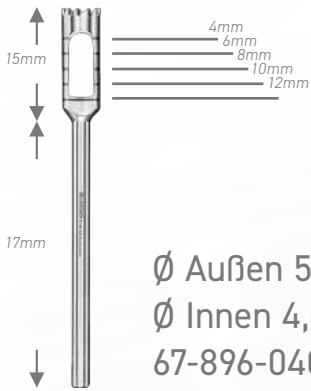

Ø Außen 5,0mm  
 Ø Innen 4,0mm  
 67-896-040



Outer Ø 7,0mm  
 Inner Ø 6,0mm  
 67-896-060



Outer Ø 11,0mm  
 Inner Ø 10,0mm  
 67-896-100

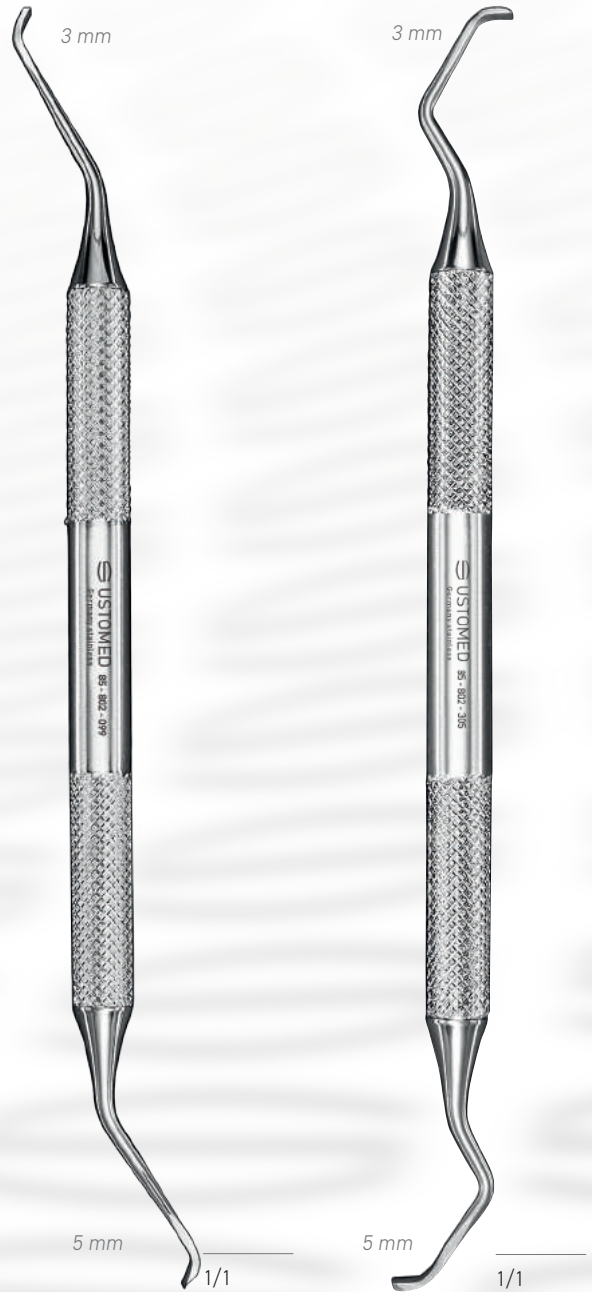

BONE SCRAPER

170mm  
 3mm und 5mm width

85-802-099

85-802-305

# 10

## Augmentation



**MICROSS**  
Bone Scraper  
single-use

85-802-005

160mm

straight

curved



**SAFESCRAPER**  
Bone Scraper  
single-use

85-802-001 straight

85-802-002 curved

150mm

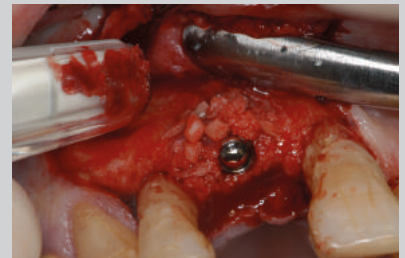
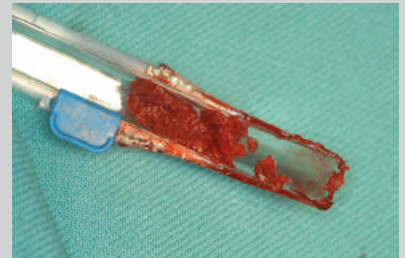
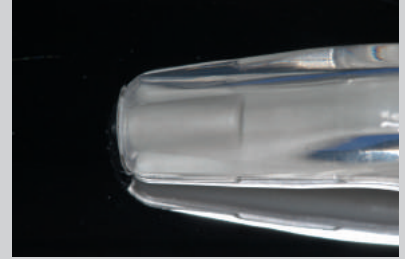

Photos Copyright Dr. Ponte



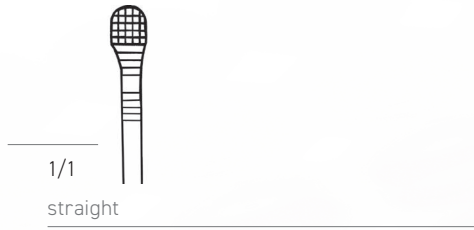

*NENTWIG*  
Bone-Fixation Forceps  
31-196-000

130mm





# USTOMED Titan-Pin-Set



## Titan-Pins



## Applicator

- Single-piece instruments to collect the pins from the holding tray therefore the twisting of the working tip during the operation is excluded.
- Very ergonomical and comfortable Grip for a safe operation of the Titan-Pins



## Holding Tray

- Functional Design
- safe and easy to operate with single hand principle
- Box can contain up to 15 Titan-Pins

## USTOMED Titan-Pin-Set

Titan-Pins for the fixation of membranes.



Pin-Set complete  
68-780-018

### USTOMED T-Fix Micro-Membrane-Screws

68-115-004 (pack of 10pcs.)

4mm length, 1,5mm diameter, conical thread,  
self-drilling, self-cutting

possible collection box for screws (68-720-002)



3/1



# 10

Augmentation

## USTOMED Bone-Fixation Set





**Contents:****68-780-016****Bone-Fixation Set -TITAN-:**

68-720-002	Box for Micro-Screws and Accessories
68-740-002	Screw Driver, 11cm
68-760-102	Blade, cross, self-retaining, 60 mm
*	1x Pilot Bur $\varnothing$ 1,0mm or $\varnothing$ 1,2mm
*	1x Pack Titanium-Micro-Screws of choice

**68-780-010****Bone-Fixation Set -STEEL-:**

68-720-002	Box for Micro-Screws and Accessories
68-740-002	Screw Driver, 11cm
68-508-014	1x Pilot Bur $\varnothing$ 0,8mm
*	1x Pack Steel-Micro-Screws of choice

**Micro Screws (10 pcs. per Pack):**

68-112-006	Titanium, $\varnothing$ 1,2mm, 6mm lenght, cross
68-112-008	Titanium, $\varnothing$ 1,2mm, 8mm lenght, cross
68-112-011	Titanium, $\varnothing$ 1,2mm, 11mm lenght, cross
68-112-013	Titanium, $\varnothing$ 1,2mm, 13mm lenght, cross
68-114-006	Titanium, $\varnothing$ 1,4mm, 6mm lenght, cross
68-114-008	Titanium, $\varnothing$ 1,4mm, 8mm lenght, cross
68-114-011	Titanium, $\varnothing$ 1,4mm, 11mm lenght, cross
68-114-013	Titanium, $\varnothing$ 1,4mm, 13mm lenght, cross
68-110-008 S	Implant-Steel Alloy, $\varnothing$ 1,0mm, 8mm lenght, cross
68-110-011 S	Implant-Steel Alloy, $\varnothing$ 1,0mm, 11mm lenght, cross
68-110-013 S	Implant-Steel Alloy, $\varnothing$ 1,0mm, 13mm lenght, cross
68-115-004	Titanium, Membrane Screws $\varnothing$ 1,5mm, 4mm lenght, conical threat, self-drilling, self-cutting

**Pilot Burs:**

68-508-014	$\varnothing$ 0,8mm, 14mm lenght, for $\varnothing$ 1,0mm screws, with depth scale
68-510-014	$\varnothing$ 1,0mm, 14mm lenght, for $\varnothing$ 1,2mm screws, with depth scale
68-512-014	$\varnothing$ 1,2mm, 14mm lenght, for $\varnothing$ 1,4mm screws, with depth scale
68-514-014	$\varnothing$ 1,4mm, 14mm lenght, for $\varnothing$ 1,6mm screws, with depth scale

**Accessories:**

68-720-002	Box for Micro-Screws and Accessories
68-740-002	Screw Driver, 11cm
68-860-008	Micro Titanium-Plates, 0,6mm, 8-hole
68-860-012	Micro Titanium-Plates, 0,6mm, 12-hole

# 10

## Augmentation

### Box for Micro Screws and Accessories

- Sophisticated and functional Design
- Integrated ruler for the exact determination of screw and graft lengths (removable)
- Newly-developed Material by Aerospace Engineering - THERMOSTABLE
- All parts are suitable for machine processing in the thermodisinfector as well as for all conventional methods, thus corresponding to the latest „RKI - Guidelines“
- Collection tray for all Ustomed screw sizes-diameter (1,0 mm to 1,6 mm)



### Screw Driver

- perfect handle length - therefore suitable for all hand sizes
- The ergonomic handle allows a comfortable and fatigue-free operation
- Self-holding mechanism for collecting screws with spring effect







Foto: Dr. Jan Kielhorn



## Innovative Geometry of the Micro Screws

- Precisely milled cross-slit screw head
- all screw types (1,0 mm bis 1,4 mm) are to be collected with the same blade
- Fast and safe collection of the self-holding micro screws
- Extreme friction between screw head and blade, prevents wear-and-tear
- Much easier removal of debris from the cross-slit (in comparison to inner four-edge or Torx)

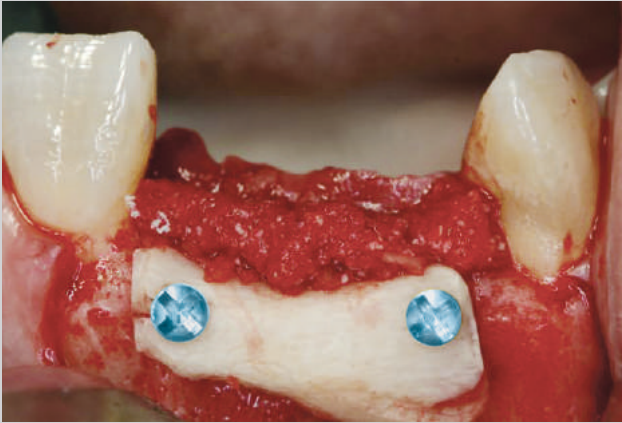

Foto: Dr. Stephan Beuer, M.Sc.



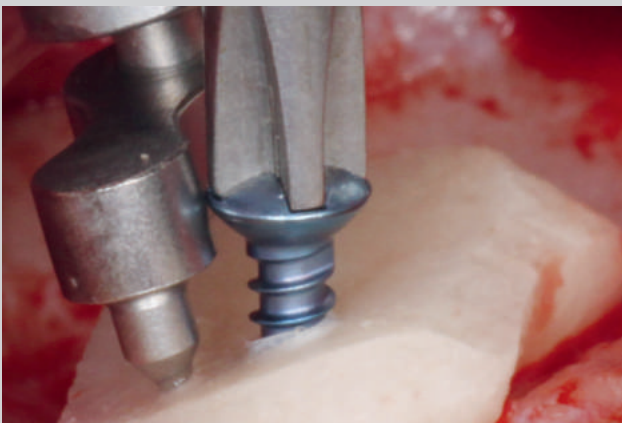
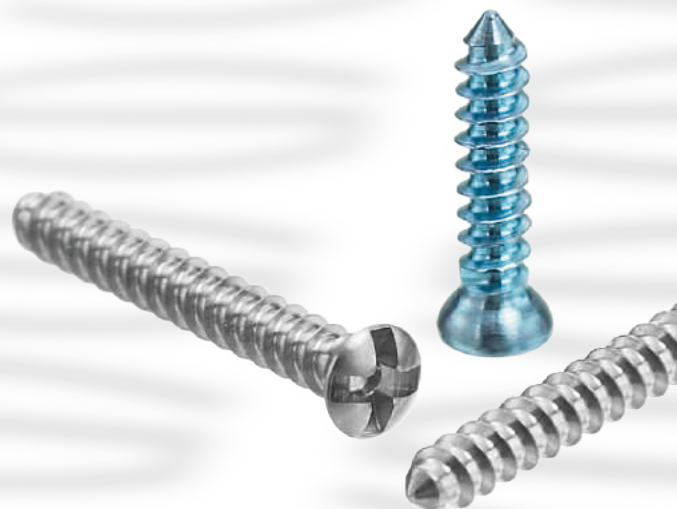

# 10

## Augmentation

### Titanium Micro Screws

- diameter: 1,2 mm / 1,4 mm
- length: 6 mm / 8 mm / 11 mm / 13 mm

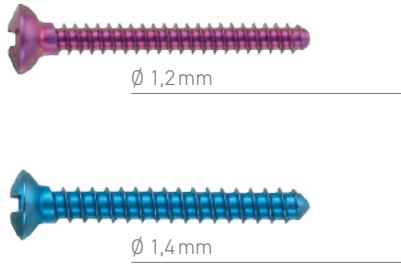

### Implant-Steel Alloy Micro Screws

- diameter: 1,0 mm
- lengths: 8 mm / 11 mm / 13 mm
- perfectly suited for very small bone grafts and 3D-Augmentations
- special alloy material prevents Osseointegration and therefore a dramatically reduced danger of breaking the screws in comparison to titanium screws of similar lengths

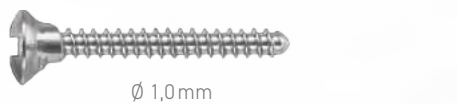

### T-Fix Membrane screw

- conical thread
- length: 4 mm
- self-cutting/self-drilling, no pre-drilling
- perfect for applications in strong cortical bone
- for PTFE and titanium-reinforced membranes

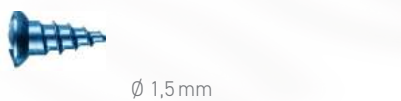



Foto: Dr. Jan Kielhorn



Foto: Dr. Stephan Beuer, M. Sc.

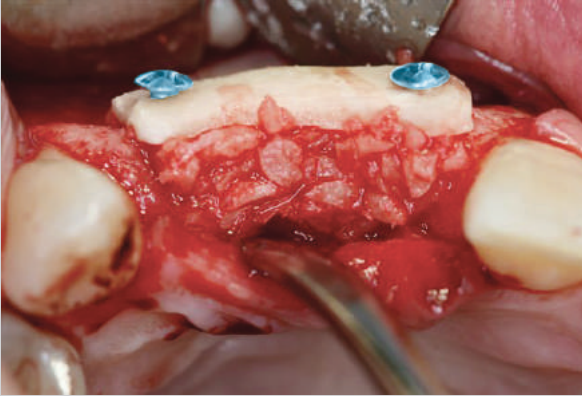

Foto: Dr. Jan Kielhorn

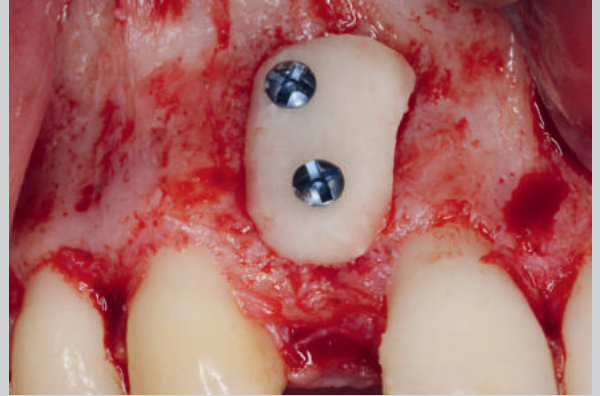

Foto: Dr. Stephan Beuer, M. Sc.

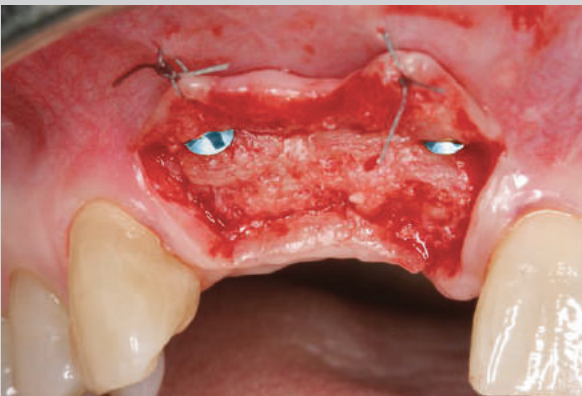

Foto: Dr. Stephan Beuer, M. Sc.

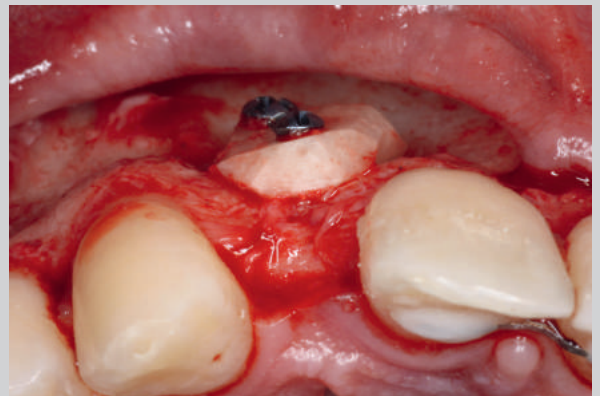

Foto: Dr. Stephan Beuer, M. Sc.

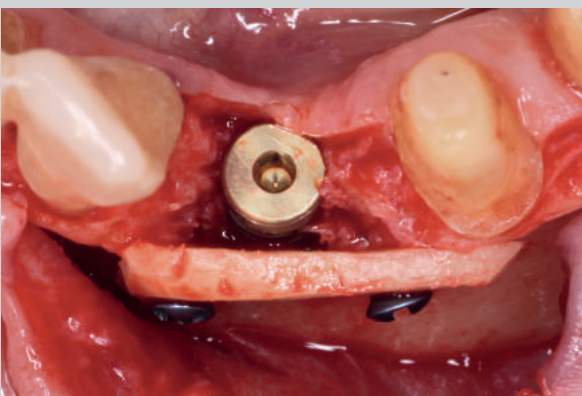

# UMBRELLA-TECHNIQUE by Dr. Dr. Schlee

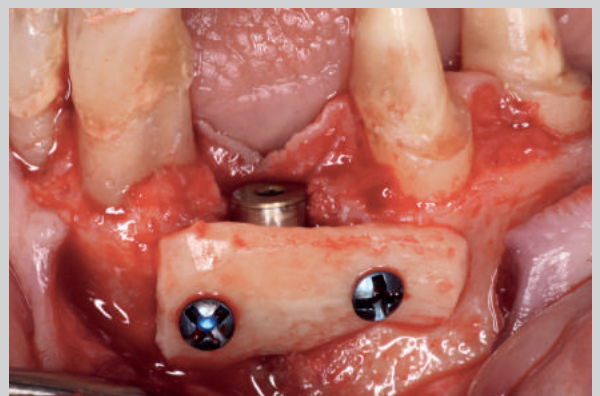

## Implant-Steel Alloy

- diameter: 1,2 mm
- lengths: 8 mm / 11 mm / 13 mm
- screw head diameter: 5 mm
- no Osseointegration

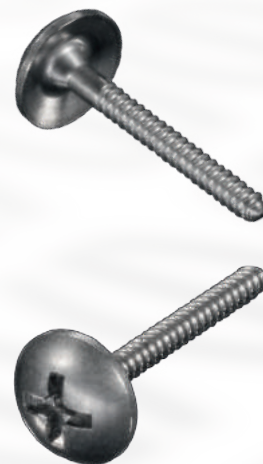

highly-magnified presentation



## Bestandteile:

- 68-780-014 Umbrella-Technique-Set:**  
 68-720-010 Box for Micro-Screws and Accessories  
 68-740-002 Screw Driver, 11cm  
 68-760-102 Blade, cross, self-retaining, 60 mm  
 68-510-014 Pilot Bur  $\varnothing$ 1,0mm  
 \* 3x Umbrella Screw, of choice

### Umbrella Screws (packed individually):

- 68-112-208 S  $\varnothing$ 1,2mm, 8mm length  
 68-112-211 S  $\varnothing$ 1,2mm, 11mm length  
 68-112-213 S  $\varnothing$ 1,2mm, 13mm length

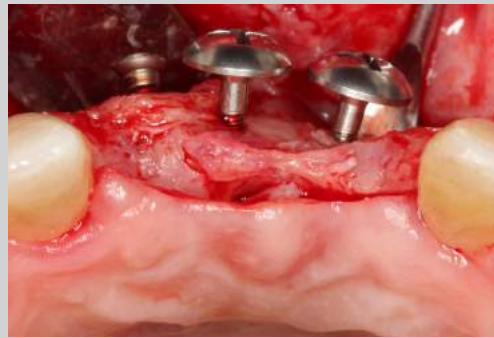

# 10

## Augmentation



1/1

*Luer*  
Bone Rongeur  
31-379-150

150mm



1/1

*FRIEDMAN*  
Bone Rongeur  
31-321-140

140mm



# 11

## ROOT ELEVATORS, LUXATORS AND DESMOTOMES





# 11

## Root Elevators, Luxators and Desmotomes



*BEIN*  
Root Elevator  
83-100-002  
straight  
140mm



*BEIN*  
Root Elevator  
83-100-003  
straight  
140mm



*BEIN*  
Root Elevator  
83-100-004  
straight  
140mm



*Bein*  
Root Elevator  
83-100-005  
straight  
140mm



*BEIN*  
Root Elevator  
83-111-025  
curved  
140mm



*BEIN*  
Root Elevator  
83-111-035  
curved  
140mm

# 11

## Root Elevators, Luxators and Desmotomes



1/1

*BEIN*  
Root Elevator  
83-111-045  
curved  
140mm



1/1

*BEIN-LUXATOR*  
Luxator  
83-120-003  
delicate, straight  
140mm



1/1

*BEIN-LUXATOR*  
Luxator  
83-120-004  
delicate, straight  
140mm





*Bein-Luxator*

Luxator

83-120-005

delicate, straight

140mm



*BEIN-LUXATOR*

Luxator

83-121-003

delikat, curved

140mm



*BEIN-LUXATOR*

Luxator

83-121-004

delikat, curved

140mm

# 11

## Root Elevators, Luxators and Desmotomes



### *BEIN-LUXATOR*

Luxator

83-121-005

delicate, curved

140mm

Desmotome

83-904-000

straight

145mm

Desmotome

83-905-001

angled, right

140mm

83-905-002

angled, left

140mm



Cartridge Syringe  
84-060-018

ring handle, compact,  
stainless-steel



Soft-Ject-Syringe  
84-147-000

for intraligamentary anesthesia



# 11

## Root Elevators, Luxators and Desmotomes



---

### Pressure-Syringe

84-144-018

with automatic  
Pressurecontrol

# 12

## CONTAINER SYSTEMS AND WASH TRAYS

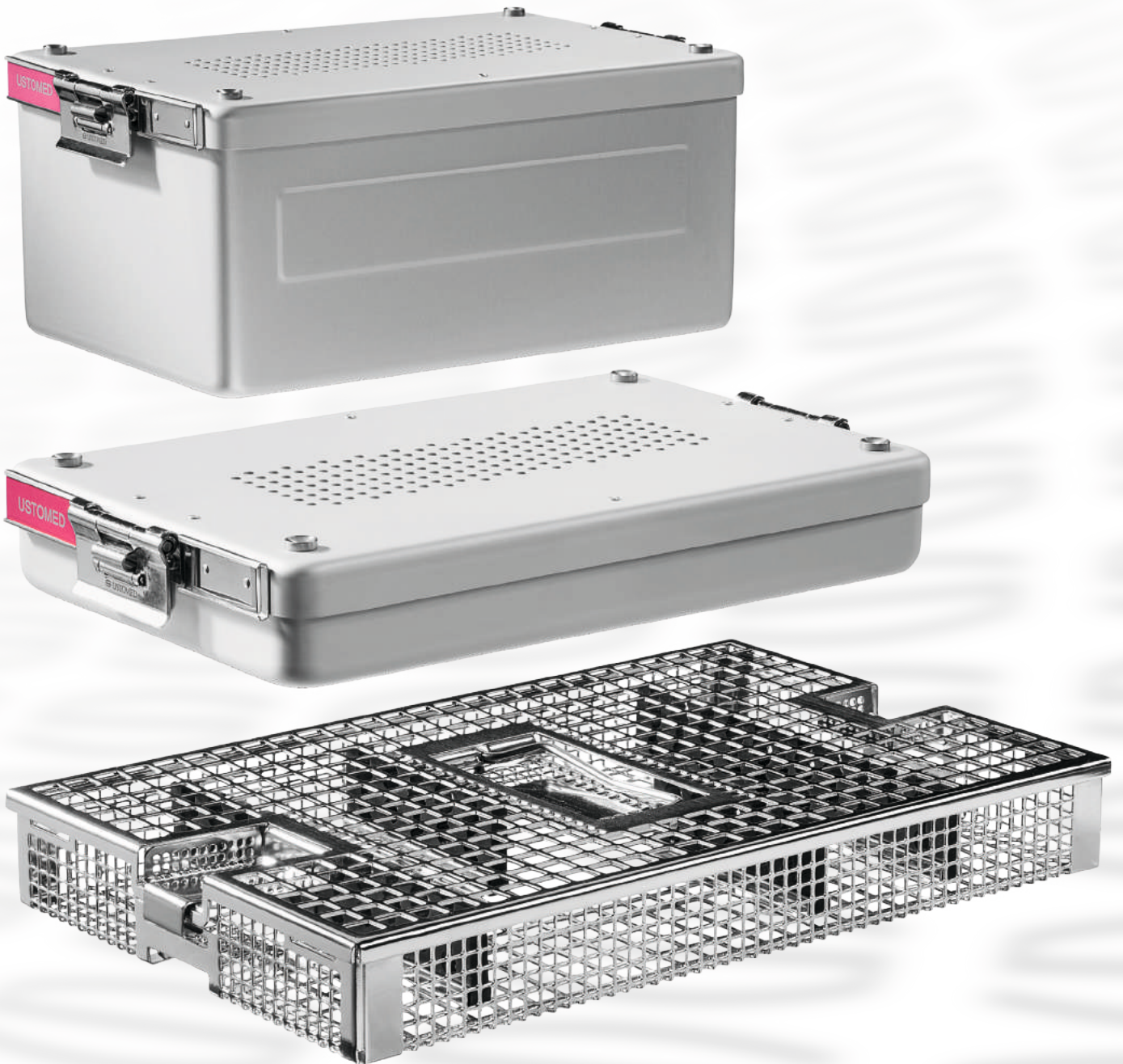

# 12

## Container Systems and Wash Trays



Sterilization-Container  
90-618-040  
315 x 190 x 40mm



Sterilization-Container  
90-618-065  
315 x 190 x 65mm



Sterilization-Container  
90-618-130  
315 x 190 x 130mm





Ustomed  
Teflon-Filter  
90-642-002

Marking Plates,  
including labeling



90-650-000 red



90-650-001 blue



90-650-002 green



90-650-003 yellow



90-650-004 black



90-650-005 silver



90-650-007 magenta



90-650-008 orange



Plate Holder  
90-652-000



Seals  
90-665-100  
(pack contains 100 pcs.)



Marking Plate, HIBC, (Data  
Matrix)  
90-654-000

or  
Marking Plate, HIBC,  
Code 128 (Barcode)  
90-656-000

# 12

## Container Systems and Wash Trays



Sterilization-Container

90-626-040

315 x 190 x 40mm



Sterilization-Container

90-626-065

315 x 190 x 65mm



Sterilization-Container

(Half-Size)

90-628-040

195 x 145 x 40mm



Sterilization-Container

(Half-Size)

90-628-065

195 x 145 x 65mm



**DENTAL STERILIZATION-CONTAINER SYSTEM WITH SAFETY-FILTER**

Ustomed's answer to consistently increasing demands for risk minimization, environmental protection and handling comfort, is the newly-developed Easy-Stop System.

The filterless mechanism stops microorganisms even more effectively than conventional filter systems and can be re-used as often as you like. There is no need for consumable purchasing.

To open or close, one handling step is enough:

Simply, press the lid down, and turn!



**THE ADVANTAGES SPEAK FOR THEMSELVES:**

- The unique lid is almost indestructible: It is precision-milled from a solid block of aluminum. That way, the lid stays in shape and can withstand the daily office routines.
- Dirt- and germ-repellent
- Fast and residue-free drying during steam-sterilization
- High quality material for triple safety: adhere-free, pore-free and corrosion-free

**INFO:**

The two-piece aluminum insert in the lid serves as a germ barrier according to the principle of the „Pasteur Loops“. By forming a labyrinth of ring ribs, it therefore reliably separates microbes, germs and particles.

The meandering flow path achieves a decontamination rate of 99.997%

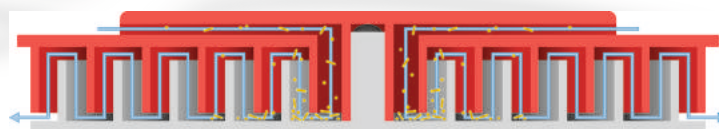



# 12

## Container Systems and Wash Trays

Wash tray „Flexi-Kit“  
with 5 silicon racks  
270 x 170 x 35mm

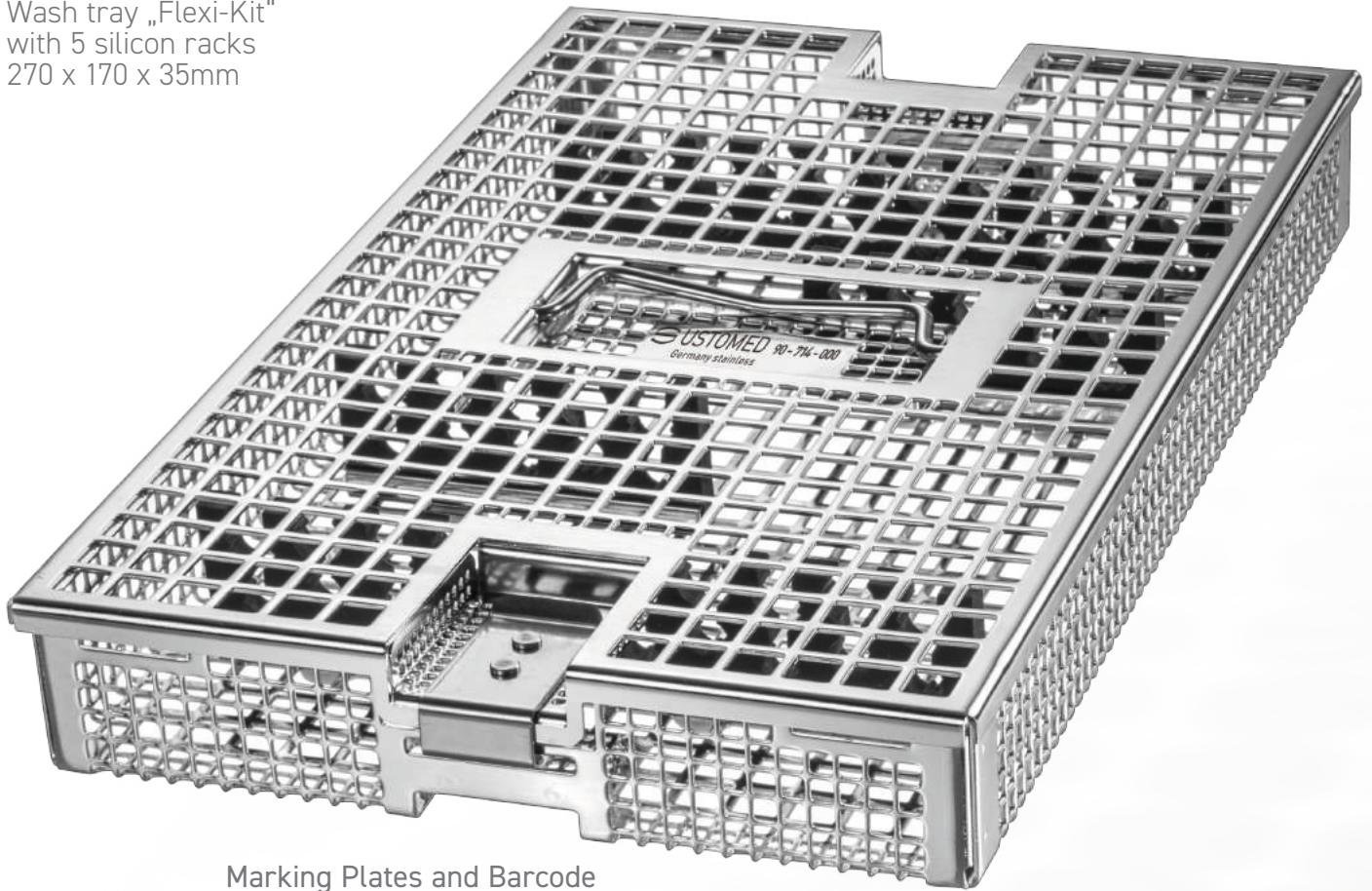

Marking Plates and Barcode  
Plates (refer to page 105)

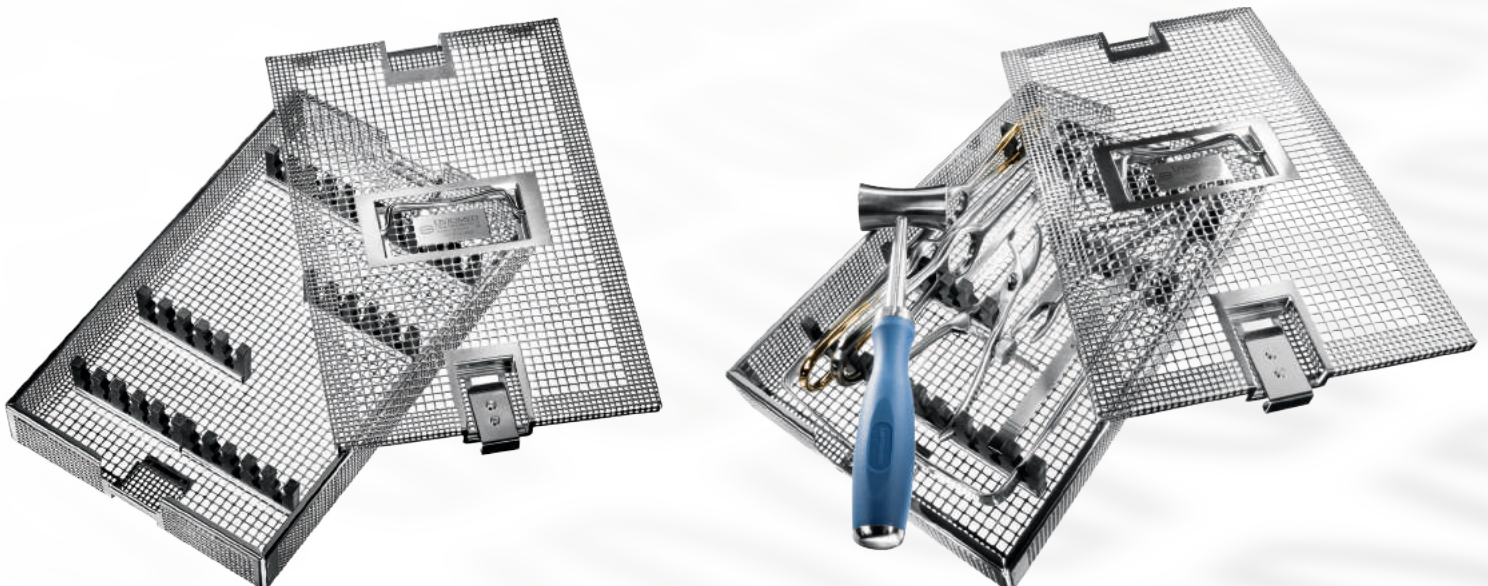

Packing Suggestion, Wash Tray is sold  
without instruments





Sterilization and Collection Tray  
for 4 instruments, half-size  
90-340-004



Sterilization and Collection Tray  
for 8 instruments, half-size  
90-340-008

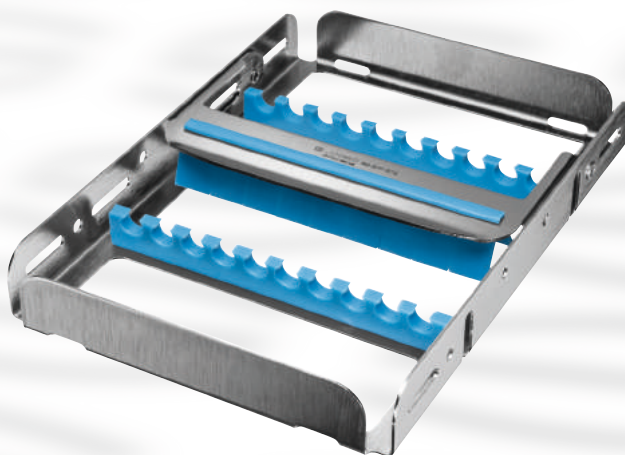

Sterilization and Collection Tray  
for 10 instruments, half-size  
90-340-010



USTOMED INSTRUMENTE  
Ulrich Storz GmbH & Co. KG

Bischof-Sproll-Straße 2  
78532 Tuttlingen / Germany

Manufacturer for Surgical and  
Dental Instruments

Phone: +49 (0) 74 61 / 9 65 85 0  
Fax: +49 (0) 74 61 / 9 65 85 65

info@ustomed.de  
www.ustomed.de