

Sungrow SH10RT
 Pn: 10 kW
 SN: AS20201081
 I: 15.2A

24 Stuks QCELLS
 Opeak DUO BLK MG11 + 395Wp
 Pdc totaal: 9480Wp

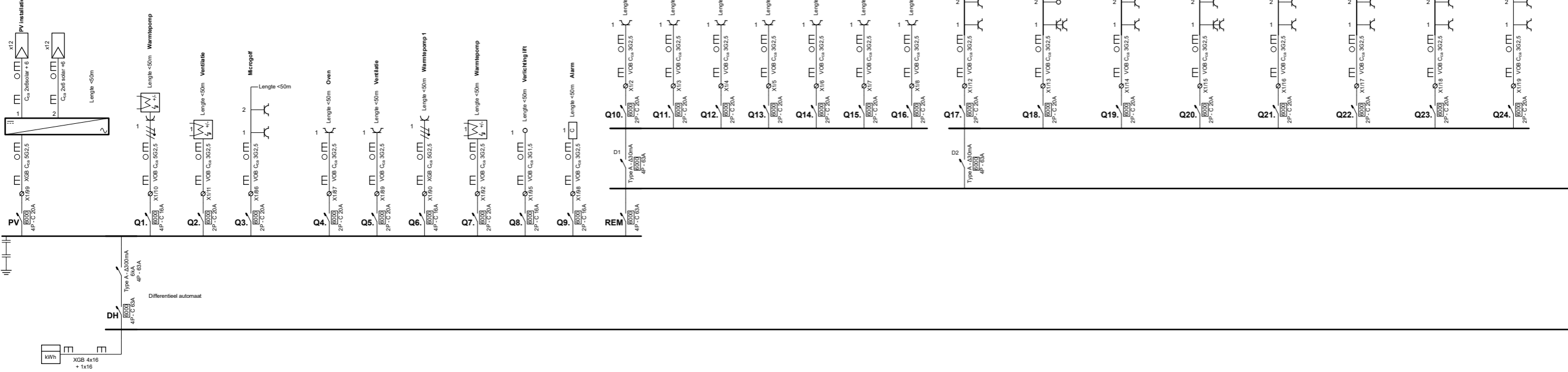

Erkend Organisme
 Atecon
 Prins Boudewijnlaan 43 bus 10
 2650 Edegem
 Tel.: 03 770 75 14
 e-mail: info@atecon.be

Plaats van de elektrische installatie
 Immo PH74
 Haachtstraat 74
 3020 Veltem

Installateur
 Hoogmartens bv
 Oude Baan 104
 3060 Bertem
 Tel.: 016 40 04 22 GSM: 0479 99 49 30
 e-mail: info@hoogmartens.eu
 BE 0891.470.679

p. 1/6
Eendraadschema
 Datum: 25/07/2023
 3 x 400V + N ~ 50Hz
 Icc = 3000A
 TT-net
 Geen filiatie

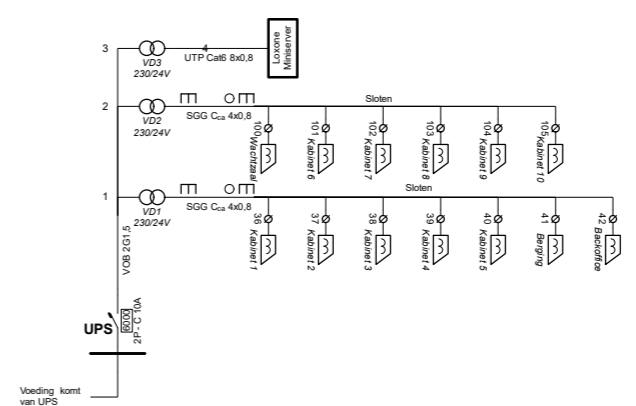
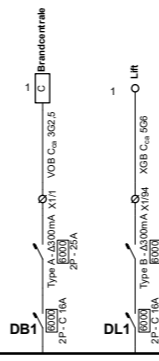
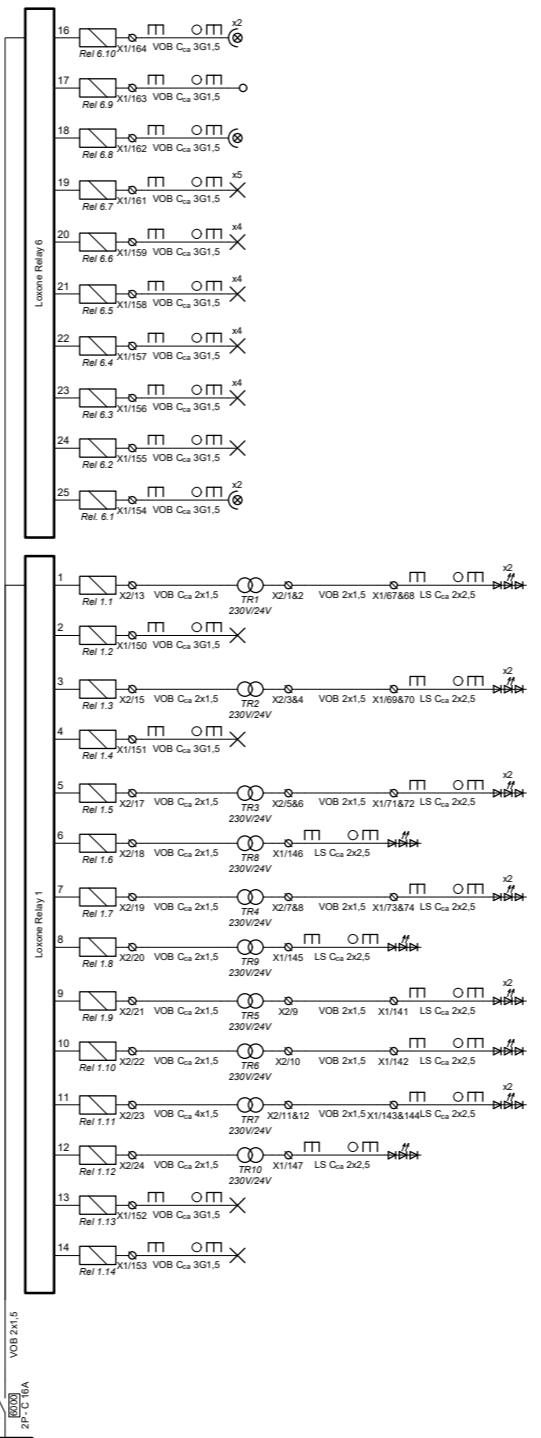
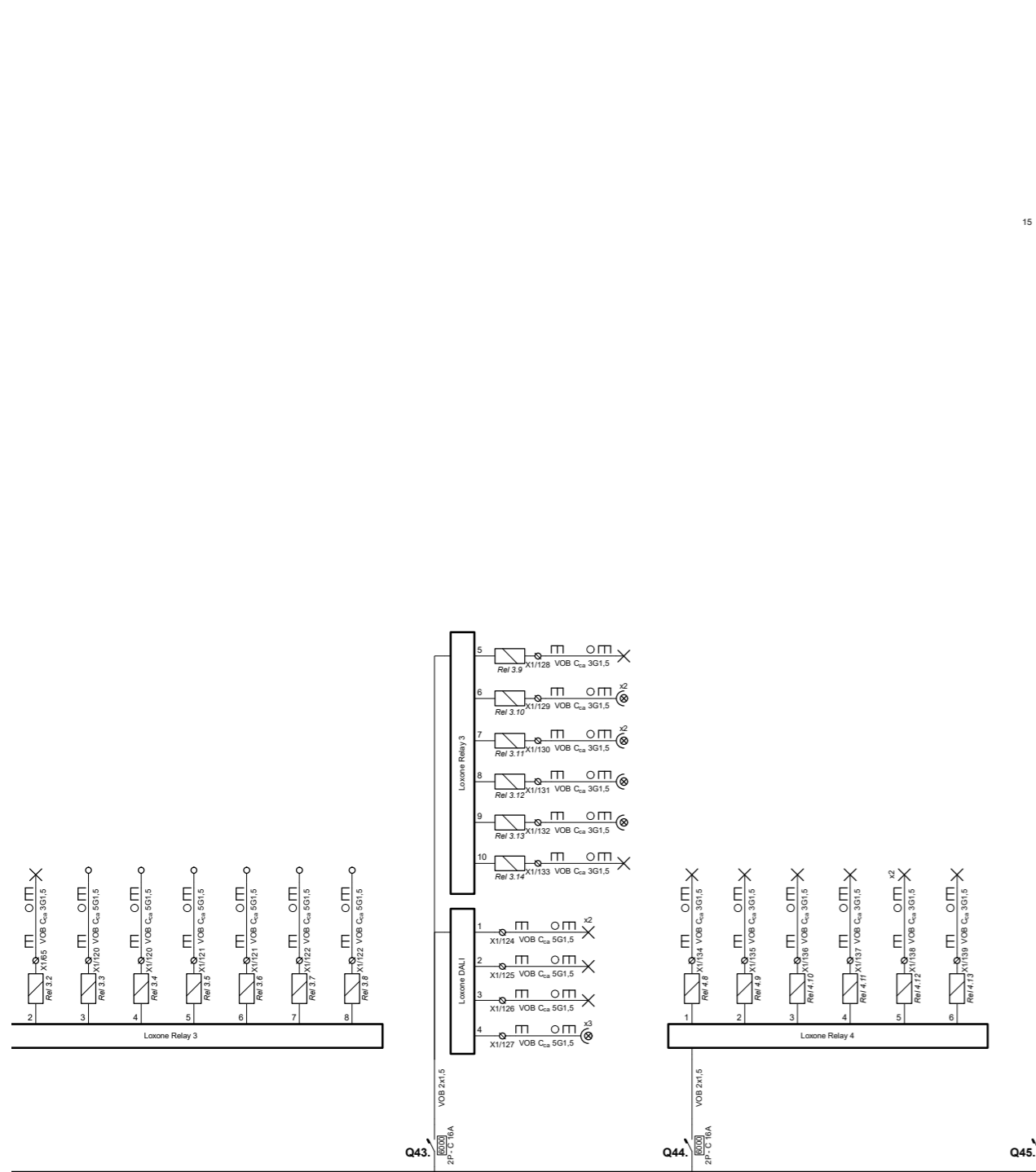

Erkend Organisme
 Atecon
 Prins Boudewijnlaan 43 bus 10
 2650 Edegem
 Tel.: 03 770 75 14
 e-mail: info@atecon.be

Plaats van de elektrische installatie
 Immo PH74
 Haachtstraat 74
 3020 Veltem

Installateur
 Hoogmartens bv
 Oude Baan 104
 3060 Bertem
 Tel.: 016 40 04 22 GSM: 0479 99 49 30
 e-mail: info@hoogmartens.eu
 BE 0891.470.679

p. 3/6
Eendraadschema
 Datum: 25/07/2023
 3 x 400V + N ~ 50Hz
 Icc = 3000A
 TT-net
 Geen filiatie

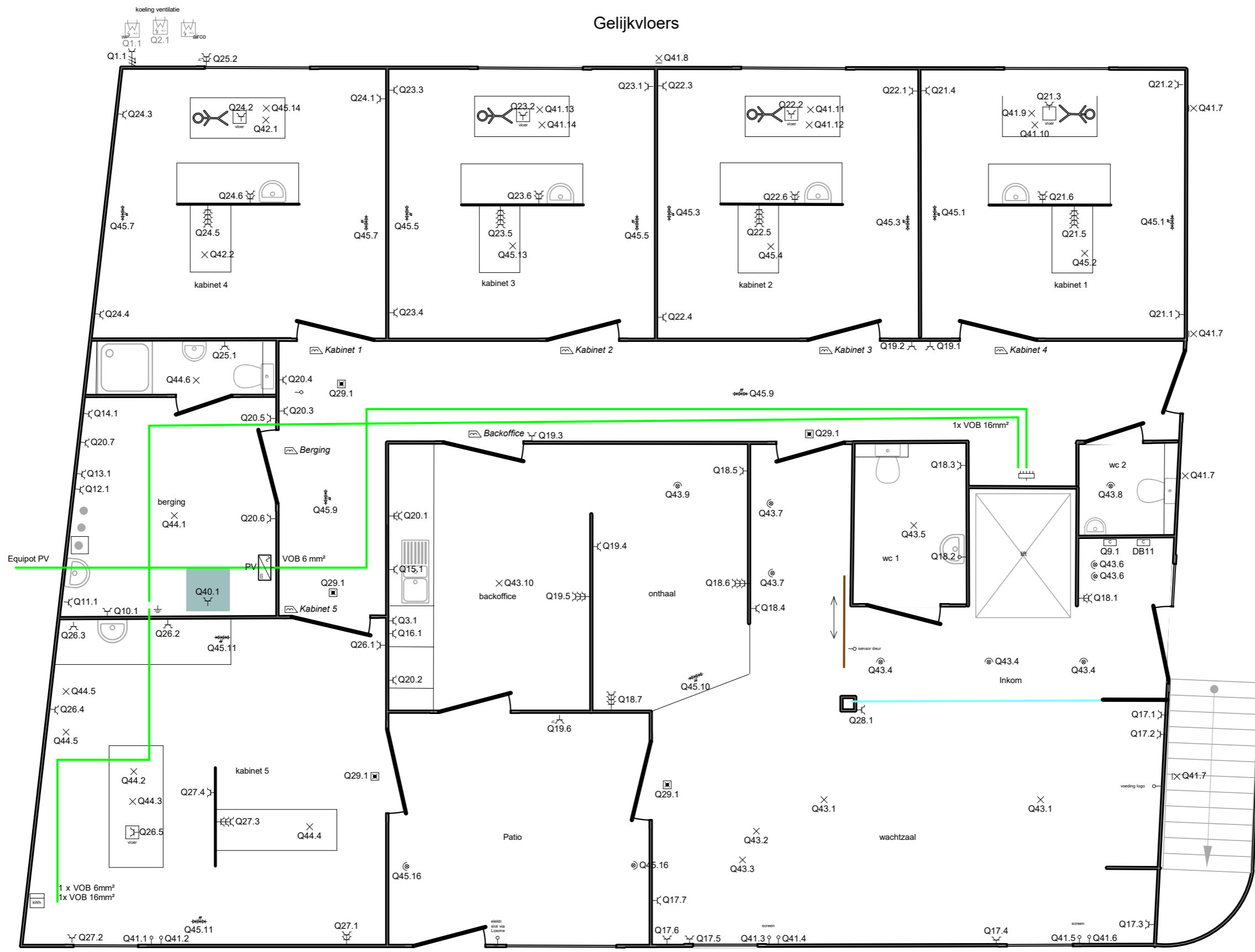

<p>Erkend Organisme Atecon Prins Boudewijnlaan 43 bus 10 2650 Edegem Tel.: 03 770 75 14 e-mail: info@atecon.be</p>	<p>Plaats van de elektrische installatie Immo PH74 Haachtstraat 74 3020 Veltem</p>	<p>Installateur Hoogmartens bv Oude Baan 104 3060 Bertem Tel.: 016 40 04 22 GSM: 0479 99 49 30 e-mail: info@hoogmartens.eu BE 0891.470.679</p>	<p>p. 4/6 Situatieschema Datum: 25/07/2023 3 x 400V + N ~ 50Hz Icc = 3000A TT-net Geen filiatie</p>
--	--	---	---

1e Verdieping

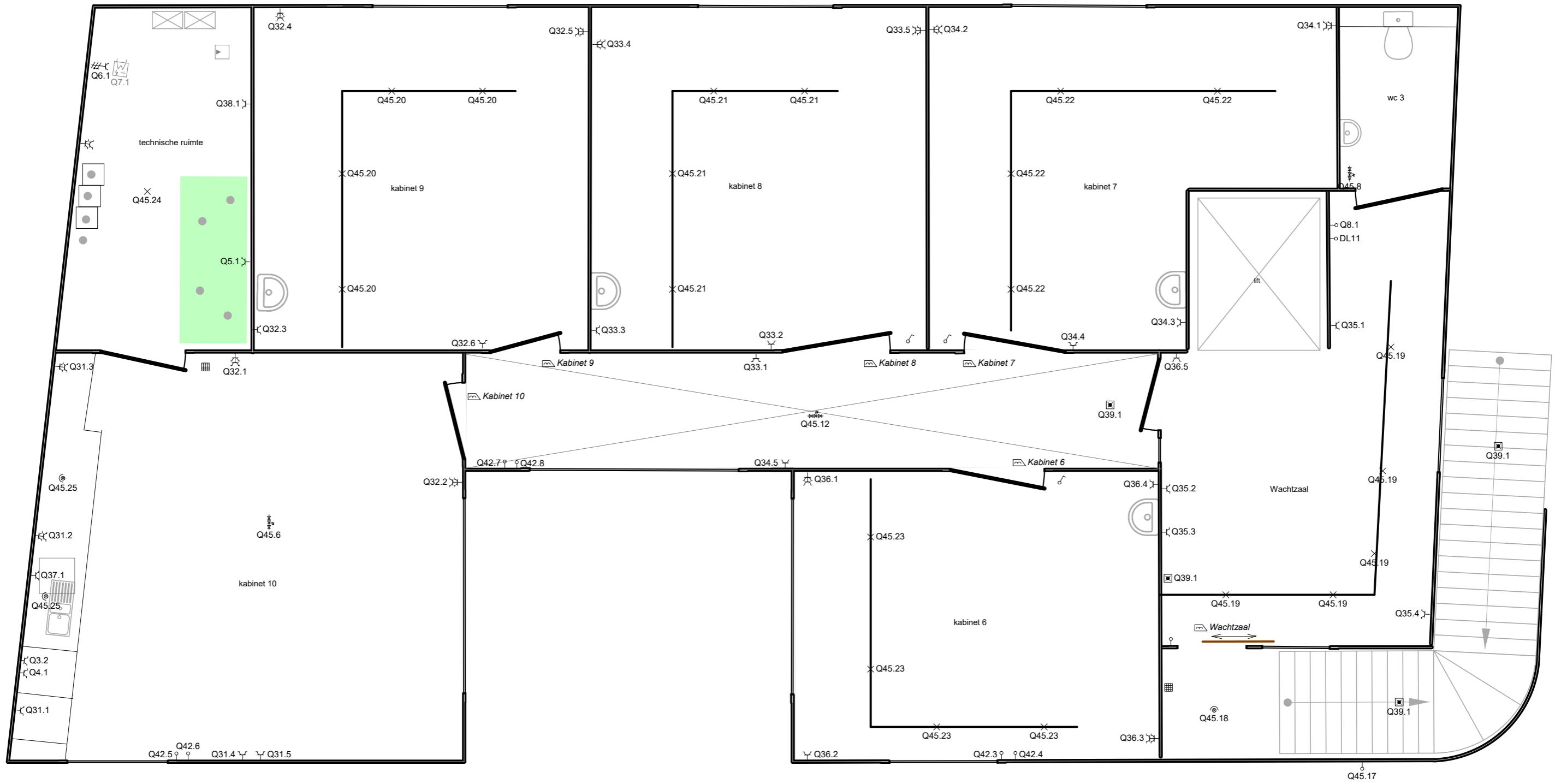

Erkend Organisme
 Atecon
 Prins Boudewijnlaan 43 bus 10
 2650 Edegem
 Tel.: 03 770 75 14
 e-mail: info@atecon.be

Plaats van de elektrische installatie
 Immo PH74
 Haachtstraat 74
 3020 Veltem

Installateur
 Hoogmartens bv
 Oude Baan 104
 3060 Bertem
 Tel.: 016 40 04 22 GSM: 0479 99 49 30
 e-mail: info@hoogmartens.eu
 BE 0891.470.679

p. 5/6
Situatieschema
 Datum: 25/07/2023
 3 x 400V + N ~ 50Hz
 Icc = 3000A
 TT-net
 Geen filliatie

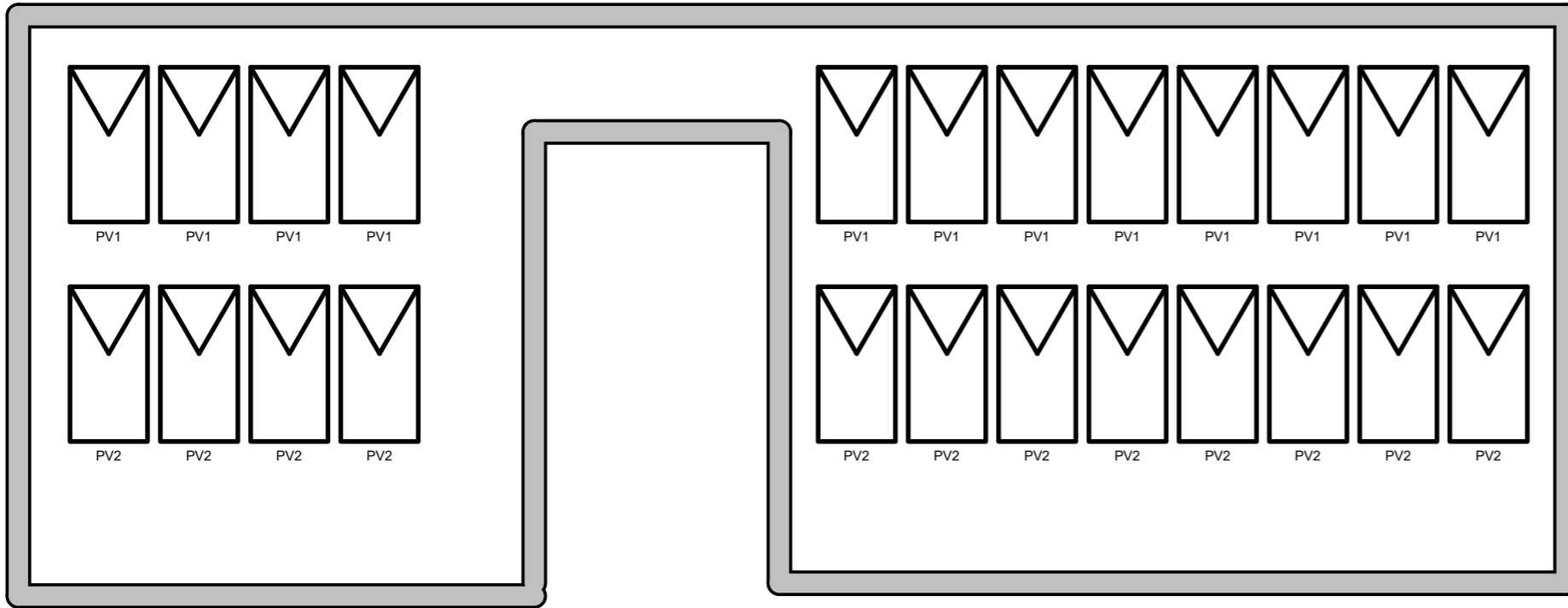

Haachtstraat

Erkend Organisme
 Atecon
 Prins Boudewijnlaan 43 bus 10
 2650 Edegem
 Tel.: 03 770 75 14
 e-mail: info@atecon.be

Plaats van de elektrische installatie
 Immo PH74
 Haachtstraat 74
 3020 Veltem

Installateur
 Hoogmartens bv
 Oude Baan 104
 3060 Bertem
 Tel.: 016 40 04 22 GSM: 0479 99 49 30
 e-mail: info@hoogmartens.eu
 BE 0891.470.679

p. 6/6
Situatieschema
 Datum: 25/07/2023
 3 x 400V + N ~ 50Hz
 Icc = 3000A
 TT-net
 Geen filliatie