

STEP 1 Attaching ESC、Receiver、Gyro、Battery
 安裝電變、接收器、陀螺儀、電池

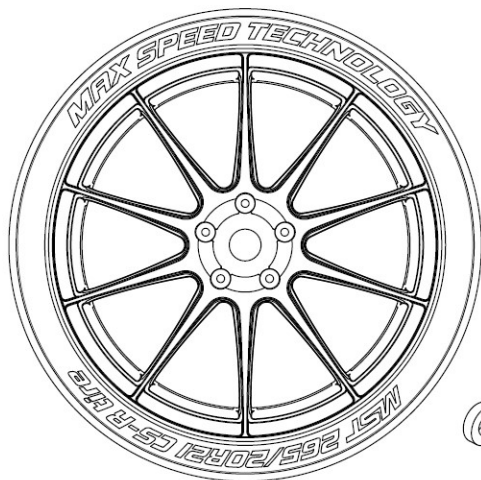

※ NOT including.
 Please refer to MST website for the wheel & tire types.
 胎框組須另購，詳情請見官網。
 [www.rc-mst.com]

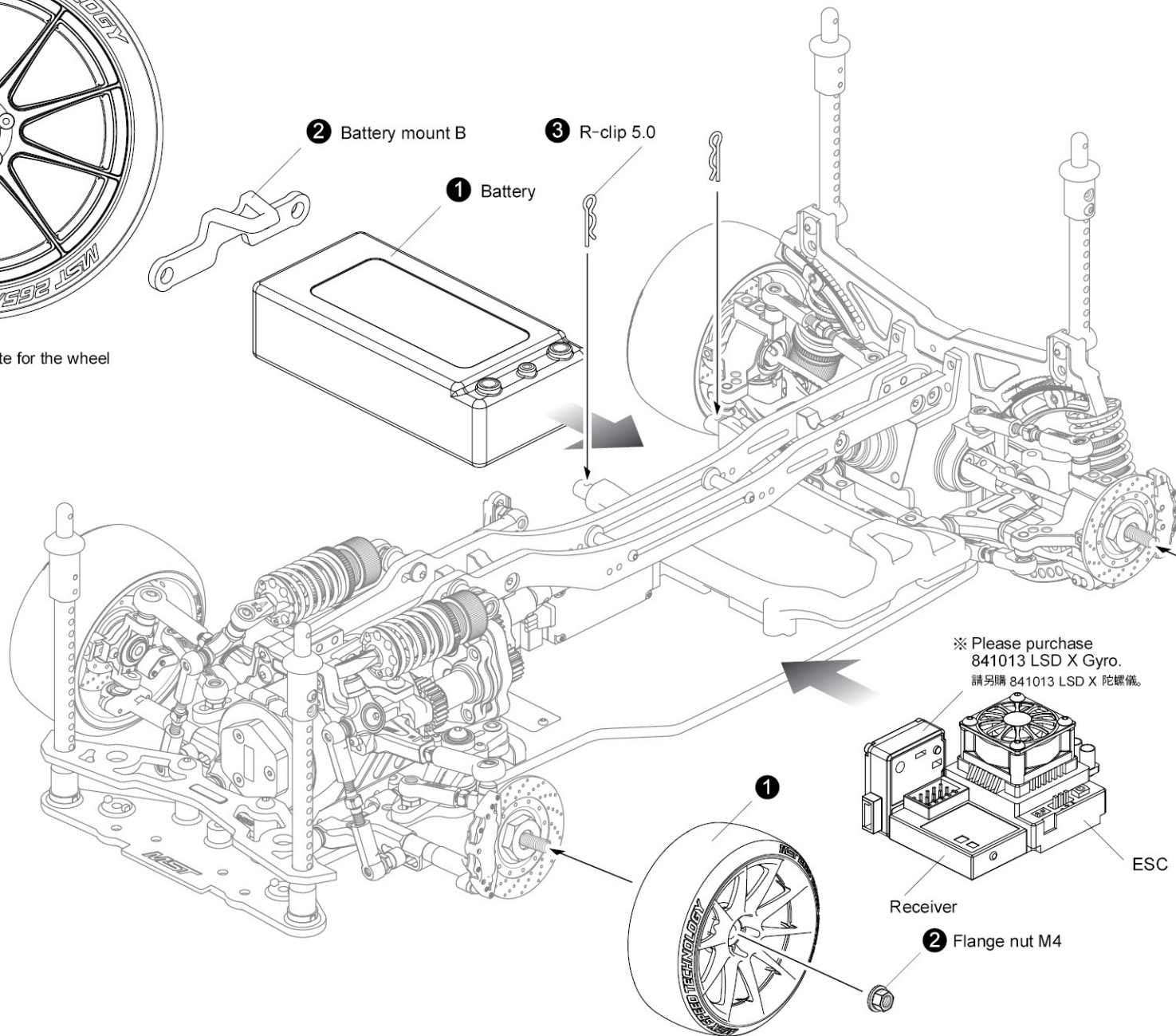
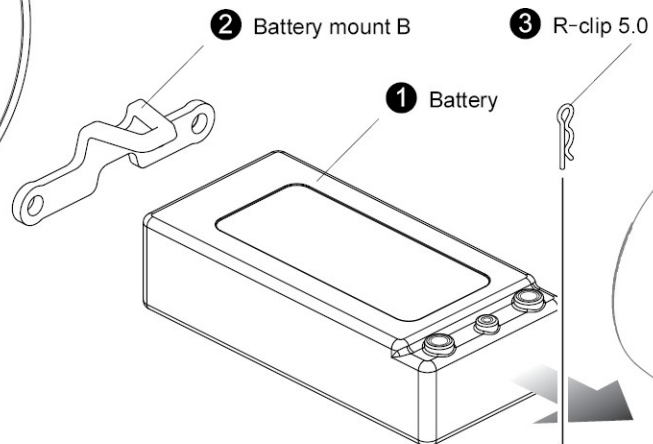

※ Please purchase
 841013 LSD X Gyro.
 請另購 841013 LSD X 陀螺儀。

STEP 2 Attaching wheels
 安裝輪胎

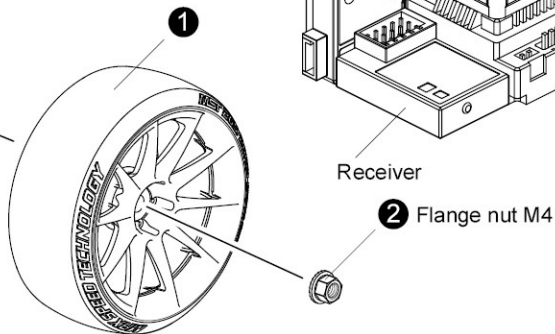
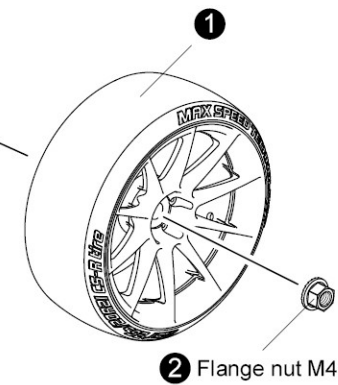

1 TRAIL ADJUSTMENT

Trail 調整

Follow the figure to assemble the trail for 0 / 0.75 / 1.5. The greater number is for the longer trail distance.
如圖依照需求選擇拖曳座0 / 0.75 / 1.5安裝，數字越大代表拖曳距離越大。



2 KINGPIN STEERING EXTENT ADJUSTMENT

大王銷轉向變化調整

Follow the figure to install the kingpin position for demanded steering extent.
如圖依照轉向變化需求選擇大王銷球頭安裝位置。

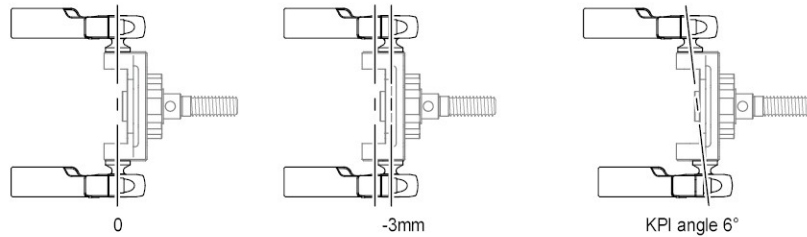

3 ACKERMANN CHANGES ADJUSTMENT

阿克曼角變化調整

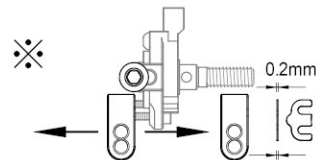
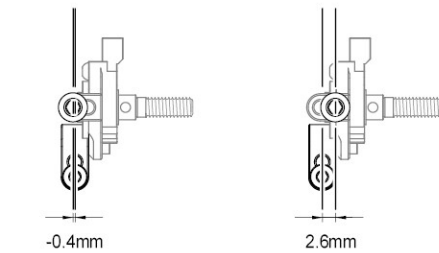

1. Install the special Ackerman spacer to adjust the offset, one for 0.2mm offset.
安裝專用阿克曼墊片調整偏移量，一片偏移量為0.2mm。
2. To adjust in the left arrow direction for bigger Ackermann angle.
往前導左邊方向調整阿克曼角越大。
3. To adjust in the right arrow direction for smaller Ackermann angle.
往前導右邊方向調整阿克曼角越小。

4 ACKMAN LOCK POINT HEIGHT ADJUSTMENT

阿克曼鎖點高低調整



STEP 1 Adjust the arm hingness

擺臂高度調整

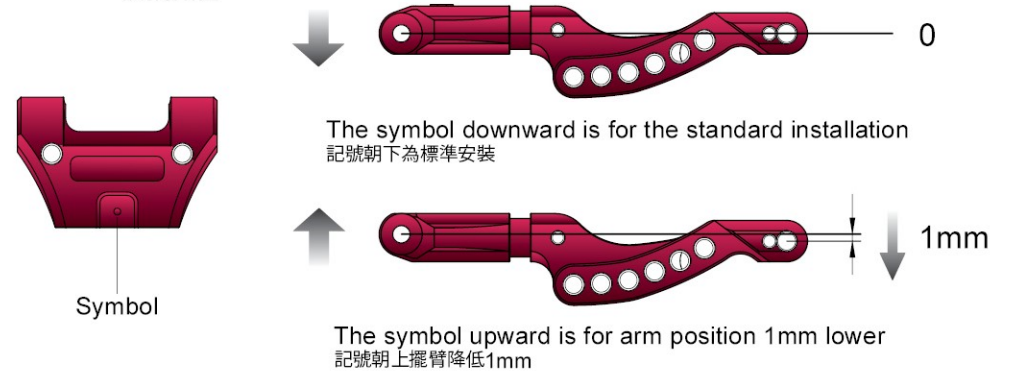

STEP 2 Adjust the arm length

擺臂長度調整

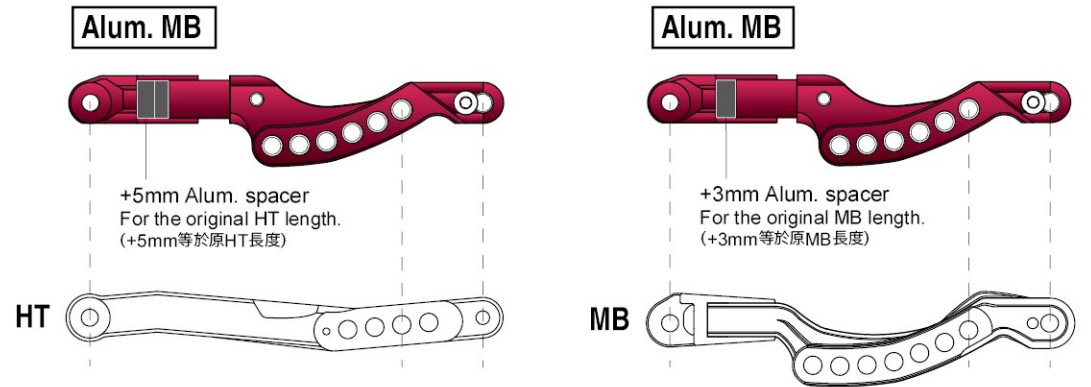

STEP 3 Wheel knuckle height adjustment

輪座高低調整

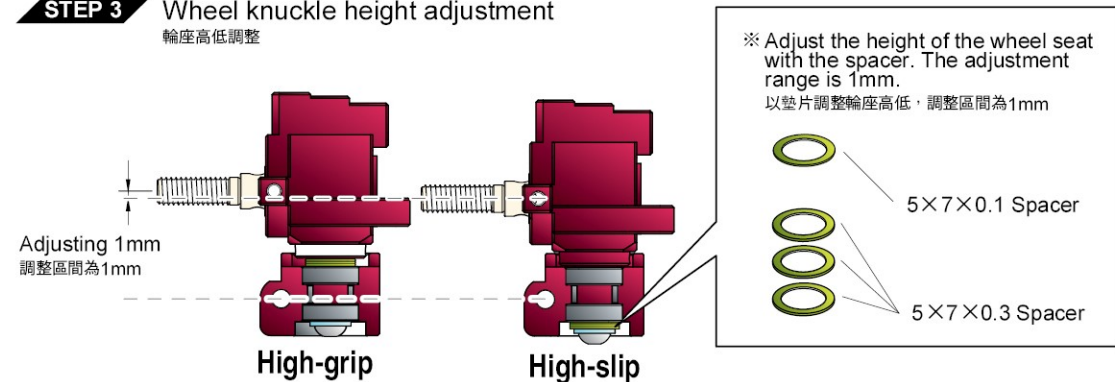

STEP 1 Rear caster angle setting
後傾角設定

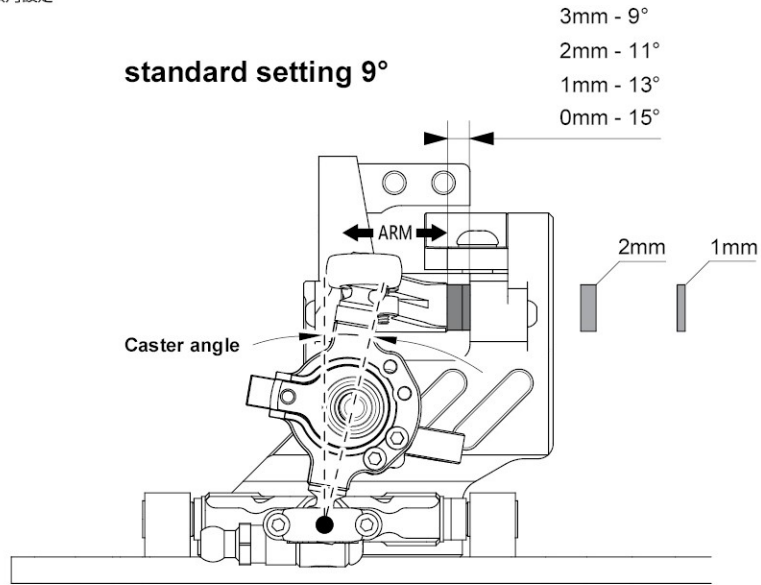

STEP 2 IFS Adjusting instruction
IFS調整說明

※ A The longer the gasket, the stronger the lifting force on the front of the vehicle. The shorter the shorter, the weaker.

A 墊片越長車頭上抬力量越強，越短則越弱。

※ B The longer the gasket, the stronger the head sinking force, the shorter the weaker.

B 墊片越長車頭下沉力量越強，越短則越弱。

※ Please adjust the characteristics according to the length of the gasket A / B, match the settings that suit your needs.

請依照墊片A/B長短調整後的特性，搭配出符合自己需求的設定。

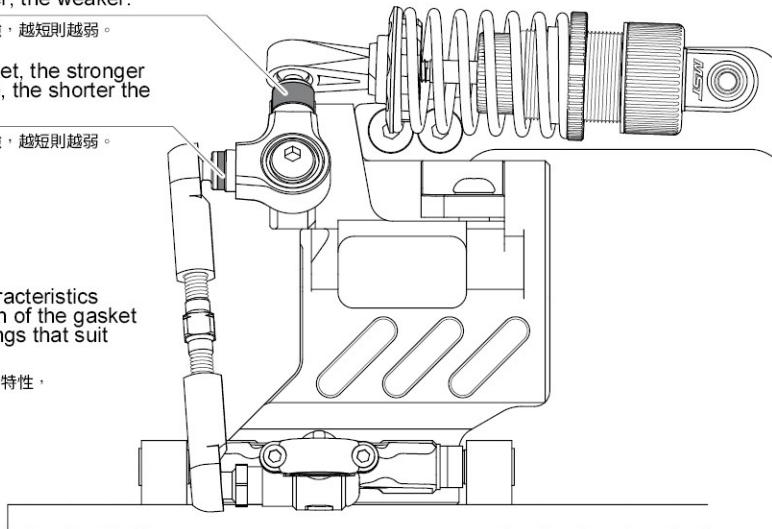

※ Please check every turnbuckle shaft length is correct before practice drive!
下場前請確認可調拉桿長度

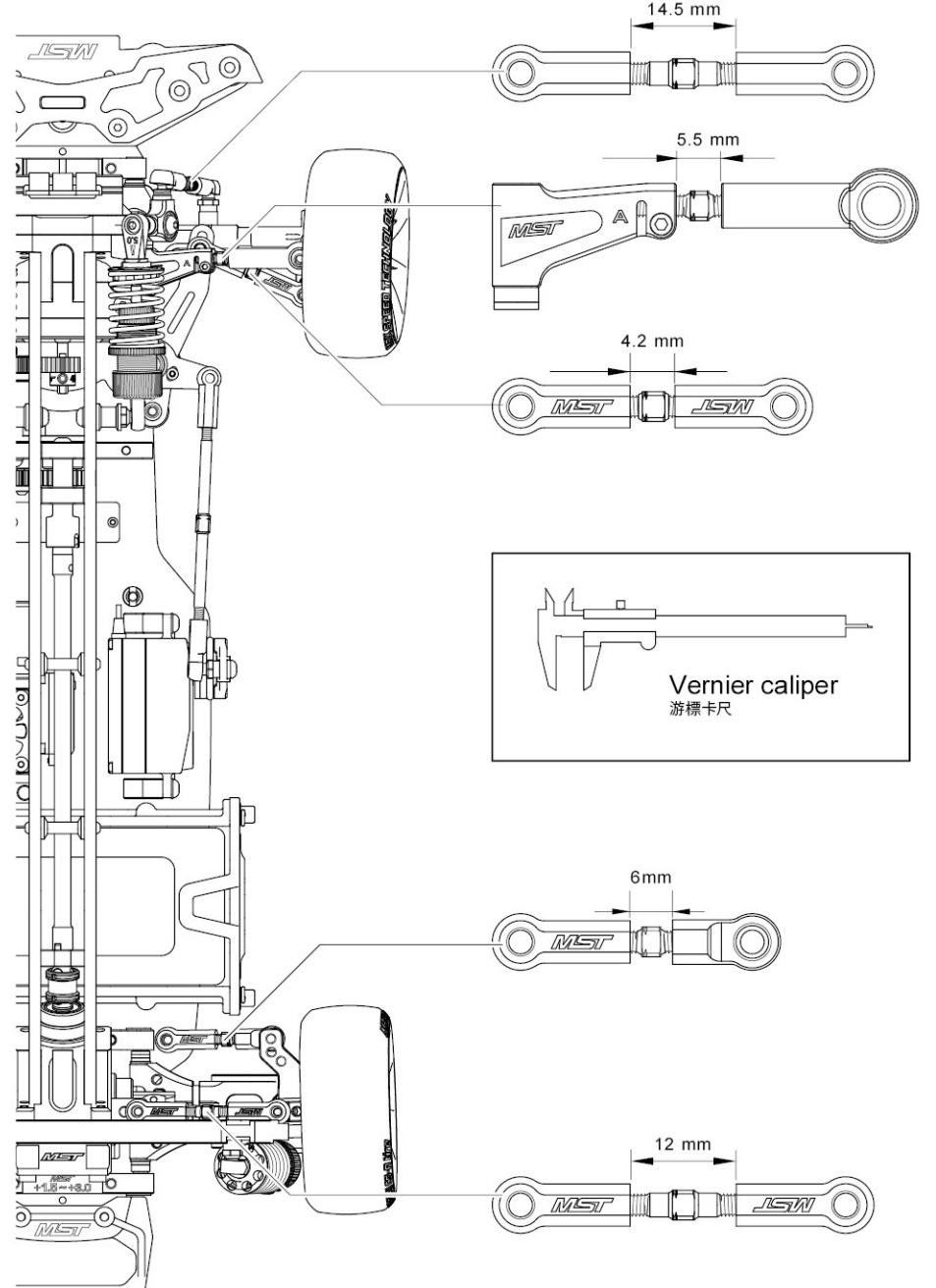

Caster

9°
 11°
 13°
 15°

Steering

IFS

0.9 mm

14.5 mm

3 mm

Rear diff

Ball diff
 Alum spool

Front upright

TRAIL ADJUSTMENT

0 -0.75 -1.5

2 mm

0 mm

0 mm

x 4

0 mm

Front suspension

Camber: 5.5°

Toe-in: -4°

Ride height: 5 mm ↓ GROUND

Rear suspension

Camber: 2°

Toe-in: 1°

Rear upright

4 mm

0 mm

1 mm

2 mm

GROUND

Ride height: 5 mm

FRONT **REAR**

Tire: CS-R Silver

Wheel: GT

Offset: +5

Front Suspension mount Rollcenter

1 mm

+0.5

0 mm

3 mm

+0.5

0 mm

Rear Suspension mount Rollcenter

3 mm

+1.5

0 mm

3 mm

+3.0

0 mm

Pinion Gear 馬達齒 Gear C 36T 齒輪C 36T

Gear A 28T 齒輪A 28T

Gear B 20T 齒輪B 20T

Gear C 36T 齒輪C 36T

Small Bevel Gear 11T 小傘齒 11T

Big Bevel Gear 42T 大傘齒 42T

Gear A 28 T
 x Gear C 36 T
 x Big Bevel Gear 42 T
 ÷ Gear B 20 T
 ÷ Small Bevel Gear 11 T
 ÷ Pinion Gear 18 T
 = Transmission ratio 10.69

Front damper

Shock oil: #10

Spring: 31 mm Ø1.1

Spring color: Gold

Piston: Ø1.0 mm

Piston hole: 3

6 mm

69.5 mm

Rear damper

Shock oil: #10

Spring: 31 mm Ø1.1

Spring color: Purple/yellow

Piston: Ø1.0 mm

Piston hole: 3

2.5 mm

64.5 mm

Motor & ESC: 13.5T XR10 Battery: 7.6V.100C

































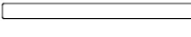



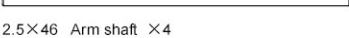







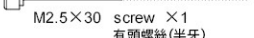





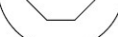

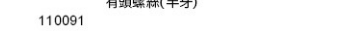



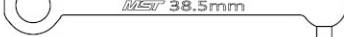



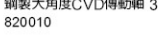







Transceiver: T7PX Gyro: LSDX Sensitivity: -10~+20

※ Please download the blank setup sheet at [www.rc-mst.com]

PARTS

Please add color remark for () part number. e.g. 210123R for Red (210123)
請增加顏色標示在 () 編號 例: 210123R for 紅色 (210123)

Color 顏色	Remark 標示
Red 紅 / Silver 銀	R / S

	M1.6×6 screw ×6 有頭螺絲 110066S		M3×3 screw ×3 止付螺絲 110060		1.5×7.8 Shaft ×1 插銷 110059		4.8×4.5 Ball connector ×4 球頭螺絲 310001		3×5.5×1 Spacer ×1 墊片 (820026)
	M1.6×10 screw ×4 有頭螺絲 110105		M3×3 screw (NL) ×4 止付螺絲 (耐落) 110035NL		2×9.8 Shaft ×4 插銷 110017		4.8×6 Ball connector ×6 球頭螺絲 310050		3×5.5×2 Spacer ×10 墊片 (820027)
	M2×3 screw ×8 圓頭螺絲 110082		M3×10 screw ×2 止付螺絲 110032		2×9.8 Shaft ×3 插銷 110046		4.8×9 Ball connector ×2 球頭螺絲 310037		3×5.5×3 Spacer ×4 墊片 (820028)
	M2×4 screw ×4 圓頭螺絲 110004		M3×12 screw ×2 止付螺絲 110056		2.6×25 Shaft ×2 插銷 310035		5.8×4 Ball connector (L) ×2 球頭螺絲(長) 210491		3×5.5×4 Spacer ×6 墊片 (820011)
	M2×5 Screw ×2 圓頭螺絲 110050		M3×6 screw ×14 沉頭螺絲 110024		2×28 Shaft ×2 插銷 310103		5.8×6 Ball connector (L) ×2 球頭螺絲 210625		3×6×0.5 Spacer ×12 墊片 110047
	M2×6 Screw ×3 圓頭螺絲 110044		M3×8 screw ×25 沉頭螺絲 110005		2.5×46 Arm shaft ×4 擺臂插銷 310048		R-clip 5.0 ×6 R-銷 5.0 820075		2.6×5.8×0.6 Spacer ×2 墊片 110080
	M2×8 Screw ×2 圓頭螺絲 110063		M3×10 Screw ×12 沉頭螺絲 110052		2WD Axle ×2 二驅輪軸 820095		Alum. wheel nut (black) (4) 鋁合金輪框螺帽 (820001)		2.5×6 Thrust bearing ×1 止推培林 120008
	M2×8 screw ×4 圓頭螺絲(半牙) 110045		M2.5×30 screw ×1 有頭螺絲(半牙) 110053		Wheel axle ×2 萬向接杯 310065		Diff. plate ×2 滾差壓板 310033		3×6 Flange bearing ×2 凸緣培林 120010
	M2.5×8 Screw ×2 圓頭螺絲 110068		M3×40 Screw ×2 有頭螺絲(半牙) 110091		FXX Alum. integrated shaft joint ×1 FXX 鋁合金一體式接杯 210385		10×12×0.1 Spacer ×2 墊片 820022		5×8 Ball bearing ×18 培林 120003
	M2.5×12 Screw ×4 圓頭螺絲 110065		Steel CVD great angle universal shaft 38.5 ×2 鋼製大角度CVD傳動軸 38.5 820010		FXX Steering arm post ×2 FXX 轉向搖臂支柱 310056		10×12×0.3 Spacer ×1 墊片 820024		5×11 Ball bearing ×1 培林 120011
	M3×6 screw ×3 圓頭螺絲 110001		M3×20 Steel turnbuckle ×2 鋼製可調拉桿 810002		2.5×5 Suspension balls ×8 插銷球頭 210321		5×7×0.1 Spacer ×5 墊片 820018		5×10 Ball bearing ×4 培林 120002
	M3×8 screw ×20 圓頭螺絲 110002		M3×16 Alum. turnbuckle ×4 鋁製可調拉桿 (810006)		E-clip 3.0 ×1 E扣 3.0 110070		5×7×0.3 Spacer ×9 墊片 820020		6×10×3 Ball bearing ×1 培林 120014
	M3×10 screw ×7 圓頭螺絲 110026		M3×25 Alum. turnbuckle ×4 鋁製可調拉桿 (210167)		Cross joint ×2 連接軸 820030		4×6×0.1 Spacer ×1 墊片 820015		8×14 Ball bearing ×1 培林 120007
	M3×12 screw ×2 圓頭螺絲 110029		Diff. spring ×1 滾差彈簧 310032		M3×68 Alum. turnbuckle 鋁製可調拉桿 (210218)		4×6×0.3 Spacer ×1 墊片 820017		10×15 Ball bearing ×2 培林 120001
	M3×16 screw ×2 圓頭螺絲 110086		Steel ball 3.0 ×8 鋼珠 3.0 110020				3×5×0.3 Spacer ×8 墊片 820014		
	4.8 Ball connector ×11 外六角球頭 210161								
	4.8 Ball connector L ×3 外六角球頭(長) 210344								

PARTS

Please add color remark for () part number. e.g. 210123R for Red (210123)
請增加顏色標示在 () 編號 例: 210123R for 紅色 (210123)

Color 顏色	Remark 標示
Red 紅 / Silver 銀	R / S

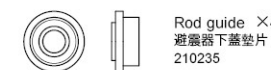
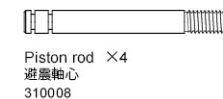
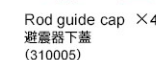
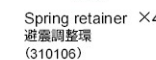
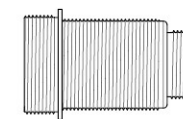
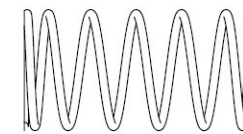
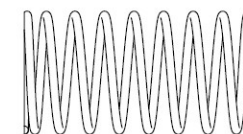
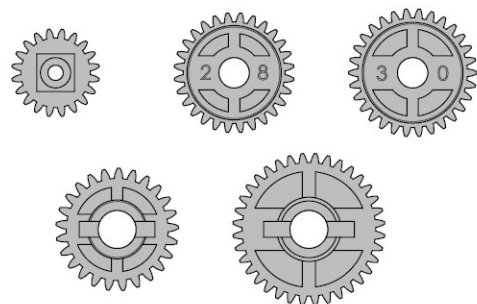
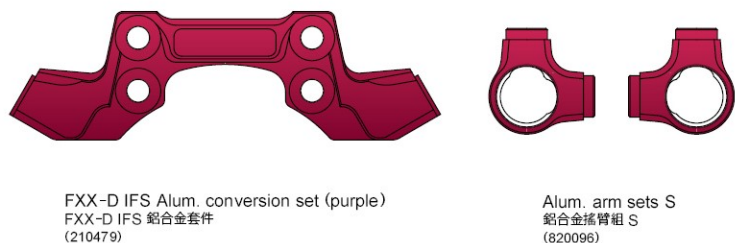
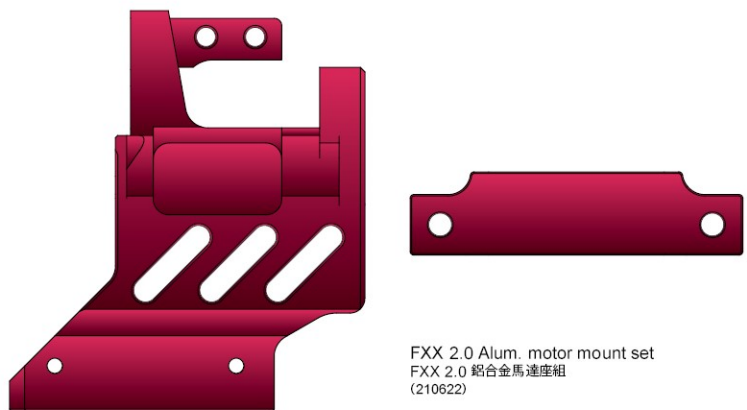

PARTS

Please add color remark for () part number, e.g. 210123R for Red (210123)
請增加顏色標示在 () 編號 例: 210123R for 紅色 (210123)

Color 顏色	Remark 標示
Red 紅 / Silver 銀	R / S

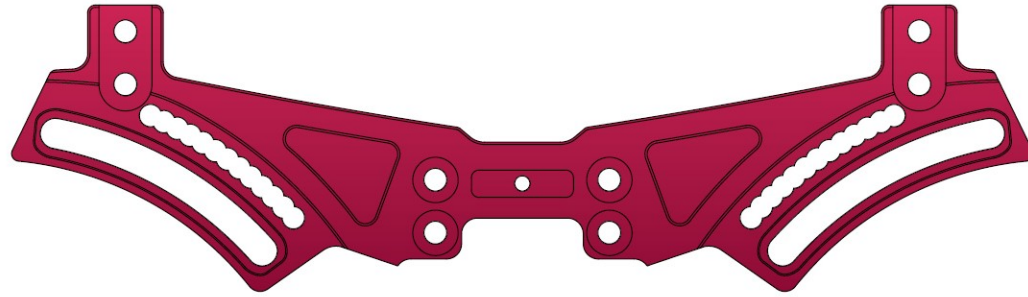

FXX Alum. rear quick adj. damper stay
FXX 鋁合金快調式後避震架
(210478)

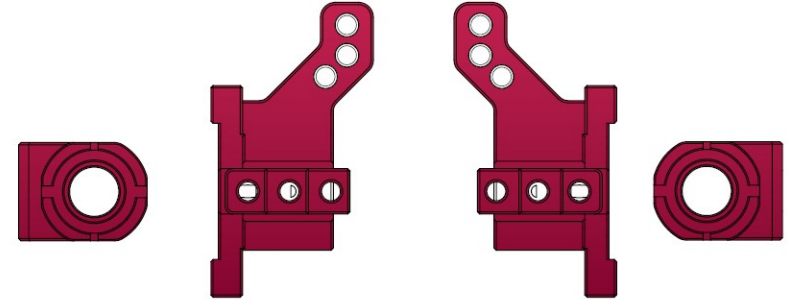

MB Alum. Rear upright set
MB 鋁合金後輪座組
(210620)



Carbon bumper support L 2.5
碳纖維前壓板 L 2.5
210610



MST-PVC Sticker ×8
MST-PVC貼紙
710001



Alum. adjustable post set ×2
鋁合金可調支柱組
(210626)



Alum. antenna pipe mount
鋁合金天線管座
(820066)

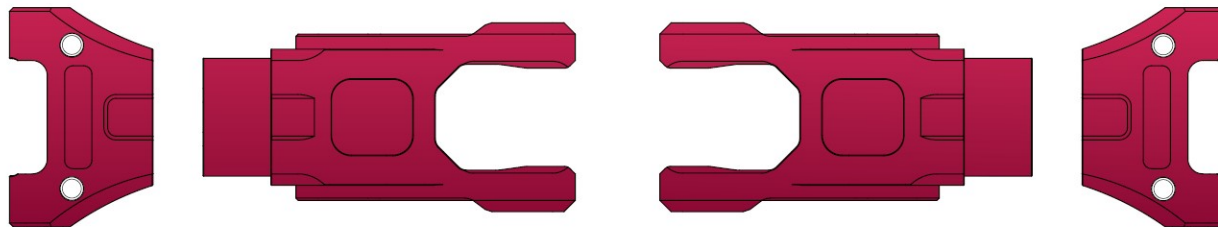

MB Alum. Rear lower arm set
MB 鋁合金後下擺臂 (紅)
(210616)



FXX Alum. bearing holder
FXX 鋁合金二樓板培林架
(210341)

PARTS

Please add color remark for () part number, e.g. 210123R for Red (210123)
請增加顏色標示在 () 編號 例: 210123R for 紅色 (210123)

Color 顏色	Remark 標示
Red 紅 / Silver 銀	R / S

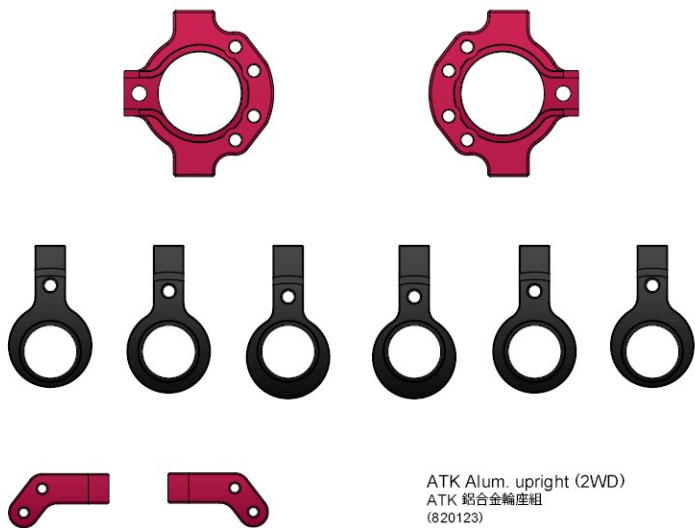

ATK Alum. upright (2WD)
ATK 鋁合金輪座組
(820123)



Alum. suspension mount (+0.5) × 2
鋁合金擺臂座 (+0.5)
(820037)



RMX 2.0 Alum. upper arm set
RMX 2.0 鋁合金上擺臂組
(210575)



Alum. 8-adjusting servo saver
鋁合金8段調整緩衝組
(820127)

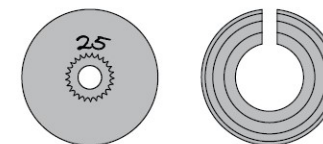

Universal servo saver set
通用型伺服緩衝組
820042

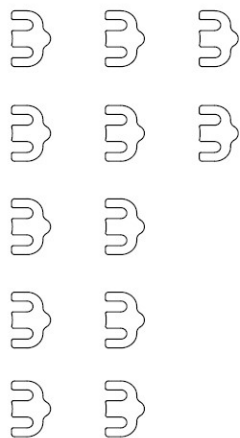

ATK Upright spacer × 12
ATK 輪座墊片
820123-1

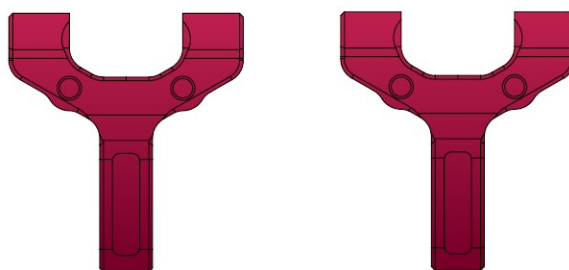

Alum. front lower arm set
鋁合金前下擺臂組
(820117)



Adjustable alum. suspension mount (+1.5~+3.0) × 2
可調式鋁合金擺臂座 (+1.5~+3.0)
(820058)



Arm shaft bush set
擺臂插銷襯套組
(210068)

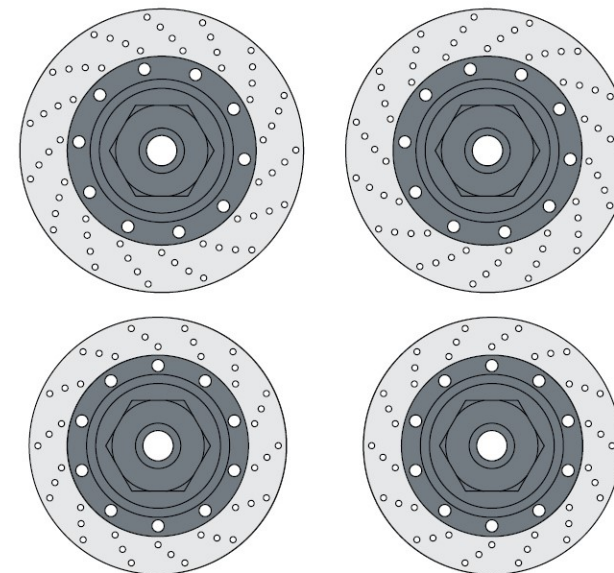

Alum. wheel hubs 6mm (large brake disc shaped)
鋁合金六角輪座6mm (加大煞車碟型)
210492

PARTS

Please add color remark for () part number. e.g. 210123R for Red (210123)
請增加顏色標示在 () 編號 例: 210123R for 紅色 (210123)

Color 顏色	Remark 標示
Red 紅 / Silver 銀	R / S

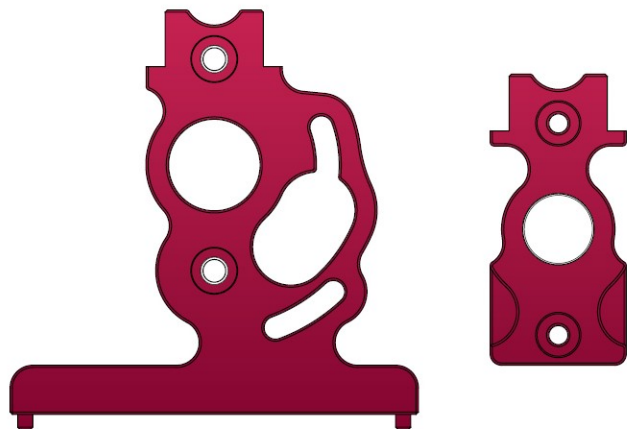

FXX 2.0 Alum. reducer case set
FXX 2.0 鋁合金減速箱組
(210624)

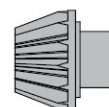
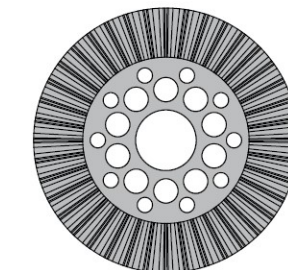

Bevel gear set 42-11
傘齒組 42-11
210036

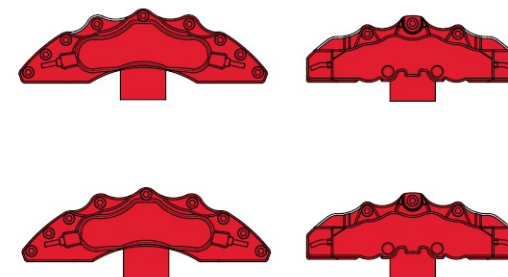

Enlarged brake calipers (red)
加大剎車卡鉗 (紅)
210510CR

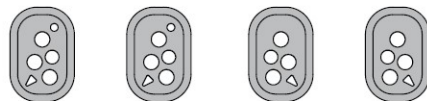

Shaft bush & spacer set
襯套墊片組
230070



Alum. servo mount
鋁合金伺服機座
(820125)



5.8 Ball end bush
球頭襯套
(820054)



4.8 Rod ends set (M/S) × 2
4.8 拉桿頭組 (M/S)
230067



Swing shaft protector
傳動軸軸套
210121-1

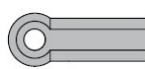

Reinforced adjuster set 4.8 × 18 × 6
強化拉桿頭組
210047

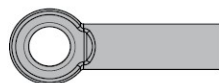

Reinforced adjuster set 5.8 × 26 × 2
強化拉桿頭組
210031

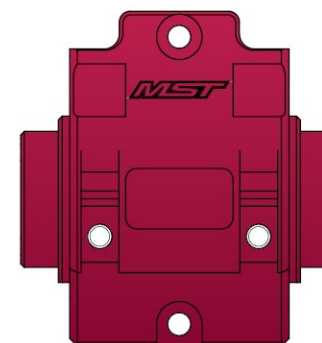
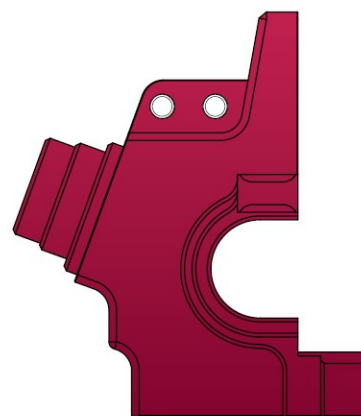

FXX Alum. rear gear box
FXX 鋁合金後齒箱
(210384)

PARTS

Please add color remark for () part number. e.g. 210123R for Red (210123)
請增加顏色標示在 () 編號 例: 210123R for 紅色 (210123)

Color 顏色	Remark 標示
Red 紅 / Silver 銀	R / S

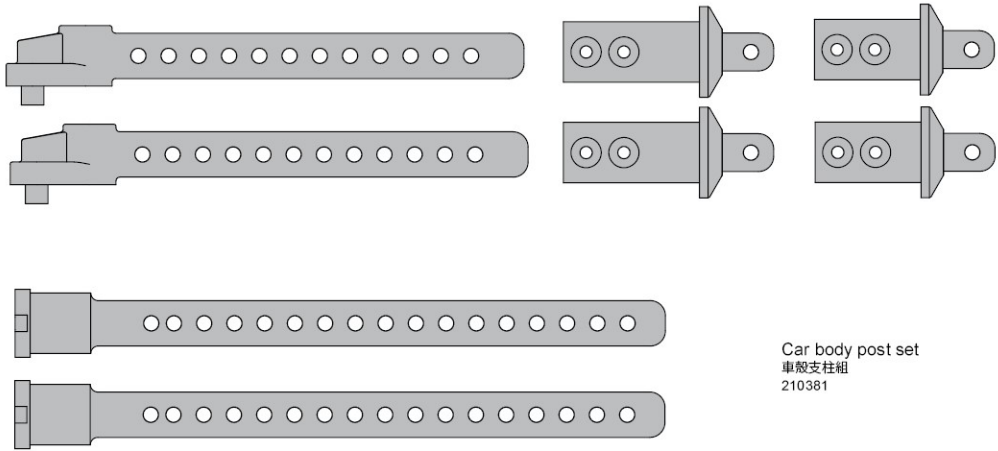

Car body post set
車殼支柱組
210381

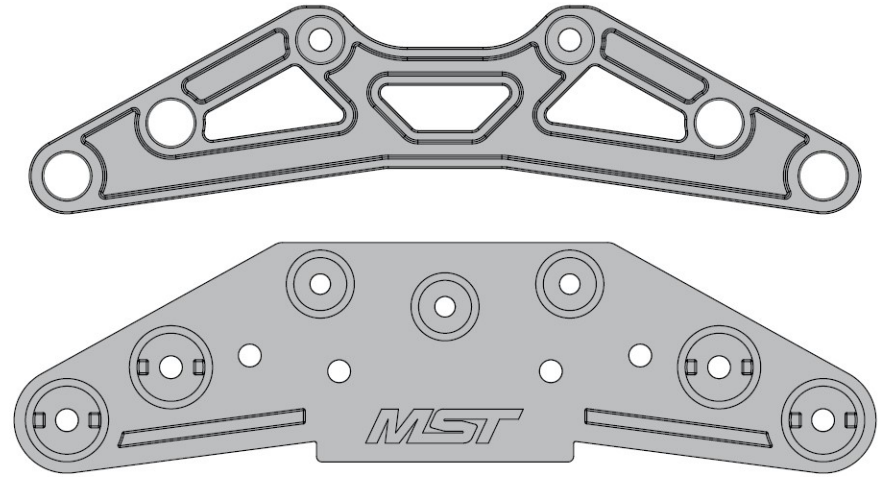

F & R Bumper set
前後防撞板組
230121

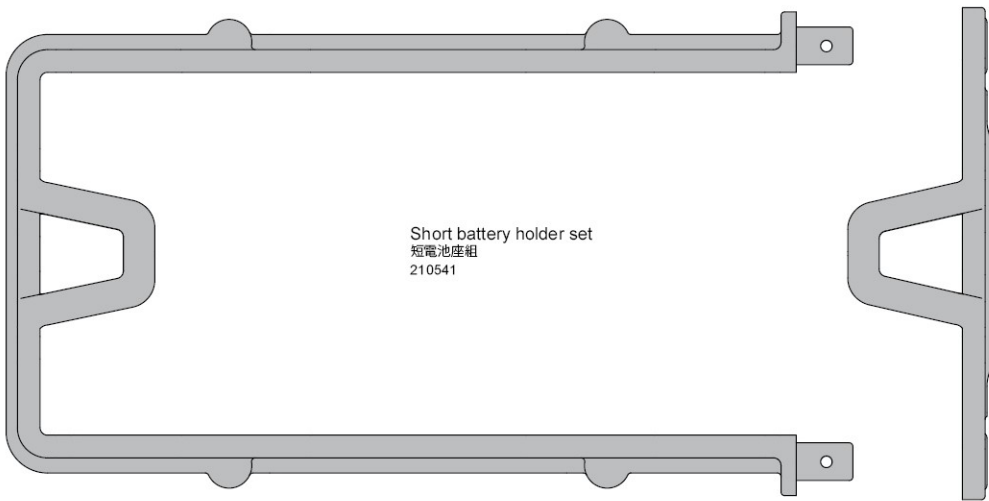

Short battery holder set
短電池座組
210541

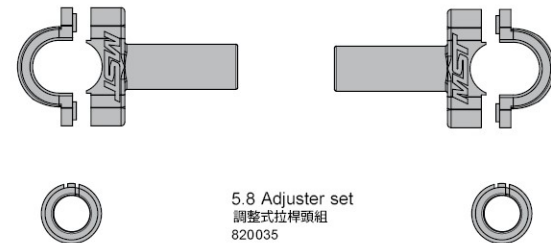

5.8 Adjuster set
調整式拉桿頭組
820035

PARTS

Please add color remark for () part number. e.g. 210123R for Red (210123)
請增加顏色標示在 () 編號 例: 210123R for 紅色 (210123)

Color 顏色	Remark 標示
Red 紅 / Silver 銀	R / S

FXX 2.0 KMW Carbon lower deck 3.5
FXX 2.0 KMW 碳纖維底盤 3.5

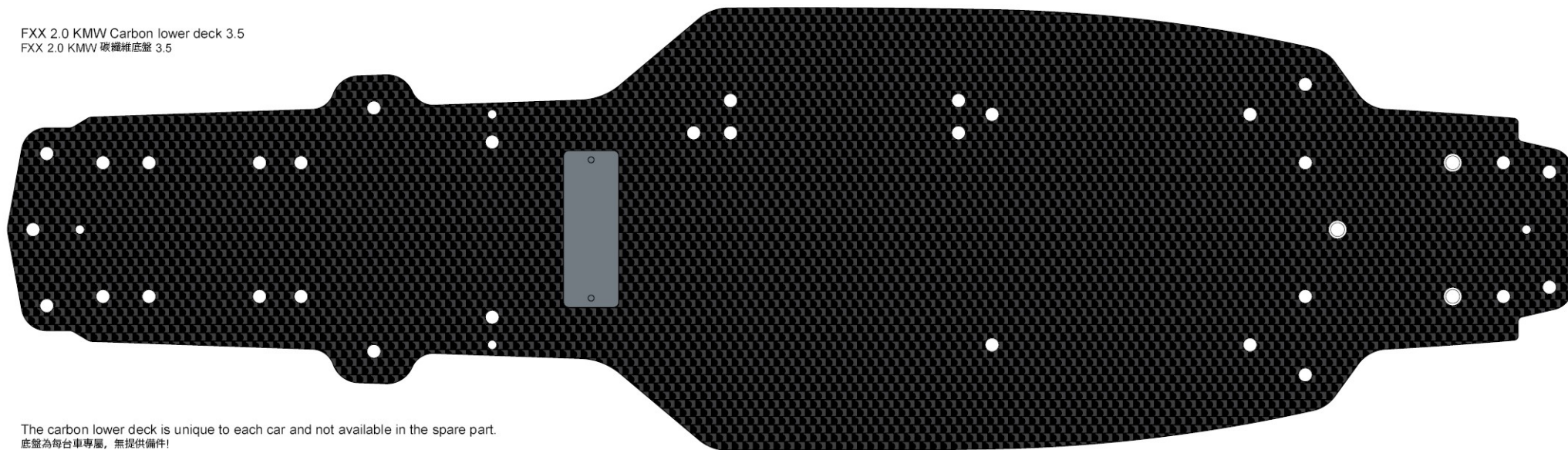

The carbon lower deck is unique to each car and not available in the spare part.
底盤為每台車專屬，無提供備件！

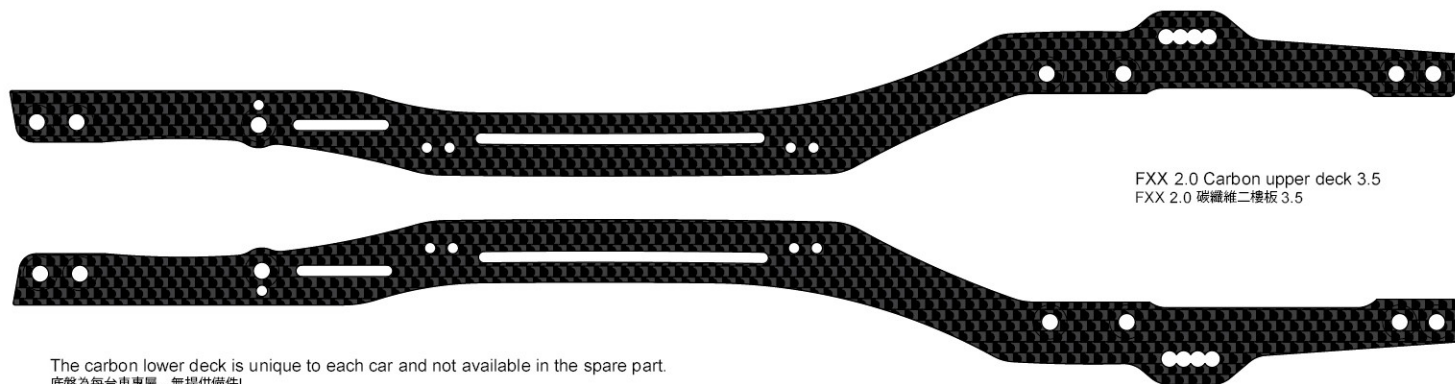

FXX 2.0 Carbon upper deck 3.5
FXX 2.0 碳纖維二樓板 3.5

The carbon lower deck is unique to each car and not available in the spare part.
底盤為每台車專屬，無提供備件！

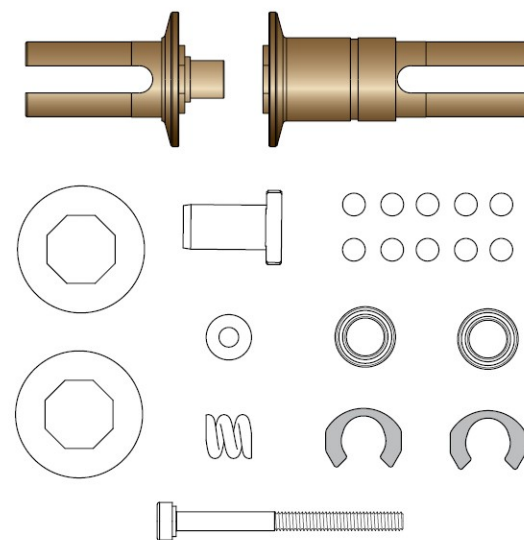

FXX Alum. ball diff.
FXX 鋁合金滾珠差速器
210353



FXX Strengthen high gear ratio rear drive shaft set
FXX 強化高齒比後軸組
(210442)

