













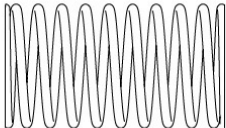
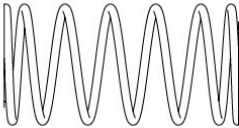











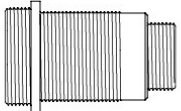
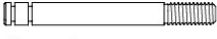









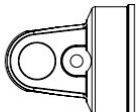





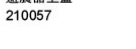









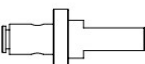







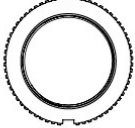









PARTS

	M2×4 Screw ×8 圓頭螺絲 110004		2.6×5.8×0.6 Spacer ×1 墊片 110080		M3×8 Screw ×4 六角半圓頭帶墊片螺絲 110120		E-clip 2.5 ×1 E形扣 110079		Soft coil spring 31mm ×2 (purple-yellow) 軟避震彈簧 31mm (紫黃) 820104-4		Hard coil spring 31mm ×2 (red) 硬避震彈簧 31mm (紅) 820103-4
	M2×6 Screw ×1 圓頭螺絲 110044		3×6×0.5 Spacer ×7 墊片 110047		M3×3 Screw ×3 止付螺絲 110035		E-clip 3.0 ×1 E形扣 110070				
	M2×8 Screw ×2 圓頭螺絲 110063		3×8×0.5 Spacer ×1 墊片 110048		M3×10 Screw ×1 止付螺絲 110032		Cross joint ×2 連接軸 820030				
	M2×8 Screw ×4 圓頭螺絲(半牙) 110045		5×7×0.1 Spacer ×2 墊片 820018		M3×20 Screw ×2 止付螺絲 110009		1.5×7.8 Shaft ×2 插銷 110059		Damper cylinder ×4 避震筒身 210071		Piston rod ×4 避震軸心 310008
	M2.5×5 Screw ×1 圓頭螺絲 110102		5×7×0.3 Spacer ×2 墊片 820020		4.8 Ball connector ×7 外六角球頭 210161		2×9.8 Shaft ×7 插銷 110017				Piston ×4 避震活塞 210082
	M3×6 Screw ×4 圓頭螺絲 110001		3×6×2.5 Bearing ×4 軸承 120024		4.8 Ball connector L ×2 外六角球頭(長) 210344		2×22 Shaft ×2 插銷 310047		Damper adjuster ×4 避震器拉桿 820079		Damper adjuster ×4 避震器拉桿 820079
	M3×8 Screw ×26 圓頭螺絲 110002		5×7×0.3 Spacer ×2 墊片 820020		4.8 Ball connector L ×2 外六角球頭(長) 210344		2×28 Shaft ×2 插銷 310103		Cylinder cap ×4 避震器上蓋 210057		10.8×0.9 O-ring ×4 O環 130032
	M3×10 Screw ×10 圓頭螺絲 110026		5×8 Bearing ×4 軸承 120017		4.8×4.5 Ball connector ×9 球頭螺絲 310001		2.5×46 Arm shaft ×4 擺臂插銷 310048				Rod guide cap ×4 避震器下蓋 210057
	M3×14 Screw ×6 圓頭螺絲 110061		4×10 Ball bearing ×1 培林 120018		5.8×4 Ball connector (L) ×4 球頭螺絲(長) 210491		Bevel gear shaft ×1 傘齒軸 310102		Damper retainer ×4 避震器彈簧座 820079		12×1 O-ring ×4 O環 130049
	M3×16 Screw ×1 圓頭螺絲 110086		5×8 Ball bearing ×4 培林 120003		M3×30 Screw ×1 有頭螺絲(半牙) 110100		R-clip 5.0 ×4 R銷 5.0 820075		Oil seal ×4 避震器氣室 130004		Spring retainer (red) ×4 避震器調整環(紅) 310106R
	M3×4 screw ×4 沉頭螺絲 110099		5×10 Ball bearing ×1 培林 120002		M3×40 Screw ×5 有頭螺絲(半牙) 110091		Suspension mount spacer 0.5mm ×3 擺臂座墊片 0.5mm 820063		Rod guide ×4 避震器下蓋墊片 210082		Damper O-ring P3 ×4 避震器O環 130028
	M3×8 Screw ×25 沉頭螺絲 110005		5×11 Ball bearing ×2 培林 120011		2WD Axle ×2 二驅輪軸 820095		Main shaft ×1 主齒軸 310105				
	M3×10 Screw ×10 沉頭螺絲 110052		8×12 Ball bearing ×2 培林 120019		Wheel axle ×2 萬向接杯 310006		Steel CVD universal shaft 48 ×2 鋼製CVD傳動軸 48 820007				
	M3×12 Screw ×2 沉頭螺絲 110043		10×15 Ball bearing ×4 培林 120001								
	M3×18 Screw ×2 沉頭螺絲 110078										
	M3×20 Screw ×2 沉頭螺絲 110101										

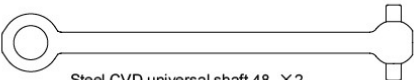
PARTS

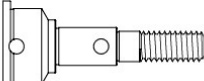

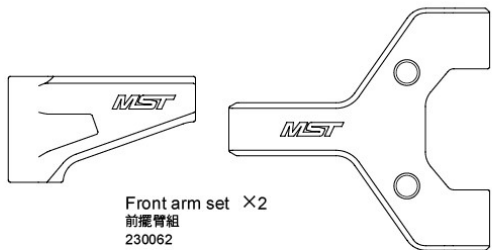
Front arm set ×2
前擺臂組
230062



×1 ×1 ×2

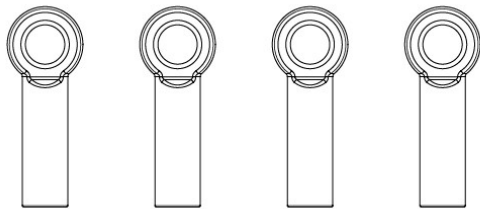

5.8×26 Reinforced adjuster set
強化拉桿頭組
210031

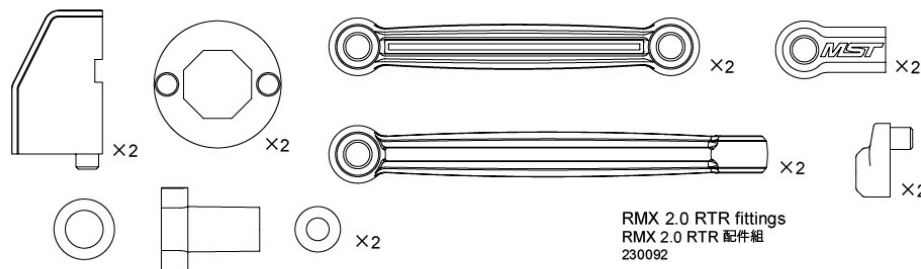

RMX 2.0 RTR fittings
RMX 2.0 RTR 配件組
230092

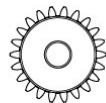

Pinion gear 48P-22T ×1
馬達齒
148022

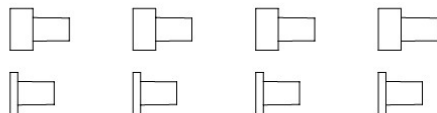

Shaft bush & spacer set (white)
襯套墊片組 (白)
210063(W)

Alum. motor mount (red)
鋁合金馬達座 (紅)
310101R

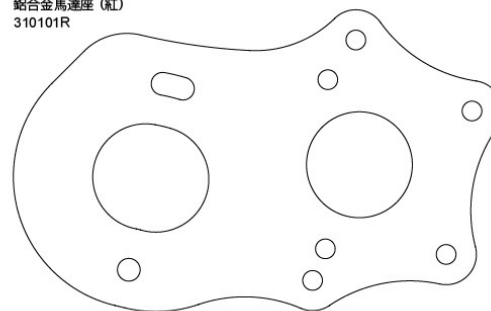

Enlarged brake calipers (red)
加大剎車卡鉗 (紅)
210510CR



ATK Front wheel hubs
前輪座組
230066

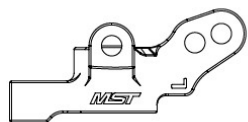

Bevel gear 16T ×2
傘齒 16T
310064

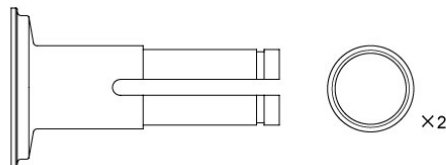

Ball diff. joint
滾差接杯組
230059

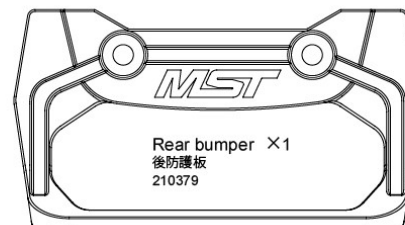
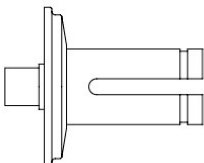

Rear bumper ×1
後防護板
210379

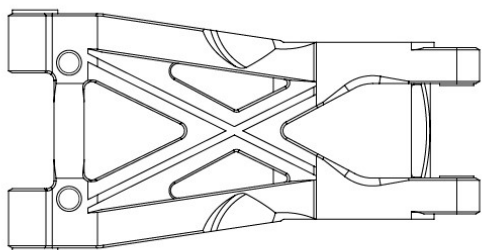

HT Rear lower arm (4hole) & wheel hub ×2
HT 後下擺臂 (4孔) & 輪座
210070-1

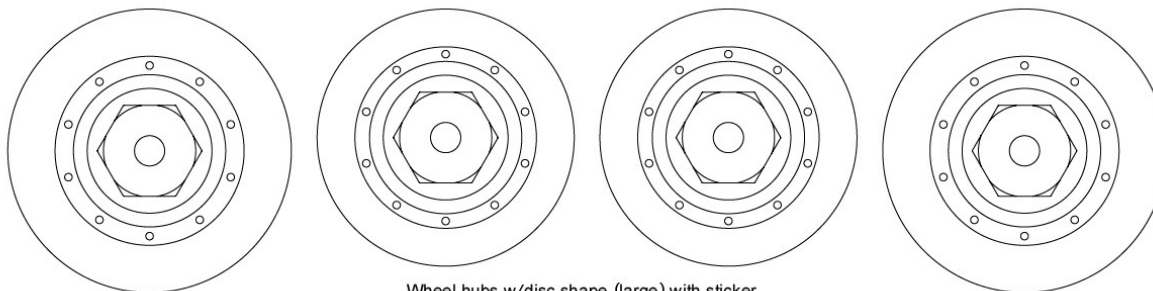
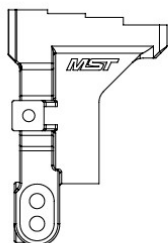

Wheel hubs w/disc shape (large) with sticker
碟型六角輪座組 (加大型) 附貼紙
230041

PARTS

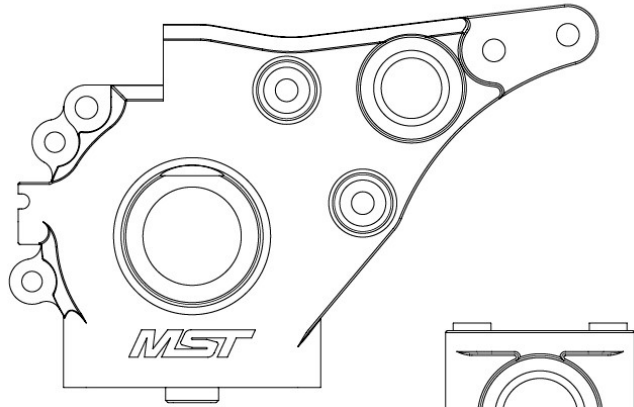

Rear gear box set
後齒箱組
230061-1

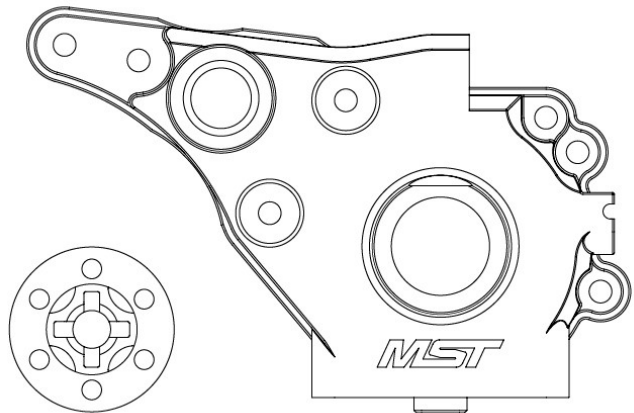

Front dmaper stay
前避震架
230063

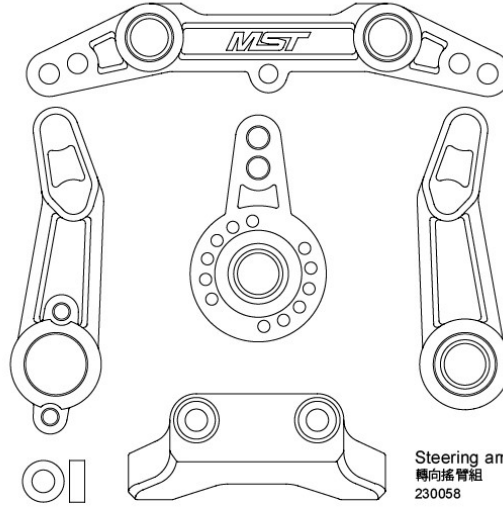

Steering arm set
轉向搖臂組
230058

Spur gear 48P 80T
大直齒
230068

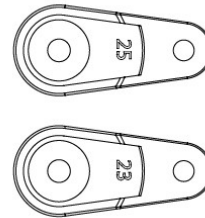
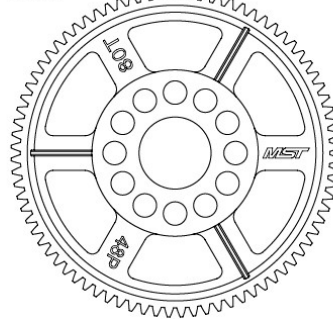

Servo horn set (23T/25T)
伺服機舵片組 (23T/25T)
210032

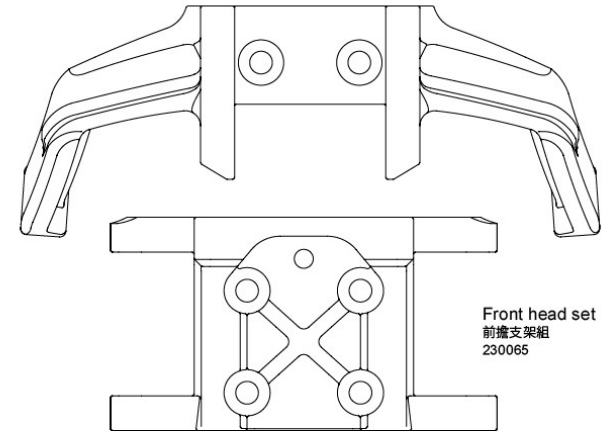

Front head set
前搖支架組
230065

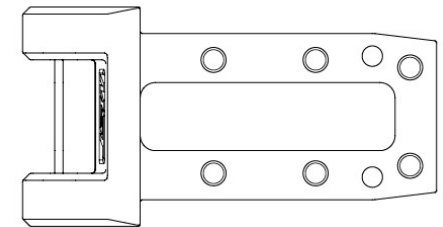

Rear dmaper stay
後避震架
230064

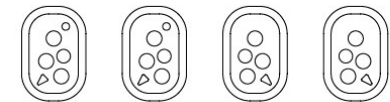

Shaft bush & spacer set
襯套墊片組
230070

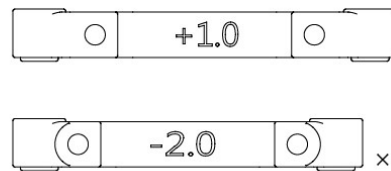
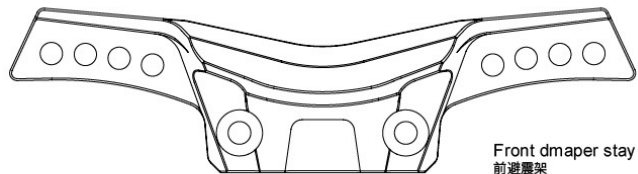

Suspension mount set (+1.0 / -2.0)
下擺臂座組 (+1.0 / -2.0)
230069

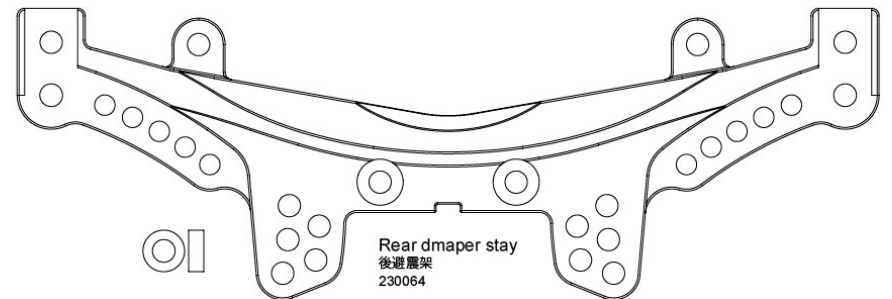

PARTS

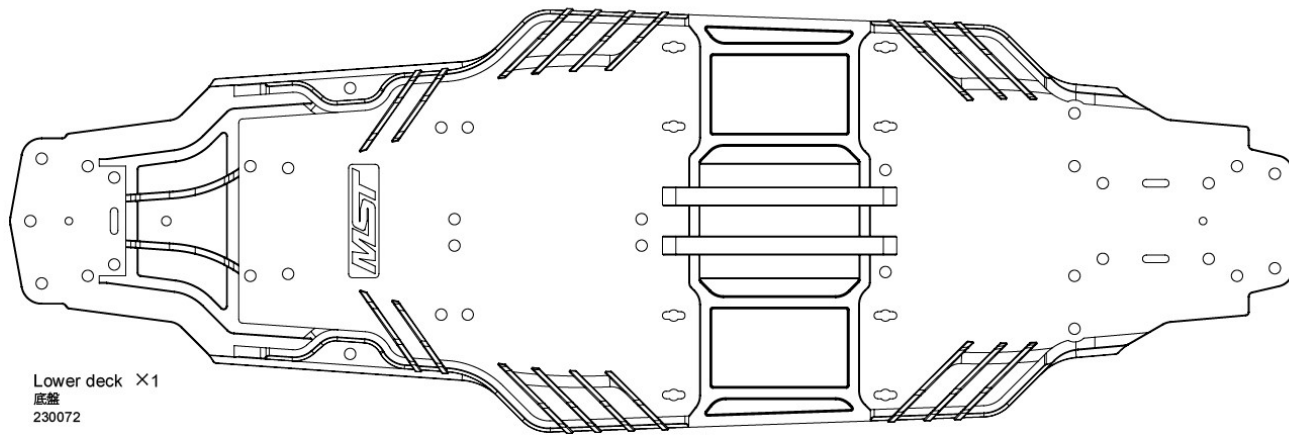

Lower deck ×1
底座
230072

C PARTS-bumper set ×1
防撞板組
210002

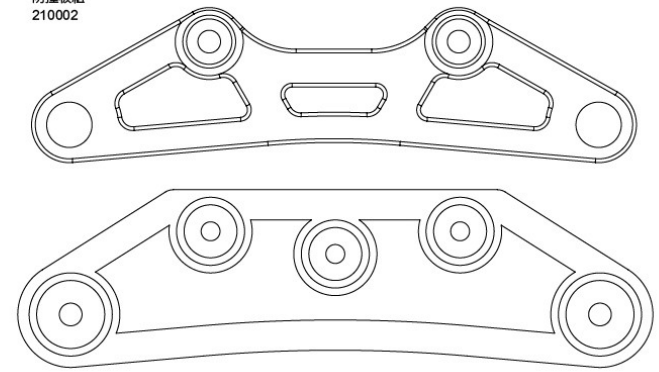

Bevel gear set 36-17
傘齒組 36-17
210034

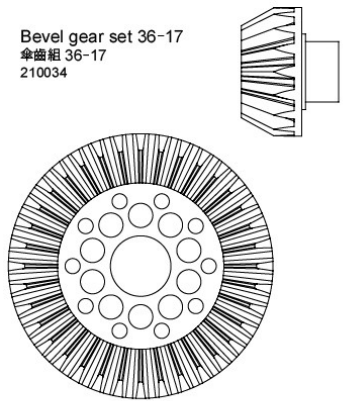

Upper deck connector
二樓板後連結座組
230071

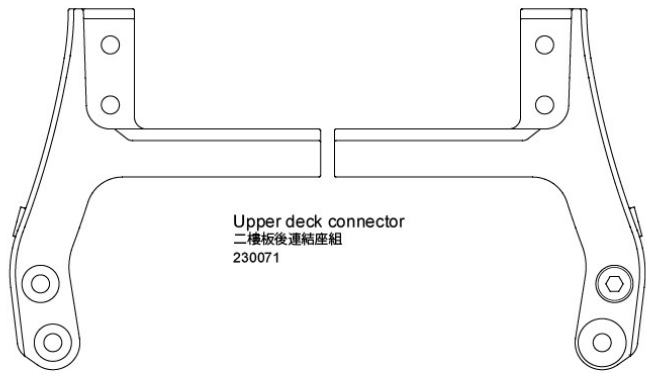

Bumper (A)
防撞泡棉 (A)
130005

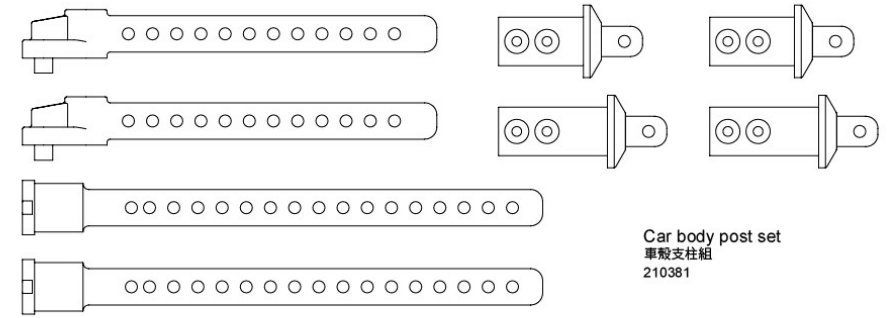
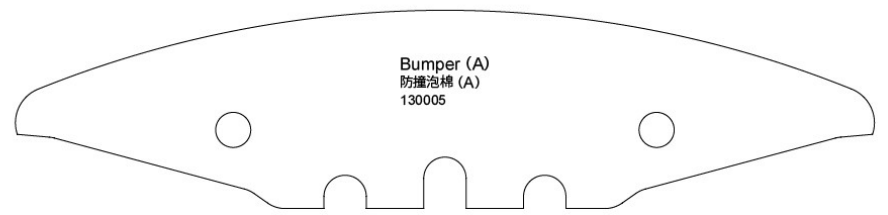

Car body post set
車殼支柱組
210381

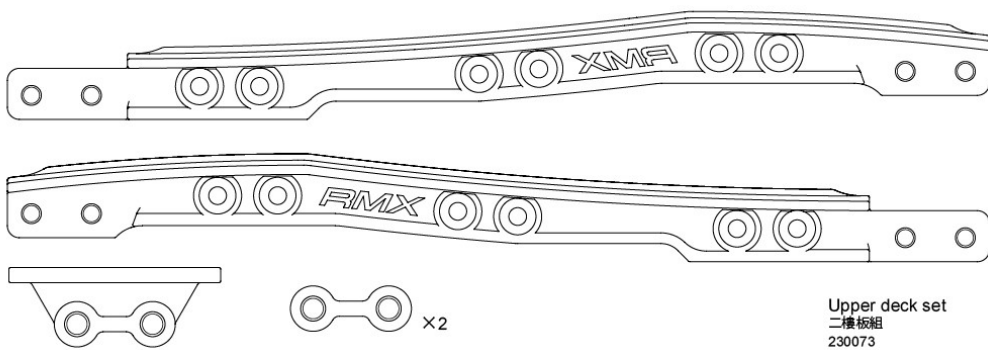

Upper deck set
二樓板組
230073

Battery holder set
電池座組
230060

