



MST
MAX SPEED TECHNOLOGY

RMX 2.0 RTR

1/10 SCALE RC RWD HIGH PERFORMANCE DRIFT CAR

EXPLODED MANUAL

ON ROAD USE ONLY

SPECIFICATION: 1:10 Drift Car
WHEELBASE: 257mm
WIDTH: 190mm
DRIVE MODE: RWD
CASTER: Adjustable 6/ 8/ 10/ 12 degrees
FULL BALL BEARING
TRANSMISSION SYSTEM
HYDRAULIC DAMPER SET

www.rc-mst.com

※ SPECIFICATION ARE SUBJECT TO CHANGE WITHOUT NOTICE

RMX 2.0 RTR

1/10 SCALE RC RWD HIGH PERFORMANCE DRIFT CAR

Appreciate for your choice of RMX 2.0 RTR! You will be impressed with its performance and beauty. Please prepare additional parts as car battery, transmitter battery, and charger. Please follow the process for assemble and setting of parts package. If you have doubt or need assistance, please contact the purchased shop or hobby shop for help, many thanks!

首先感謝你購入 RMX 2.0 RTR 這項產品，您將擁有一部兼具性能與美型的甩尾車。在首次操作前，有以下幾項須要另行購置的物件；車用電池、遙控器用電池、充電器。備妥上述物件後，請進行零件包安裝與設定。如需其他協助，請向原購買店家，或遙控模型店詢問！謝謝！

PLEASE FOLLOW BELOW OPERATIONS BEFORE ASSEMBLING 請於安裝零件包之前，執行以下操作 THE PARTS PACKAGE.



- | | |
|---|----------------------------|
| ① Install transmitter batteries. | ① 安裝遙控器電池 |
| ② Loosen receiver antenna. | ② 鬆開接收機天線 |
| ③ Connector ESC and battery. | ③ 聯結車用電池與電子變速器 |
| ④ Switch on the transmitter. | ④ 打開遙控器電源 |
| ⑤ Switch on the ESC. | ⑤ 打開電子變速器電源 |
| ⑥ Stand the car around 3 seconds till the front wheels turn once in the left / right direction. | ⑥ 靜置約3秒至前輪左右擺動 |
| ⑦ Individually turn the left / right direction of the remote control to the end to complete the boot process. | ⑦ 將遙控器方向左/右個別轉到底一次，即完成開機步驟 |

※ Please play this product in opening safe area. 請於空曠或安全無虞的場所，使用本項產品。

※ The default setting had been completed. 出廠時，基本設定已設定完成。

※ RMX 2.0 RTR electronics (Transceiver set/ESC/Gyro) are set by factory and can be directly used after attaching battery. Please refer to instructions for adjusting. RMX 2.0 RTR 之電子設備 (遙控器組/電子變速器/陀螺儀) 已經過原廠設定，玩家可於安裝電池後立即使用；如需依個人習慣調整時，再翻閱說明書。



※ Please refer to transmitter & receiver performance instructions. 遙控器&接收機功能說明請參閱詳細說明書。

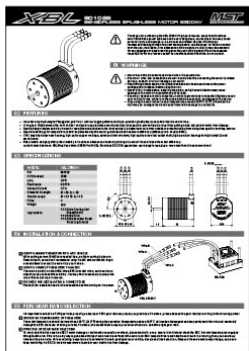

※ Please refer to ESC performance instructions. 電子變速器功能說明請參閱詳細說明書。

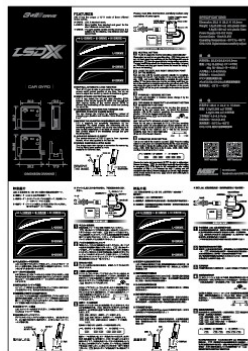

※ Please refer to LSD X CAR GYRO performance instructions. 陀螺儀功能說明請參閱詳細說明書。

Servo plugged into steering (Ch. 1)

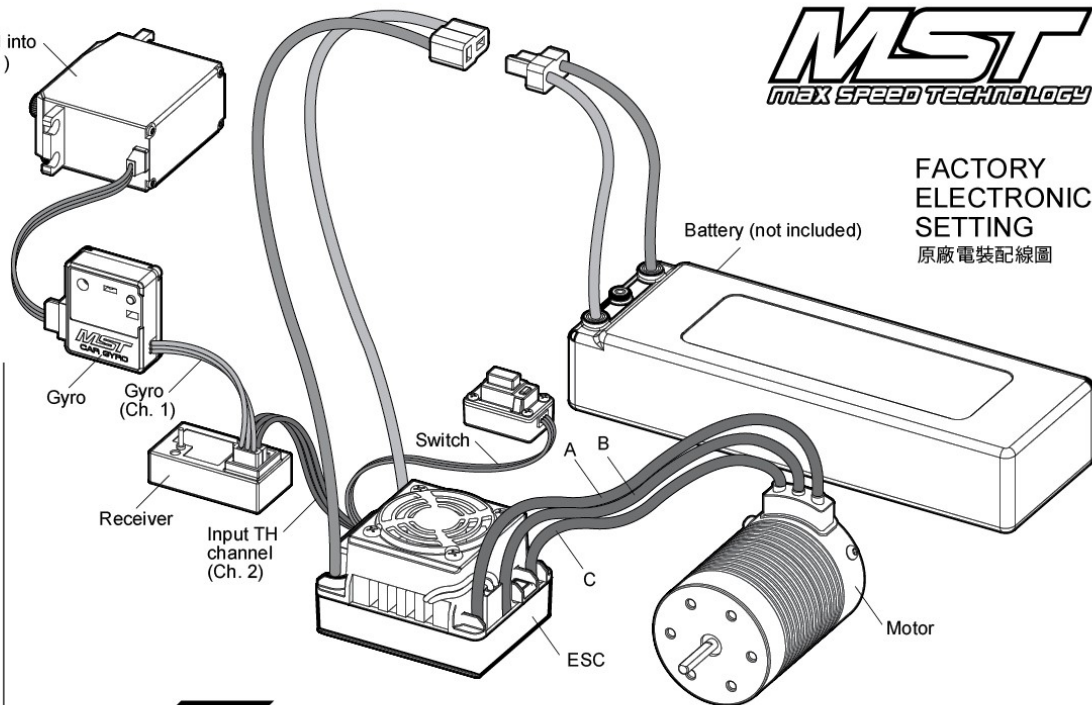

STEP 1 Pasting Sponge 貼上吸震泡棉

※ Please cut along the dashed line. 請沿虛線剪開。

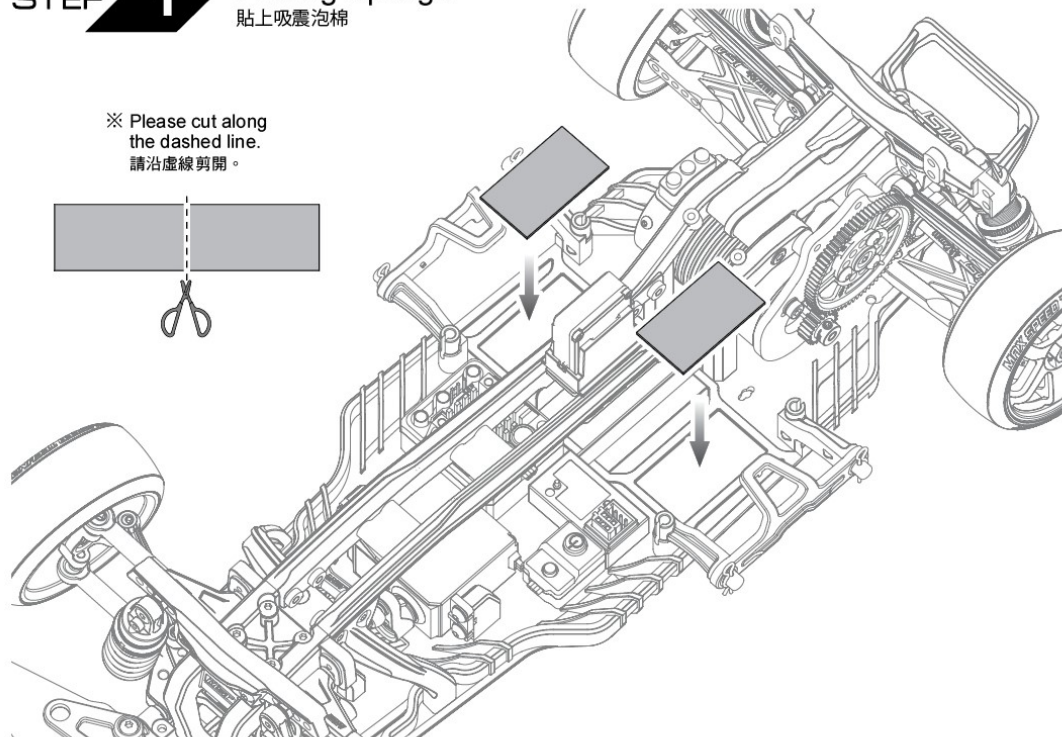

STEP 2 Attaching Battery
安裝電池

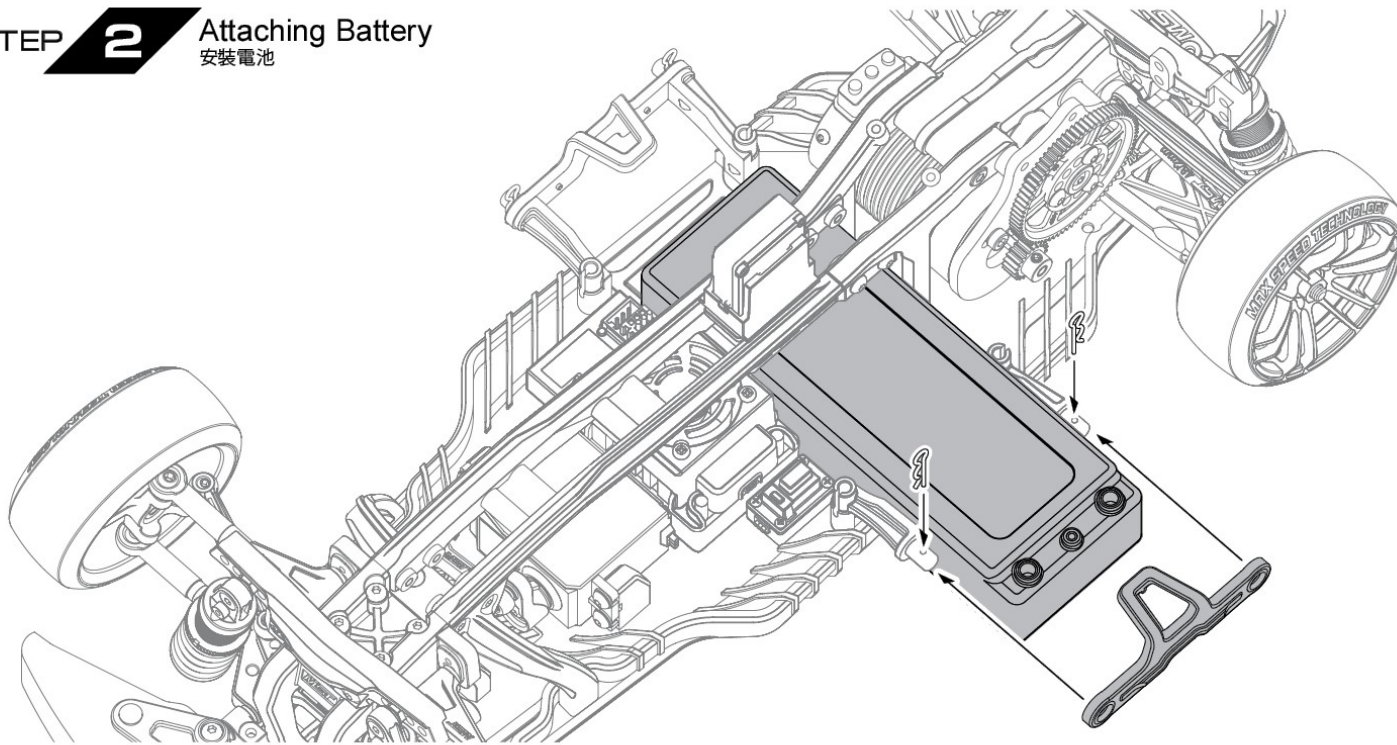

- ※ The assembly and conservation method may be different by specification of battery.
電池的安裝方式會因為廠牌規格而有些微差異，電池的使用方式與保存方式，也會因電池的種類而有所不同。
- ※ Recommended battery measurement L140×W48×H25.4mm (not exceed)
建議安裝長140×寬48×高25.4mm尺寸以內的電池。

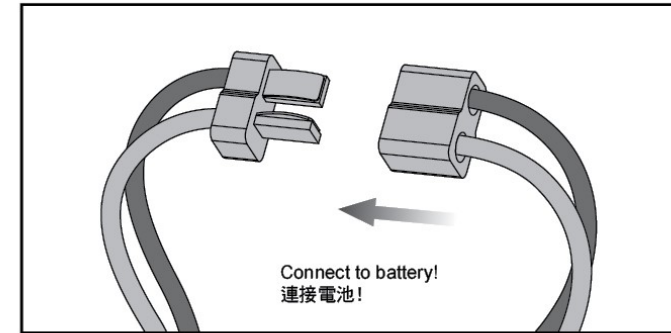

- ※ Please play in safe place after all setting finish.
Before playing, please switch on transmitter then on the car.
Please switch off reversely.
安裝設定完成後，請於安全場所使用本產品！
使用前請先開啟遙控器電源後再開啟車體電源！
使用後請反向操作關閉！





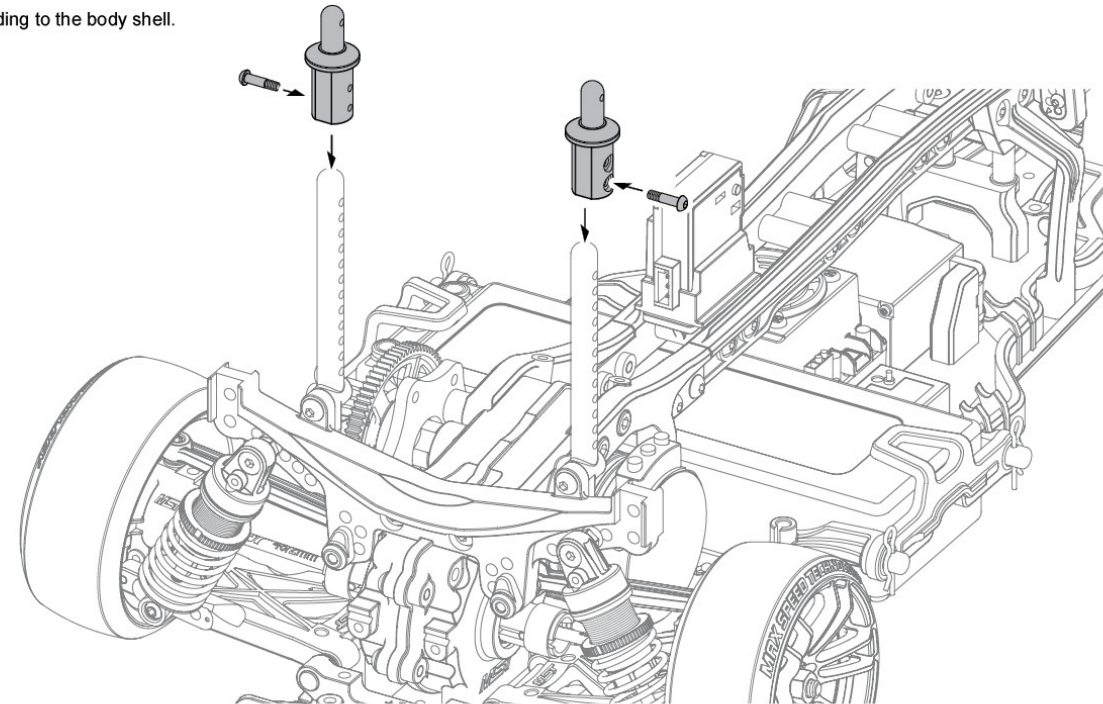
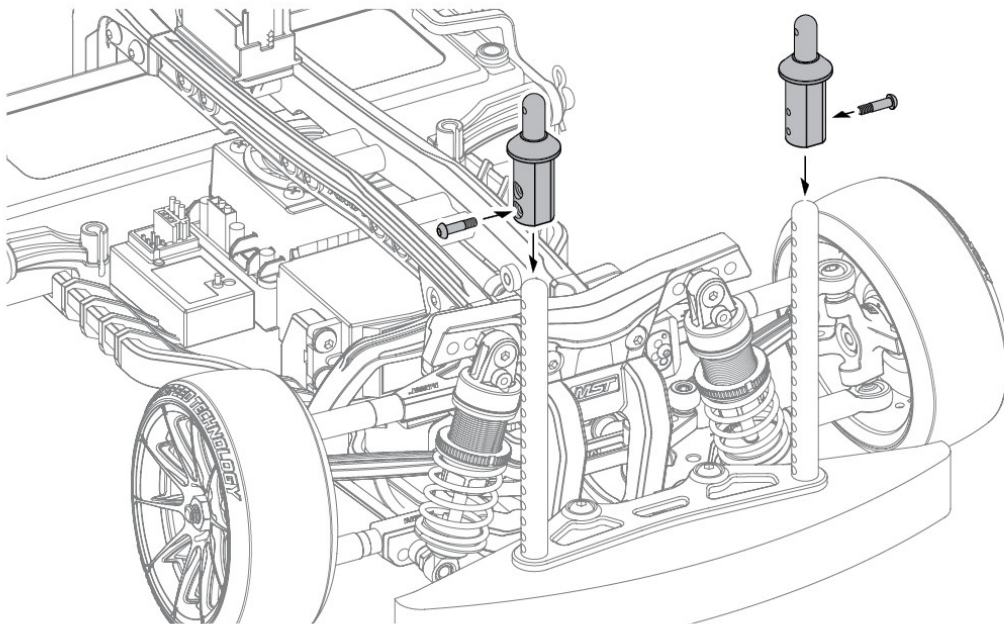

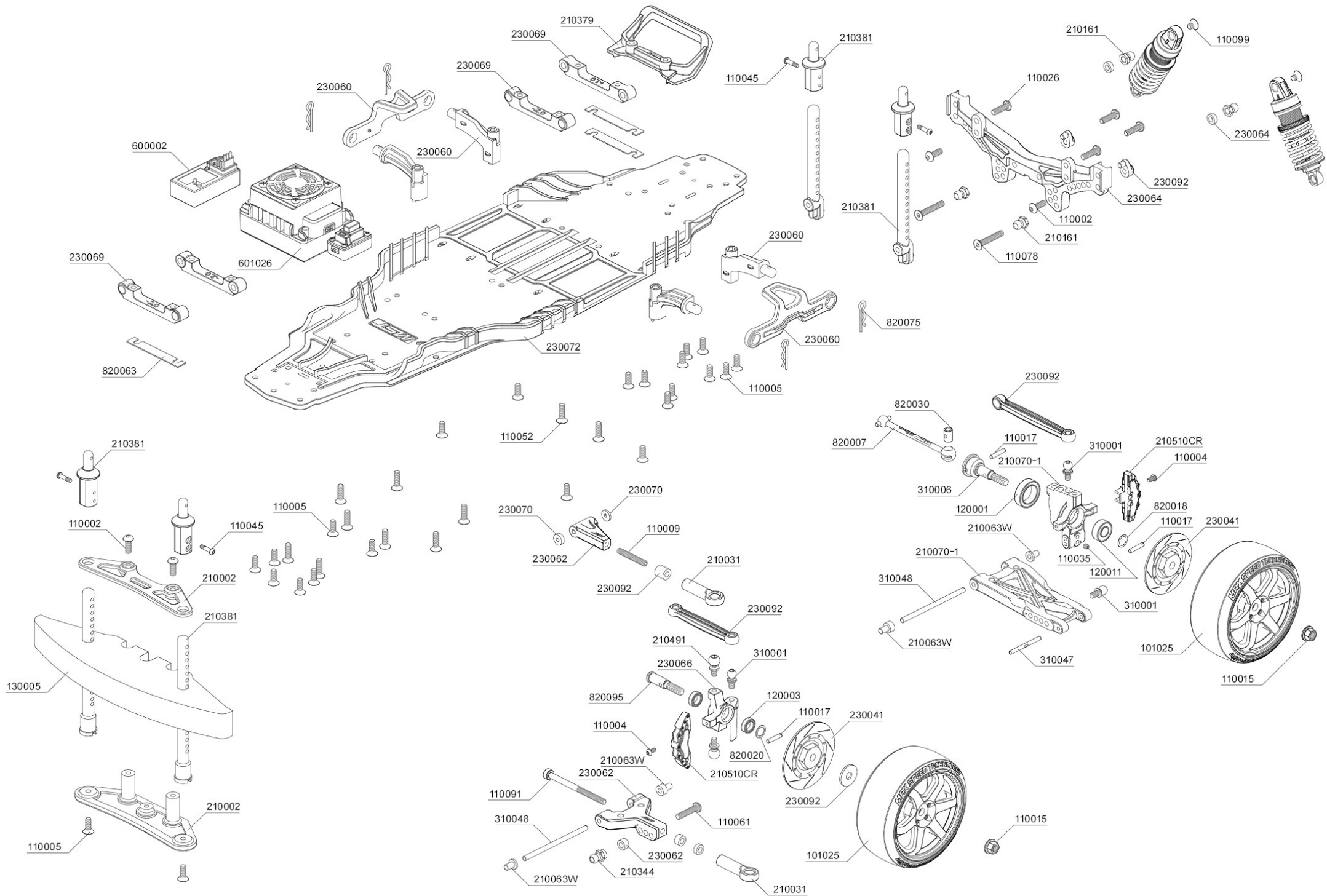







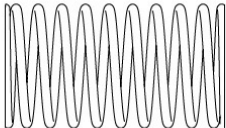
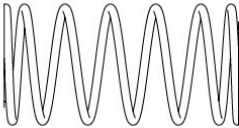











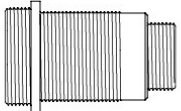
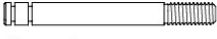









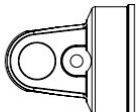





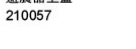









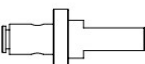







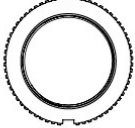







STEP 3 Attaching Body Mount
車殼浮動架安裝

- ※ Adjust the body mount highness according to the body shell.
依照車殼調整浮動架高度。



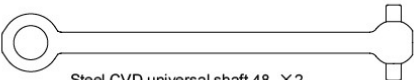

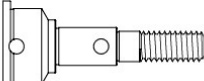
PARTS

	M2×4 Screw ×8 圓頭螺絲 110004		2.6×5.8×0.6 Spacer ×1 墊片 110080		M3×8 Screw ×4 六角半圓頭帶墊片螺絲 110120		E-clip 2.5 ×1 E形扣 110079		Soft coil spring 31mm ×2 (purple-yellow) 軟避震彈簧 31mm (紫黃) 820104-4		Hard coil spring 31mm ×2 (red) 硬避震彈簧 31mm (紅) 820103-4
	M2×6 Screw ×1 圓頭螺絲 110044		3×6×0.5 Spacer ×7 墊片 110047		M3×3 Screw ×3 止付螺絲 110035		E-clip 3.0 ×1 E形扣 110070				
	M2×8 Screw ×2 圓頭螺絲 110063		3×8×0.5 Spacer ×1 墊片 110048		M3×10 Screw ×1 止付螺絲 110032		Cross joint ×2 連接軸 820030				
	M2×8 Screw ×4 圓頭螺絲(半牙) 110045		5×7×0.1 Spacer ×2 墊片 820018		M3×20 Screw ×2 止付螺絲 110009		1.5×7.8 Shaft ×2 插銷 110059		Damper cylinder ×4 避震筒身 210071		Piston rod ×4 避震軸心 310008
	M2.5×5 Screw ×1 圓頭螺絲 110102		5×7×0.3 Spacer ×2 墊片 820020		4.8 Ball connector ×7 外六角球頭 210161		2×9.8 Shaft ×7 插銷 110017				Piston ×4 避震活塞 210082
	M3×6 Screw ×4 圓頭螺絲 110001		3×6×2.5 Bearing ×4 軸承 120024		4.8 Ball connector L ×2 外六角球頭(長) 210344		2×22 Shaft ×2 插銷 310047		Damper adjuster ×4 避震器拉桿 820079		Damper adjuster ×4 避震器拉桿 820079
	M3×8 Screw ×26 圓頭螺絲 110002		5×7×0.3 Spacer ×2 墊片 820020		4.8 Ball connector L ×2 外六角球頭(長) 210344		2×28 Shaft ×2 插銷 310103		Cylinder cap ×4 避震器上蓋 210057		10.8×0.9 O-ring ×4 O環 130032
	M3×10 Screw ×10 圓頭螺絲 110026		5×8 Bearing ×4 軸承 120017		4.8×4.5 Ball connector ×9 球頭螺絲 310001		2.5×46 Arm shaft ×4 擺臂插銷 310048				Rod guide cap ×4 避震器下蓋 210057
	M3×14 Screw ×6 圓頭螺絲 110061		4×10 Ball bearing ×1 培林 120018		5.8×4 Ball connector (L) ×4 球頭螺絲(長) 210491		Bevel gear shaft ×1 傘齒軸 310102		Damper retainer ×4 避震器彈簧座 820079		12×1 O-ring ×4 O環 130049
	M3×16 Screw ×1 圓頭螺絲 110086		5×8 Ball bearing ×4 培林 120003		M3×6 Screw ×2 有頭螺絲(半牙) 110011		R-clip 5.0 ×4 R銷 5.0 820075				Spring retainer (red) ×4 避震器調整環(紅) 310106R
	M3×4 screw ×4 沉頭螺絲 110099		5×10 Ball bearing ×1 培林 120002		M3×30 Screw ×1 有頭螺絲(半牙) 110100		Suspension mount spacer 0.5mm ×3 擺臂座墊片 0.5mm 820063		Oil seal ×4 避震器氣室 130004		Damper O-ring P3 ×4 避震器O環 130028
	M3×8 Screw ×25 沉頭螺絲 110005		5×11 Ball bearing ×2 培林 120011		M3×40 Screw ×5 有頭螺絲(半牙) 110091		Main shaft ×1 主齒軸 310105		Rod guide ×4 避震器下蓋墊片 210082		
	M3×10 Screw ×10 沉頭螺絲 110052		8×12 Ball bearing ×2 培林 120019		2WD Axle ×2 二驅輪軸 820095		Steel CVD universal shaft 48 ×2 鋼製CVD傳動軸 48 820007				
	M3×12 Screw ×2 沉頭螺絲 110043		10×15 Ball bearing ×4 培林 120001		Wheel axle ×2 萬向接杯 310006						
	M3×18 Screw ×2 沉頭螺絲 110078										
	M3×20 Screw ×2 沉頭螺絲 110101										

PARTS

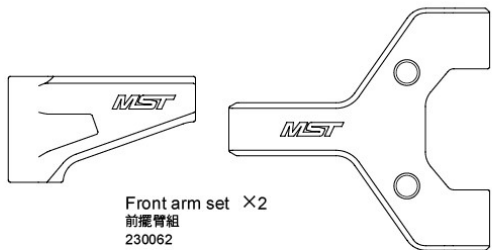

Front arm set ×2
前擺臂組
230062



×1 ×1 ×2

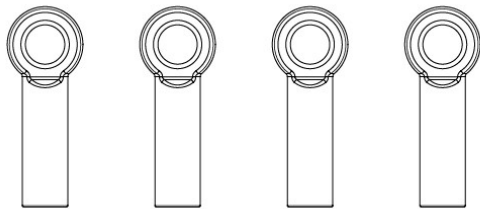

5.8×26 Reinforced adjuster set
強化拉桿頭組
210031

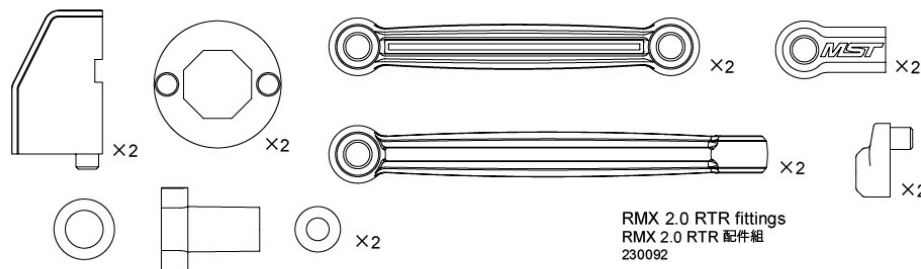

RMX 2.0 RTR fittings
RMX 2.0 RTR 配件組
230092

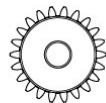

Pinion gear 48P-22T ×1
馬達齒
148022

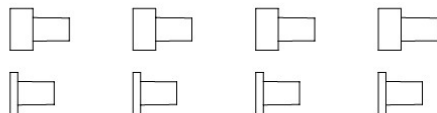

Shaft bush & spacer set (white)
襯套墊片組 (白)
210063(W)

Alum. motor mount (red)
鋁合金馬達座 (紅)
310101R

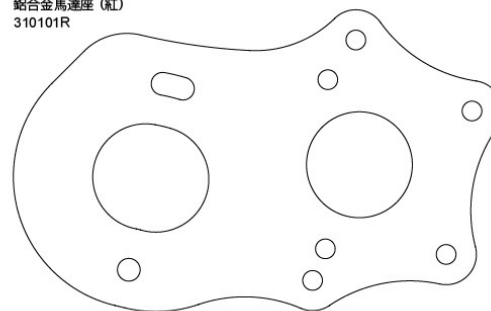

Enlarged brake calipers (red)
加大剎車卡鉗 (紅)
210510CR



ATK Front wheel hubs
前輪座組
230066



Bevel gear 16T ×2
傘齒 16T
310064

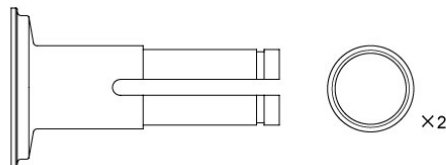
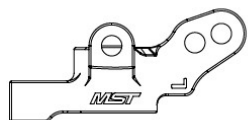

Ball diff. joint
滾差接杯組
230059

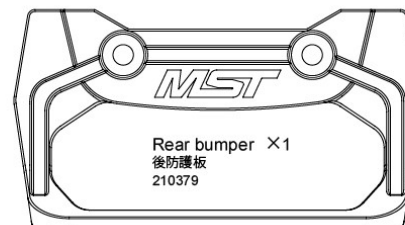
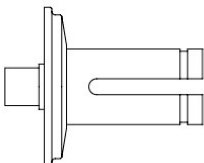

Rear bumper ×1
後防護板
210379

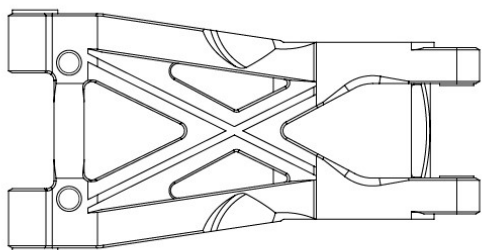

HT Rear lower arm (4hole) & wheel hub ×2
HT 後下擺臂 (4孔) & 輪座
210070-1

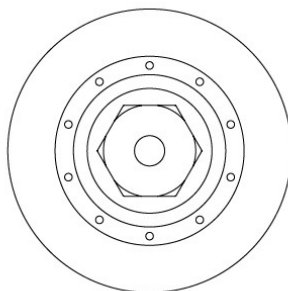
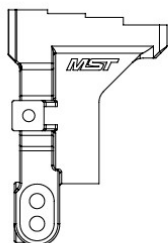

Wheel hubs w/disc shape (large) with sticker
碟型六角輪座組 (加大型) 附貼紙
230041

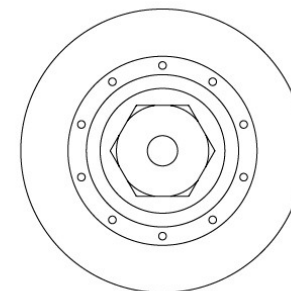
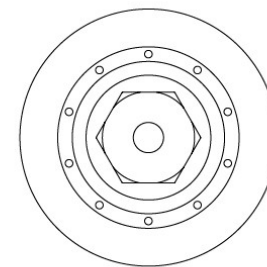
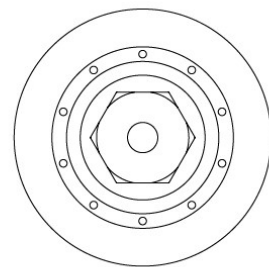

PARTS

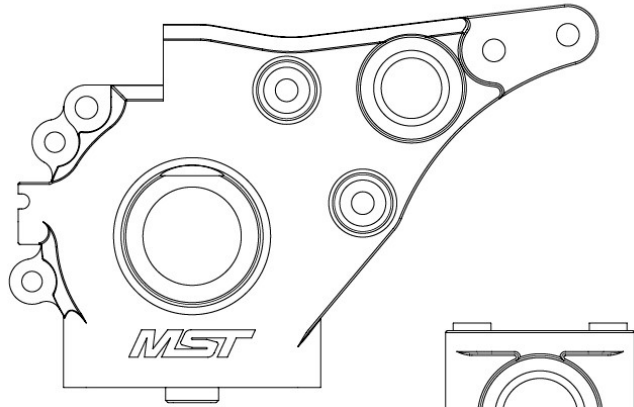

Rear gear box set
後齒箱組
230061-1

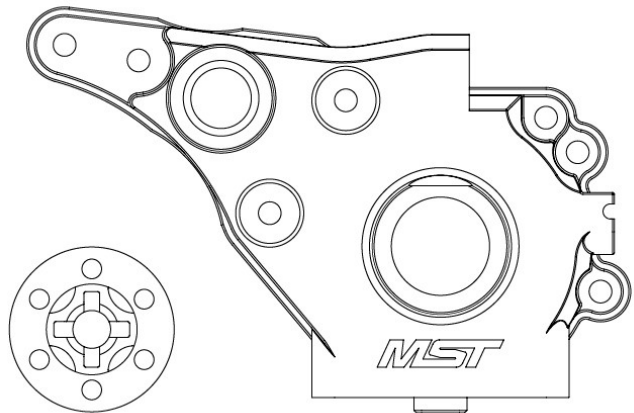

Front dmaper stay
前避震架
230063

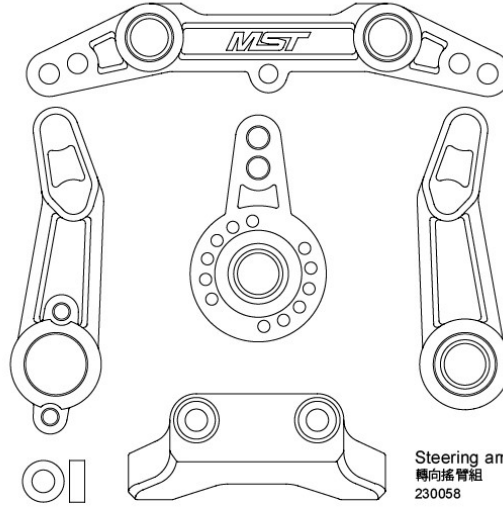

Steering arm set
轉向搖臂組
230058

Spur gear 48P 80T
大直齒
230068

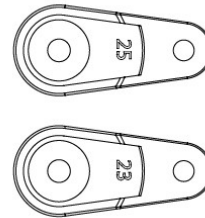
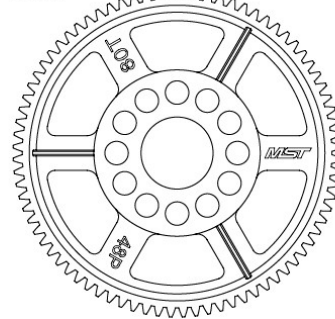

Servo horn set (23T/25T)
伺服機舵片組 (23T/25T)
210032

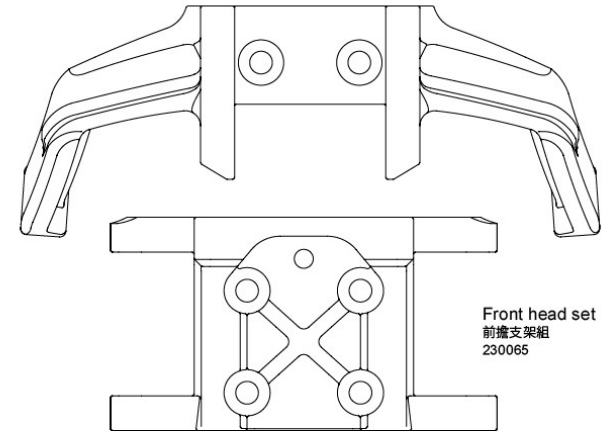

Front head set
前搖支架組
230065

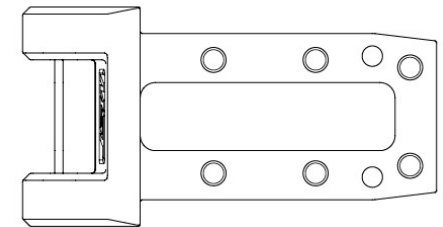

Rear dmaper stay
後避震架
230064

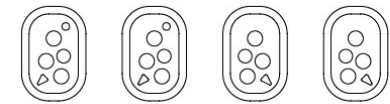

Shaft bush & spacer set
襯套墊片組
230070

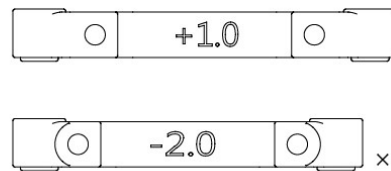
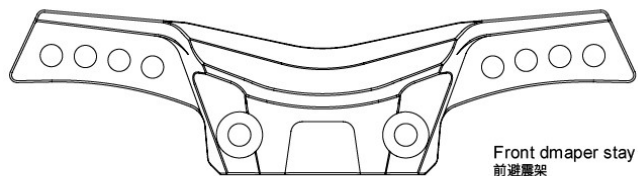

Suspension mount set (+1.0 / -2.0)
下擺臂座組 (+1.0 / -2.0)
230069

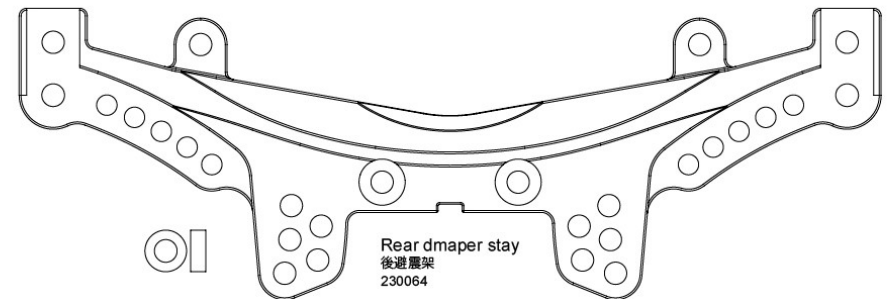

PARTS

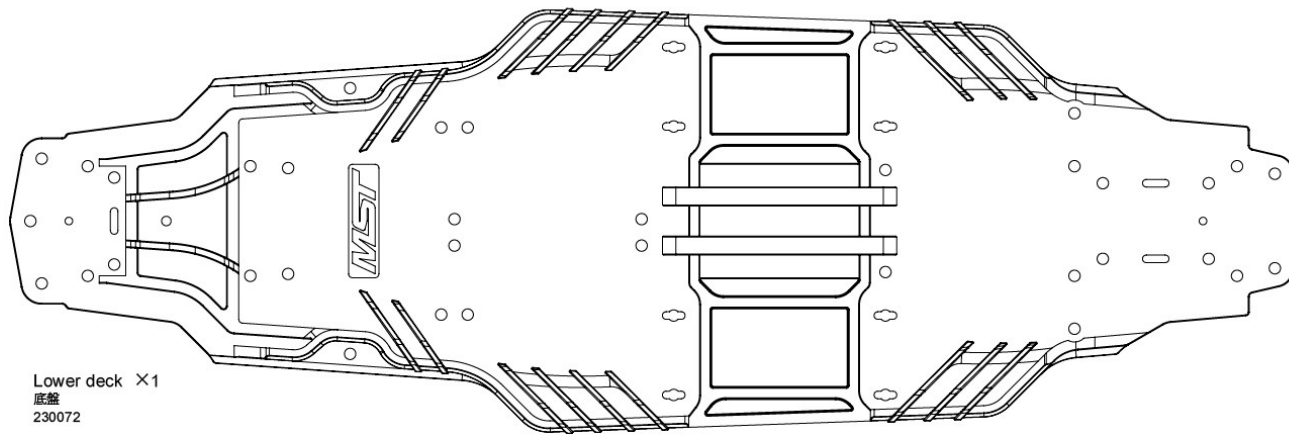

Lower deck ×1
底座
230072

C PARTS-bumper set ×1
防撞板組
210002

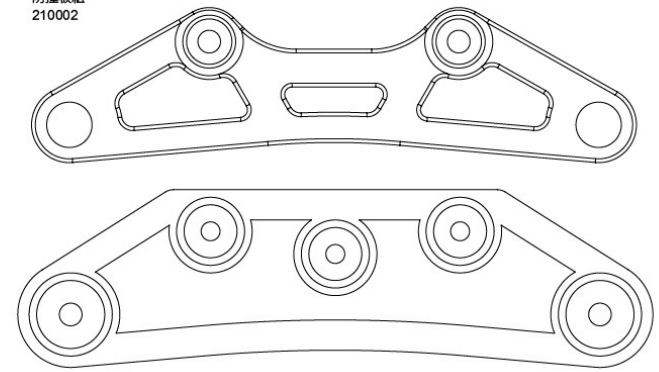

Bevel gear set 36-17
傘齒組 36-17
210034

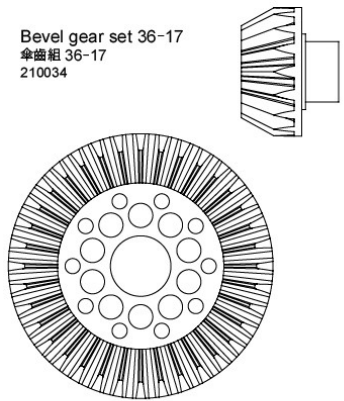

Upper deck connector
二樓板後連結座組
230071

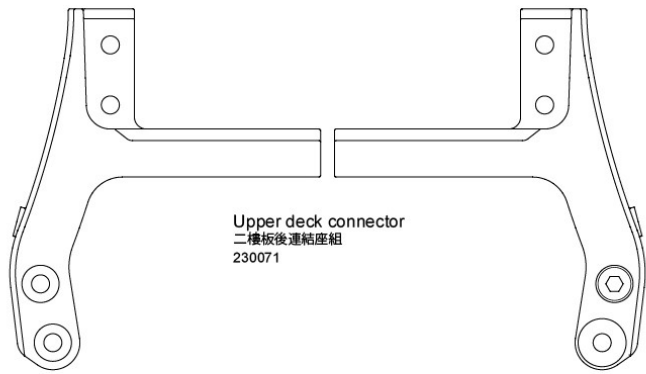

Bumper (A)
防撞泡棉 (A)
130005

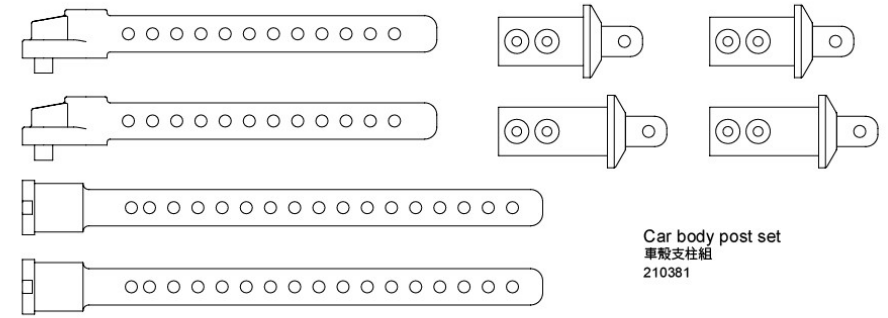
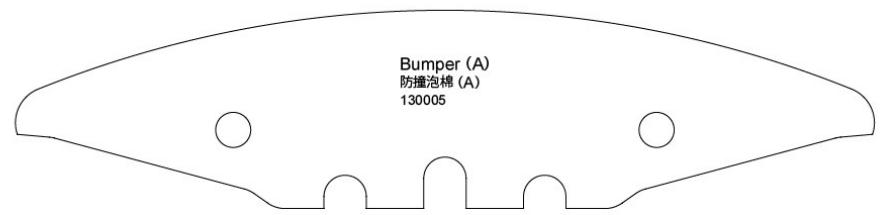

Car body post set
車殼支柱組
210381

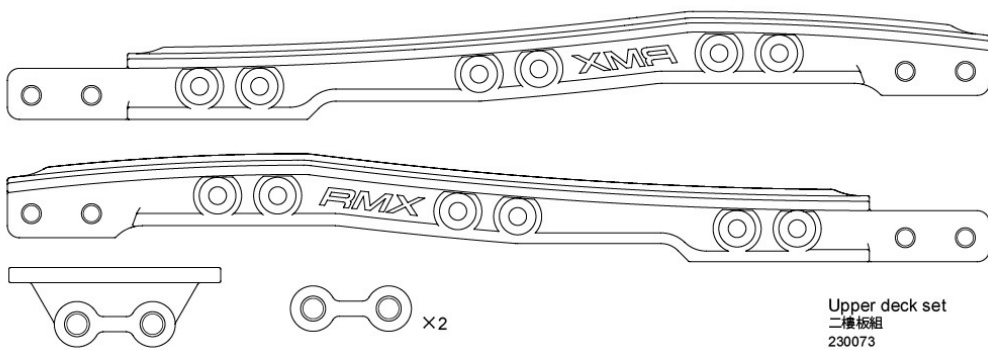

Upper deck set
二樓板組
230073

Battery holder set
電池座組
230060

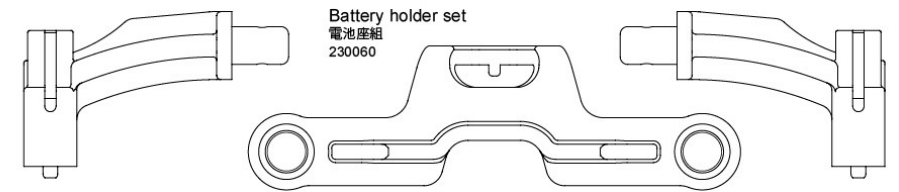

Caster

6°
 8°
 10°
 12°

Front wheel hubs

0/1 mm

Centered

Centered low gravity

Centered upper motor

Rear wheel hubs

0 mm

FRONT **REAR**

Tire: _____

Wheel: _____

Offset: **+3/+5**

Front damper stay

4 3 2 1

Camber: 6°
Toe-in: -8°

Ride height: 6 mm

Front upright

0 mm

Rear upright

Rear damper stay

5 4 3 2 1

Camber: 5°
Toe-in: -3°

Ride height: 6 mm

Rear diff

Spool
 Ball diff.

Alum spool
 Alum ball diff.

Front Suspension mount

Rollcenter -2.0

0.5 mm

Steering

Rear Suspension mount

Rollcenter +1.0

0 mm

Front lower arm

3 2 1

Rear lower arm

4 3 2 1

Front damper

Shock oil: #10 Spring color: Red
 Spring: 31 mm Ø11 Piston: Ø12 mm Piston hole: 3

Spur Gear ÷ Pinion Gear × Reduction Gear = Gear ratio

80 T ÷ 22 T × 2/2 = 7.71

Motor & ESC: _____ **Battery:** _____
Transceiver: _____ **Gyro:** _____ **Sensitivity:** _____

Rear damper

Shock oil: #10 Spring color: Purple-yellow
 Spring: 31 mm Ø11 Piston: Ø12 mm Piston hole: 3

2nd Reduction Gear

32T / 18T - 1.78
 34T / 18T - 1.89
 36T / 17T - 2.12
 40T / 16T - 2.50
 40T / 13T - 3.08
 42T / 11T - 3.82

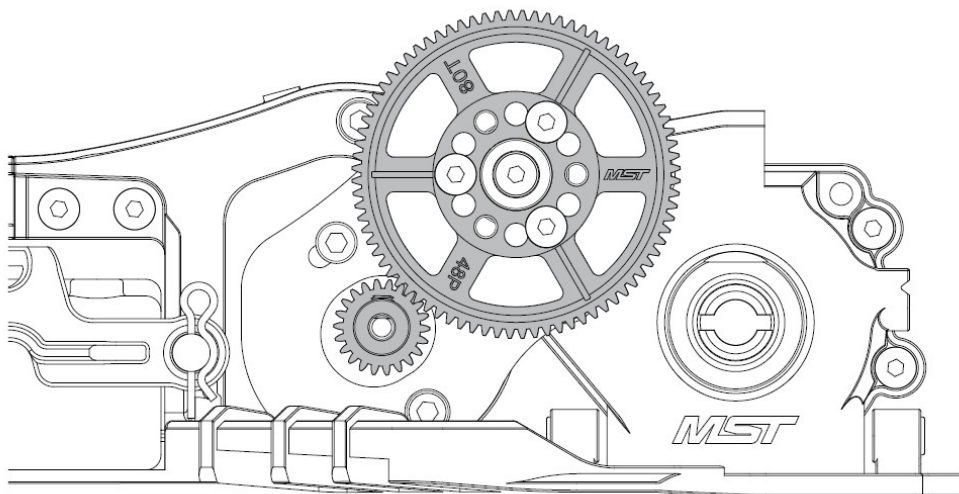

*** FORMULA**

計算公式

$$\left(\frac{\text{Spur gear teeth (大直齒)}}{\text{Pinion gear teeth (馬達齒)}} \times \frac{\text{Diff. ring gear (大傘齒)}}{\text{Diff. pinion gear (小傘齒)}} \right) = \text{Gear ratio (終傳比)}$$

GEAR RATIO (For 80T Spur Gear)

	34T/18T <1.89> 210069	36T/17T <2.12> 210034	40T/16T <2.5> 210025	40T/13T <3.08> 210035	42T/11T <3.82> 210036
22T	6.87	7.7 Original setting	9.09	11.19	13.88
23T	6.57	7.37	8.7	10.70	13.28
24T	6.3	7.06	8.33	10.26	12.73
25T	6.04	6.78	8	9.85	12.22
26T	5.81	6.52	7.69	9.47	11.75
27T	5.6	6.27	7.41	9.12	11.31
	Apply to 310102 bevel gear shaft. 需配合310102傘齒輪使用			Apply to 310104 bevel gear shaft. 需配合310104傘齒輪使用	

CS-R

TIRE COMPOUND CHART

YELLOW	830001	SOFT
RED	101024/ 830002	
GREEN	830003	
GOLD	101025/ 830009	HARD
SILVER	101026	
PURPLE	101029	HP
BLUE	101028	for asphalt
ORANGE	101030	for carpet
PC	101027	

PARTS CODE

101025	CS-R tire (medium) (4)	110100	Cap screw M3×30 (6)	210063W	Shaft bush & spacer set (white)	310006	Wheel axle (2)
110001	Round head screw M3×6 (10)	110101	Countersunk screw M3×20 (6)	210070-1	HT Rear lower arm (4 holes) & wheel hub	310008	Piston rod (4)
110002	Round head screw M3×8 (10)	110102	Round head screw M2.5×5 (6)	210071	Damper cylinder (2)	310047	Arm shaft 2.0×22 (2)
110004	Round head screw M2×4 (6)	110107	Round head screw M2.5×18 (6)	210082	Piston spacer set	310048	Arm shaft 2.5×46 (4)
110005	Countersunk screw M3×8 (10)	110120	Round head screw w/washer M3×8 (6)	210161	Ball connector nut 4.8 (4)	310064	Bevel gear 16T (2)
110009	Set screw M3×20 (6)	120001	Ball bearing 10×15 (4)	210344	Ball connector nut L 4.8 (4)	310101R	RMX Alum. motor mount (red)
110011	Cap screw M3×6 (6)	120002	Ball bearing 5×10 (4)	210379	Rear bumper	310102	RMX bevel gear shaft
110013	E-clip 2.0 (10)	120003	Ball bearing 5×8 (4)	210381	Car body post set	310103	Arm shaft 2×28 (2)
110015	Flange nut M4 (4)	120011	Ball bearing 5×11 (4)	210491	Ball connector L 5.8X4 (4)	310105	RMX Main shaft
110017	Shaft 2×9.8 (10)	120017	Bearing 5×8 (4)	210510CR	Enlarged brake calipers (red) (4)	310106R	Spring retainer (red) (2)
110032	Set screw M3×10 (6)	120018	Ball bearing 4×10×4 (2)	230041	Wheel hubs w/disc shape (large)	600002	XTR-02 2.4G Transceiver set
110035	Set screw M3×3 (6)	120019	Ball bearing 8×12 (2)	230058	Steering arm set	601021	MST SC-0352 Servo
110043	Countersunk screw M3×12 (10)	120024	Bearing 3×6×2.5 (4)	230059	Ball diff. joint	601025	XBL Brushless ESC 50A
110044	Round head screw M2×6 (6)	130004	Oil seal (4)	230060	Battery mount	601026	XBL Brushless motor 2500KV
110045	Round head screw M2×8 (partial thread) (6)	130005	Bumper (A)	230061-1	Rear gear box set	820007	Steel CVD great angle universal shaft 48 (2)
110047	Spacer 3×6×0.5 (8)	130006	Double sided tape(5)	230062	Front arm set	820018	Spacer 5×7×0.1 (8)
110048	Spacer 3×8×0.5 (8)	130017	Inner sponge (8)	230063	Front damper stay	820020	Spacer 5×7×0.3 (8)
110052	Countersunk screw M3×10 (10)	130028	Damper O-ring P3 (blue) (10)	230064	Rear damper stay	820030	Cross joint (2)
110059	Shaft 1.5×7.8 (8)	130032	Damper cap O-ring (10)	230065	Front head set	820075BK	R-clip 5.0 (black) (10)
110061	Round head screw M3×14 (6)	130034	Sponge 20×80×1 (4)	230066	ATK Front wheel hubs	820079	Damper plastic maintenance set (2)
110063	Round head screw M2×8 (6)	130035	L Wrench set (1.5 & 2.0 & 2.5)	230068	Spur gear 48P-80T	820095	AKM 2WD axle (2)
110070	E-clip 3.0 (10)	130049	O-ring 12×1 (4)	230069	Suspension mount set (+1.0/-2.0)	820103-4	31mm Hard coil spring (super-soft) (2)
110078	Countersunk screw M3×18 (6)	148022	MST 48P Pinion gear 22T	230070	Shaft bush & spacer set	820104-4	31mm Soft coil spring (super-soft) (2)
110079	E-clip 2.5 (10)	210002	C PARTS-bumper set	230071	Upper deck connector	841013	LSD X Gyro
110080	Spacer 2.6×5.8×0.6 (8)	210031	Reinforced adjuster set 5.8×26	230072	RMX Lower deck		
110086	Round head screw M3×16 (6)	210032	Servo horn set (23T/25T)	230073	RMX Upper deck set		
110091	Cap screw M3×40 (6)	210034	Bevel gear set 36-17	230092	RMX 2.0 RTR fittings		
110099	Countersunk screw M3×4 (10)	210057	Damper cap set	310001	Ball connector 4.8×4.5 (5)		

部品編號

101025	CS-R尾尾胎 (中) (4)	110100	六角有頭螺絲 M3×30 (半牙) (6)	210063W	襯套墊片組 (白)	310006	萬向接杯 (2)
110001	六角半圓頭螺絲 M3×6 (10)	110101	六角沉頭螺絲 M3×20 (6)	210070-1	HT 後下擺臂 (4孔) & 輪座	310008	避震軸心 (4)
110002	六角半圓頭螺絲 M3×8 (10)	110102	六角半圓頭螺絲 M2.5×5 (6)	210071	避震器筒身 (2)	310047	擺臂插銷 2.0×22 (2)
110004	六角半圓頭螺絲 M2×4 (6)	110107	六角半圓頭螺絲 M2.5×18 (6)	210082	避震器活塞墊片組	310048	擺臂插銷 2.5×46 (4)
110005	六角沉頭螺絲 M3×8 (10)	110120	六角半圓頭帶墊片螺絲 M3×8 (6)	210161	球頭螺帽 4.8 (4)	310064	傘齒16T (2)
110009	六角止付螺絲 M3×20 (6)	120001	培林 10×15 (4)	210344	球頭螺帽L 4.8 (4)	310101R	RMX 鋁合金馬達座 (紅)
110011	六角有頭螺絲 M3×6 (半牙) (6)	120002	培林 5×10 (4)	210379	後防撞板	310102	RMX 傘齒軸
110013	E扣 2.0 (10)	120003	培林 5×8 (4)	210381	車殼支柱組	310103	擺臂插銷 2×28 (2)
110015	凸緣螺帽 M4 (4)	120011	培林 5×11 (4)	210491	球頭螺絲 L 5.8×4 (4)	310105	RMX 主齒軸
110017	插銷 2×9.8 (10)	120017	軸承 5×8 (4)	210510CR	加大煞車卡鉗 (紅) (4)	310106R	避震調整環 (紅) (2)
110032	六角止付螺絲 M3×10 (6)	120018	培林 4×10×4 (2)	230041	碟型六角輪座組 (加大型)	600002	XTR-02 2.4G 遙控器組
110035	六角止付螺絲 M3×3 (6)	120019	培林 8×12 (2)	230058	轉向搖臂組	601021	MST SC-0352 伺服機
110043	六角沉頭螺絲 M3×12 (10)	120024	軸承 3×6×2.5 (4)	230059	滾差接杯組	601025	XBL 無刷電變 50A
110044	六角半圓頭螺絲 M2×6 (6)	130004	避震氣室 (4)	230060	電池座組	601026	XBL 無刷馬達 2500KV
110045	六角半圓頭螺絲 M2×8 (半牙) (6)	130005	防撞泡棉 (A)	230061-1	後齒箱組	820007	鋼製大角度CVD傳動軸 48 (2)
110047	墊片 3×6×0.5 (8)	130006	泡棉雙面膠 (5)	230062	前擺臂組	820018	墊片 5×7×0.1 (8)
110048	墊片 3×8×0.5 (8)	130017	吸塵泡棉 (8)	230063	前避震架	820020	墊片 5×7×0.3 (8)
110052	六角沉頭螺絲 M3×10 (10)	130028	阻尼器O環 P3 (藍) (10)	230064	後避震架	820030	連接軸 (2)
110059	插銷 1.5×7.8 (8)	130032	避震上蓋O環 (10)	230065	前擔支架組	820075BK	R銷 5.0 (黑) (10)
110061	六角半圓頭螺絲 M3×14 (6)	130034	吸塵泡棉 20×80×1 (4)	230066	ATK前輪座組	820079	避震膠件包 (2)
110063	六角半圓頭螺絲 M2×8 (6)	130035	L 板手組 (1.5 & 2.0 & 2.5)	230068	大齒盤 48P-80T	820095	AKM 二驅輪軸 (2)
110070	E扣 3.0 (10)	130049	O環 12×1 (4)	230069	下擺臂座組 (+1.0/-2.0)	820103-4	31mm 硬避震彈簧 (超軟) (2)
110078	六角沉頭螺絲 M3×18 (6)	148022	MST 48P 馬達齒 22T	230070	襯套墊片組	820104-4	31mm 軟避震彈簧 (超軟) (2)
110079	E扣 2.5 (10)	210002	C PARTS-防撞板組	230071	二樓板後連結座組	841013	LSD X 陀螺儀
110080	墊片 2.6×5.8×0.6 (8)	210031	強化拉桿頭組 5.8×26	230072	RMX 底盤		
110086	六角半圓頭螺絲 M3×16 (6)	210032	伺服機舵片組 (23T/25T)	230073	RMX 二樓板組		
110091	六角有頭螺絲 M3×40 (半牙) (6)	210034	傘齒組 36-17	230092	RMX 2.0 RTR 配件組		
110099	六角沉頭螺絲 M3×4 (10)	210057	避震器上下蓋組	310001	內六角球頭 4.8×4.5 (5)		

026164-3