

Name: _____ Date: _____ Event: _____ Ambient Temp: _____

Track: INDOOR OUTDOOR Size: SMALL MEDIUM LARGE Traction: LOW MEDIUM HIGH

Surface: SMOOTH BUMPY RUTTED Type: LOOSE / LOAMY HARD PACKED BLUE GROOVE CLAY ASTRO

Ackerman/Bumpsteer/Servo Saver

Condition: DUSTY DRY WET MUDDY



WASHERS:



FULL TURNS FROM FULLY TIGHT

Front End:

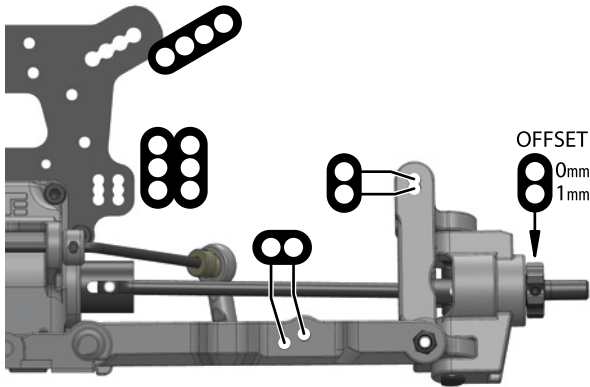

Suspension:

RIDE HEIGHT: _____ CAMBER: _____

CASTER BLOCK: _____ SWEEP: _____

KICK UP: _____ TOE: _____

SWAY BAR: _____ DROOP: _____

Shocks:

OIL: _____ BRAND: _____

PISTON: _____ SPRING: _____

REBOUND: _____ BUILD: _____

Differentials:

OPTION	FRONT	CENTER	REAR
Diff Oil			
(TKR5145B)	<input type="radio"/>	<input type="radio"/>	<input type="radio"/>
(TKR5145C)	<input type="radio"/>	<input type="radio"/>	<input type="radio"/>
(TKR9114)	<input type="radio"/>	<input type="radio"/>	<input type="radio"/>
(TKR9114HD)	<input type="radio"/>	<input type="radio"/>	<input type="radio"/>
(TKR51114XB)	<input type="radio"/>	<input type="radio"/>	<input type="radio"/>
(TKR5150)	<input type="radio"/>	<input type="radio"/>	<input type="radio"/>
(TKR5150B)	<input type="radio"/>	<input type="radio"/>	<input type="radio"/>
(TKR5113B)	<input type="radio"/>	<input type="radio"/>	<input type="radio"/>
(TKR5113S)	<input type="radio"/>	<input type="radio"/>	<input type="radio"/>
(TKR5113)	<input type="radio"/>	<input type="radio"/>	<input type="radio"/>
(TKR5149X)	<input type="radio"/>	<input type="radio"/>	<input type="radio"/>
(TKR5149A)	<input type="radio"/>	<input type="radio"/>	<input type="radio"/>
(TKR5149)	<input type="radio"/>	<input type="radio"/>	<input type="radio"/>

Rear End:

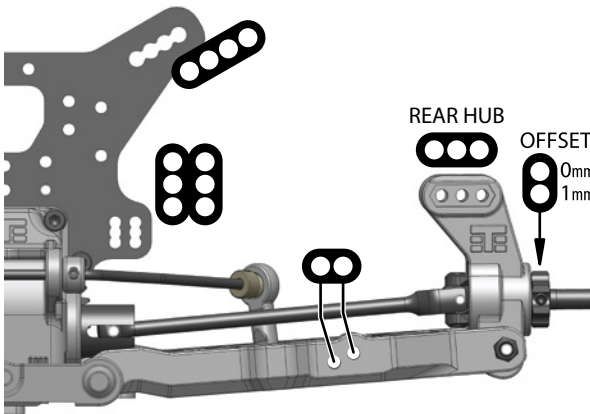

Suspension:

RIDE HEIGHT: _____ CAMBER: _____

ANTI-SQUAT: _____ TOE: _____

SWAY BAR: _____ DROOP: _____

Shocks:

OIL: _____ BRAND: _____

PISTON: _____ SPRING: _____

REBOUND: _____ BUILD: _____

Drivetrain:

PINION/SPUR: _____ / _____

Equipment:

ESC: _____

BATTERY: _____

MOTOR: _____

SERVO: _____

Wheelbase:

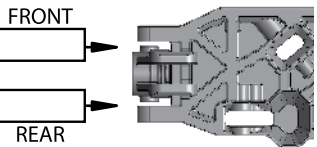

(Shims)
 (Thick - 2mm)
 (Thin - 1mm)

Chassis Braces:

TURNBUCKLE BRACE: CENTER BRACE:

REAR BRACE:

Tires / Wheels:

BRAND / TREAD: _____

COMPOUND: _____

INSERT: _____

WHEEL: _____

NOTES: _____

Body/Body Mounts:

BODY MAKE: _____

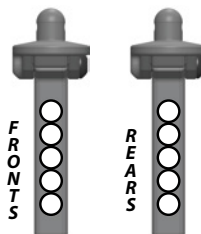

Optional Hinge Pin Braces:

"A" Block:

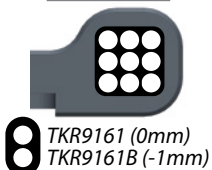

"B" Block:

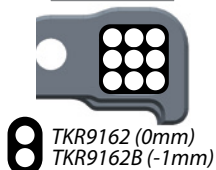

"C" Block:

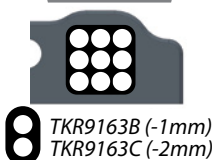

"D" Block:

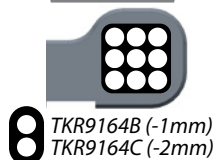

Notes: