

Name: _____
 Date: _____
 Track: _____

Track conditions
 Size: Open Med. Tight
 Traction: High Med. Low
 Surface: Smooth Med. Bumpy

Result
 Race time / Lap: _____
 Best lap (1Lap): _____

Front suspension

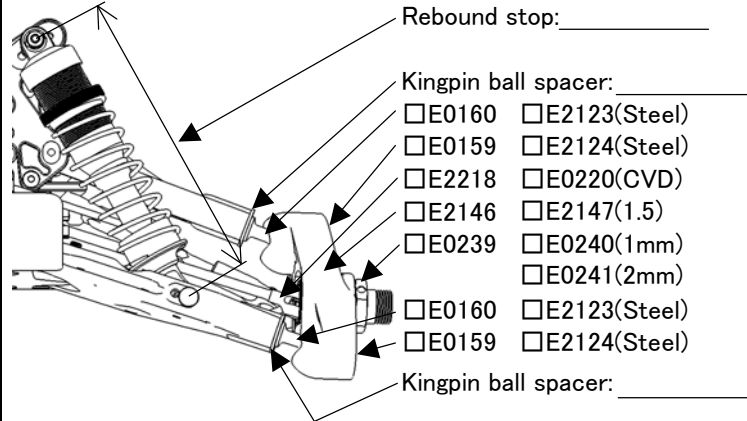

Ride height: _____
 Toe angle: _____
 Lower arm plate:
E2144A,B
E2154(CFRP 1mm)
E2155(CFRP 1.2mm)
 Anti roll bar: _____
 Upper arm spacer:

 Lower arm spacer:

Front shocks

Piston: _____ Oil: _____
 Spring: _____
 Shock position:

 Pivot ball position: Front Rear
 Damper stay: E2562(Aluminum)
E2565(CFRP)

Upper arm position:

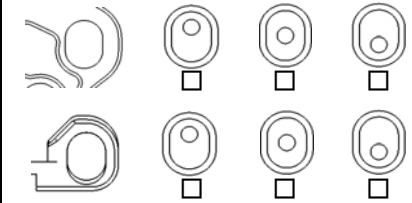

Lower arm position (Kick up):

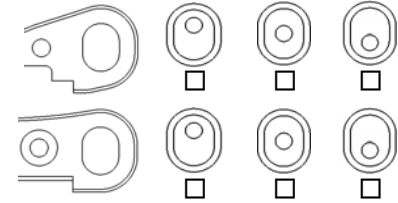

Steering ackerman

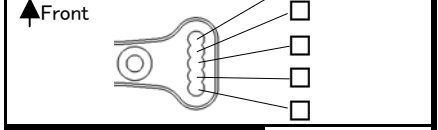

Front upper plate

E2148D E2158(CFRP)

Servo saver arm

E2301A E2310(Aluminum)

Rear suspension

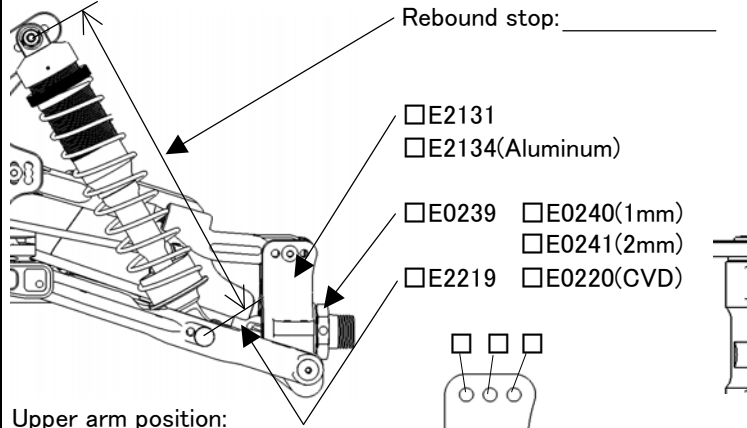

Ride height: _____
 Camber angle: _____
 Lower arm plate:
E2145A,B
E2156(CFRP 1mm)
E2157(CFRP 1.2mm)
 Anti roll bar: _____
 Lower arm spacer:

 Upright spacer:

Rear shocks

Piston: _____ Oil: _____
 Spring: _____
 Shock position:

 Pivot ball position: Front Rear
 Damper stay: E2563(Aluminum)
E2566(CFRP)

Upper arm position:

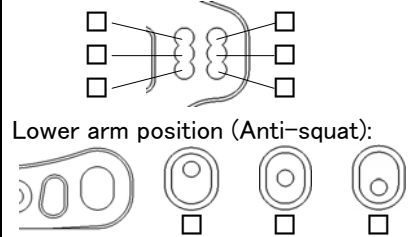

Lower arm position (Toe angle):

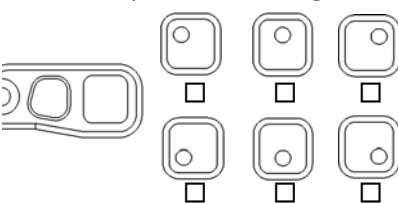

Center shaft

E0223,E0259 E2228,E2229

Tension rod

Front: E2107A(Long) E2107B(Short)
 Rear: E2148C E0803(Rubber)

Weight



Engine

Type: _____ Plug: _____ Reducer: _____
 Muffler: _____ Fuel: _____ Gasket: _____
 Engine mount: E0701(Standard) Other _____

Diff. Gear

Oil _____
 Front: 44/13T 42/12T
 Rear: 44/13T 42/12T
 Center: 44T 46T
47T 48T

Tires

	Front	Rear
Type:	_____	_____
Compound:	_____	_____
Inserts:	_____	_____
Wheel:	_____	_____

Clutch

3P 4P
 Clutch bell: 13T 14T
 Clutch shoes C0754 E0704 E0710 E2706
 Clutch spring 0.8 0.9 0.95 1.0 1.05 1.1

Body/Wing

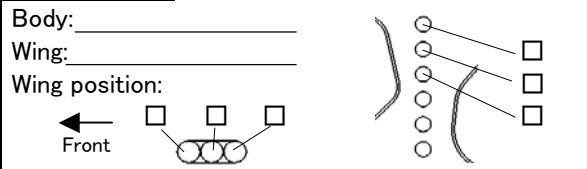

Comments

.....

