

XRAY GTXE



INSTRUCTION MANUAL

GTXE '23

BEFORE YOU START

This is a high-competition, high-quality RC car intended for persons aged 16 years and older with previous experience building and operating RC model racing cars. This is not a toy; it is a precision racing model. This model racing car is not intended for use by beginners, inexperienced customers, or by children without direct supervision of a responsible, knowledgeable adult. If you do not fulfill these requirements, please return the kit in unused and unassembled form back to the shop where you have purchased it.

Before building and operating your XRAY, **YOU MUST** read through all of the operating instructions and instruction manual and fully understand them to get the maximum enjoyment and prevent unnecessary damage.

CUSTOMER SUPPORT

We have made every effort to make these instructions as easy to understand as possible. However, if you have any difficulties, problems, or questions, please do not hesitate to contact the XRAY support team at info@teamxray.com. Also, please visit our Web site at www.teamxray.com to find the latest updates, set-up information, option parts, and many other goodies. We pride ourselves on taking excellent care of our customers.

You can join thousands of XRAY fans and enthusiasts in our online community at: www.teamxray.com

Read carefully and fully understand the instructions before beginning assembly.

Make sure you review this entire manual, download and use set-up book from the web, and examine all details carefully. If for some reason you decide this is not what you wanted or expected, **do not continue any further**. Your hobby dealer can not accept your kit for return or exchange after it has been partially or fully assembled.

Contents of the box may differ from pictures. In line with our policy of continuous product development, the exact specifications of the kit may vary without prior notice.

XRAY Europe

K Vystavisku 6992
91101 Trenčín
Slovakia, EUROPE
Phone: 421-32-7401100
Fax: 421-32-7401109
E-mail: info@teamxray.com

XRAY USA

RC America, 2030 Century Center Blvd #15
Irving, TX 75062
USA
Phone: (214) 744-2400
Fax: (214) 744-2401
E-mail: xray@rcamerica.com

FAILURE TO FOLLOW THESE INSTRUCTIONS WILL BE CONSIDERED AS ABUSE AND/OR NEGLECT.

SAFETY PRECAUTIONS

Contains:

LEAD (CAS 7439-92-1) ANTIMONY (CAS 7440-36-0)

WARNING: This product contains a chemical known to the state of California to cause cancer and birth defects or other reproductive harm.

CAUTION: CANCER HAZARD

Contains lead, a listed carcinogen. Lead is harmful if ingested. Wash thoroughly after using. DO NOT use product while eating, drinking or using tobacco products. May cause chronic effects to gastrointestinal tract, CNS, kidneys, and blood. MAY CAUSE BIRTH DEFECTS.

When building, using and/or operating this model always wear protective glasses and gloves.

Take appropriate safety precautions prior to operating this model. You are responsible for this model's assembly and safe operation! Please read the instruction manual before building and operating this model and follow all safety precautions. Always keep the instruction manual at hand for quick

reference, even after completing the assembly. Use only genuine and original authentic XRAY parts for maximum performance. Using any third party parts on this model will void guaranty immediately.

Improper operation may cause personal and/or property damage. XRAY and its distributors have no control over damage resulting from shipping, improper construction, or improper usage. XRAY assumes and accepts no responsibility for personal and/or property damages resulting from the use of improper building materials, equipment and operations. By purchasing any item produced by XRAY, the buyer expressly warrants that he/she is in compliance with all applicable federal, state and local laws and regulation regarding the purchase, ownership and use of the item. The buyer expressly agrees to indemnify and hold harmless XRAY for all claims resulting directly or indirectly from the purchase, ownership or use of the product. By the act of assembling or operating this product, the user accepts all resulting liability. If the buyer is not prepared to accept this liability, then he/she should return this kit in new, unassembled, and unused condition to the place of purchase.



IMPORTANT NOTES - GENERAL

- This product is not suitable for children under 16 years of age without the direct supervision of a responsible and knowledgeable adult.
- Carefully read all manufacturers warnings and cautions for any parts used in the construction and use of your model.
- Assemble this kit only in places away from the reach of very small children.
- First-time builders and users should seek advice from people who have building experience in order to assemble the model correctly and to allow the model to reach its performance potential.
- Exercise care when using tools and sharp instruments.
- Take care when building, as some parts may have sharp edges.
- Keep small parts out of reach of small children. Children must not be allowed to put any parts in their mouth, or pull vinyl bag over their head.
- Read and follow instructions supplied with paints and/or cement, if used (not included in kit).
- Immediately after using your model, do NOT touch equipment on the model such as the motor and speed controller, because they generate high temperatures. You may seriously burn yourself seriously touching them.
- Follow the operating instructions for the radio equipment at all times.
- Do not put fingers or any objects inside rotating and moving parts, as this may cause damage or serious injury as your finger, hair, clothes, etc. may get caught.
- Be sure that your operating frequency is clear before turning on or running your model, and never share the same frequency with somebody else at the same time. Ensure that others are aware of the operating frequency you are using and when you are using it.
- Use a transmitter designed for ground use with RC cars. Make sure that no one else is using the same frequency as yours in your operating area. Using the same frequency at the same time, whether it is driving, flying or sailing, can cause loss of control of the RC model, resulting in a serious accident.
- Always turn on your transmitter before you turn on the receiver in the car. Always turn off the receiver before turning your transmitter off.
- Keep the wheels of the model off the ground when checking the operation of the radio equipment.
- Disconnect the battery pack before storing your model.
- When learning to operate your model, go to an area that has no obstacles that can damage your model if your model suffers a collision.
- Remove any sand, mud, dirt, grass or water before putting your model away.
- If the model behaves strangely, immediately stop the model, check and clear the problem.
- To prevent any serious personal injury and/or damage to property, be responsible when operating all remote controlled models.
- The model car is not intended for use on public places and roads or areas where its operation can conflict with or disrupt pedestrian or vehicular traffic.
- Because the model car is controlled by radio, it is subject to radio interference from many sources that are beyond your control. Since radio interference can cause momentary loss of control, always allow a safety margin in all directions around the model in order to prevent collisions.
- Do not use your model:
 - Near real cars, animals, or people that are unaware that an RC car is being driven.
 - In places where children and people gather
 - In residential districts and parks
 - In limited indoor spaces
 - In wet conditions
 - In the street
 - In areas where loud noises can disturb others, such as hospitals and residential areas.
 - At night or anytime your line of sight to the model may be obstructed or impaired in any way.

To prevent any serious personal injury and/or damage to property, please be responsible when operating all remote controlled models.

IMPORTANT NOTES - ELECTRICAL

- Insulate any exposed electrical wiring (using heat shrink tubing or electrical tape) to prevent dangerous short circuits. Take maximum care in wiring, connecting and insulating cables. Make sure cables are always connected securely. Check connectors for if they become loose. And if so, reconnect them securely. Never use RC models with damaged wires. A damaged wire is extremely dangerous, and can cause short-circuits resulting in fire. Please have wires repaired at your local hobby shop.
- Low battery power will result in loss of control. Loss of control can occur due to a weak battery in either the transmitter or the receiver. Weak running battery may also result in an out of control car if your car's receiver power is supplied by the running battery. Stop operation immediately if the car starts to slow down.
- When not using RC model, always disconnect and remove battery.
- Do not disassemble battery or cut battery cables. If the running battery short-circuits, approximately 300W of electricity can be discharged, leading to fire or burns. Never disassemble battery or cut battery cables.
- Use a recommended charger for the receiver and transmitter batteries and follow the instructions correctly. Over-charging, incorrect charging,

or using inferior chargers can cause the batteries to become dangerously hot. Recharge battery when necessary. Continual recharging may damage battery and, in the worst case, could build up heat leading to fire. If battery becomes extremely hot during recharging, please ask your local hobby shop for check and/or repair and/or replacement.

- Regularly check the charger for potential hazards such as damage to the cable, plug, casing or other defects. Ensure that any damage is rectified before using the charger again. Modifying the charger may cause short-circuit or overcharging leading to a serious accident. Therefore do not modify the charger.
- Always unplug charger when recharging is finished.
- Do not recharge battery while battery is still warm. After use, battery retains heat. Wait until it cools down before charging.
- Do not allow any metal part to short circuit the receiver batteries or other electrical/electronic device on the model.
- Immediately stop running if your RC model gets wet as may cause short circuit.
- Please dispose of batteries responsibly. Never put batteries into fire.

R/C & BUILDING TIPS

- Make sure all fasteners are properly tightened. Check them periodically.
- Make sure that chassis screws do not protrude from the chassis.
- For the best performance, it is very important that great care is taken to ensure the free movement of all parts.
- Clean all ball-bearings so they move very easily and freely.
- Tap or pre-thread the plastic parts when threading screws.
- Self-tapping screws cut threads into the parts when being tightened. Do not use excessive force when tightening the self-tapping screws because you may strip out the thread in the plastic. We recommended you stop tightening a screw when you feel some resistance.
- Ask your local hobby shop for any advice.

Please support your local hobby shop. We at XRAY Model Racing Cars support all local hobby dealers. Therefore we ask you, if at all possible, to purchase XRAY products at your hobby dealer and give them your support like we do. If you have difficulty finding XRAY products, please check out www.teamxray.com to get advice, or contact us via email at info@teamxray.com, or contact the XRAY distributor in your country.

WARRANTY

XRAY guarantees this model kit to be free from defects in both material and workmanship within 30 days of purchase. The total monetary value under warranty will in no case exceed the cost of the original kit purchased. This warranty does not cover any components damaged by use or modification or as a result of wear. Part or parts missing from this kit must be reported within 30 days of purchase. No part or parts will be sent under warranty without proof of purchase. Should you find a defective or missing part, contact the local distributor. Service and customer support will be provided through local hobby store where you have purchased the kit, therefore make sure to purchase any XRAY products at your local hobby store. This model racing car is considered to be a high-performance racing vehicle. As such this vehicle will be used in an extreme range of conditions and situations, all which may cause premature wear or failure of any component. XRAY has no control over usage of vehicles once they leave the dealer, therefore XRAY can only offer warranty against all manufacturer's defects in materials, workmanship, and assembly at point of sale and before use. No warranties are expressed or implied that cover damage caused by what is considered normal use, or cover or imply how long any model cars' components or electronic components will last before requiring replacement.

Due to the high performance level of this model car you will need to periodically maintain and replace consumable components. Any and all warranty coverage will not cover replacement of any part or component damaged by neglect, abuse, or improper or unreasonable use. This includes

but is not limited to damage from crashing, chemical and/or water damage, excessive moisture, improper or no maintenance, or user modifications which compromise the integrity of components. Warranty will not cover components that are considered consumable on RC vehicles. XRAY does not pay nor refund shipping on any component sent to XRAY or its distributors for warranty. XRAY reserves the right to make the final determination of the warranty status of any component or part.

Limitations of Liability

XRAY makes no other warranties expressed or implied. XRAY shall not be liable for any loss, injury or damages, whether direct, indirect, special, incidental, or consequential, arising from the use, misuse, or abuse of this product and/or any product or accessory required to operate this product. In no case shall XRAY's liability exceed the monetary value of this product.

Take adequate safety precautions prior to operating this model. You are responsible for this model's assembly and safe operation.

Disregard of the any of the above cautions may lead to accidents, personal injury, or property damage. XRAY MODEL RACING CARS assumes no responsibility for any injury, damage, or misuse of this product during assembly or operation, nor any additions that may arise from the use of this product.

All rights reserved.

QUALITY CERTIFICATE

XRAY MODEL RACING CARS uses only the highest quality materials, the best compounds for molded parts and the most sophisticated manufacturing processes of TQM (Total Quality Management). We guarantee that all parts of a newly-purchased kit are manufactured with the highest regard to quality. However, due to the many factors inherent in model racecar competition, we

cannot guarantee any parts once you start racing the car. Products which have been worn out, abused, neglected or improperly operated will not be covered under warranty.

We wish you enjoyment of this high-quality and high-performance RC car and wish you best success on the track!

In line with our policy of continuous product development, the exact specifications of the kit may vary. In the unlikely event of any problems with your new kit, you should contact the model shop where you purchased it, quoting the part number.

We do reserve all rights to change any specification without prior notice. All rights reserved.

TOOLS REQUIRED



EQUIPMENT REQUIRED



EQUIPMENT INCLUDED * Kit includes smaller but sufficient amount of oil and grease to build the car.

800cSt (#106381)
HUDY Premium Silicone Oils



50.000cSt (#106551)
HUDY Premium Silicone Oils



300.000cSt (#106631)
HUDY Premium Silicone Oils



(HUDY #106210)
Premium Graphite Grease



At the beginning of each section is an exploded view of the parts to be assembled. There is also a list of all the parts and part numbers that are related to the assembly of that section. The part descriptions are color-coded to make it easier for you to identify the source of a part. Here are what the different colors mean:

STYLE A - indicates parts that are included in the bag marked for the section.
STYLE B - indicates parts that are included in the box.
STYLE C - indicates parts that are already assembled from previous steps.

GTX TECH TIPS

TIP FRONT & REAR DIFF GEAR MESH ADJUSTMENT

If there is too much or too little diff side play, this may create non-optimal gear mesh between the diff gear and the pinion drive gear. This is easily resolved by inserting 1 or 2 of the included thin shims behind a diff outdrive ball-bearing, depending on how much play there is.

THE LOCATION OF THE SHIM(S) DEPENDS ON WHETHER YOU ARE TRYING TO CLOSE OR OPEN THE GAP:

TO CLOSE A WIDE GAP

CLOSE A WIDE GAP

To CLOSE a wide gap: add 1 or 2 shims against diff spur gear

insert shim(s) here

WASHER #962131 S 13 x 16 x 0.1 mm (10)
#962130 S 13 x 16 x 0.2 mm (10)

TO OPEN A NARROW GAP

OPEN A NARROW GAP

To OPEN a narrow gap: add 1 or 2 shims on the other side of the diff, away from spur gear

insert shim(s) here

WASHER #962131 S 13x16x0.1mm (10)
#962130 S 13x16x0.2mm (10)

CHECK GEAR MESH AND DIFF PLAY ONLY AFTER THE ENTIRE GEARBOX IS MOUNTED TOGETHER WITH THE SUSPENSION HOLDERS ON THE CHASSIS. ALL PARTS ARE DESIGNED TO HAVE CERTAIN PLAY AND IT IS ALL DESIGNED BY PURPOSE.

SUSPENSION & DRIVETRAIN MAINTENANCE

- Check suspension for free movement during building and operation, and especially after running and if you have crashed the car. If the suspension does not move freely, use the appropriate HUDY Arm Reamer to clean and resize the holes of the suspension arms.
- Regularly check the drive shaft pins (both side and center) and if they show any wear must be immediately replaced by new pins. If the car is run with worn pins, excessive wear on the diff outdrives will result. The 106000 HUDY Drive Pin Replacement Tool (for 3mm Pins) is a compact, rugged multi-use tool set for replacing 3mm drive pins in drive shafts. Use the HUDY replacement drive shaft pins 3x14 (#106050).
- Regularly inspect and replace the connecting pins which connect the center drive shafts with the pinion gear, and also the pins that connect the wheel drive shafts with wheel axles. Use HUDY Graphite Grease to lubricate the drive shaft connecting joints and the diff gears.
- Pivot balls and ball-joints will naturally wear for some time and will generate play. If there is too much play the pivot balls and ball joints need to be replaced.
- If the car is run in wet conditions, apply WD-40® on all drivetrain parts before the run. After the run, clean and dry the parts again.

HUDY SPRING STEEL™

The HUDY Spring Steel™ used in the car is the strongest and most durable steel material on the RC market. While items made from HUDY Spring Steel™ are still subject to wear, the lifespan is considerably longer than any other material. As parts made from HUDY Spring Steel™ wear, the brown color will after some time "go down" but it will not affect the strength of the material. The brown color is only a surface treatment and if the brown color will wear the durability of the part will be still strong.

TIP DRIVE SHAFT PIN SERVICING

To enjoy the longest possible lifespan of the drive shafts and diff outdrives, it is extremely important to properly service the drive shaft pins. Inspect the pins after every 3 hours of runtime. If the pins show any wear, replace them with new pins.

- 1 Do not use drive shafts when the pins are worn.
- 2 Press out the worn pins.
- 3 Press in new pins and regularly inspect for wear.

For easy drive pin replacements use #106000 HUDY Drive Pin Replacement Tool.

To replace the worn pins use only premium HUDY drive pins #106050.

1. DIFFERENTIALS



XRAY BALL-BEARING

OPTION	#930816	8x16x5	GREASE	STEEL	OPTION
	#930817	8x16x5	OIL	STEEL	OPTION
	#940816	8x16x5	GREASE	RUBBER	OPTION
	#940817	8x16x5	OIL	RUBBER	INCLUDED



355064
FRONT DIFF. OUTDRIVE ADAPTER
LONG - V2 - HSS™ (2)

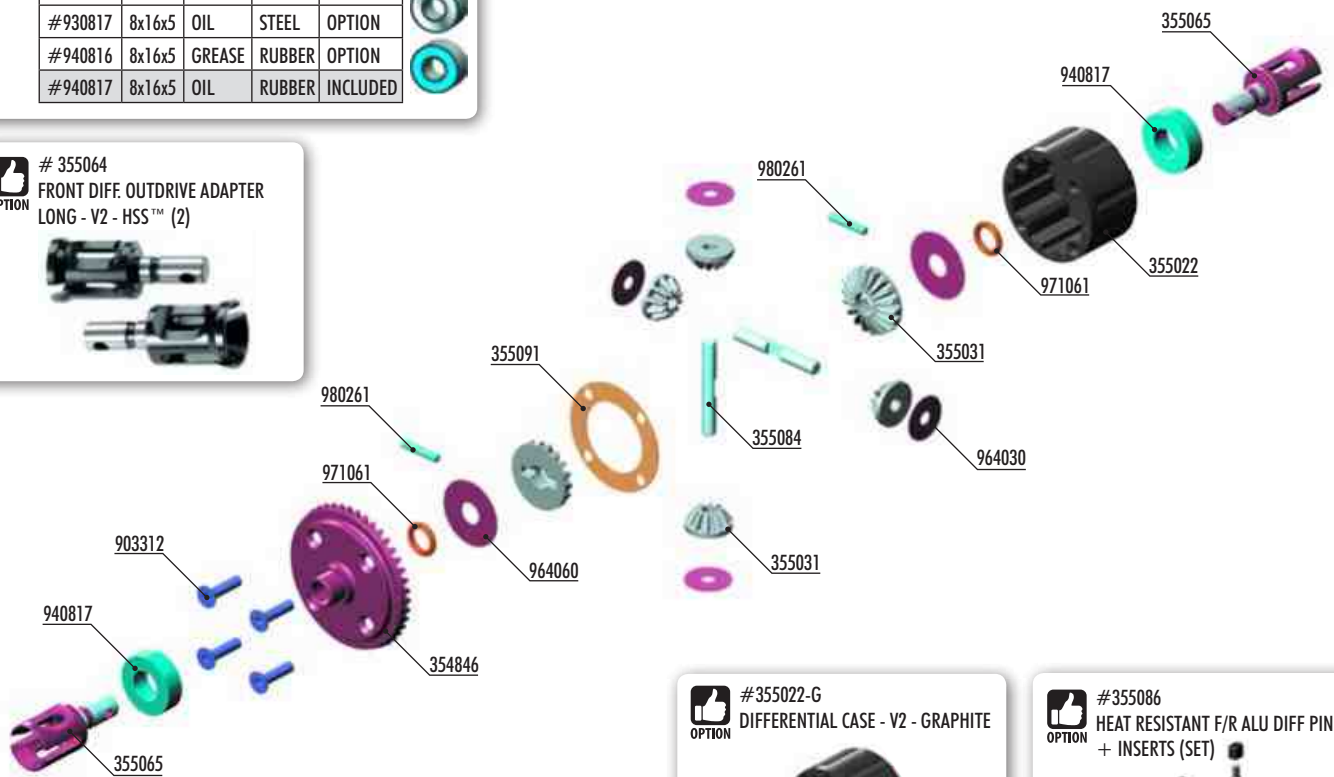

#355022-G
DIFFERENTIAL CASE - V2 - GRAPHITE



#355086
HEAT RESISTANT F/R ALU DIFF PIN
+ INSERTS (SET)



BAG

01

- 354846 BEVEL DRIVE PINION GEAR 13T - MATCHED FOR 46T LARGE BEVEL GEAR
- 355006 DIFFERENTIAL 46T - MATCHED FOR 13T PINION GEAR - SET
- 355022 DIFFERENTIAL CASE - V2
- 355031 STEEL DIFF BEVEL & SATELLITE GEARS - V2 (2+4)
- 355065 DIFF OUTDRIVE ADAPTER - V2 - HUDY SPRING STEEL™ (2)
- 355084 F/R DIFF PIN (2)
- 355091 F/R DIFF GASKET (4)

- 903312 HEX SCREW SFH M3x12 (10)
- 940817 BALL-BEARING 8x16x5 RUBBER SEALED - OIL (2)
- 964030 WASHER S 3.5x12x0.2 (10)
- 964060 WASHER S 6x18x0.2 (10)
- 971061 SILICONE O-RING 6x1.55 (10)
- 980261 PIN 2.5x11.5 (10)

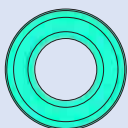

940817
BB 8x16x5



964060
S 6x18x0.2



971061
O 6x1.55



980212
P 2x11.6

2x
F=R

TIP Use HUDY Ball-Bearing Grease or Oil for servicing:
#106220 - Standard
#106221 - Extra
#106222 - Premium
#106230 - Bearing Oil

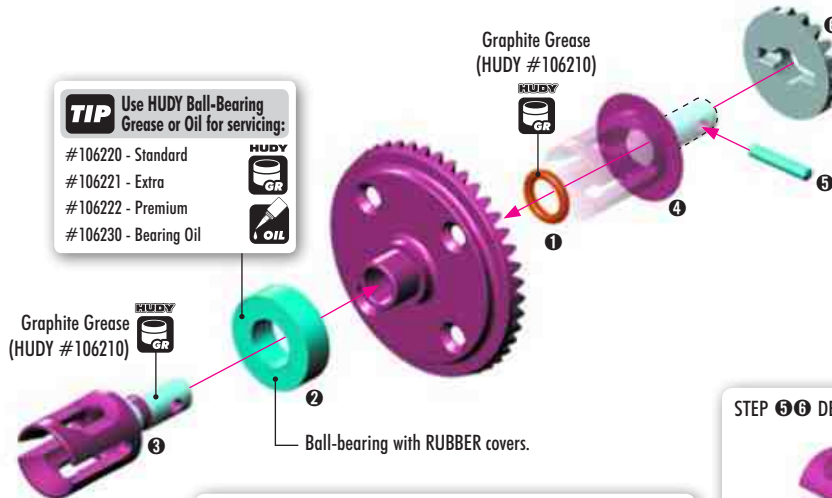

Graphite Grease (HUDY #106210)

Ball-bearing with RUBBER covers.



XRAY BALL-BEARING

OPTION	#930816	8x16x5	GREASE	STEEL	OPTION
	#930817	8x16x5	OIL	STEEL	OPTION
	#940816	8x16x5	GREASE	RUBBER	OPTION
	#940817	8x16x5	OIL	RUBBER	INCLUDED



STEP 5-6 DETAIL

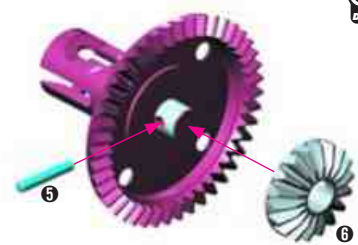

SET-UP BOOK

DIFFERENTIAL GEARS

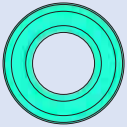

940817
BB 8x16x5

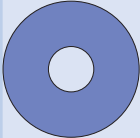

964060
S 6x18x0.2



971061
O 6x1.55



980212
P 2x11.6

2x F=R

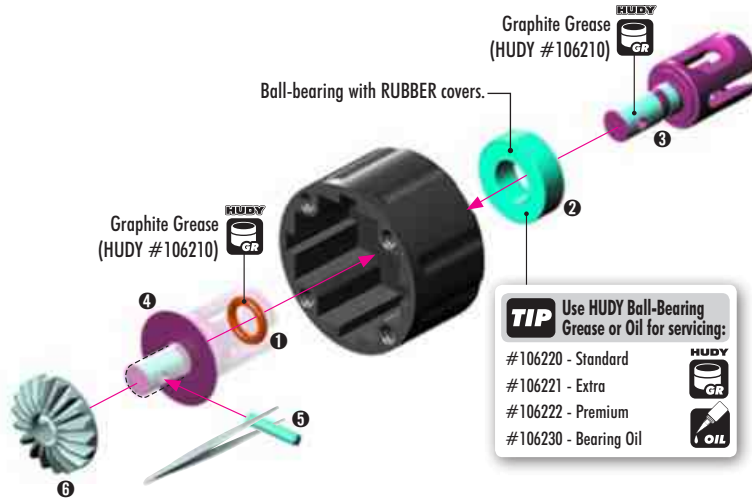

TIP Use HUDY Ball-Bearing Grease or Oil for servicing:
#106220 - Standard
#106221 - Extra
#106222 - Premium
#106230 - Bearing Oil

STEP 6 DETAIL



VERY IMPORTANT!

Use the following silicone oils included in the kit for initial settings:
FRONT diff: 300.000cSt / REAR diff: 50.000cSt

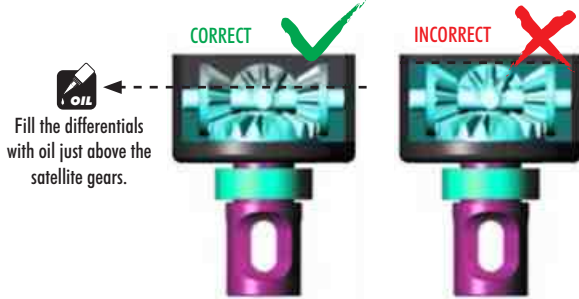

IMPORTANT!
Do not overfill the differential. If there is too much oil in the differential, it may leak after it cools down after use.

To ensure you have the same amount of oil from rebuild to rebuild, do the following:

#107865 HUDY Ultimate Digital Pocket Scale 300g ± 0.01g



1. Put the diff (without oil) on the scale and check the weight:

- FRONT DIFF approx. 39.10g
- REAR DIFF approx. 39.10g

2. Slowly pour oil into the diff and watch the weight.

- The approximate weight of the diff+oil is REAR DIFF approx. 41.10g and FRONT DIFF approx. 41.10g

REAR DIFF	39.10g + 2.0g	= 41.10g
FRONT DIFF	39.10g + 2.0g	= 41.10g

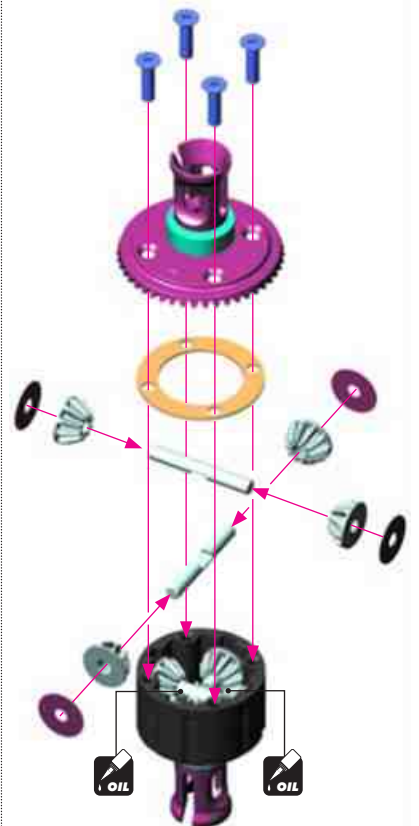

Front diff:

Silicone oil 300.000cSt
Fill just above the satellite gears.

Rear diff:

Silicone oil 50.000cSt
Fill just above the satellite gears.

SET-UP BOOK

DIFFERENTIAL OIL

Tighten the screws equally.



Finish tightening in this order.



After assembly the differentials should have a length of 32.3~32.5 mm measured from the ends of the installed ball-bearings. If differentials are longer, retighten the 4 screws holding the crown gears.



32.3~32.5 mm

2. FRONT & REAR TRANSMISSION



XRAY BALL-BEARING

OPTION	#	SIZE	LUBRICATION	MATERIAL	STATUS
	#930816	8x16x5	GREASE	STEEL	INCLUDED
	#930817	8x16x5	OIL	STEEL	OPTION

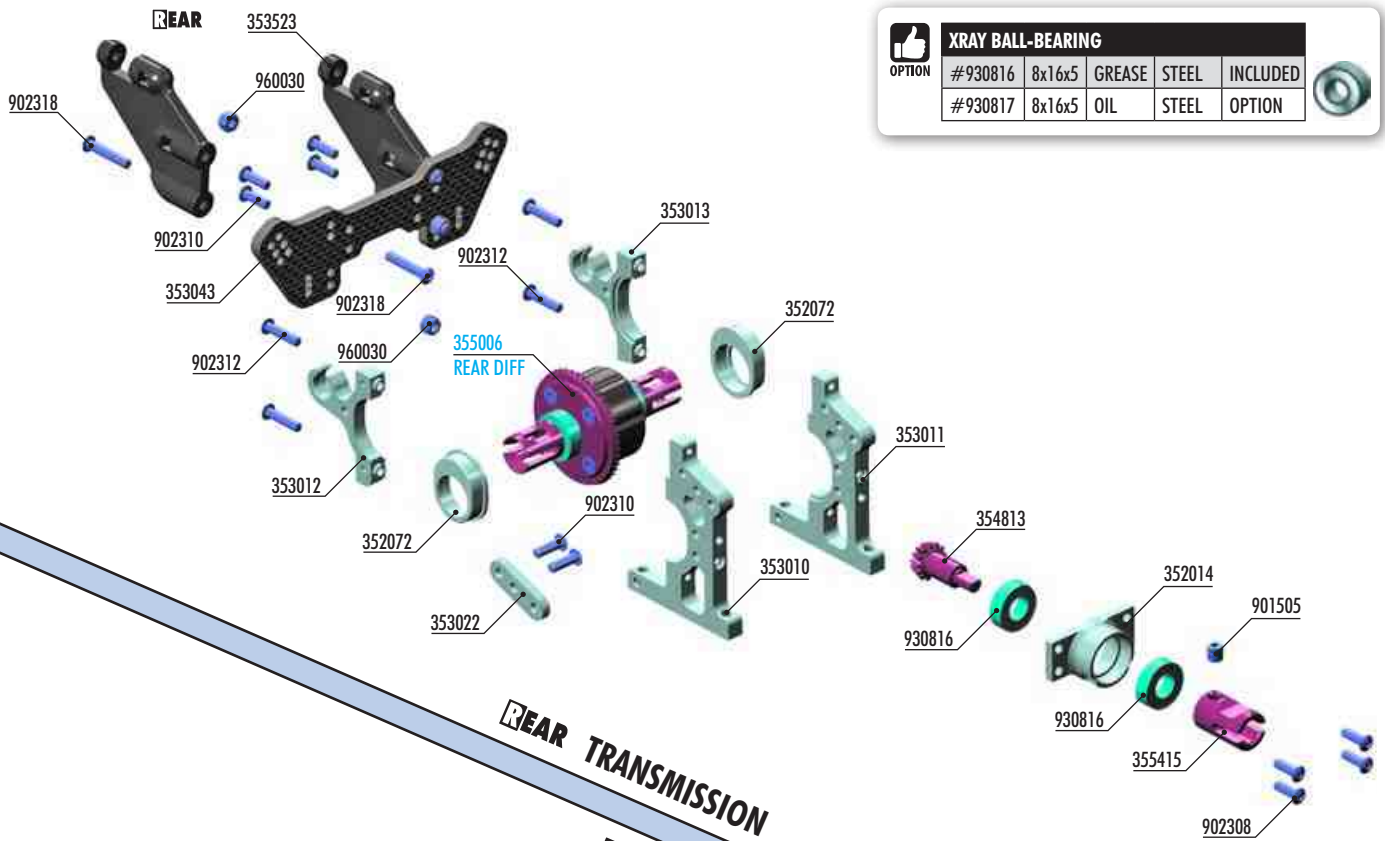

REAR TRANSMISSION

FRONT TRANSMISSION

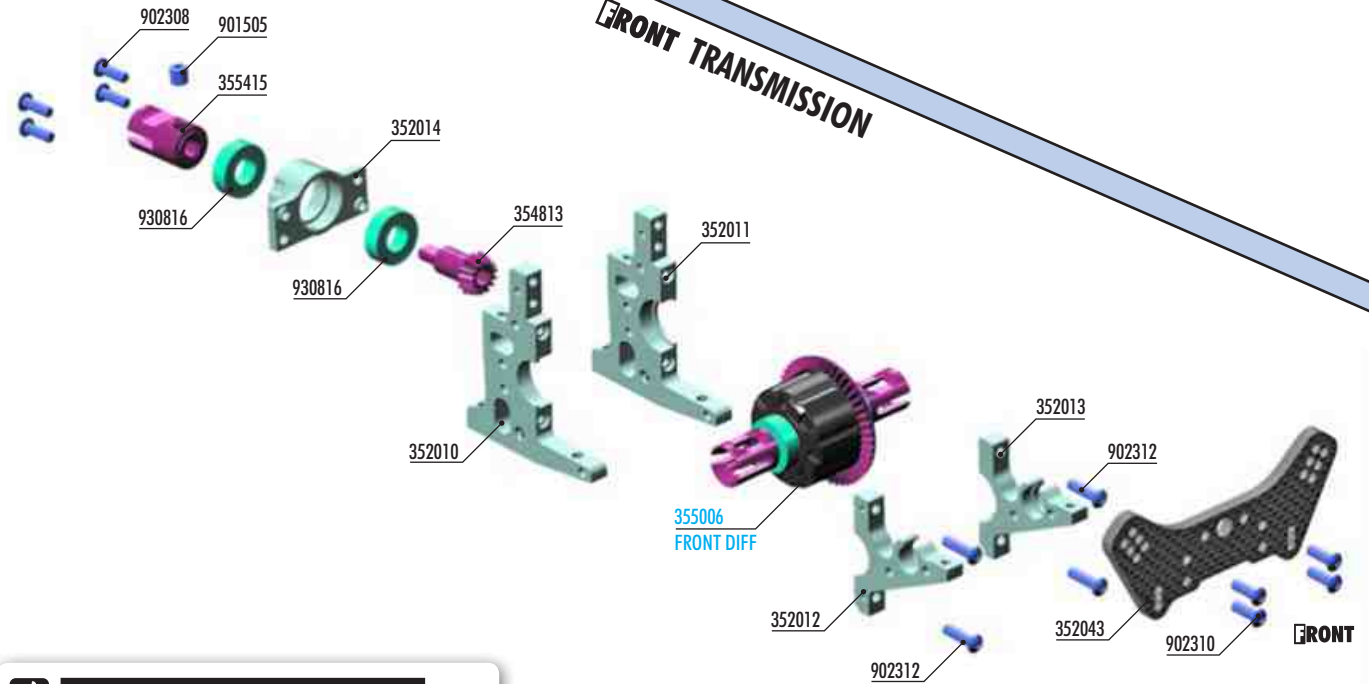

XRAY BALL-BEARING

OPTION	#	SIZE	LUBRICATION	MATERIAL	STATUS
	#930816	8x16x5	GREASE	STEEL	INCLUDED
	#930817	8x16x5	OIL	STEEL	OPTION



BAG

02

- 352010 ALU FRONT BULKHEAD - RIGHT - SWISS 7075 T6
- 352011 ALU FRONT BULKHEAD - LEFT - SWISS 7075 T6
- 352012 ALU FRONT ANTI-ROLL BAR BULKHEAD - RIGHT - SWISS 7075 T6
- 352013 ALU FRONT ANTI-ROLL BAR BULKHEAD - LEFT - SWISS 7075 T6
- 352014 ALU ADAPTER FOR CENTER JOINT - SWISS 7075 T6
- 352043 GRAPHITE FRONT SHOCK TOWER 4MM
- 352072 ALU ADJUSTMENT BALL-BEARING HUB - SWISS 7075 T6 (2)
- 353010 ALU REAR BULKHEAD - RIGHT - SWISS 7075 T6
- 353011 ALU REAR BULKHEAD - LEFT - SWISS 7075 T6
- 353012 ALU REAR ANTI-ROLL BAR BULKHEAD - RIGHT - SWISS 7075 T6
- 353013 ALU REAR ANTI-ROLL BAR BULKHEAD - LEFT - SWISS 7075 T6
- 353022 ALU REAR BRACE HOLDER - SWISS 7075 T6
- 353043 GRAPHITE REAR SHOCK TOWER 4MM

- 353523 GT COMPOSITE REAR HOLDER POST (2)
- 354813 BEVEL DRIVE PINION GEAR 13T - MATCHED FOR 46T LARGE BEVEL GEAR
- 355415 CENTRAL DOGBONE SHAFT UNIVERSAL JOINT - HUDY SPRING STEEL™ (2)

- 901505 HEX SCREW SB M5x5 (10)
- 902308 HEX SCREW SH M3x8 (10)
- 902310 HEX SCREW SH M3x10 (10)
- 902312 HEX SCREW SH M3x12 (10)
- 902318 HEX SCREW SH M3x18 (10)
- 930816 BALL-BEARING 8x16x5 STEEL SEALED - GREASE (2)
- 960030 NUT M3 (10)

- 355006 DIFFERENTIAL 46T - MATCHED FOR 13T PINION GEAR - SET

2. FRONT & REAR TRANSMISSION

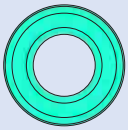

930816
BB 8x16x5



901505
SB M5x5

2x FRONT & REAR TRANSMISSION

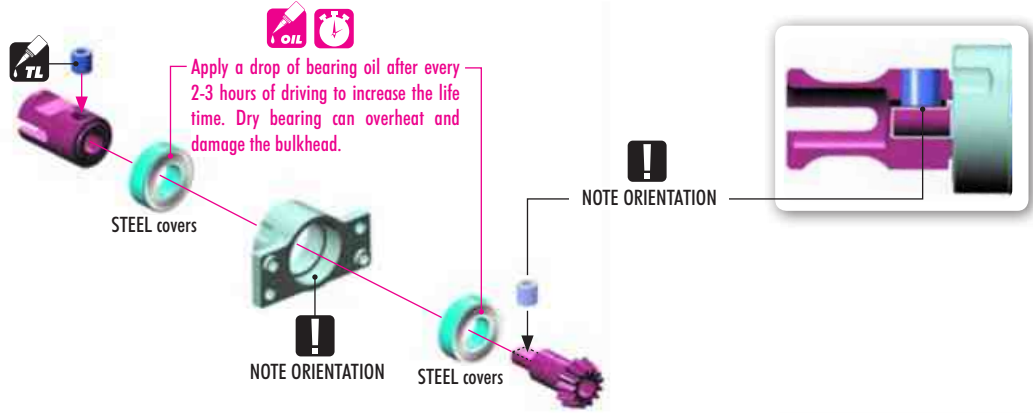

TIP Use HUDY Ball-Bearing Grease or Oil for servicing:

HUDY

- #106220 - Standard
- #106221 - Extra
- #106222 - Premium
- #106230 - Bearing Oil

XRAY BALL-BEARING

OPTION	#930816	8x16x5	GREASE	STEEL	INCLUDED
	#930817	8x16x5	OIL	STEEL	OPTION



902308
SH M3x8

REAR TRANSMISSION

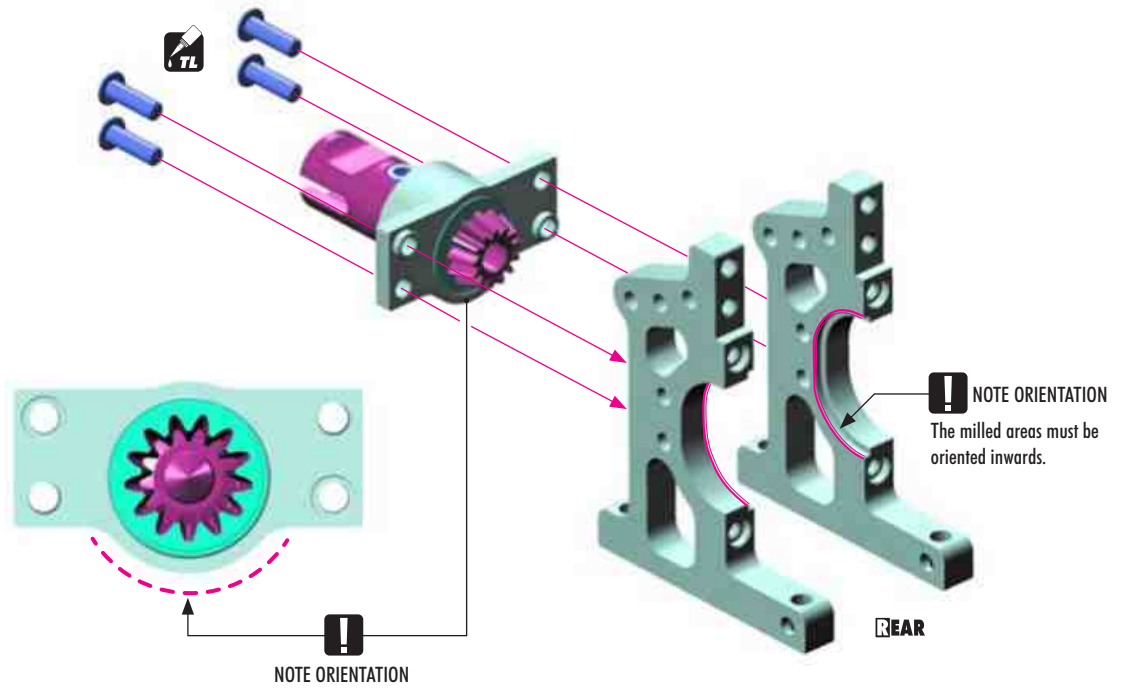

2. FRONT & REAR TRANSMISSION



902312
SH M3x12

REAR TRANSMISSION

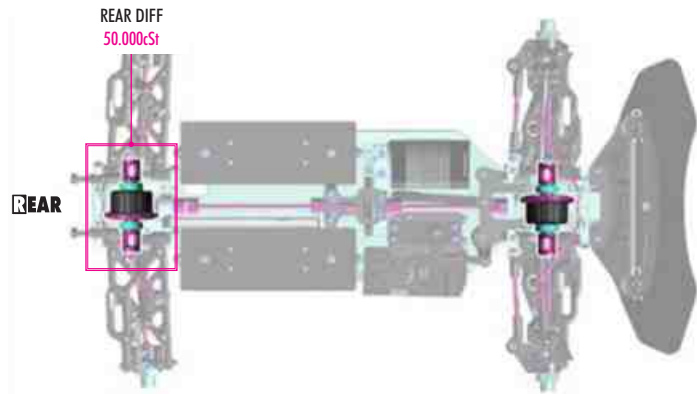
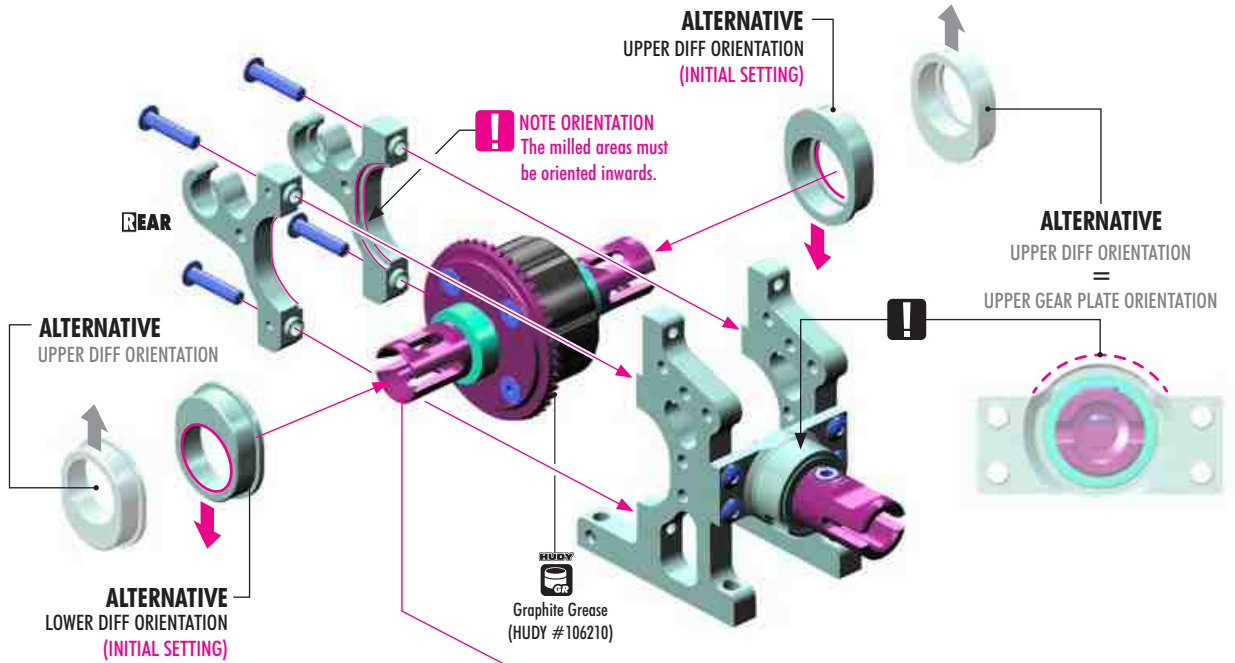

902310
SH M3x10



902318
SH M3x18



960030
N M3

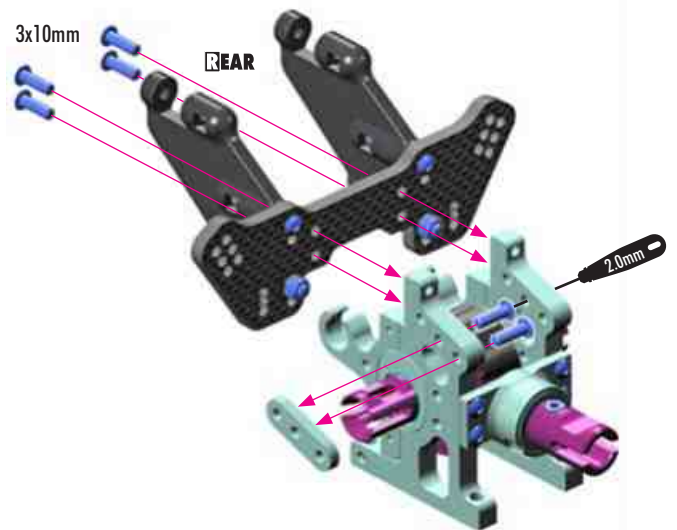
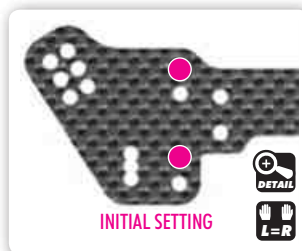
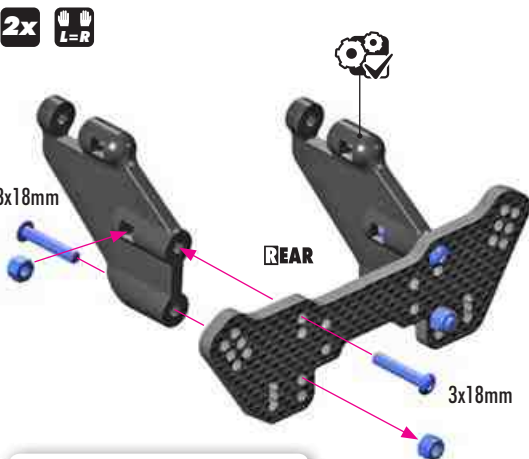

2. FRONT & REAR TRANSMISSION



902308
SH M3x8

FRONT TRANSMISSION

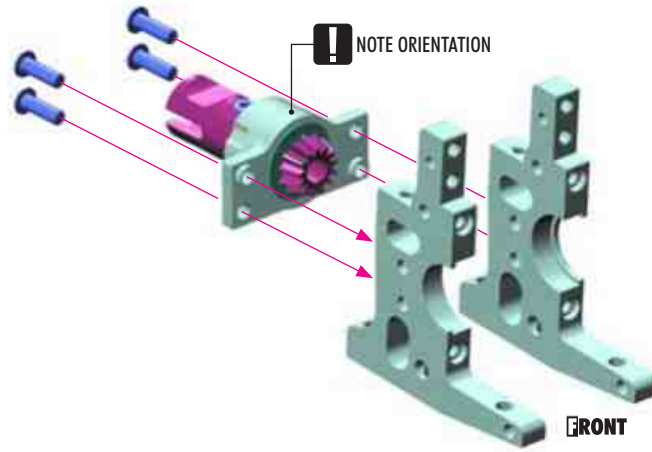

902312
SH M3x12

FRONT TRANSMISSION

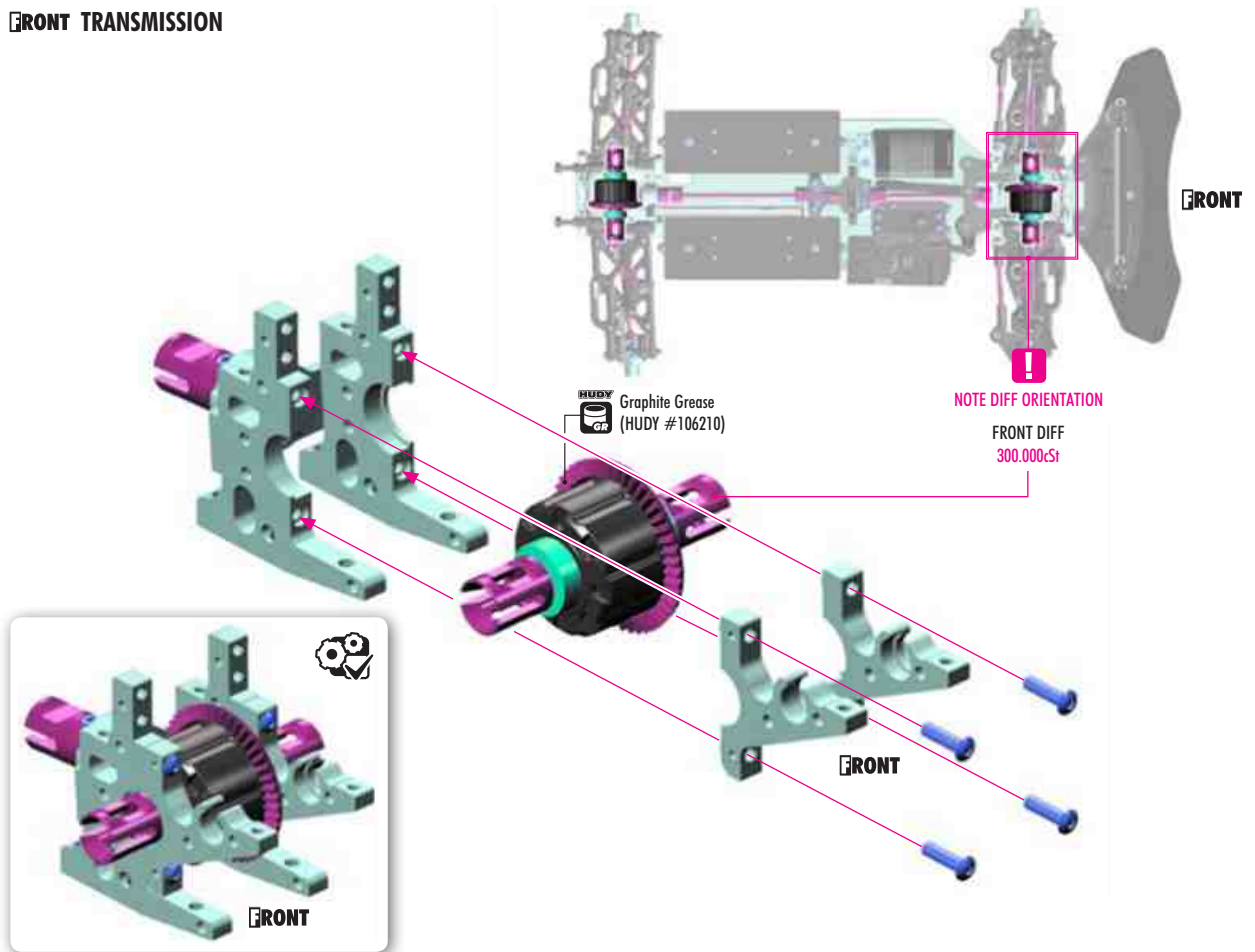

902310
SH M3x10

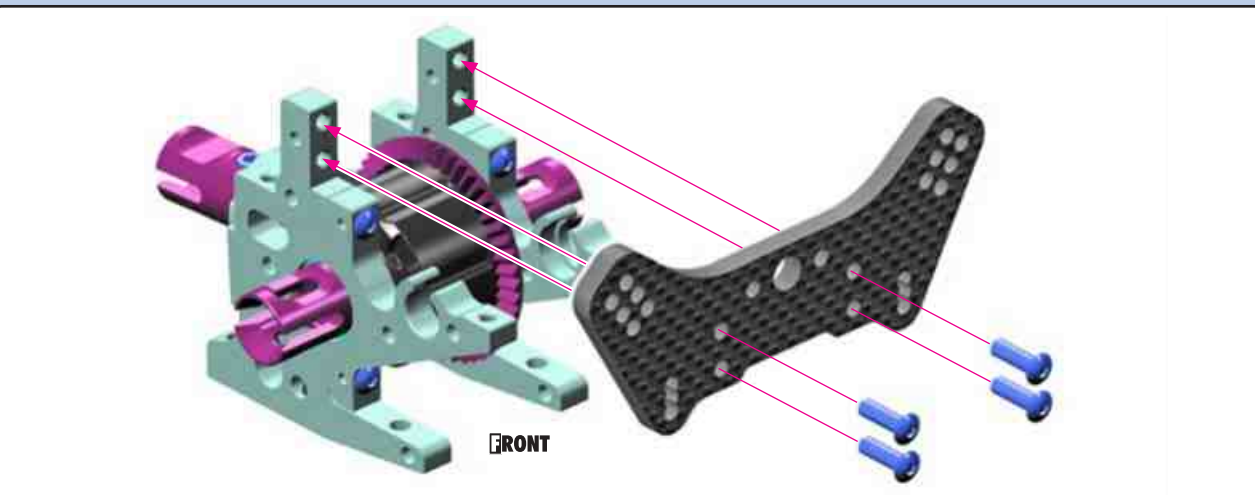

3. REAR SUSPENSION

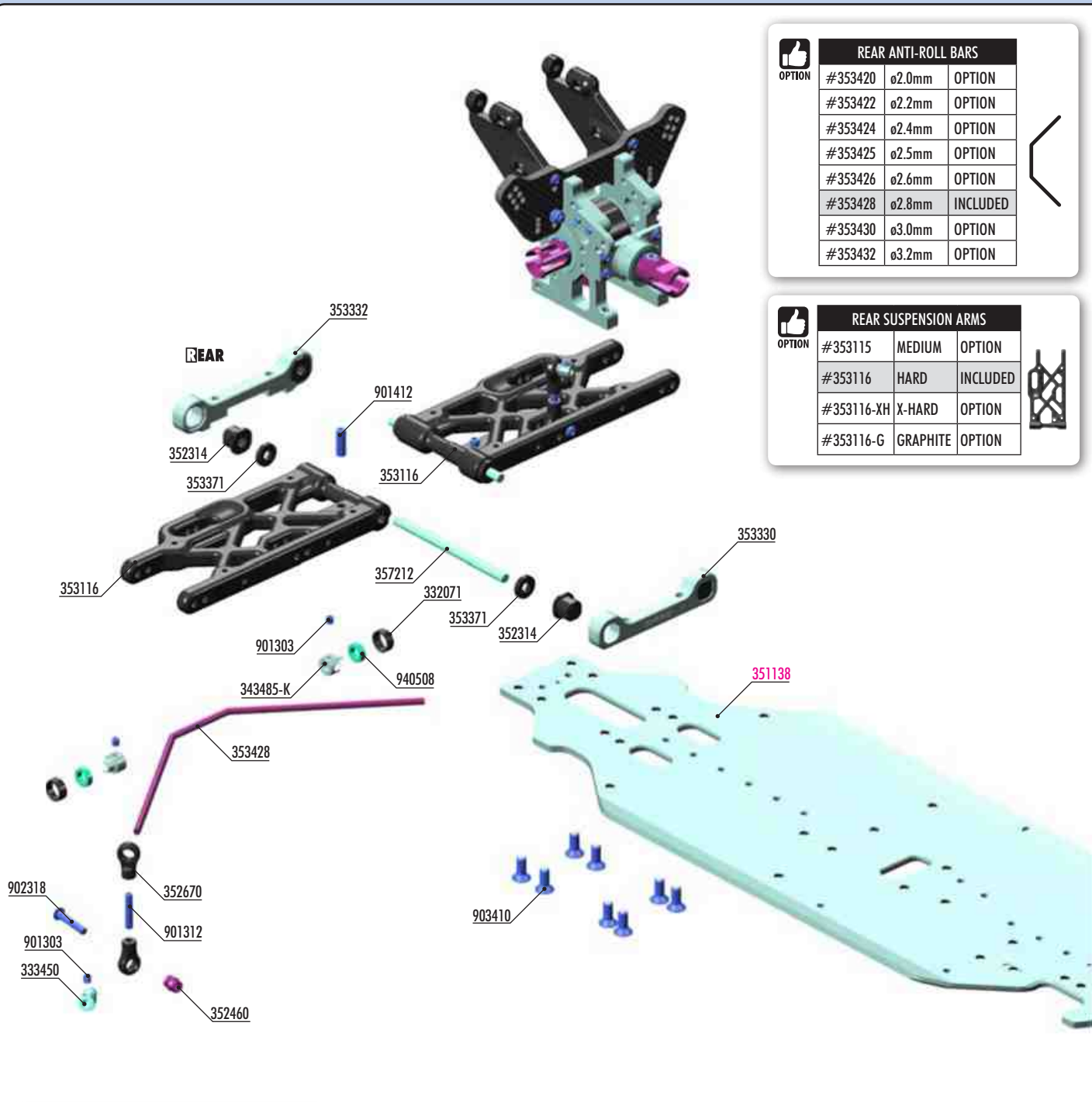

REAR ANTI-ROLL BARS		
#353420	ø2.0mm	OPTION
#353422	ø2.2mm	OPTION
#353424	ø2.4mm	OPTION
#353425	ø2.5mm	OPTION
#353426	ø2.6mm	OPTION
#353428	ø2.8mm	INCLUDED
#353430	ø3.0mm	OPTION
#353432	ø3.2mm	OPTION

REAR SUSPENSION ARMS		
#353115	MEDIUM	OPTION
#353116	HARD	INCLUDED
#353116-XH	X-HARD	OPTION
#353116-G	GRAPHITE	OPTION

ALU ANTI-ROLL BAR COLLAR		
#343483-K	ø2.2mm	OPTION
#343484-K	ø2.4mm	OPTION
#343482-K	ø2.6mm	OPTION
#343485-K	ø2.8mm	INCLUDED
#343481-K	ø3.0mm	OPTION

#333451	ALU ANTI-ROLL BAR PIVOT BALL 5.8 MM - SWISS 7075 T6 - HARDCOATED (2)
---------	---

BAG
03

- 332071 COMPOSITE BALL-BEARING HUB (4)
- 333450 ANTI-ROLL BAR BALL JOINT 5.8 MM (2)
- 343485-K ALU CUTTED ANTI-ROLL BAR COLLAR ø2.8 - BLACK (2)
- 352314 COMPOSITE ECCENTRIC BUSHINGS - V2 (2)
- 352460 PIVOT BALL 5.8 (10)
- 352670 COMPOSITE BALL JOINT 5.8 (8)
- 353116 COMPOSITE REAR LOWER SUSPENSION ARM - HARD
- 353330 ALU REAR LOWER SUSP. HOLDER - FRONT - SQUARE ADJ. ROLL-C.
- 353332 ALU REAR LOWER SUSP. HOLDER - REAR - SQUARE ADJ. ROLL-C.
- 353371 SET OF COMPOSITE LOWER ARM SHIMS
- 353428 REAR ANTI-ROLL BAR 2.8MM
- 357212 LOWER INNER PIVOT PIN F+R (2)
- 901303 HEX SCREW SB M3x3 (10)
- 901312 HEX SCREW SB M3x12 (10)
- 901412 HEX SCREW SB M4x12 (10)
- 902318 HEX SCREW SH M3x18 (10)
- 903410 HEX SCREW SFH M4x10 (10)
- 940508 BALL-BEARING 5x8x2.5 RUBBER SEALED - OIL (2)
- 351138 GTXE'23 ALU CHASSIS - SWISS 7075 T6 (3MM)**

3. REAR SUSPENSION



353371
SHIM 4x10x2



901412
SB M4x12

TOP DOWNSTOP SETTING

DETAIL

L=R

BOTTOM 3.4mm

RR

INITIAL SETTING

1° 0.5°

NOTE ARMS ORIENTATION

TIP

If the suspension arm does not move freely use a HUDY Arm Reamer to resize the holes of the arms.

(HUDY #107634)

ARM REAMER

REAR SUSPENSION ARMS

OPTION		OPTION
#353115	MEDIUM	OPTION
#353116	HARD	INCLUDED
#353116-XH	X-HARD	OPTION
#353116-G	GRAPHITE	OPTION

RF

INITIAL SETTING

1° 0.5°

ANTI-SQUAT

RR	RF	(°)
□	□	= 1°
□	□	= 2°
□	□	= 0°
□	□	= 2°
□	□	= 1°
□	□	= 3°
□	□	= 0°
□	□	= 1°
□	□	= -1°

The new XRAY rear alu lower suspension holders provide even greater range of adjustment for the rear suspension. Using different combinations of eccentric bushings, fine adjustment of rear anti-squat, rear toe-in, rear roll center, and rear track-width can be obtained. For more information about the influence of rear anti-squat, rear toe-in, rear roll center and rear track width on car handling, please refer to HUDY Off-Road Set-up Book (#209099).

ROLL CENTER

RR	RF	(mm)
□	□	= 0mm
□	□	= 1mm
□	□	= -1mm

TRACK-WIDTH

RR	RF	(mm)
□	□	= 308
□	□	= 306
□	□	= 310

The tables describe the amounts of rear anti-squat, rear toe-in, rear track-width change depending on the combinations of eccentric bushings used with 0 and 1mm, 1° off set. The 0.5mm, 0.5° represent the half change.

TOE-IN

RR	RF	(°)
□	□	= 3°
□	□	= 4°
□	□	= 2°
□	□	= 2°
□	□	= 3°
□	□	= 1°
□	□	= 4°
□	□	= 5°
□	□	= 3°



903410
SFH M4x10

Push the arm from both sides to create play.

DETAIL

3. REAR SUSPENSION



903410
SFH M4x10

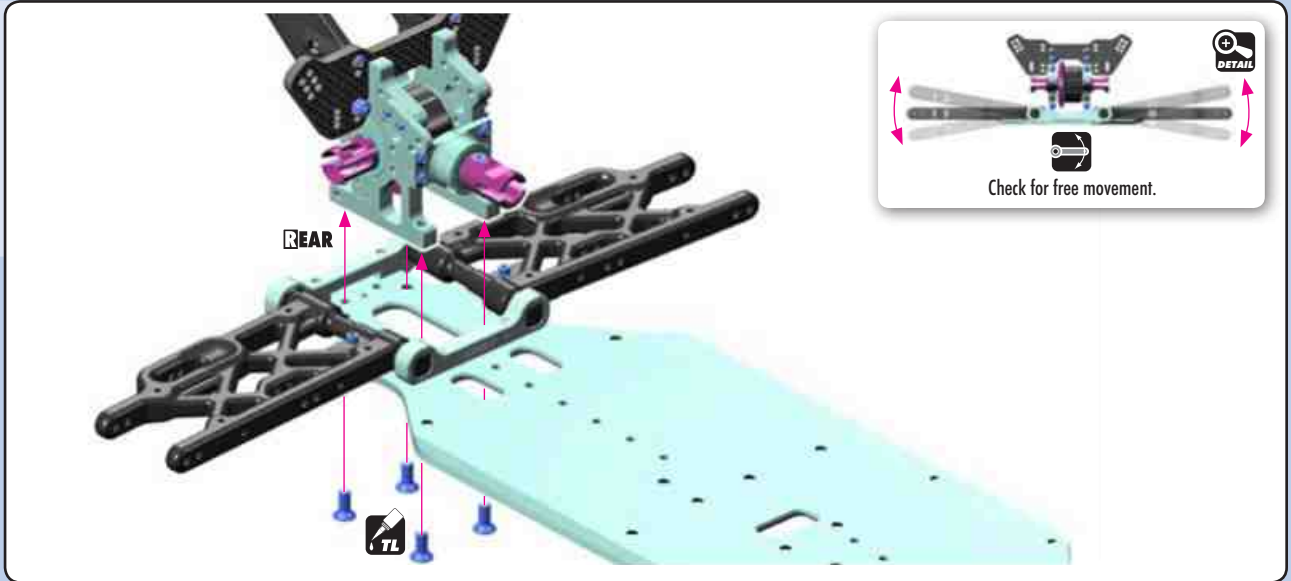

901312
SB M3x12



940508
BB 5x8x2.5

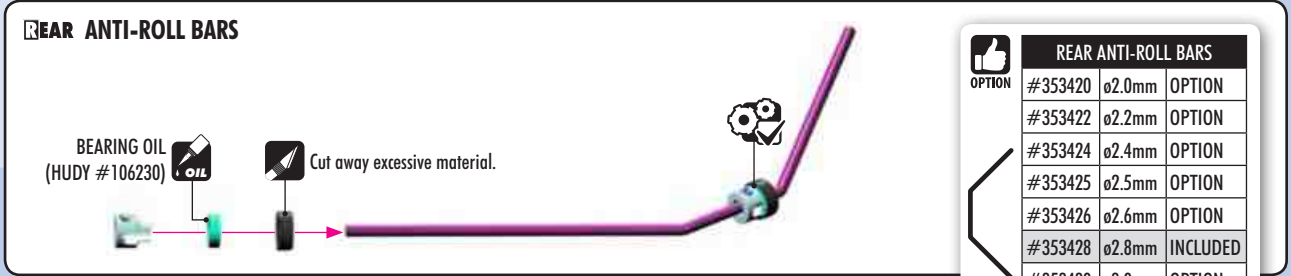

REAR ANTI-ROLL BARS		
OPTION	#353420	ø2.0mm
OPTION	#353422	ø2.2mm
OPTION	#353424	ø2.4mm
OPTION	#353425	ø2.5mm
OPTION	#353426	ø2.6mm
INCLUDED	#353428	ø2.8mm
OPTION	#353430	ø3.0mm
OPTION	#353432	ø3.2mm



901303
SB M3x3

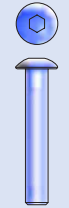

902318
SH M3x18

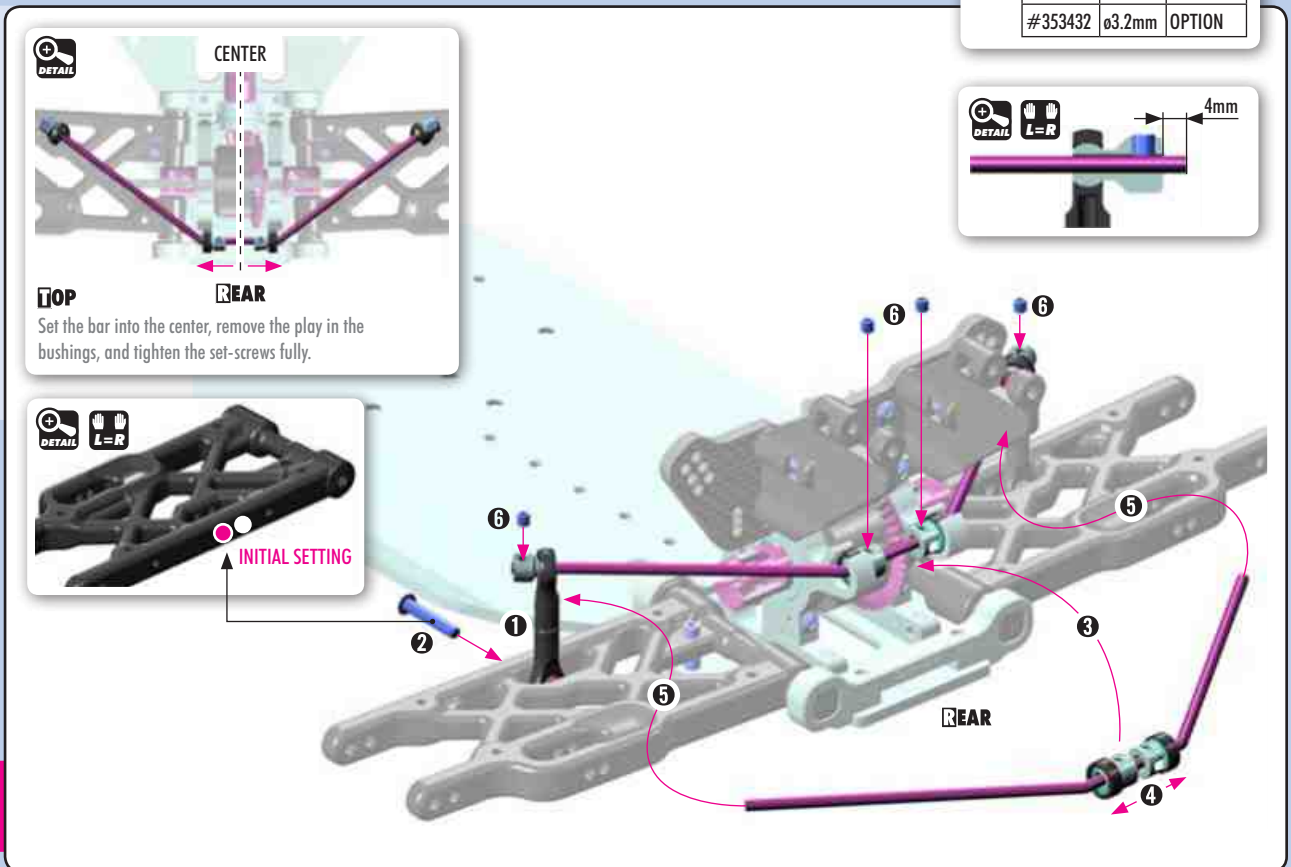

SET-UP BOOK
ANTI-ROLL BAR

4. REAR SUSPENSION

2x

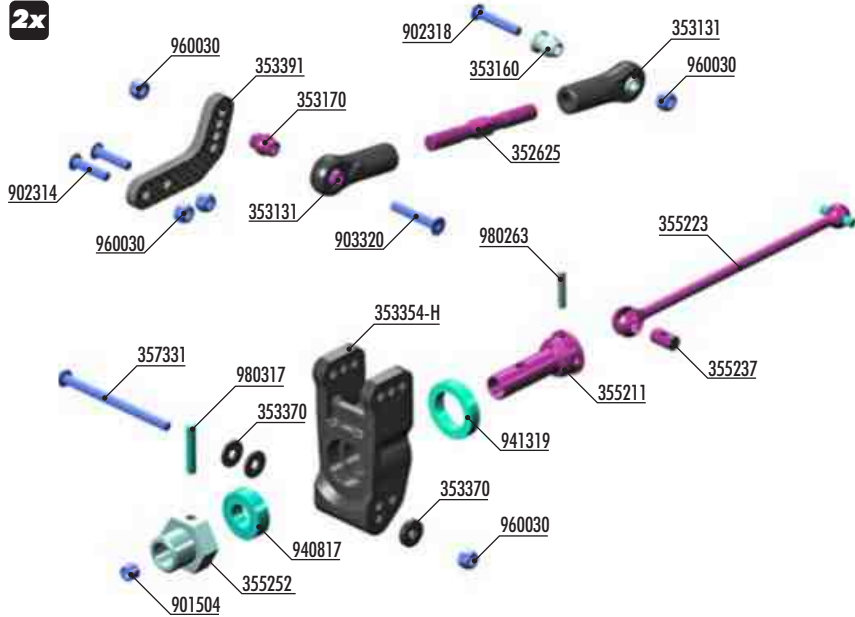

OFFSET WHEEL AXLES

#355250	0mm	OPTION	
#355251	+ 1mm	OPTION	
#355252	+ 2mm	INCLUDED	



REAR UPRIGHTS

#353354	MEDIUM	OPTION	
#353354-H	HARD	INCLUDED	
#353354-G	GRAPHITE	OPTION	



#350909 XRAY GTX ALU REAR UPRIGHTS - SET

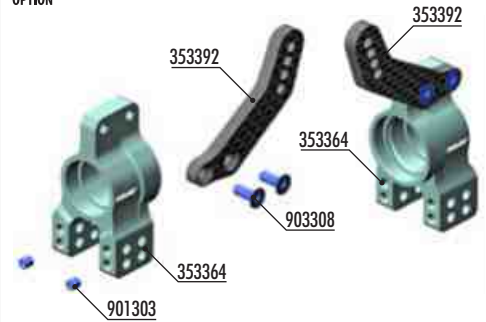

XRAY BALL-BEARING

#930816	8x16x5	GREASE	STEEL	OPTION	
#940816	8x16x5	GREASE	RUBBER	OPTION	
#931318	13x19x4	GREASE	STEEL	OPTION	
#941318	13x19x4	GREASE	RUBBER	OPTION	
#930817	8x16x5	OIL	STEEL	OPTION	
#940817	8x16x5	OIL	RUBBER	INCLUDED	
#931319	13x19x4	OIL	STEEL	OPTION	
#941319	13x19x4	OIL	RUBBER	INCLUDED	

BAG

04

- 352625 ADJ. TURNBUCKLE M5 L/R 46MM - HUDY SPRING STEEL™ (2)
- 353131 REAR UPPER INNER CAMBER LINK BALL JOINT - V3 (2)
- 353160 MOUNTING BALL 6.8 (4)
- 353170 PIVOT BALL 6.8 (4)
- 353354-H COMPOSITE REAR UPRIGHT LB - HARD
- 353370 SET OF COMPOSITE REAR HUB CARRIER SHIMS
- 353391 GRAPHITE REAR ROLL CENTER UPRIGHT PLATE 4MM - V2 (2)
- 355211 CVD DRIVE AXLE - HUDY SPRING STEEL™
- 355223 CVD UNIVERSAL DRIVE SHAFT 93MM - HUDY SPRING STEEL™
- 355237 CVD DRIVE SHAFT COUPLING - HUDY SPRING STEEL™
- 355252 ALU WHEEL AXLE OFFSET +2MM - BLACK COATED (2)
- 357331 REAR LOWER OUTER PIVOT PIN SCREW 3MM (2)

- 901504 HEX SCREW SB M5x4 (10)
- 902314 HEX SCREW SH M3x14 (10)
- 902318 HEX SCREW SH M3x18 (10)
- 903320 HEX SCREW SFH M3x20 (10)
- 940817 BALL-BEARING 8x16x5 RUBBER SEALED - OIL (2)
- 941319 BALL-BEARING 13x19x4 RUBBER SEALED - OIL (2)
- 960030 NUT M3 (10)
- 980263 PIN 2.5x13 (10)
- 980317 PIN 3x17 (10)

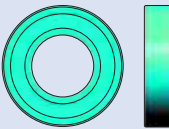

940817 BB 8x16x5

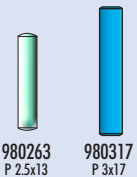

980263 P 2.5x13 980317 P 3x17



901504 SB M5x4

2x

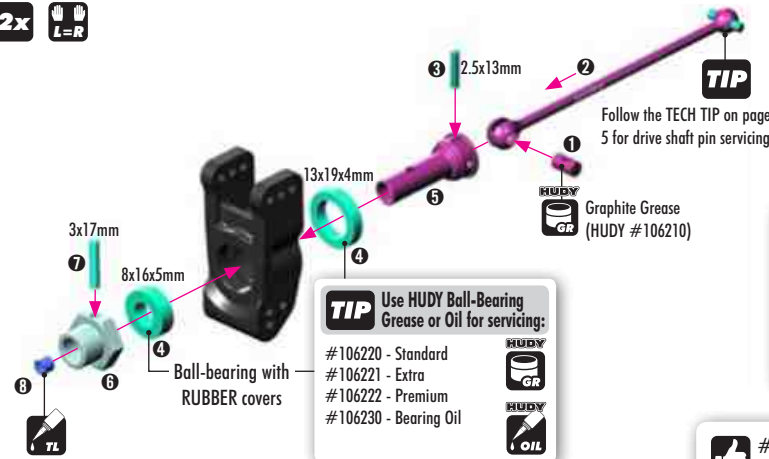

TIP

Follow the TECH TIP on page 5 for drive shaft pin servicing

TIP

Use HUDY Ball-Bearing Grease or Oil for servicing:

- #106220 - Standard
- #106221 - Extra
- #106222 - Premium
- #106230 - Bearing Oil



TIP

To tighten the setscrew you can also use the HUDY 17mm Wheel Nut Tool #107570.



OFFSET WHEEL AXLES

#355250	0mm	OPTION	
#355251	+ 1mm	OPTION	
#355252	+ 2mm	INCLUDED	



REAR UPRIGHTS

#353354	MEDIUM	OPTION	
#353354-H	HARD	INCLUDED	
#353354-G	GRAPHITE	OPTION	
#353364	ALU	OPTION	



#350909 XRAY GTX ALU REAR UPRIGHTS - SET

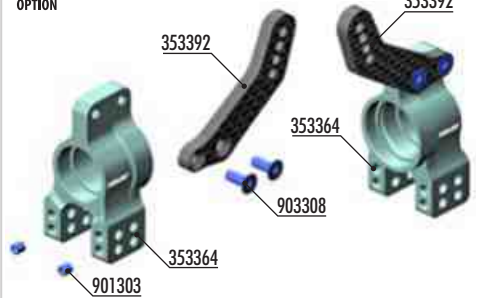

4. REAR SUSPENSION



353370
SHIM 3x9x1



353370
SHIM 3x9x2



960030
N M3

2x
L=R

TIP Ensure that the rear upright moves freely. If it does not move freely, use sandpaper to thin both wheelbase adjustment shims.

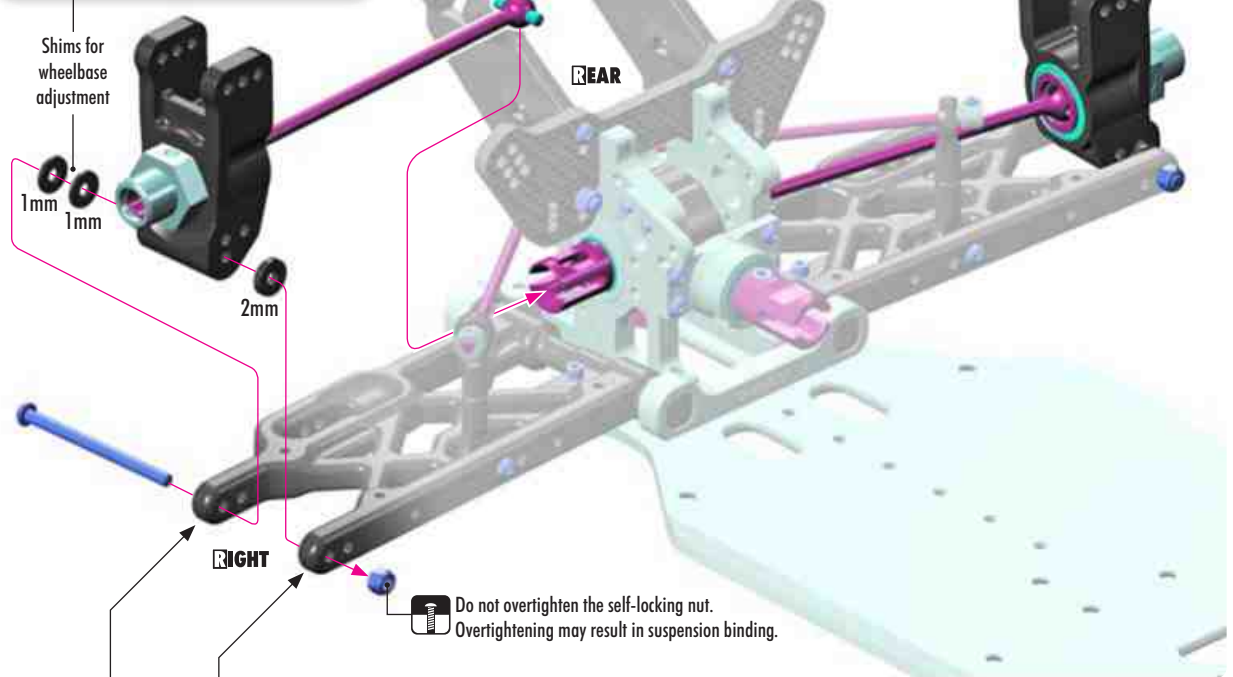

2x
L=R

TIP If the suspension arm does not move freely use a HUDY Arm Reamer to resize the holes of the arms. (HUDY #107633)

ARM REAMER

DETAIL

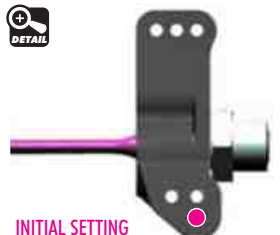

DETAIL

Check for free movement.



2x
L=R

TIP



Install the pivot balls with Professional Multi Tool (HUDY #183011).

NOTE ORIENTATION



NOTE ORIENTATION

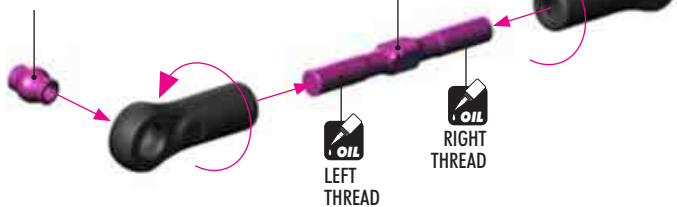
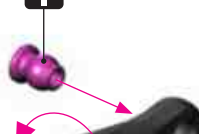

Use tools to tighten as shown.

DETAIL



Special Tool for all turnbuckles & nuts (HUDY #181090) or Turnbuckle Wrench 5mm (HUDY #181050).

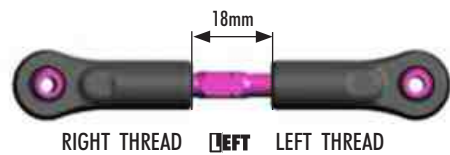
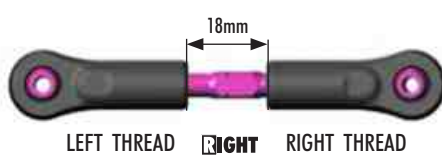

SET-UP BOOK

CAMBER

4. REAR SUSPENSION

- 

902314
SH M3x14
- 

902318
SH M3x18
- 

903320
SFH M3x20
- 

960030
N M3

2x 

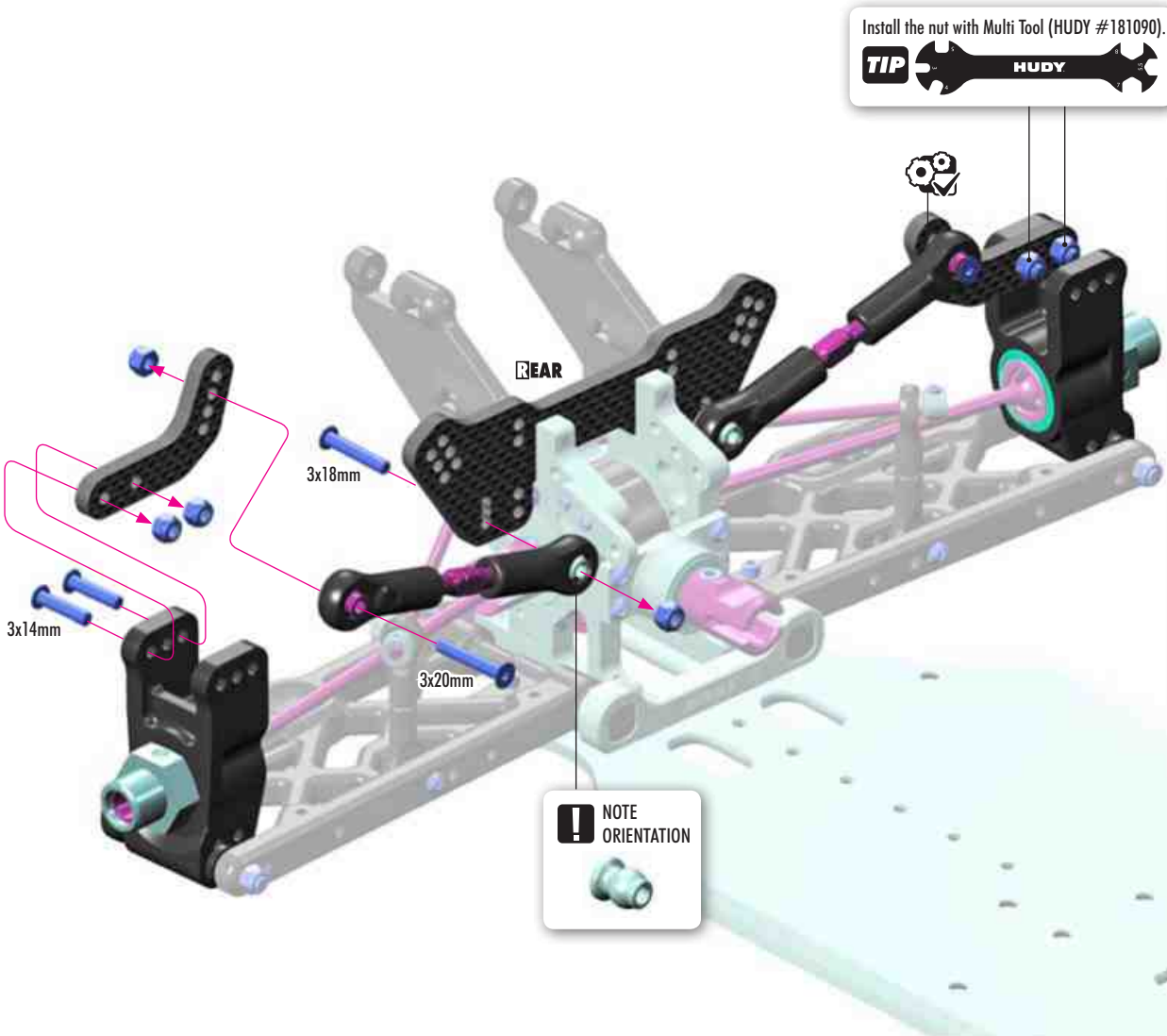

Install the nut with Multi Tool (HUDY #181090).



! NOTE ORIENTATION

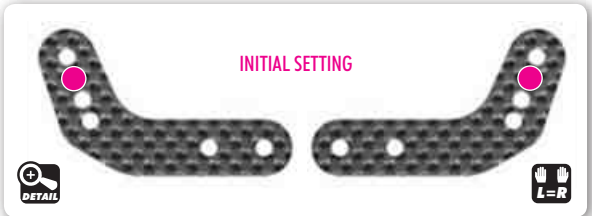
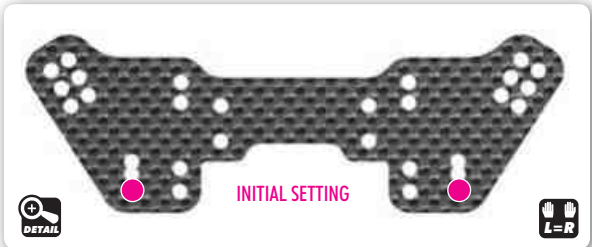
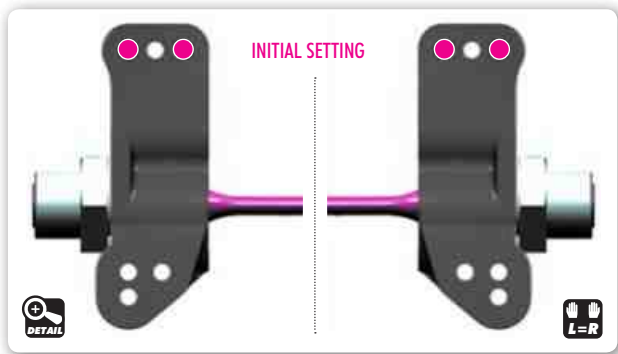

5. FRONT SUSPENSION



#333451
ALU ANTI-ROLL BAR PIVOT BALL 5.8 MM - SWISS 7075 T6 - HARDCOATED (2)

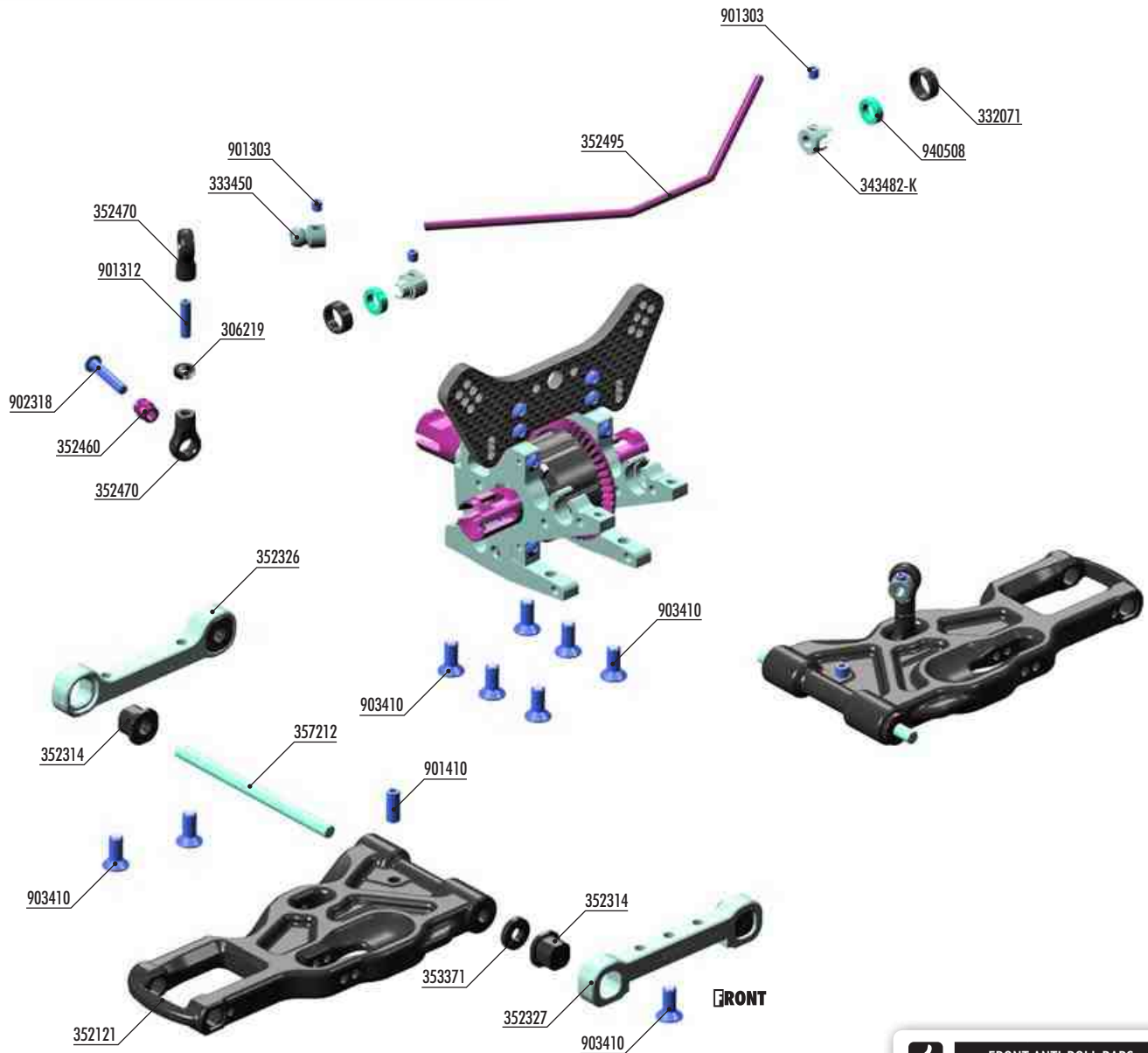

FRONT LOWER SUSP. ARMS		
#352121-S	SOFT	OPTION
#352121	MEDIUM	INCLUDED
#352121-H	HARD	OPTION
#352121-G	GRAPHITE	OPTION

ALU ANTI-ROLL BAR COLLAR		
#343483-K	ø2.2mm	OPTION
#343484-K	ø2.4mm	OPTION
#343482-K	ø2.6mm	INCLUDED
#343485-K	ø2.8mm	OPTION
#343481-K	ø3.0mm	OPTION

FRONT ANTI-ROLL BARS		
#352489	1.8mm	OPTION
#352490	2.0mm	OPTION
#352492	2.2mm	OPTION
#352493	2.3mm	OPTION
#352494	2.4mm	OPTION
#352495	2.5mm	INCLUDED
#352496	2.6mm	OPTION
#352498	2.8mm	OPTION



- 306219 COMPOSITE SET OF SHIMS (4)
- 332071 COMPOSITE BALL-BEARING HUB (4)
- 333450 ANTI-ROLL BAR BALL JOINT 5.8 MM (2)
- 343482-K ALU CUTTED ANTI-ROLL BAR COLLAR ø2.6 - BLACK (2)
- 352121 C-HUB COMPOSITE FRONT LOWER SUSPENSION ARM - MEDIUM
- 352314 COMPOSITE SQUARE ADJ. ROLL CENTER BUSHINGS - V2 (2)
- 352326 ALU FRONT LOWER SUSP. HOLDER - REAR - SQUARE ADJ. ROLL-C.
- 352327 ALU FRONT LOWER SUSP. HOLDER - FRONT - SQUARE ADJ. ROLL-C.
- 352460 PIVOT BALL 5.8 (10)
- 352470 BALL JOINT 5.8 (8)
- 352495 FRONT ANTI-ROLL BAR 2.5MM

- 353371 SET OF COMPOSITE LOWER ARM SHIMS
- 357212 LOWER INNER PIVOT PIN F+R (2)
- 901303 HEX SCREW SB M3x3 (10)
- 901312 HEX SCREW SB M3x12 (10)
- 901410 HEX SCREW SB M4x10 (10)
- 902318 HEX SCREW SH M3x18 (10)
- 903410 HEX SCREW SFH M4x10 (10))
- 940508 BALL-BEARING 5x8x2.5 RUBBER SEALED - OIL (2)

5. FRONT SUSPENSION



353371
SHIM 4x10x2



901410
SB M4x10

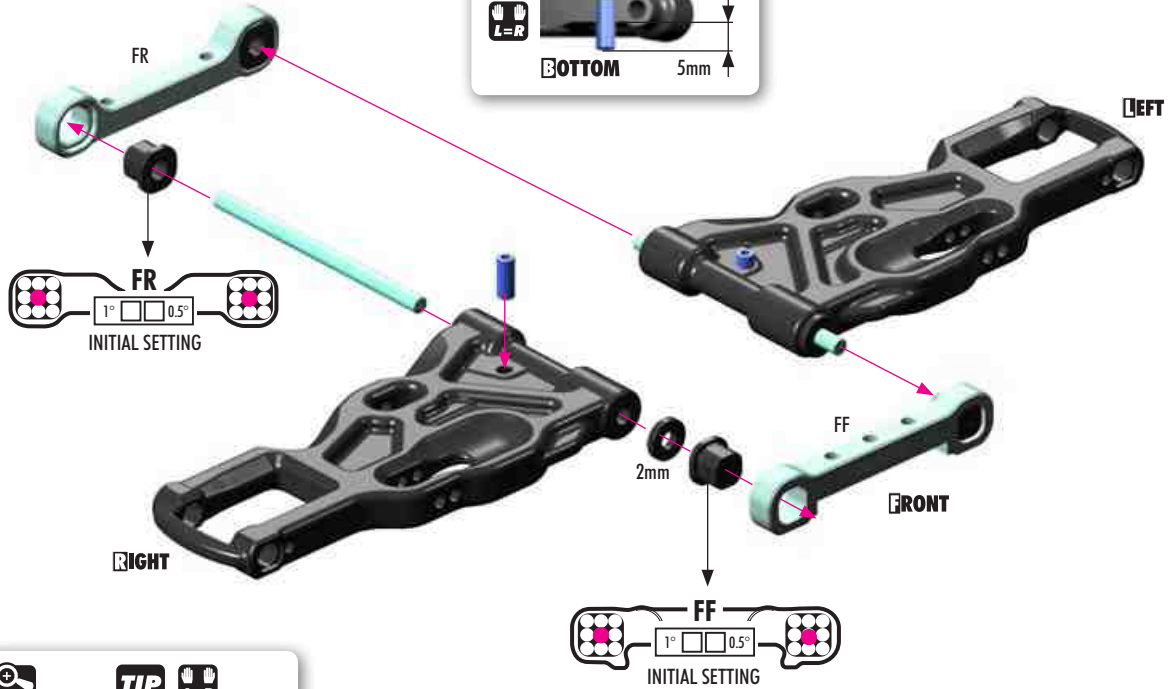
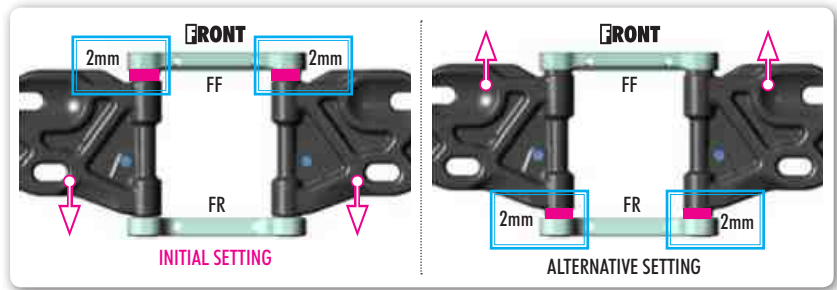

TIP If the suspension arms do not move freely, use a HUDY Arm Reamer to resize the holes.

(HUDY #107634)

OPTION	FRONT LOWER SUSP. ARMS	
#352121-S	SOFT	OPTION
#352121	MEDIUM	INCLUDED
#352121-H	HARD	OPTION
#352121-G	GRAPHITE	OPTION

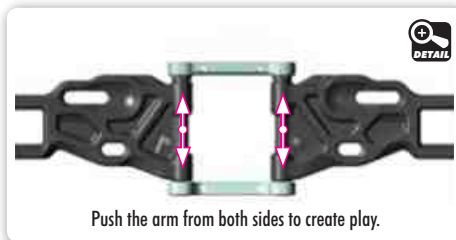
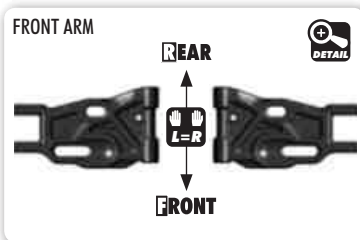

Eccentric bushings have two different offsets from the center.

- Middle position = 0.5 mm or 0.5° from center
- Outer position = 1 mm or 1° from center

TRACK-WIDTH		
FF	FR	(mm)
		= 308
		= 306
		= 310

ROLL CENTER		
FF	FR	(mm)
		= 1
		= 0
		= -1

The XRAY alu front lower suspension holders provide even greater range of adjustment for the front suspension. Using different combinations of eccentric bushings, fine adjustment of front kick-up, roll center, and front track-width can be obtained. For more information about the influence of kick-up, front track-width, and roll centers on car handling, please refer to HUDY Off-Road Set-up Book (#209099).

The tables below describe the amounts of kick-up, front track-width change depending on the combinations of eccentric bushings used with 0 and 1mm, 1° offset. The 0.5mm, 0.5° represents the half change.

SET-UP BOOK
KICK UP
ROLL CENTER DOWNSTOP
WHEELBASE
TRACK WIDTH

5. FRONT SUSPENSION



903410
SFH M4x10

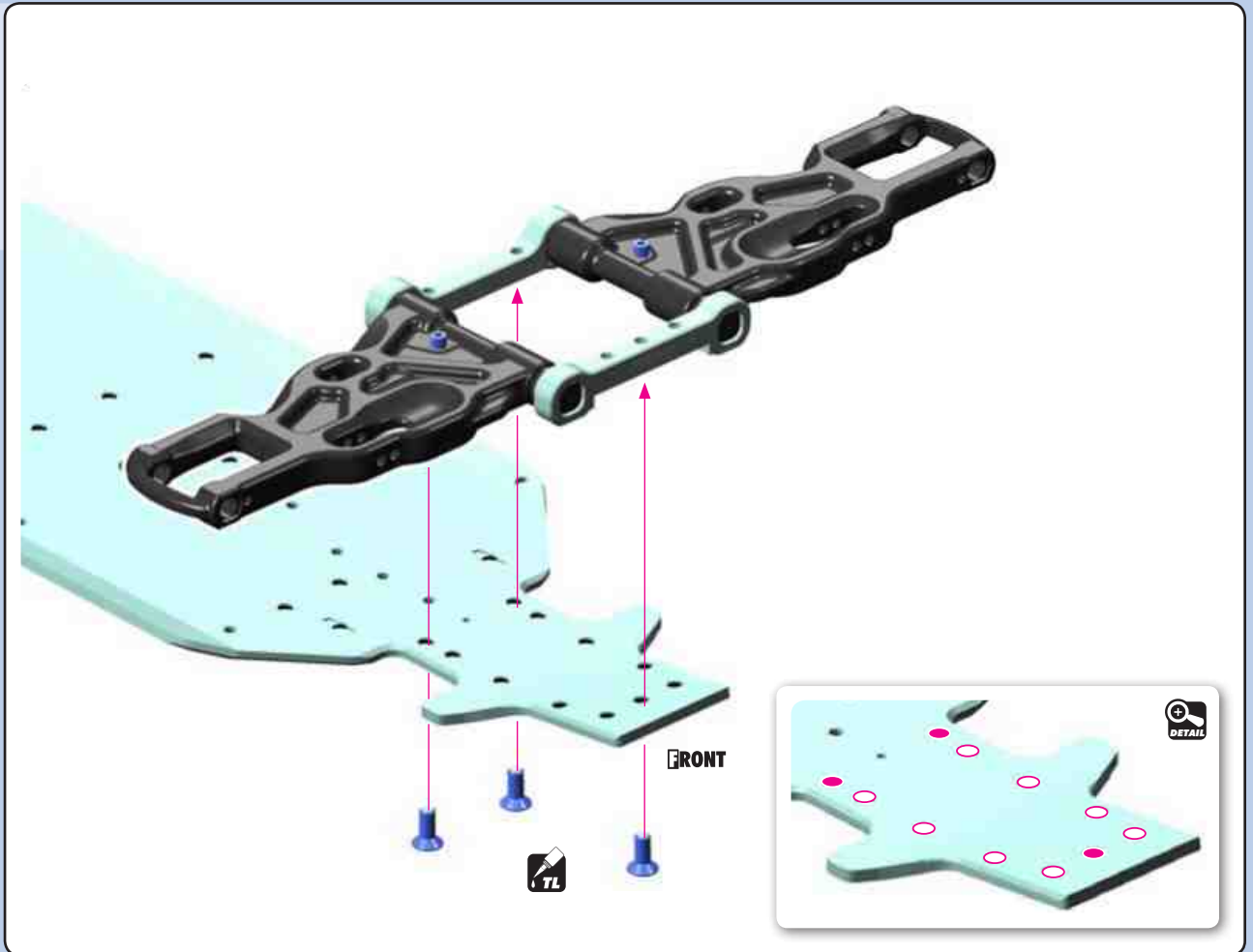

903410
SFH M4x10

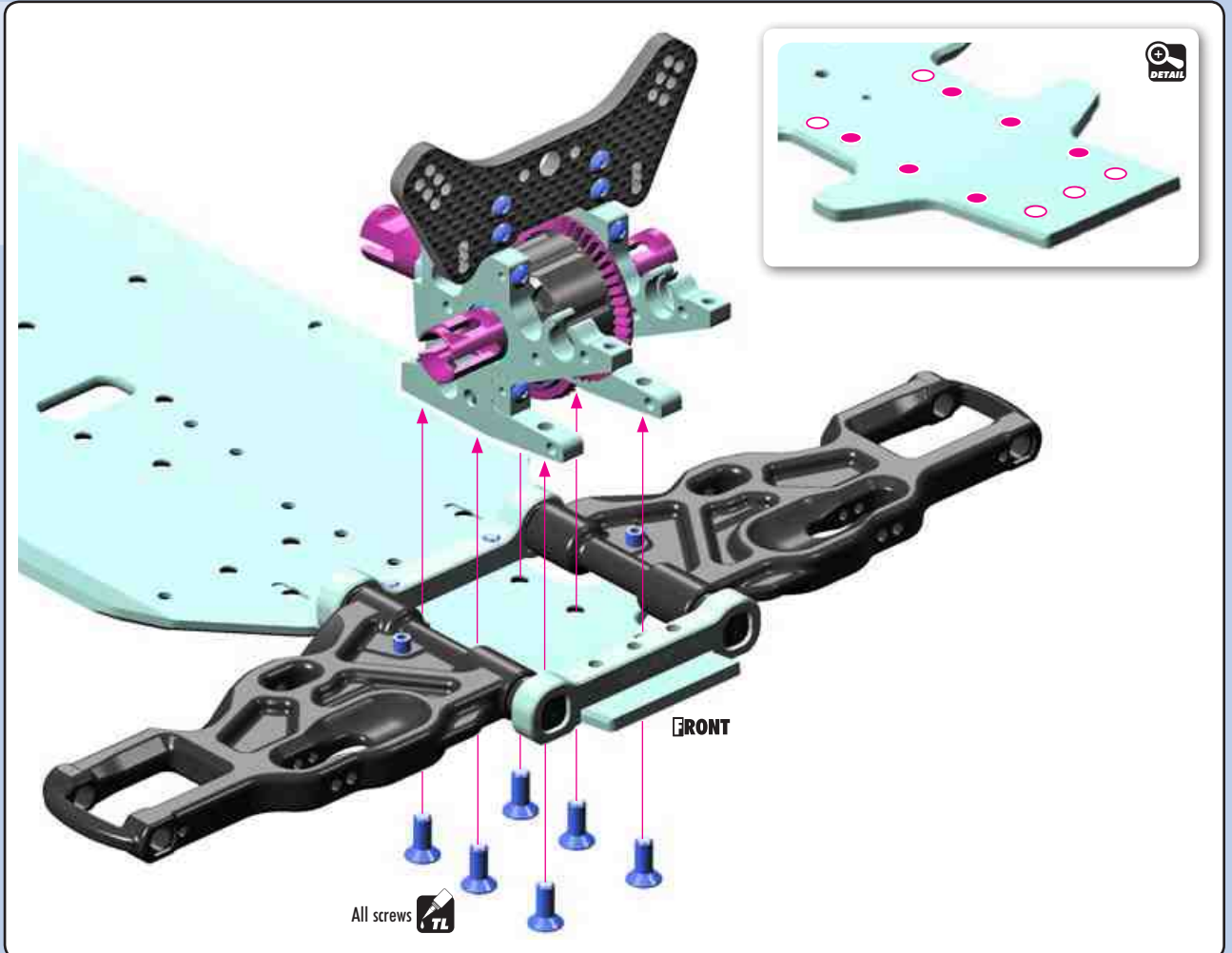

5. FRONT SUSPENSION

IO
306219
SHIM 3x6x2



901312
SB M3x12

2x **L=R**



TIP
Install the pivot balls with Professional Multi Tool (HUDY #183011).

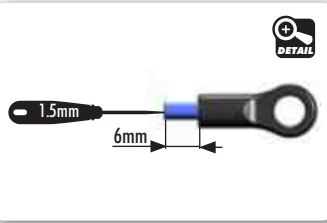

940508
BB 5x8x2.5

FRONT ANTI-ROLL BARS

BEARING OIL
(HUDY #106230)



Cut away excessive material.



OPTION

FRONT ANTI-ROLL BARS

#352489	1.8mm	OPTION
#352490	2.0mm	OPTION
#352492	2.2mm	OPTION
#352493	2.3mm	OPTION
#352494	2.4mm	OPTION
#352495	2.5mm	INCLUDED
#352496	2.6mm	OPTION
#352498	2.8mm	OPTION

901303
SB M3x3



902318
SH M3x18

STEP 4 DETAIL

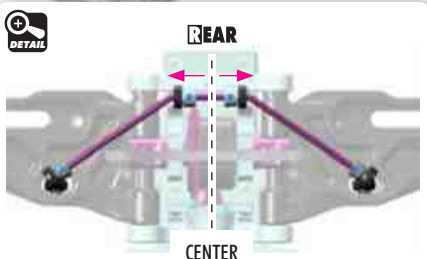
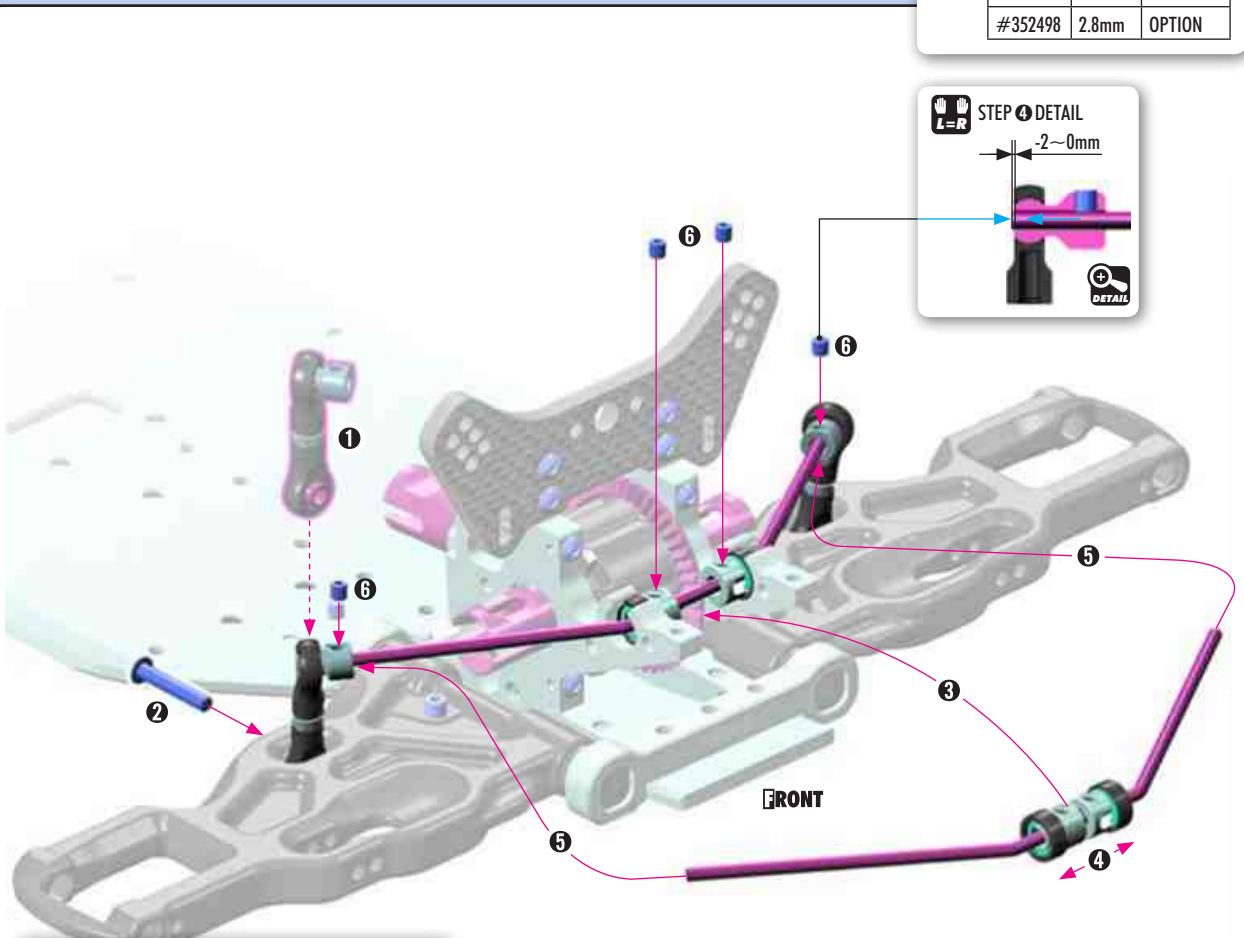
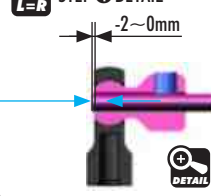

TOP

Set the bar into the center, remove the play in the bushings, and tighten the set-screws fully.



Step 4 check for free movement.

SET-UP BOOK
ANTI-ROLL BAR

6. FRONT SUSPENSION

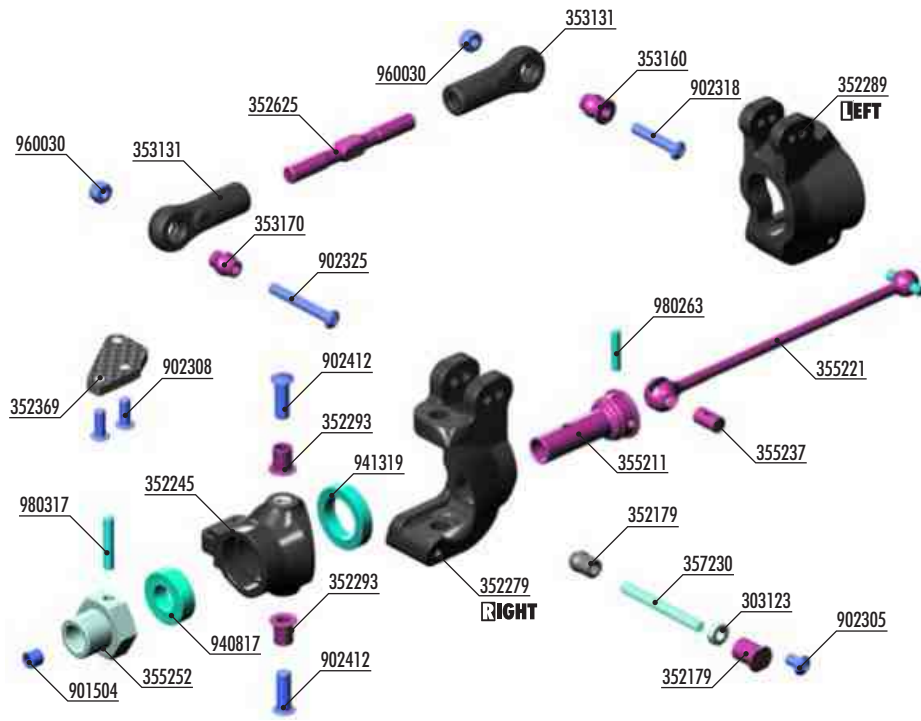

STEERING BLOCK			
OPTION	#352245	COMPOSITE	INCLUDED
	#352254	ALU*	OPTION

CASTER BLOCK - RIGHT				
OPTION	#352273	18° RIGHT	ALU*	OPTION
	#352277	16° RIGHT	COMP.	OPTION
	#352278	6° RIGHT	ALU*	OPTION
	#352279	6° RIGHT	COMP.	INCLUDED

CASTER BLOCK - LEFT				
OPTION	#352283	18° LEFT	ALU*	OPTION
	#352287	16° LEFT	COMP.	OPTION
	#352288	6° LEFT	ALU*	OPTION
	#352289	6° LEFT	COMP.	INCLUDED

*To use alu C-hub and alu steering blocks you need to use also these additional parts:

- *#352655 - Ball Stud 6.8mm with Backstop L=6mm - M4 (2)
- *#352292 - Steel Steering Block Pivot Pin (2)
- *#352294 - Composite Bushing for Alu Caster Block (2)

STEEL BALL MOUNT (2)	
OPTION	#352180

OFFSET WHEEL AXLES			
OPTION	#355250	0mm	OPTION
	#355251	+1mm	OPTION
	#355252	+2mm	INCLUDED

ECCENTRIC BUSHINGS			
OPTION	#352170	0° - STEEL	OPTION
	#352174	1° - STEEL	OPTION
	#352175	2° - STEEL	OPTION
	#352179	0° - COMP.	INCLUDED

BAG

06

- | | | | |
|--------|---|--------|--|
| 303123 | ALU SHIM 3x6x2.0MM (10) | 355252 | ALU WHEEL AXLE OFFSET "+2MM" - HARD COATED (2) |
| 352179 | COMPOSITE BUSHING & BALL MOUNT SET (2+2) | 357230 | FRONT LOWER OUTER PIVOT PIN (2) |
| 352245 | C-HUB STEERING BLOCK LB WITH ALU INSERTS | 901504 | HEX SCREW SB M5x4 (10) |
| 352279 | COMPOSITE C-HUB 6° RIGHT | 902305 | HEX SCREW SH M3x5 (10) |
| 352289 | COMPOSITE C-HUB 6° LEFT | 902308 | HEX SCREW SH M3x8 (10) |
| 352293 | STEEL C-HUB BUSHING (2) | 902318 | HEX SCREW SH M3x18 (10) |
| 352369 | GRAPHITE STEERING PLATE (2) | 902325 | HEX SCREW SH M3x25 (10) |
| 352625 | ADJ. TURNBUCKLE M5 L/R 46 MM - HUDY SPRING STEEL™ (2) | 902412 | HEX SCREW SH M4x12 (10) |
| 353131 | REAR UPPER INNER CAMBER LINK BALL JOINT - V3 (2) | 940817 | BALL-BEARING 8x16x5 RUBBER SEALED - OIL (2) |
| 353160 | MOUNTING BALL 6.8 (4) | 941319 | BALL-BEARING 13x19x4 RUBBER SEALED - OIL (2) |
| 353170 | PIVOT BALL 6.8 (4) | 960030 | NUT M3 (10) |
| 355211 | CVD DRIVE AXLE - HUDY SPRING STEEL™ | 980263 | PIN 2.5x13 (10) |
| 355221 | CVD UNIVERSAL DRIVE SHAFT 94MM - HUDY SPRING STEEL™ | 980317 | PIN 3x17 (10) |
| 355237 | CVD DRIVE SHAFT COUPLING - HUDY SPRING STEEL™ | | |

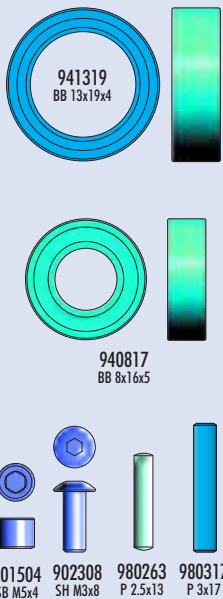

OFFSET WHEEL AXLES			
OPTION	#355250	0mm	OPTION
	#355251	+1mm	OPTION
	#355252	+2mm	INCLUDED

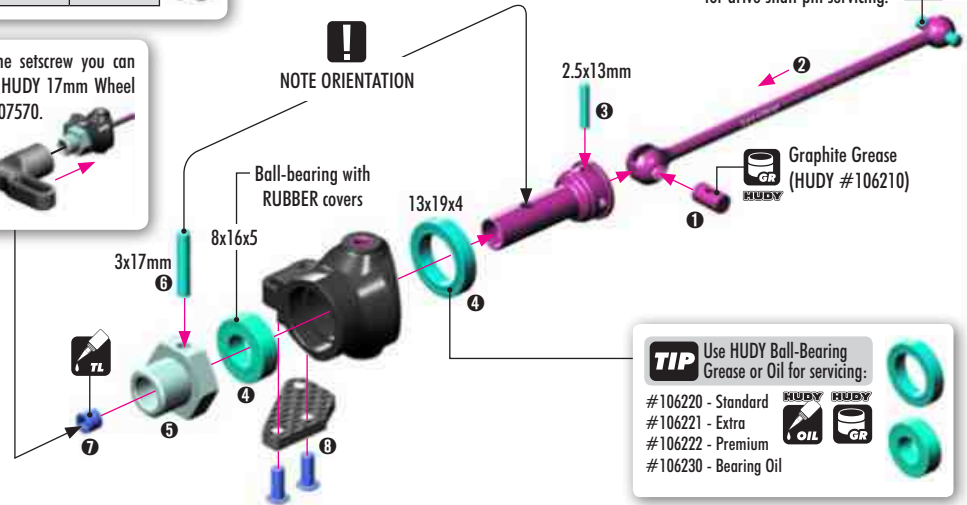

TIP Use HUDY Ball-Bearing Grease or Oil for servicing:	
#106220	Standard
#106221	Extra
#106222	Premium
#106230	Bearing Oil

6. FRONT SUSPENSION



902412
SH M4x12

2x
L=R

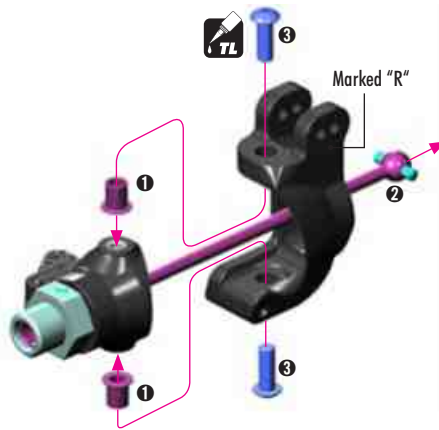

303123
SHIM 3x6x2



902305
SH M3x5

2x
L=R

#352180
OPTION STEEL BALL MOUNT (2)



TIP Press pivot ball into arm until it snaps into place.



ECCENTRIC BUSHINGS			
#352170	0° - STEEL	<input type="radio"/>	OPTION
#352174	1° - STEEL	<input type="radio"/>	OPTION
#352175	2° - STEEL	<input type="radio"/>	OPTION
#352179	0° - COMP.	<input type="radio"/>	INCLUDED

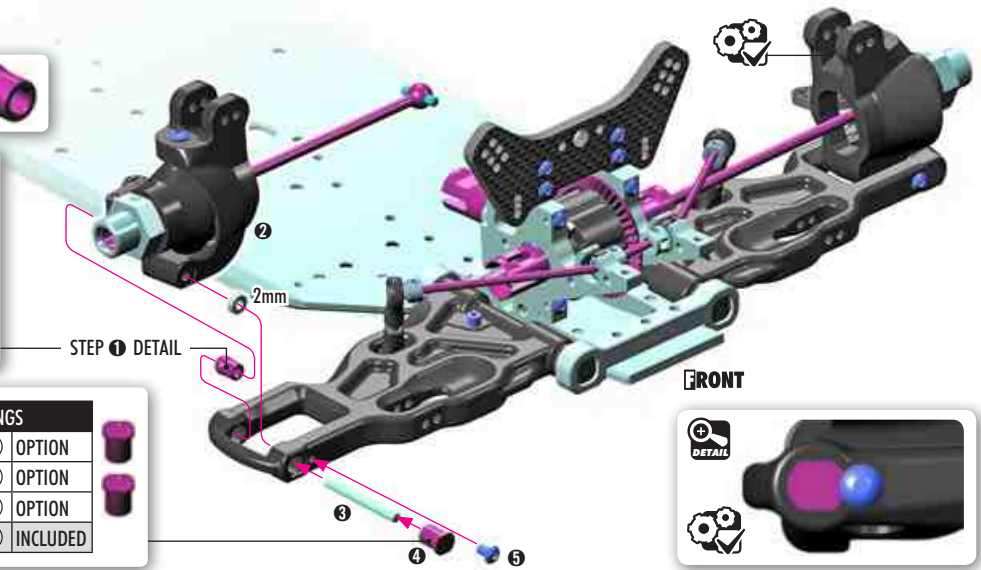

2x
L=R

TIP Install the pivot balls with Professional Multi Tool (HUDY #183011).

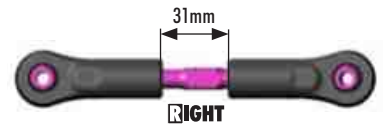
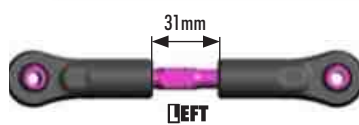
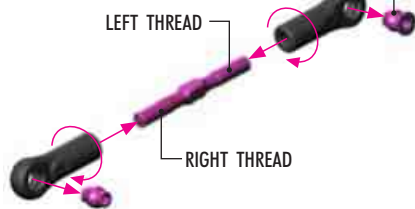

960030
N M3

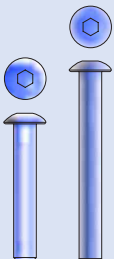

902318 SH M3x18 902325 SH M3x25

2x
L=R

NOTE
ORIENTATION

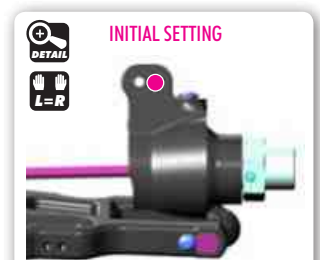
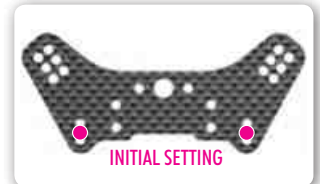
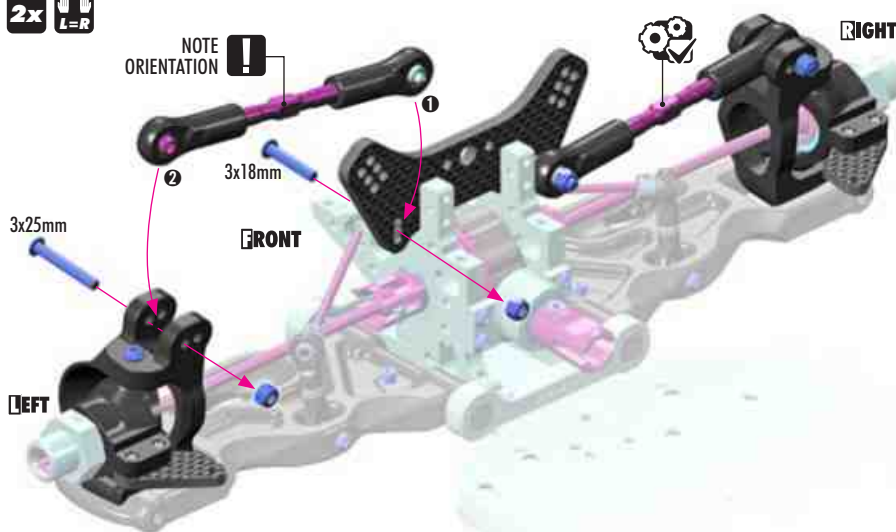

SET-UP BOOK

ROLL CENTER

7. STEERING

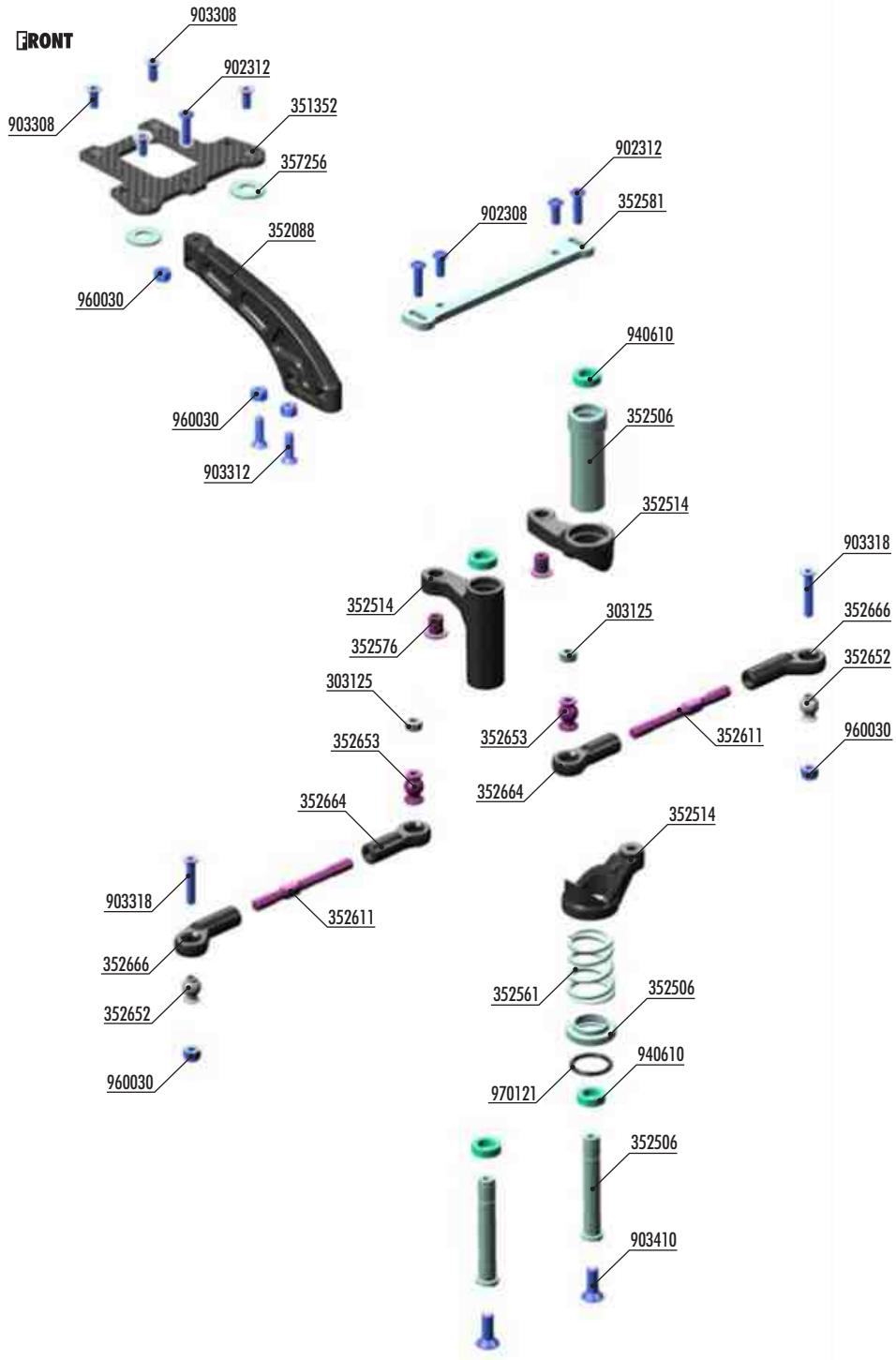

BAG

07

303125	ALU SHIM 3x6x3.0MM (10)	902308	HEX SCREW SH M3x8 (10)
351352	GRAPHITE UPPER PLATE 2.5MM	902312	HEX SCREW SH M3x12 (10)
352088	COMPOSITE FRONT BRACE	903308	HEX SCREW SFH M3x8 (10)
352506	SERVO SAVER WITH CHASSIS LOCK & HARD SPRING - G - SET	903312	HEX SCREW SFH M3x12 (10)
352514	COMPOSITE SERVO SAVER - GRAPHITE	903318	HEX SCREW SFH M3x18 (10)
352561	SERVO SAVER SPRING PROGRESSIVE	903410	HEX SCREW SFH M4x10 (10)
352576	STEERING PLATE BUSHING (2)	940610	BALL-BEARING 6x10x3 RUBBER SEALED - OIL (2)
352581	ALU STEERING PLATE - SWISS 7075 T6	960030	NUT M3 (10)
352611	ADJ. TURNBUCKLE M4 L/R 53MM - HUDY SPRING STEEL™ (2)	970121	O-RING 12.1 x 1.6 (10)
352652	BALL STUD 6.8MM (4)		
352653	BALL STUD 6.8MM WITH BACKSTOP - M3 (2)		
352664	COMPOSITE STEERING BALL JOINT 6.8MM - V3 (2)		
352666	COMPOSITE RELIEF STEERING BALL JOINT 6.8MM (2)		
357256	ALU SHIM 6x13x1MM (2)		

7. STEERING



970121
O 12.1x1.6

SET-UP BOOK
SERVO SAVER

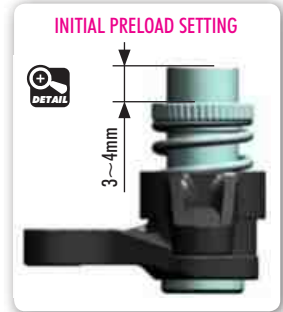
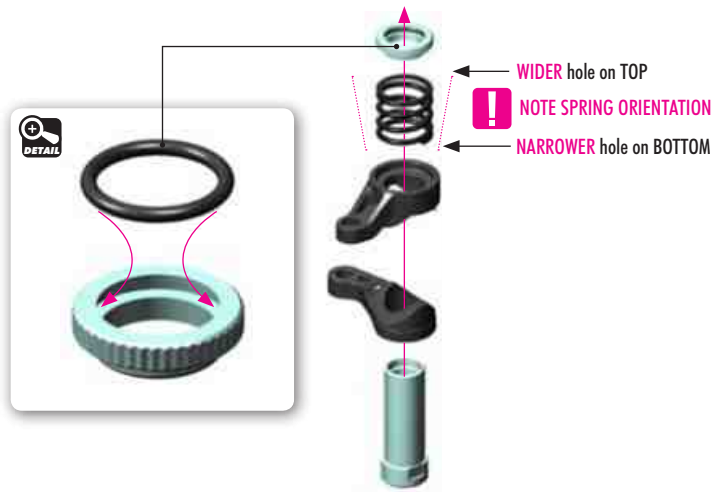

902308
SH M3x8



903410
SFH M4x10



940610
BB 6x10x3

For servicing use
Bearing Oil (HUDY #106230).

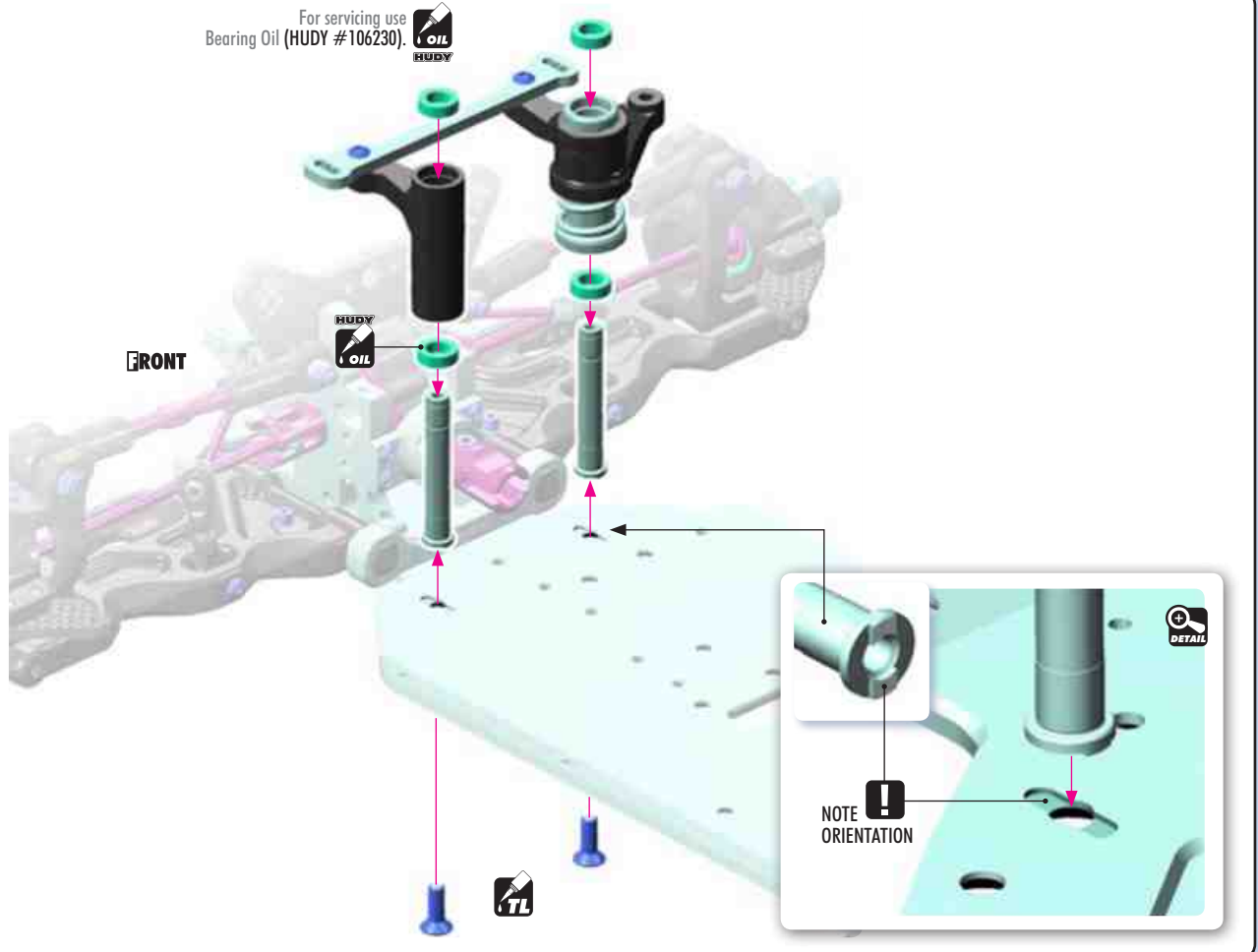

7. STEERING

-  357256 SHIM 6x13x1
-  902312 SH M3x12
-  903308 SFH M3x8
-  903312 SFH M3x12
-  960030 N M3

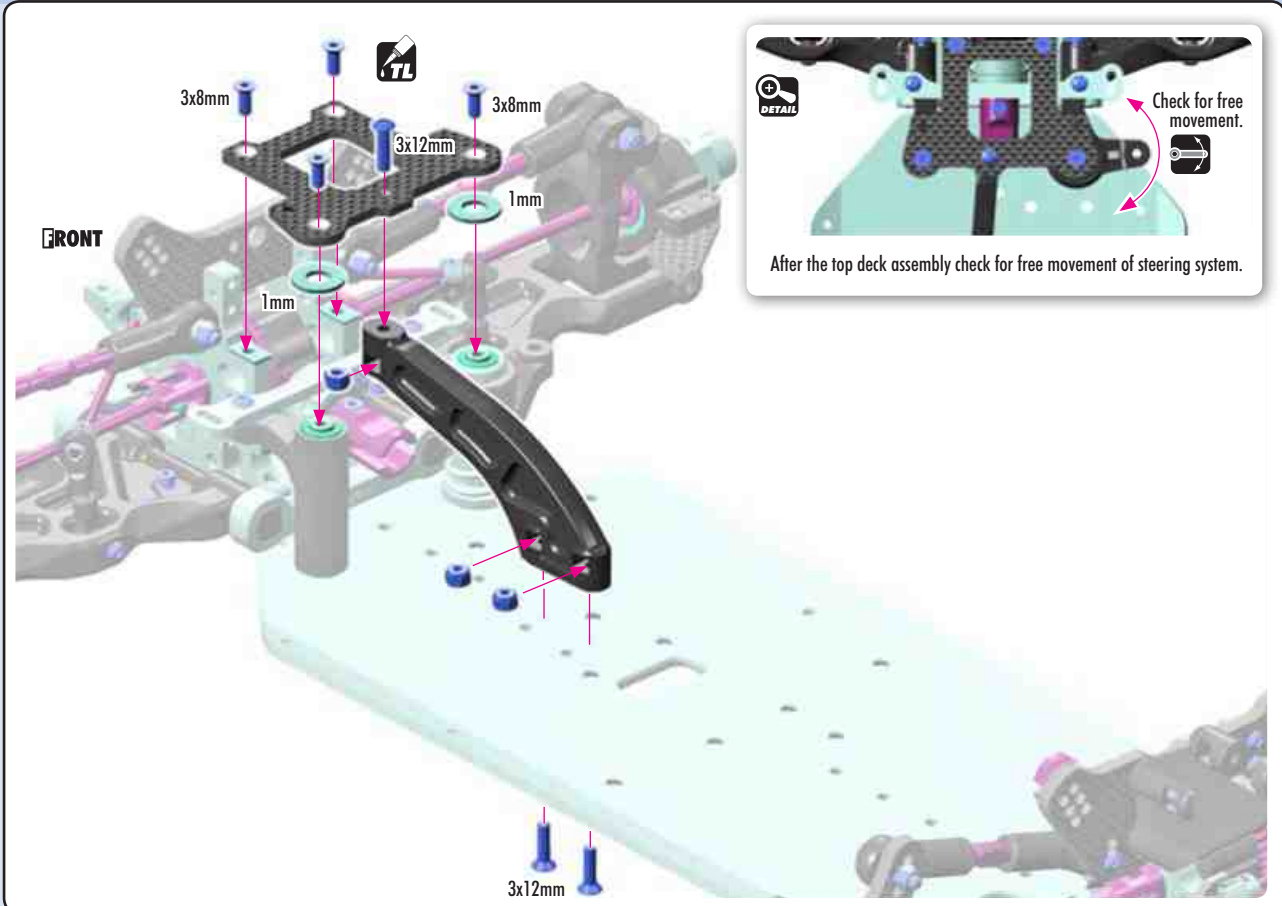

-  

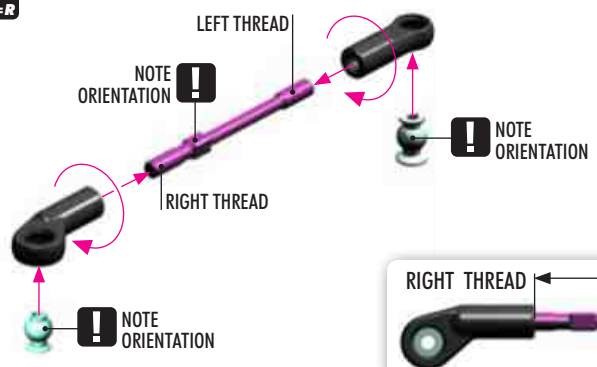





TIP Use tools to tighten as shown.

Special Tool (HUDY #181090)
Turnbuckle Wrench 4mm (HUDY #181040)

Install the pivot balls with Professional Multi Tool (HUDY #183011).



-  303125 SHIM 3x6x3
-  902312 SH M3x12
-  903318 SFH M3x18
-  960030 N M3

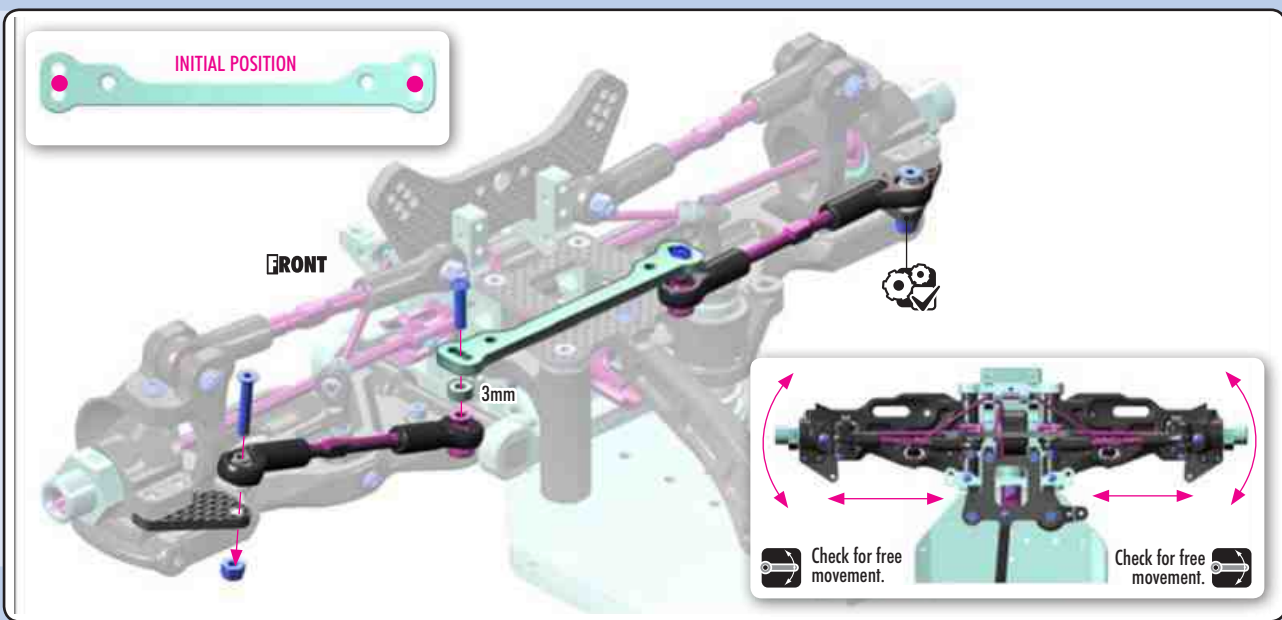

8. CENTER SOLID SHAFT & MOTOR

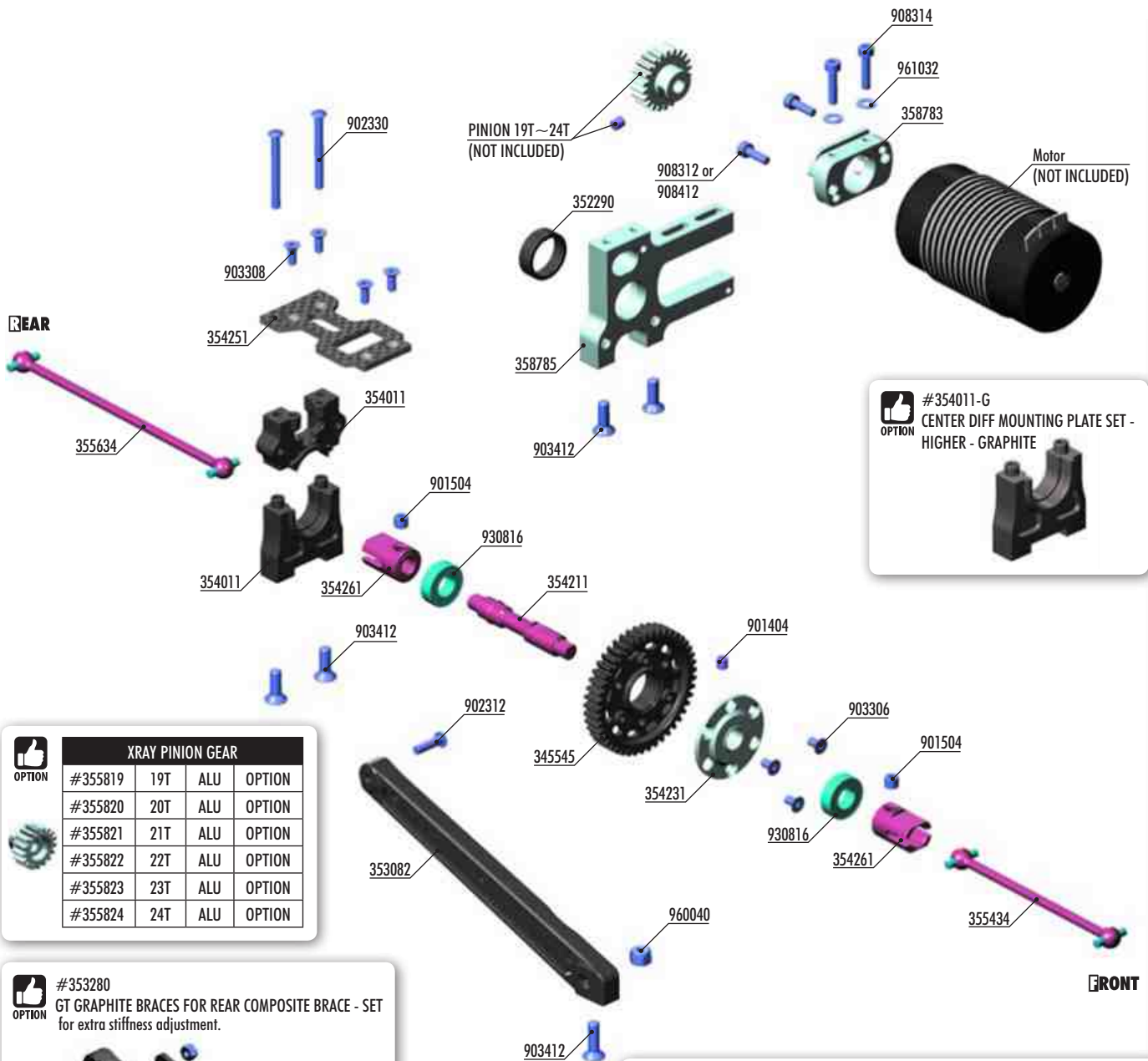

OPTION

XRAY PINION GEAR			
#355819	19T	ALU	OPTION
#355820	20T	ALU	OPTION
#355821	21T	ALU	OPTION
#355822	22T	ALU	OPTION
#355823	23T	ALU	OPTION
#355824	24T	ALU	OPTION

OPTION #353280
GT GRAPHITE BRACES FOR REAR COMPOSITE BRACE - SET for extra stiffness adjustment.

960030
353280
902312

OPTION

COMPOSITE 2-SPEED GEARS				GRAPHITE 2-SPEED GEARS			
#345545	45T	2ND	INCLUDED	#345645	45T	2ND	OPTION
#345546	46T	2ND	OPTION	#345646	46T	2ND	OPTION
#345547	47T	2ND	OPTION	#345647	47T	2ND	OPTION
#345548*	48T	1ST	OPTION	#345648*	48T	1ST	OPTION
#345549*	49T	1ST	OPTION	#345649*	49T	1ST	OPTION
#345550*	50T	1ST	OPTION	#345650*	50T	1ST	OPTION

*these spur gears can be used just with #354230 collar



345545	COMPOSITE 2-SPEED GEAR 45T (2nd)	901404	HEX SCREW SB M4x4 (10)
352290	COMPOSITE BUSHING FOR ALU STEERING BLOCK (4)	901504	HEX SCREW SB M5x4 (10)
353082	COMPOSITE REAR BRACE - MEDIUM - M	902312	HEX SCREW SH M3x12 (10)
354011	CENTER DIFF MOUNTING PLATE - SET	902330	HEX SCREW SH M3x30 (10)
354211	GTE SOLID SHAFT - HUDY SPRING STEEL™	903306	HEX SCREW SFH M3x6 (10)
354231	ALU CENTER SPUR GEAR COLLAR - 7075 T6	903308	HEX SCREW SFH M3x8 (10)
354251	GRAPHITE CENTER UPPER PLATE	903412	HEX SCREW SFH M4x12 (10)
354261	CENTRAL TRANSMISSION OUTDRIVE ADAPTER - HUDY SPRING STEEL™ (2)	908312	HEX SCREW SOCKET HEAD CAP M3x12 (10)
355434	FRONT CENTRAL DOGBONE DRIVE SHAFT 80MM - HUDY SPRING STEEL™	908314	HEX SCREW SOCKET HEAD CAP M3x14 (10)
355634	REAR CENTRAL DOGBONE DRIVE SHAFT 105MM - HUDY SPRING STEEL™	908412	HEX SCREW SOCKET HEAD CAP M4x12 (10)
358783	ALU MOTOR MOUNT PLATE	930816	BALL-BEARING 8x16x5 STEEL SEALED - GREASE (2)
358785	ALU MOTOR MOUNT	960040	NUT M4 (10)
		961032	WASHER S 3.2 (10)

8. CENTER SOLID SHAFT & MOTOR



901404
SB M4x4

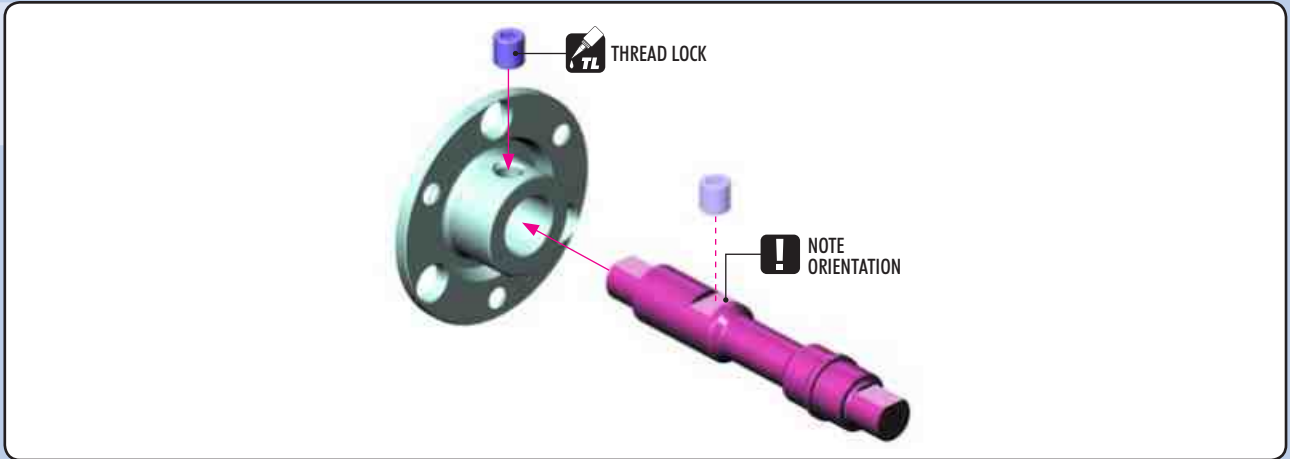

903306
SFH M3x6



901504
SB M5x4

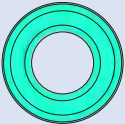

930816
BB 8x16x5

TIP Use HUDY Ball-Bearing Grease or Oil for servicing:

- #106220 - Standard
- #106221 - Extra
- #106222 - Premium
- #106230 - Bearing Oil

NOTE ORIENTATION

CUTAWAY VIEW

Ball-bearing with STEEL covers

NOTE ORIENTATION

	COMPOSITE 2-SPEED GEARS				GRAPHITE 2-SPEED GEARS			
	#345545	45T	2ND	INCLUDED	#345645	45T	2ND	OPTION
	#345546	46T	2ND	OPTION	#345646	46T	2ND	OPTION
	#345547	47T	2ND	OPTION	#345647	47T	2ND	OPTION
	#345548*	48T	1ST	OPTION	#345648*	48T	1ST	OPTION
	#345549*	49T	1ST	OPTION	#345649*	49T	1ST	OPTION
	#345550*	50T	1ST	OPTION	#345650*	50T	1ST	OPTION

*these spur gears can be used just with #354230 collar

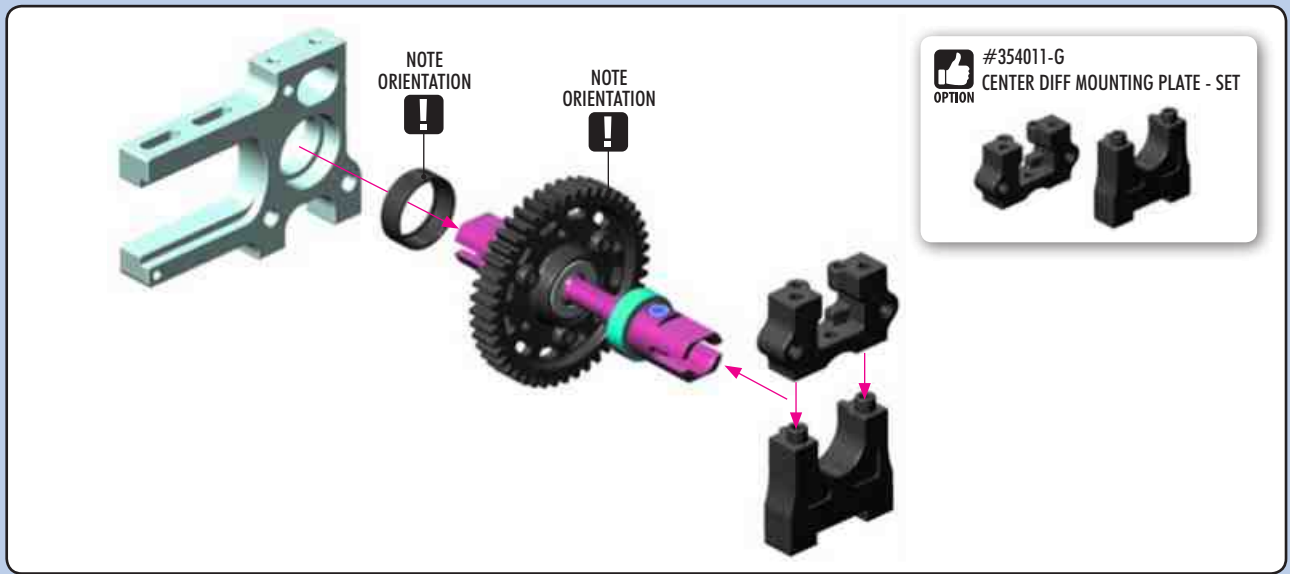

8. CENTER SOLID SHAFT & MOTOR



902330
SH M3x30



903308
SFH M3x8

ALL SCREWS TIGHTEN GENTLY

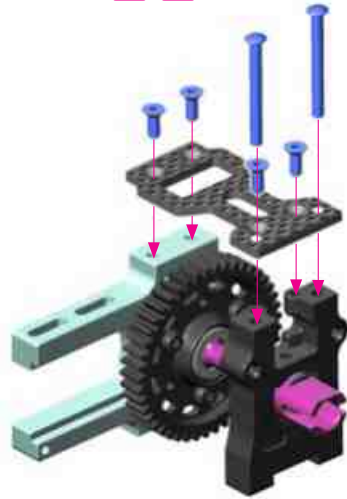

902312
SH M3x12



903412
SFH M4x12



960040
N M4

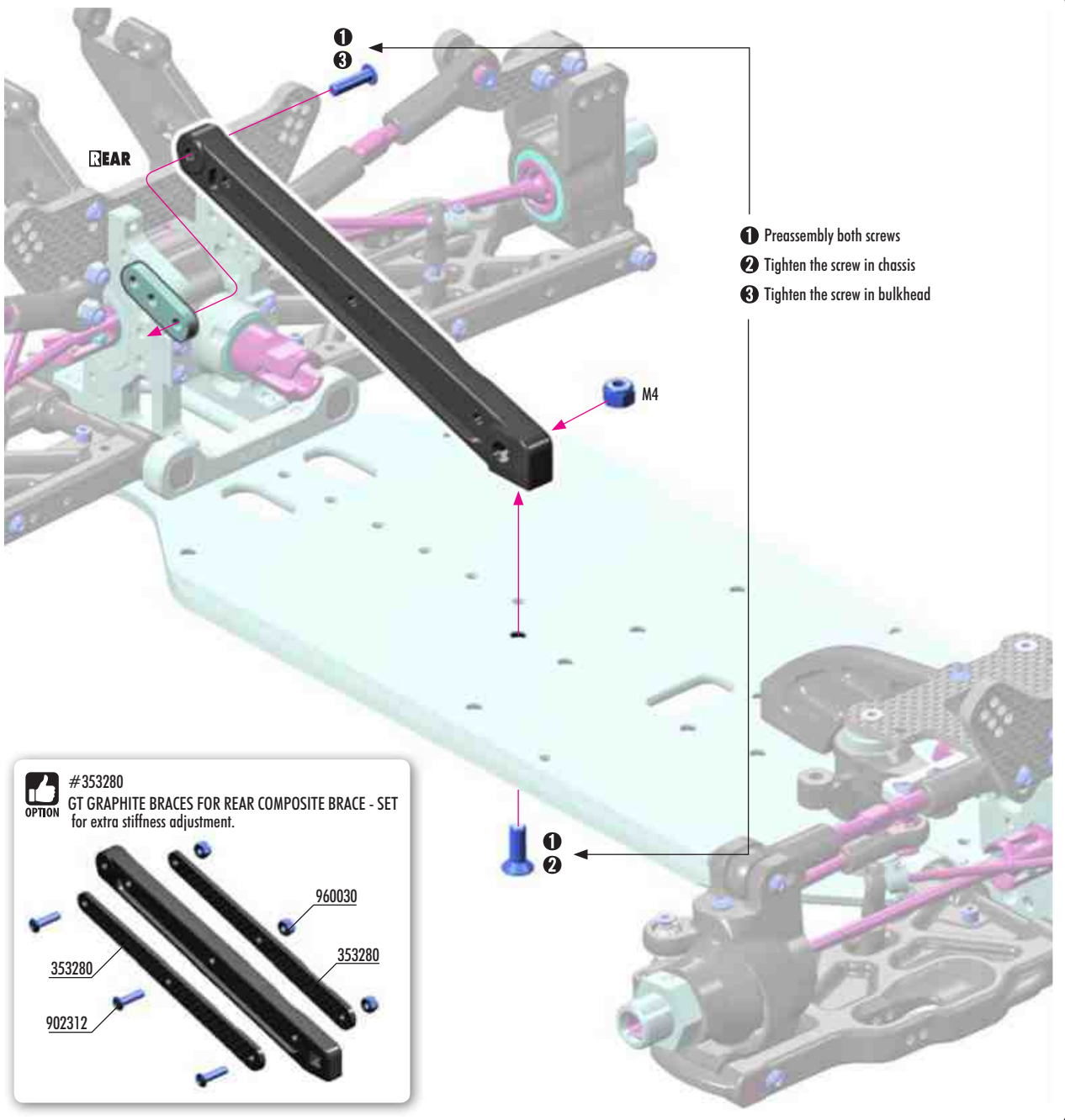

REAR

- 1 Preassembly both screws
- 2 Tighten the screw in chassis
- 3 Tighten the screw in bulkhead



#353280
GT GRAPHITE BRACES FOR REAR COMPOSITE BRACE - SET
for extra stiffness adjustment.

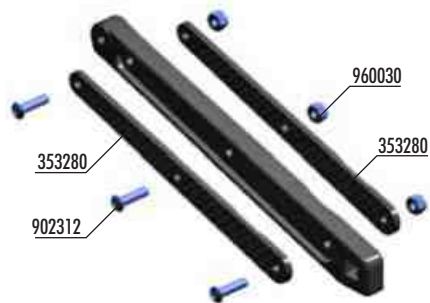

8. CENTER SOLID SHAFT & MOTOR



903412
SFH M4x12

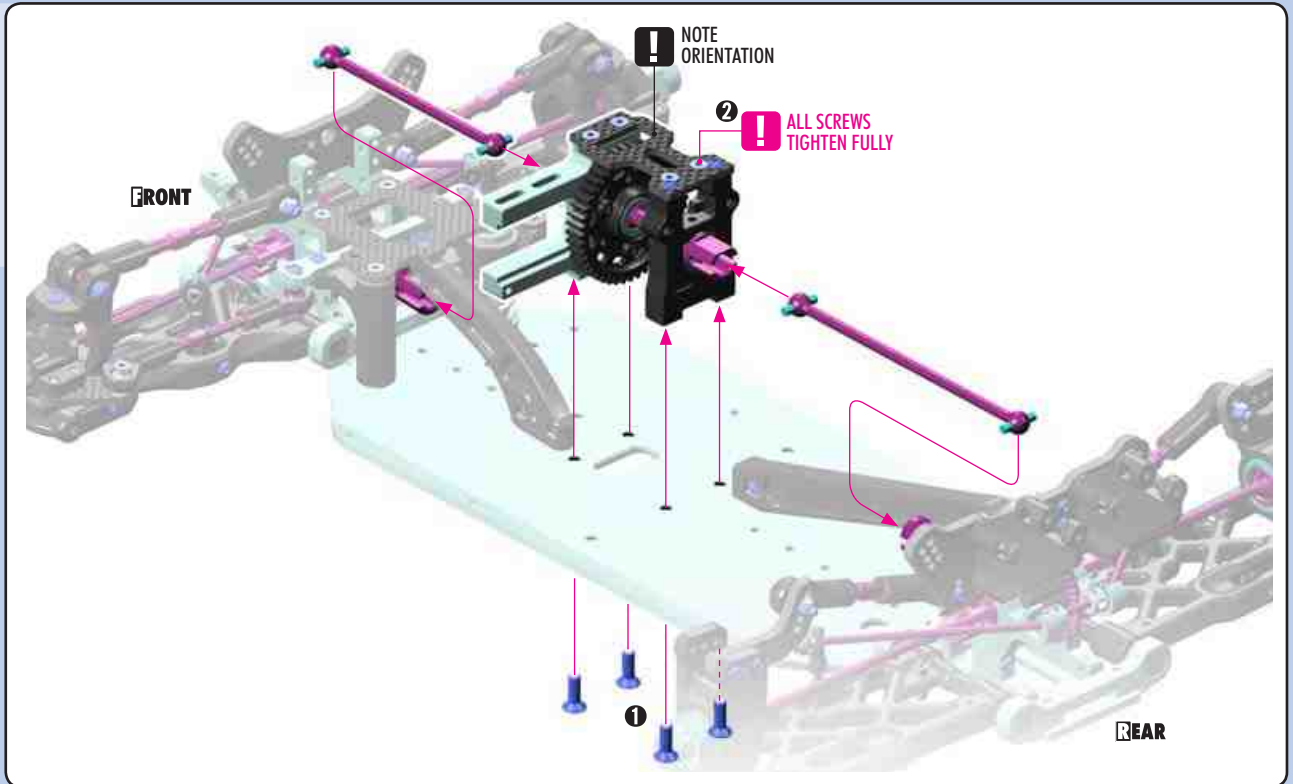

908312
SCH M3x12

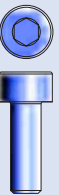

908412
SCH M4x12

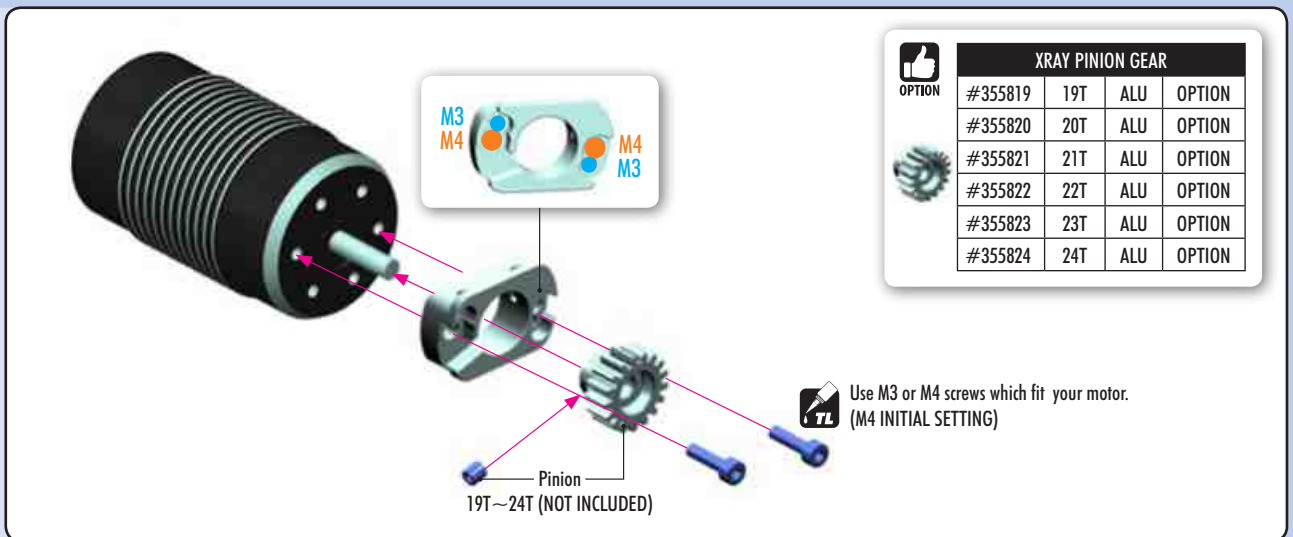

908314
SCH M3x14



961032
S3.2

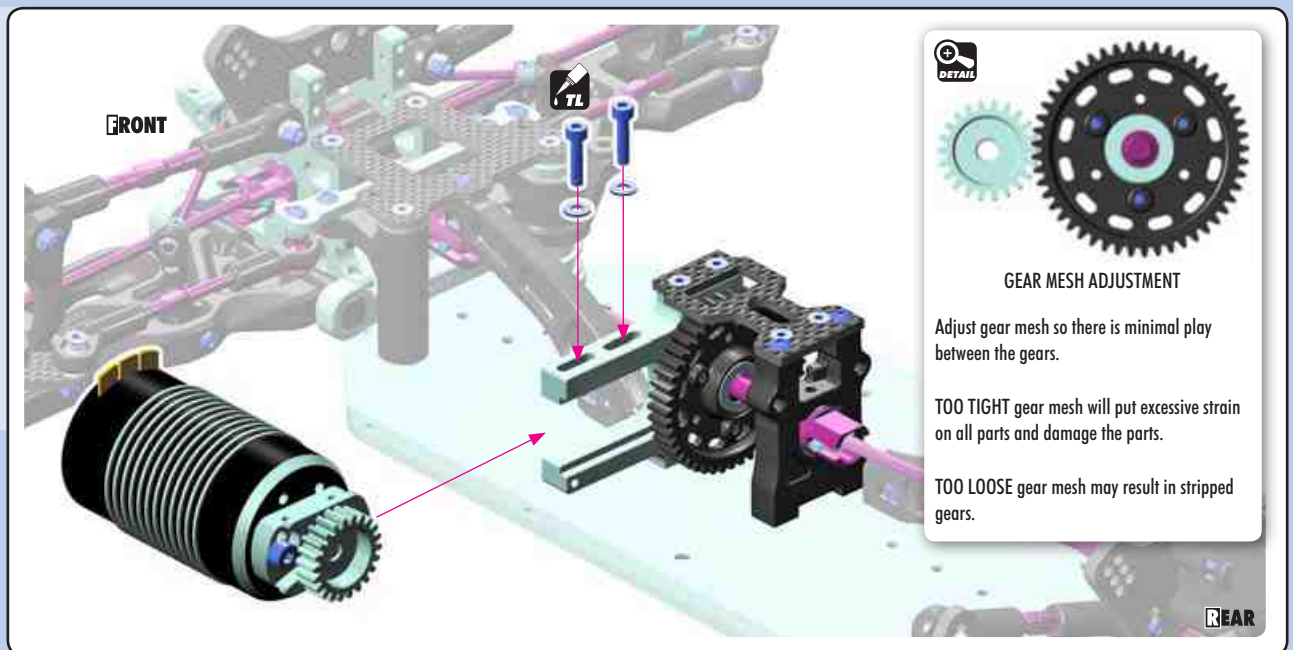

10. ELECTRONICS

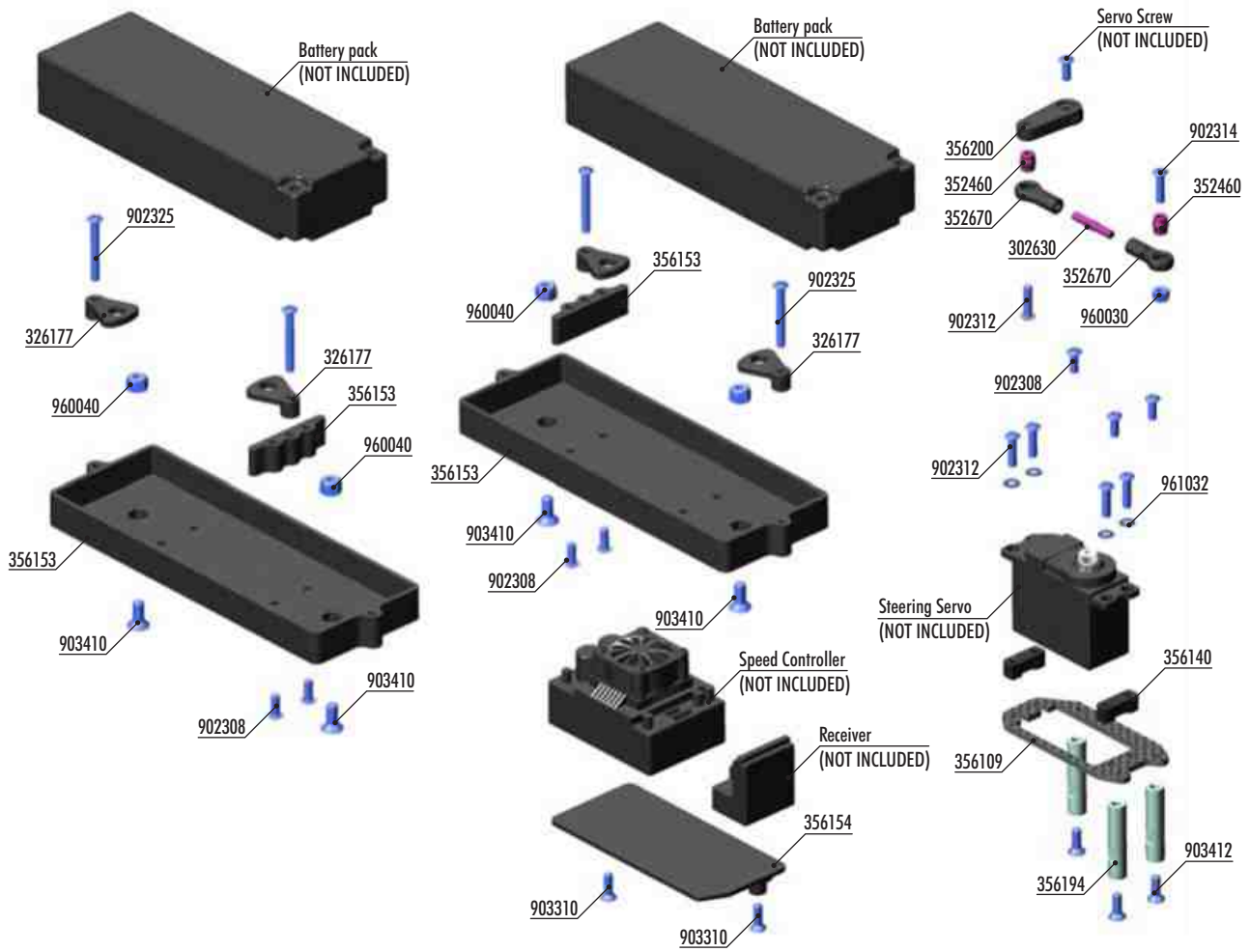

BAG

10

- 302630 ADJ. TURNBUCKLE L/R 20MM - HUDY SPRING STEEL™ (2)
- 326177 COMPOSITE BATTERY CLAMP (2)
- 352460 PIVOT BALL 5.8 (10)
- 352670 SERVO BALL JOINT 5.8MM (4)
- 356109 XB8E/GTXE/XT8E SADDLE PACK GRAPHITE SERVO HOLDER
- 356140 COMPOSITE SERVO MOUNT - SMALL (2)
- 356153 XB8E/GTXE/XT8E BATTERY BOX FOR STANDARD & SHORT BATTERY PACK (2)
- 356154 COMPOSITE SPEEDO PLATE
- 356194 ALU MOUNT FOR RECEIVER BOX
- 356200 BRAKE/THROTTLE ARMS & STEERING SERVO ARMS - SET

- 902308 HEX SCREW SH M3x8 (10)
- 902312 HEX SCREW SH M3x12 (10)
- 902314 HEX SCREW SH M3x14 (10)
- 902325 HEX SCREW SH M3x25 (10)
- 903310 HEX SCREW SFH M3x10 (10)
- 903410 HEX SCREW SFH M4x10 (10)
- 903412 HEX SCREW SFH M4x12 (10)
- 960030 NUT M3 (10)
- 960040 NUT M4 (10)
- 961032 WASHER S 3.2 (10)



902312
SH M3x12

TIP Install the pivot balls with Professional Multi-Tool (HUDY #183011).

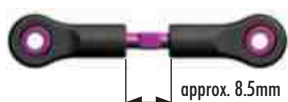

The length of the linkages varies according to the type of servo.

Use appropriate servo arm:
K - (23T) H - (24T) F - (25T)



! NOTE ORIENTATION



ALU SERVO HORNS		
#293501	23T	OPTION
#293502	24T	OPTION
#293503	25T	OPTION



CLAMP ALU SERVO HORNS		
#293407	23T	OPTION
#293408	24T	OPTION
#293409	25T	OPTION





903310
SFH M3x10

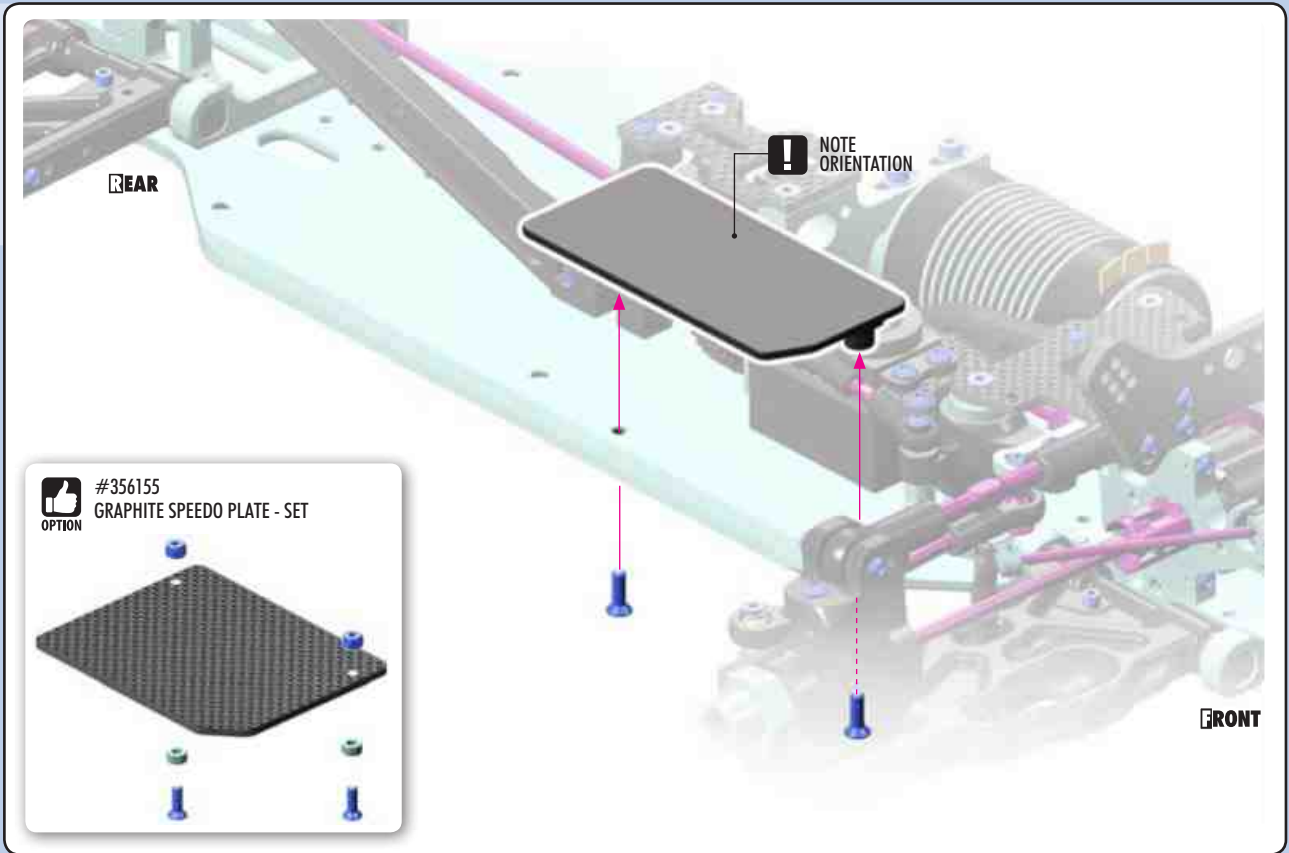

#356155
GRAPHITE SPEEDO PLATE - SET

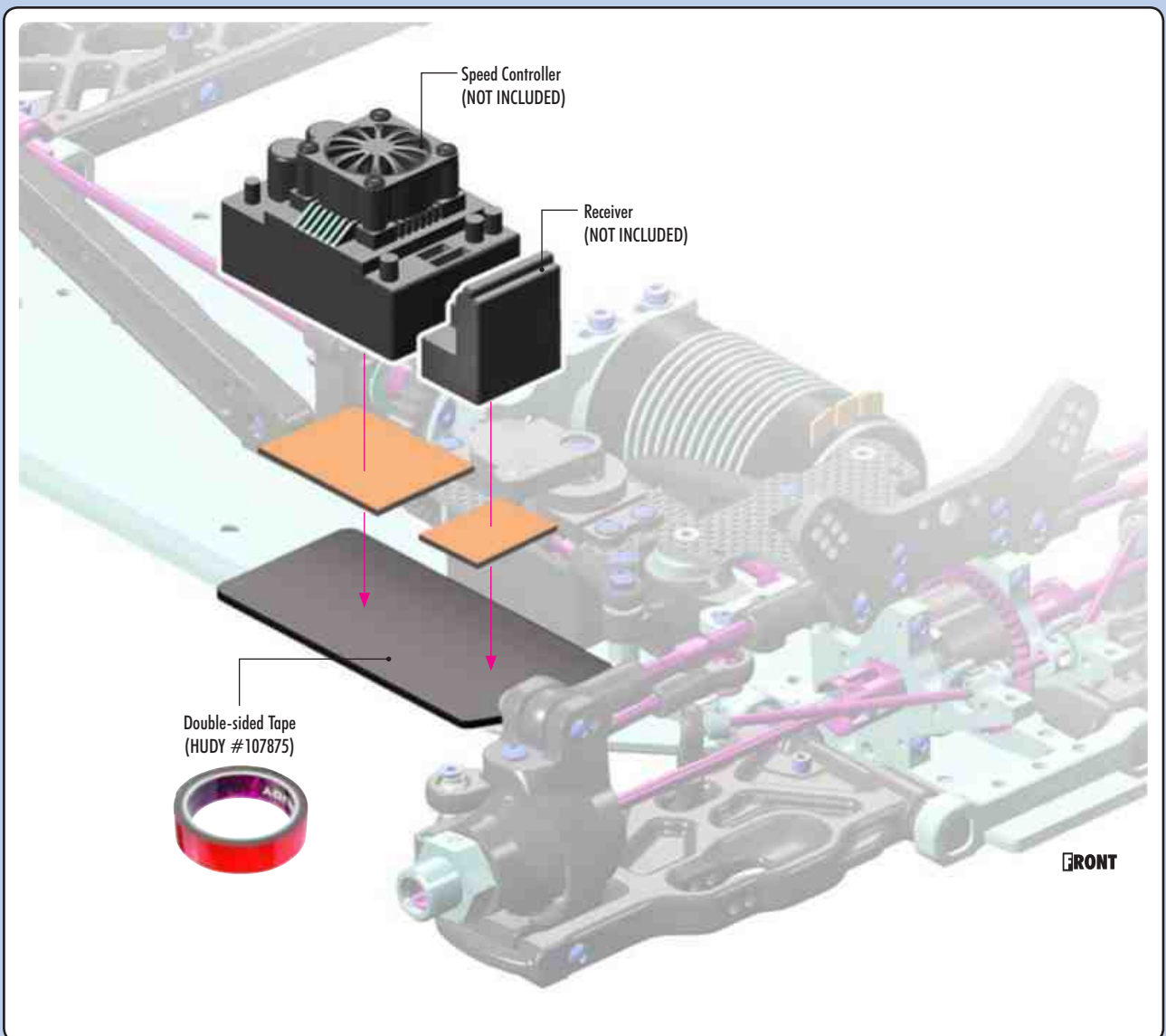
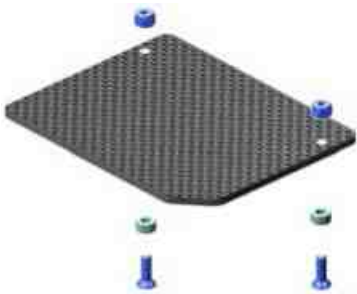

10. ELECTRONICS



902325
SH M3x25



903410
SFH M4x10



960040
N M4



902308
SH M3x8

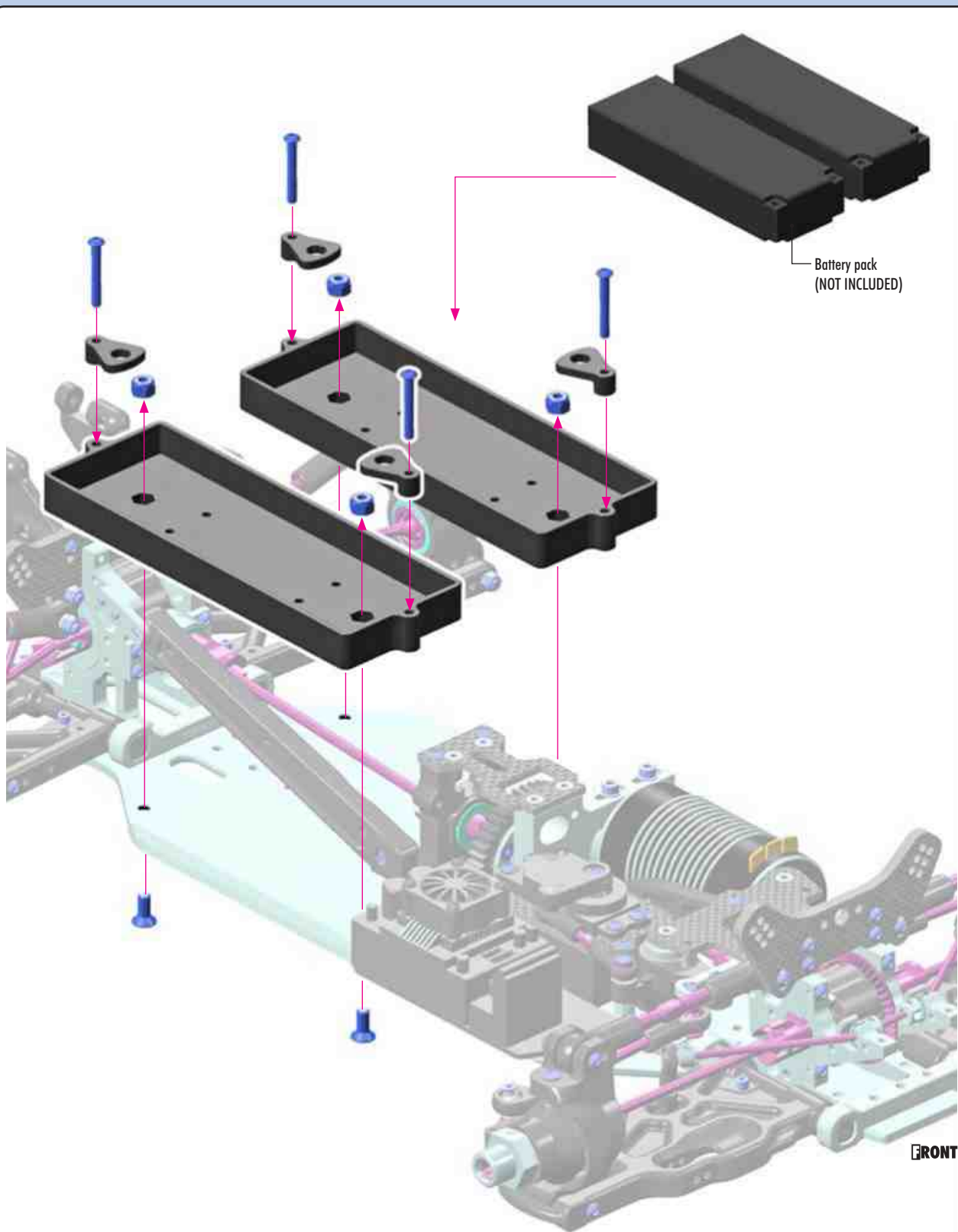

To ensure correct functioning of the battery holder, do not overtighten the screw; the holder must be able to move.



ORIENTATION FOR
LOW BATTERY
PACK



ORIENTATION FOR
STANDARD BATTERY
PACK

HEIGHT ADJUSTMENT
1 turn = 0.5mm



11. SHOCK ABSORBERS

PISTONS

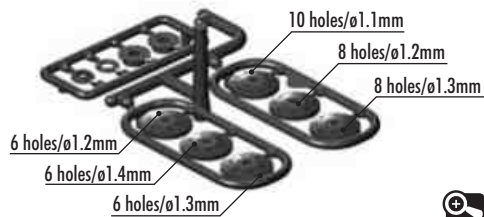

#358196
XRAY GT SPRING SET C=6.0, 3 DOTS (2)

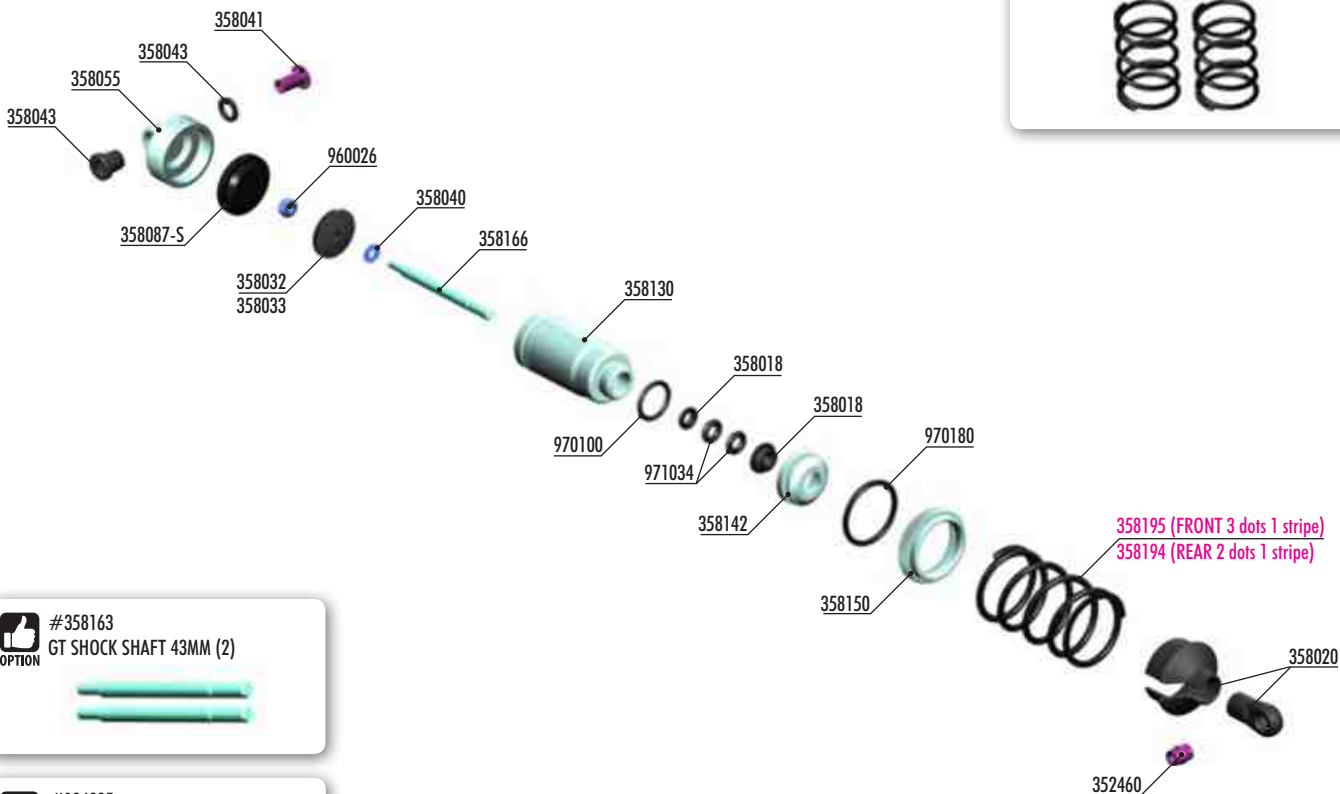

#358163
GT SHOCK SHAFT 43MM (2)



#104005
HUDY AIR VAC - VACUUM PUMP
- 1/8 OFF-ROAD



SHOCK RUBBER MEMBRANE (4)

#358084-S	BRIBBED	SOFT	OPTION	
#358087-S	CELL	SOFT	INCLUDED	
#358087-M	CELL	MEDIUM	OPTION	



#358027 PISTON 5-HOLE (1.5mm) & 2-HOLE (1.0mm) (4)
#358028 PISTON 6-HOLE (1.3mm) & 2-HOLE (1.1mm) (4)
#308029 PISTON 6-HOLE (1.4mm) & 2-HOLE (1.1mm) (4)
#358030 PISTON 8-HOLE (1.2mm) & 2-HOLE (1.2mm) (4)
#358031 PISTON 8-HOLE (1.3mm) & 2-HOLE (1.2mm) (4)



#358054-K
ALU SHOCK CAP NUT WITH VENT
HOLE - BLACK COATED (2)



BAG



352460 PIVOT BALL 5.8 - V3 (10)
358018 COMPOSITE SET OF SHIMS FOR SHOCKS - (2)
358020 COMPOSITE SHOCK PARTS
358032 SHOCK PISTON SET 8-HOLE (1.2; 1.3) 10-H. (1.1MM) - DELRIN - V2
358033 COMPOSITE SHOCK 6-HOLE PISTON SET (1.2; 1.3; 1.4MM) - DELRIN - V2
358040 HARDENED SHOCK SHIMS (4)
358041 STEEL SHOCK BUSHING (2)
358043 COMPOSITE SHOCK BUSHING & SHIM (2+2)
358055 ALU SHOCK CAP NUT - BLACK COATED (2)
358087-S SHOCK RUBBER MEMBRANE CELL - SOFT (4)
358130 GT ALU SHOCK BODY - V2 (2)
358142 ALU SHOCK BODY NUT FOR SHOCK BOOT (2)

358150 ALU SHOCK BODY ADJ. NUT (2)
358166 GT SHOCK SHAFT 46MM (2)
960026 NUT M2.5 - SHORT (10)
970100 O-RING 10 x 1.5 (10)
970180 O-RING 18 x 1.8 (10)
971034 SILICONE O-RING 3.5x2 (10)

358194 XRAY GT PROGRESSIVE SPRING SET C=4.1-4.7, 2-DOTS WITH STRIPE (2)
358195 XRAY GT PROGRESSIVE SPRING SET C=5.2-5.8, 3-DOTS WITH STRIPE (2)

11. SHOCK ABSORBERS

358040
S 2.5x6x0.5

960026
N M2.5

4x

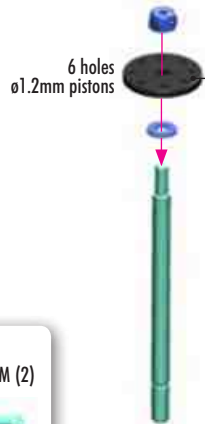

!
NOTE ORIENTATION

#358163
OPTION
GT SHOCK SHAFT 43MM (2)



+
DETAIL

Install the piston with Professional Multi Tool (HUDY #183011).



+
DETAIL



+ DO NOT OVERTIGHTEN

The self-locking nut is overtightened, causing distortion of the piston. This will negatively affect the free movement of the piston in the shock body.

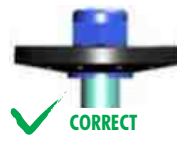

+ TIGHTEN GENTLY

The self-locking nut is gently tightened. The piston remains undistorted and fits inside the shock body perfectly, ensuring smooth movement of the piston.

SET-UP BOOK
SHOCK DAMPING
SHOCK PISTONS

4x

There are two different thickness shims, use them as shown. Use the same procedure when building both front and rear shocks.

970100
O 10x1.5

971034
O 3.4x2

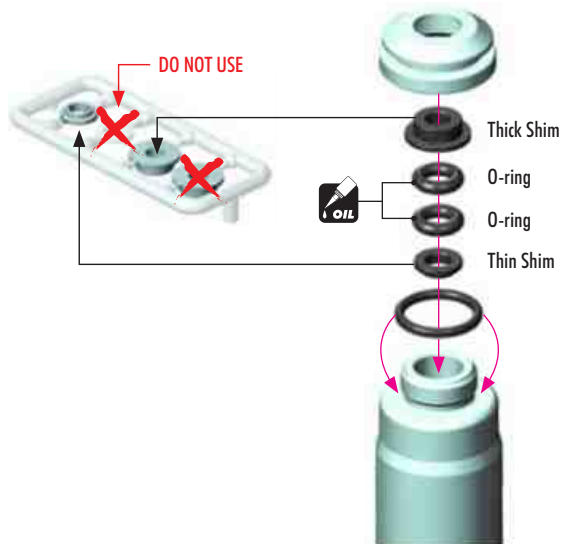

4x

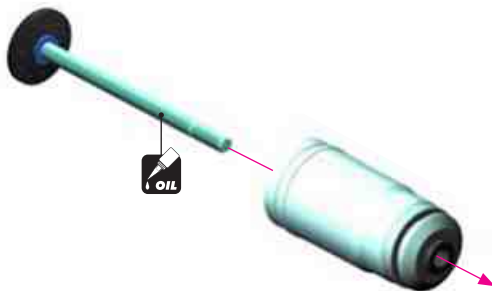

! EXTREMELY IMPORTANT

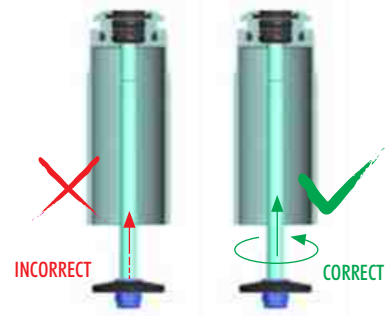

Do not push the shock rod straight through the lower shock body assembly; O-ring damage may result.

Twist the shock rod through the lower shock body assembly.

11. SHOCK ABSORBERS



970180
O 18x1.8

4x

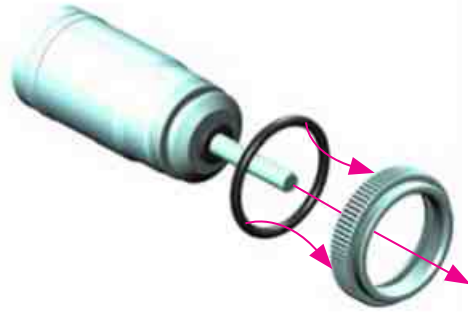

2x FRONT SHOCKS

2x REAR SHOCKS

Professional Multi Tool
(HUDY #183011).

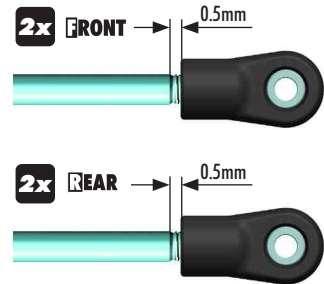
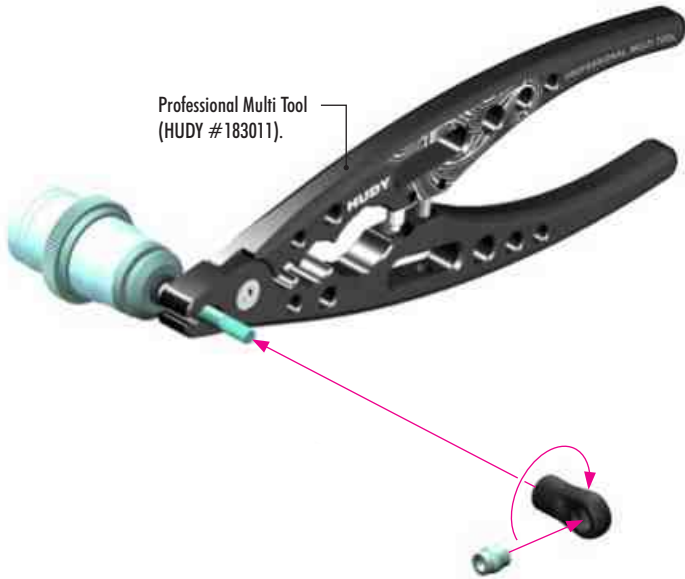

DEFAULT SHOCK REBOUND SETTING 0% (LOW REBOUND)

Follow the steps below to set the shock rebound to the default setting of 0%.

4x SHOCK
Oil 800cSt

SET-UP
BOOK
SHOCK OIL



1 Extend the shock shaft completely. Fill the shock body with the shock oil. For the shocks use 800cSt oil.



2 Move the shock shaft up and down a few times to release the air bubbles trapped beneath the piston.



3 Orient the filled shock vertically for several minutes with the shock shaft fully extended. The remaining air bubbles will release.

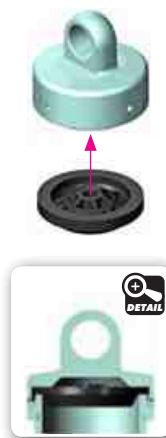

4 Install the shock membrane into the groove in the upper shock cap.



5 Gently place the shock cap assembly onto the filled shock body. Excess oil will spill from the shock. Screw the shock cap onto the body by only a few turns.



6 Gently push the shock shaft completely into the shock body. Excess oil will flow through the hole in the shock cap.



7 Keep the shock shaft pushed in the shock body and tighten the shock cap completely. The rebound will be at approximately 0%.

11. SHOCK ABSORBERS



971034
O 3.4x2

4x

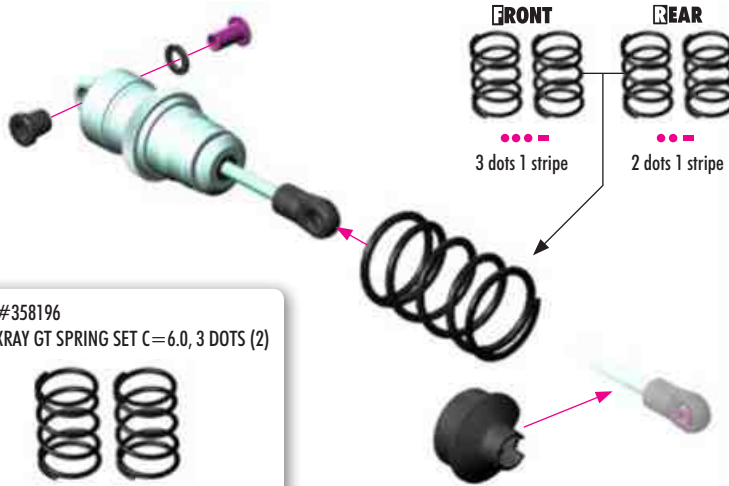

#358196
XRAY GT SPRING SET C=6.0, 3 DOTS (2)



SHOCK PRELOAD



SET-UP BOOK

SPRING RATE SHOCK
PRELOAD
RIDE HEIGHT

TIP ALTERNATE SHOCK REBOUND SETTING (50% AND 100%)

The default shock rebound setting is 0% (as described on page 40).

Alternatively, you may set the shock rebound setting to 50% or 100% as described below. Remove the shock springs before performing shock rebound adjustment.

SETTING THE SHOCK REBOUND TO 50% (MEDIUM REBOUND)

REMOVE SHOCK CAP



1 Extend the shock shaft completely and remove the shock cap.



2 Fill the shock body with shock oil up to the top. Make sure to use same viscosity shock oil as is in the shock.



3 Orient the filled shock vertically for several minutes with the shock shaft fully extended. The remaining air bubbles will release.

HALF TIGHTEN



4 Gently place the shock cap assembly onto the filled shock body. Excess oil will spill from the shock.



5 Push the shock shaft 50% into the shock body. Excess oil will bleed through the hole in the shock cap.

TIGHTEN FULLY

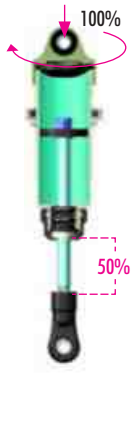

6 Keep the shock shaft pushed 50% into the shock body and tighten the shock cap completely. The rebound will be at approximately 50%.

SETTING THE SHOCK REBOUND TO 100% (HIGH REBOUND)

REMOVE SHOCK CAP



1 Extend the shock shaft completely and remove the shock cap.



2 Fill the shock body with shock oil up to the top. Make sure to use same viscosity shock oil as is in the shock.



3 Orient the filled shock vertically for several minutes with the shock shaft fully extended. The remaining air bubbles will release.

TIGHTEN FULLY

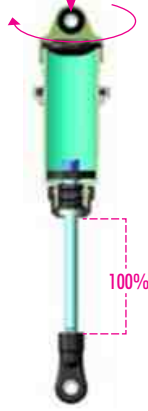

4 Gently place the shock cap assembly onto the filled shock body. Keep the shock shaft extended 100% from the shock body and tighten the shock cap completely. The rebound will be at approximately 100%.

12. FINAL ASSEMBLY

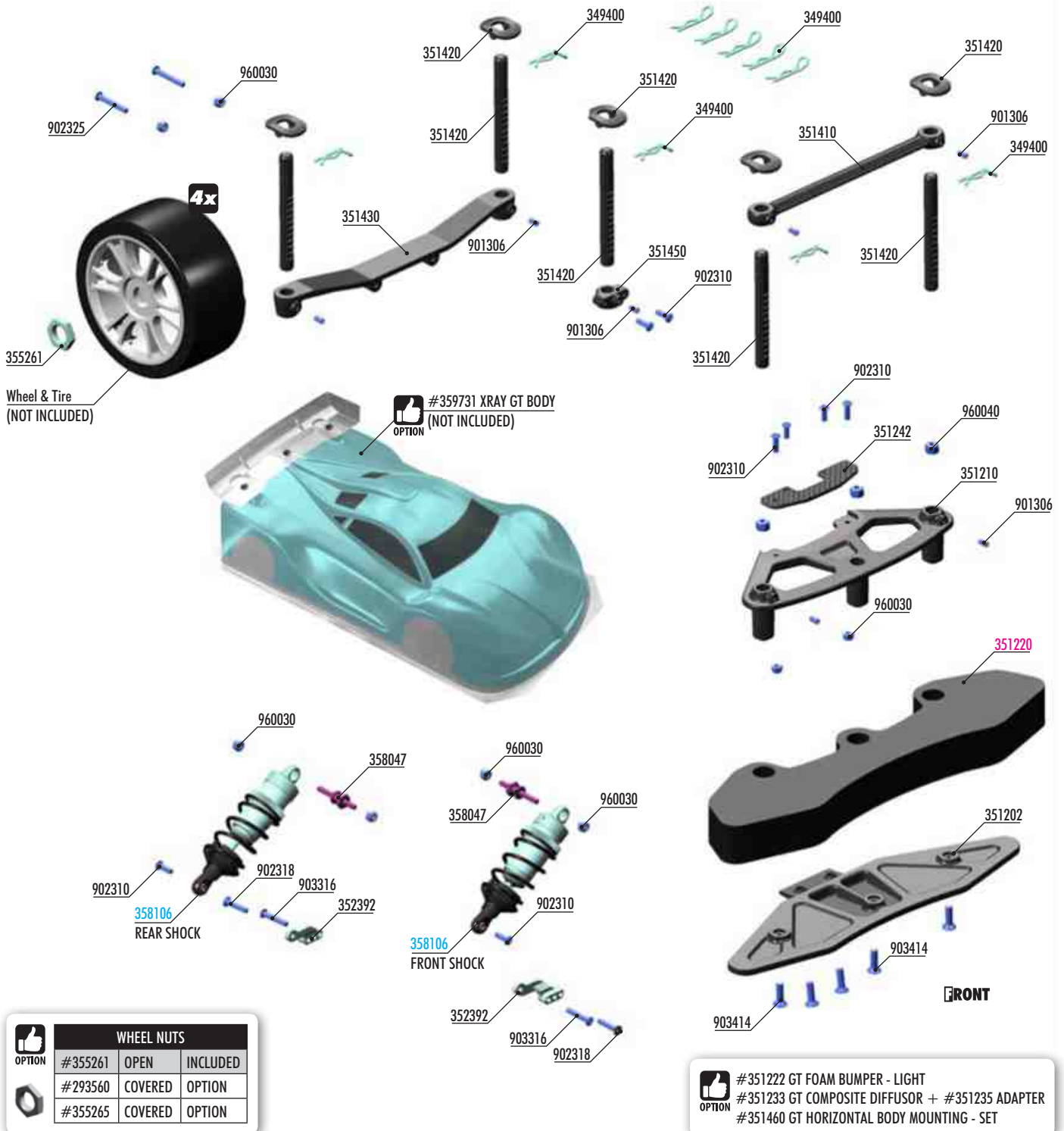

WHEEL NUTS			
	#355261	OPEN	INCLUDED
	#293560	COVERED	OPTION
	#355265	COVERED	OPTION





#351222 GT FOAM BUMPER - LIGHT
 #351233 GT COMPOSITE DIFFUSOR + #351235 ADAPTER
 #351460 GT HORIZONTAL BODY MOUNTING - SET

BAG
12

- 349400 BODY CLIP (10)
- 351202 COMPOSITE FRONT BUMPER - NARROW
- 351210 GT COMPOSITE FRONT UPPER BUMPER
- 351242 GT GRAPHITE PLATE FOR FRONT UPPER BUMPER
- 351410 GT COMPOSITE FRONT HOLDER FOR BODY POSTS
- 351420 GT COMPOSITE BODY POSTS (2)
- 351430 GT COMPOSITE REAR HOLDER FOR BODY POSTS
- 351450 GT COMPOSITE CENTER BODY POST HOLDER
- 352392 GT ALU SHOCK PLATE - SWISS 7075 T6 (L+R)
- 355261 WHEEL NUT - RIBBED - HARD COATED (2)
- 358047 STEEL SCREW SHOCK PIVOT BALL WITH HEX (2)
- 901306 HEX SCREW SB M3x6 (10)
- 902310 HEX SCREW SH M3x10 (10)
- 902318 HEX SCREW SH M3x18 (10)
- 902325 HEX SCREW SH M3x25 (10)
- 903316 HEX SCREW SFH M3x16 (10)





- 903414 HEX SCREW SFH M4x14 (10)
- 960030 NUT M3 (10)
- 960040 NUT M4 (10)
- 358106 GT SHOCK ABSORBER - V2 (2)
- 351220 GT FOAM BUMPER - V2

12. FINAL ASSEMBLY

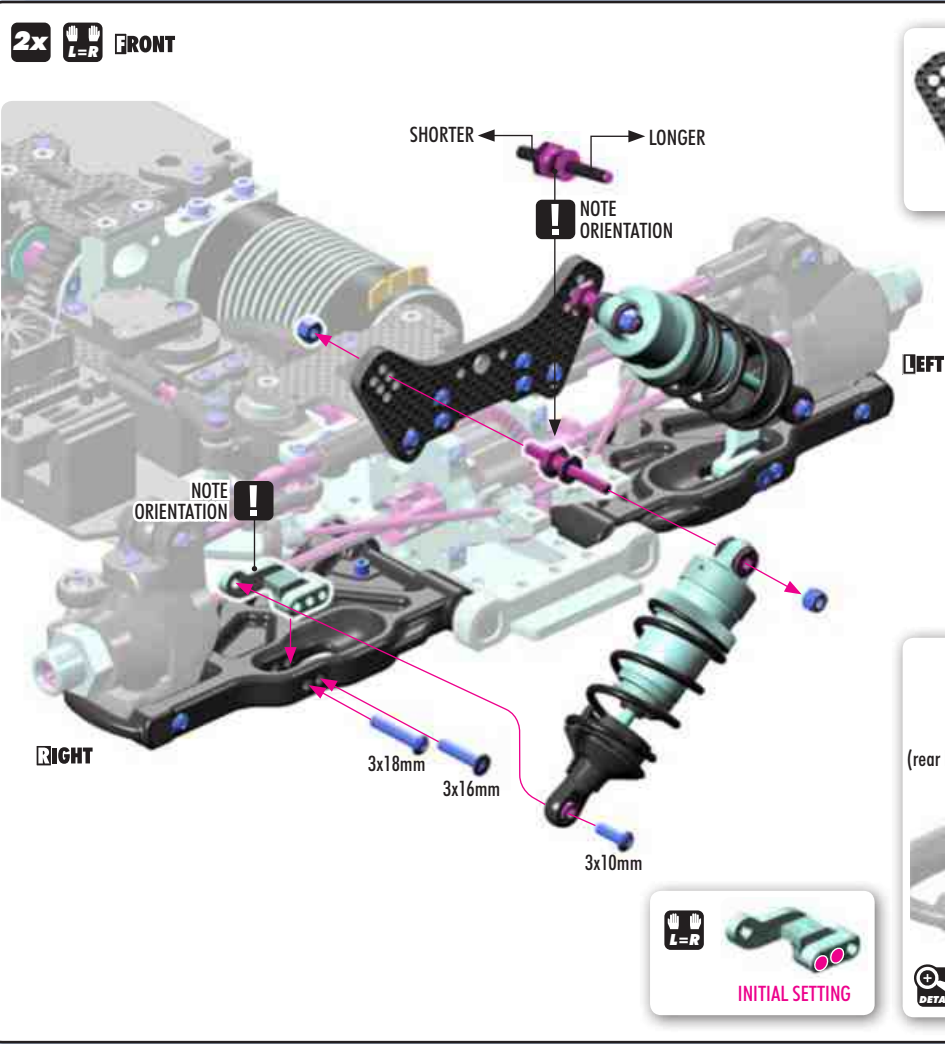
-  902310 SH M3x10
-  903316 SFH M3x16
-  902318 SH M3x18
-  960030 N M3

SET-UP BOOK
SHOCK ABSORBERS



-  902310 SH M3x10
-  903316 SFH M3x16
-  902318 SH M3x18
-  960030 N M3

SET-UP BOOK
SHOCK ABSORBERS

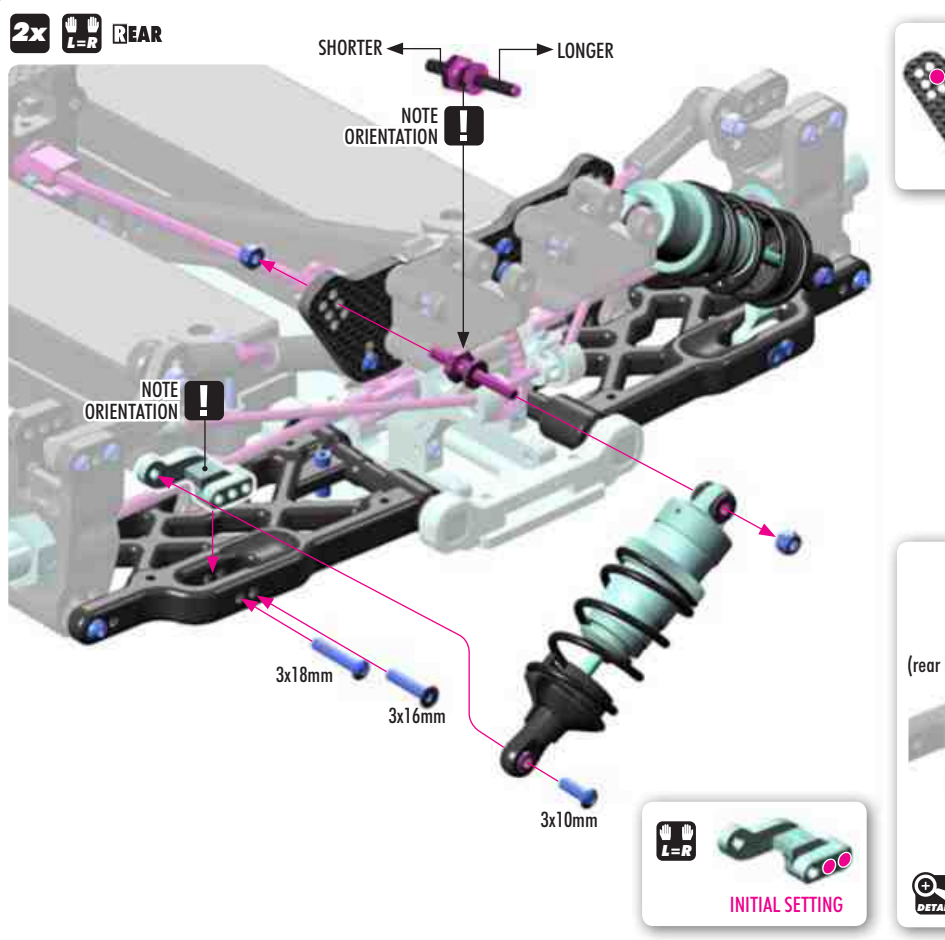

12. FINAL ASSEMBLY



903414
SFH M4x14



960040
N M4

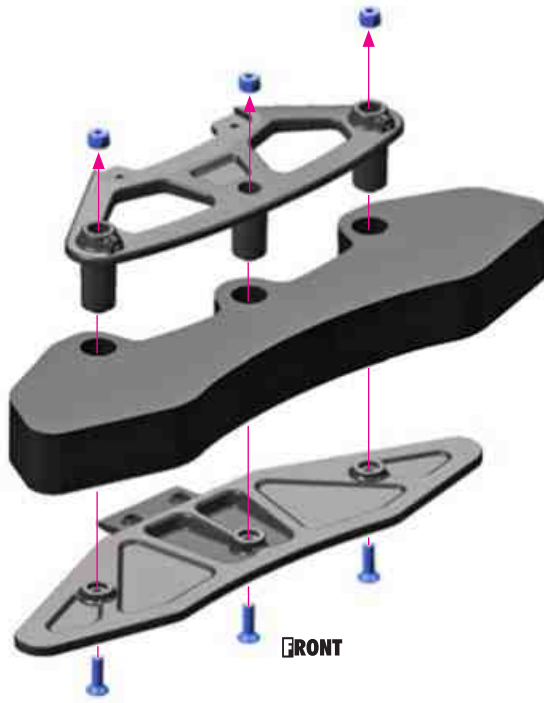

902310
SH M3x10



960030
N M3

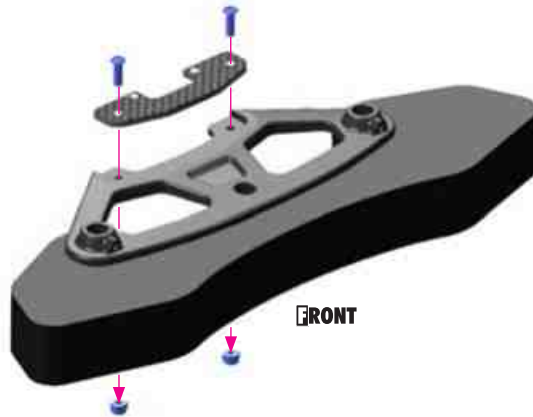

901306
SB M3x6



902310
SH M3x10



903414
SFH M4x14

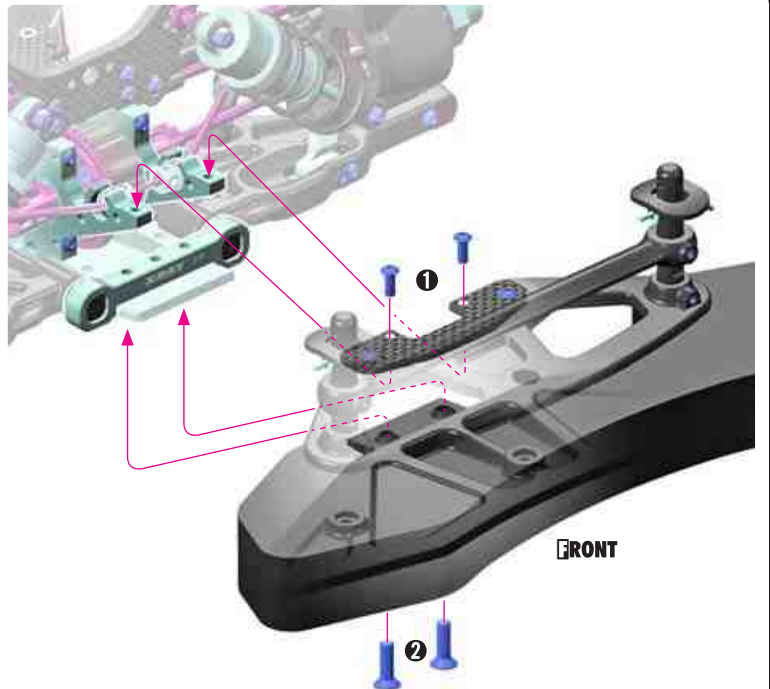
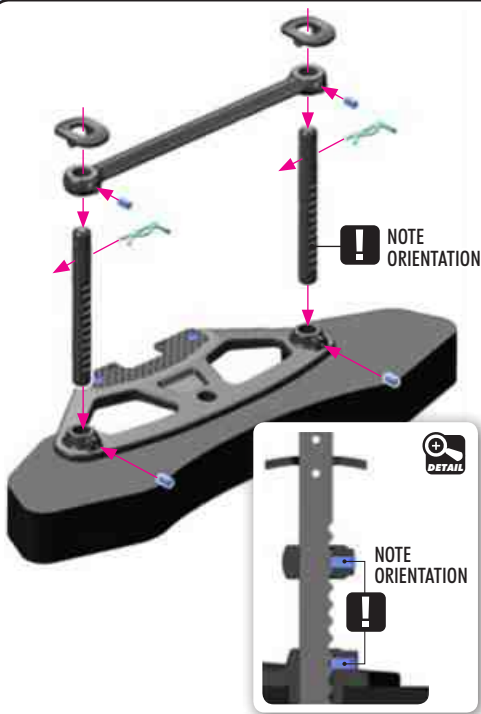

12. FINAL ASSEMBLY



901306
SB M3x6



902310
SH M3x10

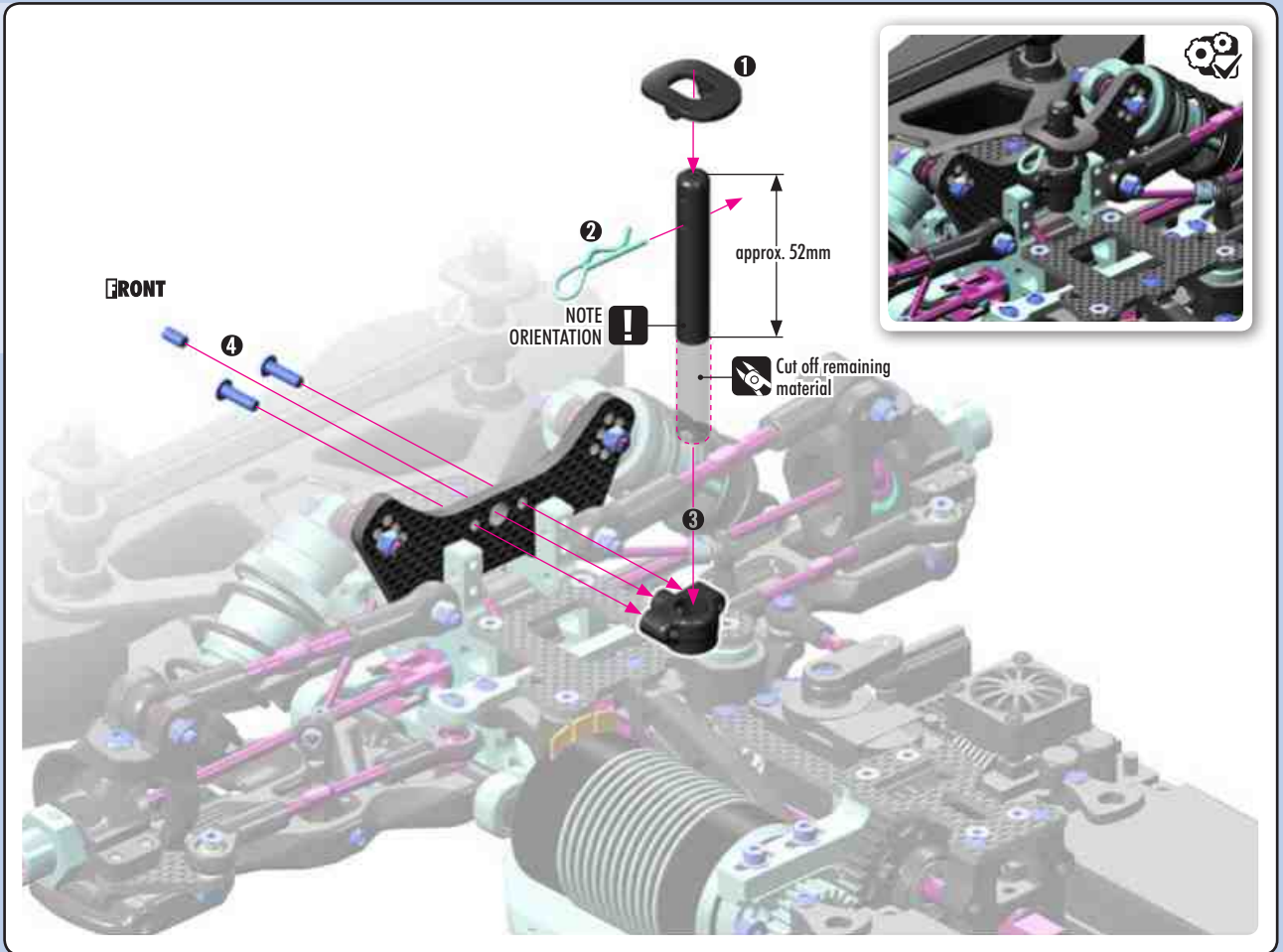

901306
SB M3x6



902325
SH M3x25



960030
N M3

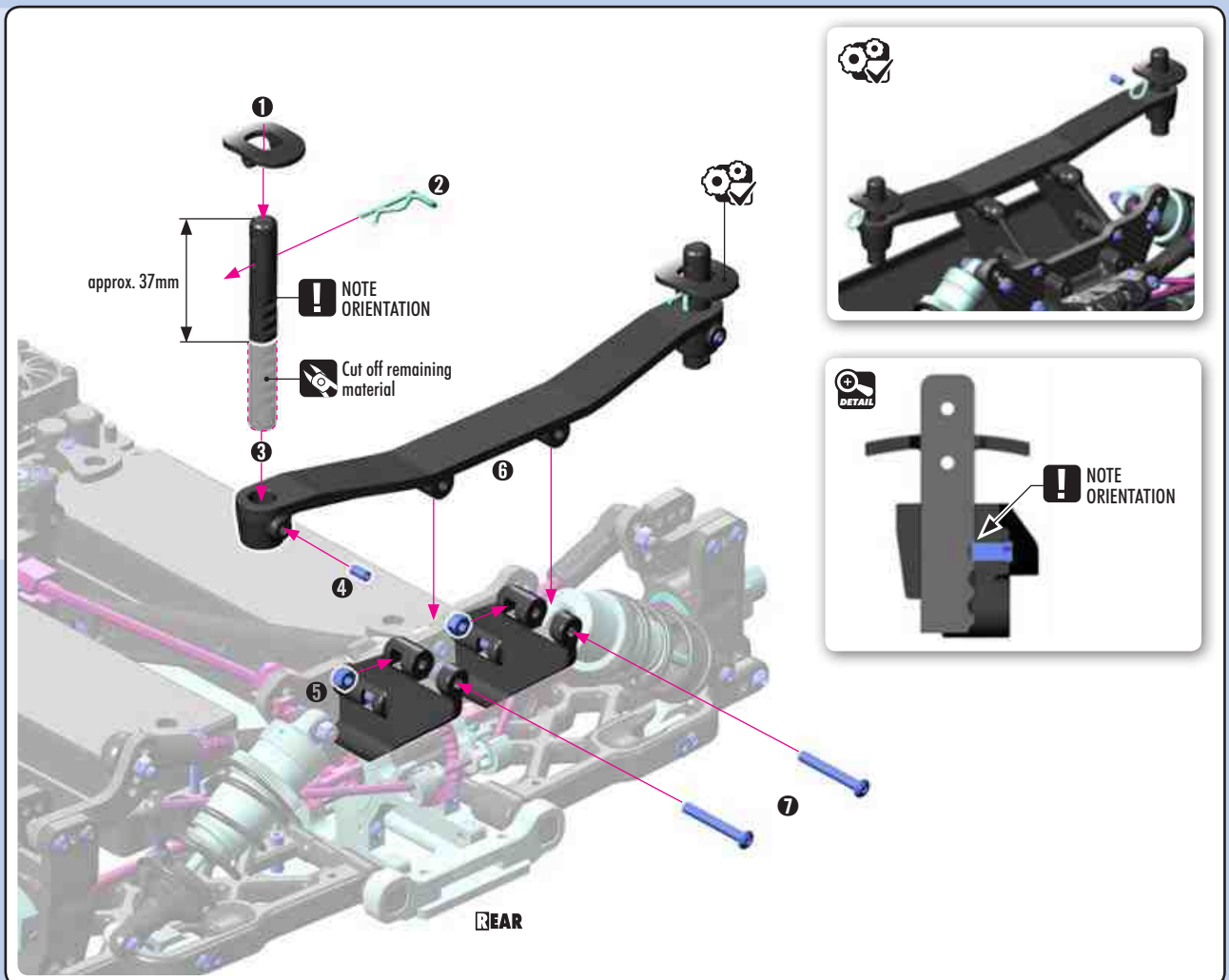

12. FINAL ASSEMBLY

4x

Wheel & Tire (NOT INCLUDED)

FRONT

Wheel & Tire (NOT INCLUDED)

TIP To tighten the screw you can also use the #107570 HUDY 17mm Wheel Nut Tool.

		WHEEL NUTS		
OPTION	#355261	OPEN	INCLUDED	
	#293560	COVERED	OPTION	
	#355265	COVERED	OPTION	

OPTION #359731 GTX BODY (NOT INCLUDED)

- 1 Before cutting and making holes on the body, put the unpainted body on the chassis to confirm the mounting position and location for holes and cutouts.
- 2 Before painting, wash the inside of the body with mild detergent, and then rinse and dry thoroughly.
- 3 Mask all windows.
- 4 Apply paint masks as appropriate.
- 5 Paint the body using paints formulated for polycarbonate bodies.
- 6 When the paint is dry, remove the masking.
- 7 Carefully cut out the body using appropriate scissors or cutting tools.
- 8 When you have finished cutting, peel off the external protective films.

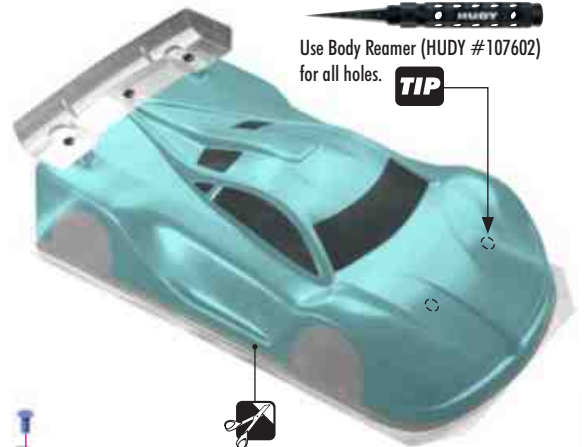

TIP To reinforce the body or to fix broken body use #106280 HUDY BODY FIX.

		WING SHIMS		
OPTION	#353565	COMPOSITE	INCLUDED	
	#293561	ALU	OPTION	
	#293561-K	ALU	OPTION	
	#293561-O	ALU	OPTION	
	#353561	ALU	OPTION	

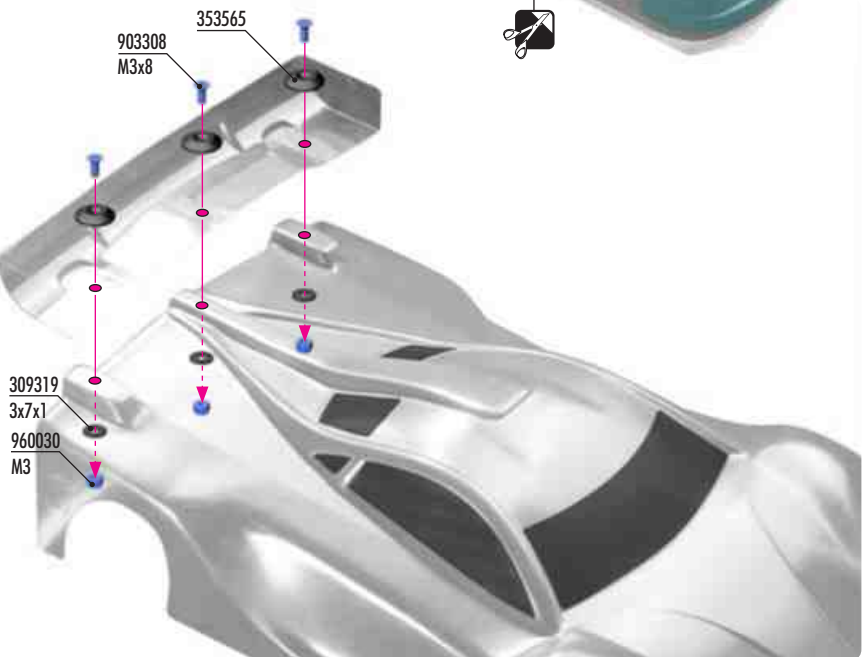

12. FINAL ASSEMBLY



#351460
GT HORIZONTAL BODY MOUNTING - SET

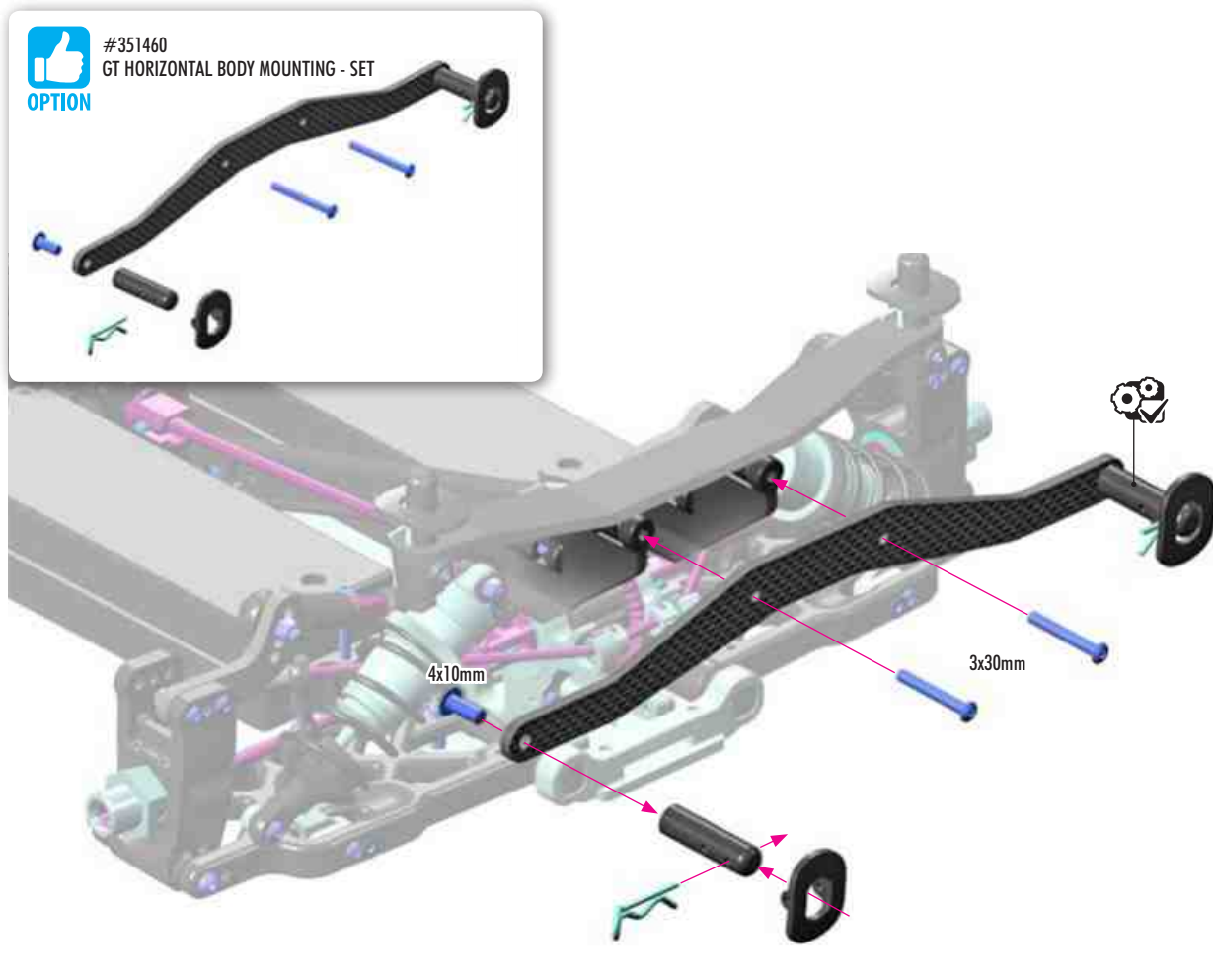

960030
N M3

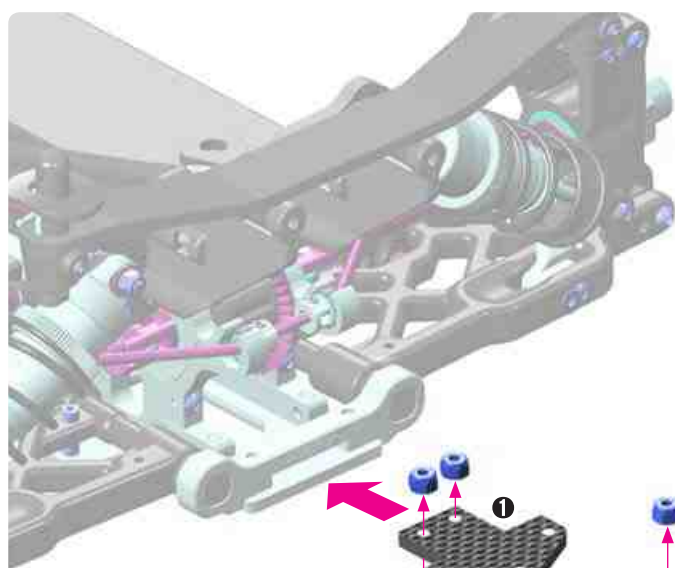

#351233 GT COMPOSITE DIFFUSOR
#351235 ADAPTER

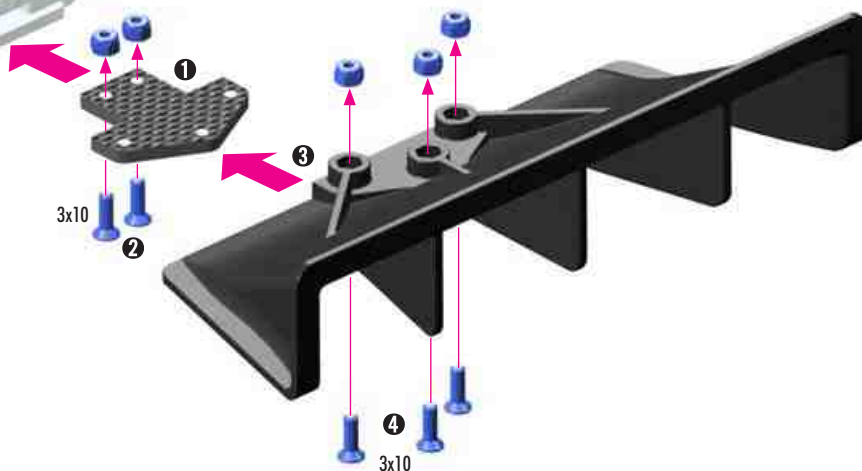

SHOCK MAINTENANCE

The most important maintenance task for keeping consistent shock performance is refilling and bleeding them correctly. If built correctly, it will not be necessary to re-build them often. Replacing warped/hard rubber bladders and o-rings, scarred piston rods, or shaved/split/loose composite upper and lower ball joints are also important.

- For club racing, it is recommended to check the shocks for air inside before each race and only re-fill and bleed them if necessary. Before each race day, make sure you take the spring off of each shock, hold it up to your ear, and quickly compress the shock rod fully into the body while listening for any air making a "whistling" or "squishy" sound as it passes through the piston holes. If you hear any air, refill and bleed your shocks. For high-competition racing, it is recommended that the shocks be re-filled and bled before a large event.
- If building or pairing new shocks, always make sure they are the same length using a shock length measuring tool and adjust the lower ball joints as needed.
- If installing new rubber bladders, carefully trim the thin excess rubber from the edges of their lips. Curved body scissors work the best.
- Regularly inspect the amount of dirt on the felt protector in the shocks (if present) and regularly replace with a new one.
- During regular shock operation, oil naturally gets on the shock shaft and drop-by-drop slightly gets out of the shock body. Shocks should be inspected regularly after each race, and oil replaced as required.

BEARING MAINTENANCE

Ball-bearings in an off-road car or truggy must be properly maintained for smooth operation and long lifespan.

Typically, the ball-bearings included in new cars are greased for highest lifespan and as such the drivetrain may not seem to be as free as with lightly-oiled ball-bearings. However, when the car is run the ball-bearings will become more free and the drivetrain will become very efficient.

There are several types of bearings discussed here: bearings which already come greased from the factory, bearings which must be lubricated using the HUDY Bearing Grease, and then there are also bearings in the steering system which need to be lubricated with HUDY Bearing Oil.

The following procedures are recommended to clean all of the bearings in your off-road car or truggy. For high-competition racing, we recommended doing this every 3-4 weeks, or before a major race.

1. Remove the seals on both sides of the bearing (if present). If the seals bend a little and you can see a kink, carefully flatten the kink out by hand.
2. Spray the seals with motor cleaner and blow dry with compressed air.
3. Spray the bearing on both sides with motor cleaner.
4. Spin the bearing while it is still wet to dislodge any particles with the cleaner.
5. Spray the bearing on both sides again.
6. Blow both sides of the bearing dry with compressed air to make sure particles come out.
7. Hold the inner part of the bearing with my left thumb/forefinger and spin it to make sure it spins free without any abnormal vibrations or sounds.
8. Place one drop of bearing oil into each side of the bearing.
9. Replace both seals at the same time by lining them up on each side of the bearing and lightly pressing them in all the way around the bearings circumference with your thumb and forefinger. Do not press too hard or use any type of tool, such as a wrench tip, to push the blue seals in as they will push in too far, bend and cause drag.

If you spin test the bearing after you have re-oiled and sealed it, it will not spin freely for an extended period of time. The lightest of oils may allow it to spin for 1-2 seconds. This is normal and once you have mounted the bearings in the car again, the drive train will spin freely.

Make sure you use a motor cleaner that does not leave a residue after it dries as this may cause drag and wear in the bearings.

CLUTCH BEARINGS

To prolong the lifespan of the clutch bearings, they must be regularly cleaned and lubricated (preferably after each run) using a high-quality grease such as HUDY Bearing Grease. However, after some time the clutch bearings must be replaced with new ones.

RECOMMENDED PRODUCTS

- Use HUDY Bearing Grease to regularly lubricate grease-bearing ball-bearings.
- Use HUDY Bearing Oil to lubricate the bearings of the steering system.
- Use HUDY Bearing Grease to regularly lubricate the clutch bearings.



SUSPENSION & DRIVETRAIN MAINTENANCE

- Check suspension for free movement during building and operation, and especially after running and if you have crashed the car. If the suspension does not move freely, use the appropriate HUDY Arm Reamer to clean and resize the holes of the suspension arms.
- Regularly check the drive shaft pins (both side and center) and if they show any wear must be immediately replaced by new pins. If the car is run with worn pins, excessive wear on the diff outrives will result. The 106000 HUDY Drive Pin Replacement Tool (for 3mm Pins) is a compact, rugged multi-use tool set for replacing 3mm drive pins in drive shafts. Use the HUDY replacement drive shaft pins 3x14 (#106050).
- Regularly inspect and replace the connecting pins which connect the center drive shafts with the pinion gear, and also the pins that connect the wheel drive shafts with wheel axles. Use HUDY Graphite Grease to lubricate the drive shaft connecting joints and the diff gears.
- Pivot balls and ball-joints will naturally wear for some time and will generate play. If there is too much play the pivot balls and ball joints need to be replaced.
- If the car is run in wet conditions, apply WD-40® on all drivetrain parts before the run. After the run, clean and dry the parts again.

HUDY SPRING STEEL™

The HUDY Spring Steel™ used in the car is the strongest and most durable steel material on the RC market. While items made from HUDY Spring Steel™ are still subject to wear, the lifespan is considerably longer than any other material. As parts made from HUDY Spring Steel™ wear, the brown color will after some time "go down" but it will not affect the strength of the material. The brown color is only a surface treatment and if the brown color will wear the durability of the part will be still strong.

HUDY

All the tools & accessories shown are suitable for GTX8 and/or GTX8E

199310

199911

108760

108701

108213

108202

HUDY

107855

109880

104005

107704

107030

109672

293111

106245

181110

108190

109601

107701

107717

293560

107865

188981

181030

181040

181034

181050

107744

107581

293540

112071

112571

164071

107742

- #104005 HUDY Air Vac - Vacuum Pump - 1/8 Off-Road
- #104140 HUDY Engine Break-In Bench
- #104500 HUDY Star-Box 1/8 Off-Road
- #105500 HUDY Universal Tire Balancing Station
- #105510 Wheel Adapter for 1/8 Off-Road Cars, Truggy & Rally Game
- #106000 HUDY Drive Pin Replacement Tool (for 3mm Pins)
- #106200 HUDY Magic Cleaning Gum
- #106245 HUDY Air Filter Sealant
- #107030 HUDY Flywheel Puller
- #107090 HUDY Bearing Check Tool
- #107570 HUDY 17mm Off-Road Wheel Nut Tool
- #107581 HUDY Cross Wrench Glowplug # 8mm / Clutchnut # 10mm
- #107602 Limited Edition - Reamer for Body 0-18mm + Cover - Large

- #107612 Limited Edition - Exhaust Spring / Caster Clip Remover
- #107644 Limited Edition - Arm Reamer # 4.0mm
- #107701 Chassis Droop Gauge Support Blocks 20mm for 1/8 - LW(2)
- #107704 Chassis Droop Gauge Support Blocks 30mm 1/8 Off-Road - LW (2)
- #107717 Chassis Droop Gauge 0 to -13 mm for 1/8 Off-Road
- #107742 HUDY Adjustable Ride Height Gauge 20-30mm
- #107744 HUDY Adjustable Ride Height Gauge 30-45mm
- #107762 HUDY Adjustable Camber Gauge 110mm
- #107780 HUDY Adjustable Droop Gauge 80-140mm
- #107783 HUDY Droop Gauge 70-140mm
- #107855 HUDY Pit LED
- #107865 HUDY Ultimate Digital Pocket Scale 300g/0.01g
- #108170 HUDY Off-Road & Truggy Car Stand

- #108190 HUDY Alu Tray for Parts
- #108202 Flat Set-Up Board for 1/8 Off-Road & Truggy
- #108213 Plastic Set-up Board Decal for 1/8 Off-Road & Truggy
- #108701 Flat Set-Up Board for 1/8 Off-Road & GT - Lightweight
- #108760 Plastic Set-Up Board Decal 399x545mm - 1/8 Off-Road & GT
- #109601 HUDY Set-Up Station for 1/8 GT
- #108860 Alu Nut for 1/8 Off-Road System (4)
- #109672 Alu Set-Up Wheel for 1/8 GT (4)
- #109802 HUDY Alu Tray for 1/8 Off-Road Diff & Shocks
- #109841 HUDY Alu Tray for 1/8 Off-Road Diff Assembly
- #109860 HUDY Alu Tray for Set-Up System
- #109880 HUDY Alu Tray for Accessories & Pit LED
- #111545 Limited Edition - Allen Wrench # 1.5mm

EXCLUSIVE PROFESSIONAL

HUDY

199186

104500

HUDY

199060

109802

108170

105510

105500

199270

106200

106000

107762

107780

107783

107602

107090

183011

188990

107644

154060

107612

113045

112545

132545

112045

132045

111545

164045

175535

170050

109841

109860

181090

107570

182016

- #112045 Limited Edition - Allen Wrench # 2.0mm
- #112071 Power Tool Tip Allen 2.0 x 90 mm
- #112545 Limited Edition - Allen Wrench # 2.5mm
- #112571 Power Tool Tip Allen 2.5 x 90 mm
- #113045 Limited Edition - Allen Wrench # 3.0mm
- #132045 Limited Edition - Allen Wrench + Ball Repl. Tip # 2.0mm
- #132545 Limited Edition - Allen Wrench + Ball Repl. Tip # 2.5mm
- #154060 Long Slotted Screwdriver 4.0 mm - for Engine Adjust. - SPC - V2
- #164045 Limited Edition - Phillips Screwdriver # 4.0mm
- #164071 Power Tool Tip Phillips 4.0 x 90 mm
- #170050 Socket Driver 5.0 mm
- #175535 Limited Edition - Socket Driver # 5.5mm
- #181030 HUDY Spring Steel Turnbuckle Wrench 3 mm

- #181034 HUDY Spring Steel Turnbuckle Wrench 3 & 4mm
- #181040 HUDY Spring Steel Turnbuckle Wrench 4 mm
- #181050 HUDY Spring Steel Turnbuckle Wrench 5 mm
- #181090 HUDY Special Tool For Turnbuckles & Nuts
- #181110 HUDY Ball Joint Wrench
- #182016 Wheel Nut & 3/4 Shoe Flywheel Multi-Toll 1/8 GT
- #183011 HUDY Professional Multi Tool
- #188981 HUDY Pocket Hobby Knife
- #188990 HUDY Professional Body Scissors
- #199060 HUDY Alu Tool Stand
- #199186 HUDY Car Bag - 1/8 On-Road GT
- #199270 HUDY LiPo Safety Bag
- #199310 HUDY Pit Bag - Compact

- #199911 HUDY Pit Mat Roll 750x1200mm with Printing
- #293111 HUDY Brushless RC Fan 40mm
- #293540 Air Filter Foam & Oil (10) - XRAY XB8 Low Profile Style
- #293560 HUDY Alu Wheel Nut with Cover - Ribbed (2)

For more information about tools, set-up equipment and accessories suitable for your car please visit:

www.hudy.net



www.teamxray.com

XRAY EUROPE

XRAY, K VÝSTAVISKU 6992, 91101 TRENCIN, SLOVAKIA, EUROPE
PHONE: +421-32-740 11 00, FAX: +421-32-740 11 09, info@teamxray.com

XRAY USA

RC AMERICA, 2030 Century Center Blvd #15, Irving, TX 75062, USA
PHONE: 214-744-2400, FAX: 214-744-2401, xray@rcamerica.com