



DRIVER, TRACK AND RESULTS

DRIVER Andy freeman	Serpent UK	WEATHER AIR 23C/73F	TRACK 20C/68F	Moisture: Dry
RACE BRCA east of England regional	July 22, 2024	Class: Modified	FINAL POS.	FASTEST LAP
TRACK Boughton Raceway	TYPE Outdoor astroturf	STYLE <input type="checkbox"/> TIGHT <input type="checkbox"/> MEDIUM <input type="checkbox"/> OPEN <input type="checkbox"/>	Medium	
SURFACE GRIP <input type="checkbox"/> LOW <input type="checkbox"/> MEDIUM <input type="checkbox"/> HIGH <input type="checkbox"/>	Low	CONDITION <input type="checkbox"/> SMOOTH <input type="checkbox"/> ROUGH <input type="checkbox"/>	Bumpy	
Setup: Boughton dry		Full details in app: sodialed.com/s/TCem		

FRONT SHOCK ABSORBERS		REAR
650 cst	OIL	450 cst
AE Red V2	SPRINGS	AE Blue V2
0 %	REBOUND	0 %
Int/ext: 0 / 0 mm	LIMITERS	Int/ext: 0 / 0 mm
Reactor 1.7x2	PISTONS	Reactor 1.8x2
Oil brand: CORE		
<input checked="" type="checkbox"/> SHORT <input type="checkbox"/> LONG	SPRING BUCKETS	<input type="checkbox"/> SHORT <input checked="" type="checkbox"/> LONG
<input type="checkbox"/> BLADDER	SEAL TYPE	<input type="checkbox"/> BLADDER
<input checked="" type="checkbox"/> EMULSION		<input checked="" type="checkbox"/> EMULSION

FRONT ANTI-ROLL BARS		REAR
Front: 1.4 mm		Rear: 1.0 mm

FRONT DIFFERENTIAL	REAR
<input type="checkbox"/> BALL DIFFERENTIAL	<input type="checkbox"/> BALL DIFFERENTIAL
<input type="checkbox"/> GEAR DIFF 20,000	<input type="checkbox"/> GEAR DIFF 15,000
FR DIFF HEIGHT  Mid	RR DIFF HEIGHT  Mid

GEARING	
PINION 21 Teeth	SPUR GEAR 78 Teeth

ELECTRONICS	
BATTERY	
BRAND Intellect Pioneering	HV 7.6v CAPACITY 4400 mAh
MOTOR	
BRAND Konect	TYPE K1 elite Wind: 5.5 T TIMING 30 deg
ESC	
BRAND Corally	TYPE Cerix 2 160a

AERODYNAMIC CONFIGURATION	
BODY RB Flow	
REAR WING Jconcepts astro 7"	
REAR WING WIDTH	REAR WING LIP mm
RR WING ANGLE <input type="checkbox"/> 0° <input checked="" type="checkbox"/> 2° <input type="checkbox"/> 4° <input type="checkbox"/> 6° <input type="checkbox"/> 8°	MOUNT <input type="checkbox"/> STD <input type="checkbox"/> LOW
FRONT WING <input type="checkbox"/> YES <input type="checkbox"/> NO	TYPE

FRONT TIRES	REAR
Schumacher Mezzo	Schumacher Mezzo
Yellow	Yellow
Rb cheater	Rb Cheater
Serpent	Jconcepts mono
	ADDITIVE

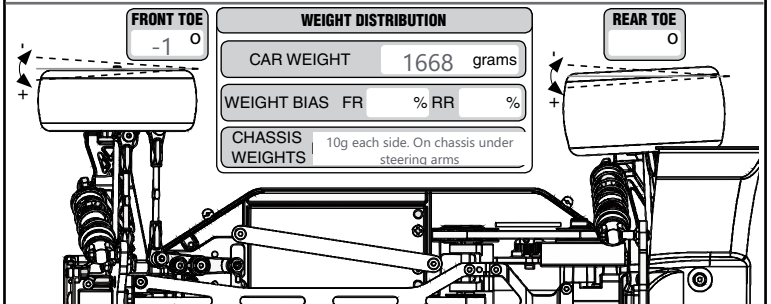
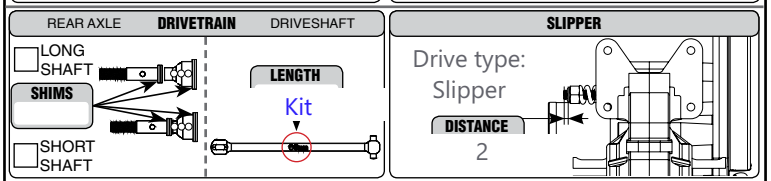
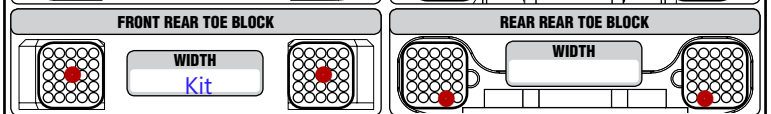
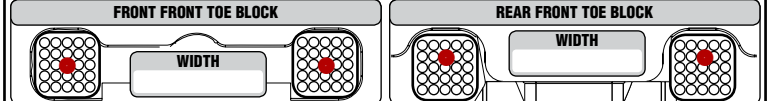
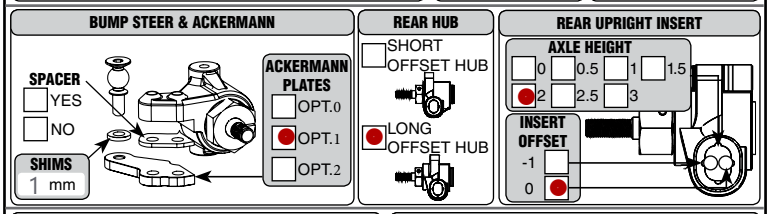
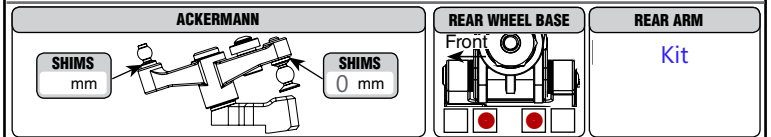
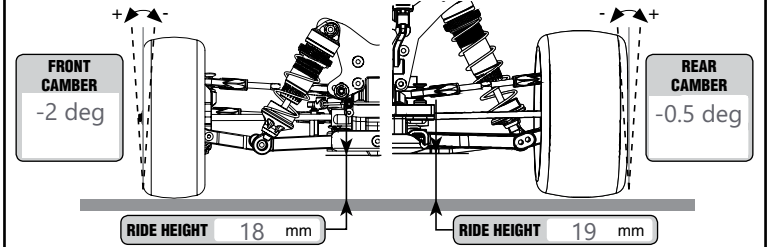
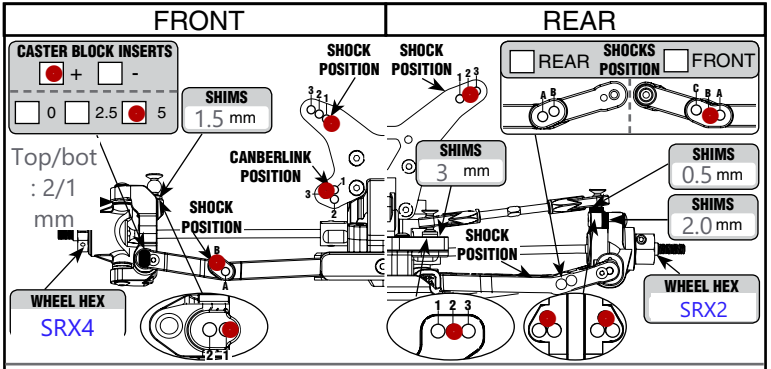

REMARKS