

# **User Manual**

## **Binocular Compound LED Microscope**

**Model M8211 Series**

The logo for OMAX, consisting of the letters 'OMAX' in a white, bold, sans-serif font, centered within a solid blue rectangular background.

**OMAX**

# Table of Contents

I.	Caution .....	1
II.	Care and Maintenance.....	2
1.	Components Illustration .....	3
2.	Installation.....	4
3.	Operation .....	6
4.	Specifications.....	9
5.	Optional Parts .....	10
6.	Troubleshooting Guide .....	13
7.	Darkfield Condenser Installation and Operation Instructions .....	15
8.	Phase Contrast Kit Installation and Operation Instruction .....	16

## **I. Caution**

1. Open the carton carefully with a knife or paper cutter. Find the “UP” sign and place the Styrofoam container on the side that makes the arrow upward. If the “UP” sign is missing, please open the Styrofoam container gently to prevent any accessory items (i.e. objectives or eyepieces) from dropping and being damaged.
2. Do not discard the molded Styrofoam container. The container should be retained should the microscope ever requires reshipment.
3. Keep the instrument out of direct sunlight, high temperature or humidity, and dusty environments. Ensure that the microscope is located on a smooth, level and firm surface.
4. If any specimen solutions or other liquids splash onto the stage, objective or any other component, disconnect the power cord immediately and wipe up the spillage. Otherwise, the instrument may be damaged.
5. All electrical connectors (power cord) should be inserted into an electrical surge suppressor to prevent damage due to voltage fluctuations.

## II. Care and Maintenance

1. Do not attempt to disassemble any component including eyepieces, objectives or focusing assembly.
2. Keep the instrument clean; remove dirt and debris regularly. Accumulated dirt on metal surfaces should be cleaned with a damp cloth. More persistent dirt should be removed using a mild soap solution. **Do not use organic solvents for cleansing.**
3. The outer surface of the optics should be inspected and cleaned periodically using an air stream from an air bulb. If dirt remains on the optical surface, use a soft cloth or cotton swab dampened with a lens cleaning solution (available at camera stores). All optical lenses should be swabbed using a circular motion. A small amount of absorbent cotton wound on the end of a tapered stick makes a useful tool for cleaning recessed optical surfaces. Avoid using an excessive amount of solvents as this may cause problems with optical coatings or cemented optics or the flowing solvent may pick up grease making cleaning more difficult. Oil immersion objectives should be cleaned immediately after use by removing the oil with lens tissue or a clean, soft cloth.
4. Observe the specimen with the 4X, 10X and 40X objectives in order, then observe the specimen with the 100X objective. Apply the immersion oil on the slide cover with the 100X objective. Do not let the immersion oil to contact with the dry objectives lens (especially the 40X). Clean the dry objective lens using the lens cleaning paper if the immersion oil is on the dry objectives lens. Clean the 100X objective lens first using the lens cleaning paper after observing the specimen with the 100X objective, then clean the specimen. More persistent dirt should be removed using a little bit alcohol. **Do not use organic solvents for cleansing.**
5. Store the instrument in a cool, dry environment. Cover the microscope with the dust cover when not in use.

# 1. Components Illustration

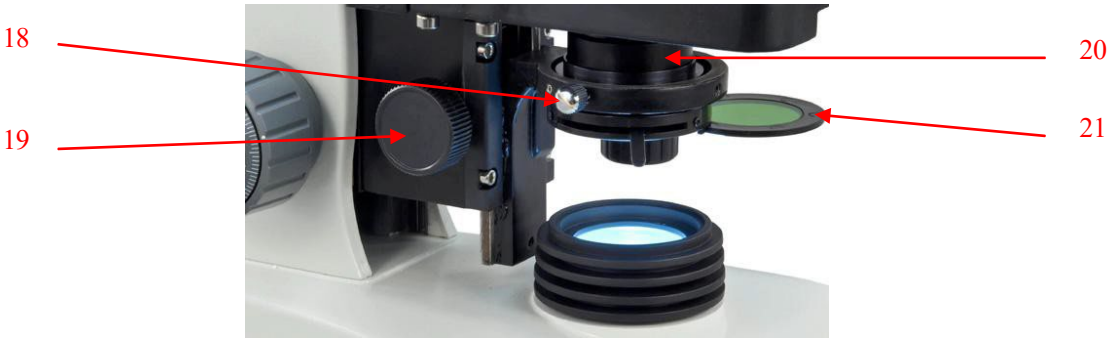
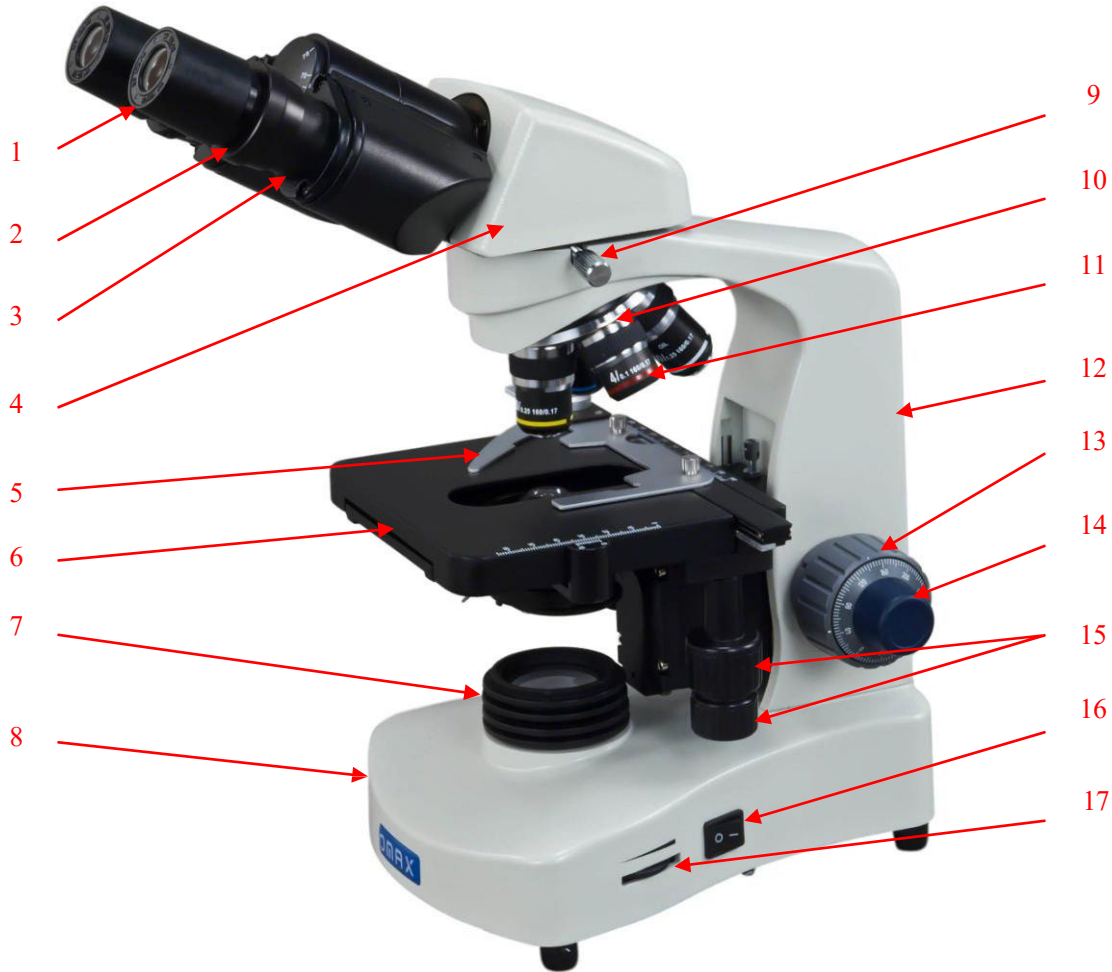

- |   |                  |    |                       |    |                            |
|---|------------------|----|-----------------------|----|----------------------------|
| 1 | Eyepiece         | 8  | Microscope Base       | 15 | X-Y Stage Moving Knobs     |
| 2 | Diopter Ring     | 9  | Head Lock Thumb Screw | 16 | Power Switch               |
| 3 | Eyepiece Tube    | 10 | Nosepiece             | 17 | Brightness Intensity Dial  |
| 4 | Viewing Head     | 11 | Objective             | 18 | Condenser Lock Thumb Screw |
| 5 | Slide Holder     | 12 | Microscope Body       | 19 | Condenser Focus Knob       |
| 6 | Mechanical Stage | 13 | Coarse Focus Knob     | 20 | Condenser                  |
| 7 | Light Collector  | 14 | Fine Focus Knob       | 21 | Color Filter Holder        |

## 2. Installation

### 2.1 Installation of the binocular viewing head

- 1) Loosen the head lock thumb screw on the top of the microscope body and remove the plastic cover on the top.
- 2) Remove the cap on the dovetail of the binocular viewing head.
- 3) Seat the dovetail of the viewing head into the socket on the top of the microscope body and tighten the head lock thumb screw.

**Caution:**

Do not release the viewing head from your hand grip until you are sure the viewing head is installed securely.

### 2.2 Installation of the eyepieces

- 1) Remove the protective caps from the eyepiece tubes.
- 2) Insert the eyepieces into the eyepiece tubes.

### 2.3 Installation of the objectives

- 1) Adjust the coarse focus knob until the mechanical stage is at its lowest position.
- 2) Turn the caps counter-clockwise to remove them from the nosepiece.
- 3) Take the objectives out from the plastic cases and turn each one clock-wise into the holes on the nosepiece. Install the 4X objective into the nosepiece first. Then in a counter-clockwise direction, rotate the nosepiece and install each succeeding higher magnification objective as shown in **Fig. 1**.



**Fig.1**

**Note:**

- Inspect the objectives frequently for dirt or oil; clean if necessary.
- Use the 10X objective to initially focus the image of your specimen.
- When changing the objective magnification, rotate the objective nosepiece until you hear a “click” sound or have a clear “in position” feeling. This ensures the objective is centered in the optical light path.

### 2.4 Replacing the fuse (older models)

- 1) Turn off the power switch and disconnect the power cord.
- 2) Find the fuse holder at the rear bottom of the microscope body.
- 3) Pry out the fuse holder gently with a flat head screwdriver.
- 4) Replace the old fuse with a new one, and then insert it back in. See **Fig. 2**.

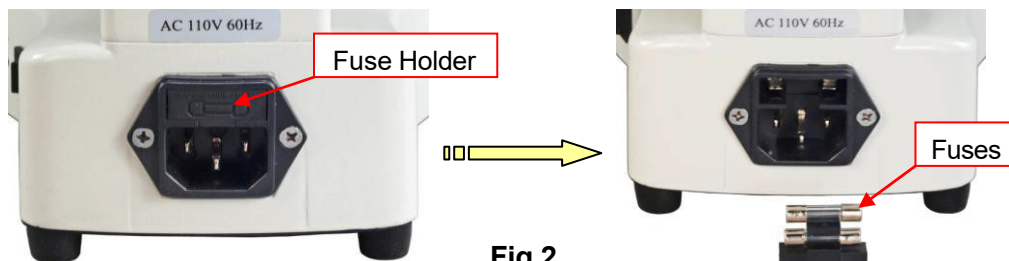

**Fig.2**

**2.5 Installation of the glass filter**

- 1) Swing out the color filter holder under the condenser.
- 2) Place the filter into the color filter holder as shown in **Fig. 3**, swing the holder in.

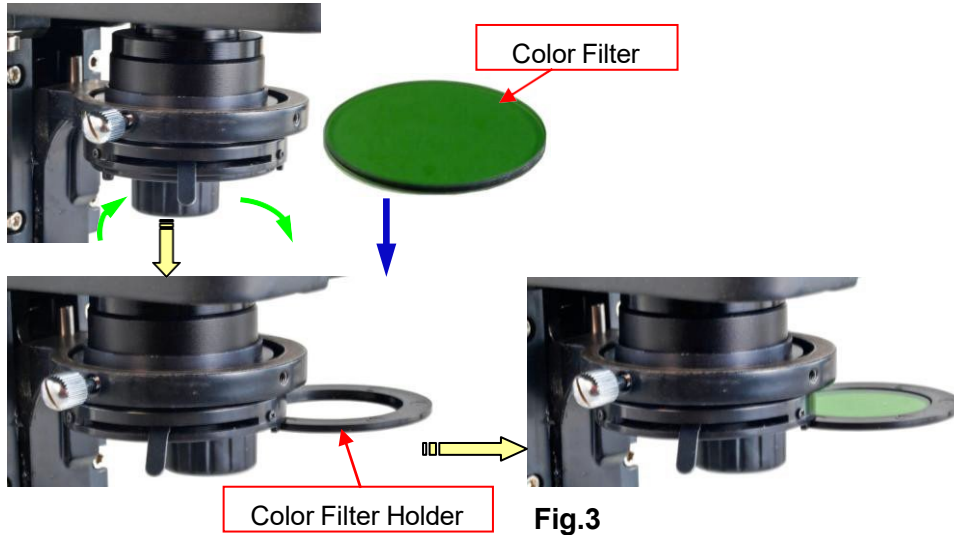

**Fig.3**

**2.6 Installation of the camera (optional, may not included in your package)**

- 1) Take off the eyepiece from the eyepiece tube.
- 2) Insert the camera into the eyepiece tube, and then connect the camera to a computer via USB2.0 cable. See **Fig.4**.
- 3) The manual for the camera is on a CD (or mini CD). Refer to the manual to install the driver and software on to the computer.
- 4) The camera is optional and may have different color and shape from the one in the figure, depending on the model purchased.



**Fig.4**

**2.7 Installation of darkfield condensers (optional, may not included in your package)**

Please see section 7 (*Darkfield Condenser Installation and Operation Instructions*)

**2.8 Installation of phase contrast kit (optional, may not included in your package)**

Please see section 8 (*Phase Contrast Kit Installation and Operation Instruction*)

## 3. Operation

### 3.1 Adjusting illumination

- 1) Plug the power cord into the power socket on the microscope and connect it to the power outlet.
- 2) Turn on the power switch.
- 3) Rotate the brightness intensity dial to increase or decrease the brightness of the illuminator.

#### Caution:

A diffusion filter is attached beneath the condenser to get uniform light and protect your eyes from strong LED light when a low power objective applies. The diffusion filter can be swung out to make the view field brighter when observing with a high power objective, such as 100X objective.

### 3.2 Placing specimen

- 1) Place the slide on the mechanical stage.
- 2) Use the slide holder to gently secure the slide.
- 3) Turn the X and Y stage moving knobs to position the specimen in the center of viewing field.

#### Caution:

Be sure not to allow an objective to touch a specimen slide when changing objectives.

### 3.3 Focusing

- 1) With the 10X objective in position, raise the mechanical stage using the coarse focus knob until the specimen is close to the objective.
- 2) Turn the coarse focus knob until the specimen is in focus. Then use the fine focus knob to obtain a sharp image. You may now switch to another magnification objective.
- 3) To get a good focused image, you may need to combine the focus knob adjustment and interpupillary distance adjustment, along with eyepiece diopter adjustment stated in 3.4 and 3.5.



Fig.5

#### Tips:

To prevent your specimen slide from making contact with an objective, turn the 100X objective in position and adjust the thumb screw of focus stop (as shown in **Fig.5**) so that the 100X objective will not contact the specimen while the stage is adjusted to its highest position. Give the stage a tiny extra moving space to ensure the objective can be focused every time.

### 3.4 Adjusting interpupillary distance

While observing with both eyes, hold the left and right eyepiece tubes then swing them around the center axis. The interpupillary distance is correct when the left and right fields of view converge completely into one image.



### 3.5 Adjusting eyepiece diopter

- 1) Using the 10X objective and your right eye only, observe your specimen through the eyepiece and bring it into focus by adjusting the focus knobs.
- 2) Then observe the specimen with your left eye only through the left eyepiece. If the specimen is not in focus, turn the diopter ring on the eyepiece tube until a sharp image is obtained.

### 3.6 Applying the immersion oil

- 1) Rotate the objective nosepiece to seat the observing position between the 40X and 100X objectives as shown in **Fig. 6 (a)**.
- 2) Place a drop of immersion oil on the slide cover as shown in **Fig. 6 (b)**.
- 3) Rotate the objective nosepiece to seat the 100X objective to the observing position until you hear a “click” sound.
- 4) After observing the specimen, use the lens cleaning paper to clean the 100X objective lens gently and the specimen in time.
- 5) If it is hard to clean, you need a little bit alcohol to clean the 100X objective lens and the specimen.



(a)

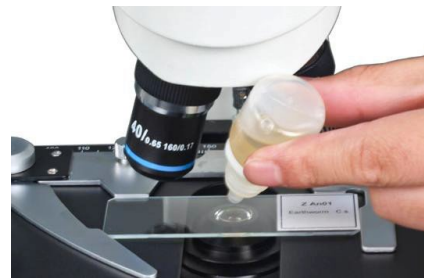

(b)

**Fig.6**

#### Caution (*important*):

- When you use the 100X objective to observe the specimen, you have to finish observing the specimen with the 4X, 10X, 40X objectives.
- When you use the 100X objective to observe the specimen, you have to apply the immersion oil on the top of the slide cover.
- When you apply the immersion oil with the 100X objective, do not let the immersion oil to contact with the dry objective lenses (especially the 40X). If the immersion oil is on the dry objectives lens, please use the lens cleaning paper to clean the objectives lens in time. The oil will damage the dry objective lenses.
- After observing the specimen with the 100X objective, clean the 100X objective lens first.

### 3.7 Adjusting condenser

- 1) Turn the condenser focus knob to raise or lower the condenser.
- 2) The condenser is raised when using high magnification objectives and lowered when using low magnification objectives.

#### Note:

- The centering of the condenser and the light axis of the objective are factory adjusted. Do not attempt to re-adjust.
- The highest position of the condenser has been factory adjusted. Do not attempt to re-adjust.

**3.8 Adjusting iris aperture diaphragm**

Swing the iris diaphragm lever (**Fig.7**) left or right to adjust the aperture size.

**Note:**

The iris diaphragm is designed to adjust the aperture size, not to adjust the brightness although the brightness will be changed when it's adjusted. When aperture is adjusted to smaller size, the contrast will be increased and the depth of field will be increased as well. Turn up the intensity of the light if the image is too dim.

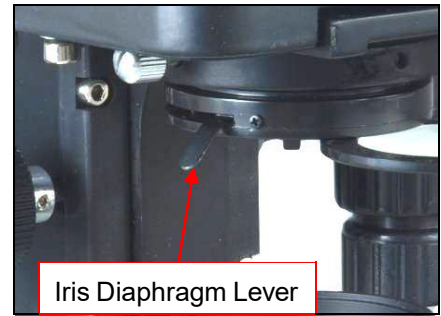

**Fig.7**

**3.9 Adjusting focus knob tension**

The tightness of the focus knob tension has been pre-set at the factory. If the mechanical stage drops by itself, rotate the tension adjustment ring (**Fig.8**) located inside the focus knob on the power switch side until the tension is maintained.

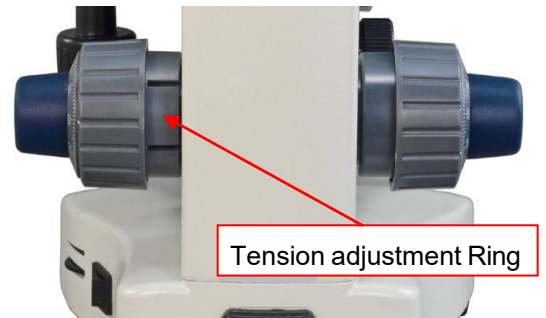

**Fig.8**

**3.10 Camera (optional, may not included in your package)**

- 1) Bring the microscope into focus by following the procedures in **3.3**.
- 2) Install the camera by following the procedures in **2.6**.
- 3) Open image observing software to examine.
- 4) You also can capture images or record live videos through the software, depending on the functions provided by the software.

**Note:**

Please refer to the manuals in the camera's CD for the details of installation and operation of the camera.

**3.11 Darkfield condensers observation (optional, may not included in your package)**

Please see section 7 (*Darkfield Condenser Installation and Operation Instructions*)

**3.12 Phase contrast kit observation (optional, may not included in your package)**

Please see section 8 (*Phase Contrast Kit Installation and Operation Instruction*)

## 4. Specifications







### General

<b>Model</b>	<b>M8211 series</b>
Total Magnification	40X, 80X, 100X, 200X, 400X, 800X, 1000X, 2000X
Viewing Head	30° inclined, 360° swiveling siedentopf binocular viewing head Interpupillary distance 1-7/8" ~ 2-15/16" (48mm ~ 75mm) Adjustable diopter on left eyepiece tubes
Eyepieces	1 pair of WF10X/18 1 pair of WF20X
Objective Tube Length	160mm
Nosepiece	Reversed revolving quadruple
Objectives	Achromatic 4X, 10X, 40X(spring), 100X(spring, oil)
Condenser	Abbe, NA=1.25, w/ iris aperture diaphragm and filter holder Rack and pinion focus adjustment
Focus Mechanism	Coaxial coarse and fine focusing knobs on both sides w/ stop
Stage	Double layer mechanical stage Dimension: 5-1/2" x 4-1/4" (140mm x 110mm) Translation range: 3" x 1-9/16" (78mm x 40mm)
Illumination	Transmitted, LED, variable intensity
Darkfield Condensers ( <i>optional</i> )	Refer to the darkfield condensers specifications
Phase Contrast Kit ( <i>optional</i> )	Refer to the phase contrast kit specification
Cameras ( <i>optional</i> )	Refer to the cameras specifications
Carrying Case ( <i>optional</i> )	Net weight: 10 lbs 8 oz (4.75 kg) Size: 16-1/2" x 12-1/2"x 13-3/8" (42cm x 32cm x 34cm)
Power Supply	AC 110V~240V, 50/60HZ (US and Canada plug)
Dimension	12-3/16" x 8" x 15-3/8" (31cm x 20.3cm x 39cm)
Net weight	11 lb 3.5 oz (5.09 kg)



## 5. Optional Parts

(The optional parts may be included in some models or sold separately.)



### 1) Cameras

	Model	Sensor	Resolution	Operating System	Software	
	A1502	CMOS USB2.0	640 x 480 (0.3MP)	MS Windows Mac OS X 10.6-10.8	Included	
	A3513U		1280 x 1024 (1.3MP)			
	A3520U		1600 x 1200 (2.0MP)			
	A3530U		2048 x 1536 (3.0MP)			
	A3550U		2592 x 1944 (5.0MP)			
	A3590U		3488x2616 (9.0MP)			
	A35100U		3584 x 2748 (10.MP)	MS Windows Mac OS 10.8 and up Linux (2.6 or above)		
	A35140U		4096 x 3288 (14.0MP)			
	A3550U3	CMOS USB3.0	2560 x 1922 (5.0MP)			
	A35100U3		3584 x 2746 (10.0MP)			
	A35140U3		4096 x 3286 (14.0MP)			
	A35180U3		4912 x 3684 (18.0MP)			
	CPZJ-150R	CMOS	2560 x 1920 (5.0MP)	N/A		N/A

## 2) Darkfield Condensers

	Model	Darkfield Condenser	Numerical Aperture	Objective	Mounting Size(diameter)
	A191	Dry	0.7-0.9	-	37mm
	A191BD	Oil	1.36-1.25	-	37mm
	A191BOIL (new design)	Oil	1.36-1.25	Plan 100X/1.25 oil-0.5 160/0.17(spring), with iris diaphragm	37mm

## 3) Carrying Case

	Model	Dimension	Net Weight
	A187V	9-7/8" x 11" x 18-1/2" (25cm x 28cm x 47cm)	2 lb 6 oz (1.1 kg)
	A185A	18-1/8" x 13" x 13-3/8" 46cm x 33cm x 34cm	10 lb 14 oz (4.93 kg)

#### 4) Phase Contrast Kit

	Model	Objectives	Condenser	Annular Ring Plates	Centering Telescope
	A1PHB1	Plan achromatic 10X with built-in phase plate Plan achromatic 20X with built-in phase plate Plan achromatic 40X with built-in phase plate, spring Plan achromatic 100X with built-in phase plate, spring, oil	NA 1.25	Five positions: 10 for 10X phase contrast objective 20 for 20X phase contrast objective 40 for 40X phase contrast objective 100 for 100X phase contrast objective B for bright field observation, with iris diaphragm	focusing adjustable
	A1PHB3	Achromatic 10X with built-in phase plate Achromatic 20X with built-in phase plate Achromatic 40X with built-in phase plate, spring Achromatic 100X with built-in phase plate, spring, oil		Five positions: 10 for 10X phase contrast objective 20 for 20X phase contrast objective 40 for 40X phase contrast objective 100 for 100X phase contrast objective B for bright field observation, with iris diaphragm	
	A1PHC2	Achromatic plan 10X with built-in phase plate Achromatic plan 40X with built-in phase plate, spring		Four positions: 10/20 for 10X/20X phase contrast objective 40 for 40X phase contrast objective DF for darkfield observation BF for brightfield observation, with iris diaphragm	
	A1PHD	Achromatic 10X with built-in phase plate Achromatic 40X with built-in phase plate, spring Achromatic 100X with built-in phase plate, spring, oil		10 for 10X phase contrast objective 40 for 40X phase contrast objective 100 for 100x phase contrast objective	

## 6. Troubleshooting Guide

### GENERAL PROBLEMS

Problem	Cause	Solution
Lamp does not light when switched on	No electrical power	Check power cord connection
	LED or power unit dead	Contact seller for service
	Fuse blown out	Replace fuse
Darkness at the periphery or uneven brightness in the field of view	Revolving nosepiece not in click stop position	Revolve the nosepiece to click-stop position by swinging the objective correctly into the optical path
Dirt or dust on the view	Dirt or dust on the eyepiece, condenser, objective, collector lens or specimen	Clean the lens with a lens cleaning paper
Poor image quality or not able to get focused image	No slide cover attached to the slide	Attach a 0.17mm slide cover
	Slide cover is too thick or thin	Use a slide cover of the appropriate thickness (0.17mm)
	Slide may be upside down (specimen at the bottom)	Turn slide over so the cover-glass faces up
	Diopter adjustment is not set properly	Readjust the diopter settings
	Immersion oil is on a dry objective (especially the 40X)	Check the objectives, clean if necessary
	No immersion oil used with 100x objective	Use immersion oil
	Air bubbles in immersion oil	Remove bubbles
	Condenser aperture is closed or open too much	Open or close properly
	Condenser is positioned too low	Position the condenser upward
	Specimen rises from stage surface	Secure the specimen in the slide holder
	Revolving nosepiece is not in the click-stop position	Revolve the nosepiece to the click-stop position
	Lamp intensity is too high or low	Adjust the light intensity by rotating the intensity control dial

Slippage of focus when using the coarse focusing knob Fine focus is ineffective	Tension adjustment is set too low	Increase the tension on the focusing knobs
	Tension adjustment is set too high	Loosen the tension on the focusing knobs

**DARKFIELD PROBLEMS**

<b>Problem</b>	<b>Cause</b>	<b>Solution</b>
It's totally dark in the viewing field	The light is not on	Turn on the light
	<i>(A191BOIL only)</i> There is no oil in between the condenser top lens and slide	Place a drop of oil on the top lens of condenser and let it contact the underside of slide
	<i>(A191BOIL only)</i> The built-in iris diaphragm of 100X objective is not in proper position	Adjust the iris diaphragm ring on the objective
	The condenser is not in the right position	Lower or raise the condenser slightly to the position that the specimen is the brightest. <i>(A191BOIL only)</i> Make sure the oil contact the bottom of the slide and the top of the condenser during the adjustment.
The illumination is insufficient or too bright	The intensity of lamp is too low	Adjust the intensity dial to increase the brightness
	The condenser is not in the right position	Lower or raise the condenser slightly to the position that the specimen is the brightest. <i>(A191BOIL only)</i> Make sure the oil contact the bottom of the slide and the top of the condenser during the adjustment.
	The condenser is not centered properly	Adjust the translational centering screws to center the condenser
	<i>(A191BOIL only)</i> The built-in iris diaphragm of 100X objective is not in proper position	Turn the iris diaphragm ring on the objective
Image of the specimen is not clear and lacking in sufficient contrast	The specimen is not suitable for darkfield observation	Change to brightfield or phase contrast
	<i>(A191BOIL only)</i> The built-in iris diaphragm of 100X objective is not in proper position	Turn the iris diaphragm ring on the objective
	The condenser is not in the right position	Lower or raise the condenser slightly to the position that the specimen is the brightest. <i>(A191BOIL only)</i> Make sure the oil contact the bottom of the slide and the top of the condenser during the adjustment.



## 7. Darkfield Condenser Installation and Operation Instructions

### 7.1 Dry darkfield condenser of A191

- 1) Mounting the dry darkfield condenser
  - Loosen the condenser lock thumb screw on the condenser holder and remove the brightfield condenser.
  - Install the dry darkfield condenser and tighten the condenser lock thumb screw on the condenser holder (see **Fig. 9**).
- 2) Centering the dry darkfield condenser
  - Turn the 4X objective to the light path.
  - Turn the condenser focus knob to lower the condenser till a dark spot showed in the viewing field as shown in **Fig. 10 (a)**.
  - Turn the condenser translational centering screws to move the dark spot to the center as shown in **Fig. 10 (b)**.
- 3) Place the slide on the stage.
- 4) Raise the condenser all the way to the top and lower it a little bit.
- 5) Following the procedures in this manual to focus and observe.
- 6) Move the condenser up or down slightly to get the best darkfield viewing.

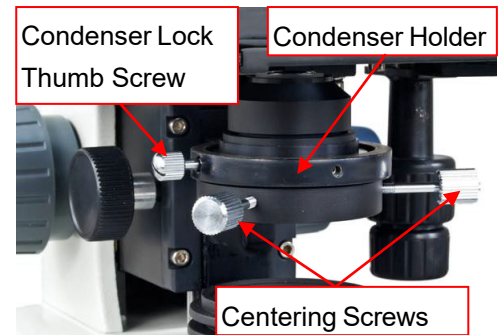
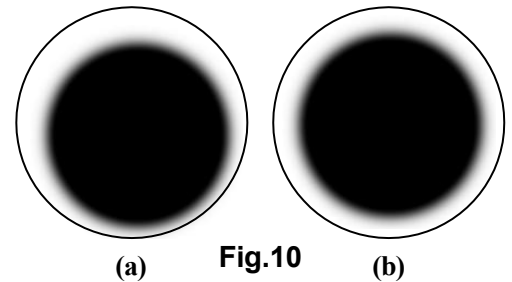

Fig.9



(a) Fig.10 (b)

#### Note :

- The dry darkfield condenser is used with the dry objectives only.
- The dry darkfield condenser works with the 4X, 10X, 40X objectives.
- The dry darkfield condenser won't work with the 100X oil immersion objective.

### 7.2 Oil darkfield condenser of A191BOIL

- 1) Mounting the oil darkfield condensers
  - Loosen the condenser lock thumb screw on the condenser holder and remove the brightfield condenser.
  - Install the oil darkfield condensers and tighten the condenser lock thumb screw on the condenser holder (see **Fig. 11**).
- 2) Centering the oil darkfield condensers
  - Turn the 40X objective to the light path.
  - Turn the condenser focus knob to slowly lower and raise the condenser till a dark spot showed in the viewing field as shown in **Fig. 12 (a)**.
  - Turn the condenser translational centering screws to move the dark spot to the center as shown in **Fig. 12 (b)**.

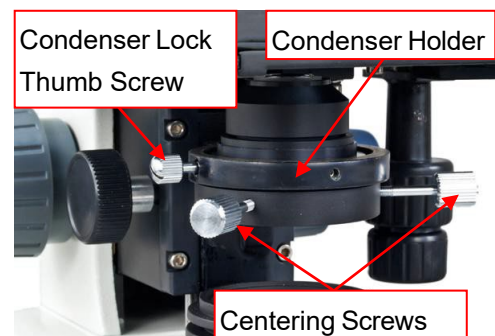
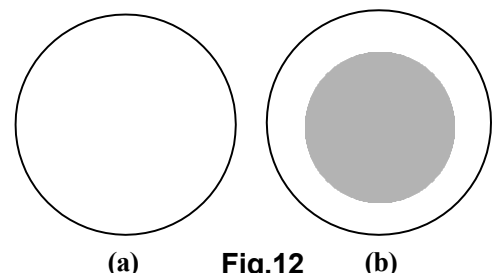

Fig.11



(a) Fig.12 (b)

- 3) Raise the condenser till the top lens is close to the opening of stage. Place a drop of immersion oil on the top of the lens of the condenser.
- 4) Place the slide on the stage. Raise the condenser and let the oil drop contact the bottom of the slide. If air bubbles exist in the oil, clean the oil from the condenser lens and bottom of slide with a camera cleaning paper and repeat the procedures.
- 5) Follow the procedures in this manual to bring the sample on slide in focus and observe.
- 6) When using the 100X oil darkfield objective, you will need to drop the immersion oil and adjust the iris ring (**Fig. 13**) to get proper brightness and contrast of view field.



Fig.13

**Note :**

- The condenser won't work well if no oil drop applied on the condenser

## 8. Phase Contrast Kit Installation and Operation Instruction

### 8.1 Phase contrast kits of A1PHB1 or A1PHB3:

- 1) Mounting the phase contrast objectives
  - a. Take off all the objectives from the nosepiece.
  - b. Install the phase contrast objectives onto the nosepiece following the steps in 2.3.
- 2) Mounting the phase contrast condenser/annular ring disk
  - a. Rotate the nosepiece and set the 4X objective in position.
  - b. Turn the coarse focus knob to raise the mechanical stage to the highest position without contacting the 4X objective.
  - c. Turn the condenser control knob to raise the condenser to the highest position.
  - d. Loosen the light collector and take it off.
  - e. Loosen the condenser lock thumb screw, pull down the condenser and take it off.
  - f. Insert the condenser/annular ring disk into the condenser holder, and tighten the thumb screw.
  - g. Insert the light collector back onto the base and turn until it's tightened.
  - h. Re-adjust the condenser height to its normal position.
  - i. Re-adjust the mechanical stage height to its normal position.



Fig.14

**Note:**

- When raising the mechanical stage, do not make contact with the objective.
- 3) Turn the desired objective into light path.
  - 4) Turn the annular ring disk to put the corresponding ring into light path, i.e. if you are using the **20X** phase contrast objective, you should turn the disk at **20** as shown in **Fig. 14**.



Fig.15

- 5) Centering the annular ring.
  - a. Remove one eyepiece from the microscope eyepiece tube and insert the centering telescope as shown in **Fig. 15**.
  - b. Observe from the telescope. The bright ring and dark ring should be coincided with each other as shown in **Fig.16 (d)**.
  - c. If the ring images are not clear, turn the top of telescope until both ring images are in focus.
  - d. If the bright ring is still obscure as in **Fig.16 (b)**, adjust the condenser focus knob.
  - e. If the two ring images are not coincided as shown in **Fig.16 (c)**, hold the ring plate from the bottom of the annular ring disk and adjust its position until two ring images are coincided.

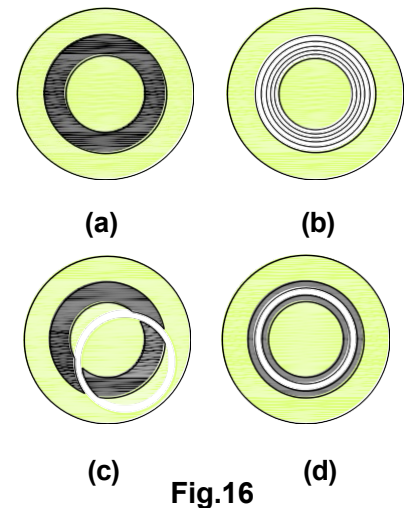

- f. Remove the centering telescope and replace it with the eyepiece.
- g. Put the specimen on the stage and adjust the illumination, focusing, etc following the instructions in this manual.

**Note:**

- The phase contrast condenser will be working as a conventional Abbe condenser if the annular ring disk being put at **B** position.

6) Performing the phase contrast observation.

After centering the condenser ring plate, perform the phase contrast observation the same way as a normal bright field microscope.

**Note:**

- When change to another phase contrast objective and corresponding condenser ring plate, the focusing and centering of bright ring and dark ring should be repeated following the procedures from **5)-b** to **5)-f**.

## 8.2 Phase contrast kit of A1PHC2:

- 1) Mounting the phase contrast kit
  - a. Replace the brightfield objective(s) on nosepiece with the phase contrast objective(s).
  - b. Rotate the nosepiece and set the 4X objective in position.
  - c. Turn the coarse focus knob to raise the mechanical stage to the highest position without contacting the 4X objective.
  - d. Turn the condenser control knob to raise the condenser to the highest position.
  - e. Loosen the condenser lock thumb screw (**Fig. 17**), pull down the condenser and take it off.
  - f. Insert the condenser/annular ring disk into the condenser holder, and tighten the thumb screw (**Fig. 17**).
  - g. Re-adjust the condenser height to its normal position.
  - h. Re-adjust the mechanical stage height to its normal position.

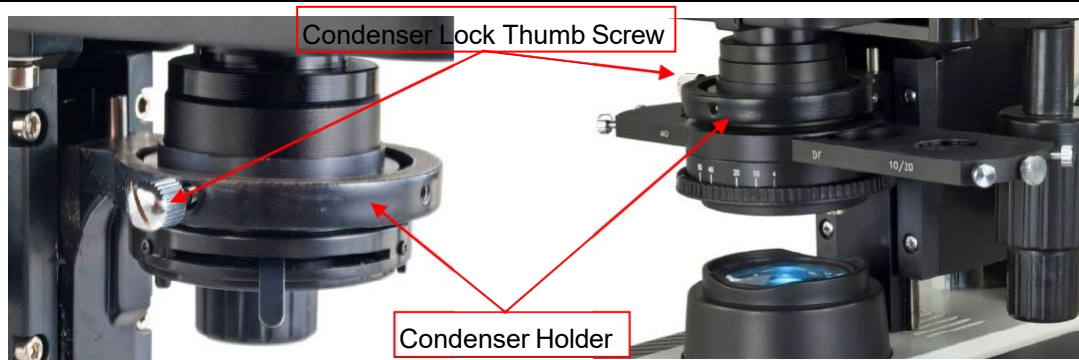

Fig.17

**Note:**

- There are 2 phase contrast objectives: 10X and 40X, and there are 2 condenser annular rings on the sliding selector: 10/20 and 40. The corresponding objective, annular ring and iris diagram must work together, i.e., **40X** phase contrast objective must work with **40** condenser annular ring and iris diagram **40** and so on.

## 2) Centering the condenser ring plate

- Connect the power cord to the microscope and insert the plug into a power outlet.
- Turn the desired phase contrast objective into light path. Slide the sliding selector to the corresponding annular ring and turn iris diagram corresponding to the phase contrast objective in the light path.
- Remove one eyepiece from the microscope eyepiece tube and insert the centering telescope.
- Observe from the telescope. The bright ring and dark ring should be coincided with each other as shown in **Fig. 18 (d)**.
- If the ring images are not clear, turn the top of telescope until both ring images are in focus.
- If the bright ring is still obscure as in **Fig. 18 (b)**, adjust the condenser focusing knob.
- If the two ring images are not coincided as shown in **Fig. 18 (c)**, adjust the two centering screws on the phase contrast condenser.
- Remove the centering telescope and replace the eyepiece.

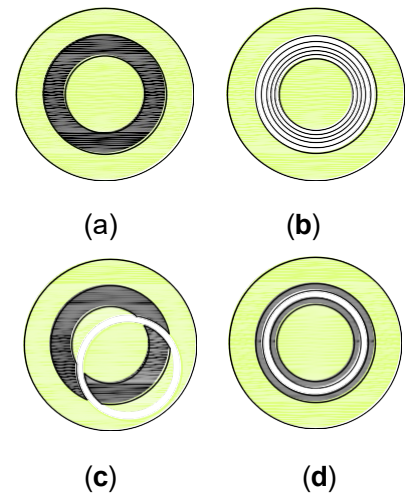

Fig. 18

## 3) Performing the phase contrast observation

Perform the phase contrast observation the same way as a normal brightfield microscope.

**Note:**

- When change to another phase contrast objective and corresponding condenser ring plate, the focusing and centering of bright ring and dark ring should be repeated following the procedures from 2)-b to 2)-h.

## 4) Performing the darkfield observation

- Slide the sliding selector to the darkfield position, the condenser will work as a darkfield condenser.
- Turn iris diagram to 100.
- Perform the darkfield observation the same way as a normal brightfield microscope.



**Note :**

- The darkfield condenser works with the 4X, 10X, 40X regular brightfield objectives.
- The darkfield condenser does not work with the regular 100X oil immersion objective.
- The darkfield condenser works with the 100X oil darkfield objective with iris diaphragm AJ100PR (***sold separately***).
- (***optional***) When using the 100X oil darkfield objective, you will need to drop the immersion oil on the top of the condenser & on the top of the specimen, and adjust the iris ring (***Fig. 19***) to get proper brightness and contrast of view field. The condenser does not work well if no oil drop applied on the condenser.
- (***optional***) If air bubbles exist in the oil, clean the oil from the top of the condenser, the top and bottom of slide with a lens cleaning paper.
- (***optional***) When you apply the immersion oil with the 100X objective, do not let the immersion oil to contact with the dry objective lenses (especially the 40X). If the immersion oil is on the dry objectives lens, please use the lens cleaning paper to clean the objectives lens in time. The oil will damage the dry objective lenses.
- (***optional***) After observing the specimen with the 100X objective, use the lens cleaning paper to gently clean the 100X objective lens, oil darkfield condenser and the specimen in time.
- (***optional***) If it is hard to clean, you need a little bit alcohol to clean the 100X objective lens, oil darkfield condenser and the specimen.

**Fig. 19****8.3 Phase contrast kit of A1PHD:**

- 1) Mounting the phase contrast kit
  - a. Replace the bright field objective(s) on nosepiece with the phase contrast objective(s)
  - b. Thread the condenser ring plate onto the condenser as shown in ***Fig.20***.
  - c. Loosen the condenser lock thumb screw as shown in ***Fig. 23***; take off the original condenser from the holder.
  - d. Insert the phase contrast condenser into the condenser holder as shown in ***Fig. 21***; tighten the condenser lock thumb screw.

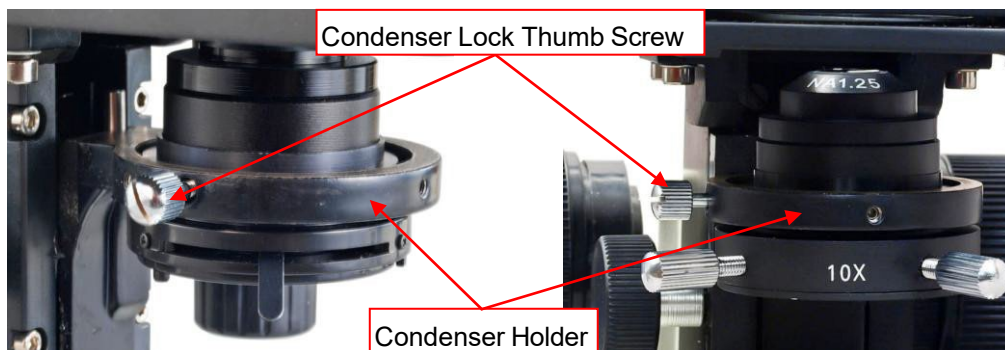
**Fig.20****Fig.21**

**Note:**

There are 3 phase contrast objectives: 10X, 40X and 100X, and there are 3 condenser ring plates: 10X, 40X and 100X. The corresponding objective and ring plate must work together, i.e. **10X** phase contrast objective must work with **10X** condenser ring plate, and so on.

## 2) Centering the condenser ring plate

- a. Connect the power cord to the microscope and insert the plug into a power outlet.
- b. Turn the desired phase contrast objective into light path.
- c. Choose the ring plate that corresponding to the phase contrast objective in light path and screw it on the condenser.
- d. Replace the bright field condenser with the phase contrast condenser with ring plate on.
- e. Remove one eyepiece from the microscope eyepiece tube and insert the centering telescope.
- f. Turn the light of microscope on and observe from the telescope.
- g. Turn the top of the telescope (**Fig.23**) until the dark ring image is in focus. If the dark ring is hard to find, put a normal white print paper on the stage and under the objective then you will see the dark ring as shown in **Fig.22 (a)**.
- h. If the bright ring is still obscure as in **Fig.22 (b)**, raise or lower the condenser by adjusting the condenser focusing knob (or the microscope focusing knob if necessary) till the bright ring is in focus and the dark ring is visible.
- i. If the two ring images are not coincided as shown in **Fig.22 (c)**, adjust the two centering screws on the condenser ring plate till the two rings are coincided with each other as shown in **Fig.22 (d)**.
- j. Remove the centering telescope and replace it with the eyepiece.

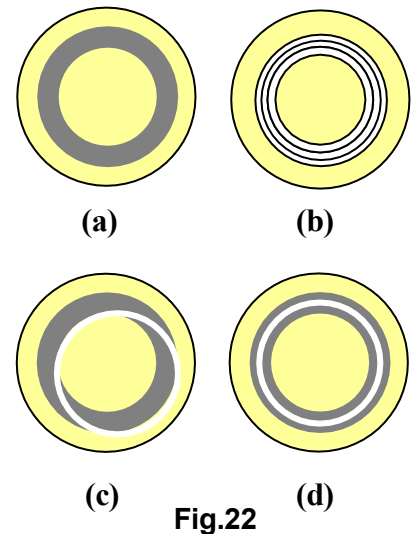

Fig.22

## 3) Performing the phase contrast observation

After you center the ring plate, you can perform the phase contrast observation the same way as a normal bright field microscope.

**Note:**

When change to another phase contrast objective and corresponding condenser ring plate, the focusing and centering of bright ring and dark ring should be repeated following the procedures from **2)-b to 2)-h**.

**Tips:**

- Make the illumination as bright as possible.
- The thinner the specimen, the better the image.



Fig.23