

**ue aw wh ph ew oe bingo!**

**ue**

**aw**

**wh**

**ph**

**ew**

**oe**

**ue aw wh ph ew oe bingo!**

**aw**

**ue**

**oe**

**ew**

**wh**

**ph**

ue aw wh ph ew oe bingo!

ew

wh

aw

ph

ue

oe

**ue aw wh ph ew oe bingo!**

**ph**

**oe**

**aw**

**ue**

**ew**

**wh**

# ue aw wh ph ew oe bingo!

Picture cards:  
cut these out for children to match to  
the letter boards.

(glue)

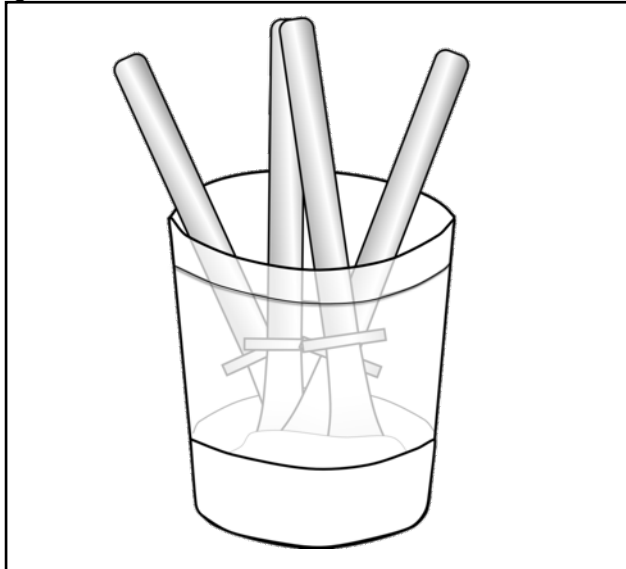

(saw)

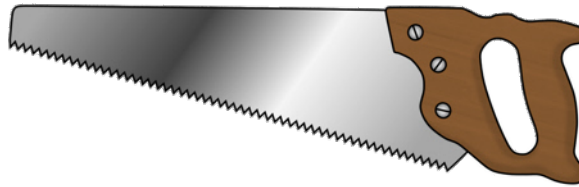

(wheel)

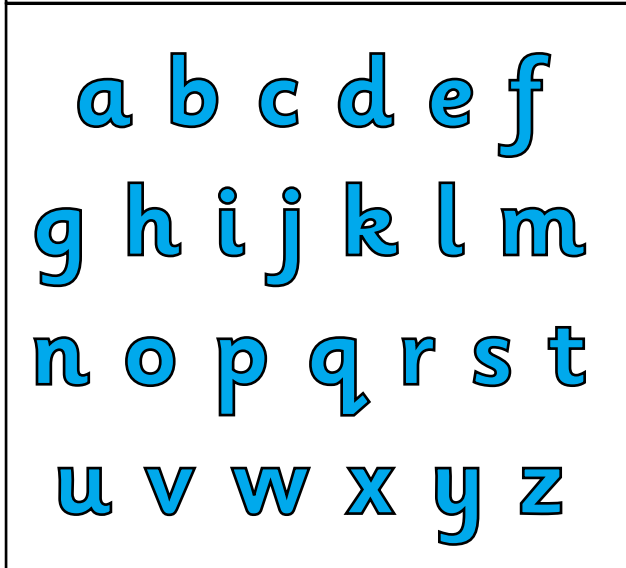

(alphabet)

(screw)

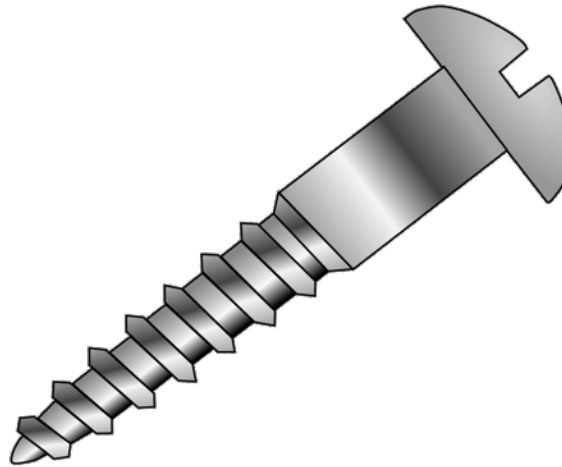

(hoe)

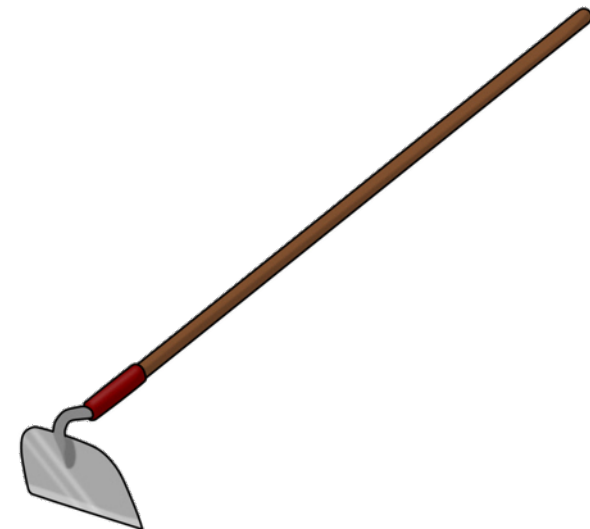

# ue aw wh ph ew oe bingo!

**Picture cards:**  
cut these out for children to match to  
the letter boards.

(blue)

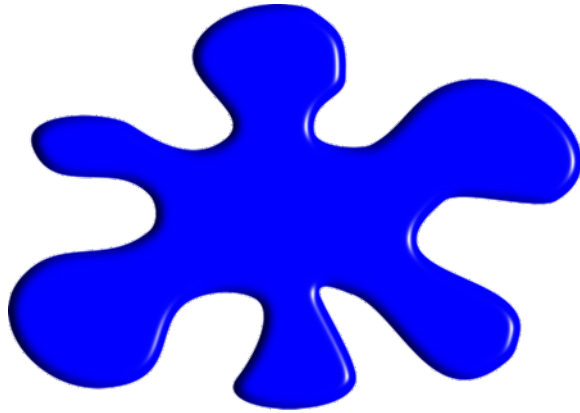

(claw)



(wheat)

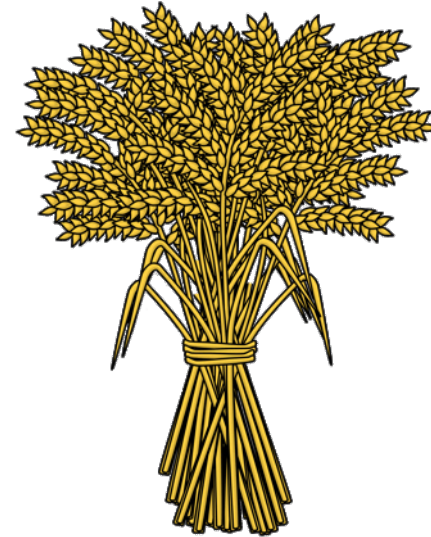

(phone)



(chew)

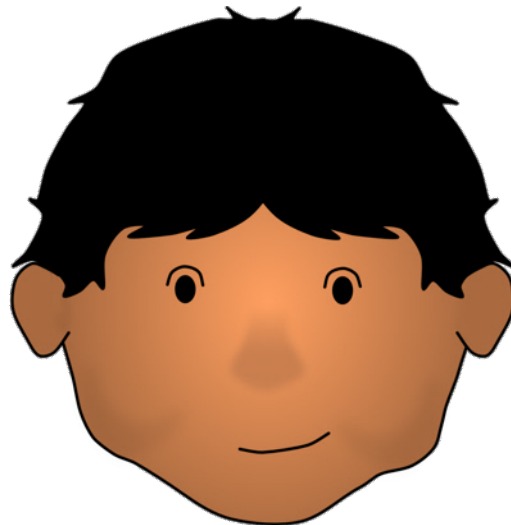

(toe)

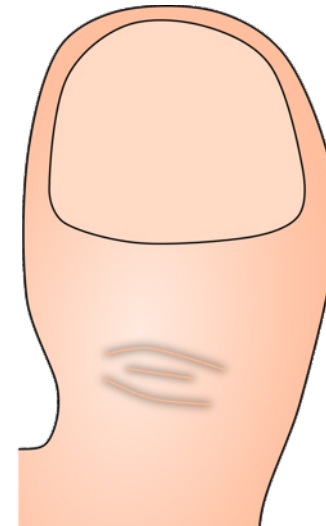

# ue aw wh ph ew oe bingo!

Picture cards:  
cut these out for children to match to  
the letter boards.

(tissue)

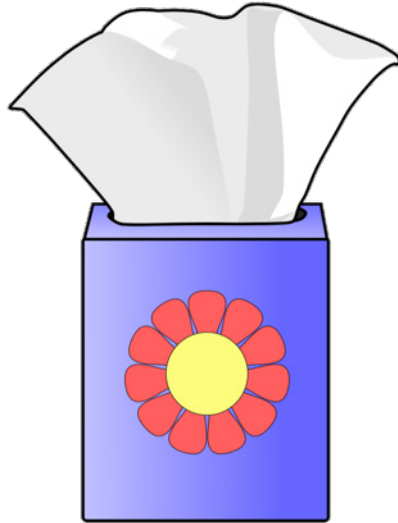

(paw)



(whistle)

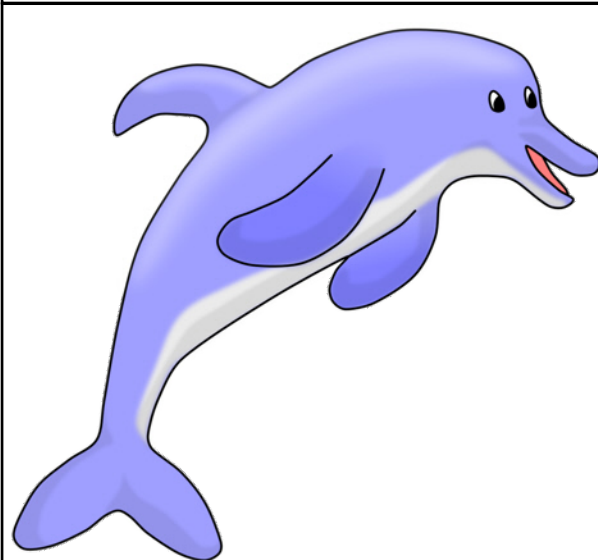
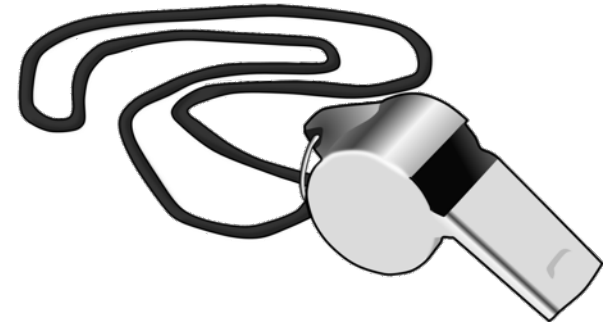

(dolphin)

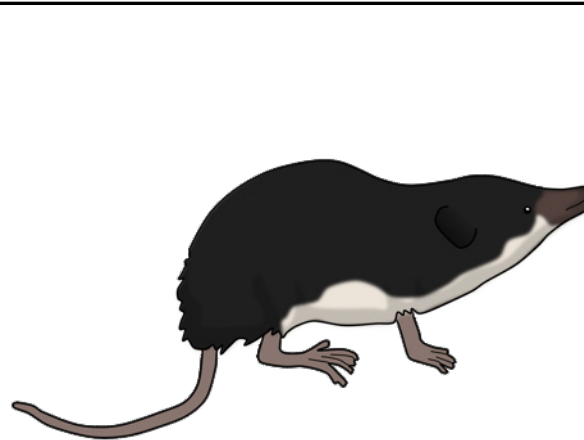

(shrew)

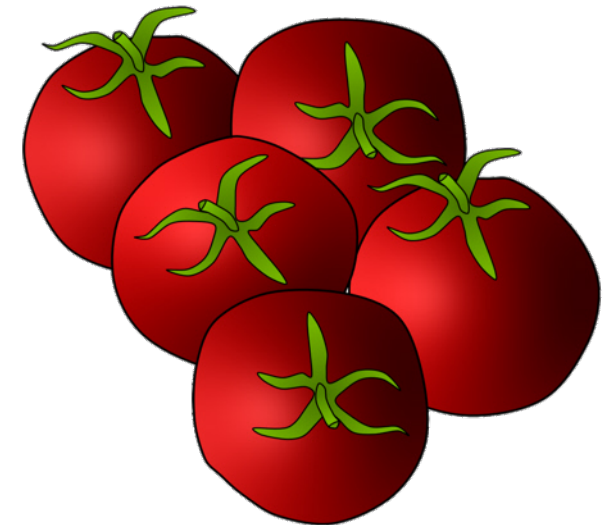

(tomatoes)

# ue aw wh ph ew oe bingo!

Picture cards:  
cut these out for children to match to  
the letter boards.

(clue)

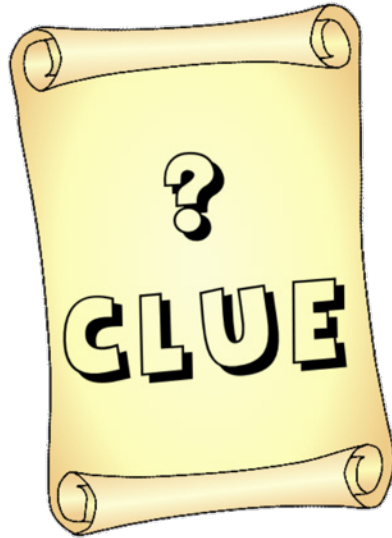

(straw)

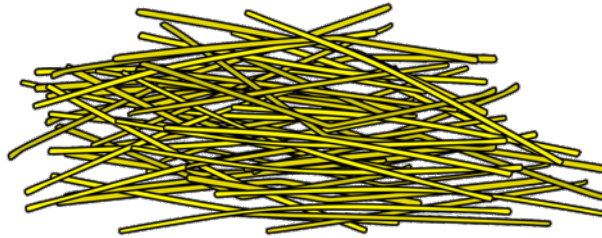

(whale)

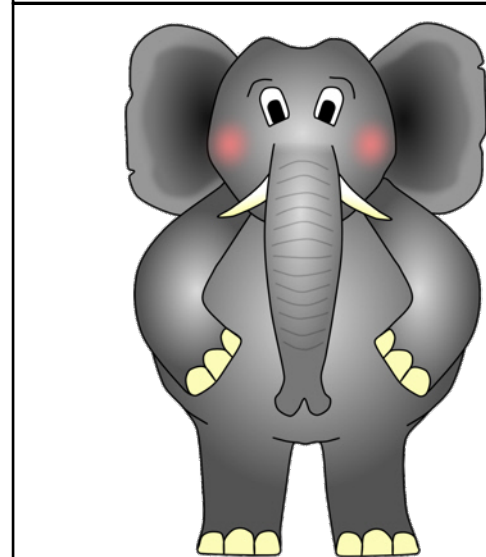
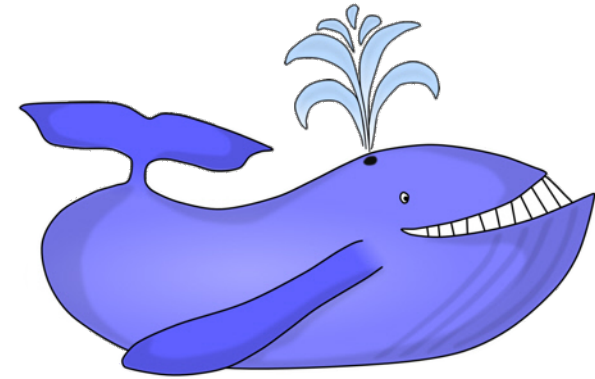

(elephant)

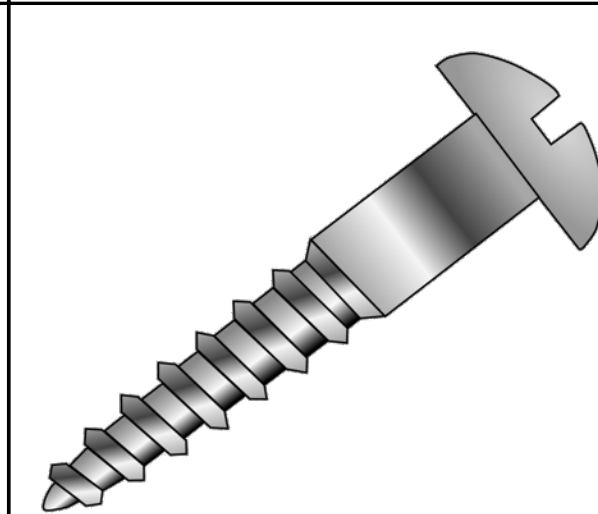

(screw)



(oboe)



ue aw wh ph ew oe bingo!

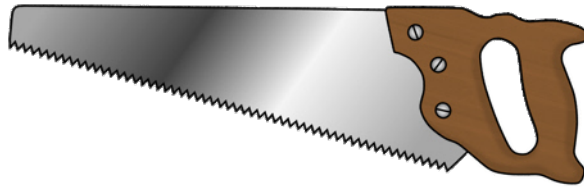
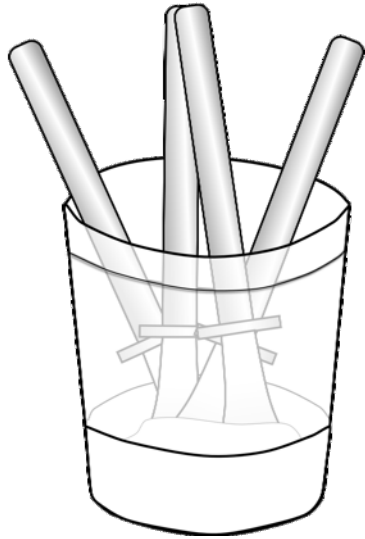

a b c d e f  
g h i j k l m  
n o p q r s t  
u v w x y z

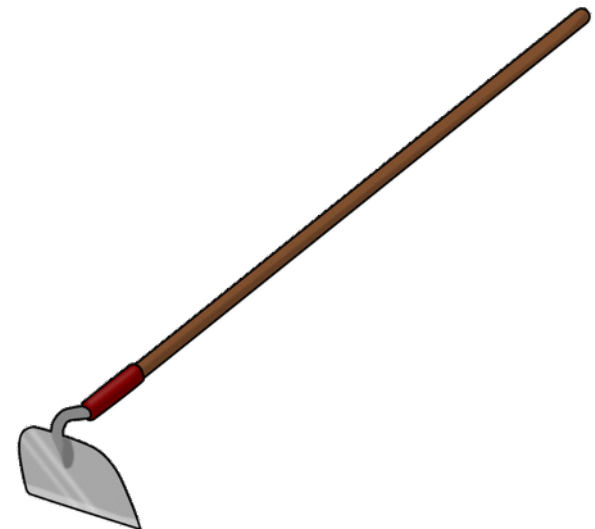
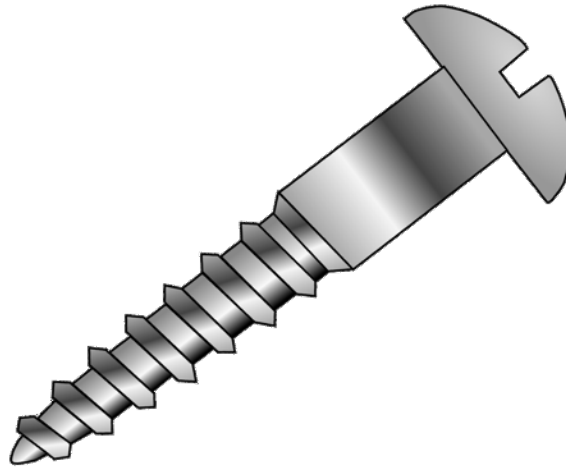

ue aw wh ph ew oe bingo!

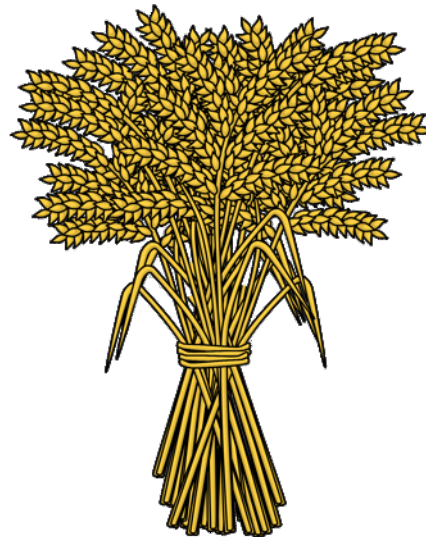
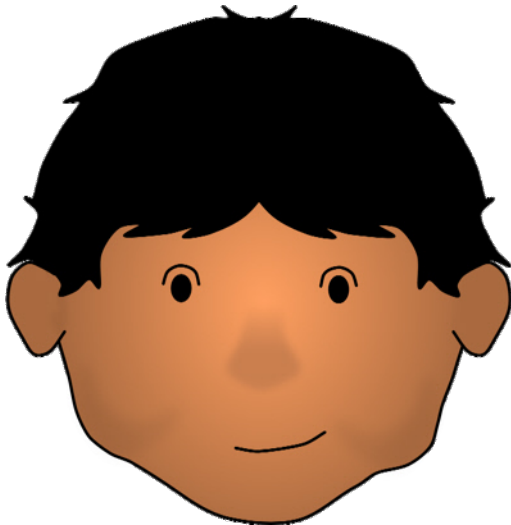
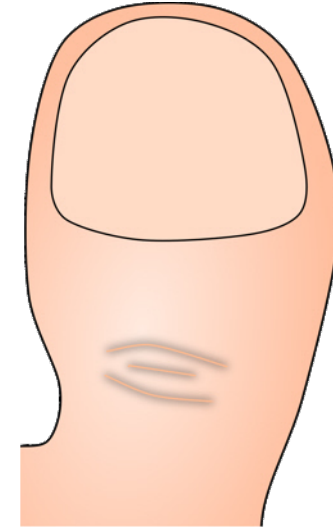
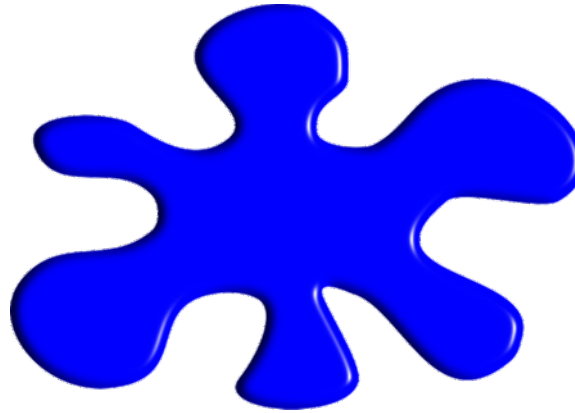

ue aw wh ph ew oe bingo!

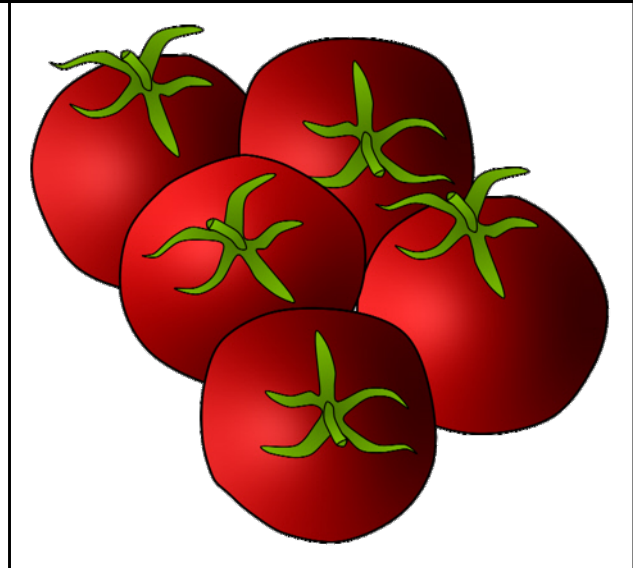
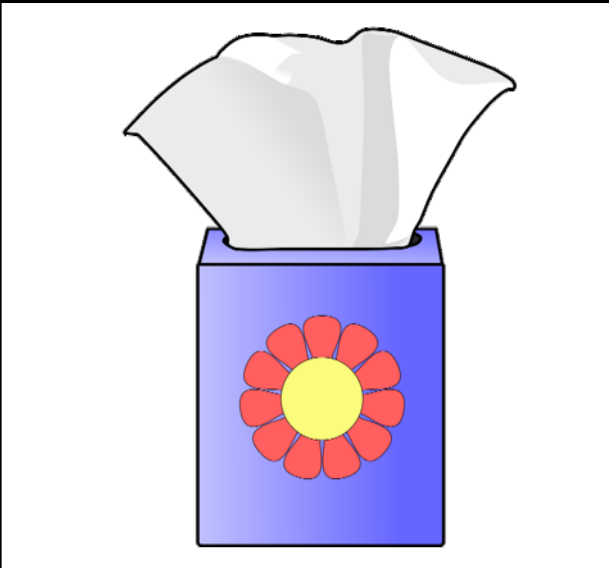
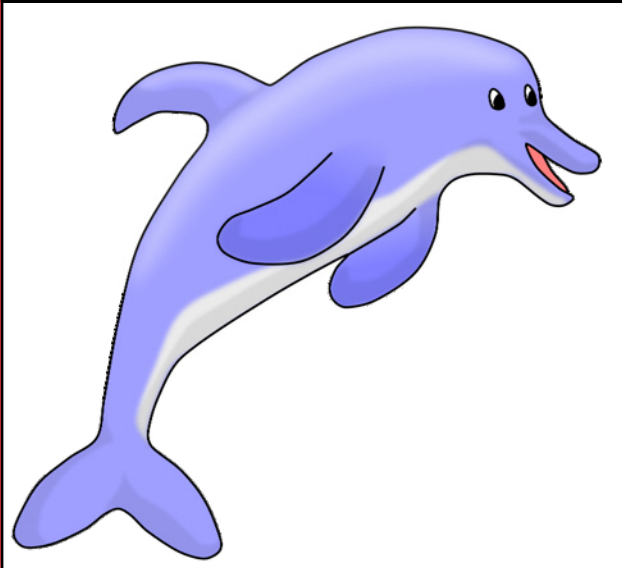
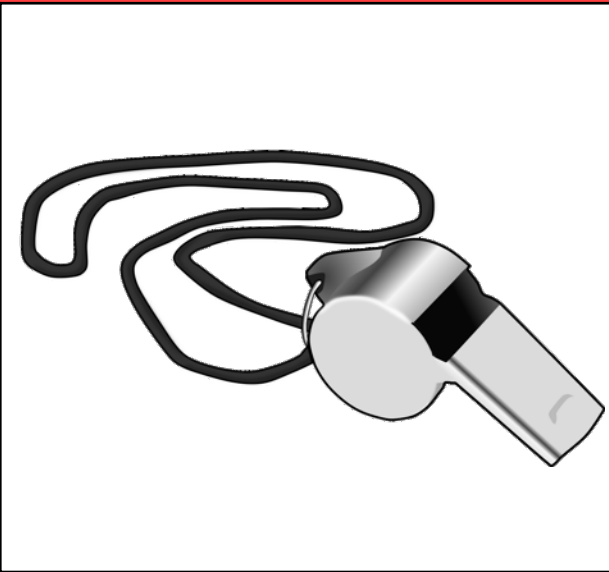

ue aw wh ph ew oe bingo!

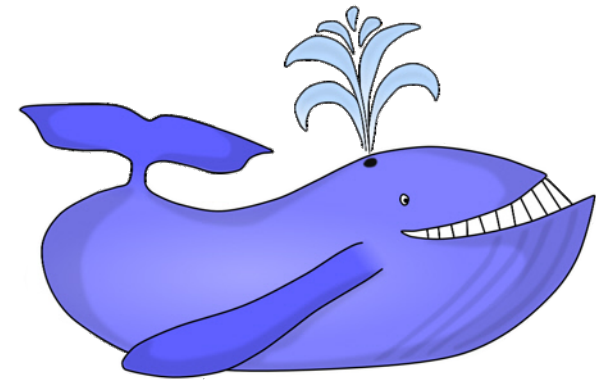
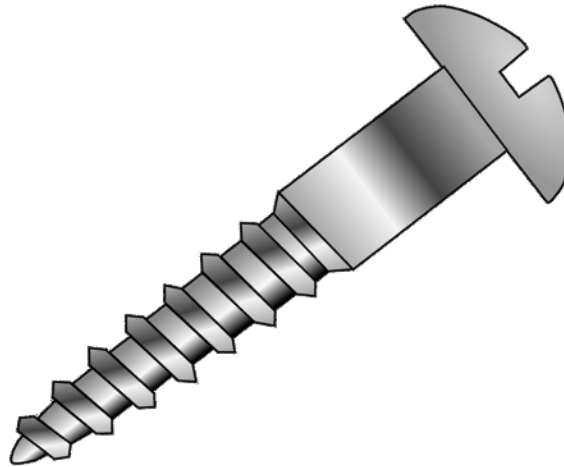
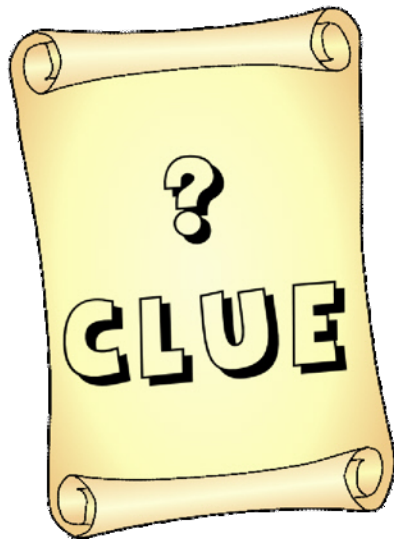
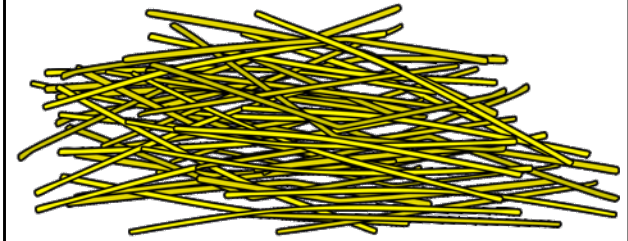
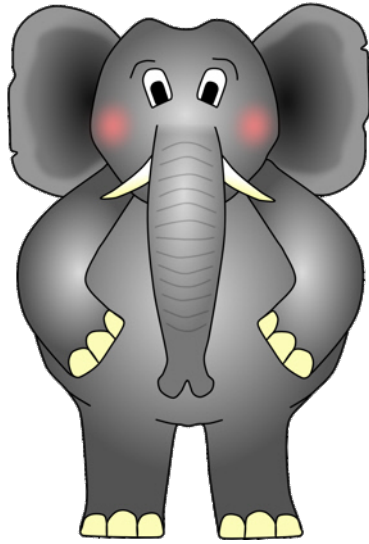

**ue aw wh ph ew oe bingo!**

**ue**

**aw**

**wh**

**ph**

**ew**

**oe**