

Old

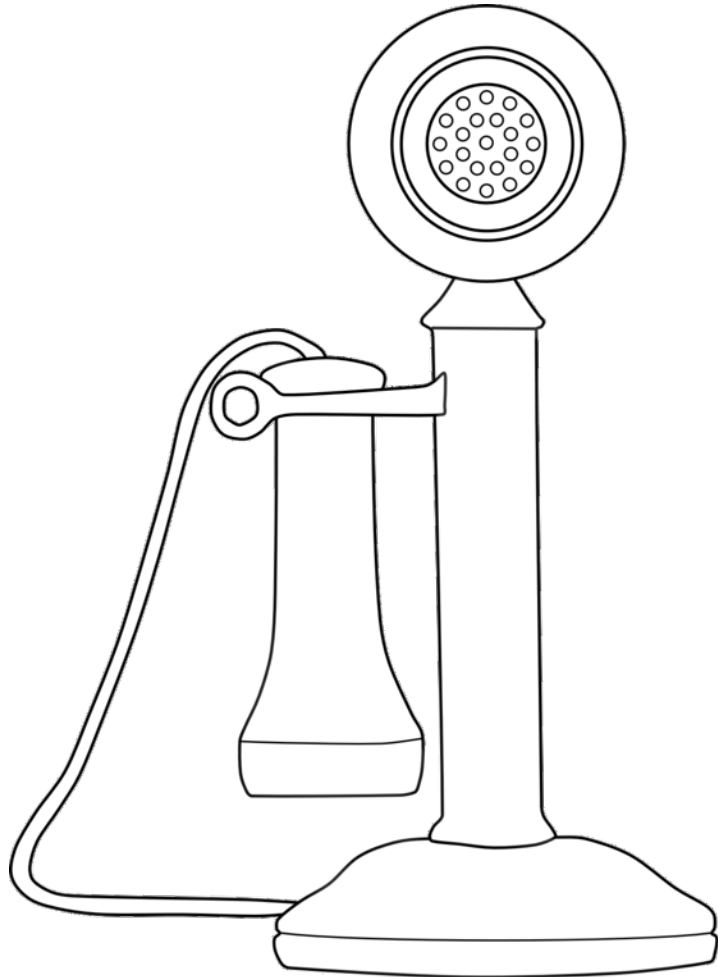

telephone

New

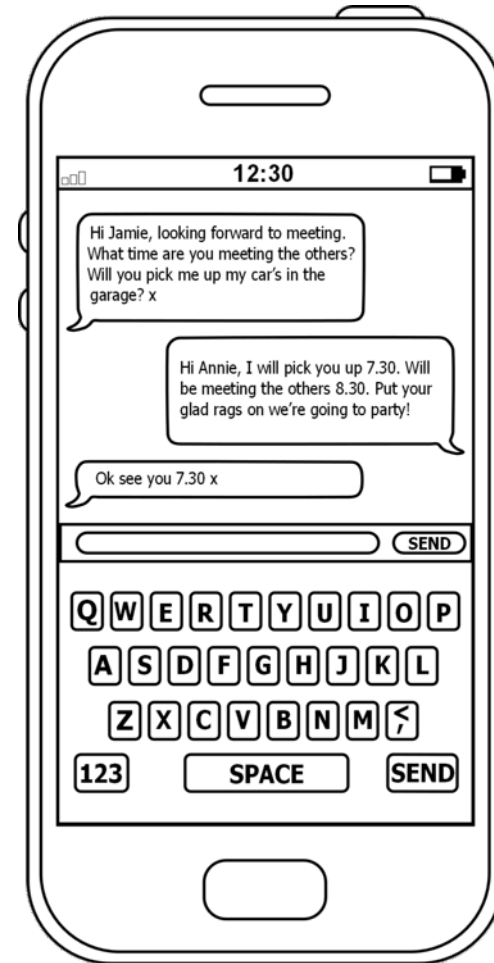

smartphone

Old

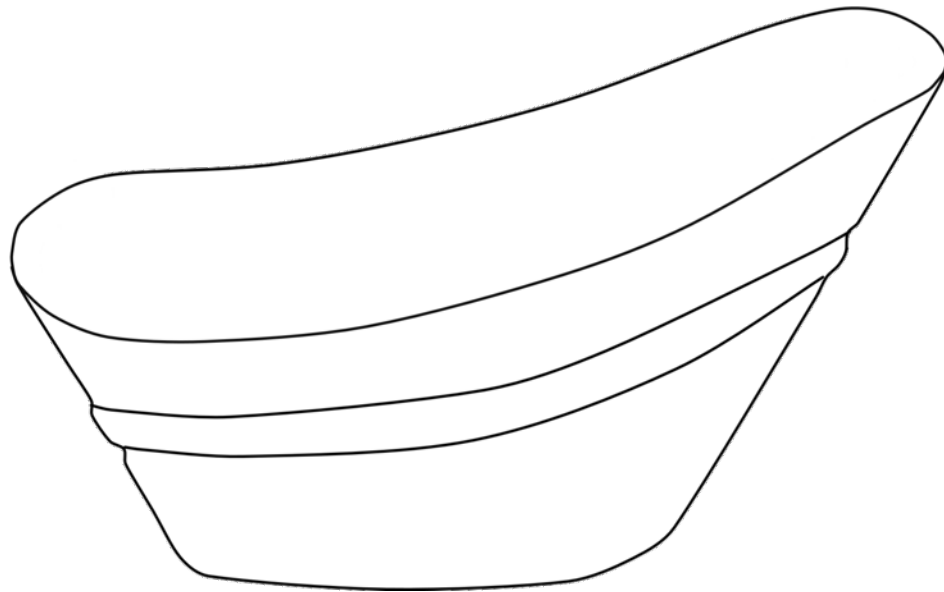

tin bath

New

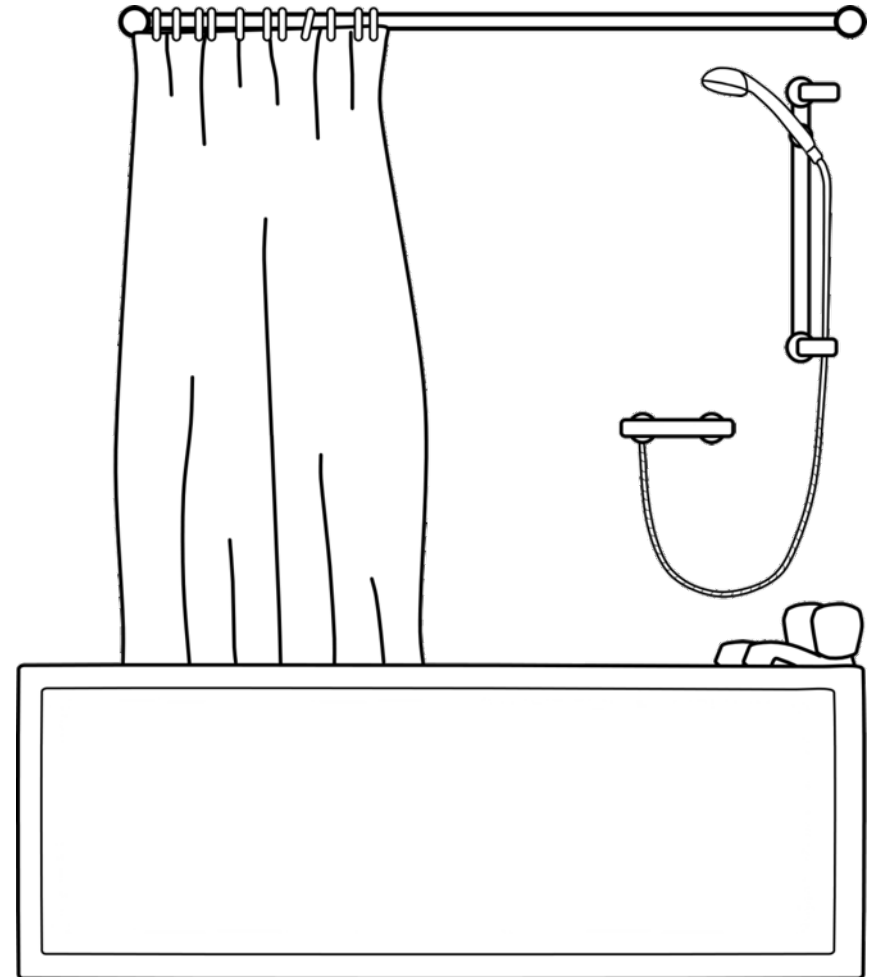

bath and shower

Old

NEW

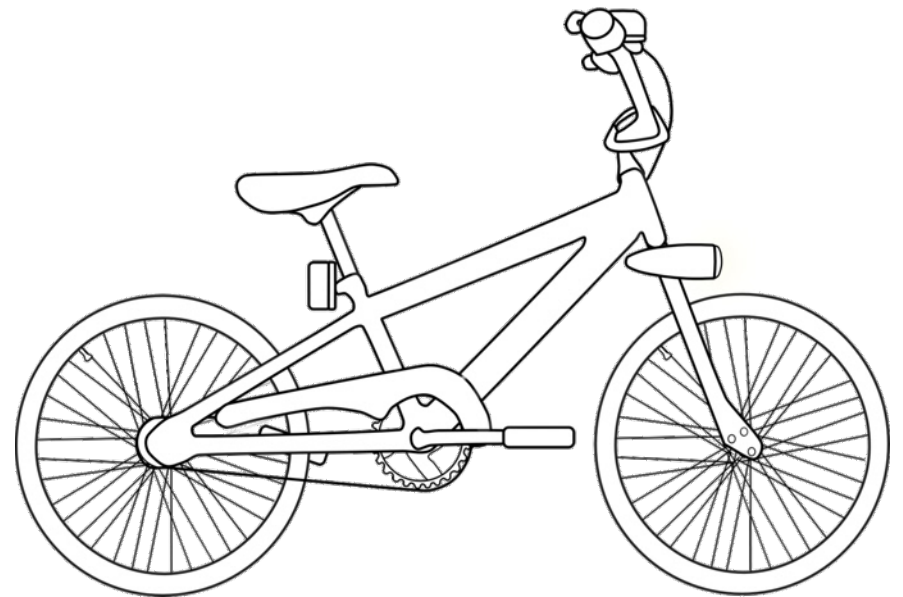
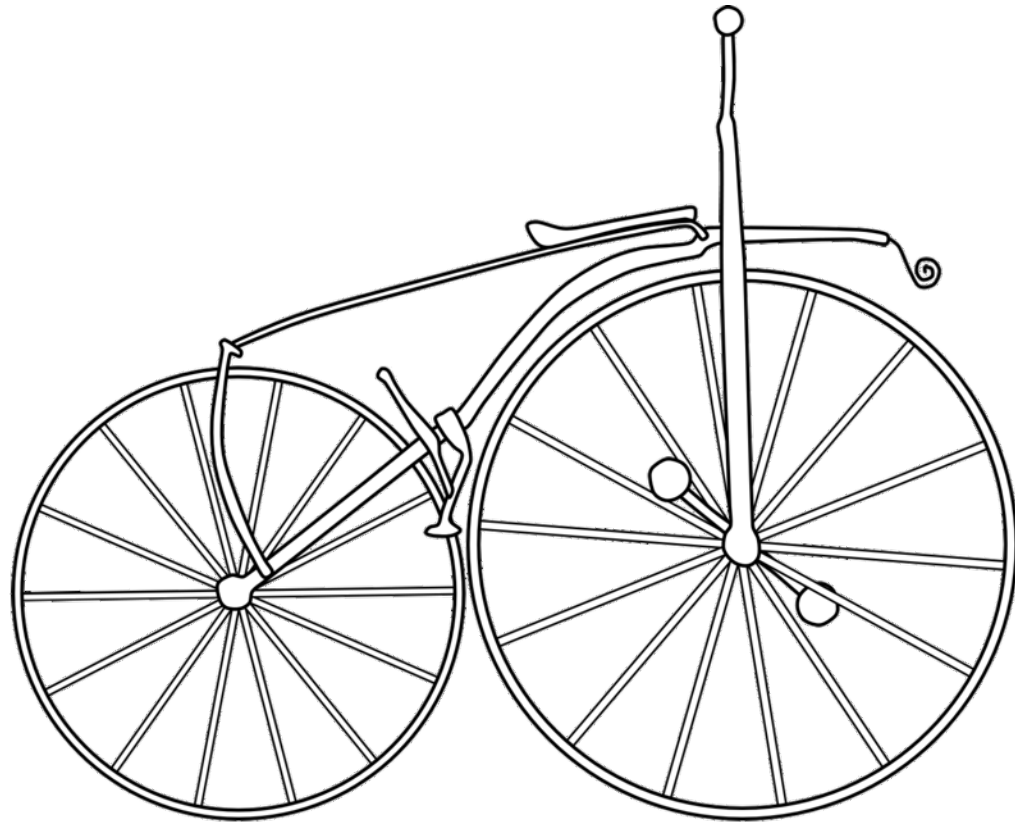

bicycles

Old

NEW

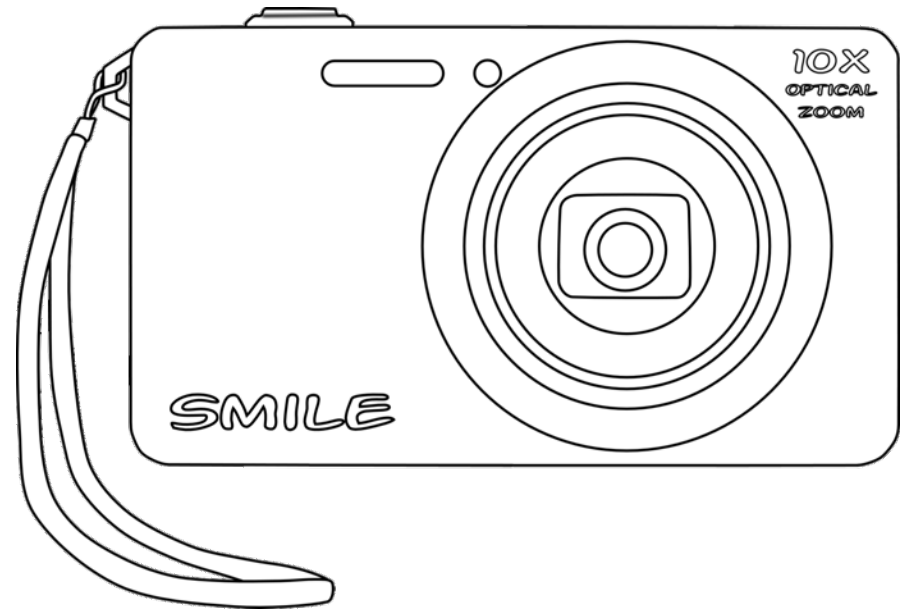
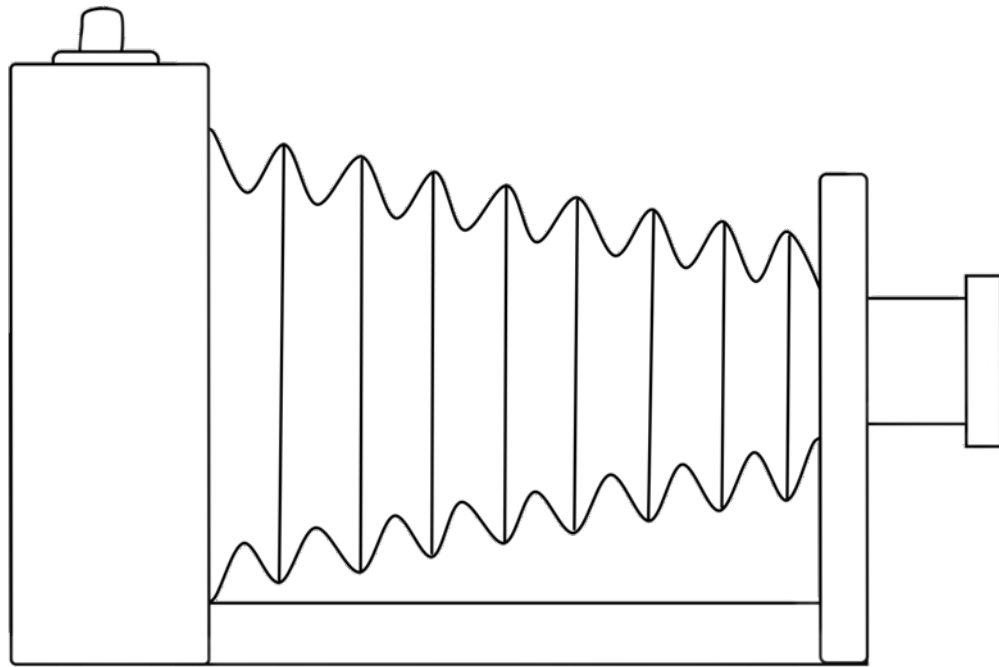

cameras

Old

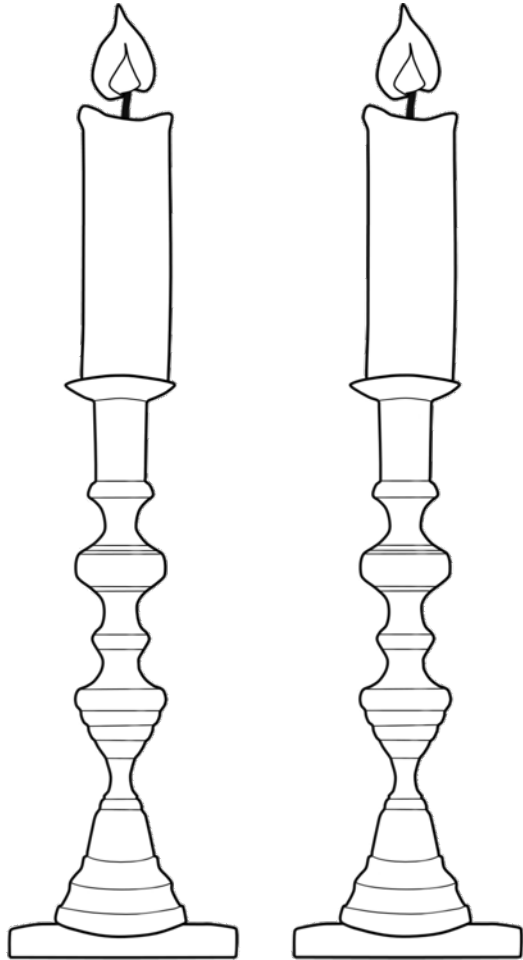

candlesticks

New

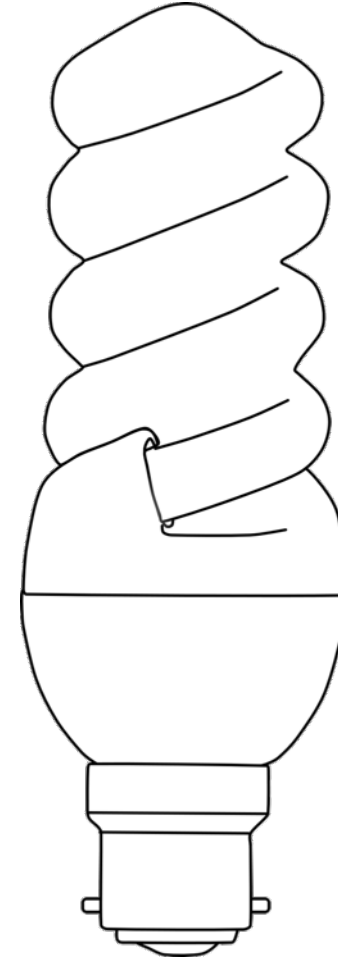

light bulb

Old

NEW

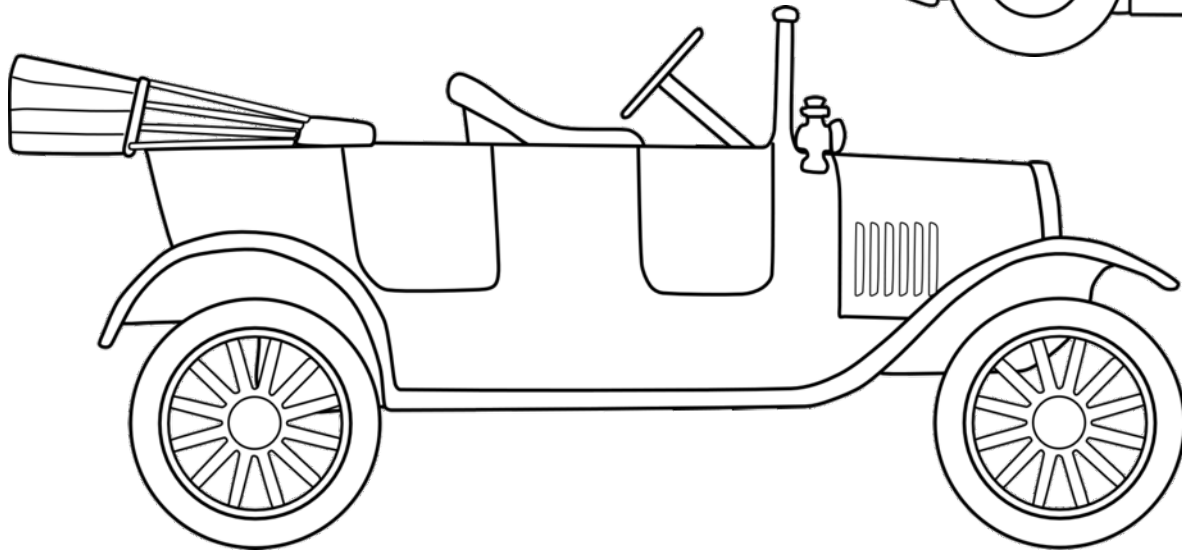
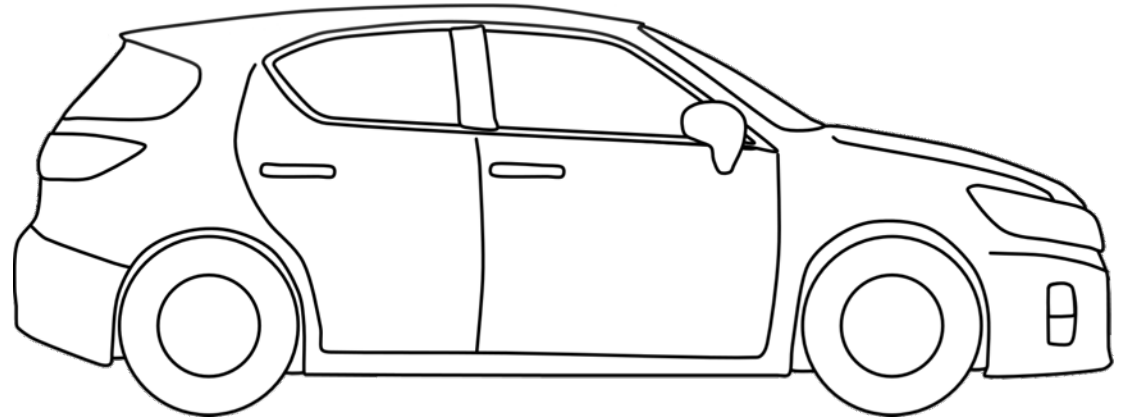

cars

Old

NEW

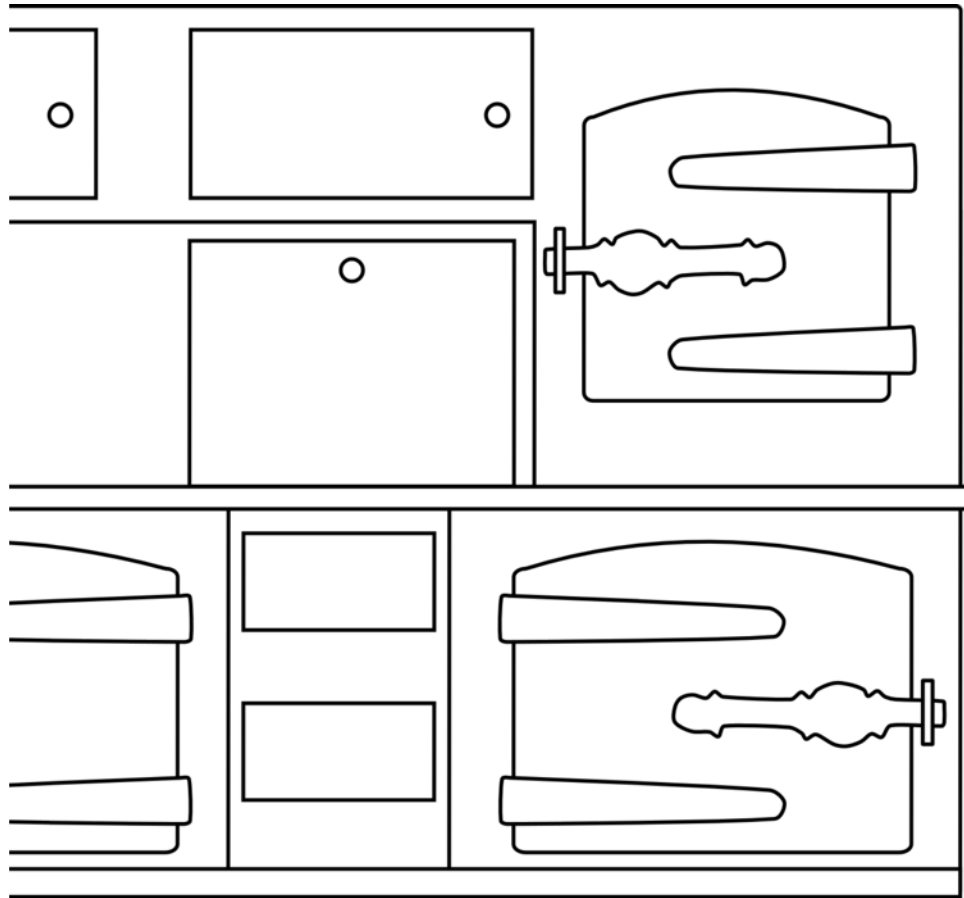

range oven

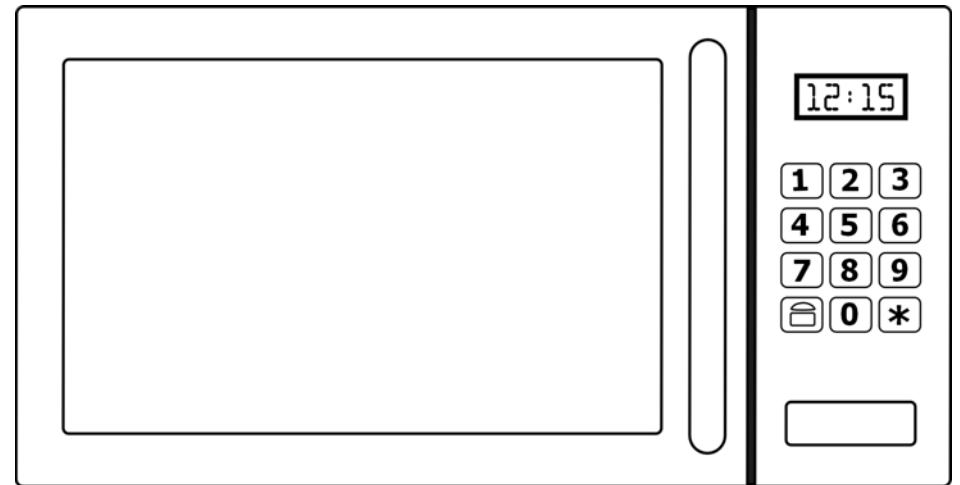

microwave

Old

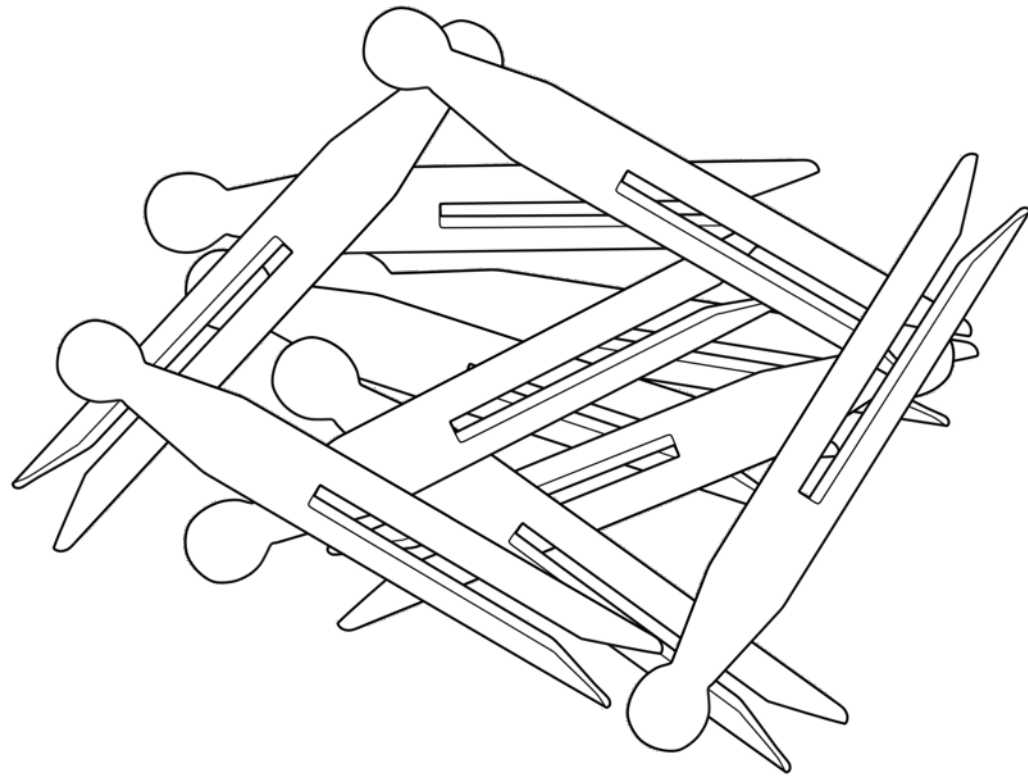

wooden pegs

New

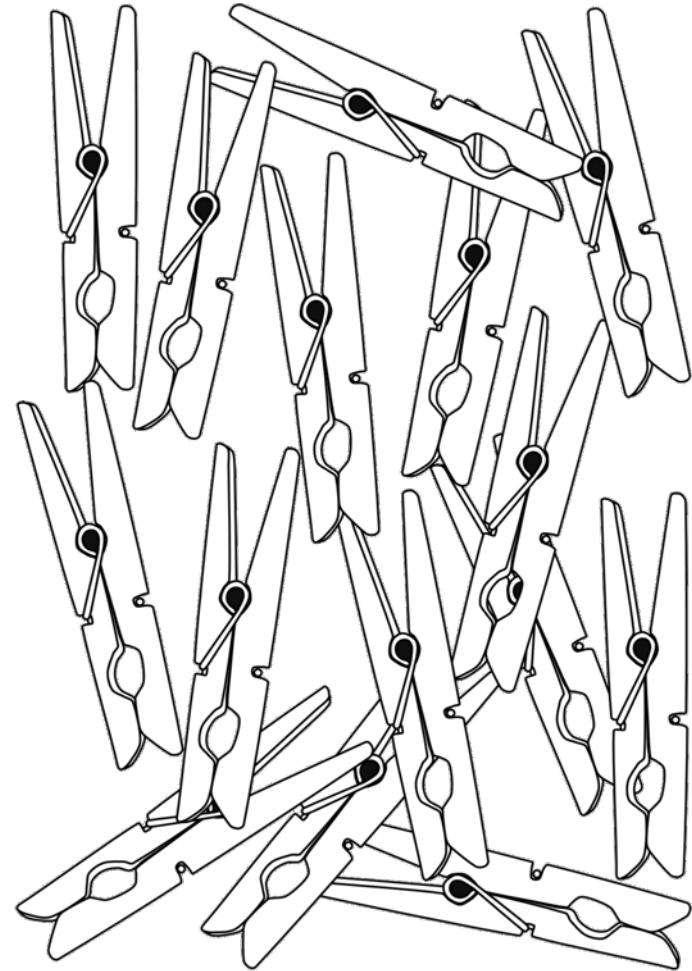

plastic pegs

Old

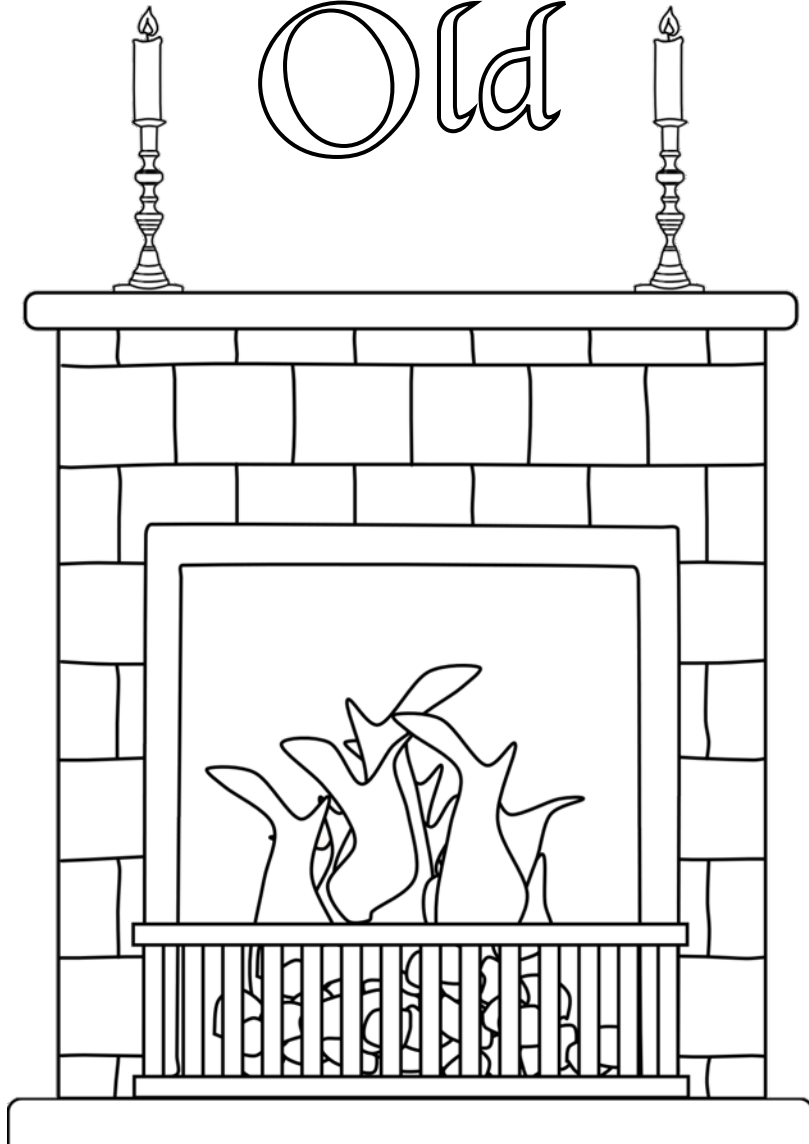

fire

New

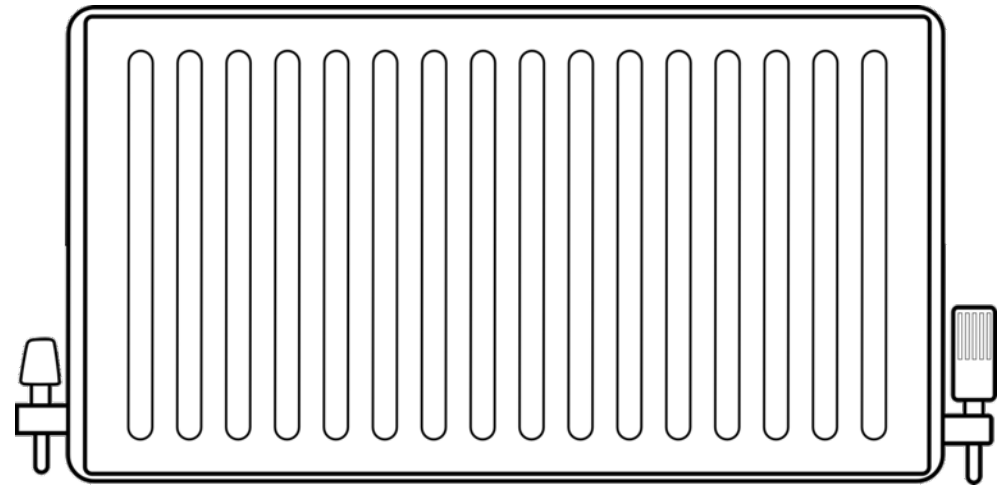

radiator

Old

NEW

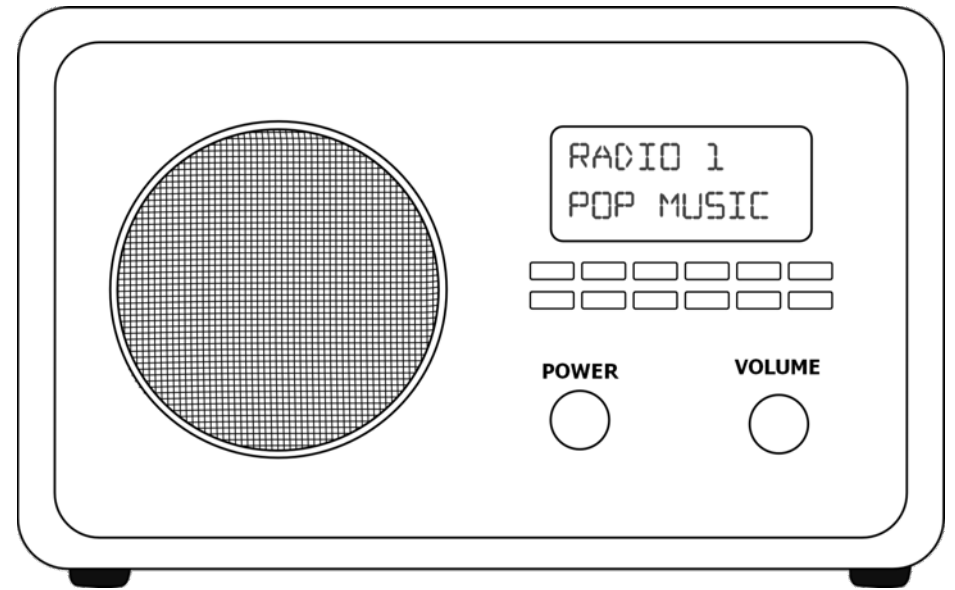
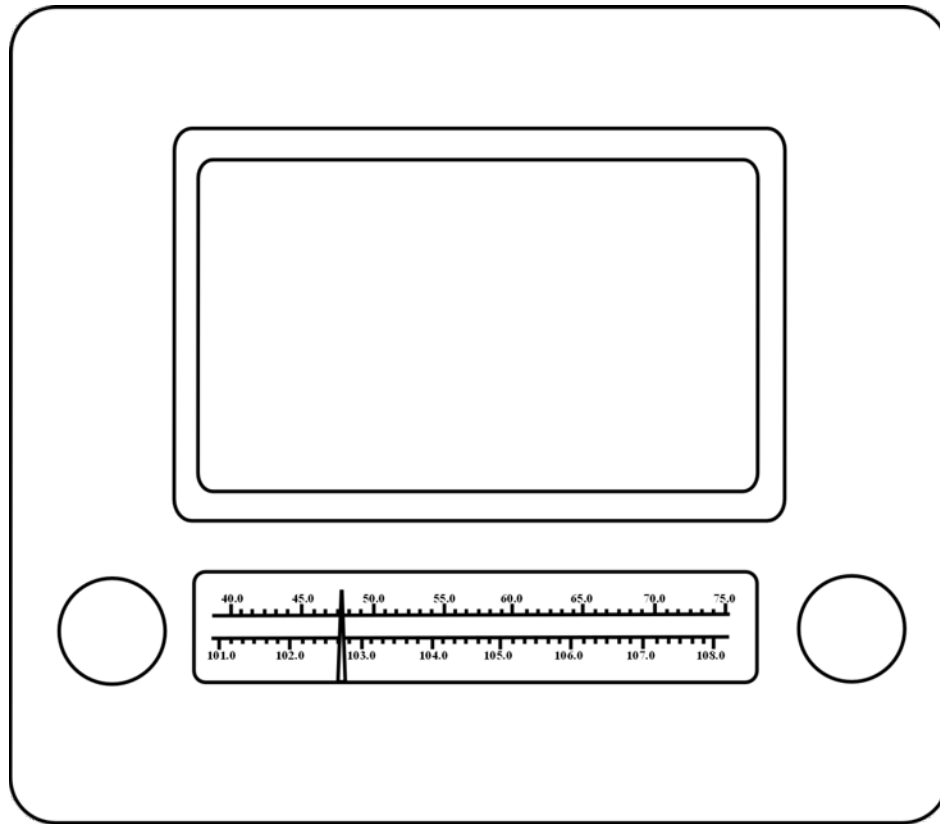

analogue radio

digital radio

Old

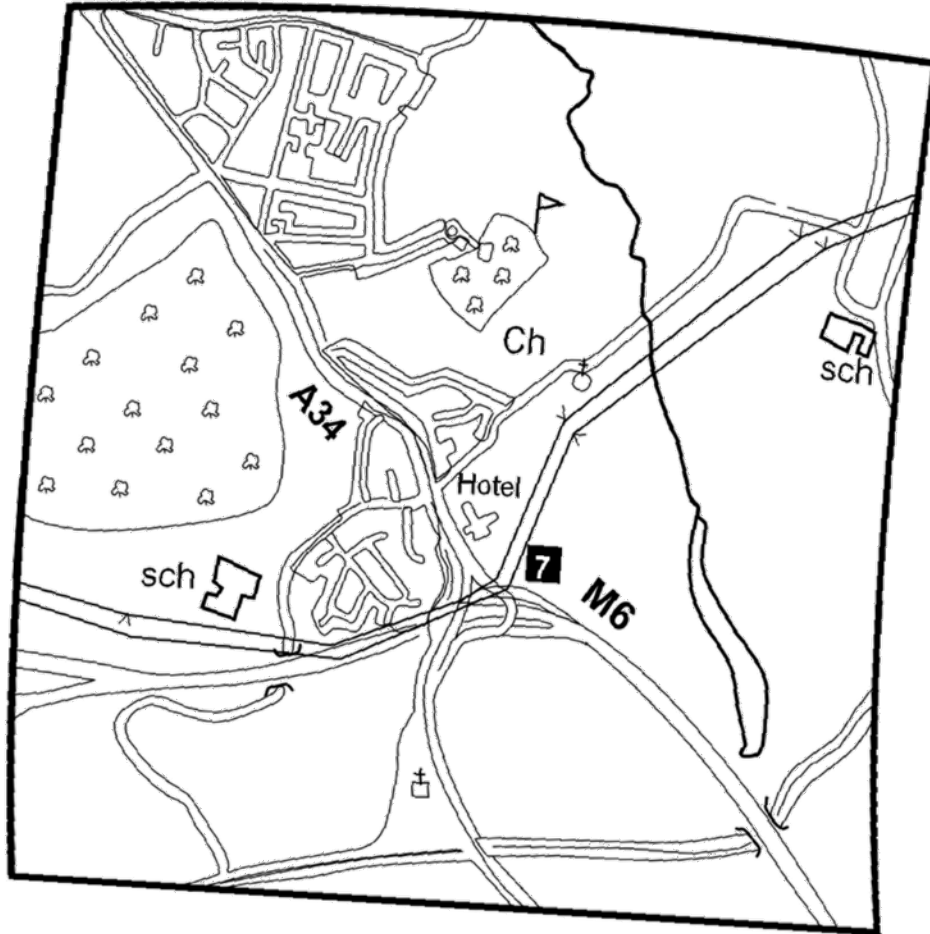

paper map

NEW

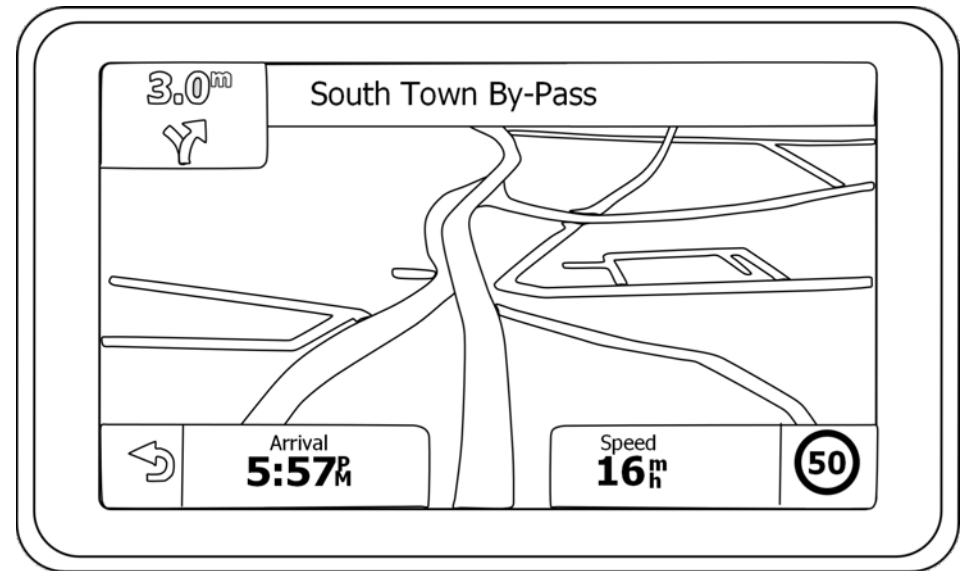

satellite navigation

Old

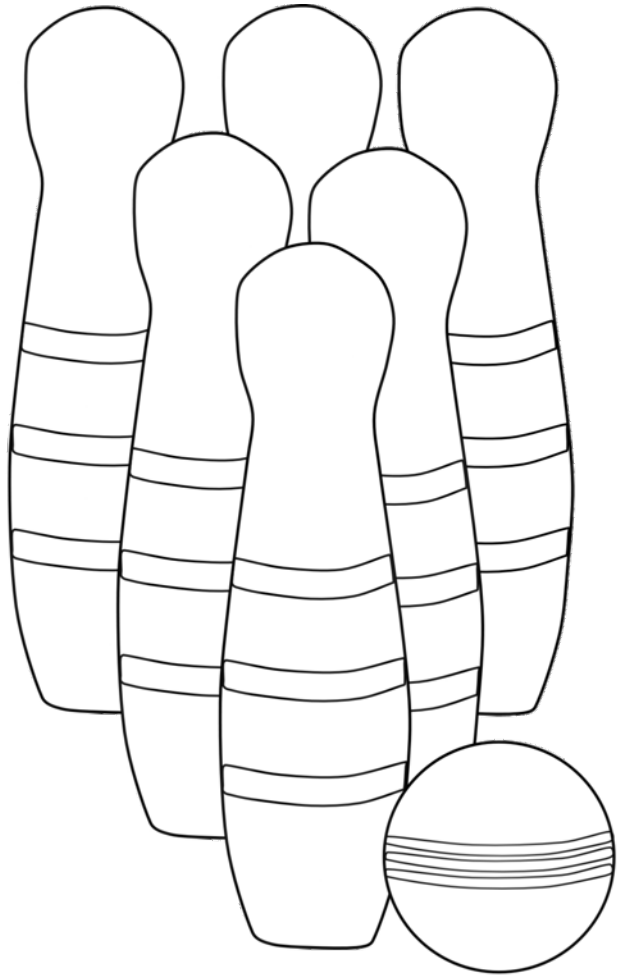

wooden skittles

NEW

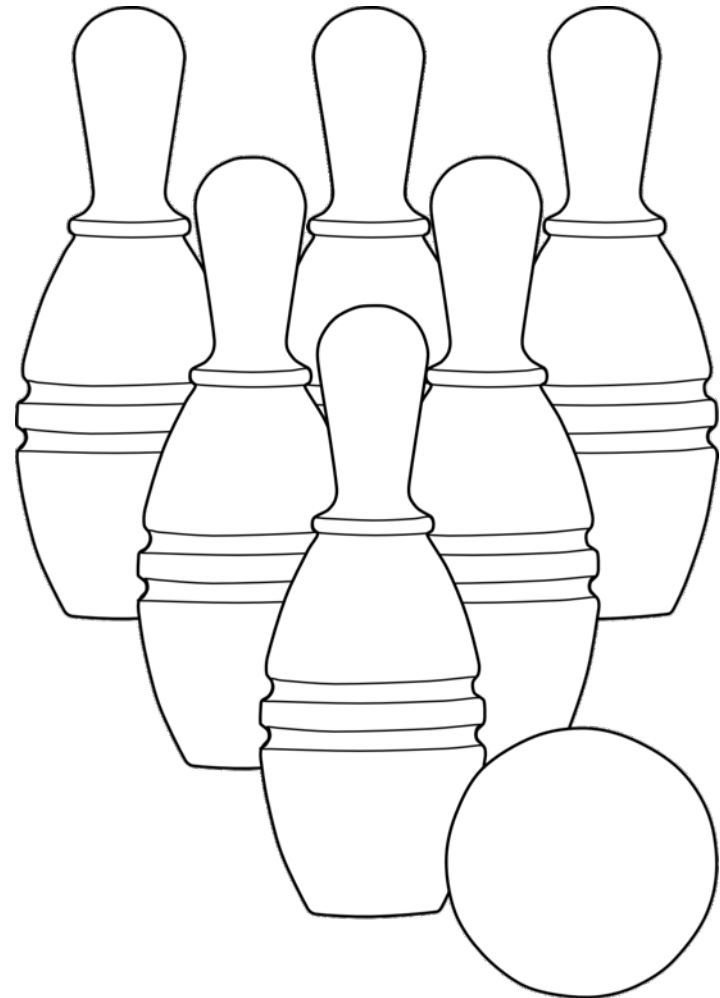

plastic skittles

Old

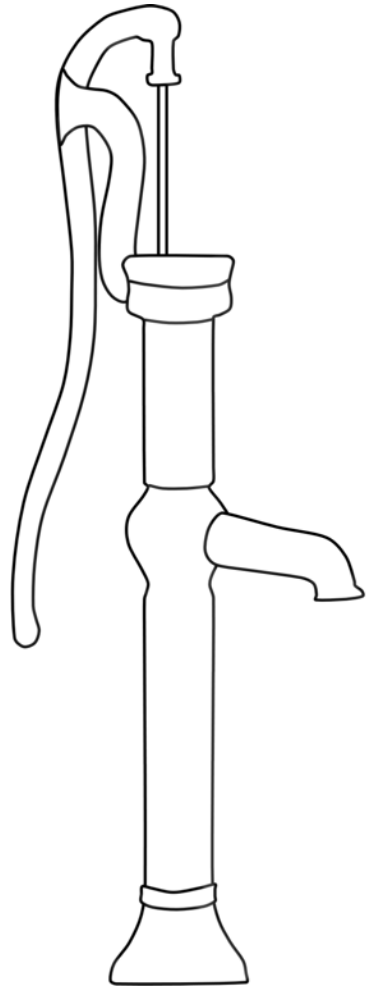

water pump

New

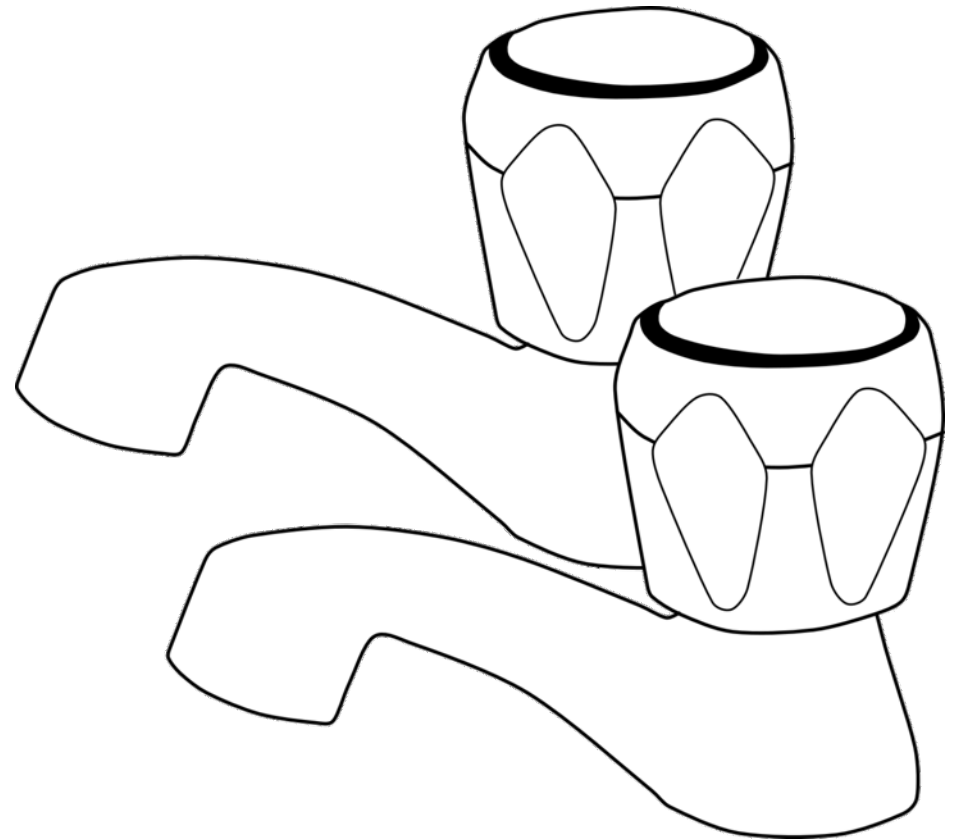

water taps

Old

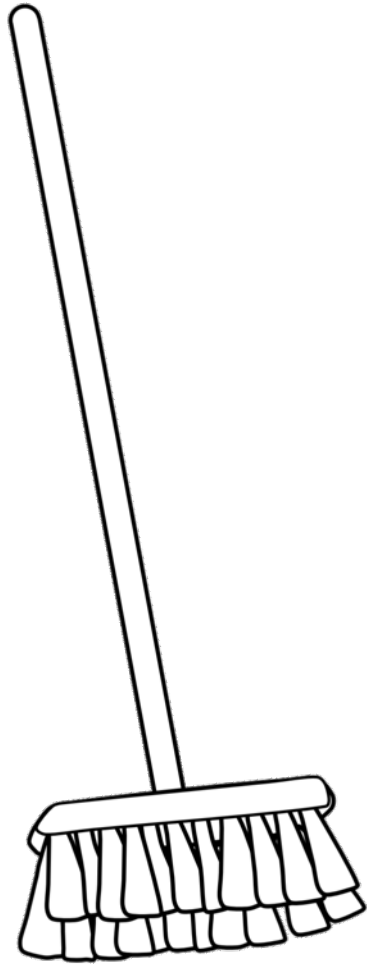

broom

New

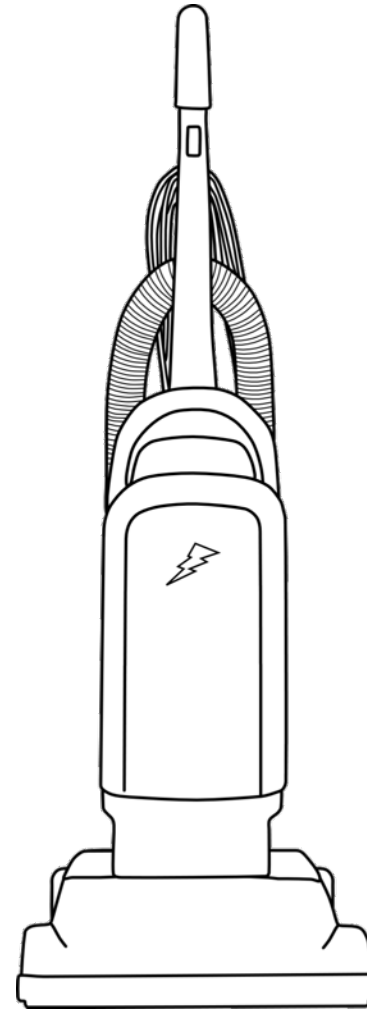

vacuum cleaner

Old

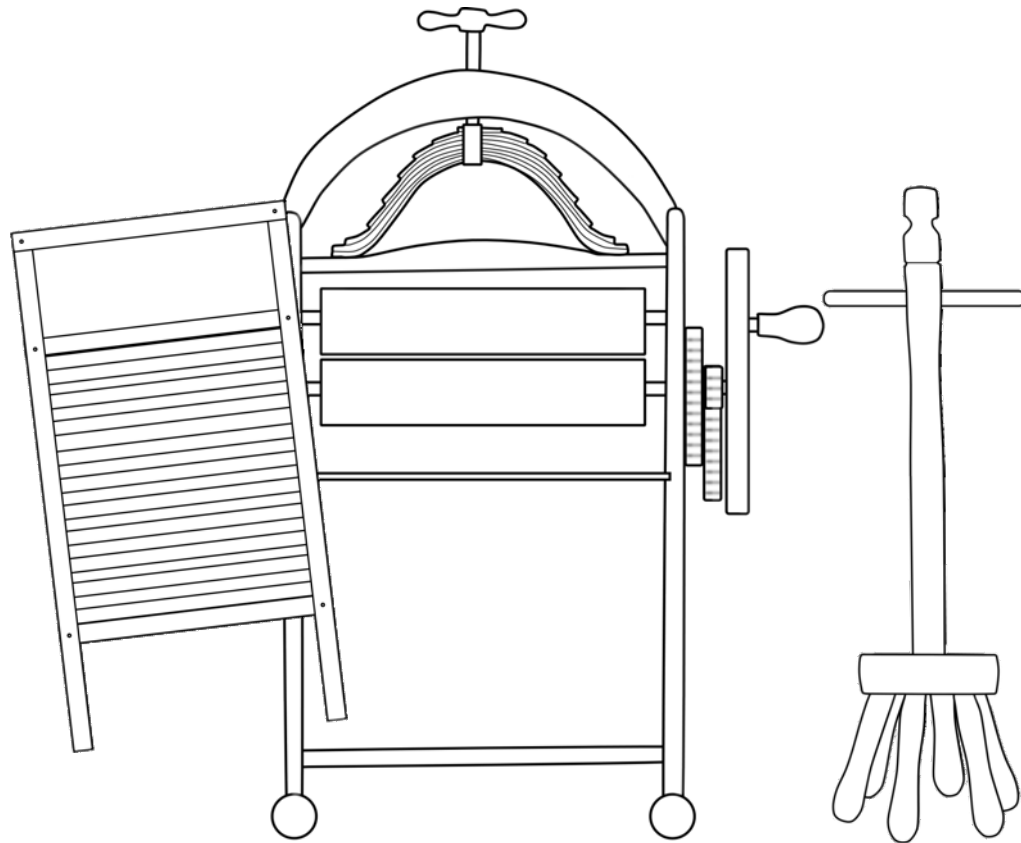

washboard, dolly
and mangle

New

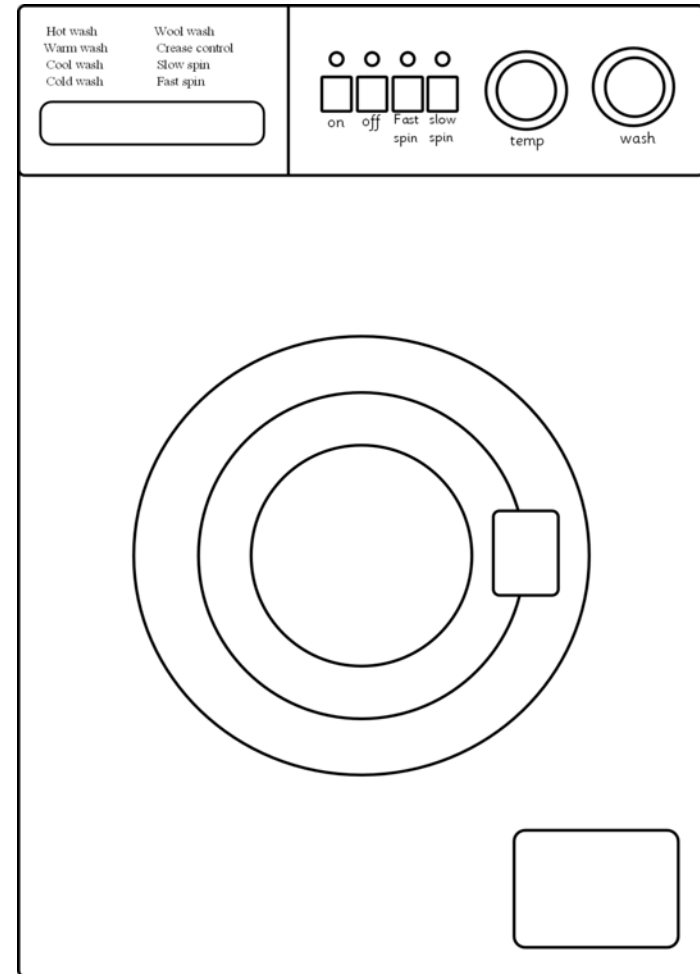

washing machine

Old



kettle

NEW

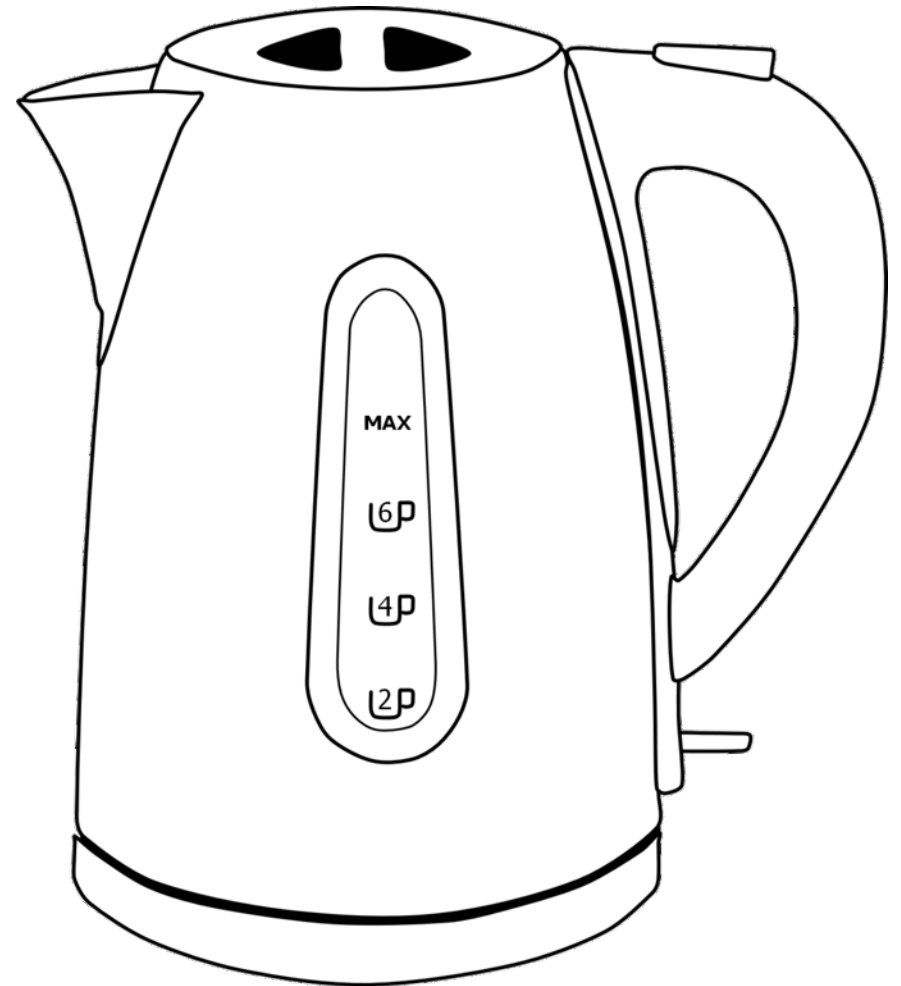

electric kettle

Old

NEW

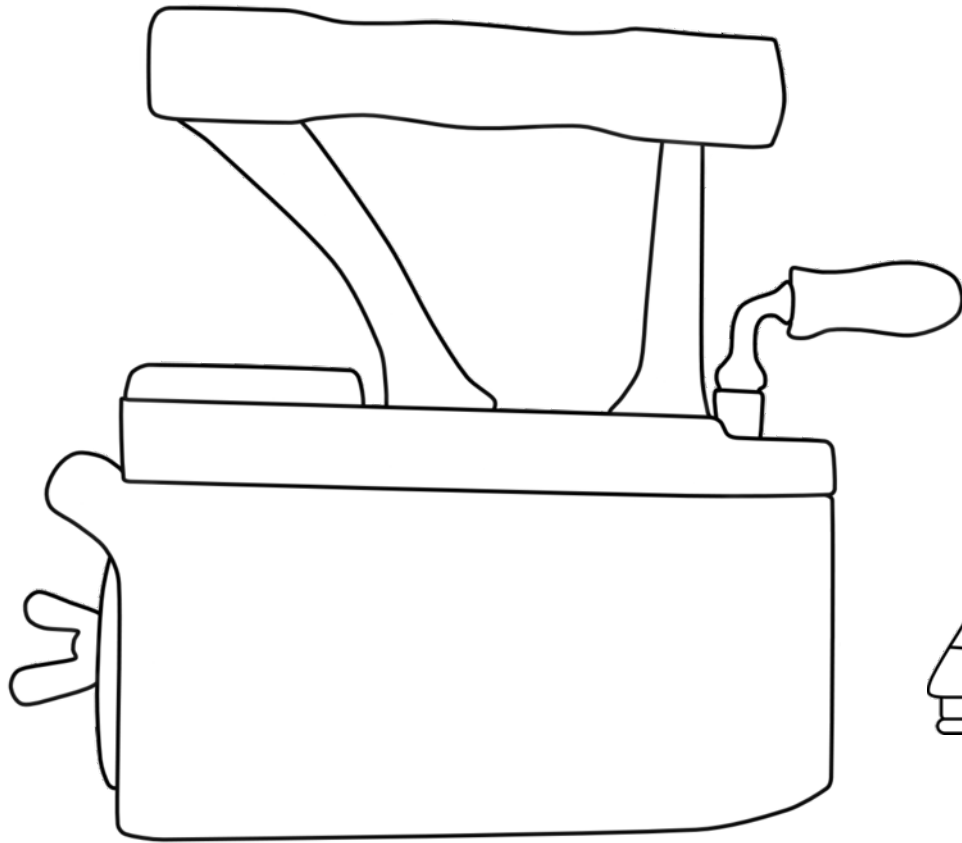

iron

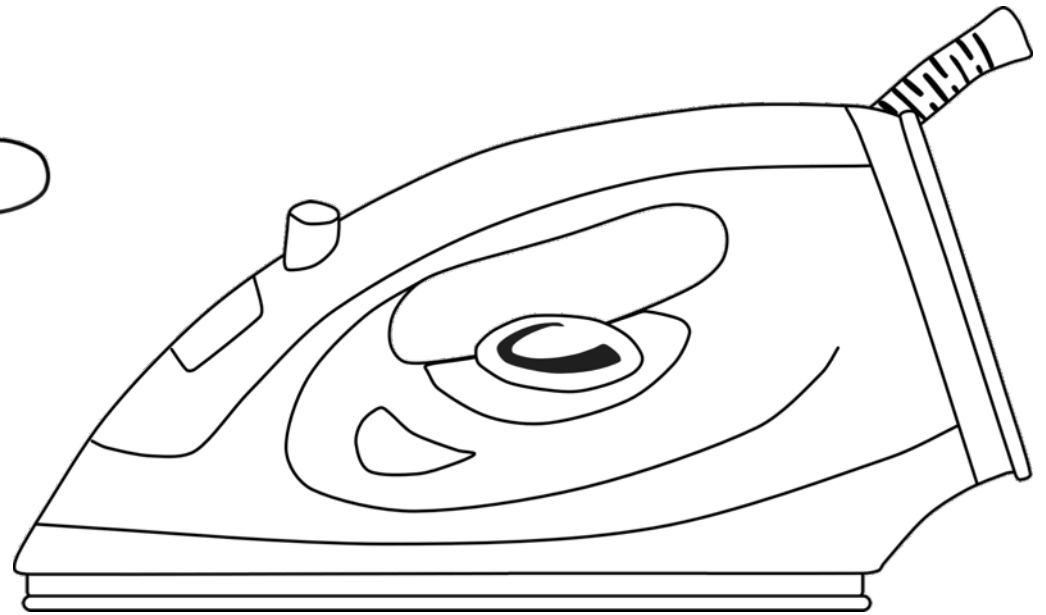

electric iron

Old

NEW

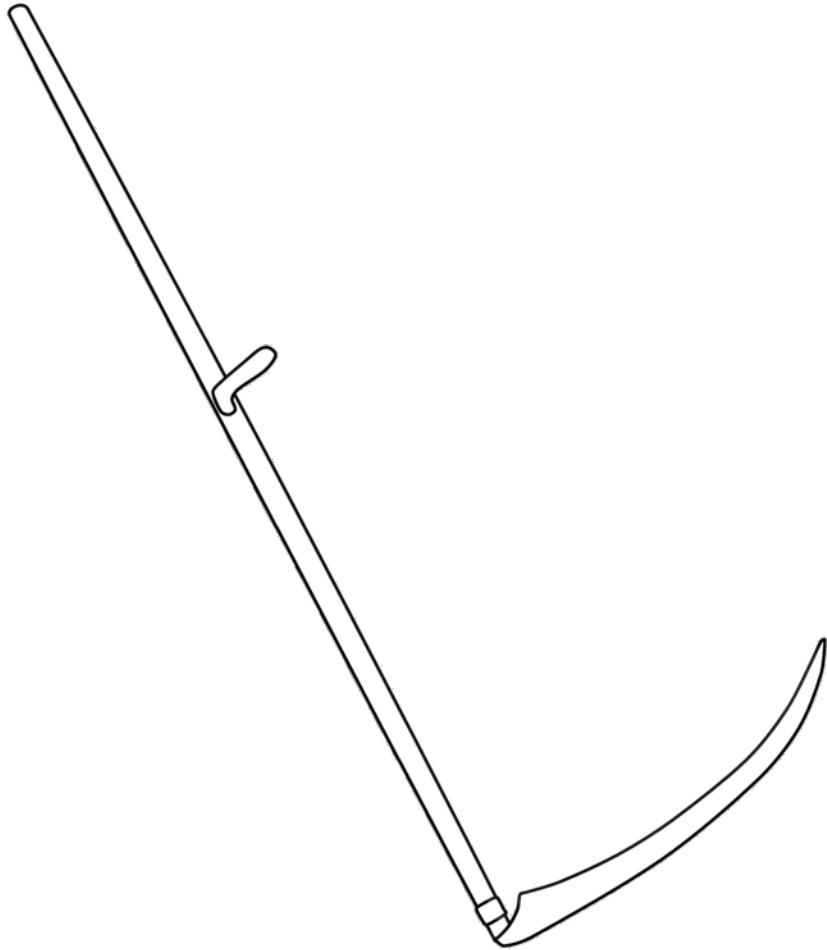

scythe

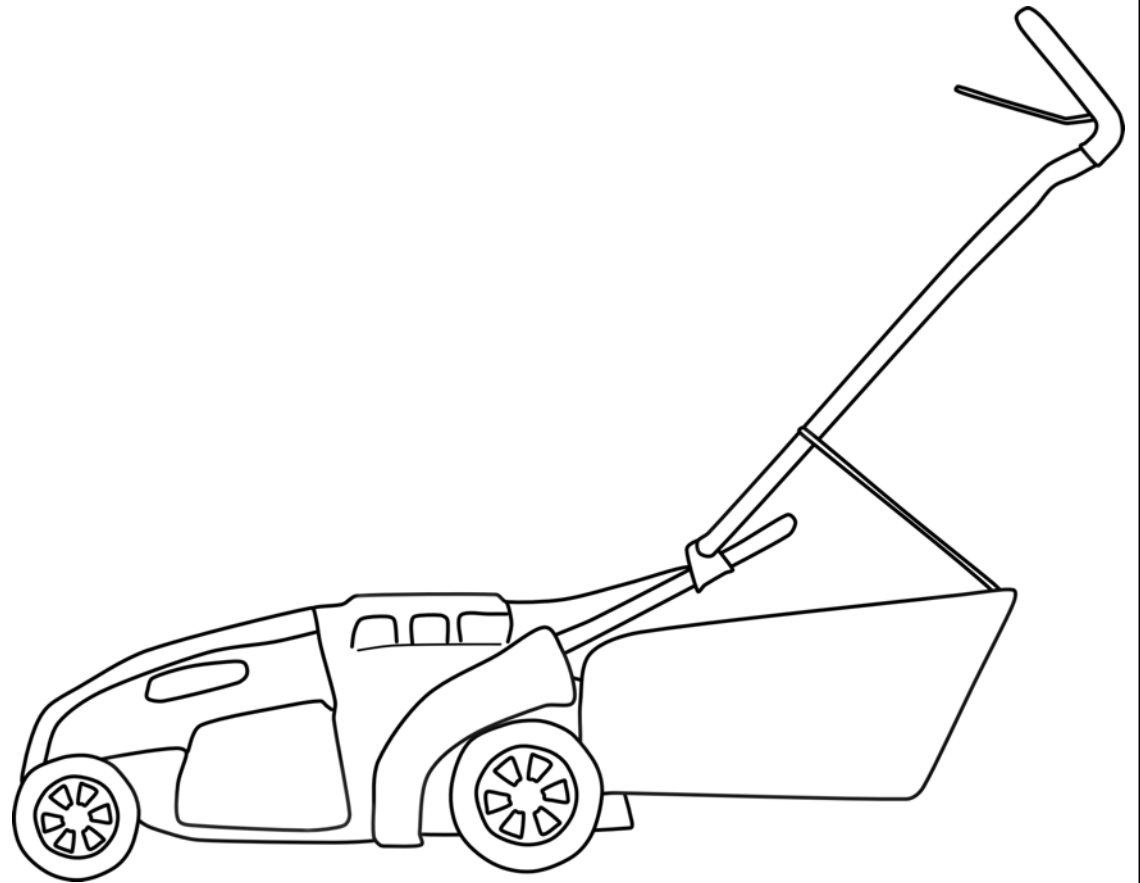

lawn mower