

The Wright Brothers

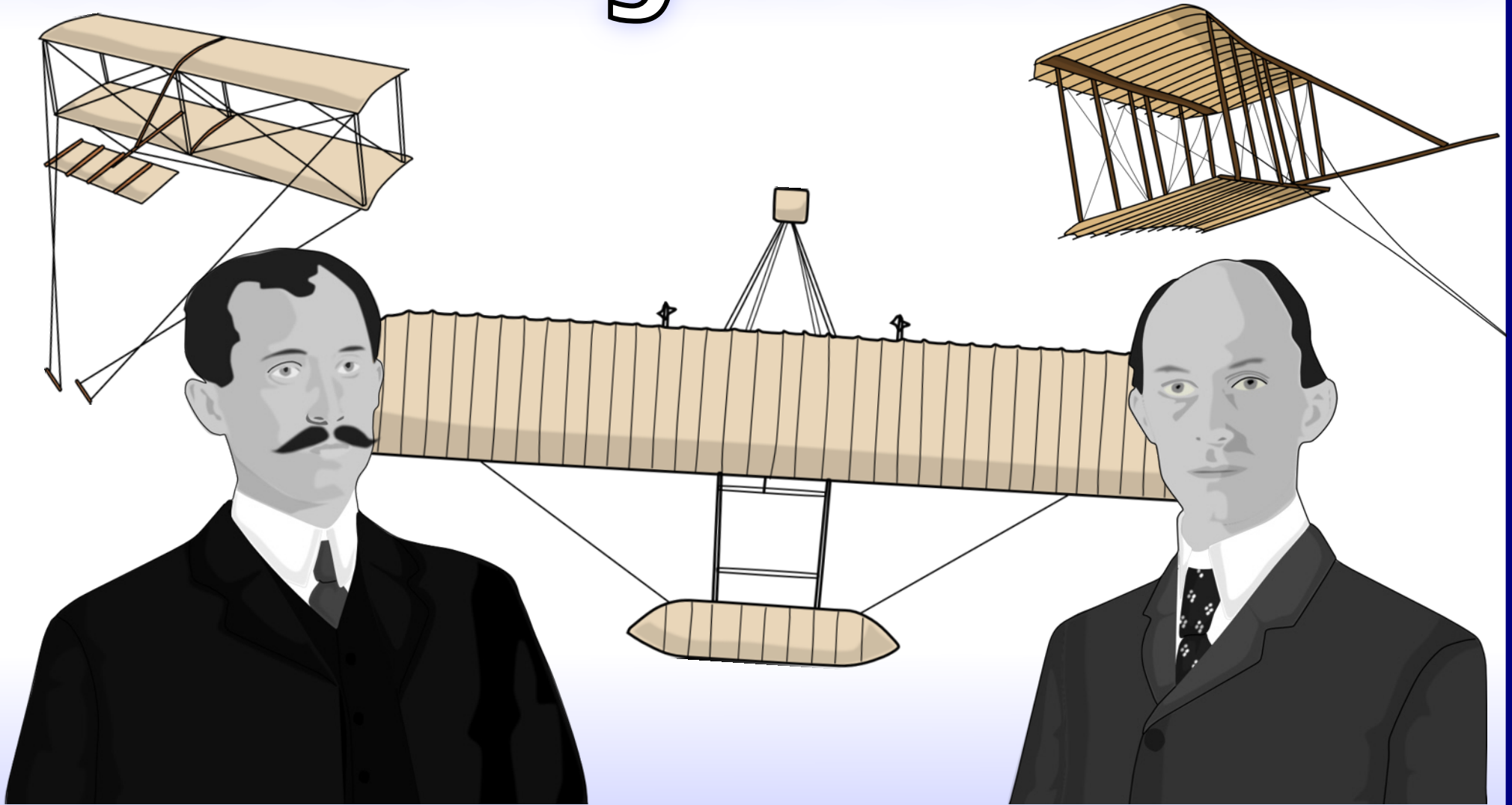

1867 **16th April**

Wilbur Wright is born in Indiana, USA.

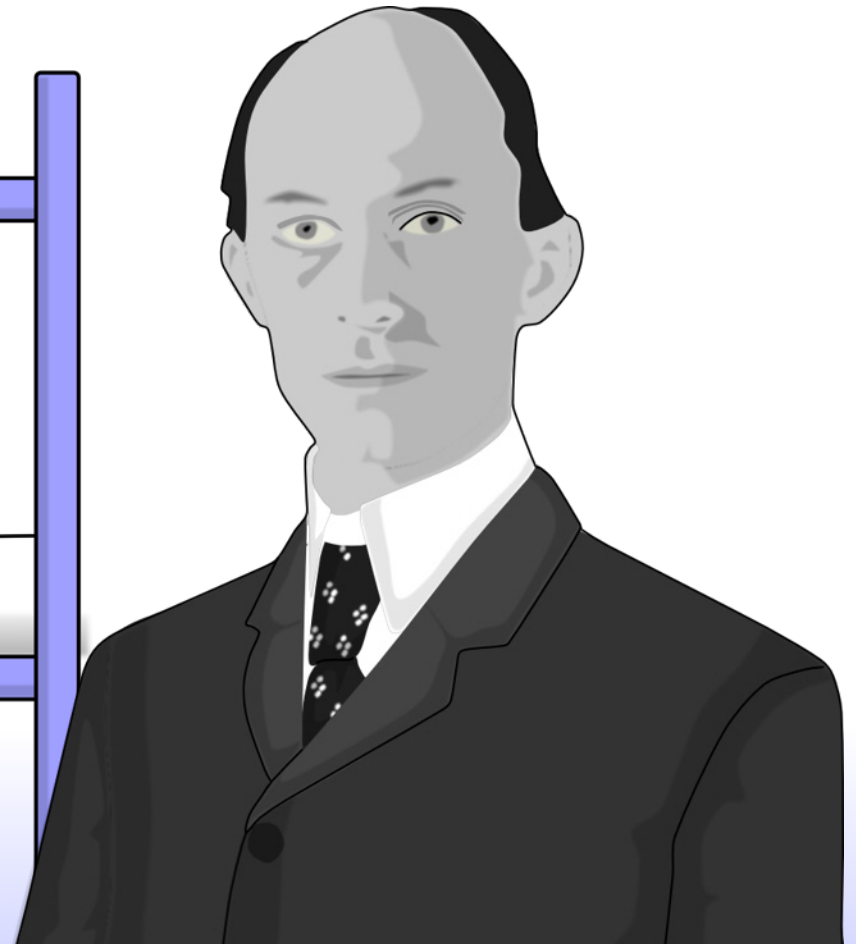
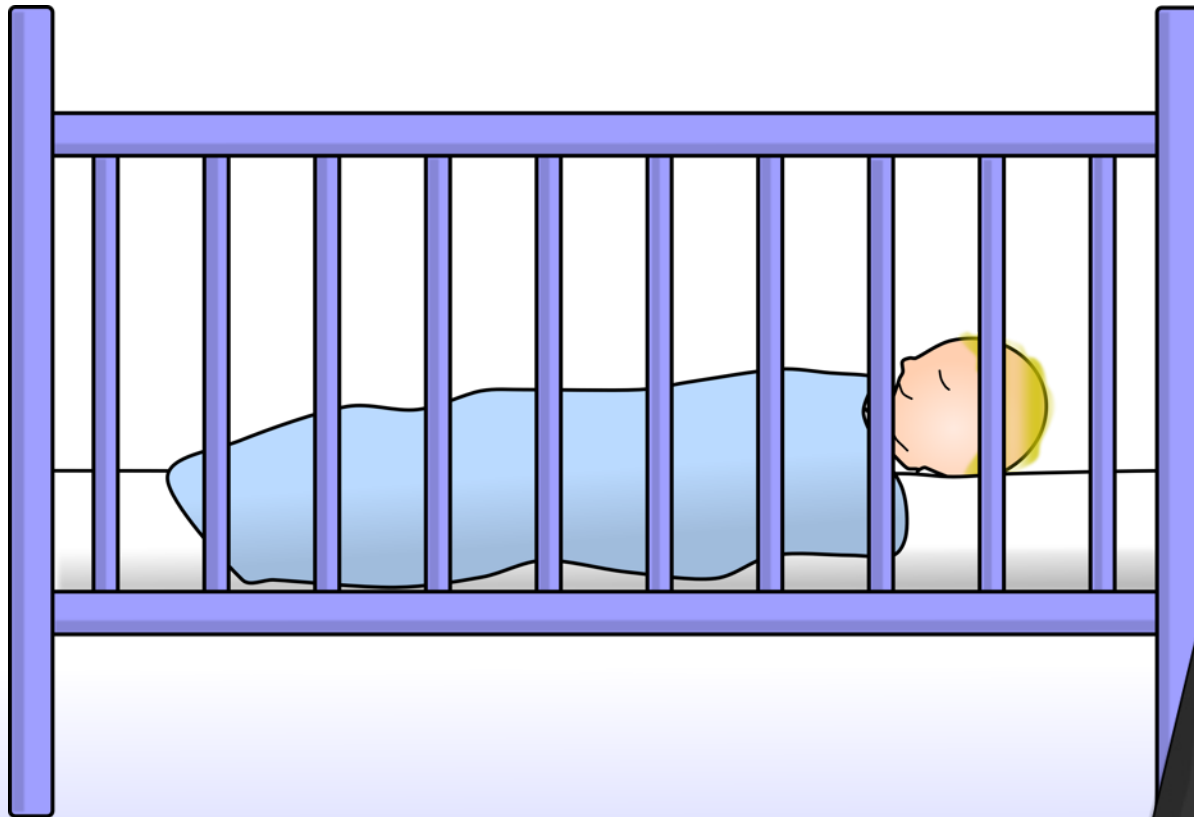

1871 19th August

Orville Wright is born in Ohio, USA.

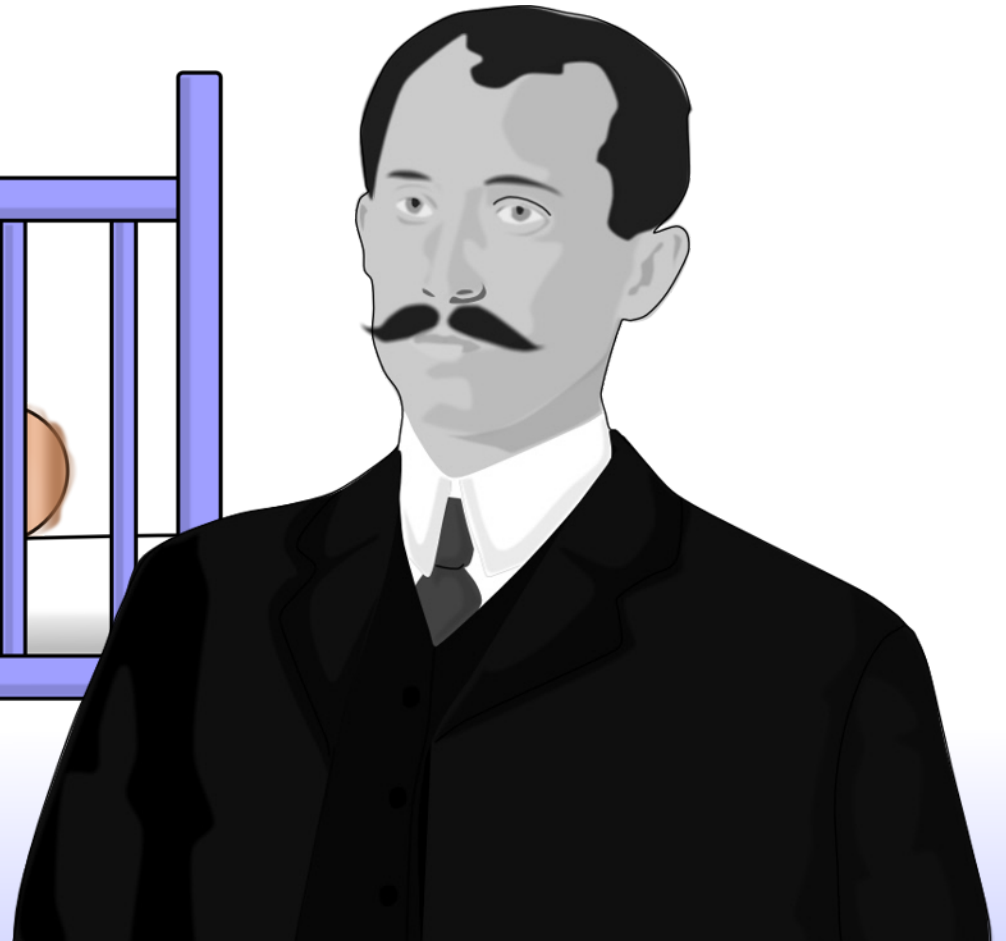
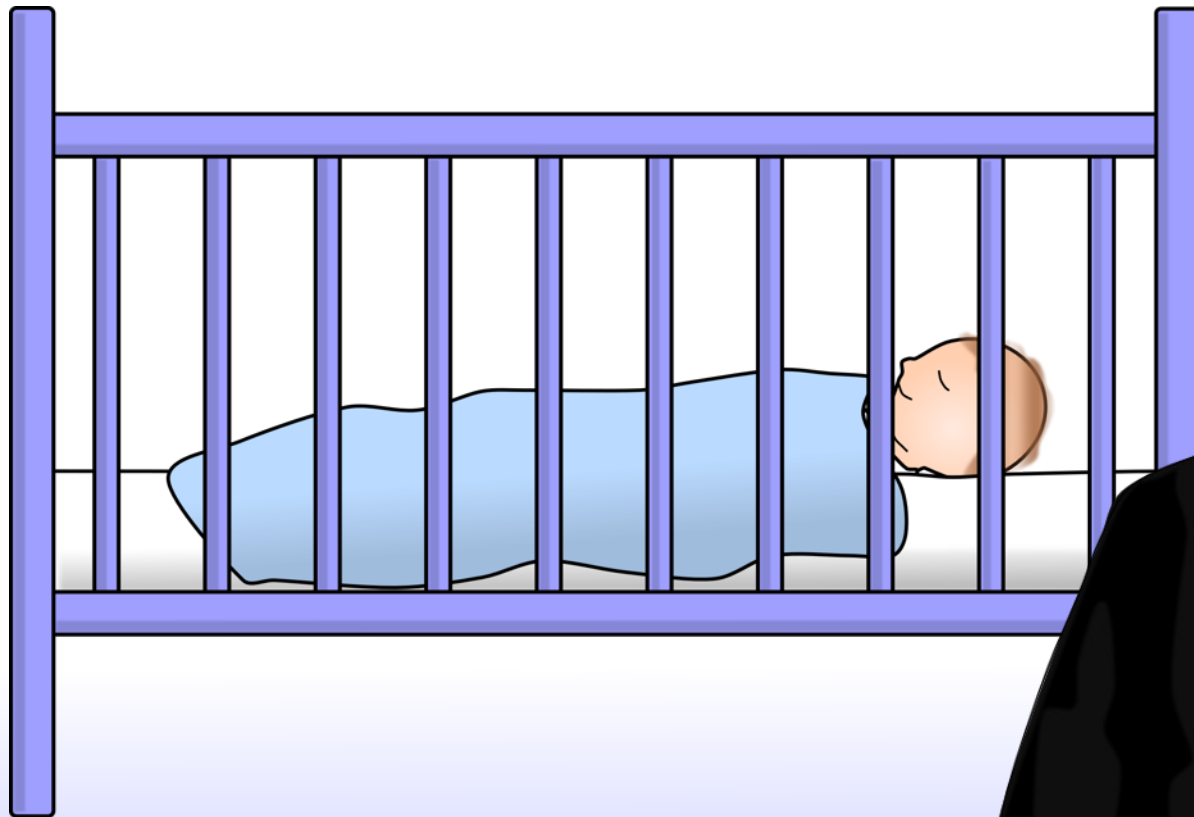

1878

The boys' father buys them a toy helicopter and their interest in flying things begins.

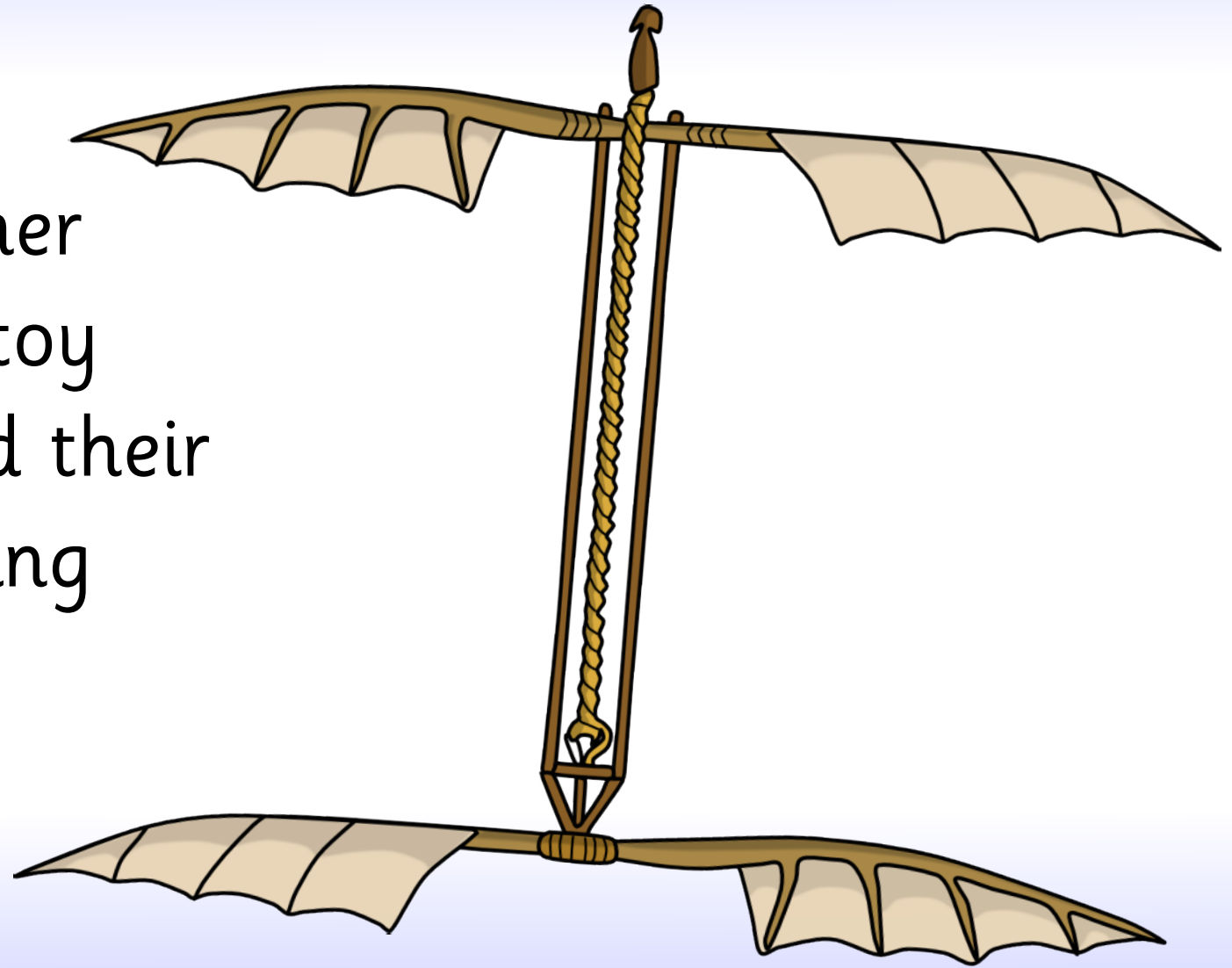

1881

Orville begins making his own kites as a hobby.

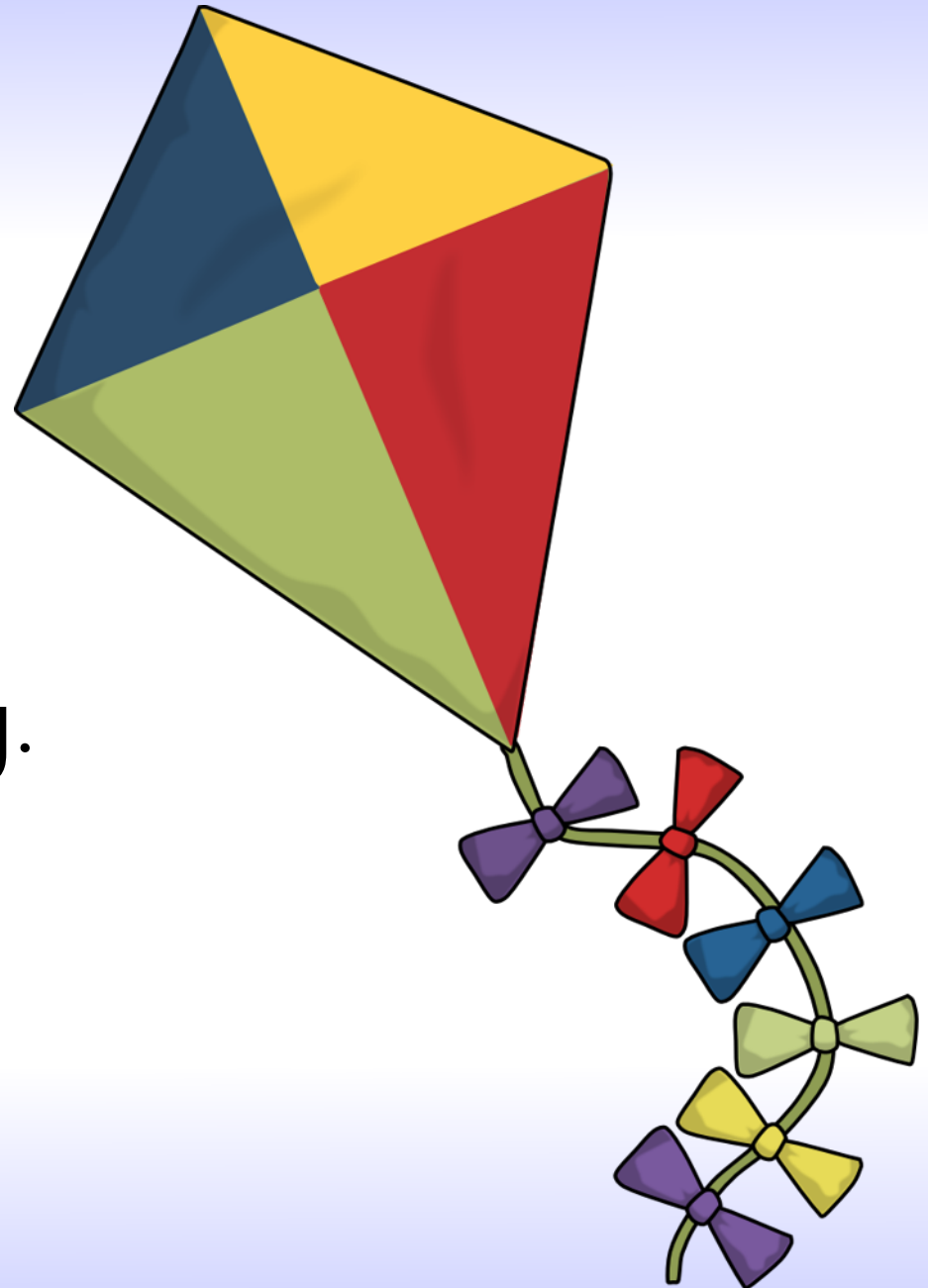

1892

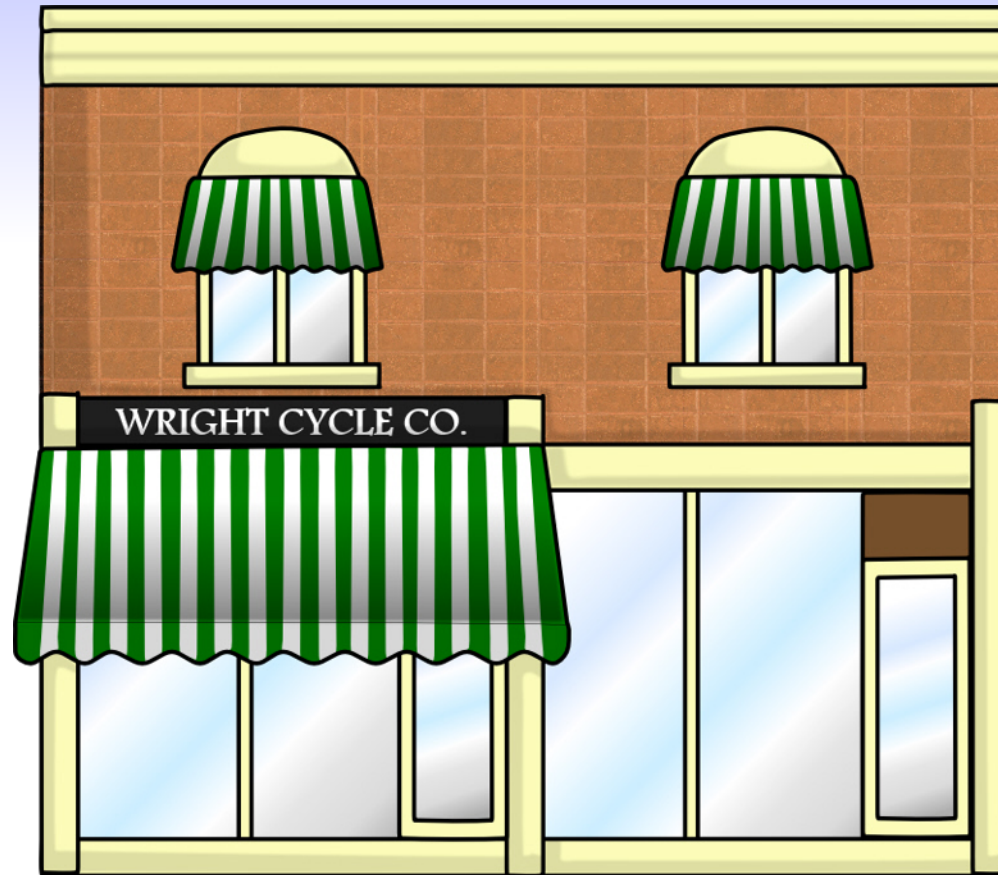

The two brothers open a bicycle shop enabling them to practise building things and to earn money to use later.

1896

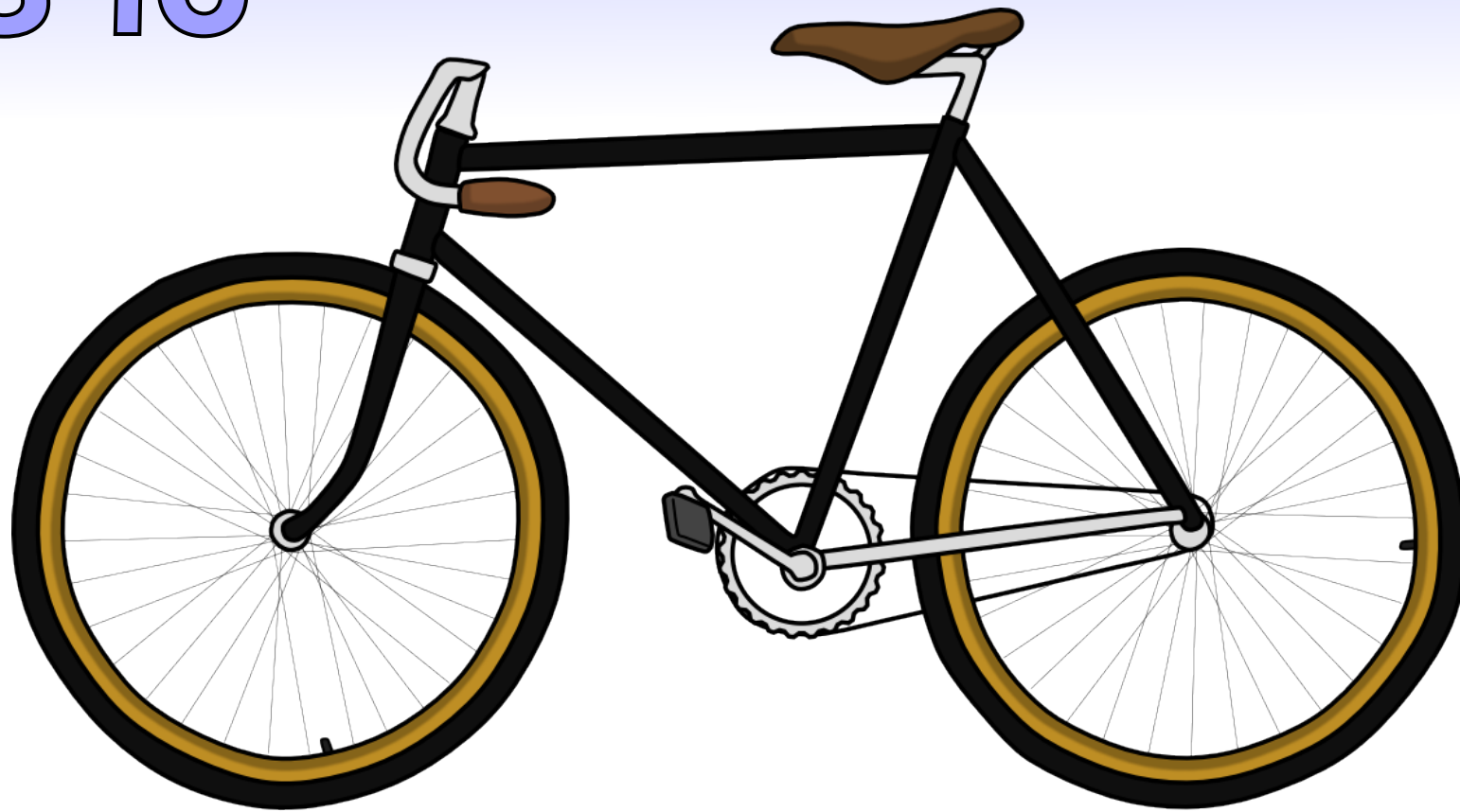

The brothers begin making their own bicycles at their shop.

1896 10th August

Famous aeronautical engineer, Otto Lillenthal, dies while trying to fly a glider.

The Wright brothers are reminded of their passion for flying things.



1899

The brothers begin testing a special “wing-warping” type of kite.

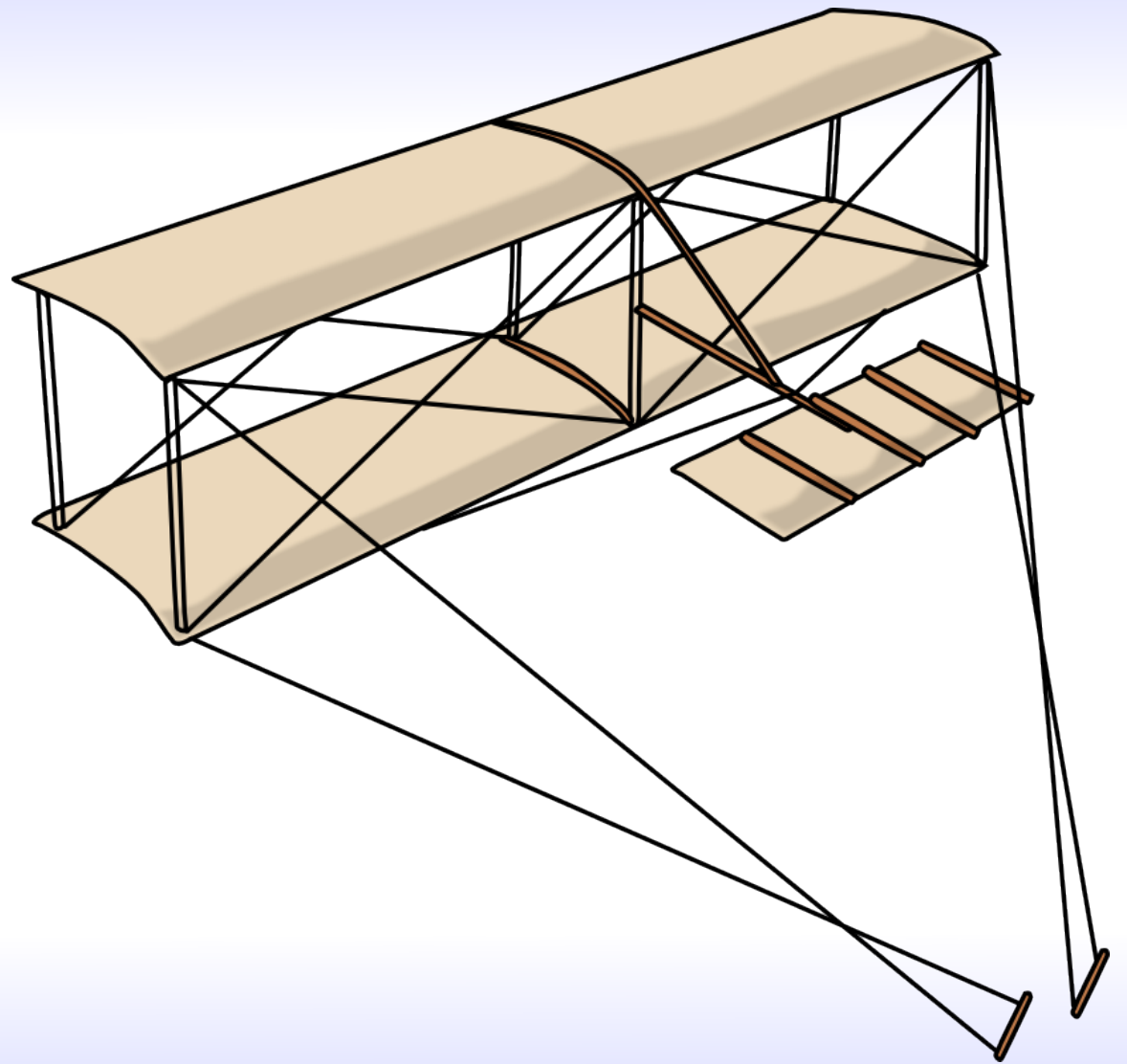

1901

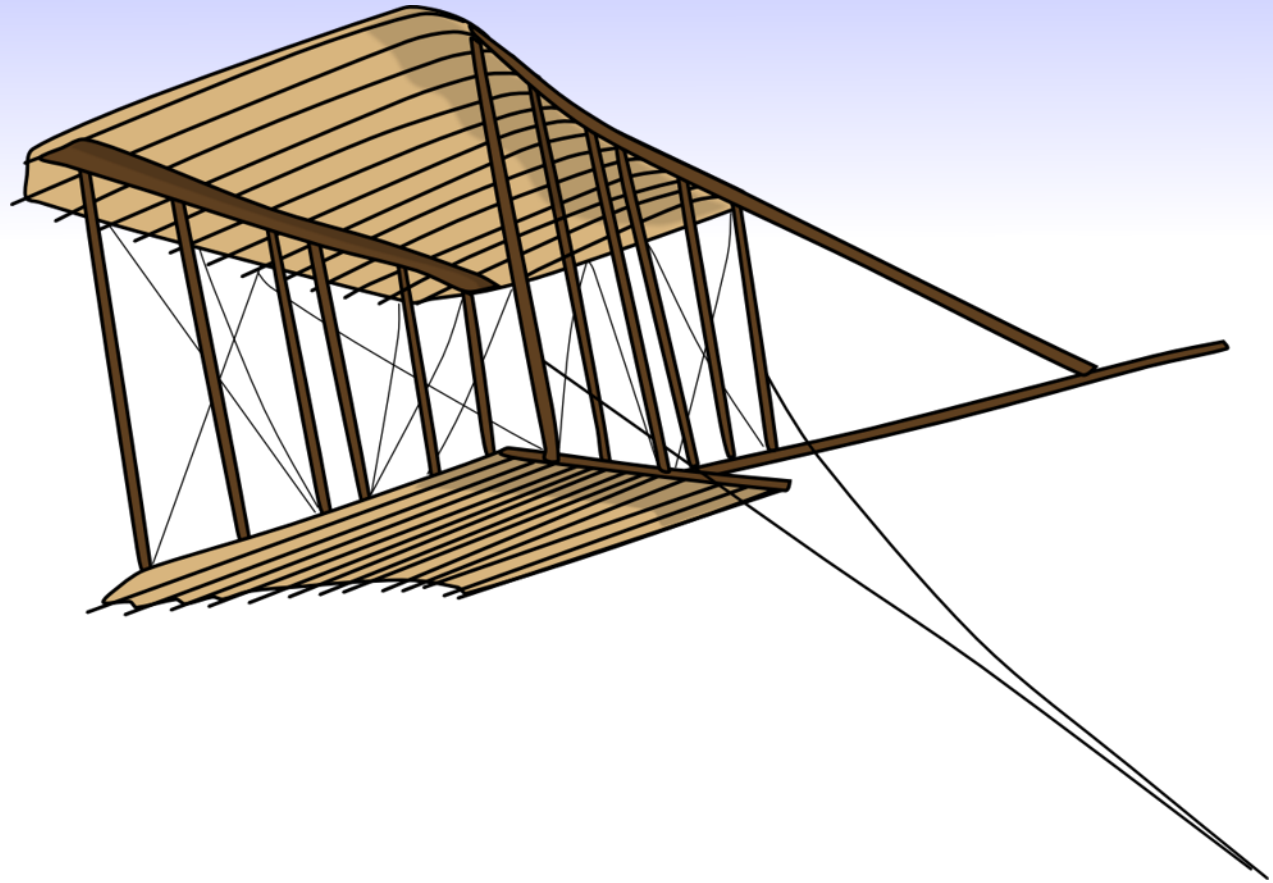

After moving to Kitty Hawk the year before, the brothers continue testing and experimenting with different glider designs.

1903

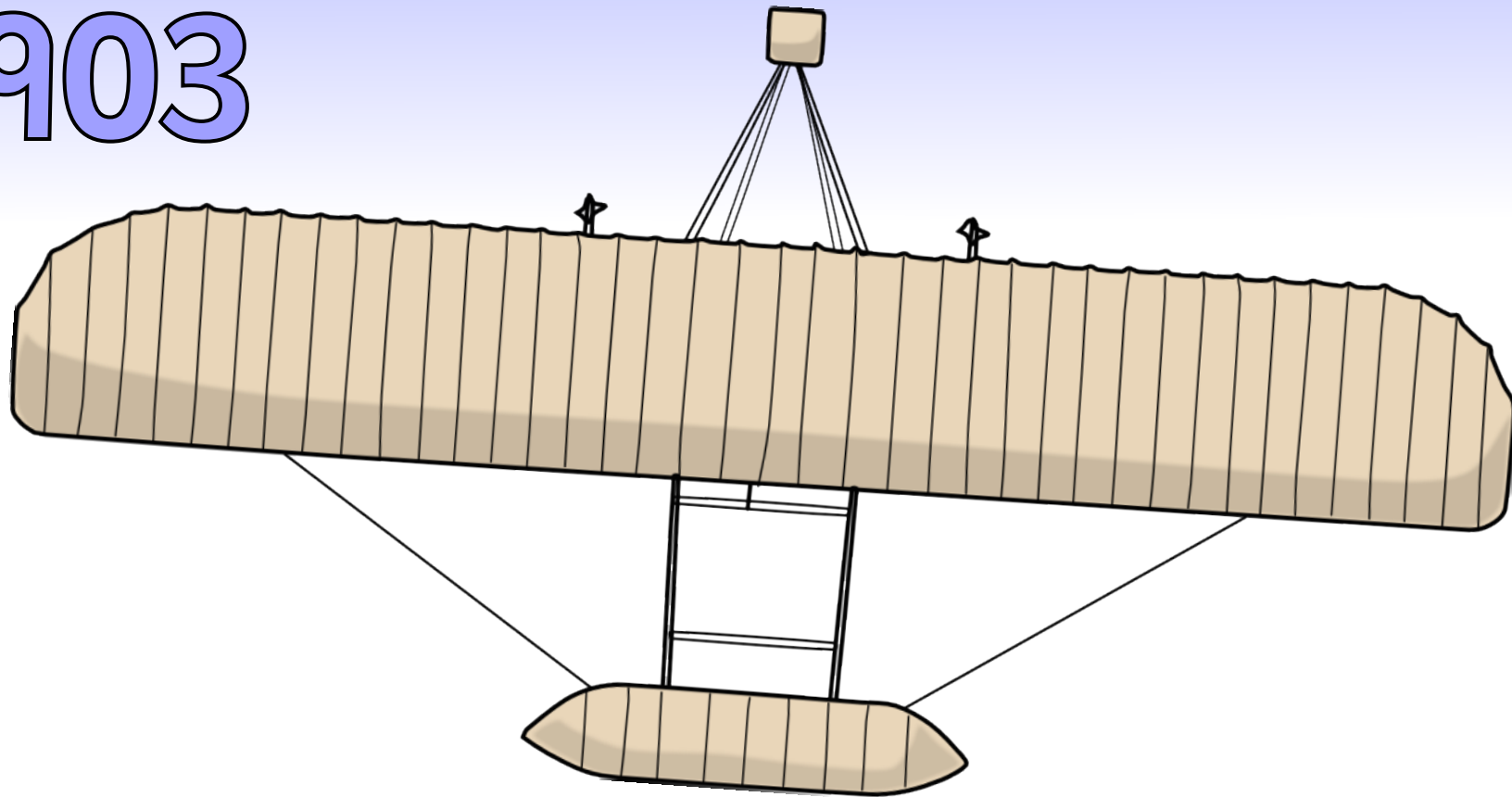

Wilbur and Orville work on adding an engine to their gliders and make the first short powered flights.

1906

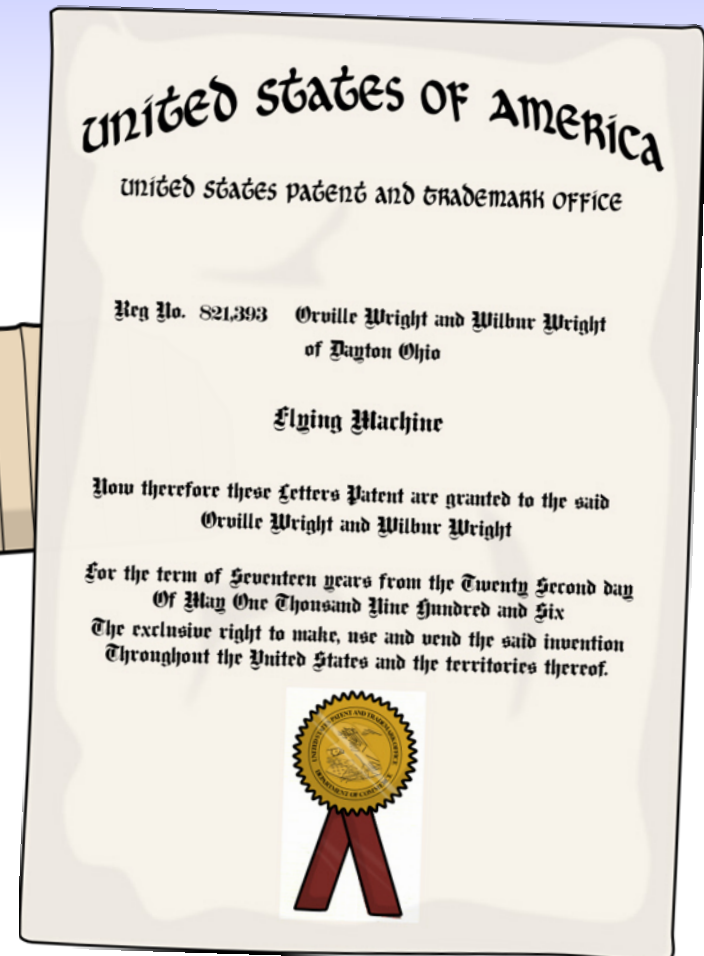
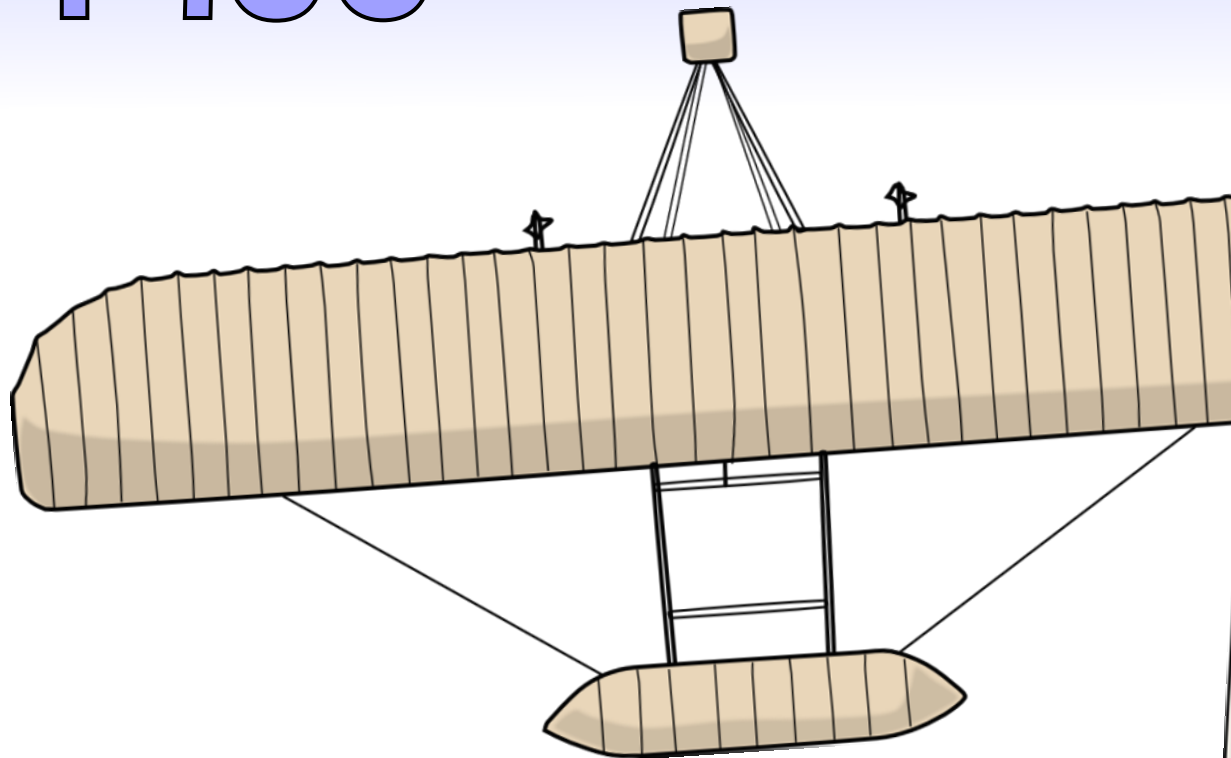

The Wrights are granted a patent for their flying machine. It is named an aeroplane.

1909



The brothers are awarded the Congressional Medal for their work on the aeroplane.