

My book about

ai

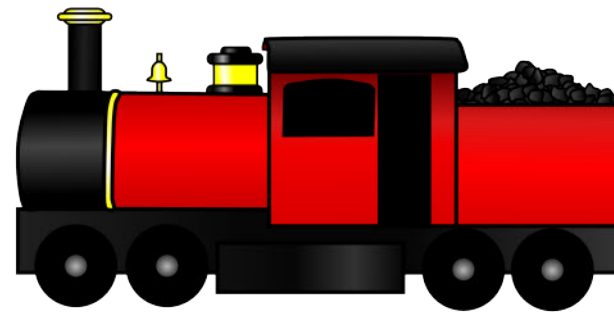

train

This book belongs to

Can you see **ai**?

Find all the ai sounds and circle them.

ai igh ee
ea a ai
ai ai ar i
d g
air ai th

Colour in the train

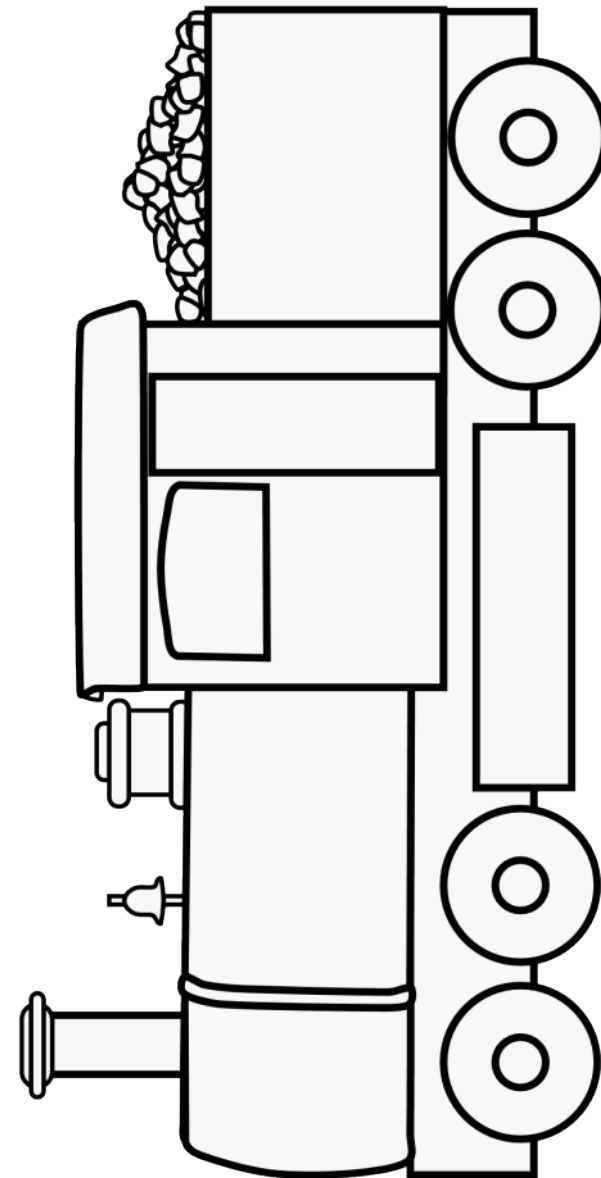

Shout out **ai**!

Slowly trace your hand along the line. When you reach an ai sound, shout it out!

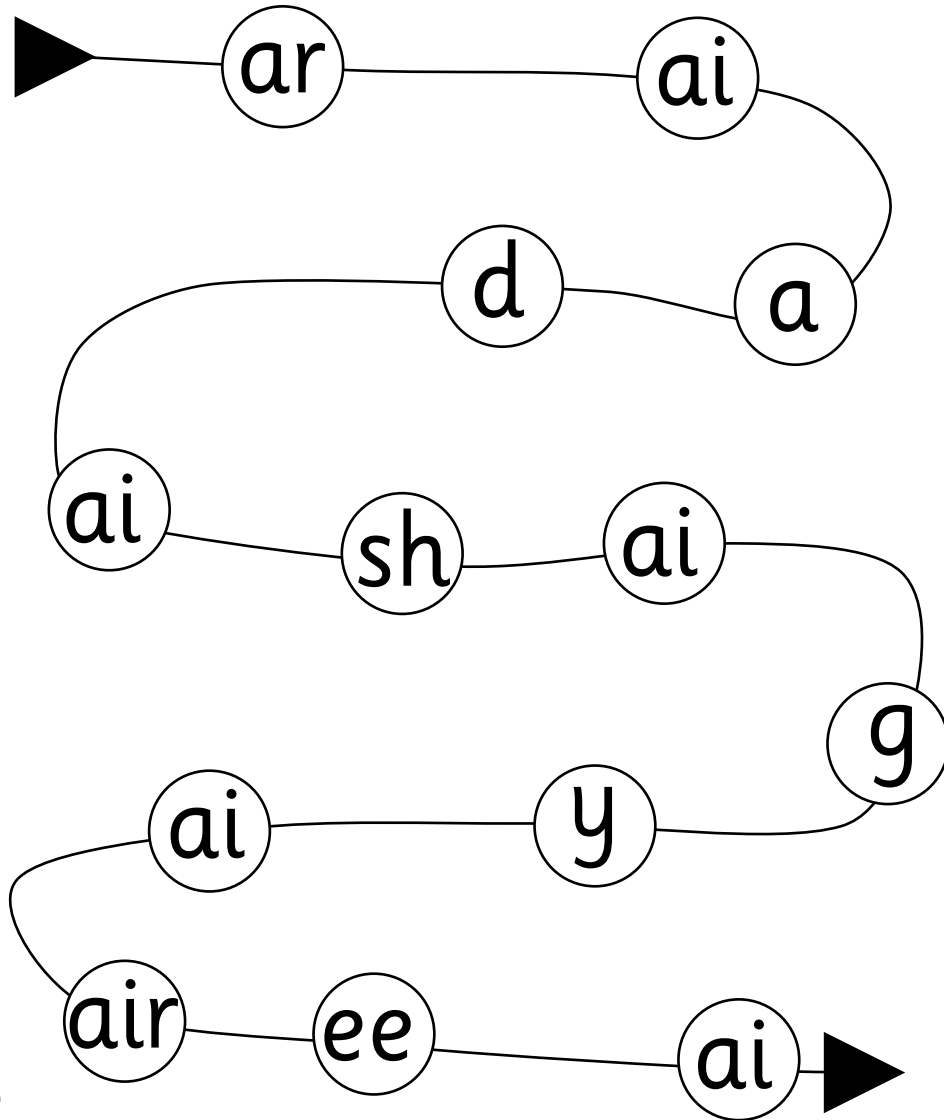

Draw a tail for the rat

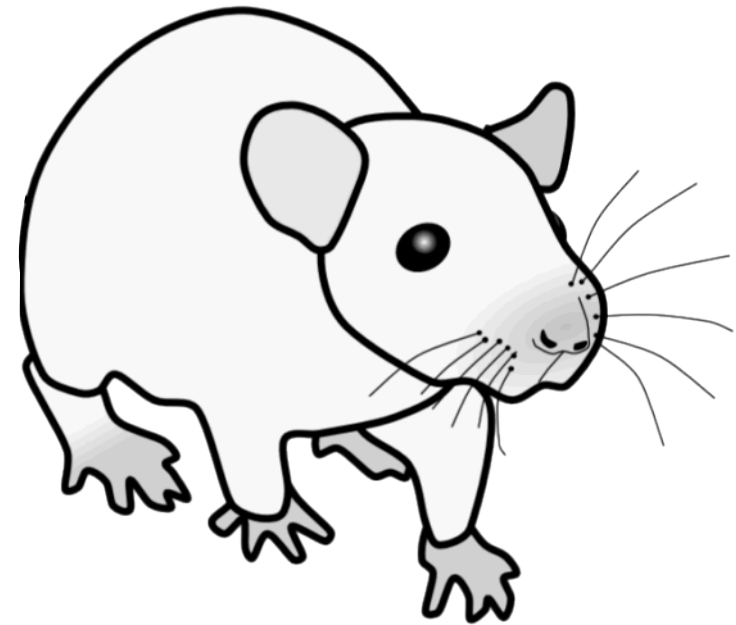

Things that have ai

Put a line through the one that does not have ai

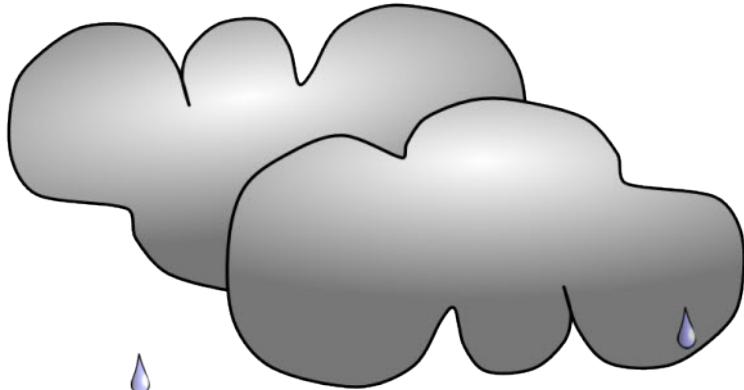

rain



trainers

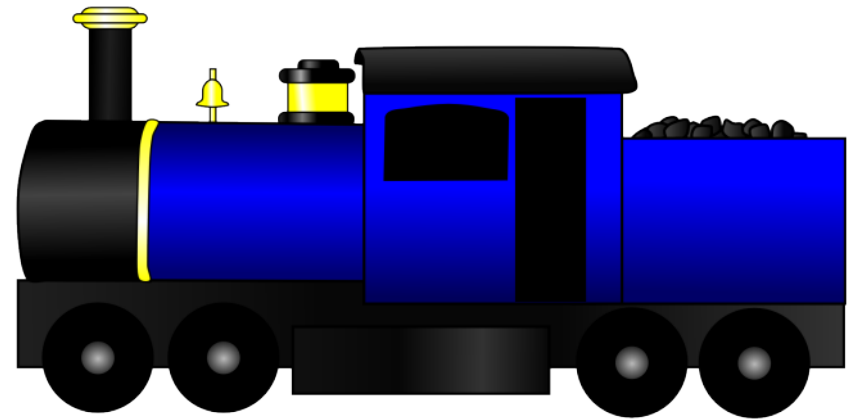

train

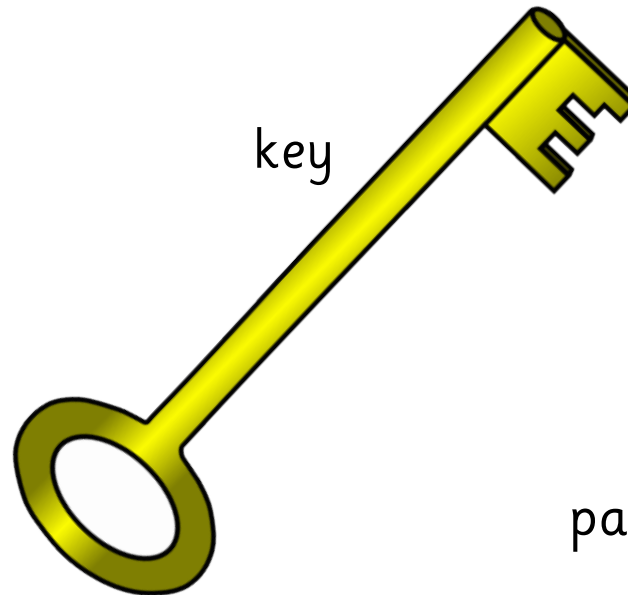

key

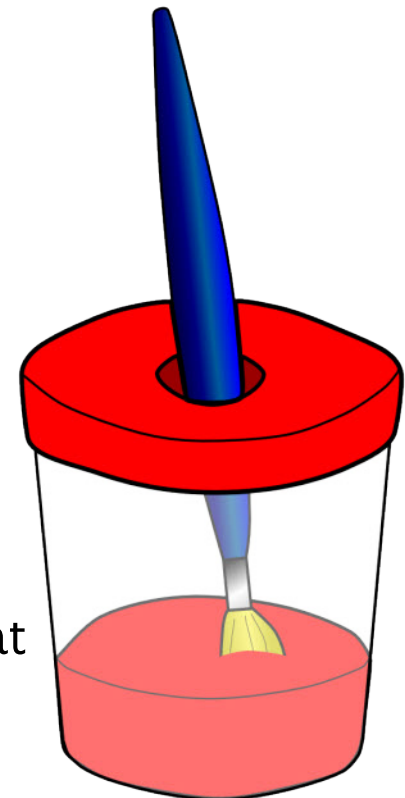

paint