

My book about

B

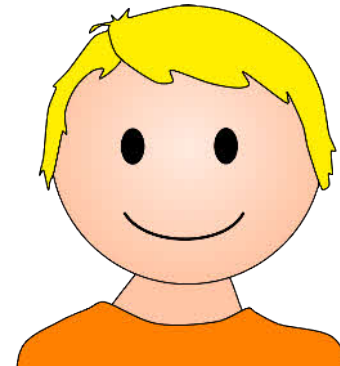

B is for Ben.

This book belongs to

SparkleBox

SparkleBox

© Copyright 2009, SparkleBox Teacher Resources
Downloaded FREE from www.sparklebox.co.uk

Can you see **B**?

Find all the B letters and circle them.

C B D
V B Z
B O F
R B Y
B G T

Draw lines from the capital B
to the lowercase 'b' sounds.

d b b e
a h o
b b l b
s b u

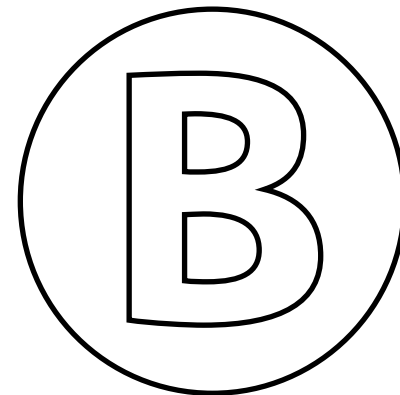

Shout out **B**!

Slowly trace your hand along the line. When you reach a letter B, shout out its name!

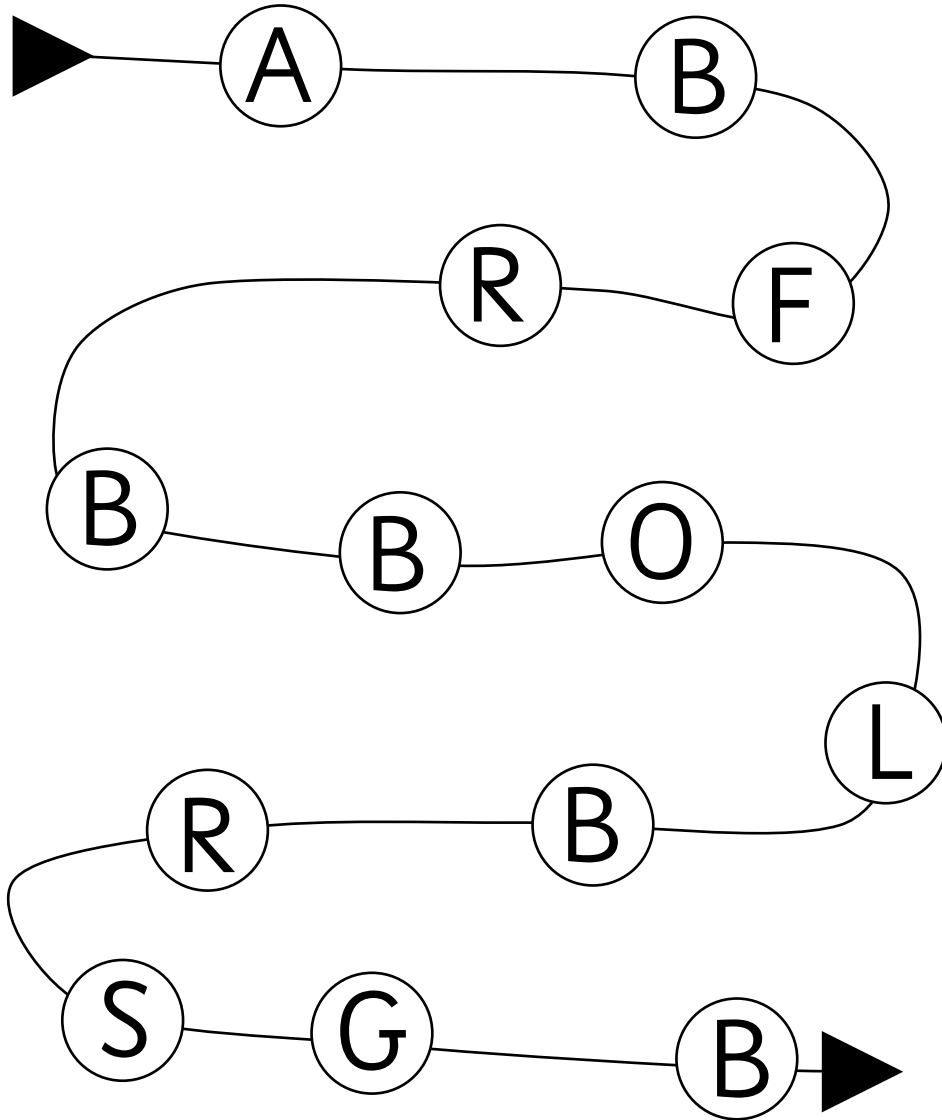

Choose 6 rainbow colours and trace over the giant B below.

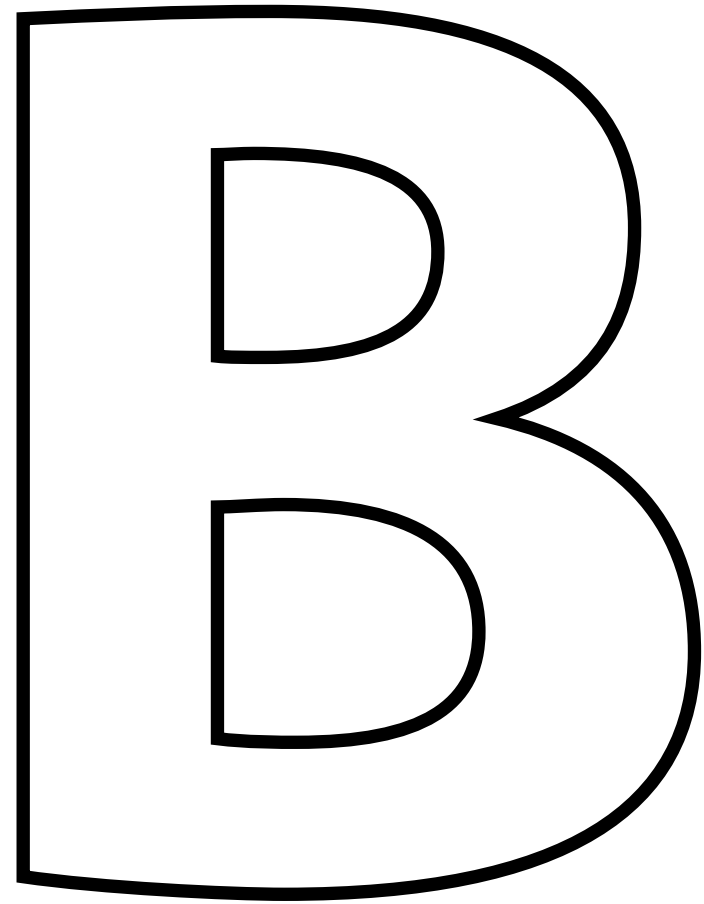

Ben and Bethany

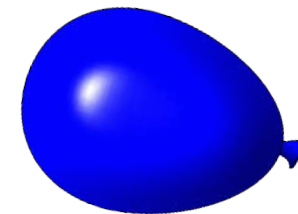

This is Ben.
His name begins with the letter B.

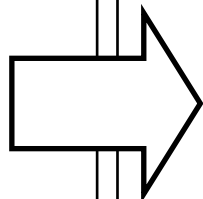
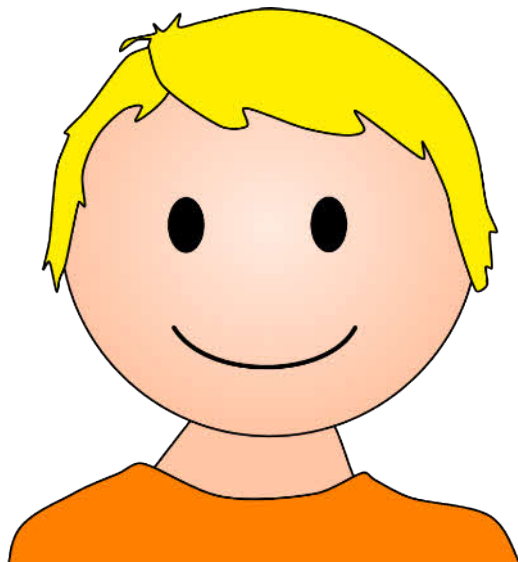

This is Bethany. She is Ben's friend.
Draw a picture of Bethany below.

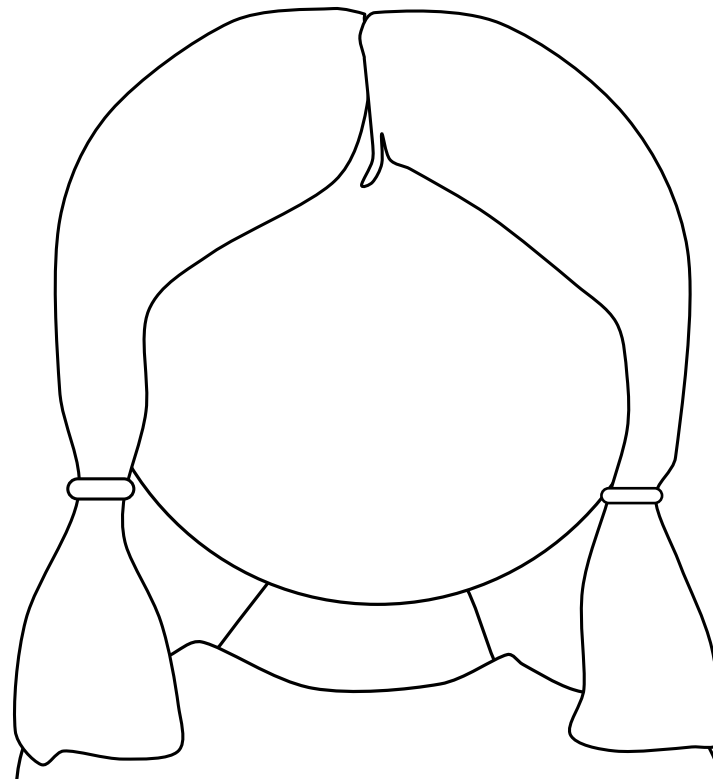

Bethany

