

My book about

H

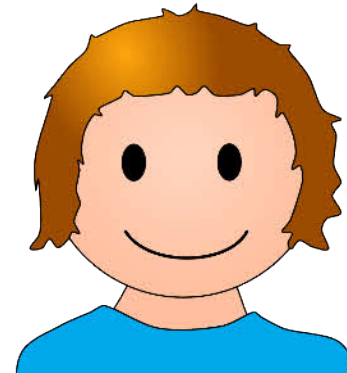

H is for Harry.

This book belongs to

SparkleBox

SparkleBox

© Copyright 2009, SparkleBox Teacher Resources
Downloaded FREE from www.sparklebox.co.uk

Can you see **H**?

Find all the H letters and circle them.

F T H
H R S
H G V
L E W N
H H

Draw lines from the capital H
to the lowercase 'h' sounds.

b g h h
h f n
d h
h n j m

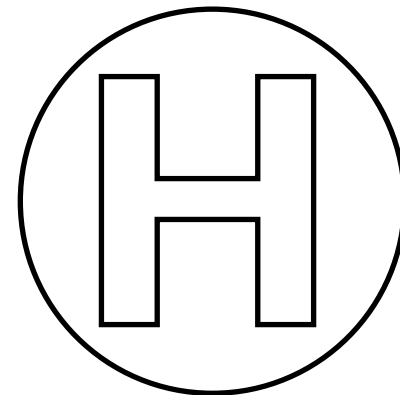

Shout out H!

Slowly trace your hand along the line. When you reach a letter H, shout out its name!

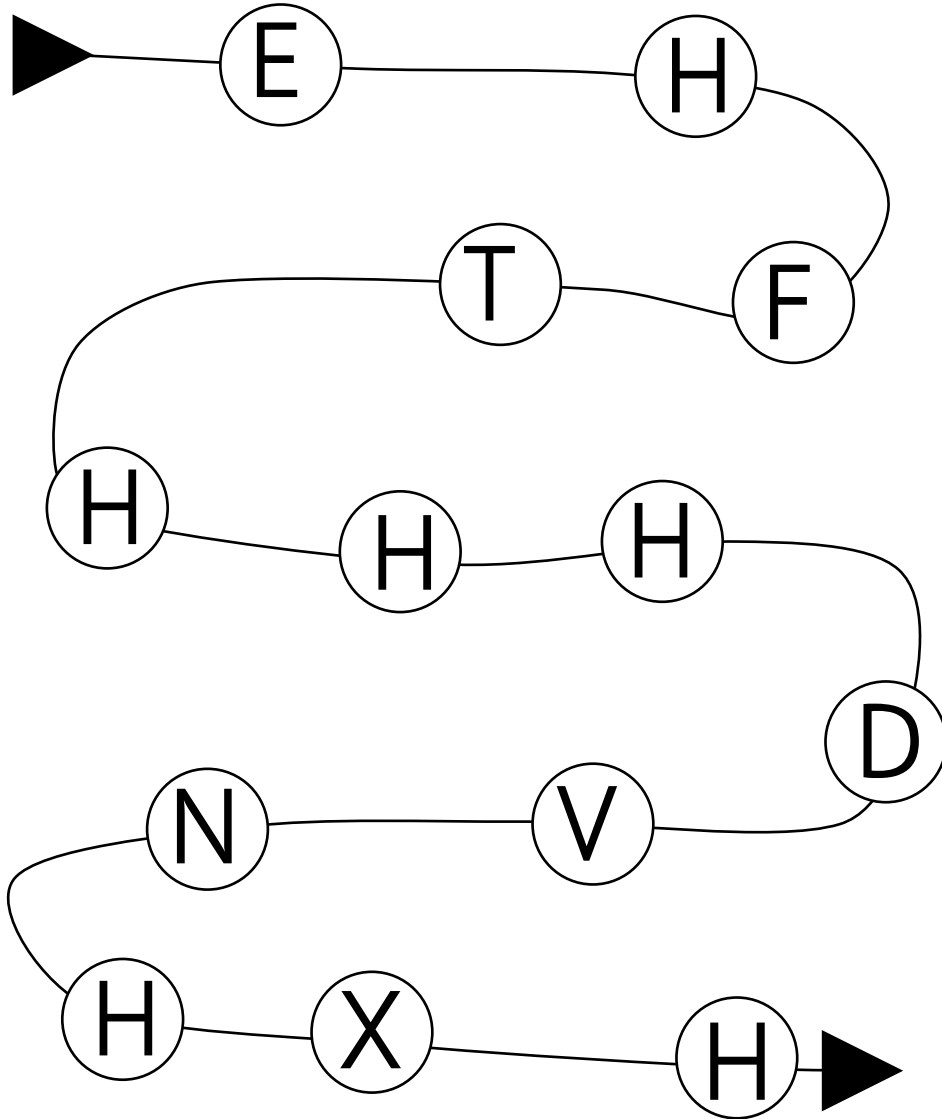

Choose 6 rainbow colours and trace within the giant H below.

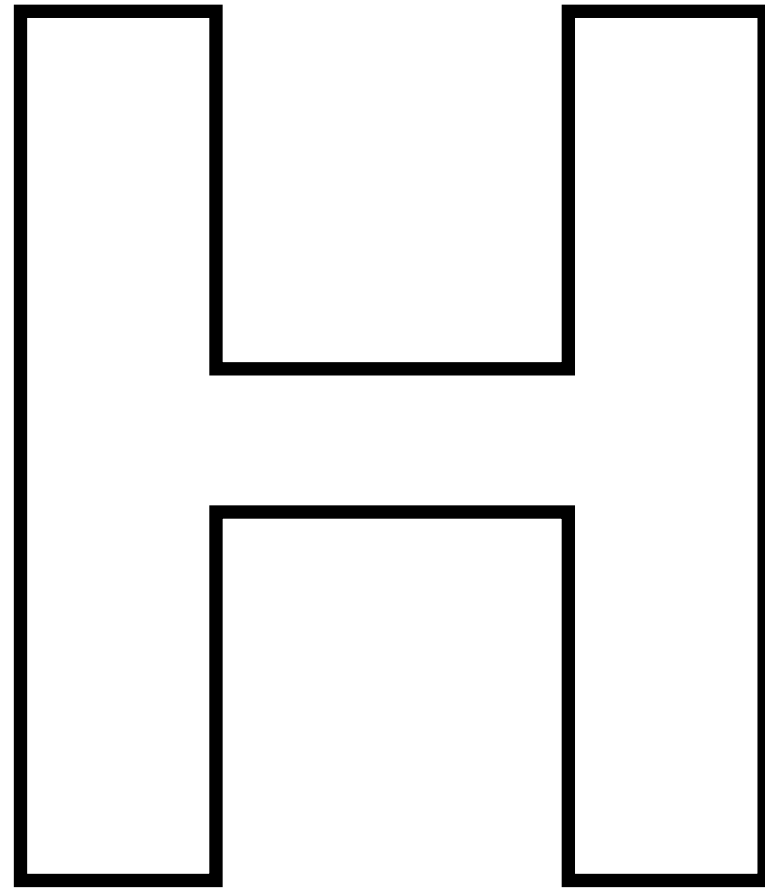

Harry and Harriet

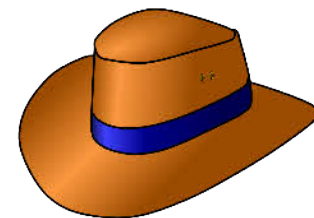

This is Harry.
His name begins with the letter H.

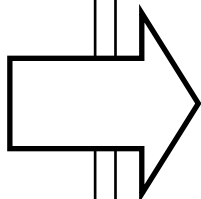
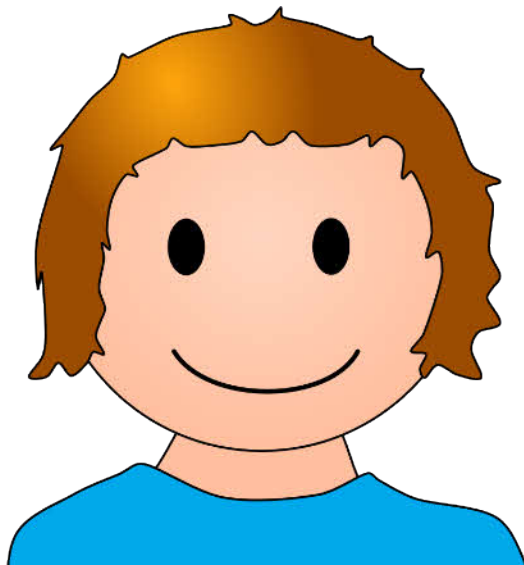

This is Harriet. She is Harry's friend.
Draw a picture of Harriet below.

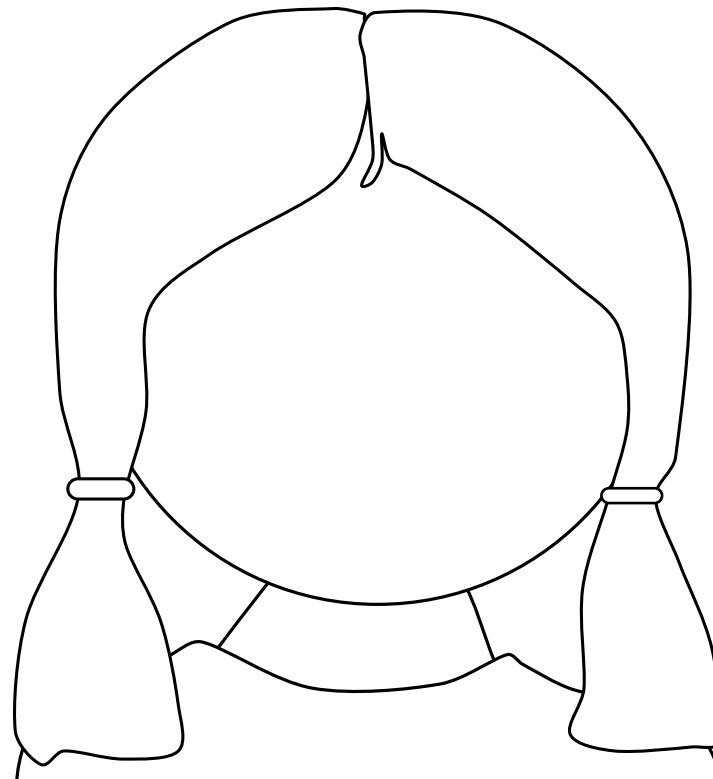

Harriet

