

My book about

J



J is for John.

This book belongs to

SparkleBox

SparkleBox

© Copyright 2009, SparkleBox Teacher Resources
Downloaded FREE from www.sparklebox.co.uk

Can you see **J**?

Find all the J letters and circle them.

G T H
J J S
E F V
J B J
Q R J

Draw lines from the capital J
to the lowercase 'j' sounds.

j g i j
l f s
j o j h
m

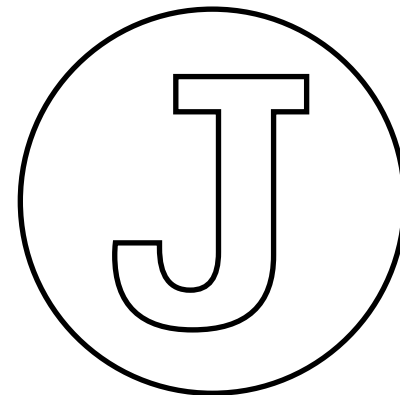

Shout out J!

Slowly trace your hand along the line. When you reach a letter H, shout out its name!

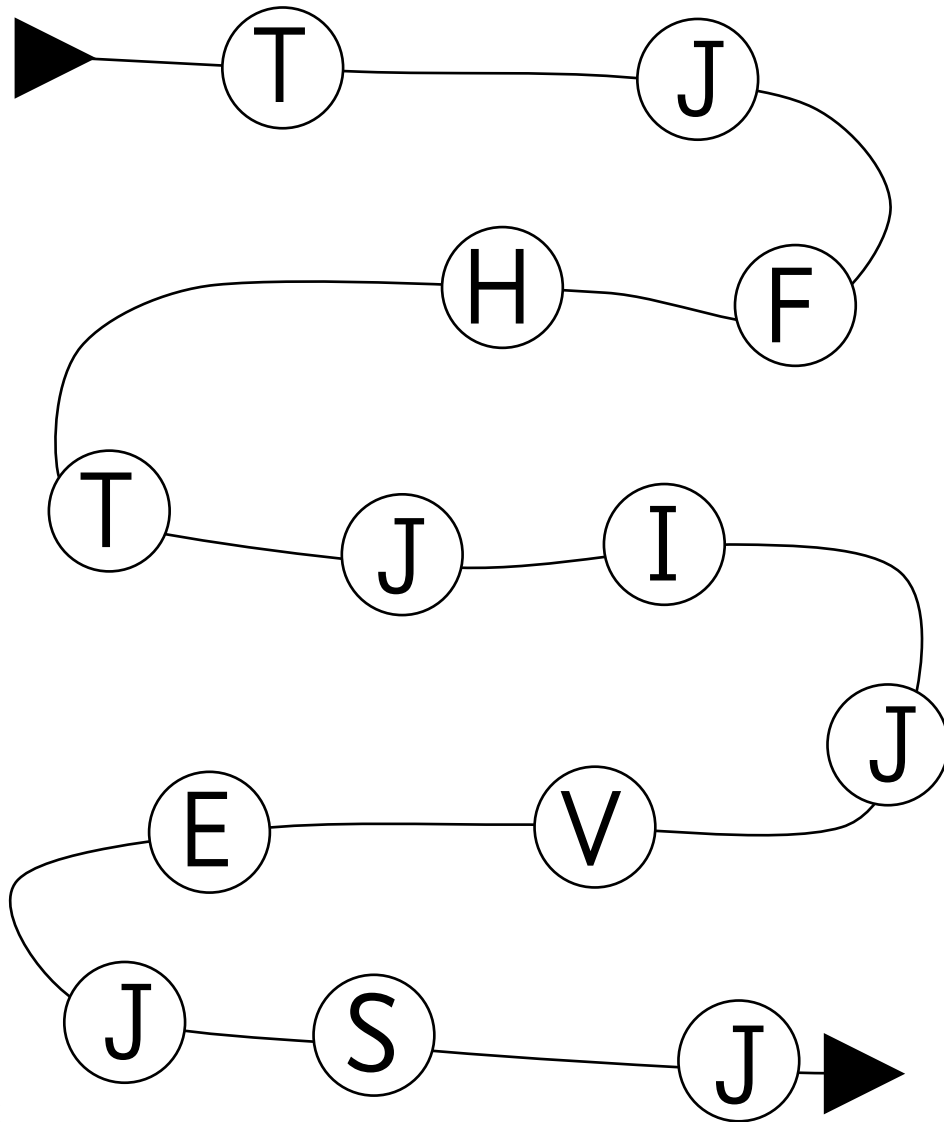

Choose 6 rainbow colours and trace within the giant J below.

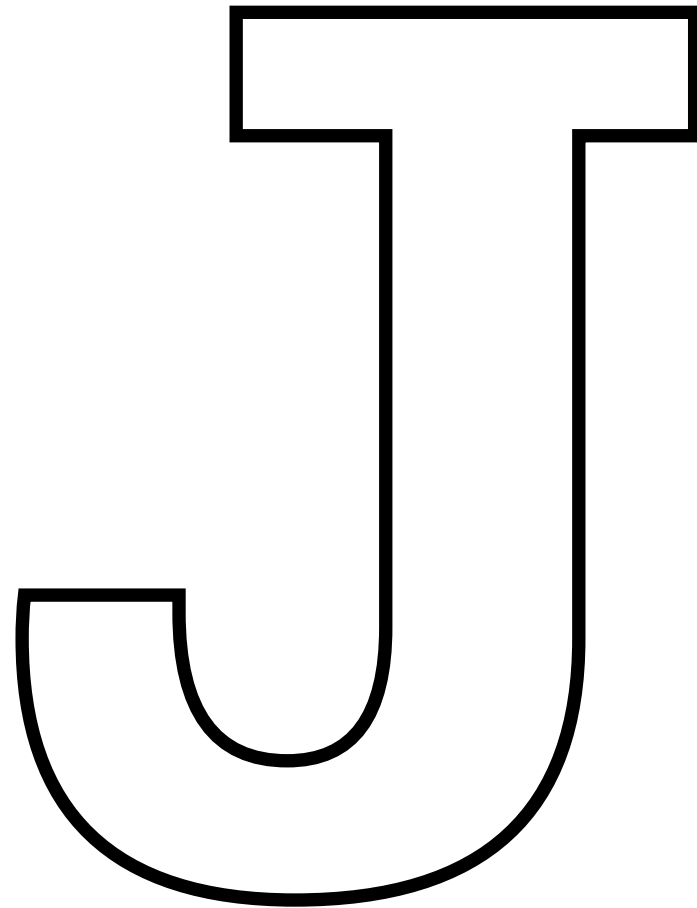

John and Jane

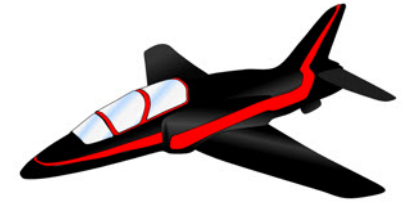
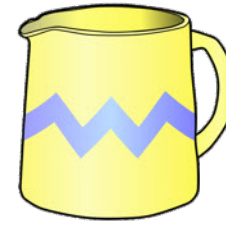
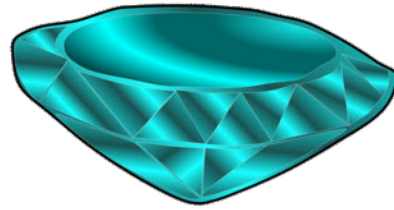

This is John.
His name begins with the letter J.

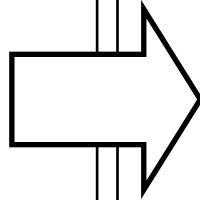
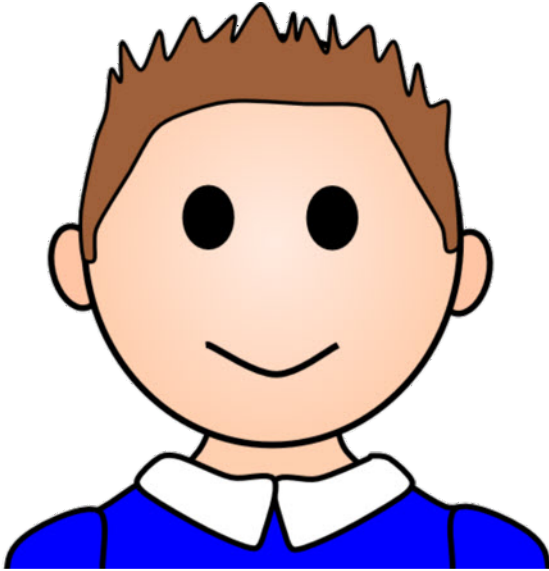

This is Jane. She is John's friend.
Draw a picture of Jane below.

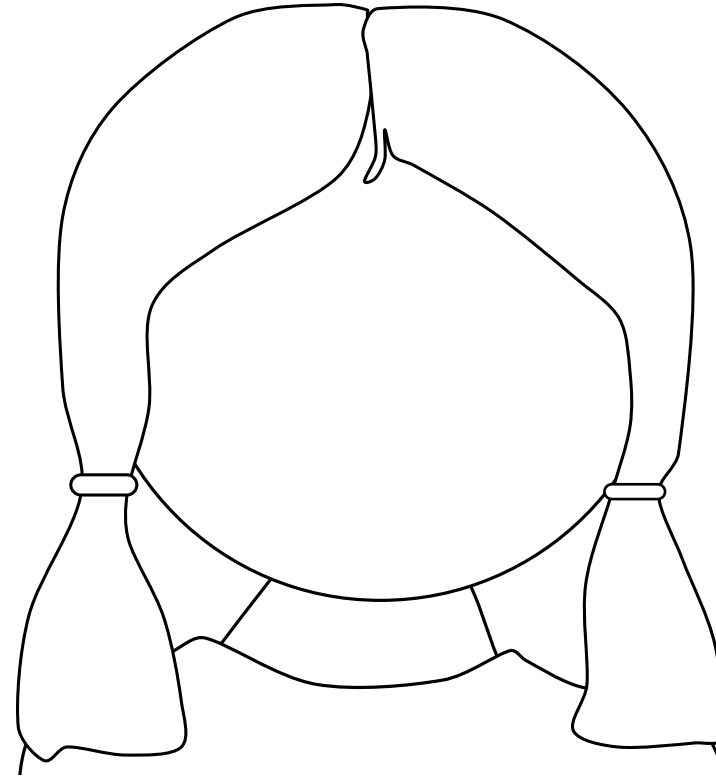

Jane

