

My book about

t

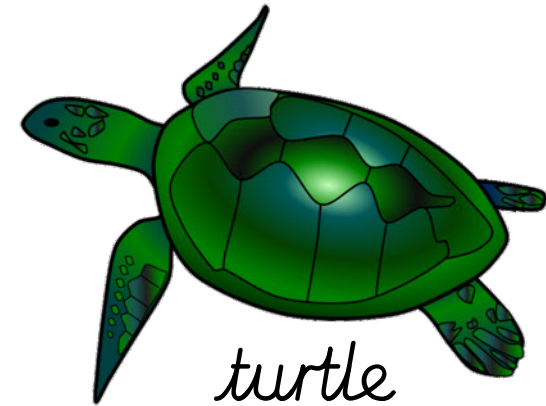

turtle

This book belongs to

---

SparkleBox

SparkleBox

© Copyright 2009, SparkleBox Teacher Resources  
Downloaded FREE from [www.sparklebox.co.uk](http://www.sparklebox.co.uk)

Can you see t?

Find all the t sounds and circle them.

t d f a  
b t h t  
t d f  
t k t l

Colour the train.

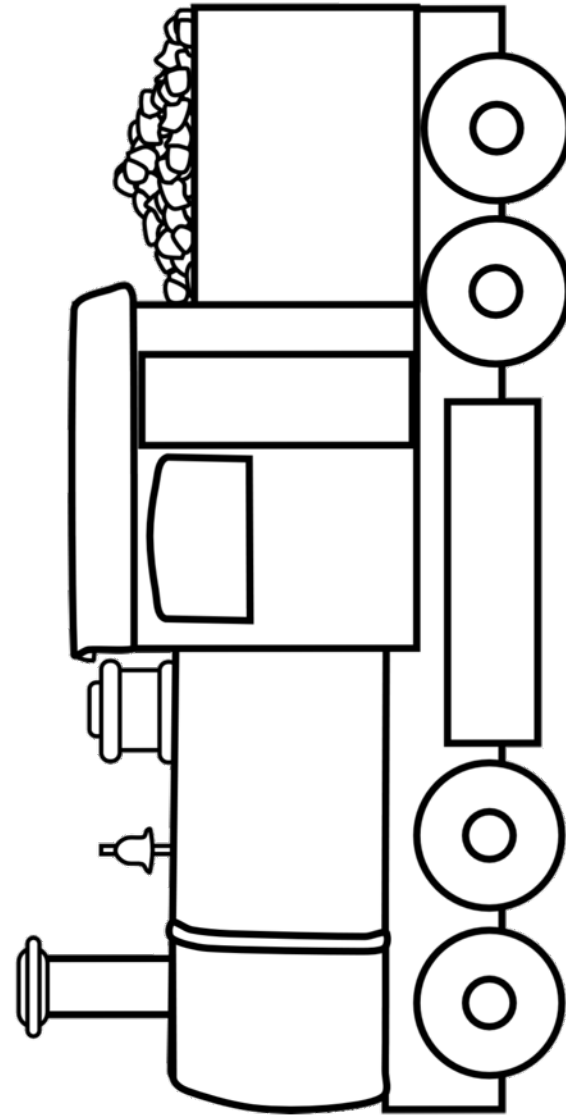

# Shout out t!

Slowly trace your hand along the line.  
When you find a t sound, shout it out!

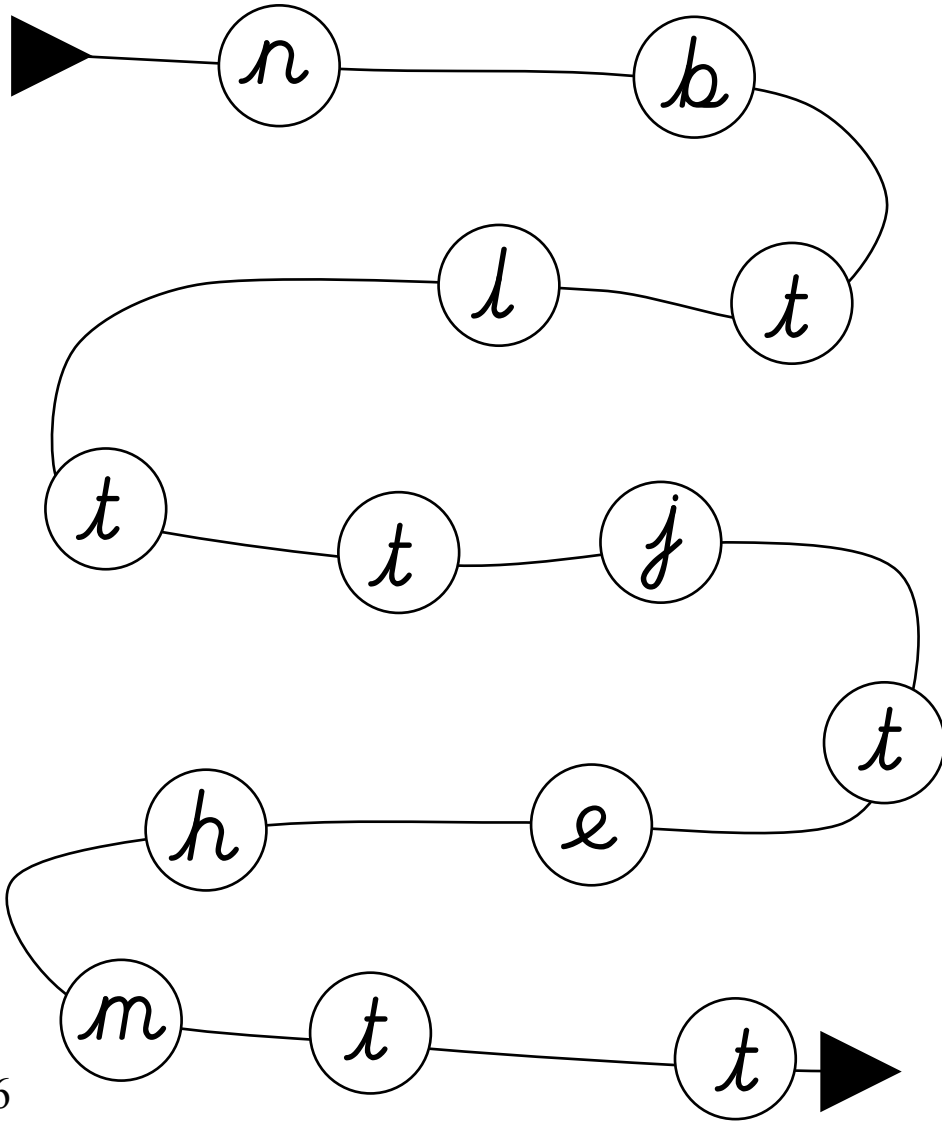

# Colour in the tractor.

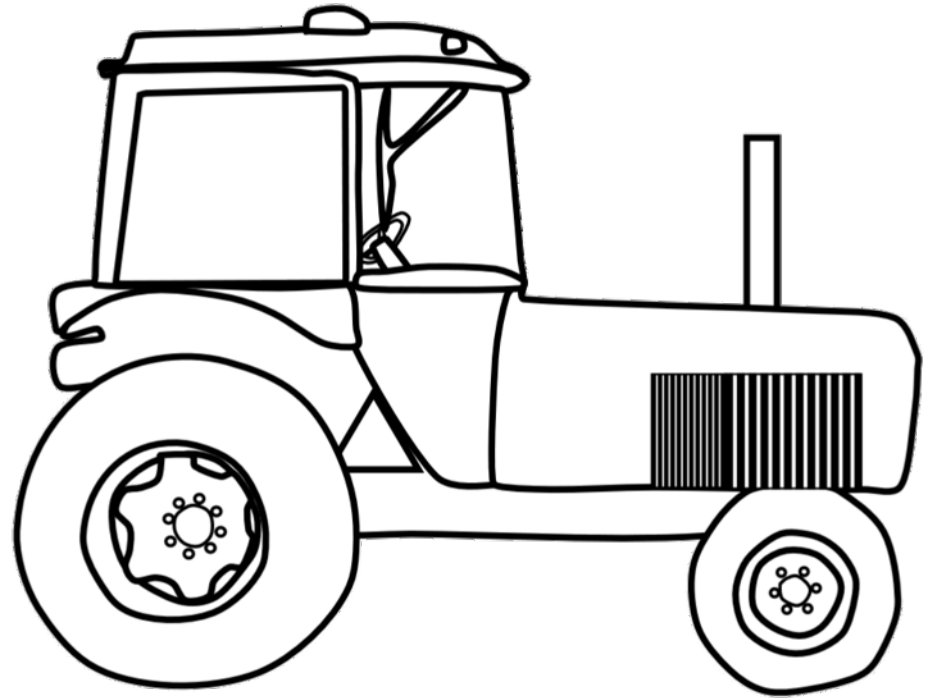

# Things that begin with t.

Put a line through the one that does not begin with t.

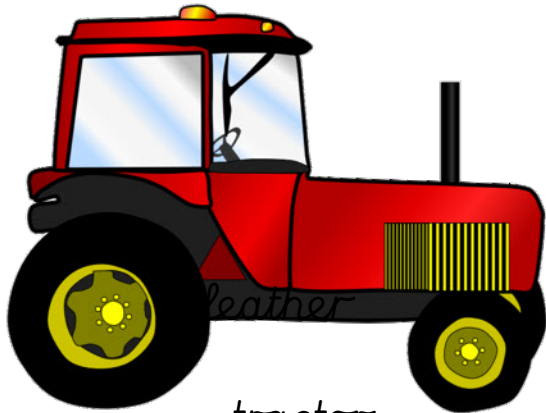

tractor



tambourine

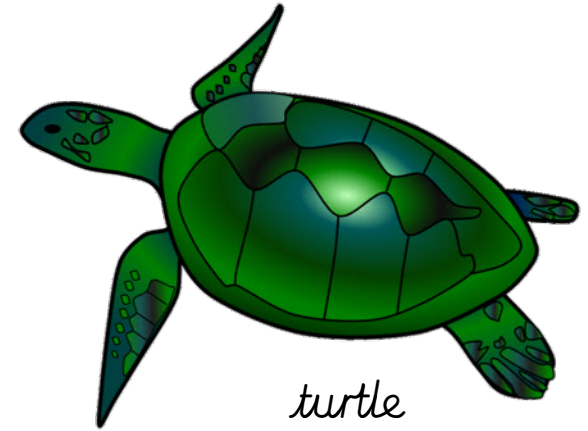

turtle

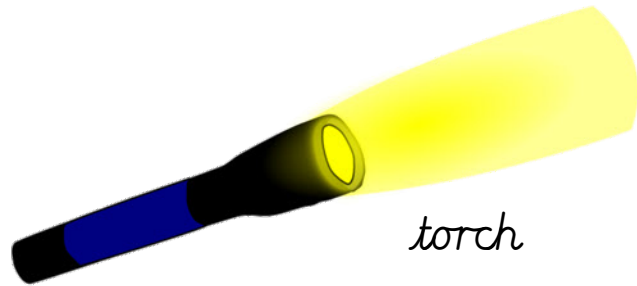

torch

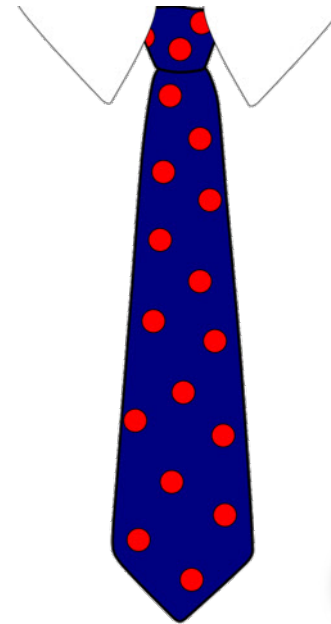

tie

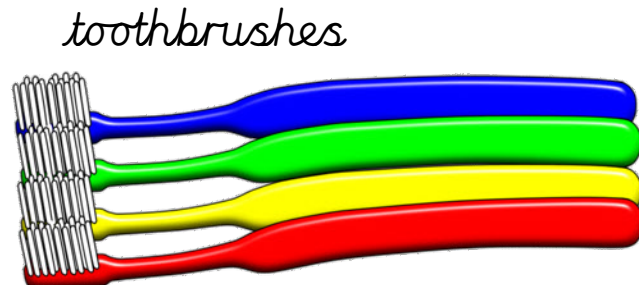

toothbrushes



mouse



tiger