

My book about

M

© Copyright 2010, www.sparklebox.co.uk

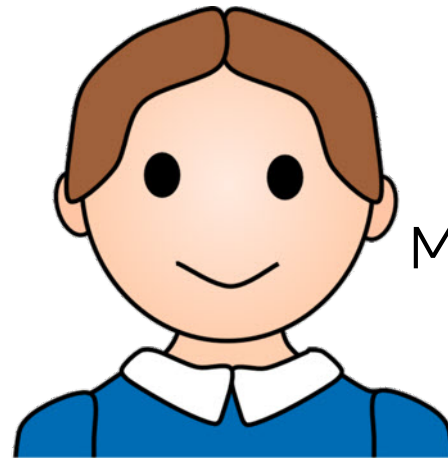

M is for Michael

This book belongs to

SparkleBox

Can you see **M**?

Find all the M letters and circle them.

W N M M
K X V N
M
A B M
Z M W

Draw lines from the capital M to the lowercase 'm' sounds.

n h r n
m
n m
m h
u e m
m t

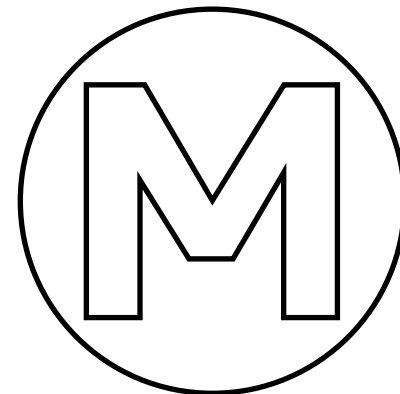

Shout out M!

Slowly trace your hand along the line. When you reach a letter M, shout out its name!

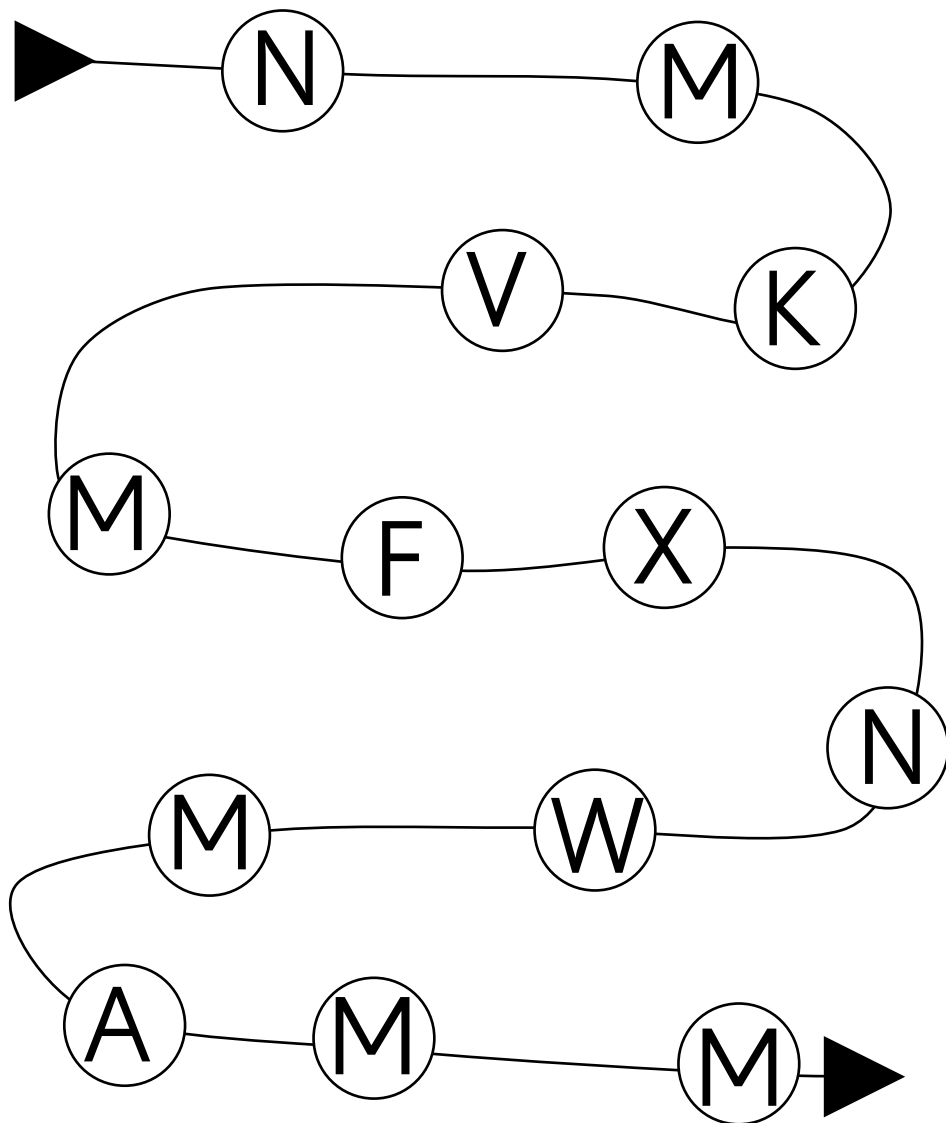

Choose 6 rainbow colours and trace within the giant M below.

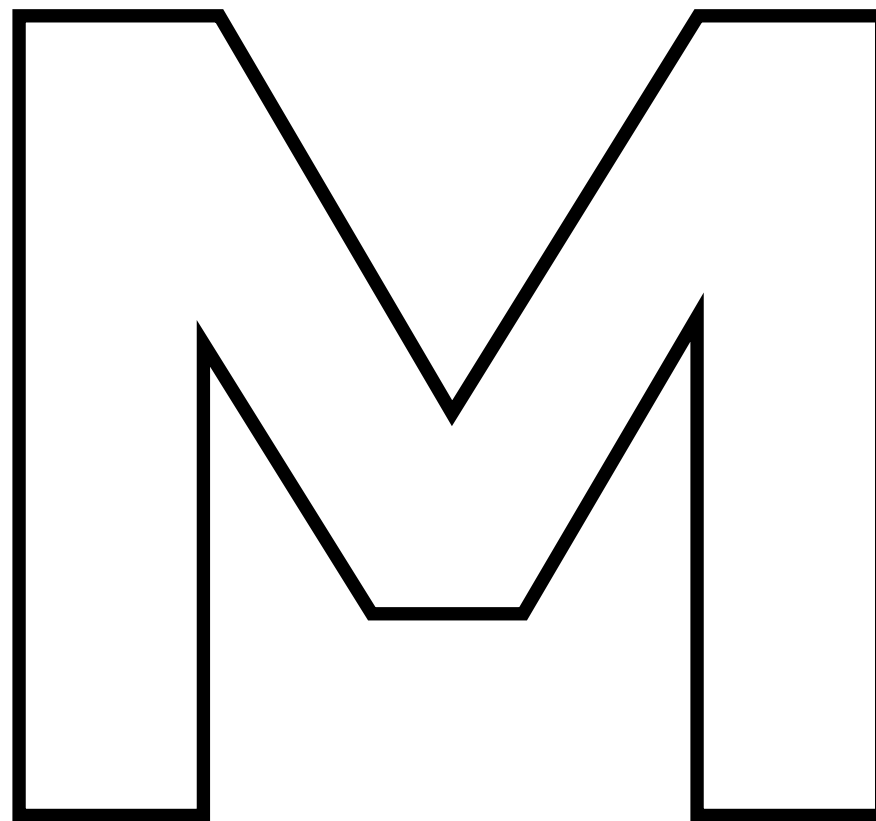

Michael and Matthew

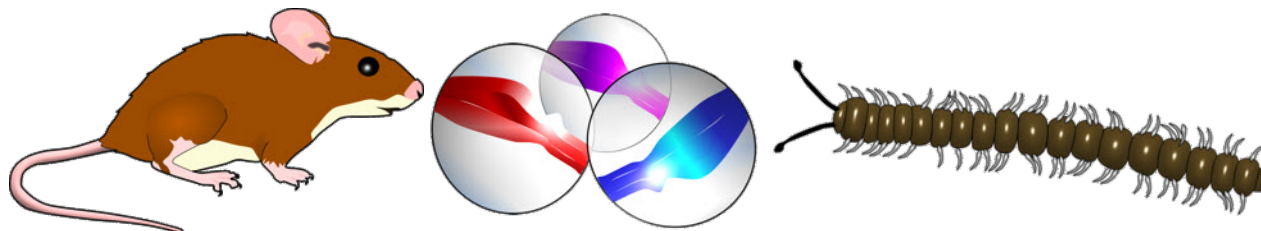

This is Michael.
His name begins with the letter M.

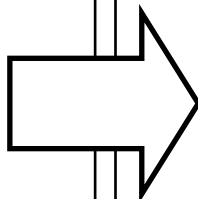
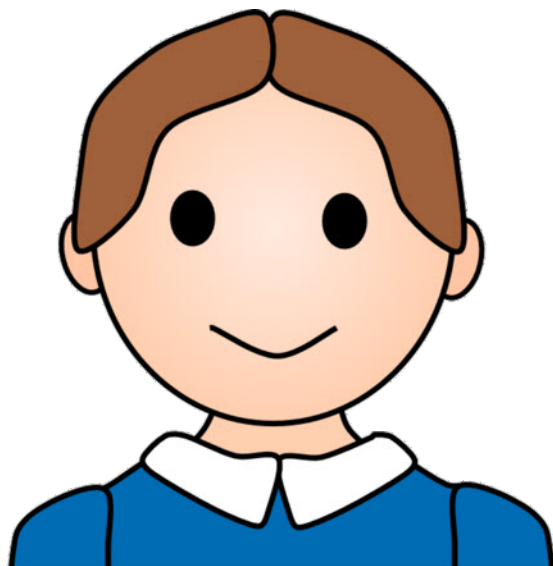

This is Matthew. He is Michael's friend.
Finish the picture of Matthew below.

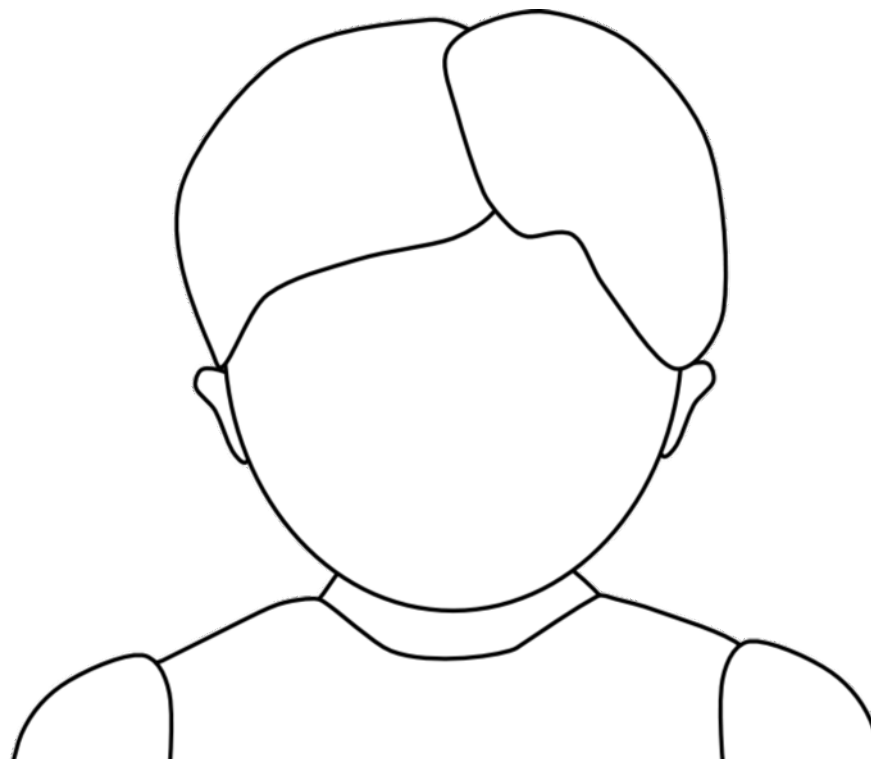

Matthew

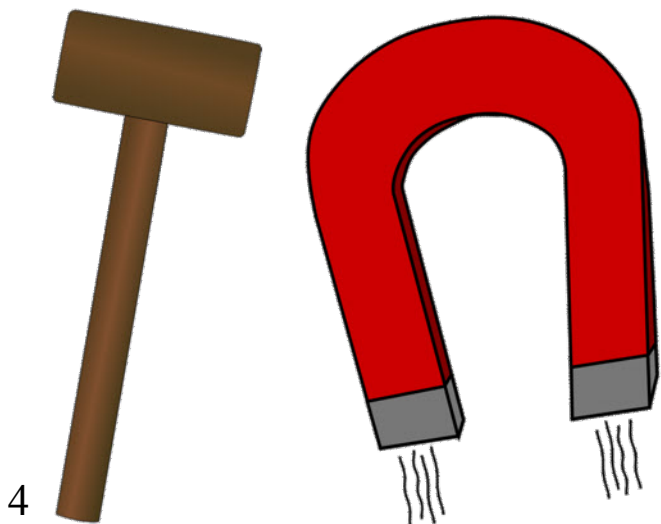

4