

My book about

P

© Copyright 2010, www.sparklebox.co.uk

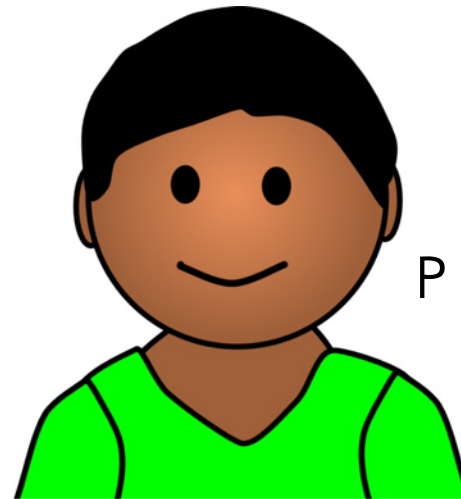

P is for Peter

This book belongs to

Can you see P?

Find all the P letters and circle them.

R B P R
C P Q P
A S O
J P P

Draw lines from the capital P to the lowercase 'p' sounds.

p j b p
q p d o
a o p q
p o

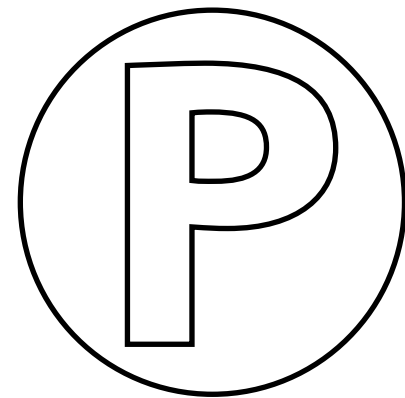

Shout out P!

Slowly trace your hand along the line. When you reach a letter P, shout out its name!

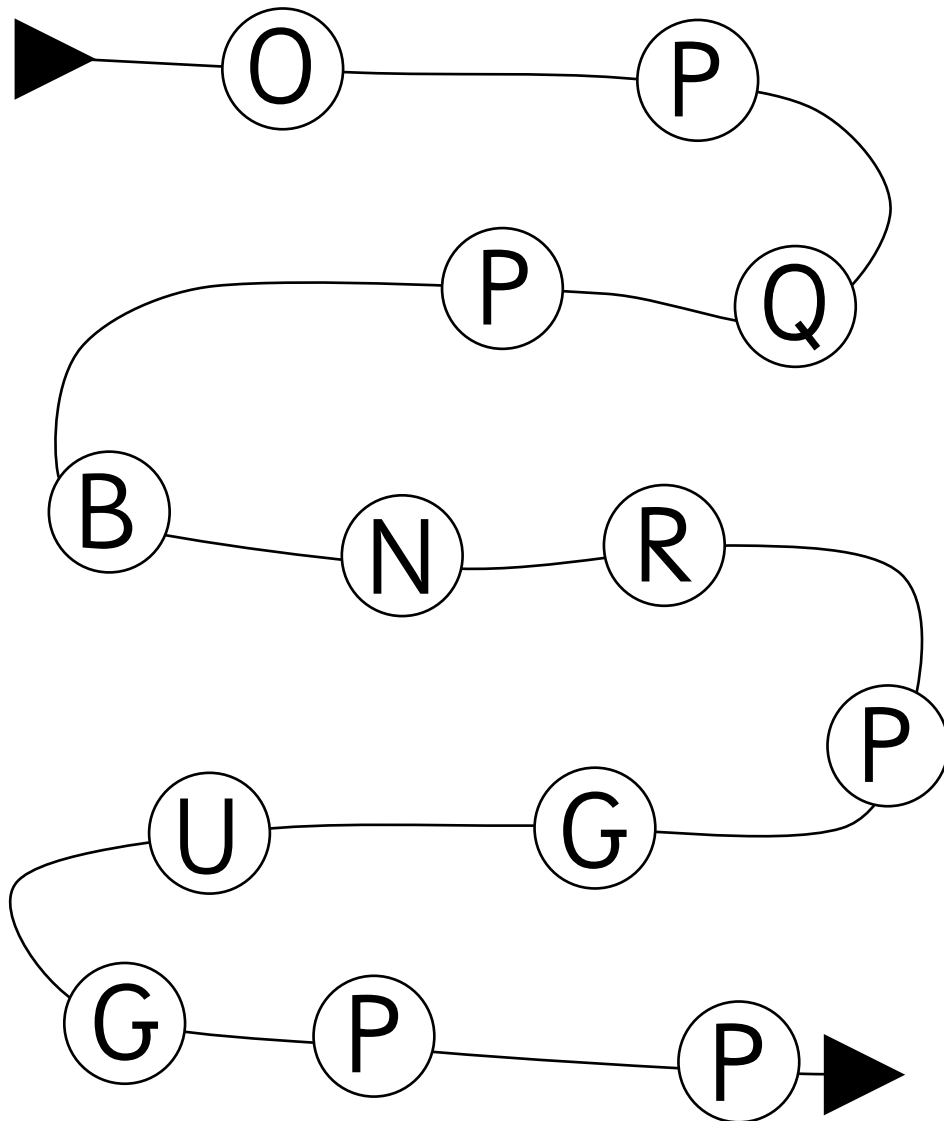

Choose 6 rainbow colours and trace within the giant P below.

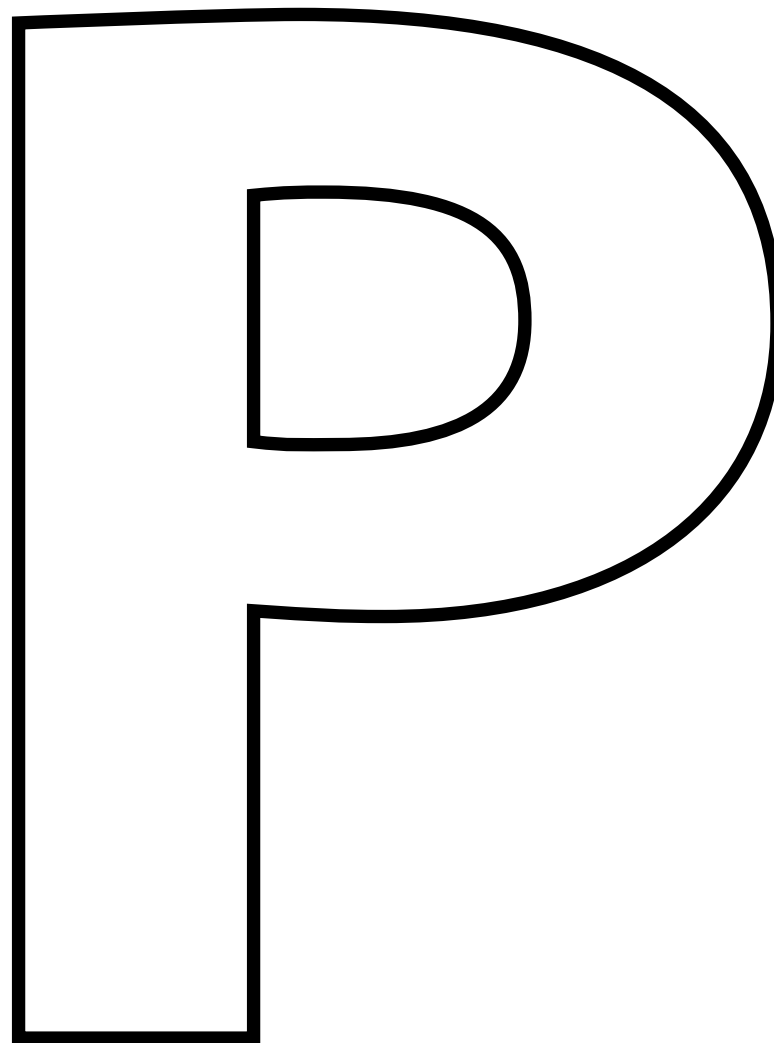

Peter and Penny

This is Peter.
His name begins with the letter P.

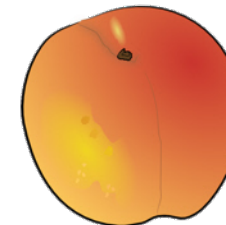
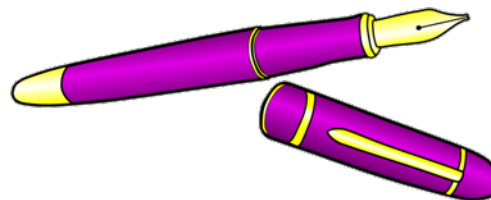
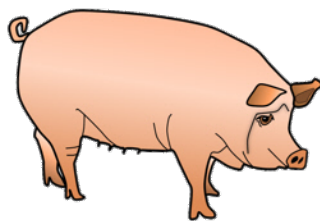
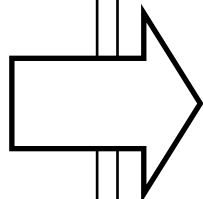
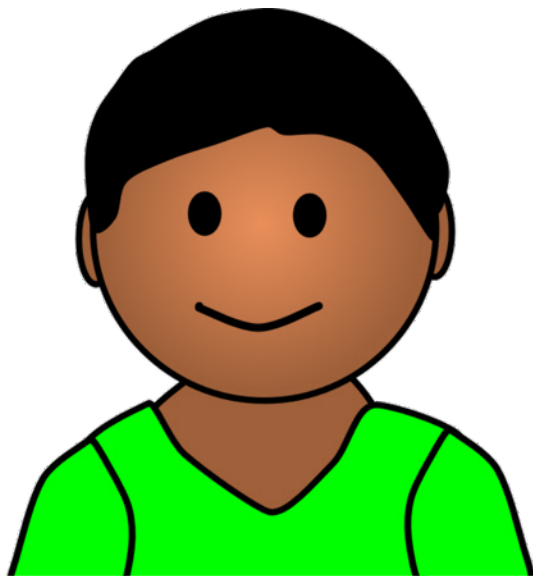

This is Penny. She is Peter's friend.
Finish the picture of Penny below.

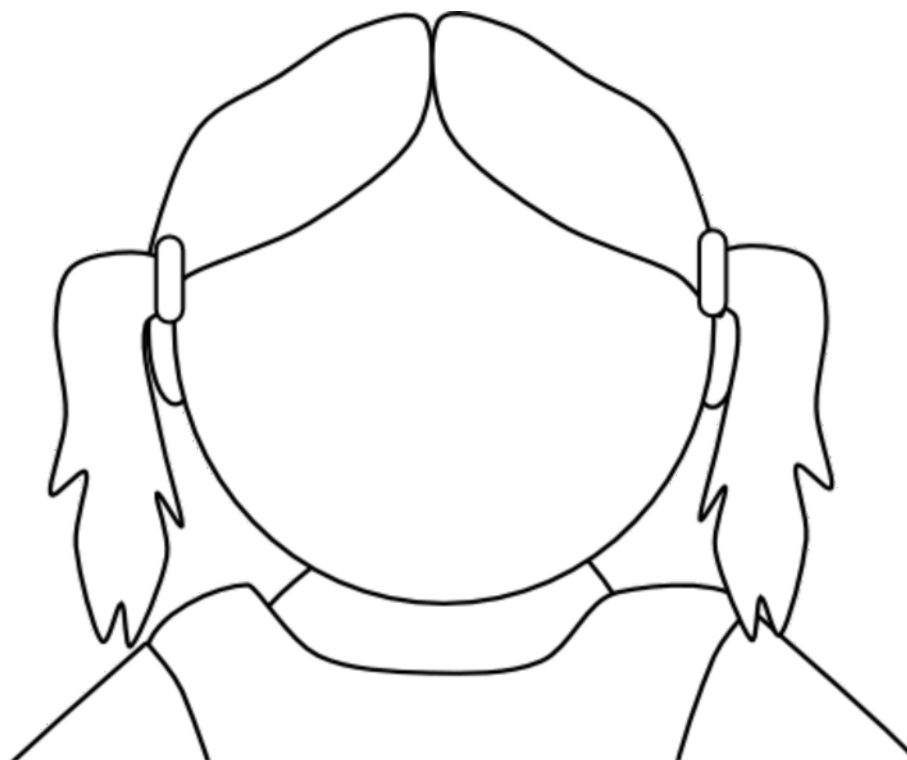

Penny

