

Jack and Jill went up the hill,
To fetch a pail of water.
Jack fell down and broke his crown,
And Jill came tumbling after.

Up Jack got and home he ran,
As fast as he could caper.
He went to bed and bound his head,
With vinegar and brown paper.

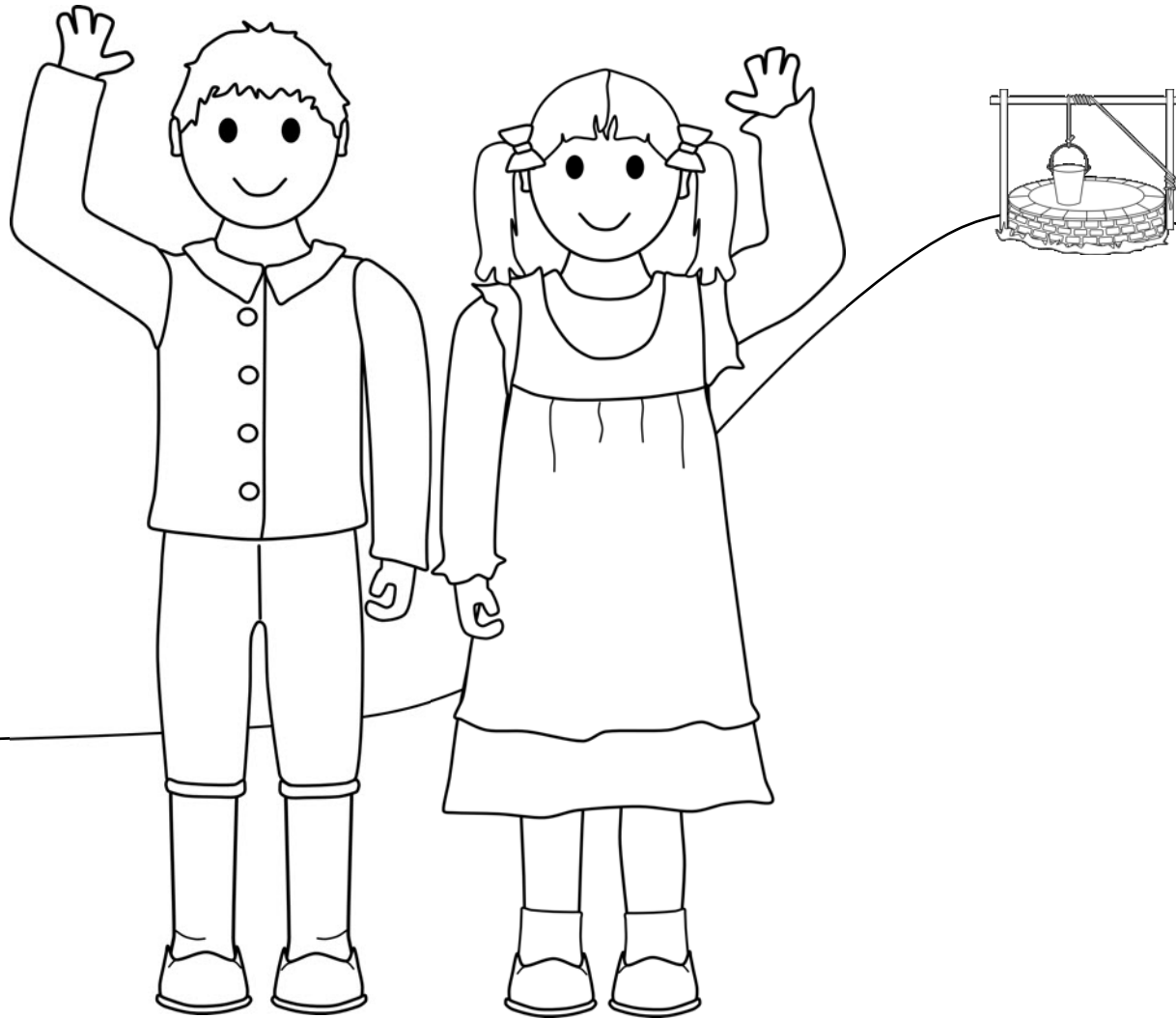

Jack and Jill went up the hill...

...to fetch a pail of water.

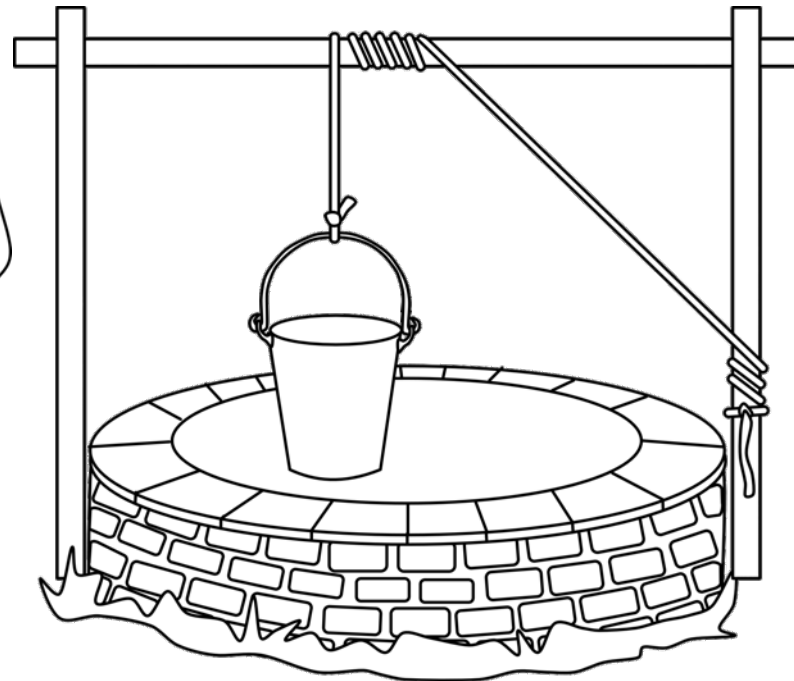
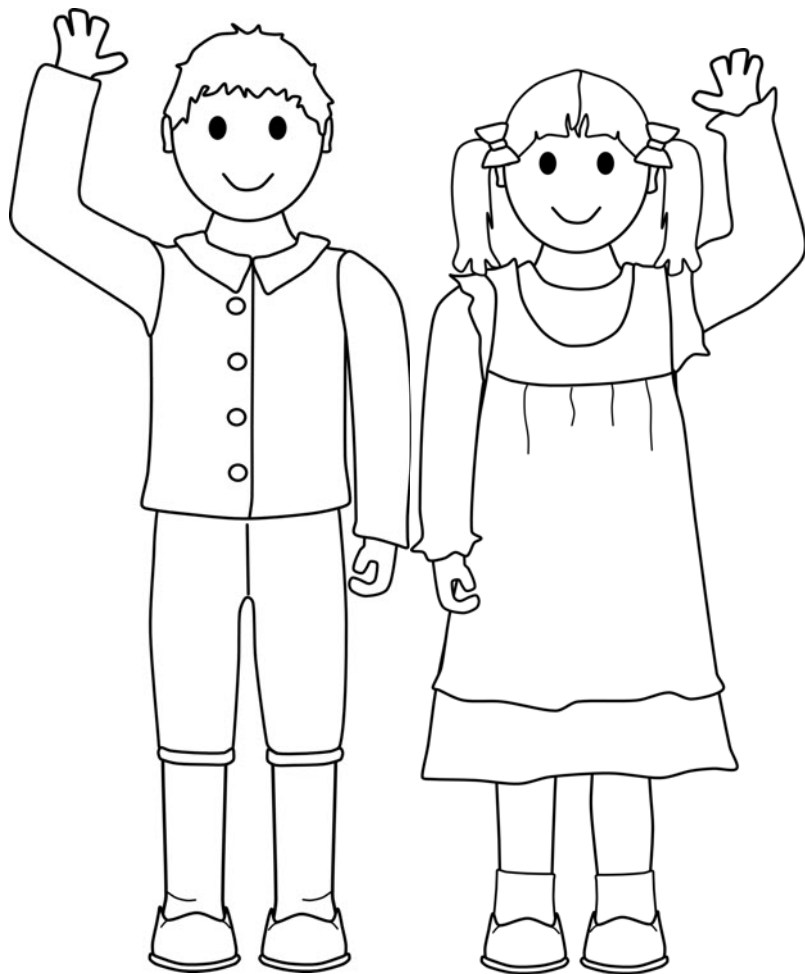

Jack fell down and
broke his crown...

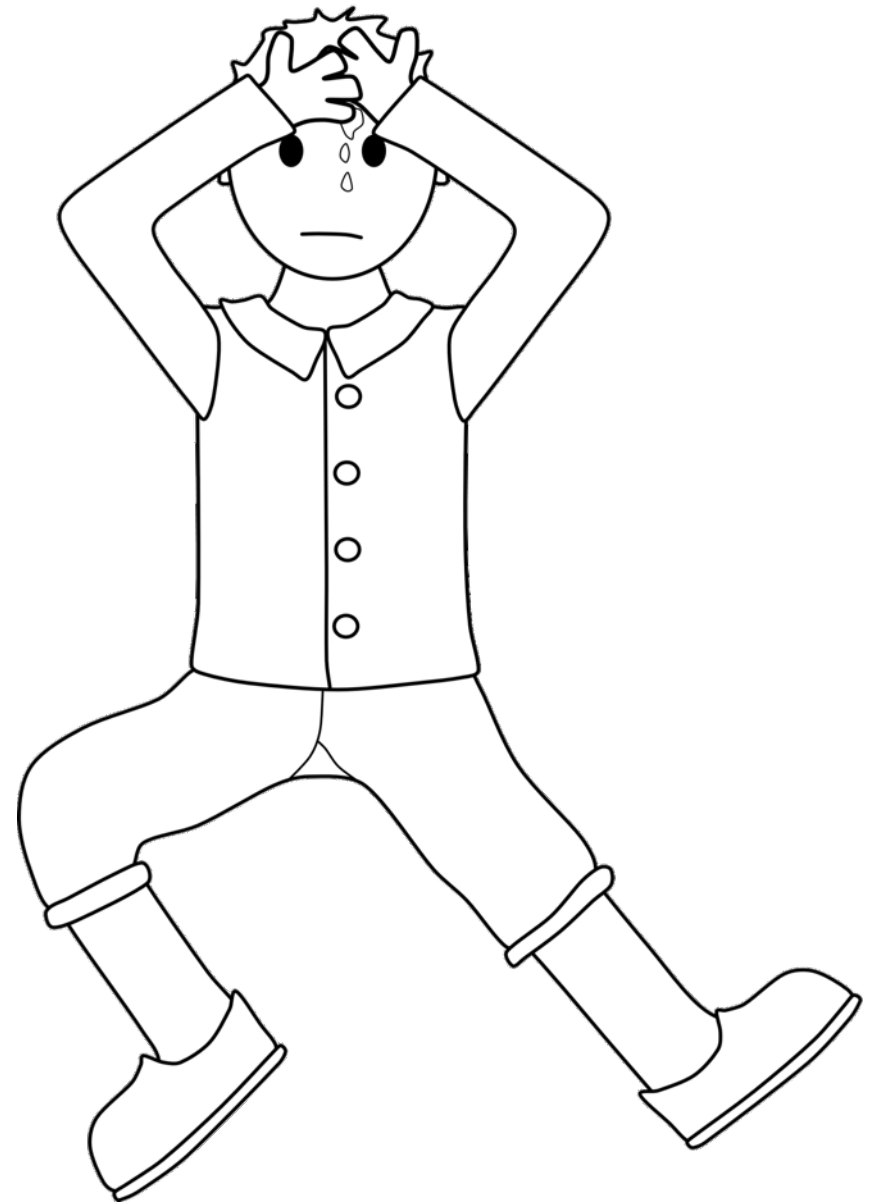

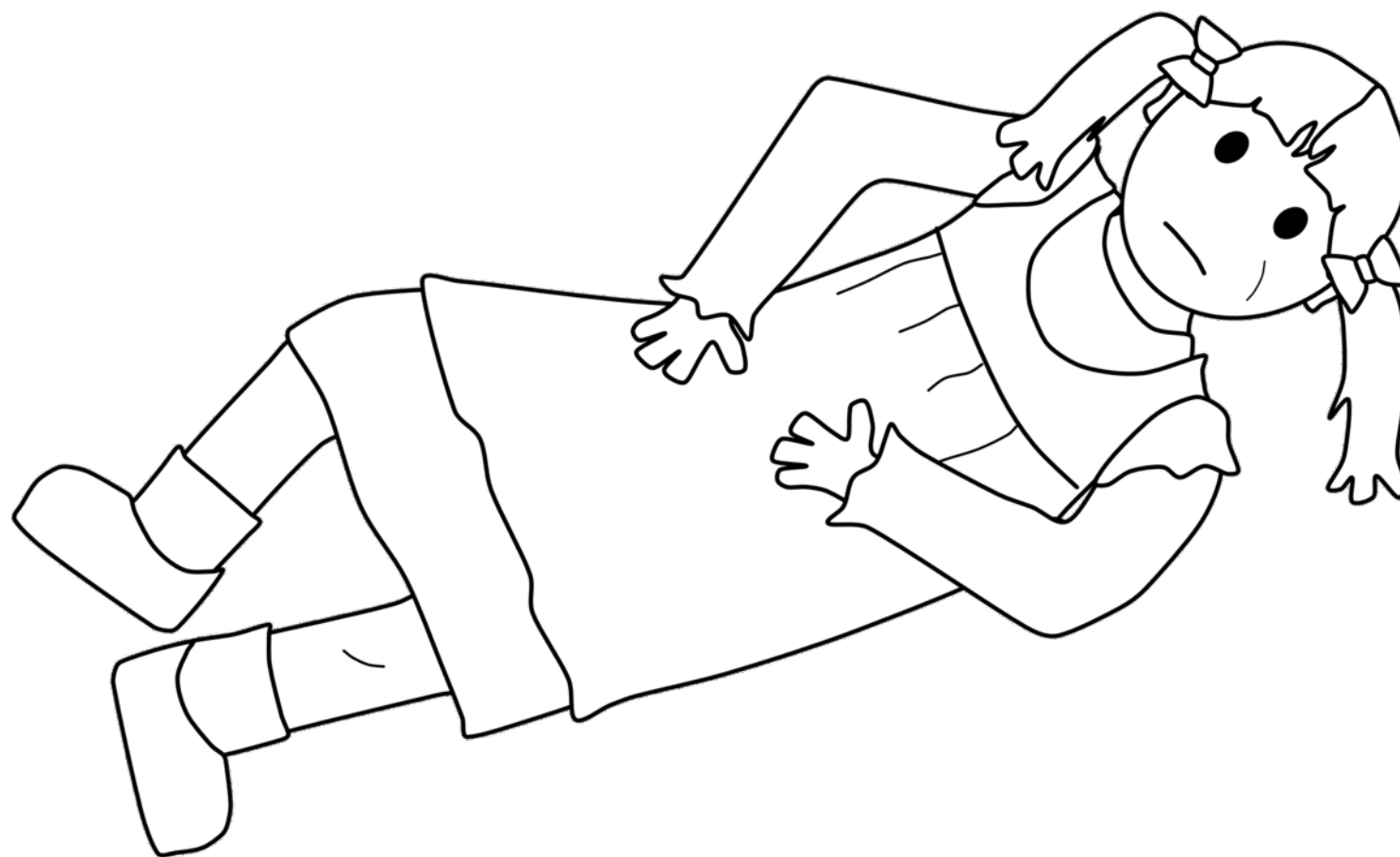

...and Jill came tumbling after.

Up Jack got and home he ran...



...as fast as he could caper.

He went to bed and bound his head...

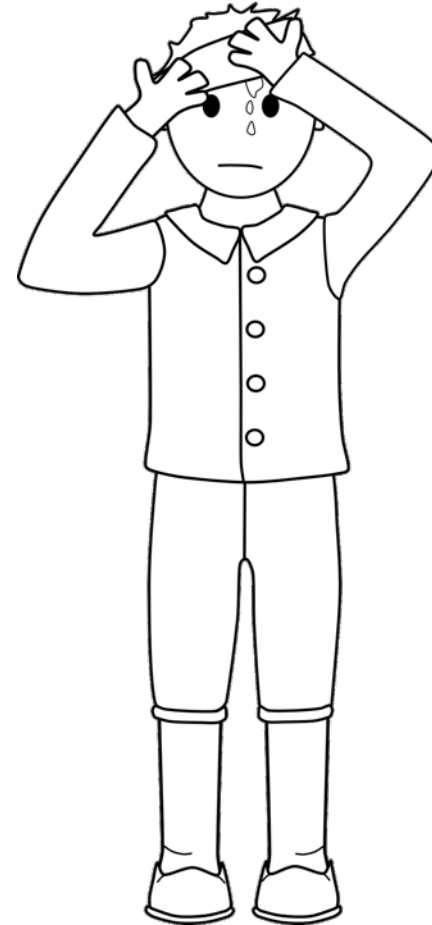
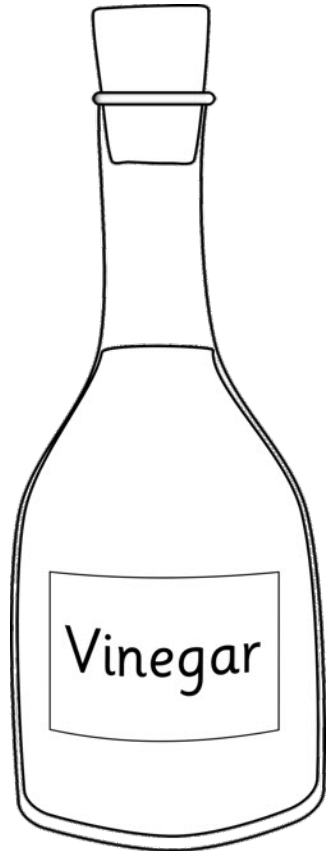

...with vinegar and brown paper.