

Can you make a playdough snake that is shorter?

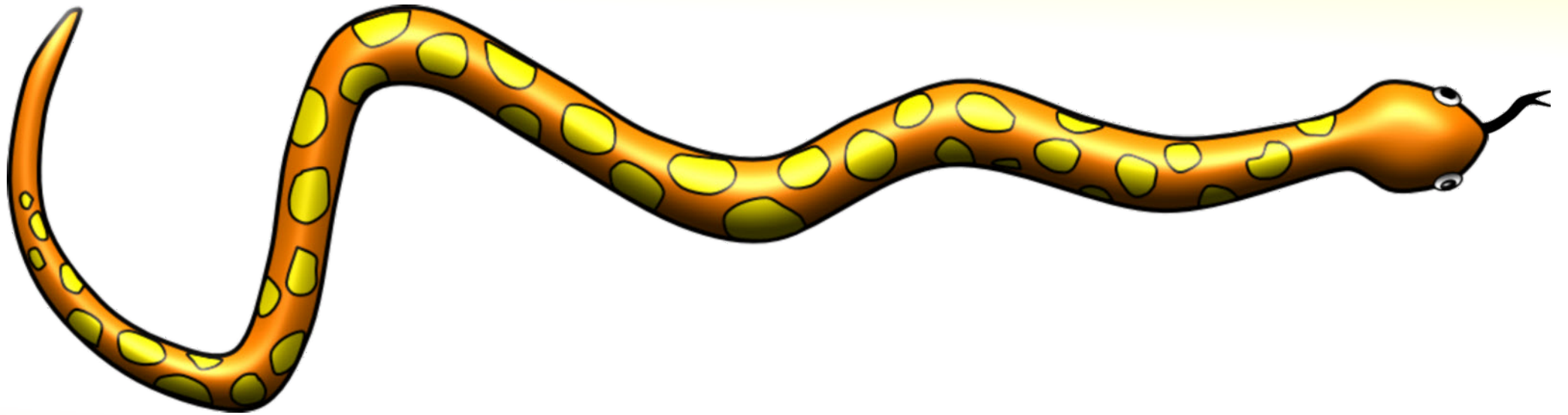

shorter

Can you give the green alien antennae that are longer?

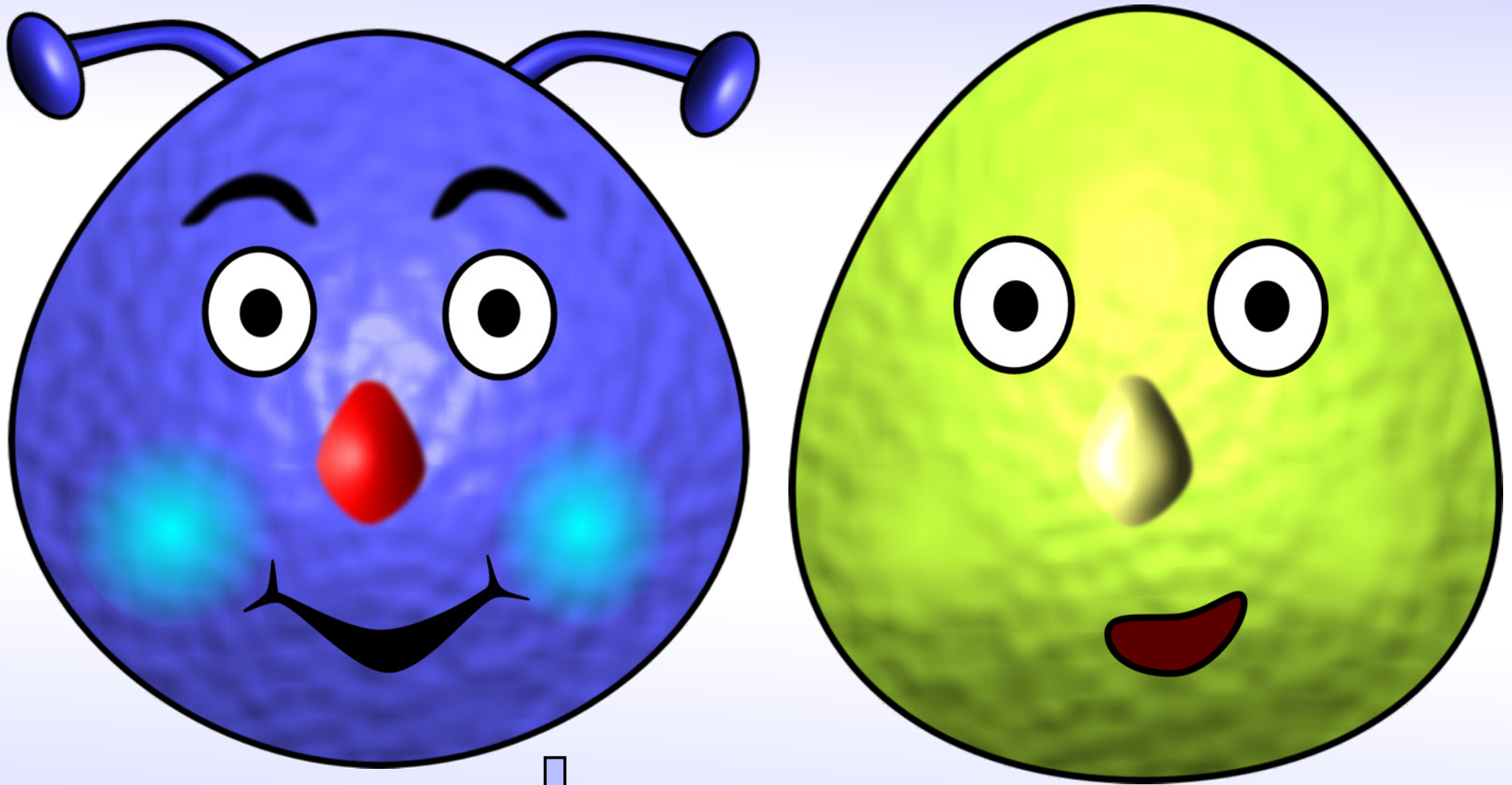

longer

Can you make a playdough plant  
that is shorter?

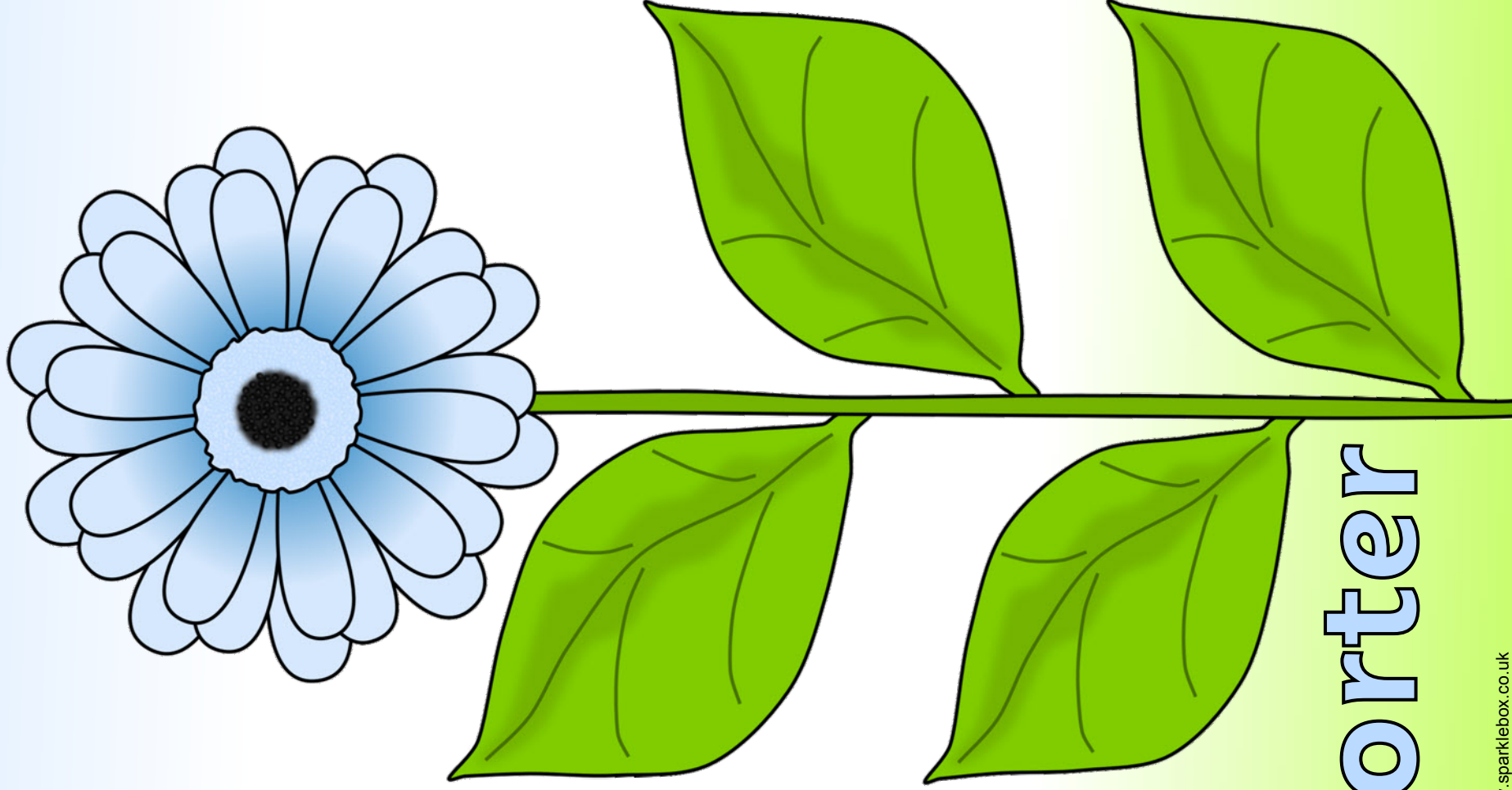

shorter

**Can you make a playdough spanner that is longer?**

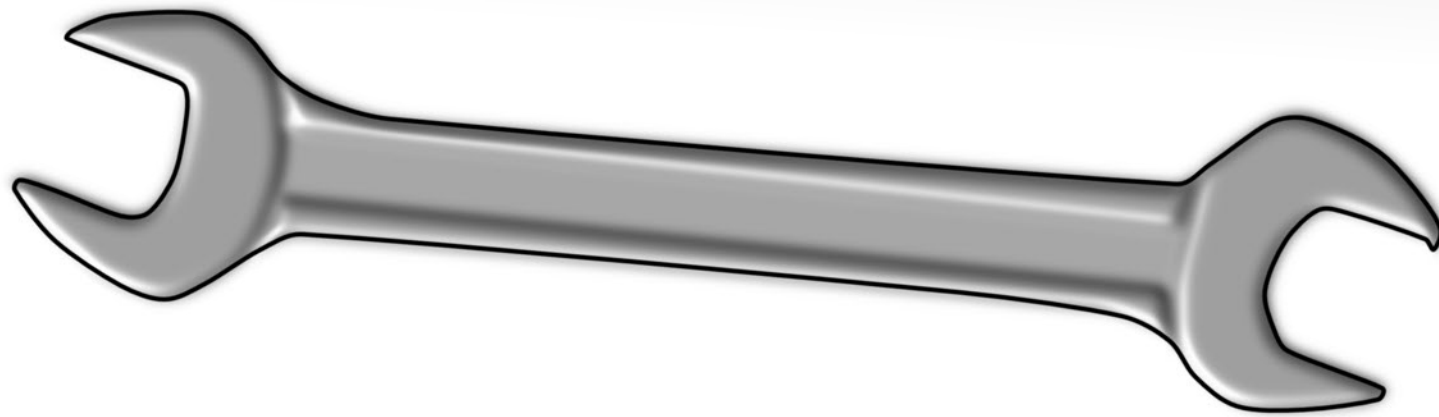

**longer**

Can you make a playdough pencil that is longer?

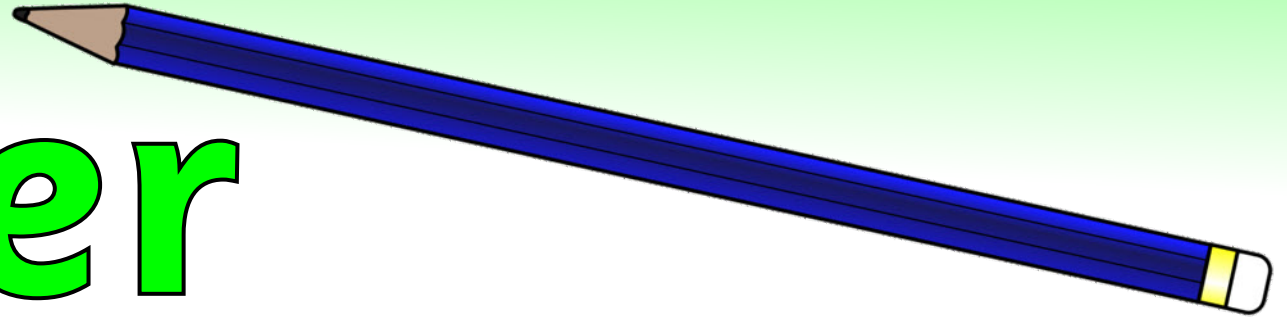

longer

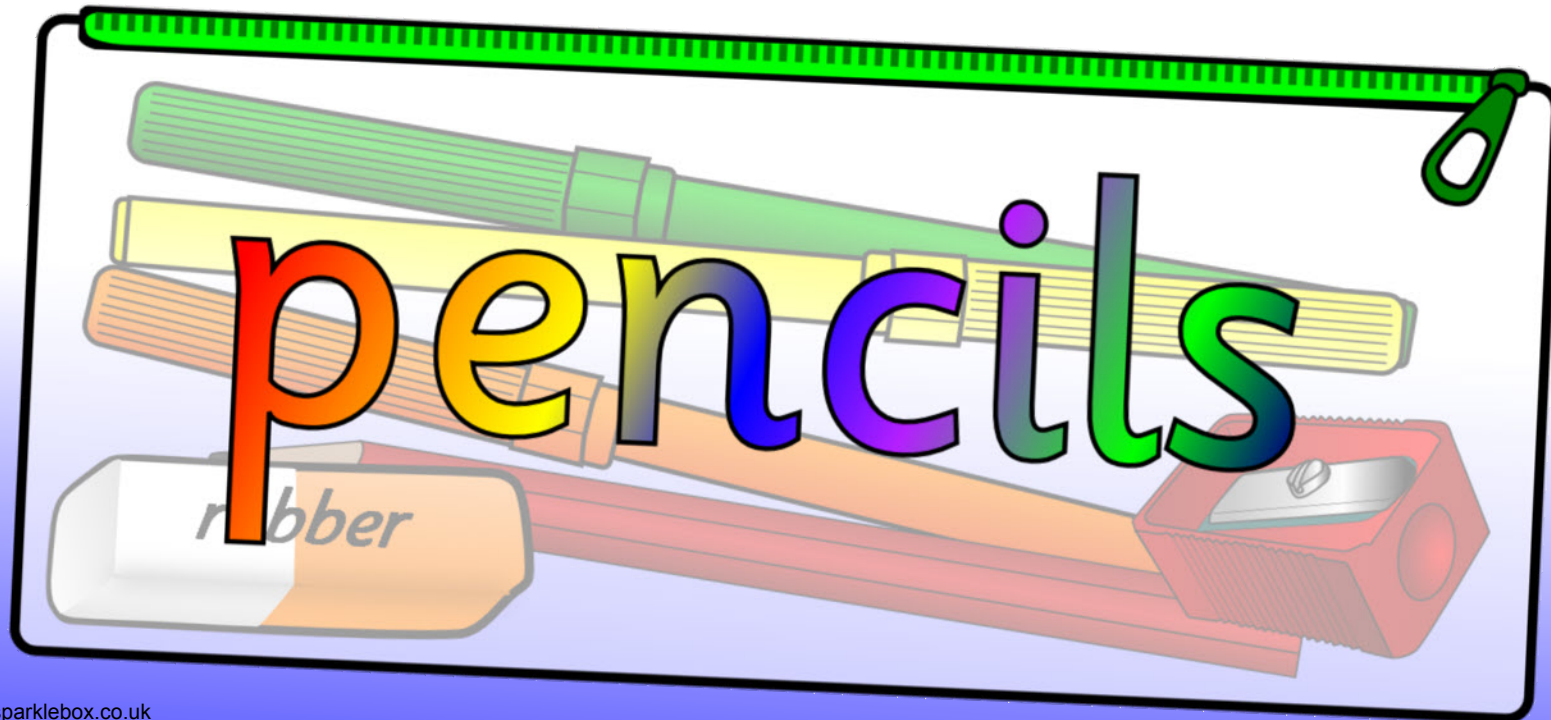

Can you give the ladybird antennae that are shorter?

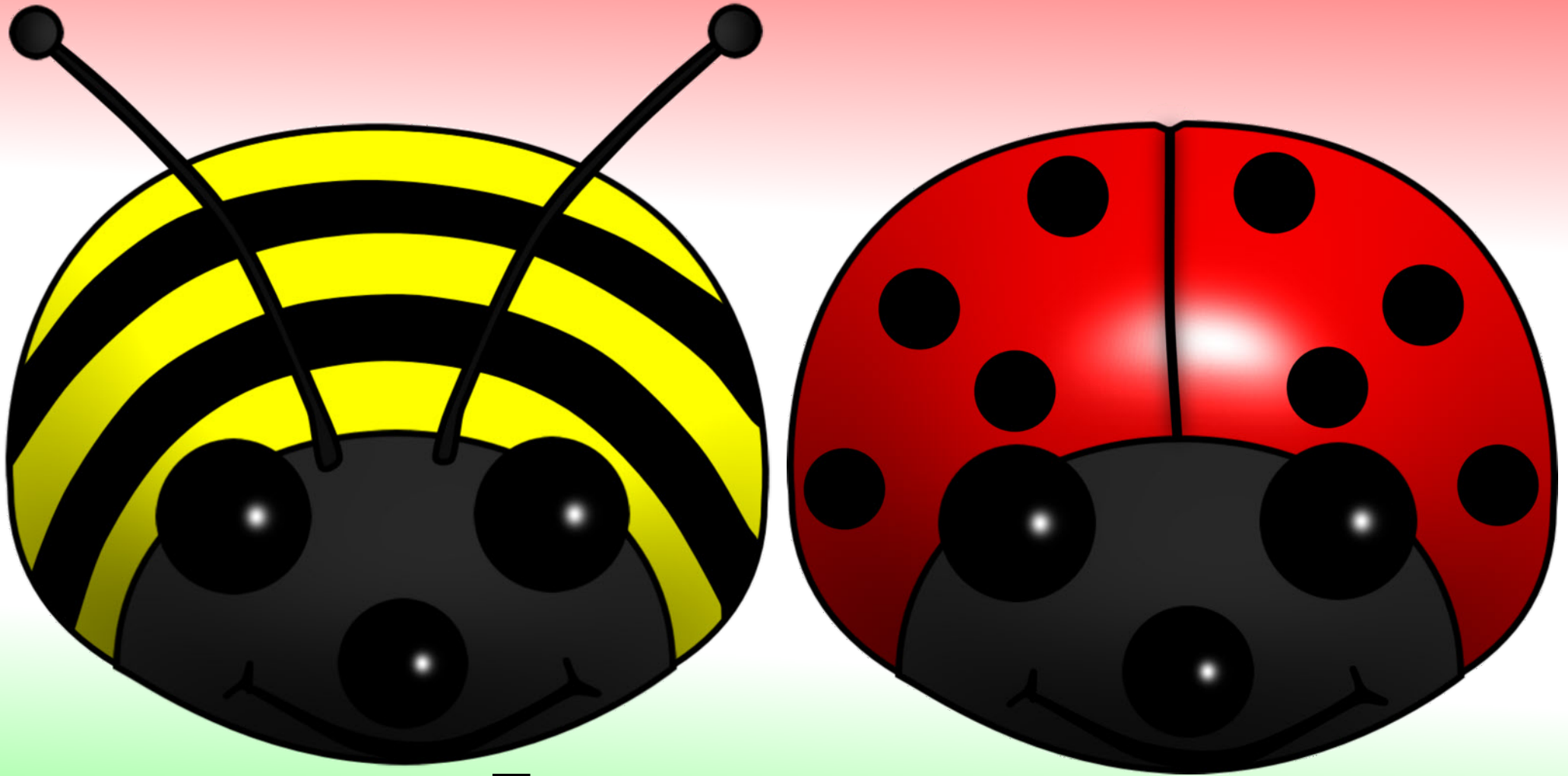

**shorter**

Can you give the elephant a trunk that is longer?

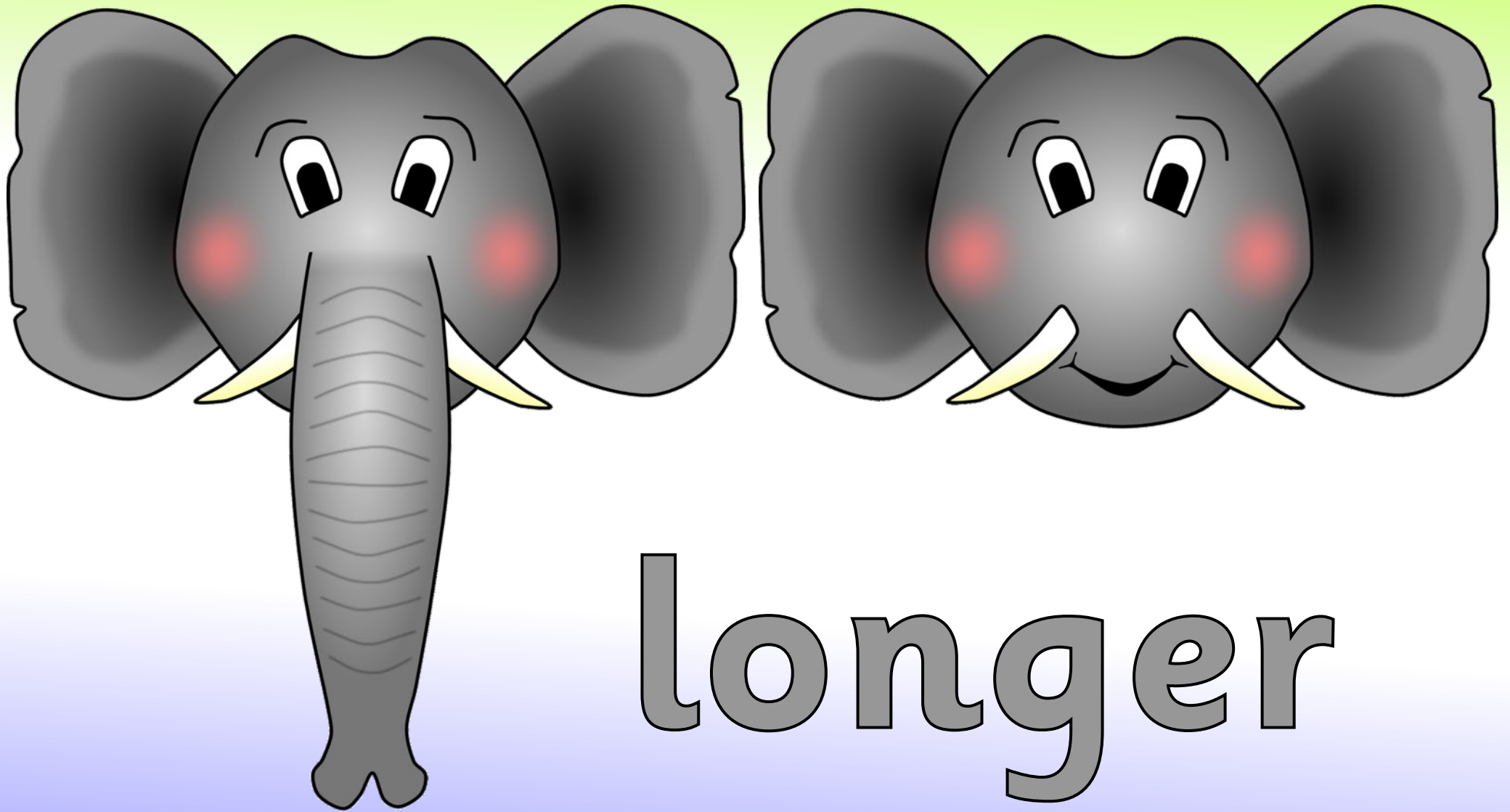

longer

Can you give the goat some horns that are longer?

longer

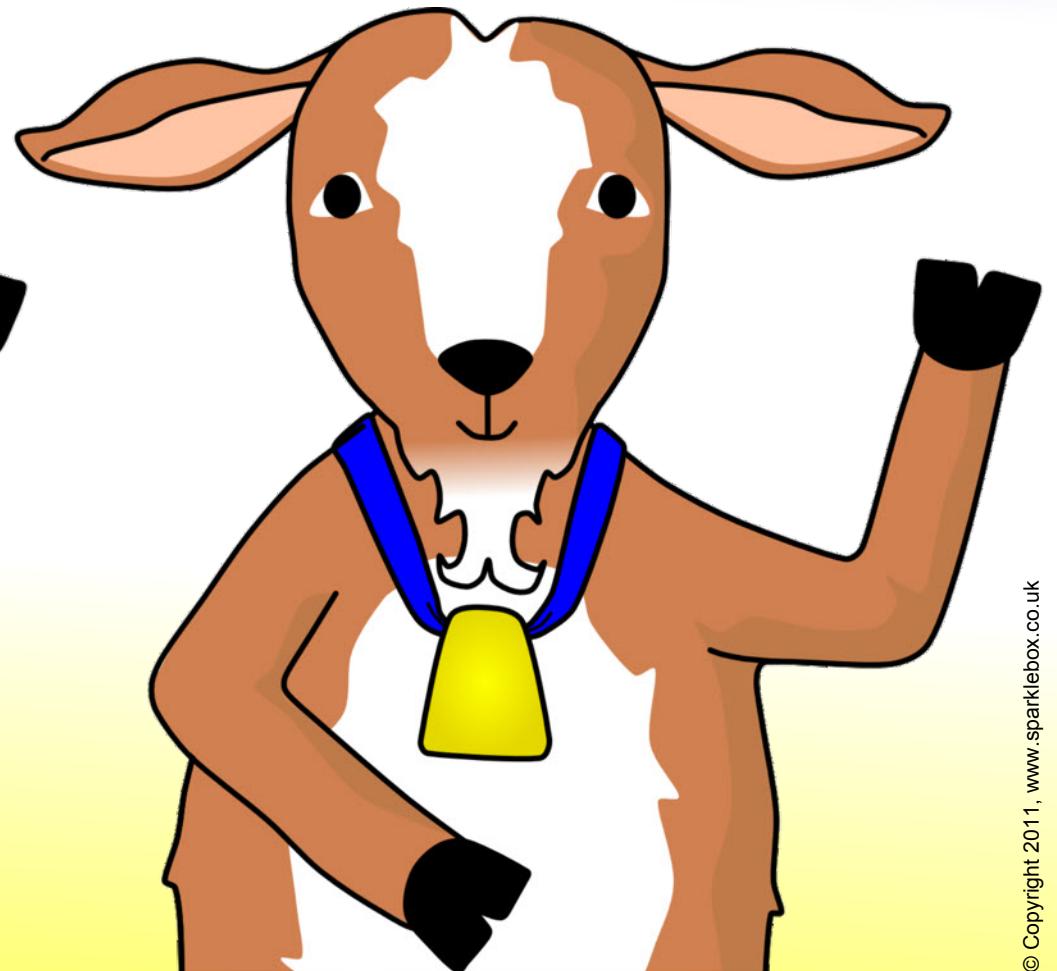



**Can you make a playdough plant  
that is taller?**

**taller**

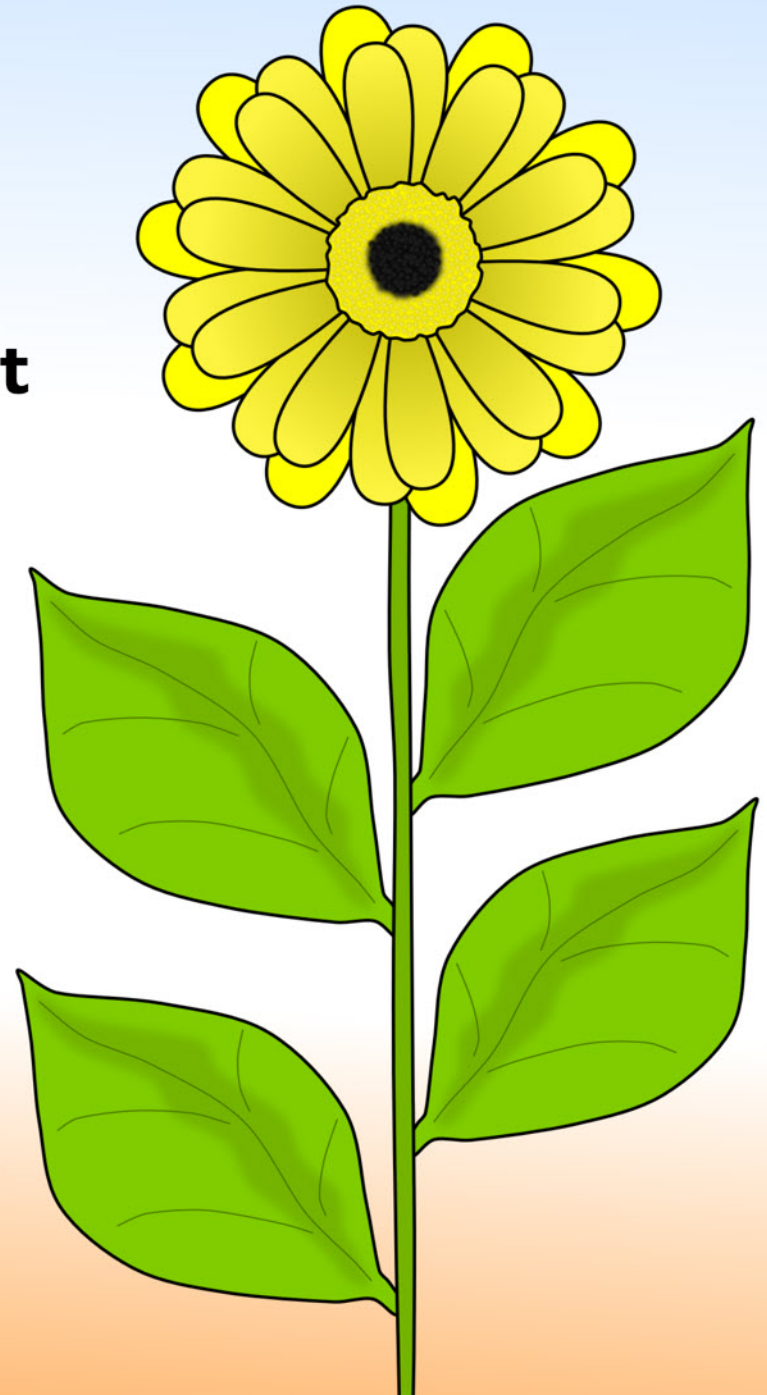

Can you make a playdough 'T' that is taller?

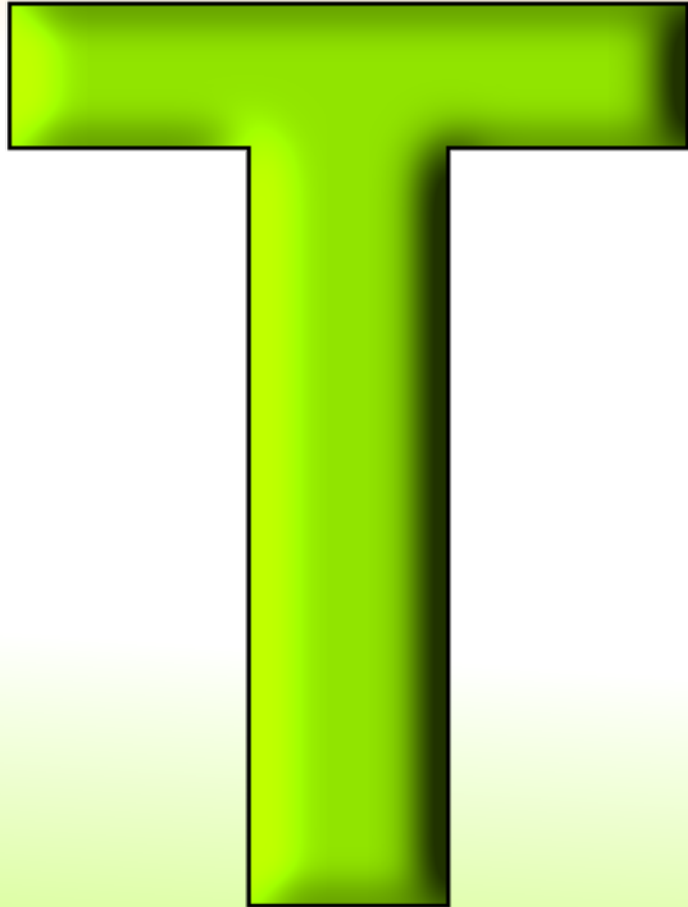

taller

**Can you make a playdough 'L' that is shorter?**

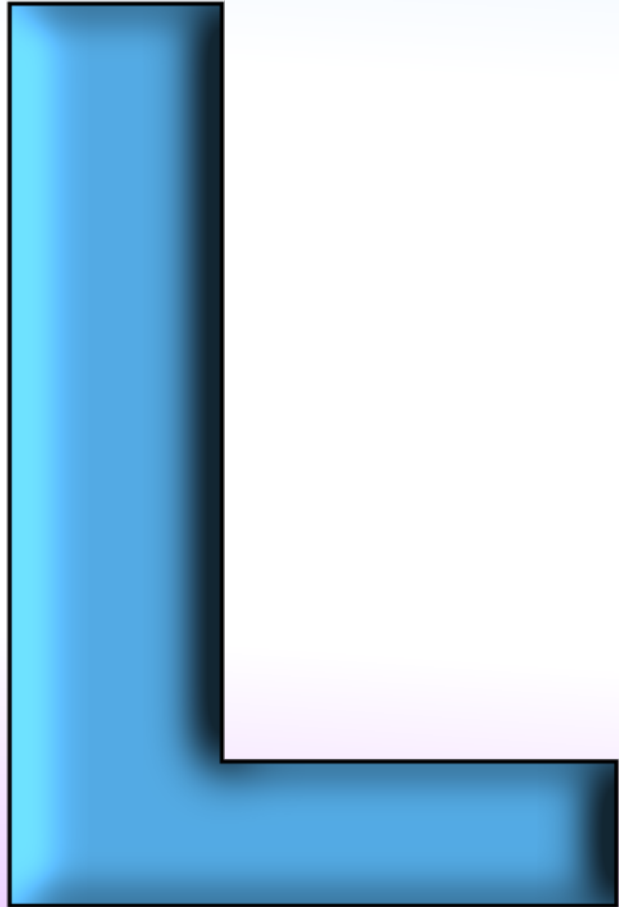

shorter

Can you make a playdough zigzag that is longer?

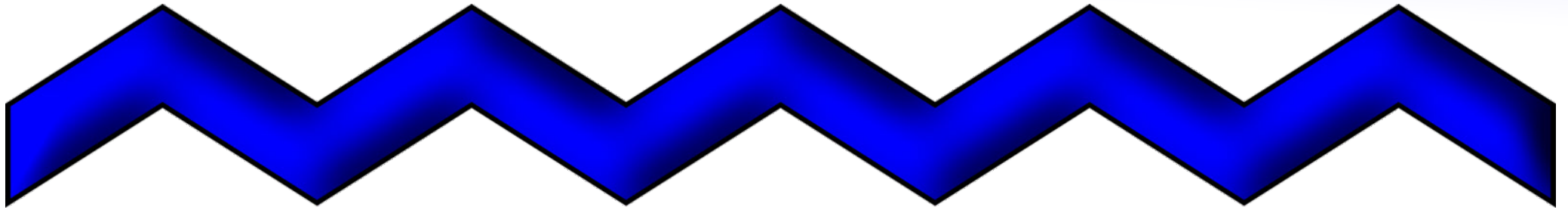

longer

**Can you make a playdough arrow that is shorter?**



**shorter**

Can you make a playdough triangle that is wider?

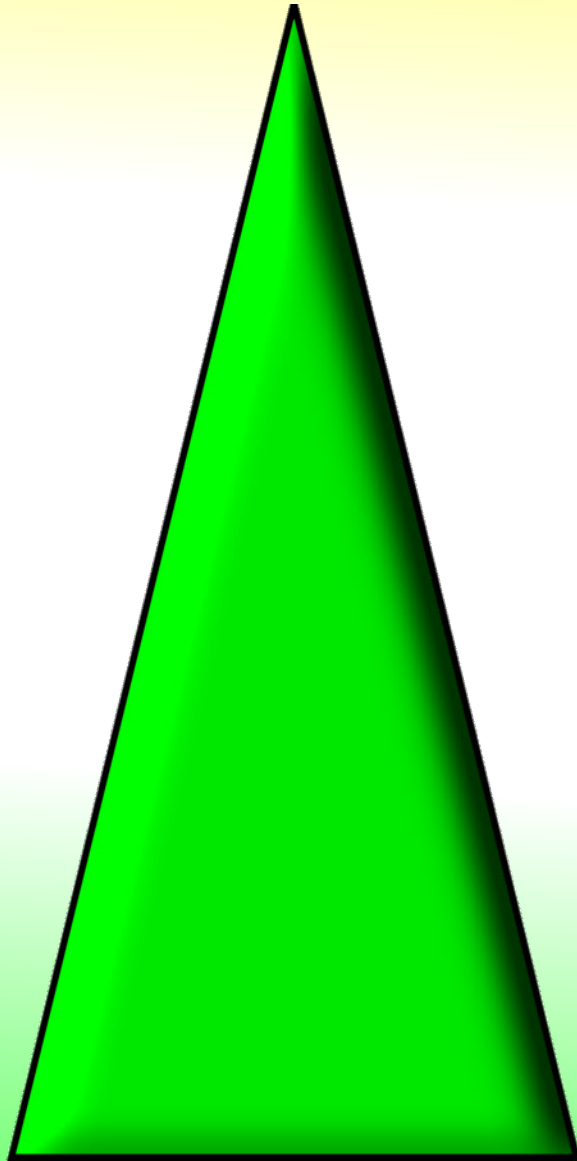

wider