

Aparan

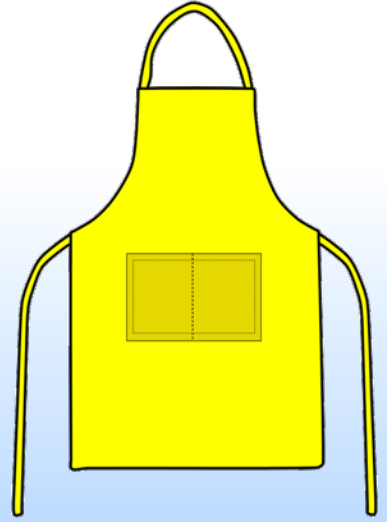

Pinn



Peansailean dathte

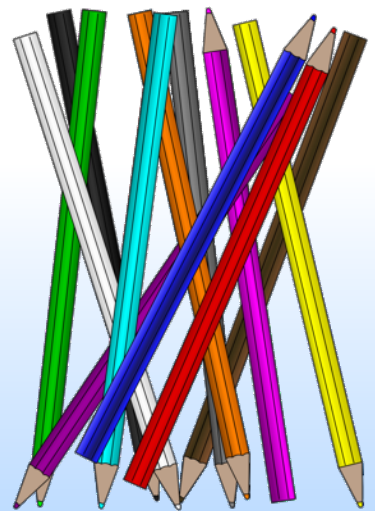

Creidhean

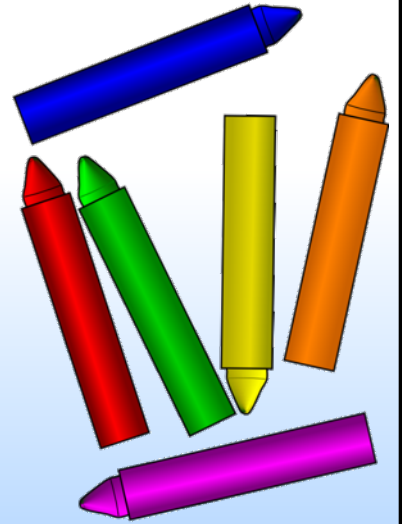

Pinn

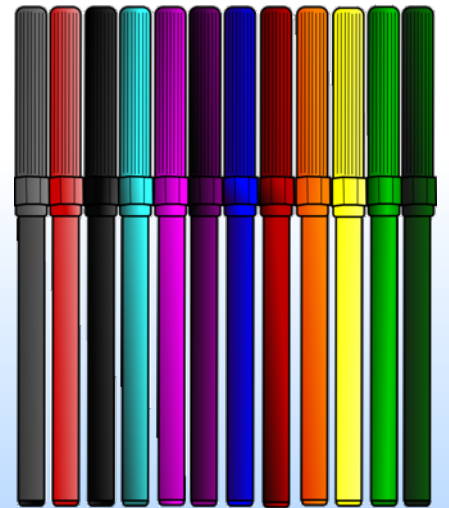

Bruisean-
peantaidh

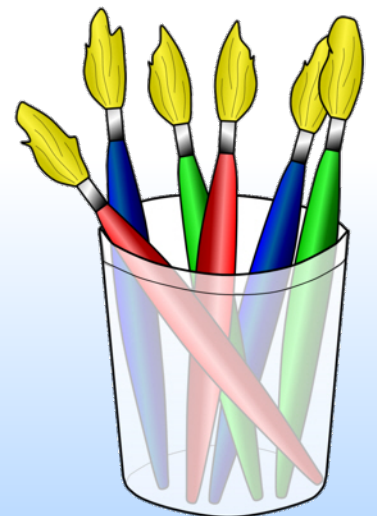

Bruisean-
glaoidh

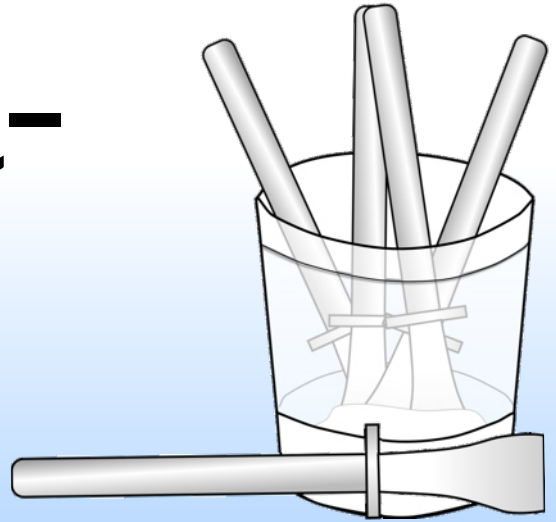

Glaodh



Peant

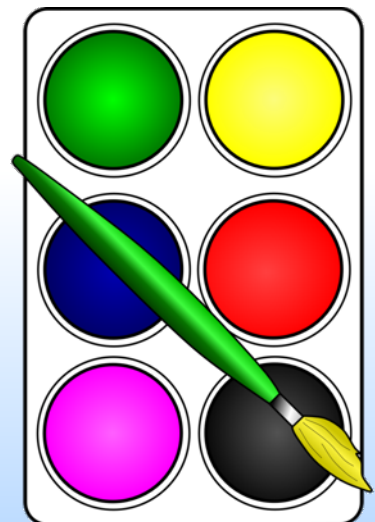

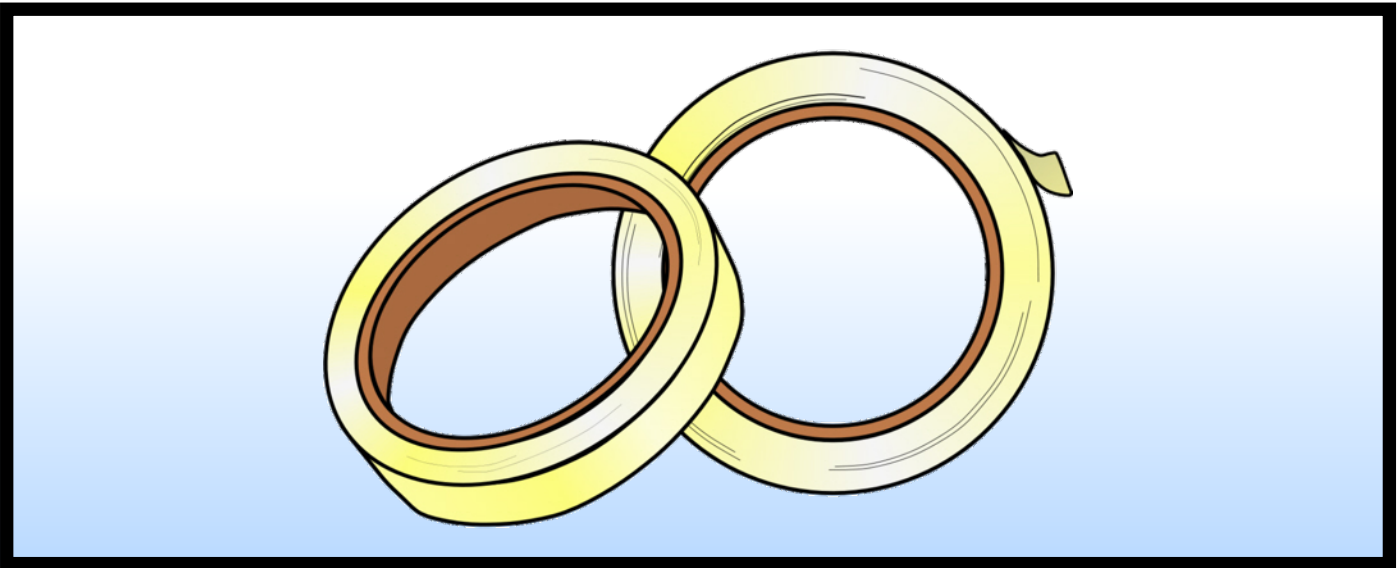
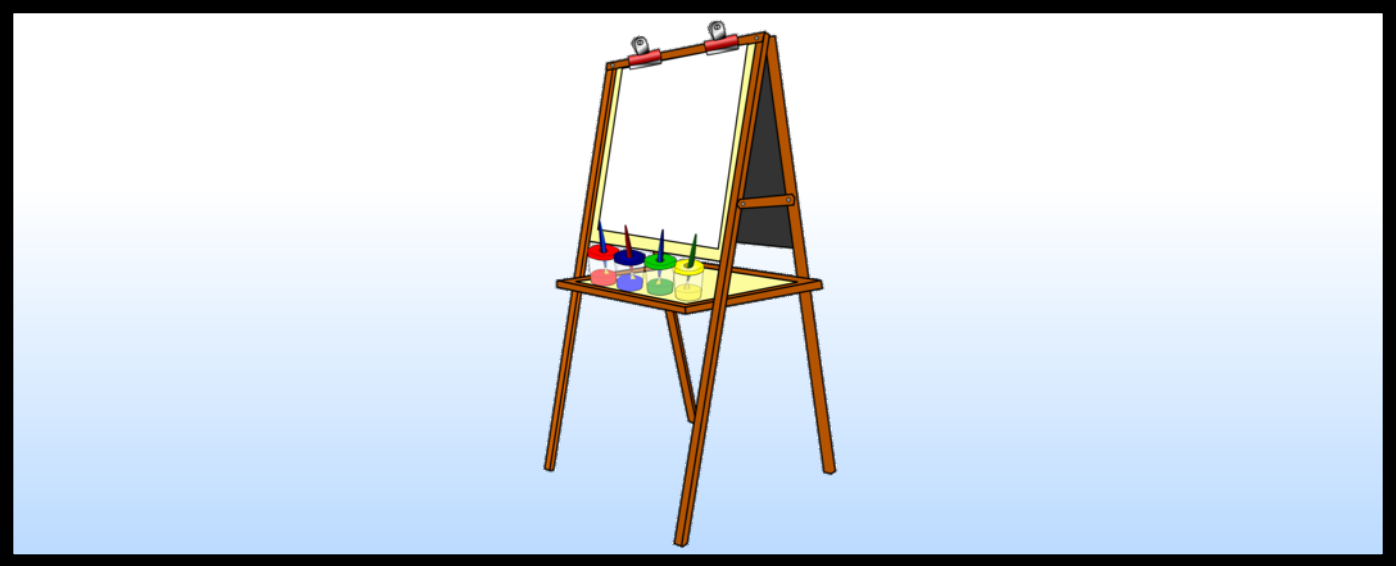

Peant

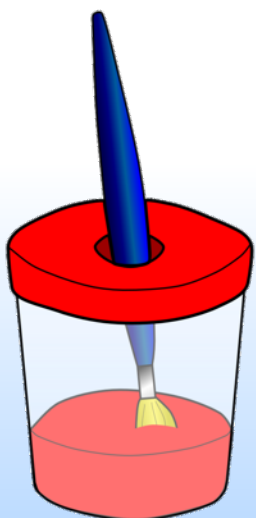
A blue pen is shown vertically inside a red cylindrical container. The container is partially filled with red liquid, and the pen's tip is submerged in it. The background is light blue.

Siosar

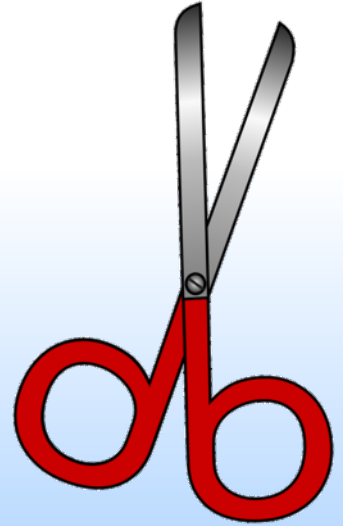

Sgudal

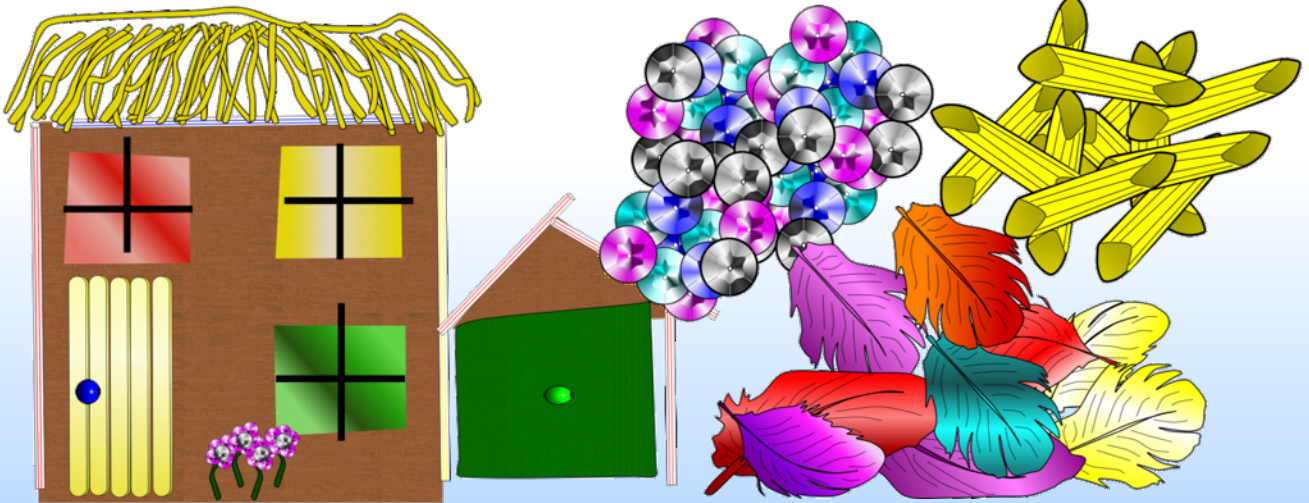
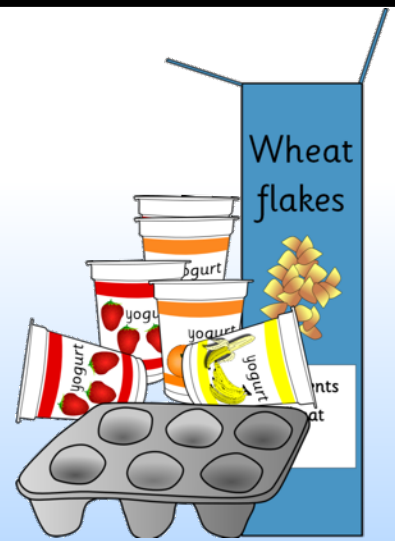

Ribinn

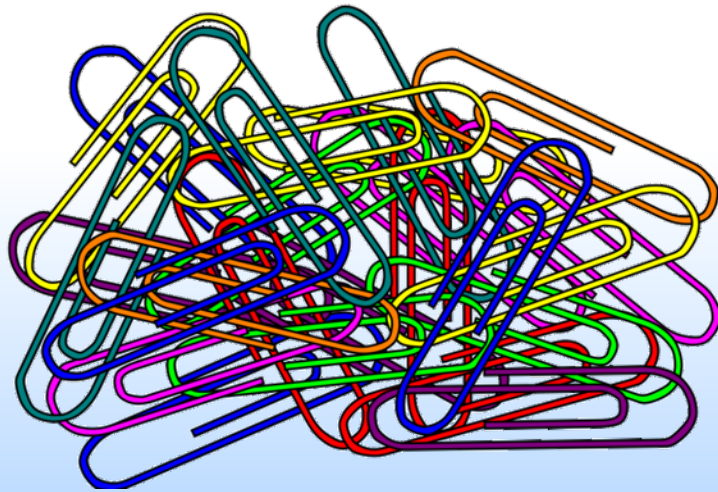
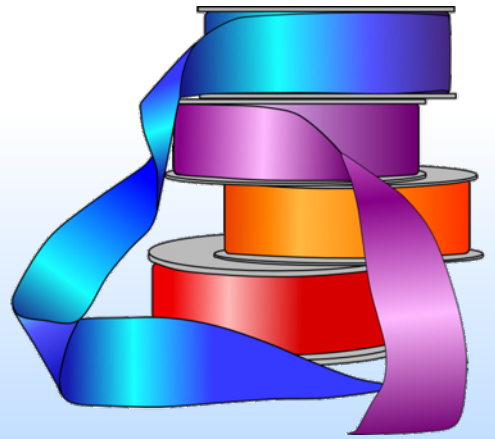

Reansailean

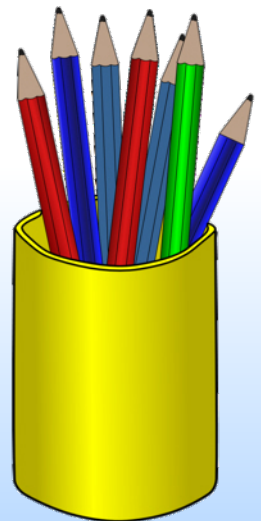

Pàipear-sgudail

Pàipear- sgrìobhaidh

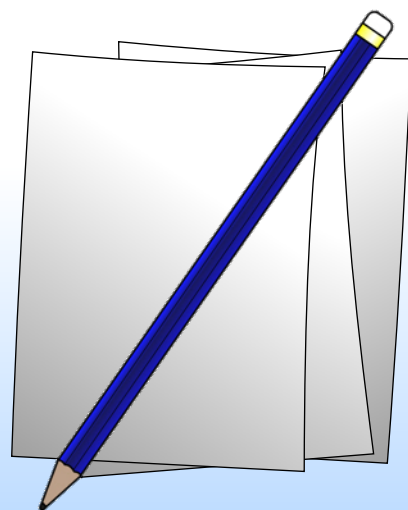

Sgrìobhadh



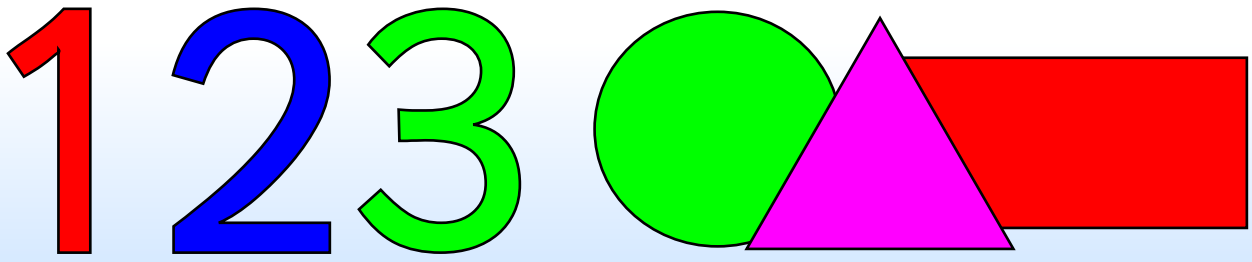

Coimputair



Tòimhseachan

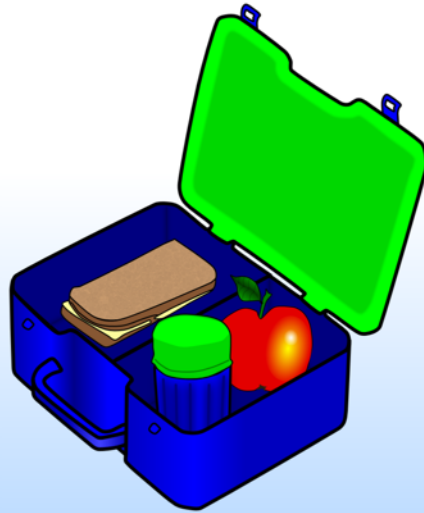
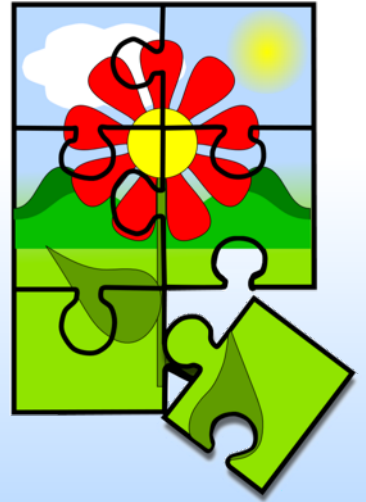

Dísne



My 0 to 10 number line

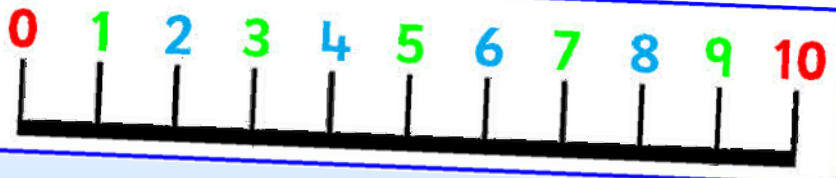

Cumaidhean

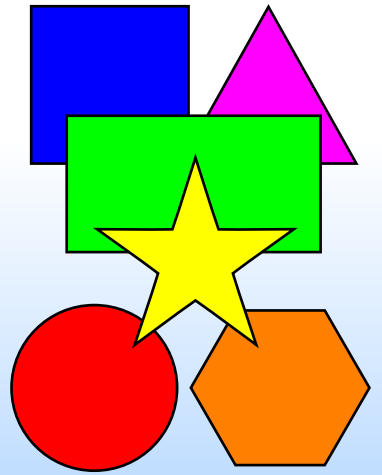

Cumaidhean

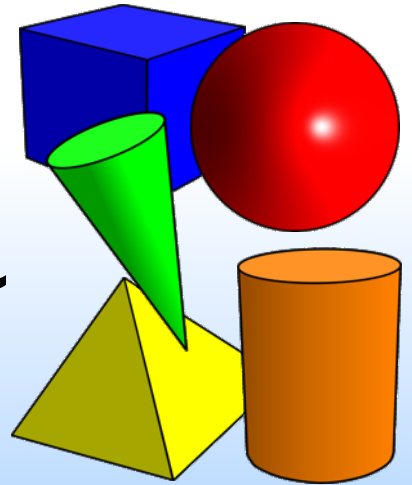

Gleoc



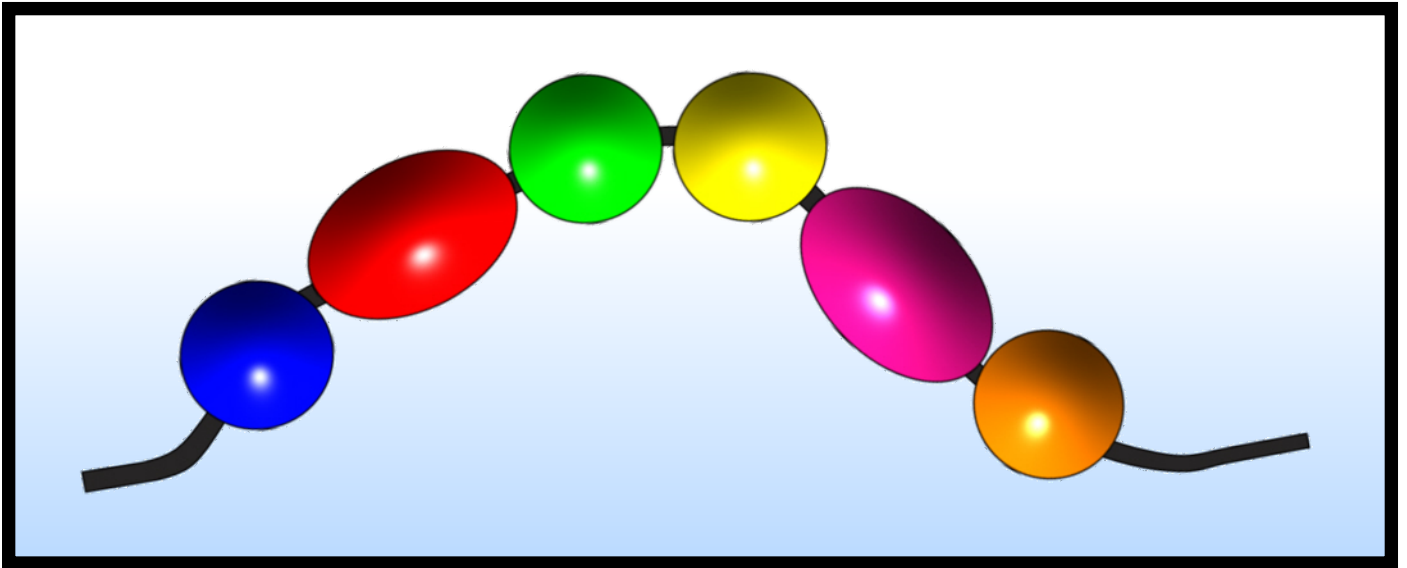

100 ceàrnag

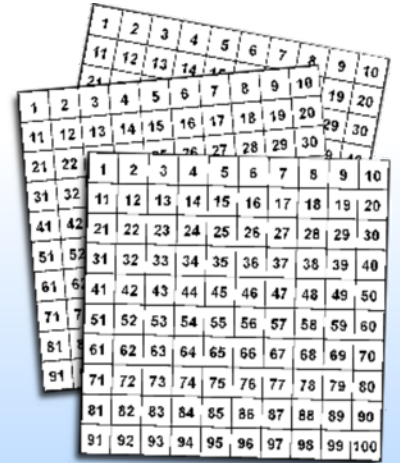

Teadaidhean



Airgead



Geamaichean

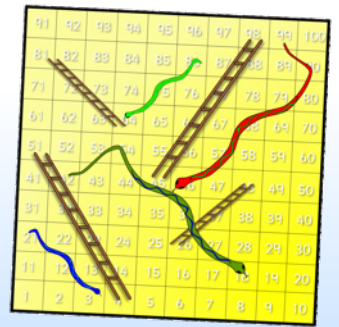

Rùilearan





Ciùban

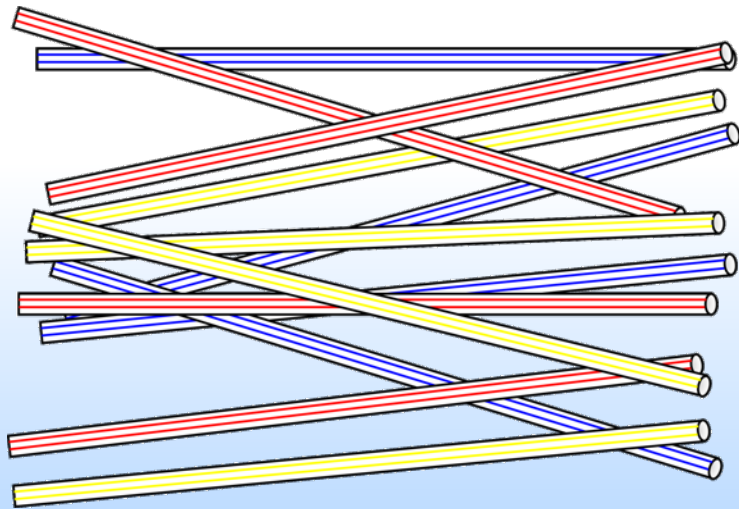
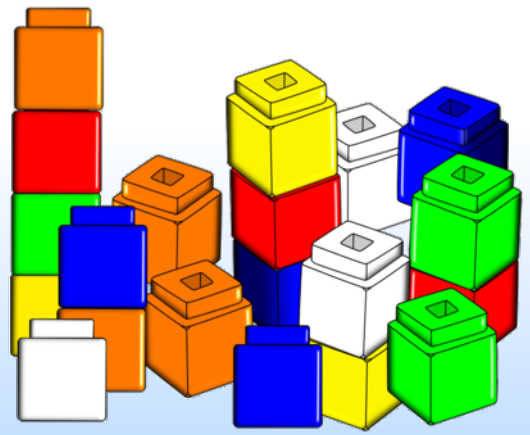

Steansailean

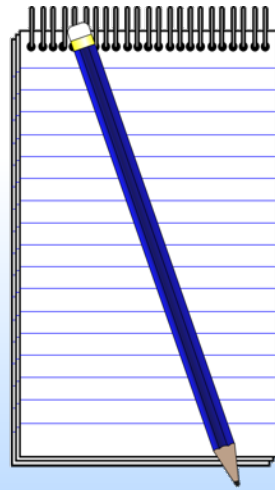
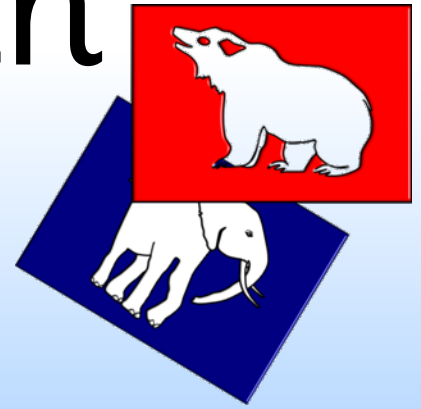

Cairtean

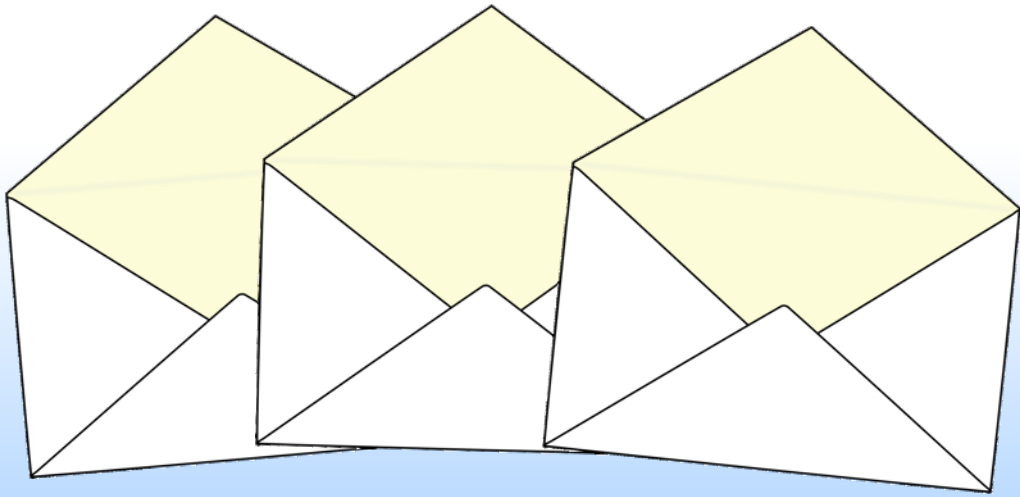

Stampaichean

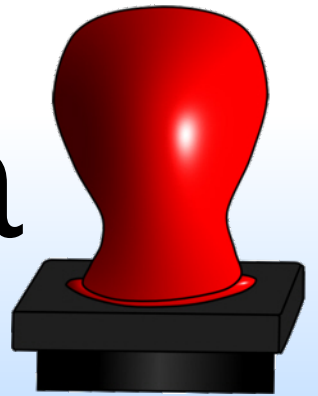

Sotaichean

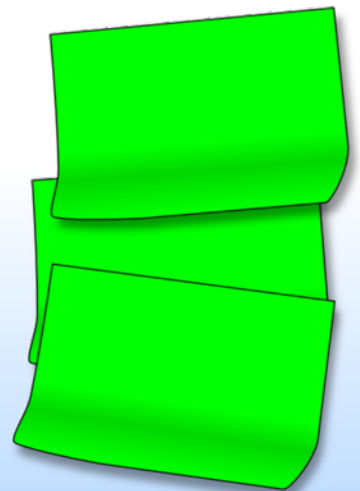

Cairt-phuist



Biadh



Biadh

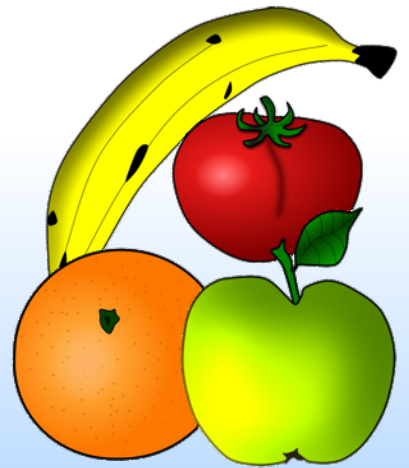

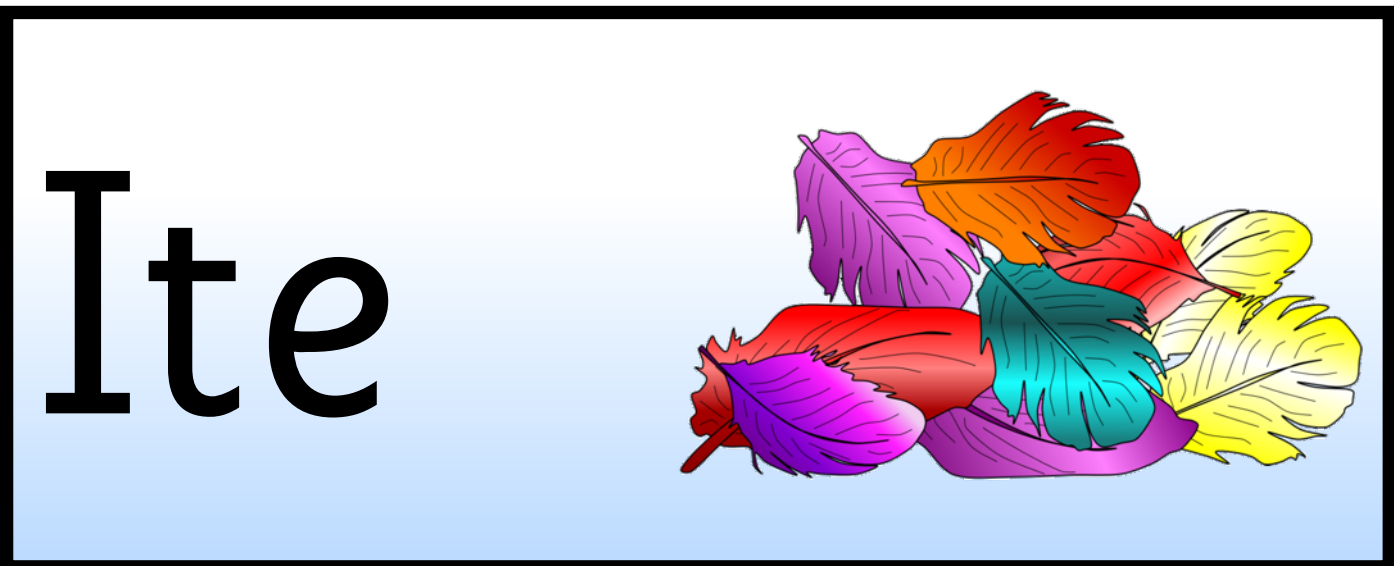
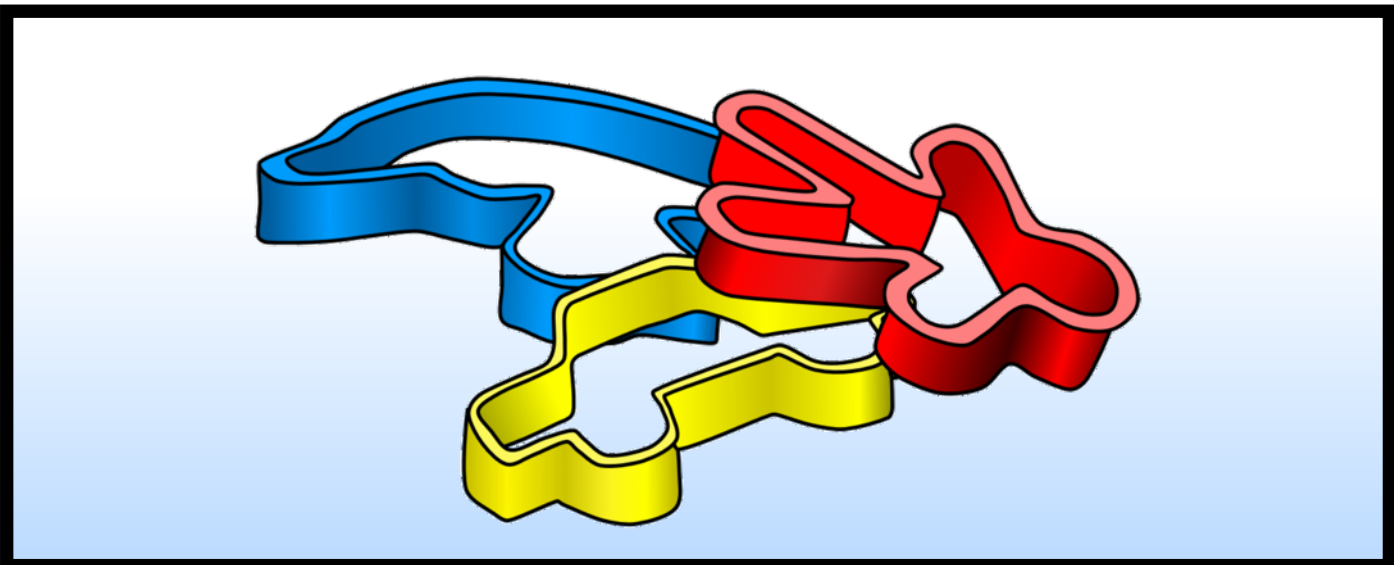
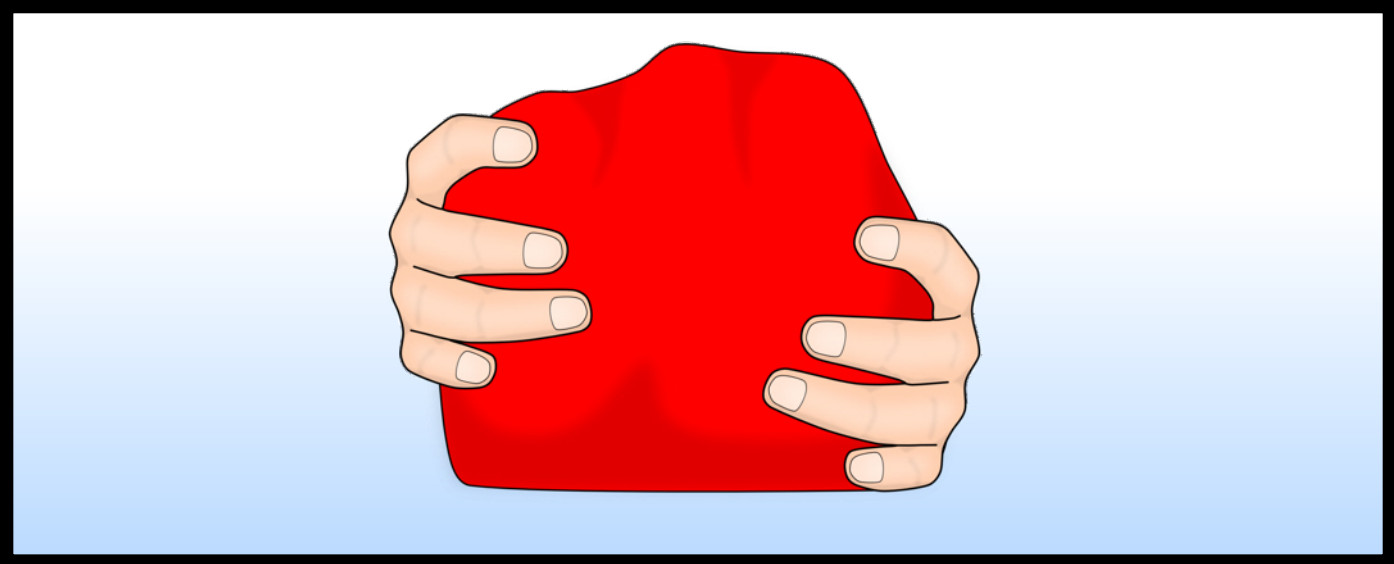

Ite

Pasta

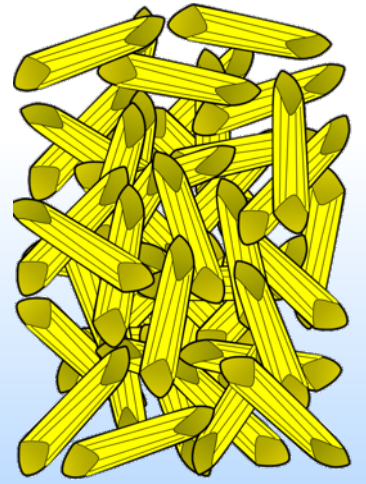

Blocaichean

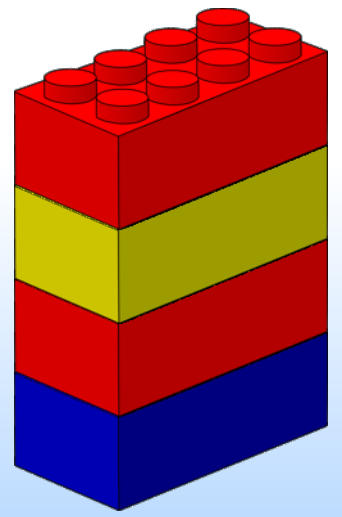

Còmhdhail

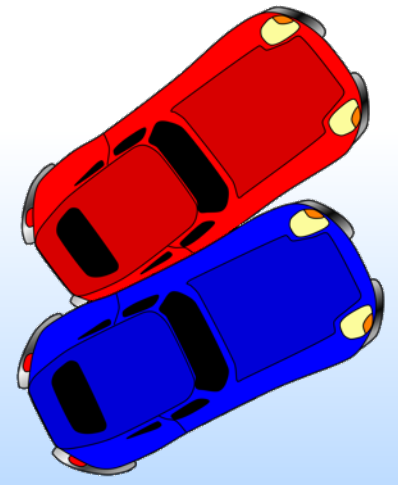

Tuathanas

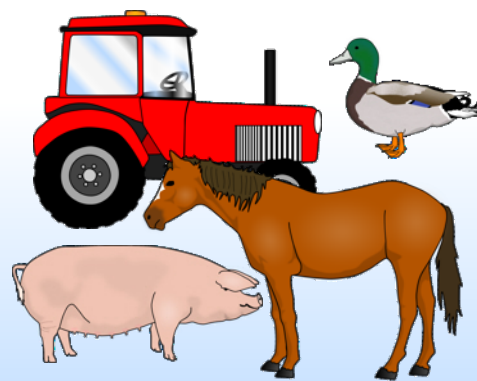

Trèan



Beathaichean

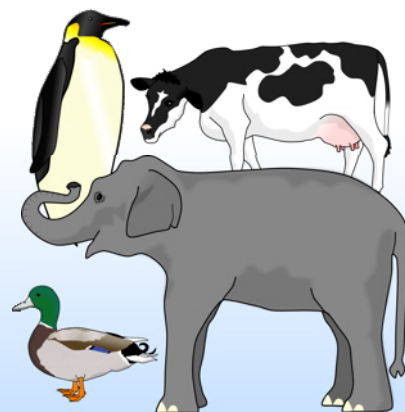

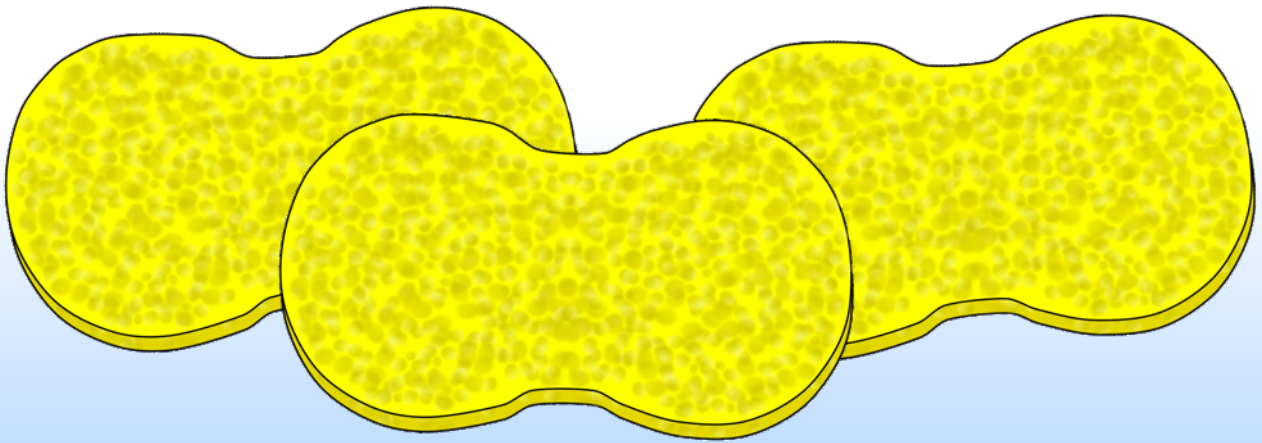
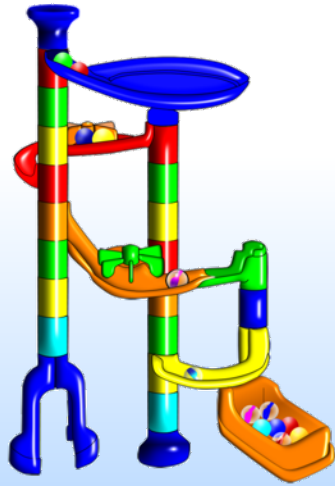

Blocaichean

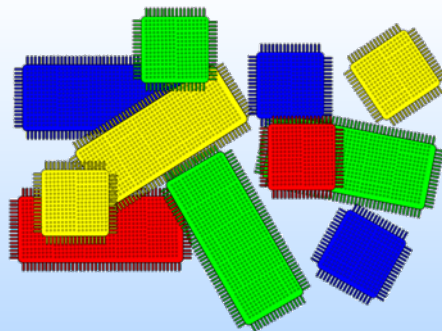

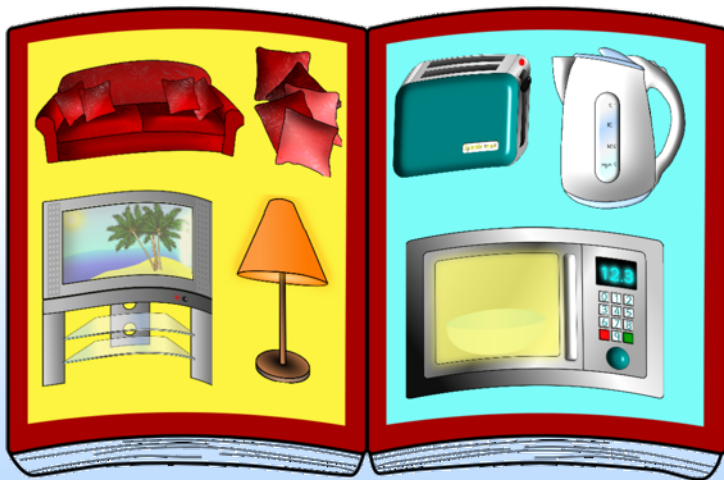
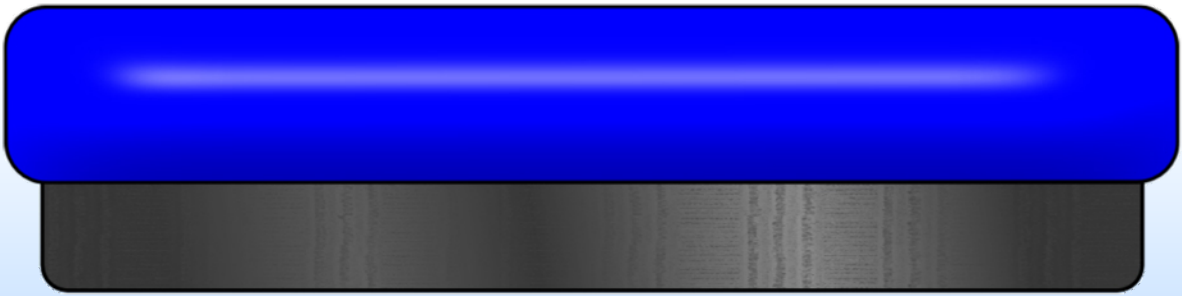

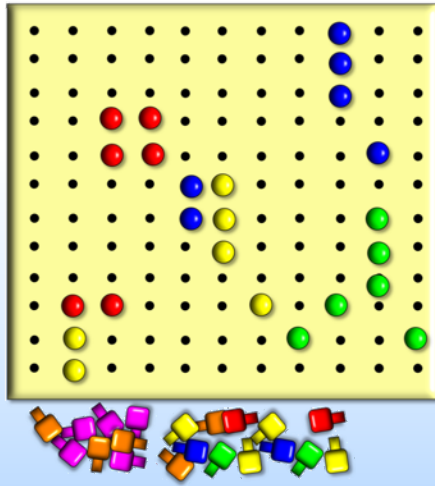

Pinn

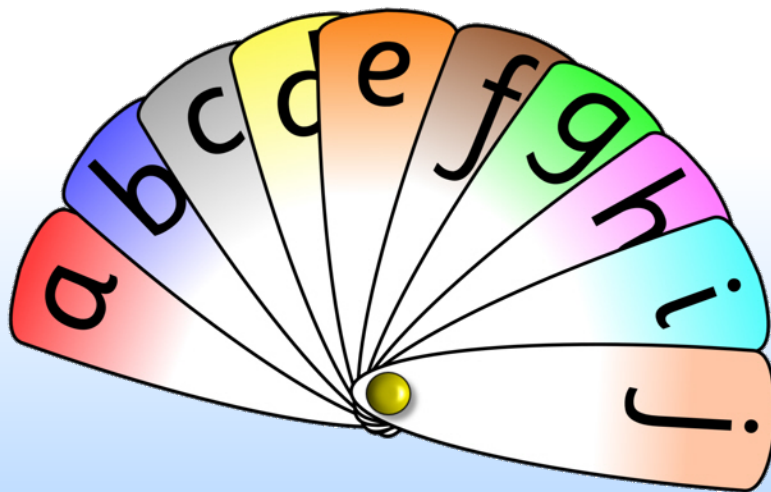
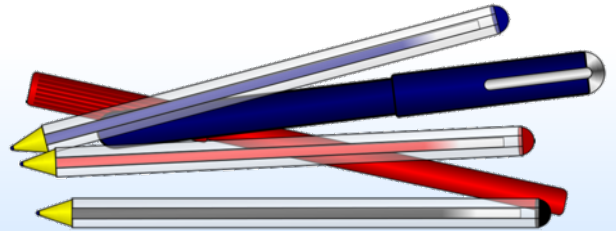

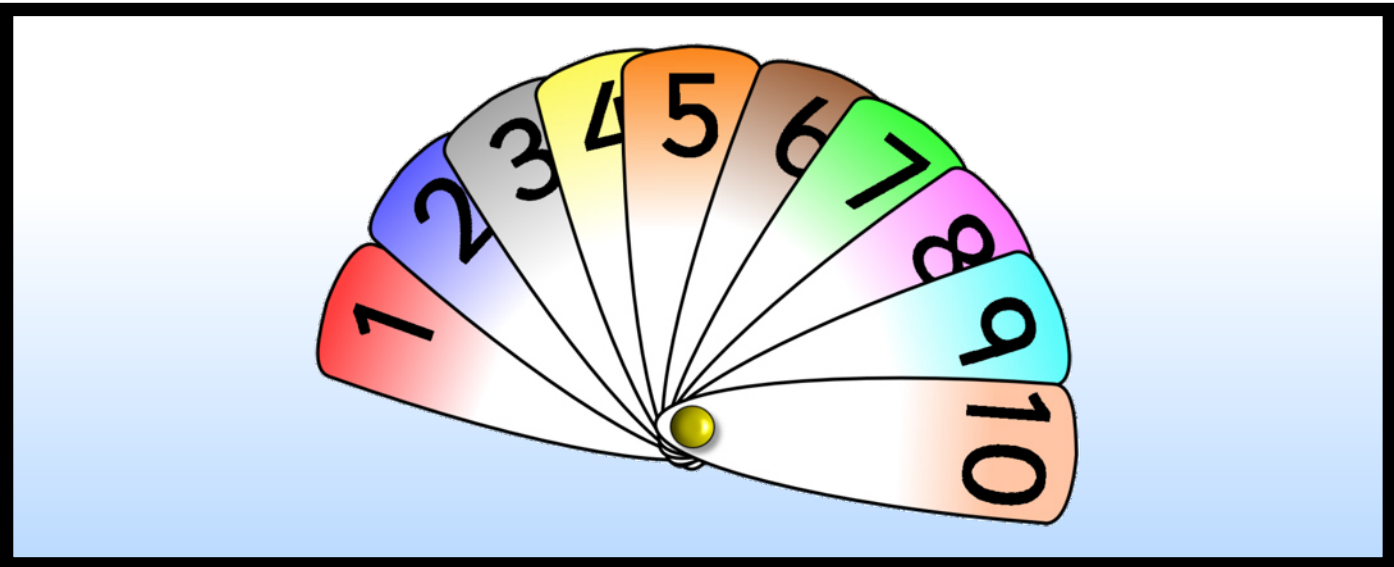
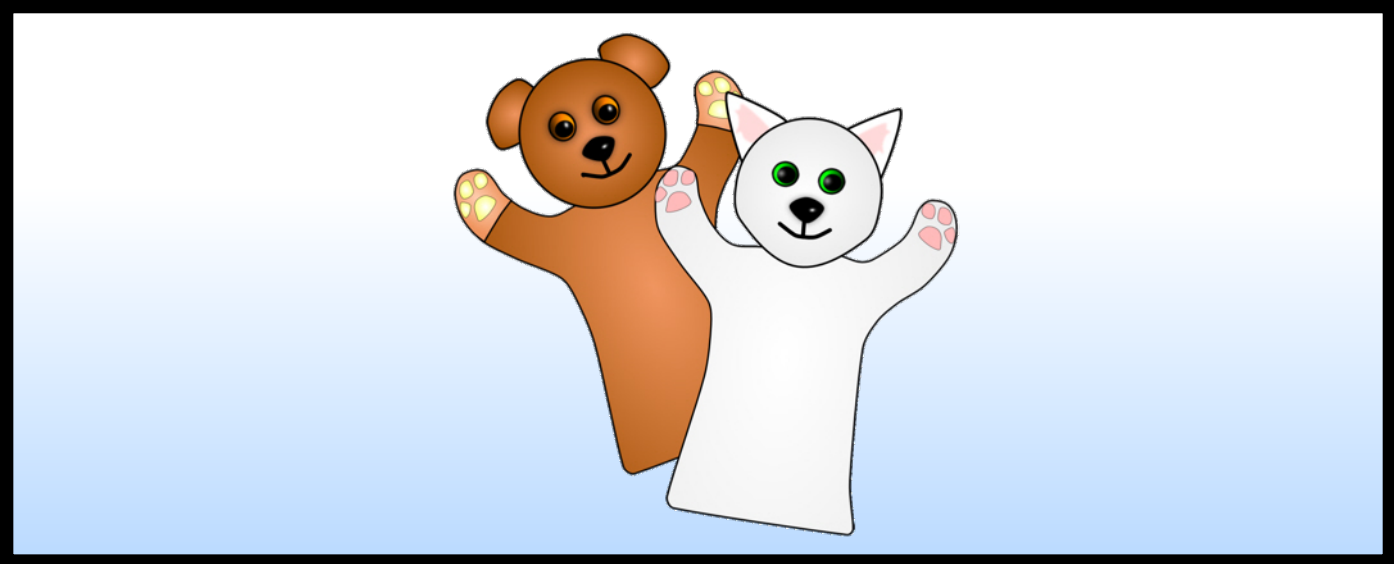

Matamataig

1 2 3

