

My book about

cr

© Copyright 2011, SparkleBox Teacher Resources
Downloaded FREE from www.sparklebox.co.uk

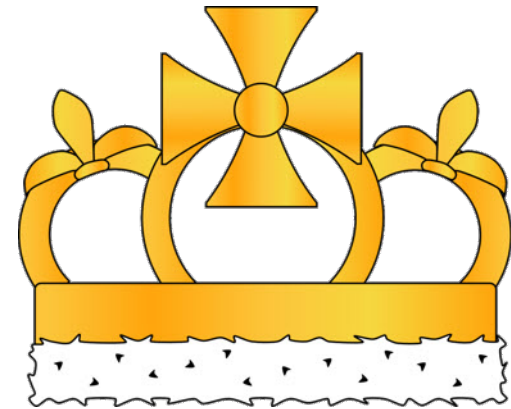

crown

This book belongs to

Can you see **cr**?

Find all the **cr** blends and circle them.

cr cl cr
fr st ch
dr sl spr
cr cr str
r pl cr st

Colour the crown.

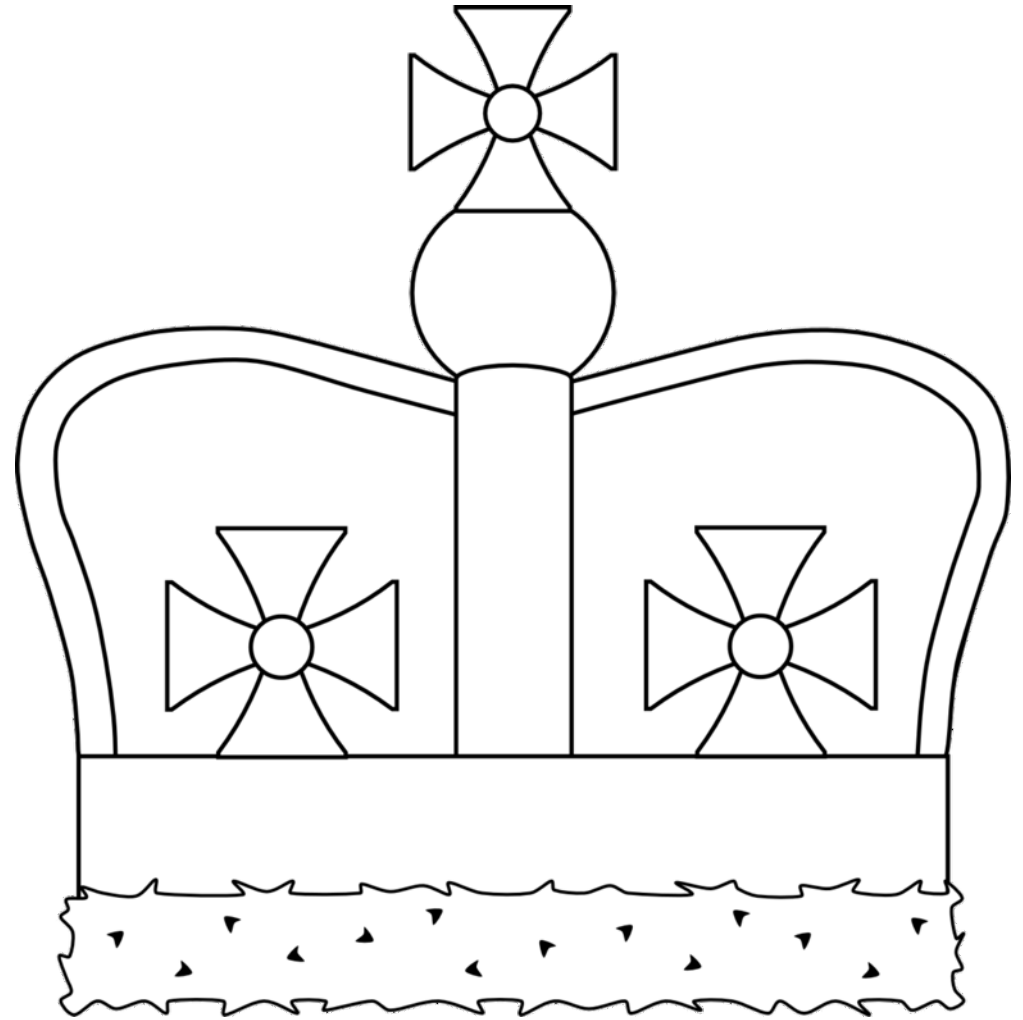

Shout out **cr**!

Slowly trace your hand along the line. When you reach a **cr** blend, shout it out!

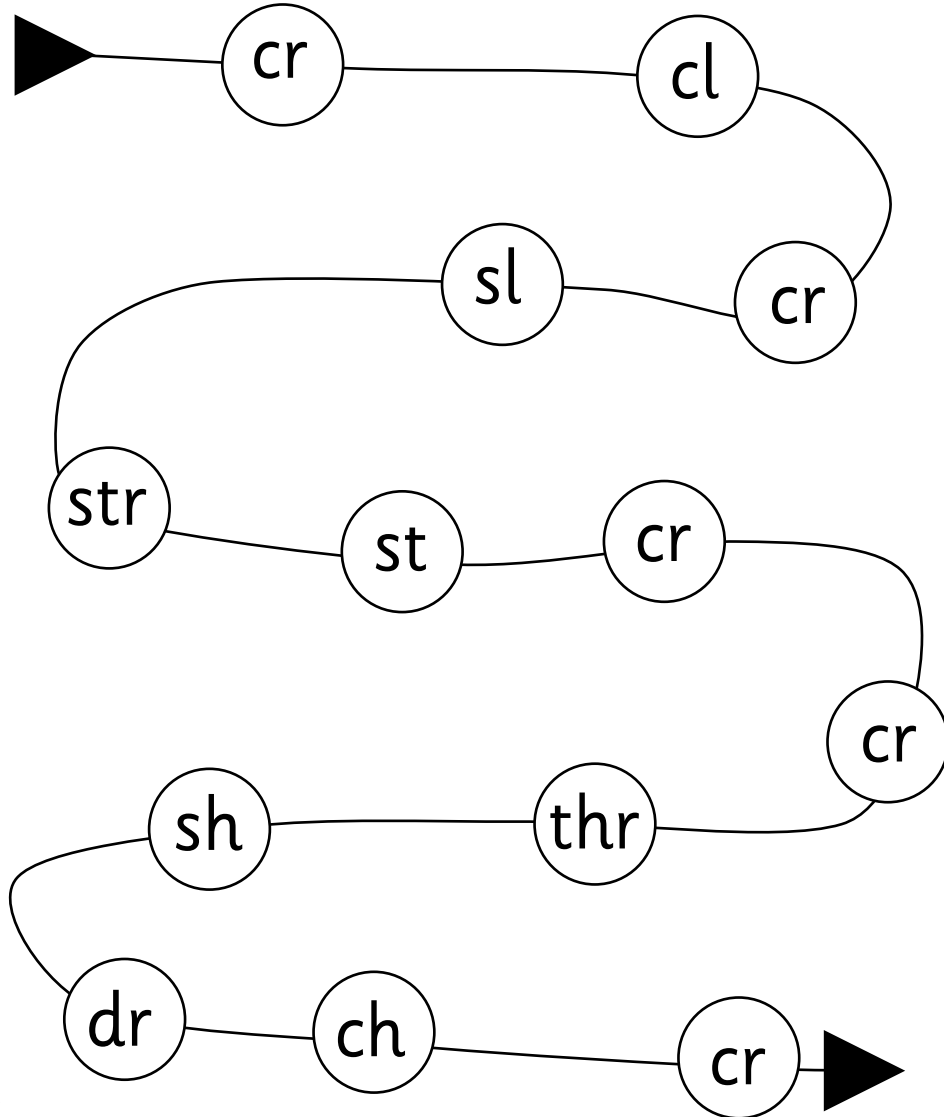

Choose 6 rainbow colours and trace within the giant **cr** below.

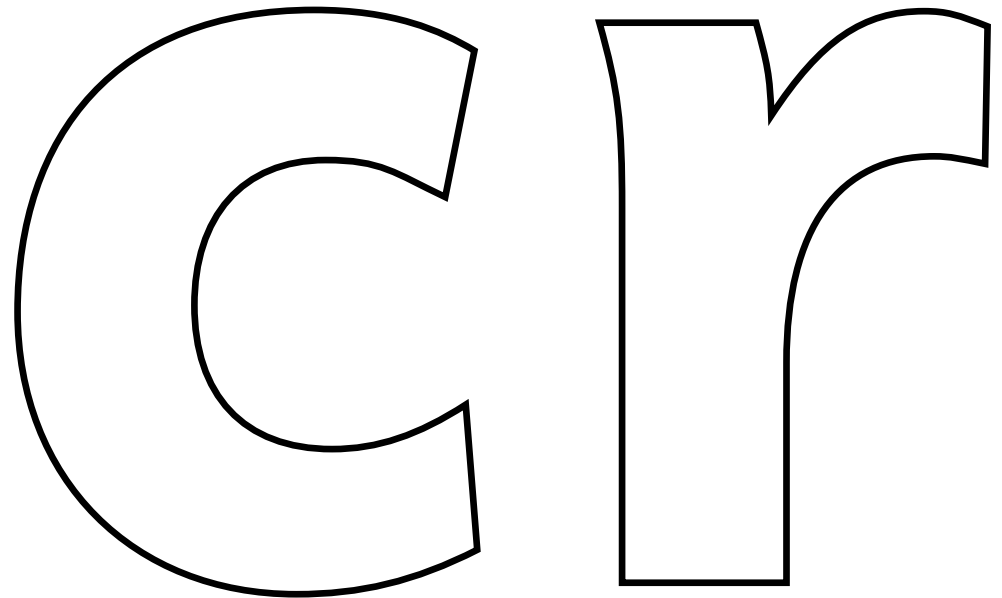

Things that begin with **cr**

Put a line through the one that does **not** begin with **cr**.

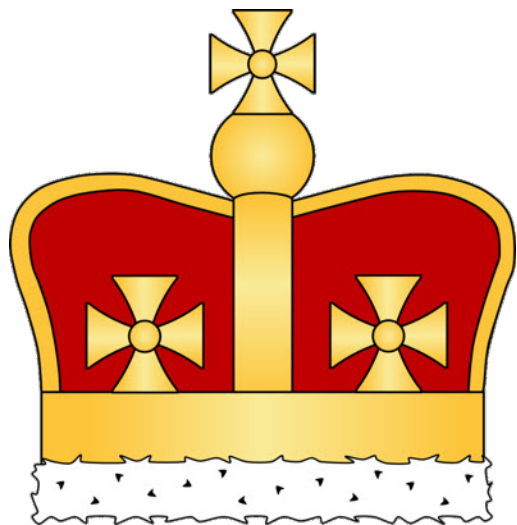

crown

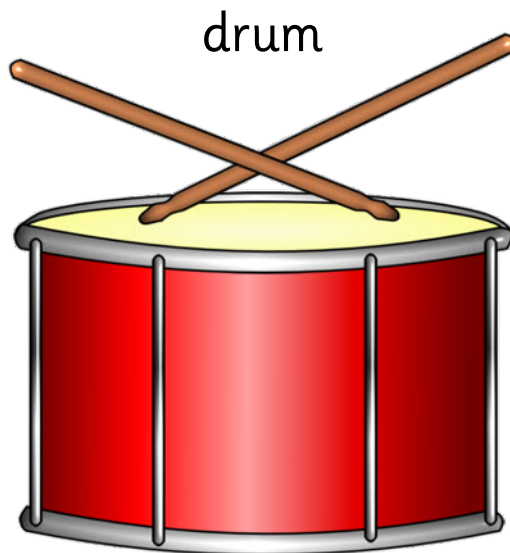

drum

crass

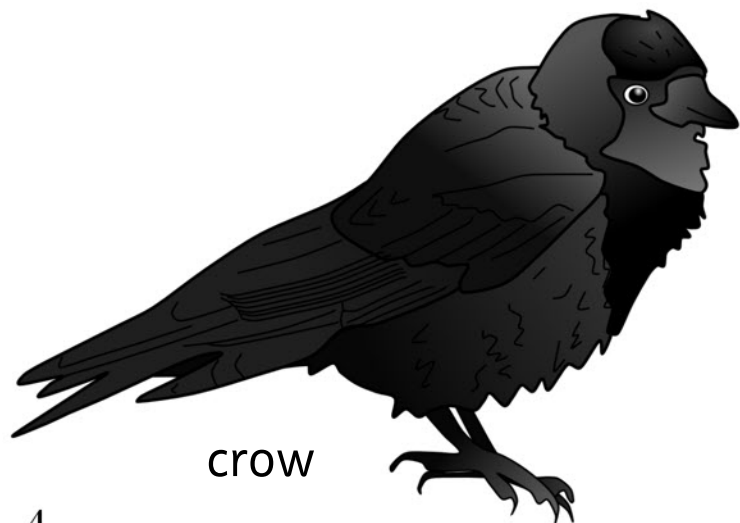
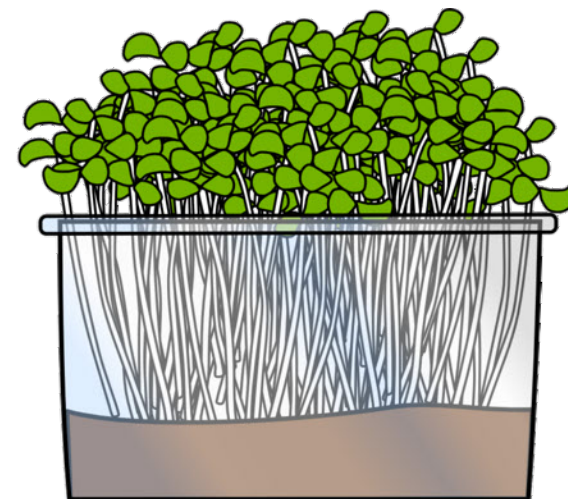

crow

crab

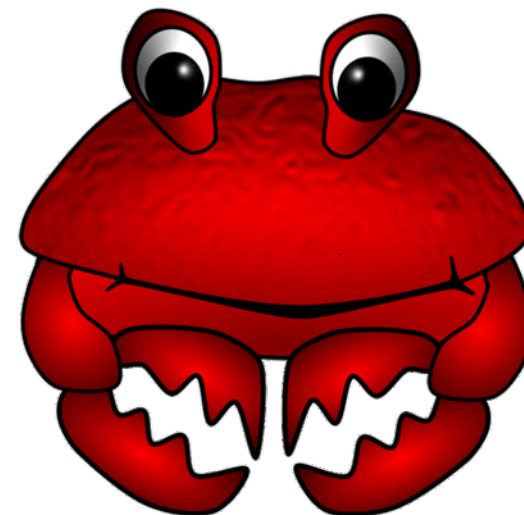

crocodile

