

Initial Sounds

n

nose

newt

newspaper

nails

nightingale

nan

Initial Sounds

n

net

nuts

nest

noodles

necklace

nurse

Initial Sounds

n

nurse

noodles

newt

net

nest

nails

Initial Sounds

n

newspaper

nose

nightingale

necklace

nan

nuts

Initial Sounds

n

nuts

necklace

nan

nest

noodles

nightingale

Initial Sounds

n

net

nurse

newspaper

newt

nose

nails

Initial sound bingo: **n**

Print several copies of the picture cards for children to match to their boards.

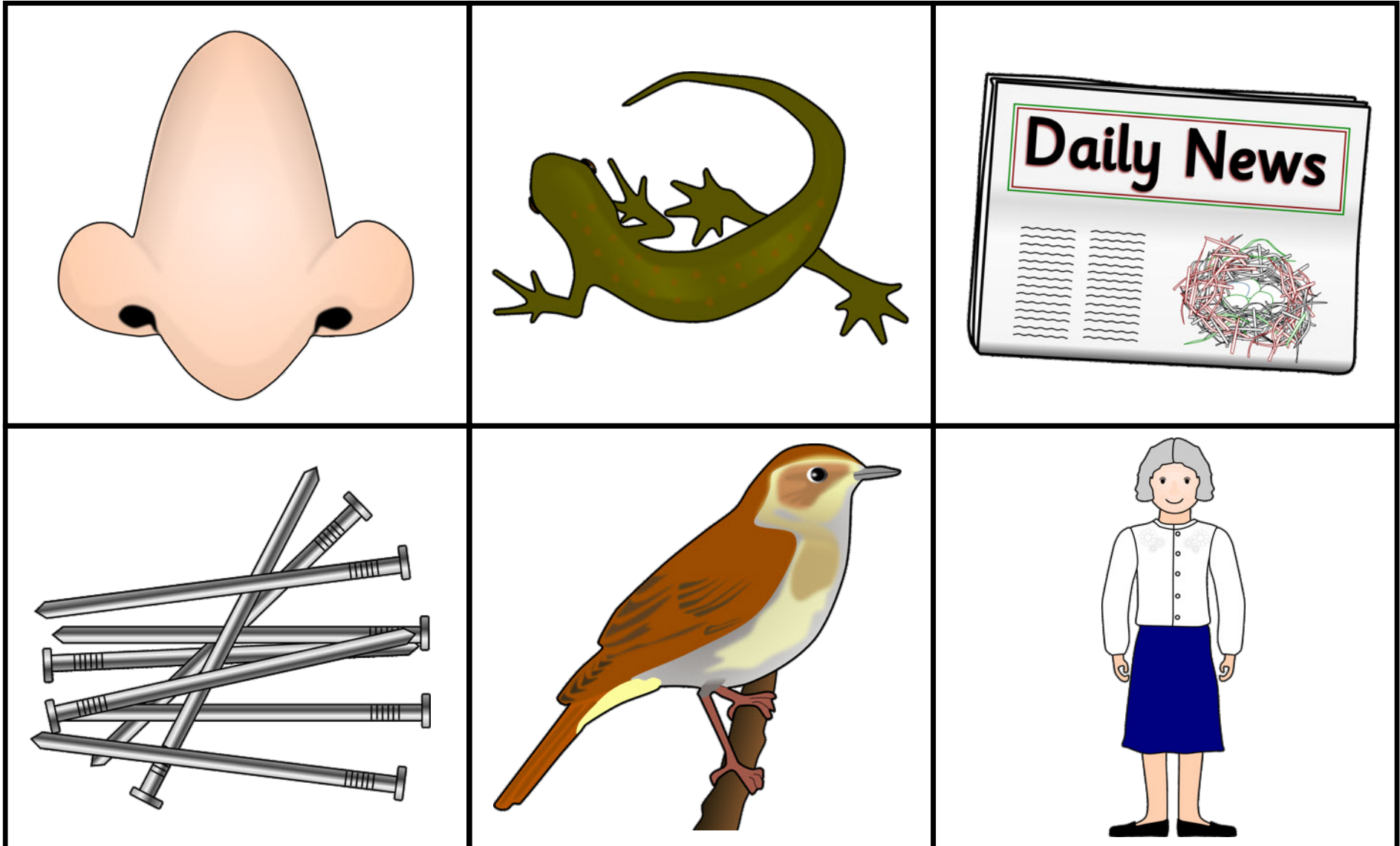

Initial sound bingo: **n**

Print several copies of the picture cards for children to match to their boards.

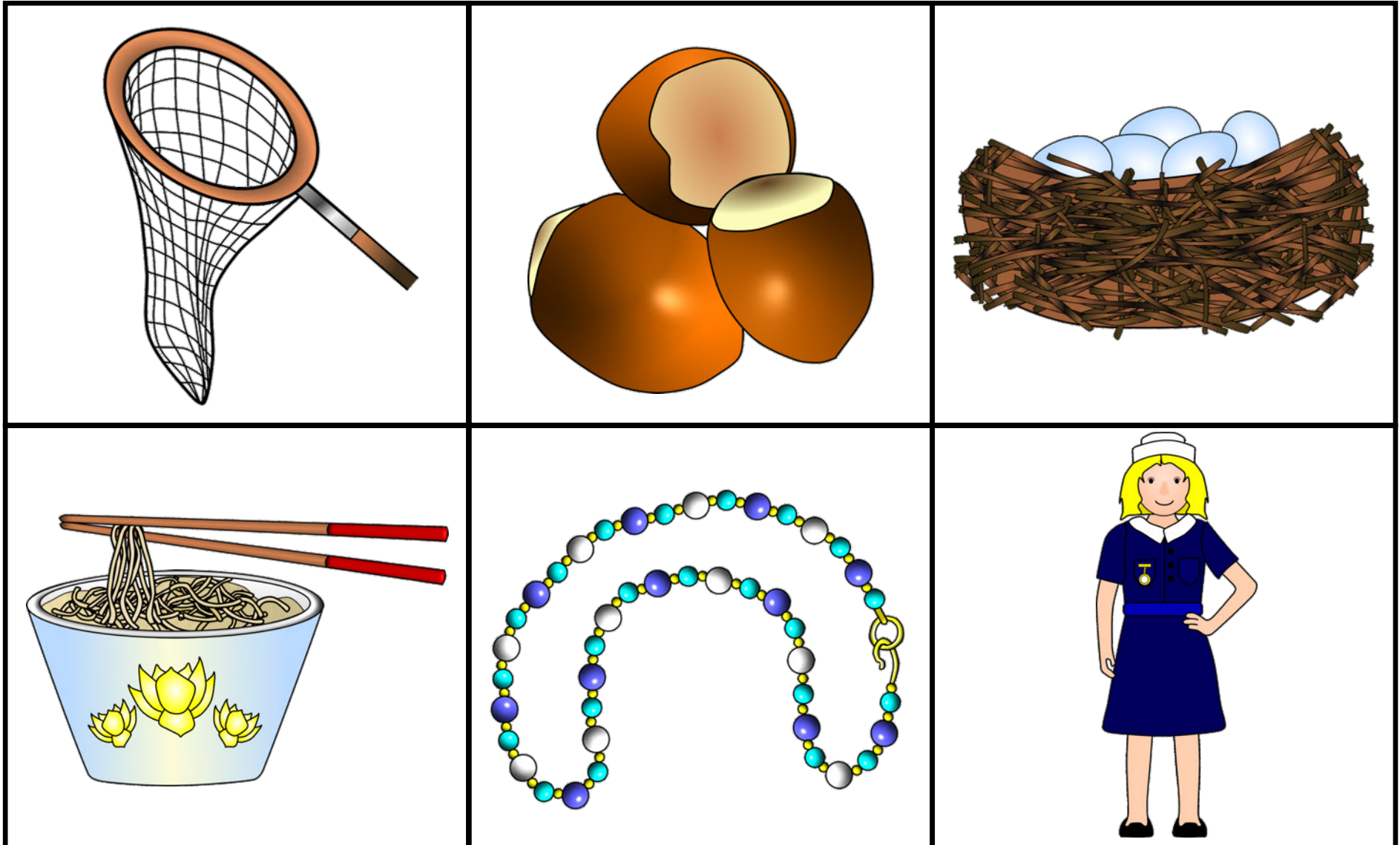

Initial Sounds

n

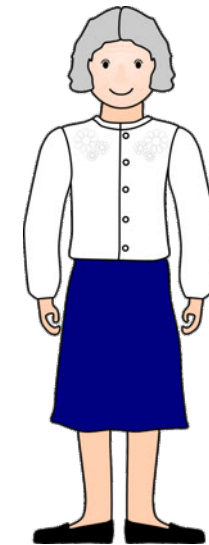
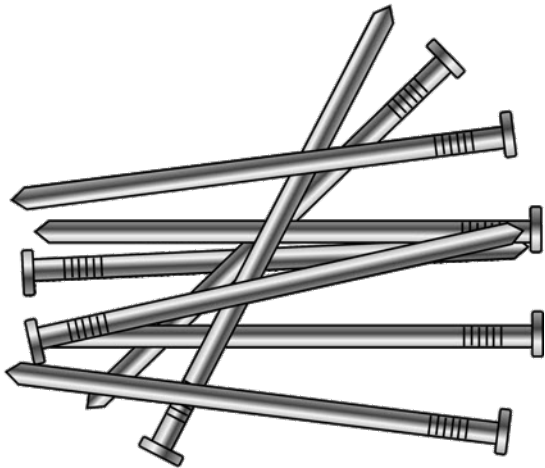
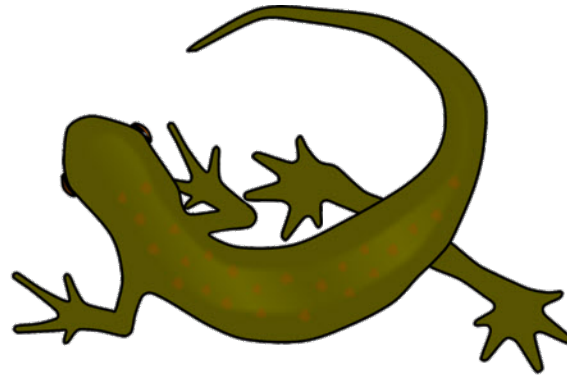
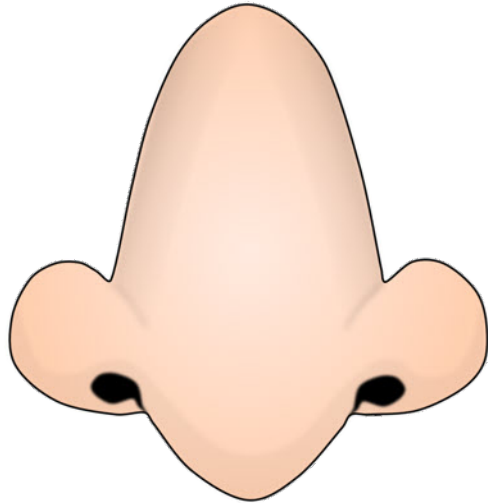

Initial Sounds

n

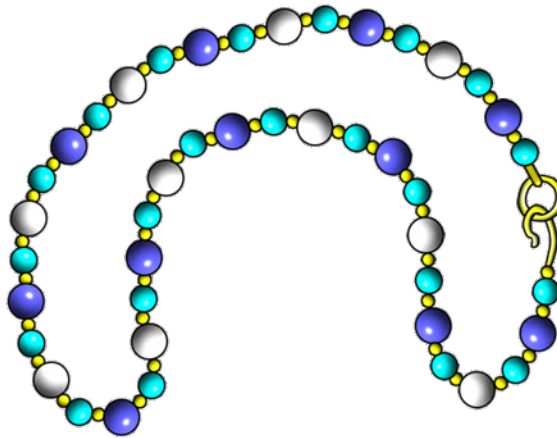
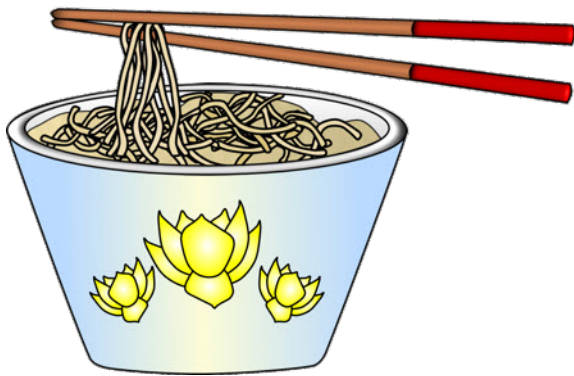
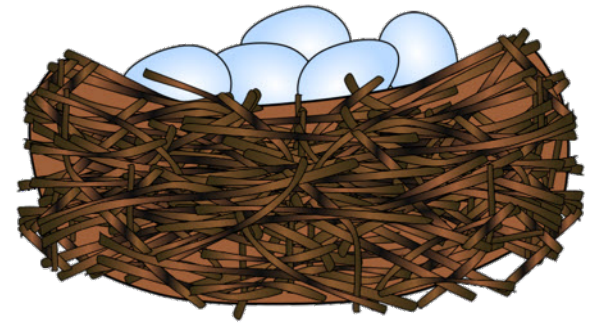
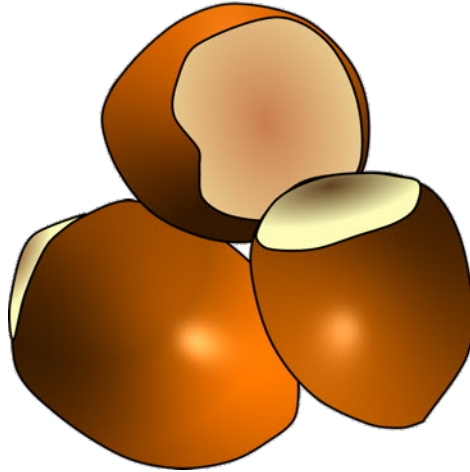
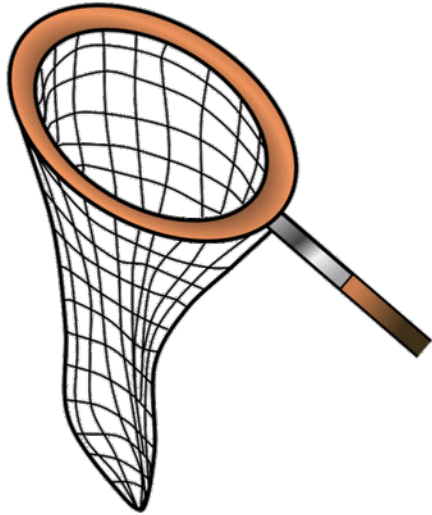

Initial Sounds

n

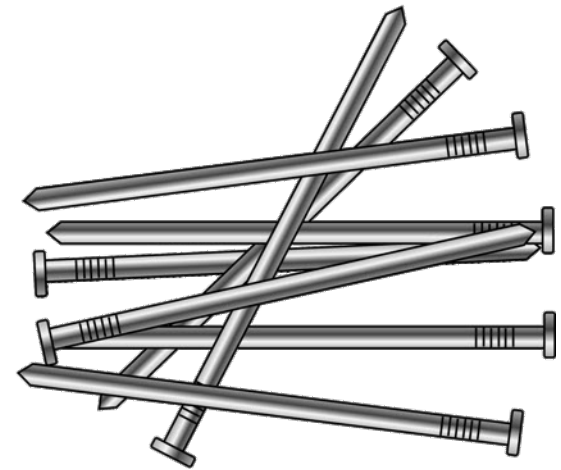
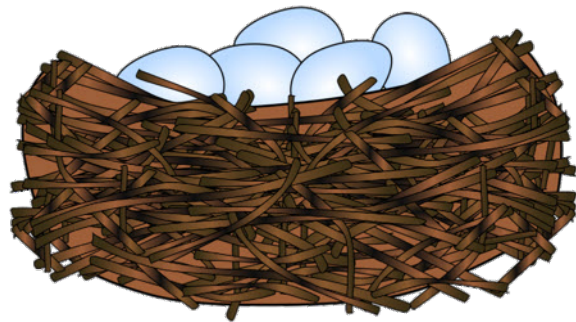
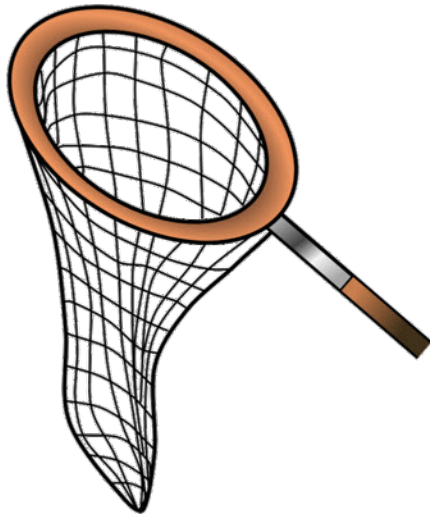
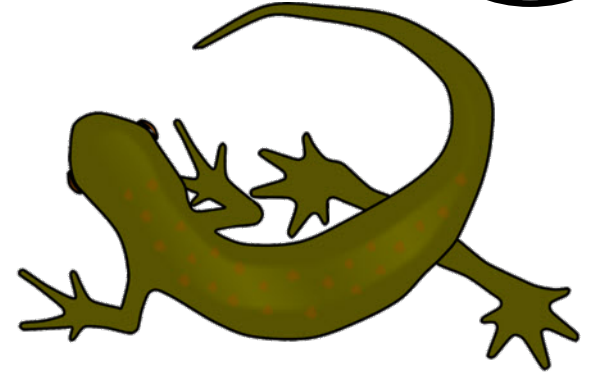
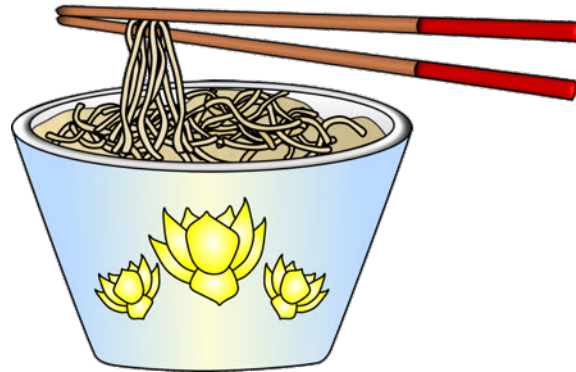

Initial Sounds

n

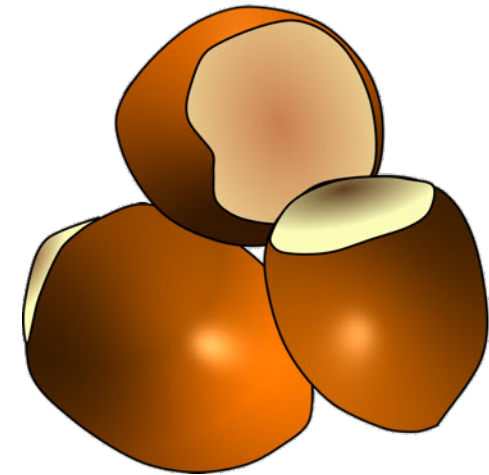
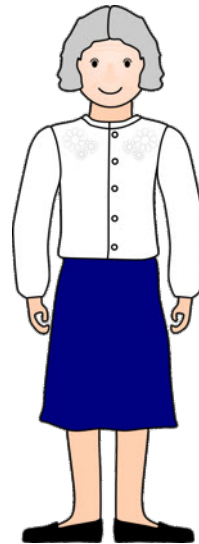
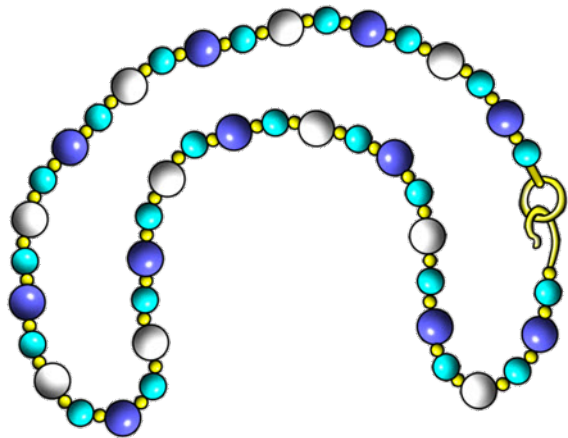
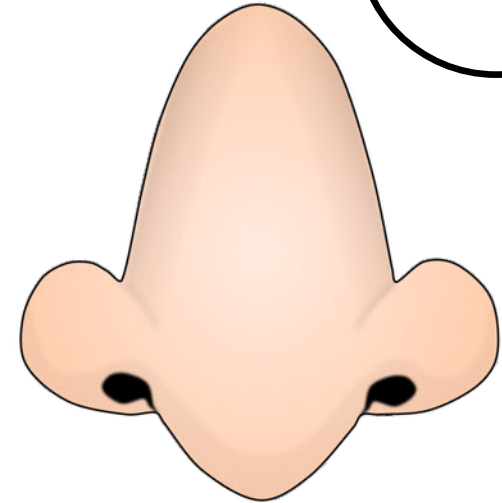
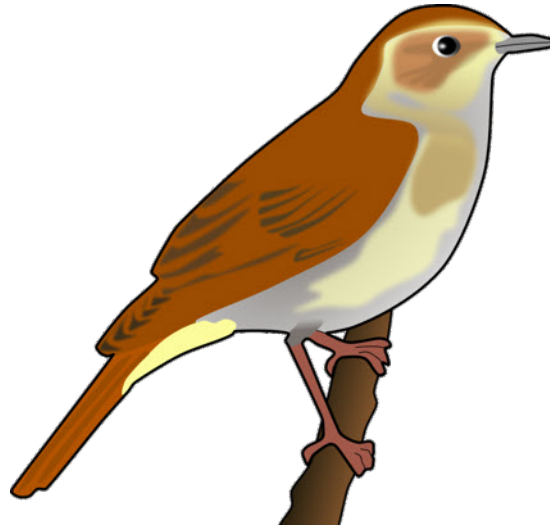

Initial Sounds

n

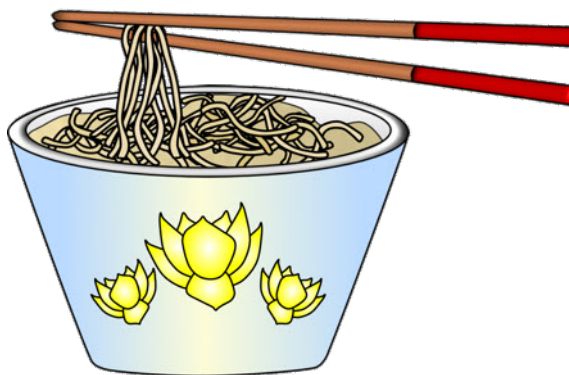
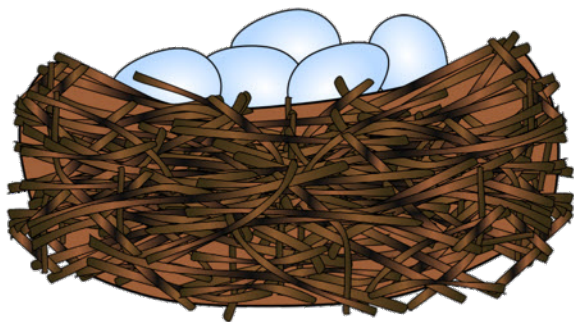
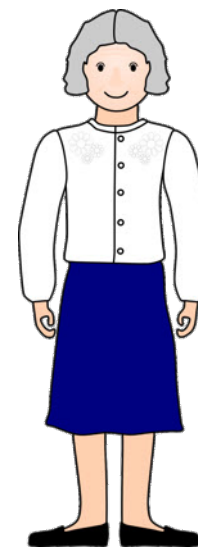
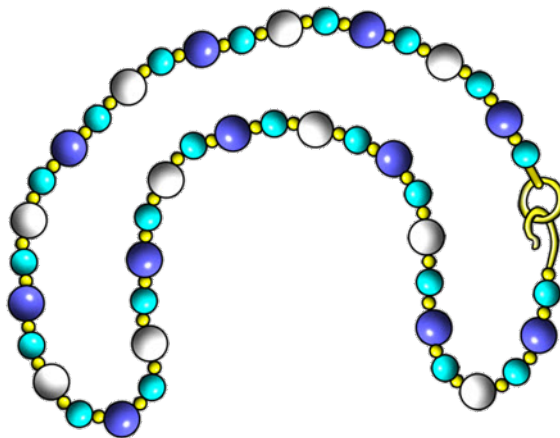
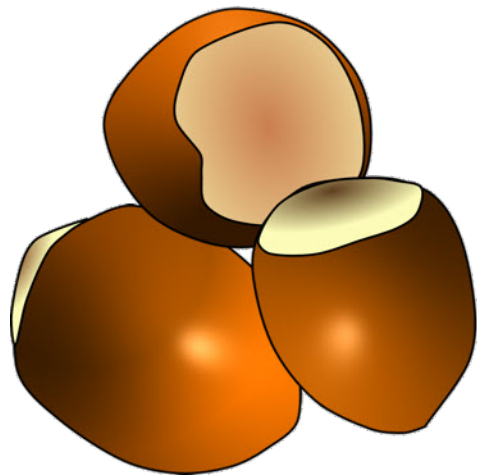

Initial Sounds

n

