

Name: _____

guitar

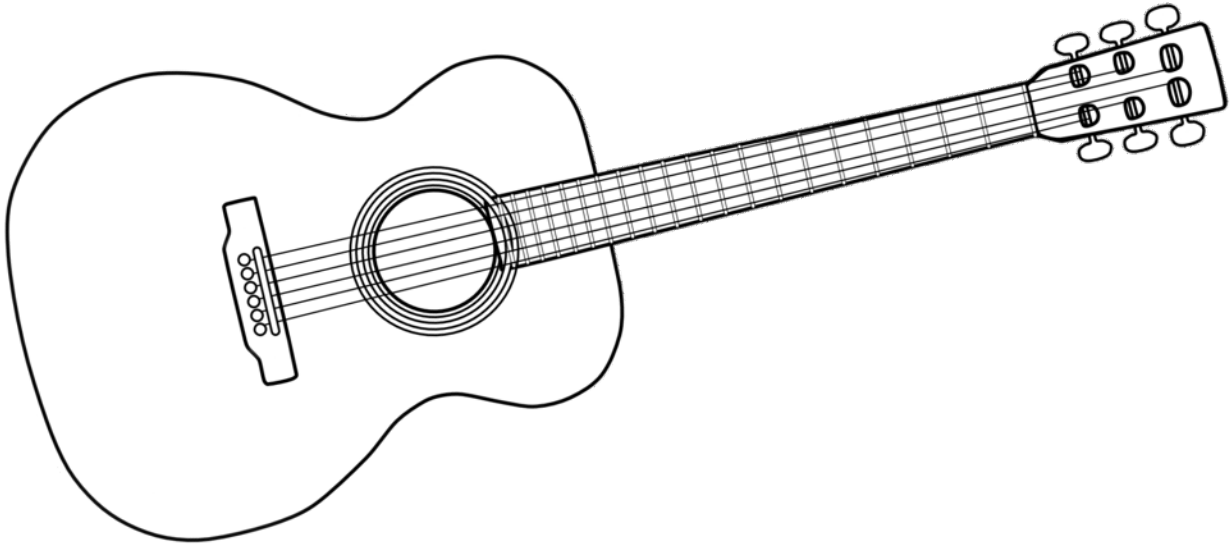

Name: _____

guitar

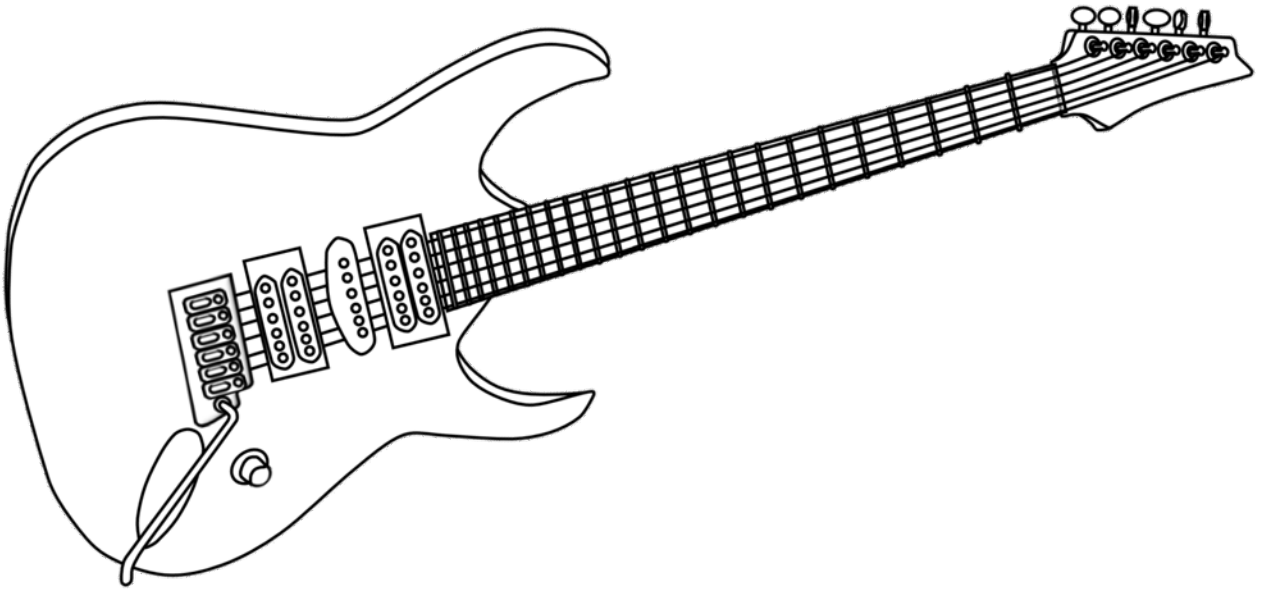

Name: _____

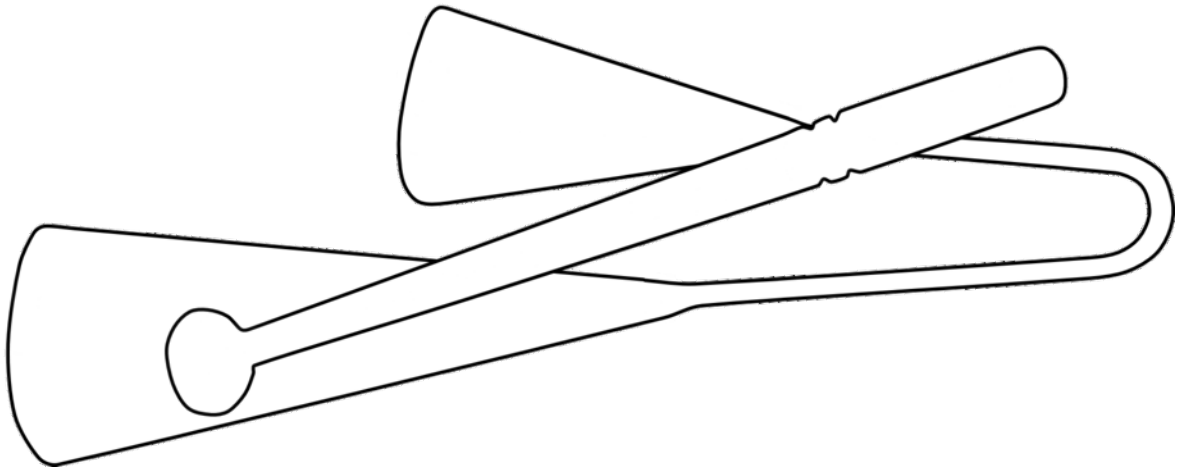

agogo

Name: _____

bells

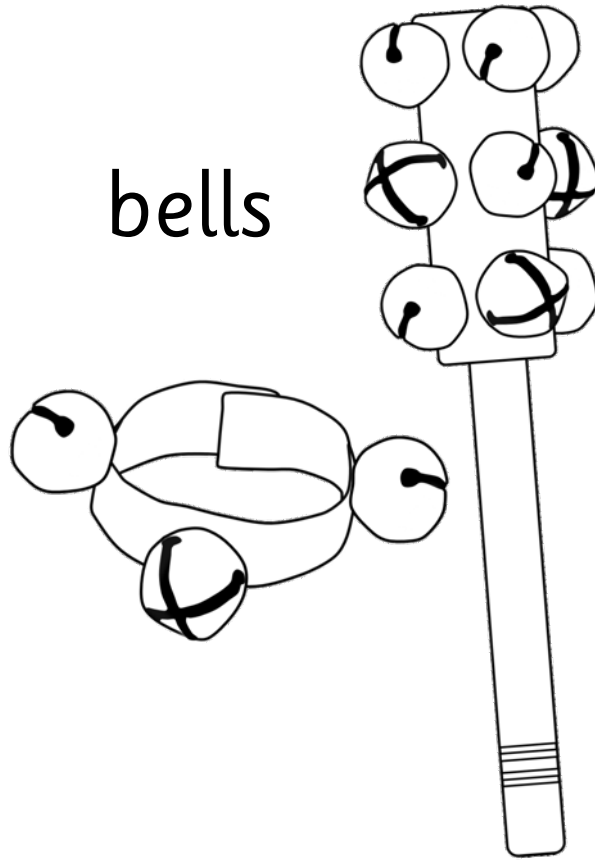

Name: _____

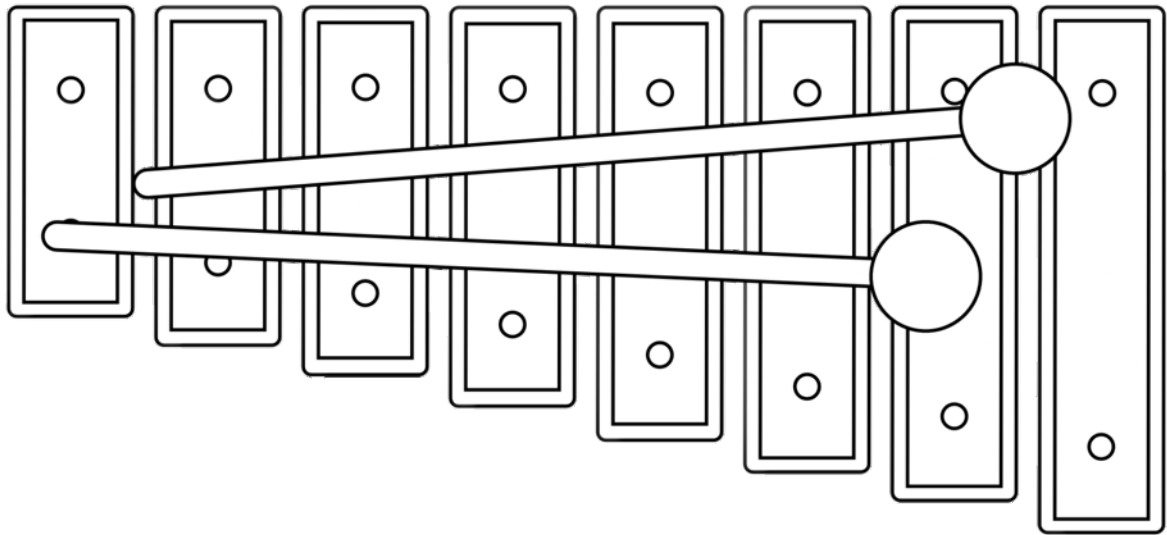

chime bars

Name: _____

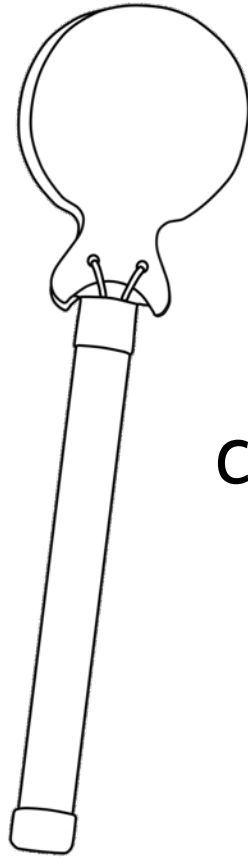

castanet

Name: _____



cello

Name: _____

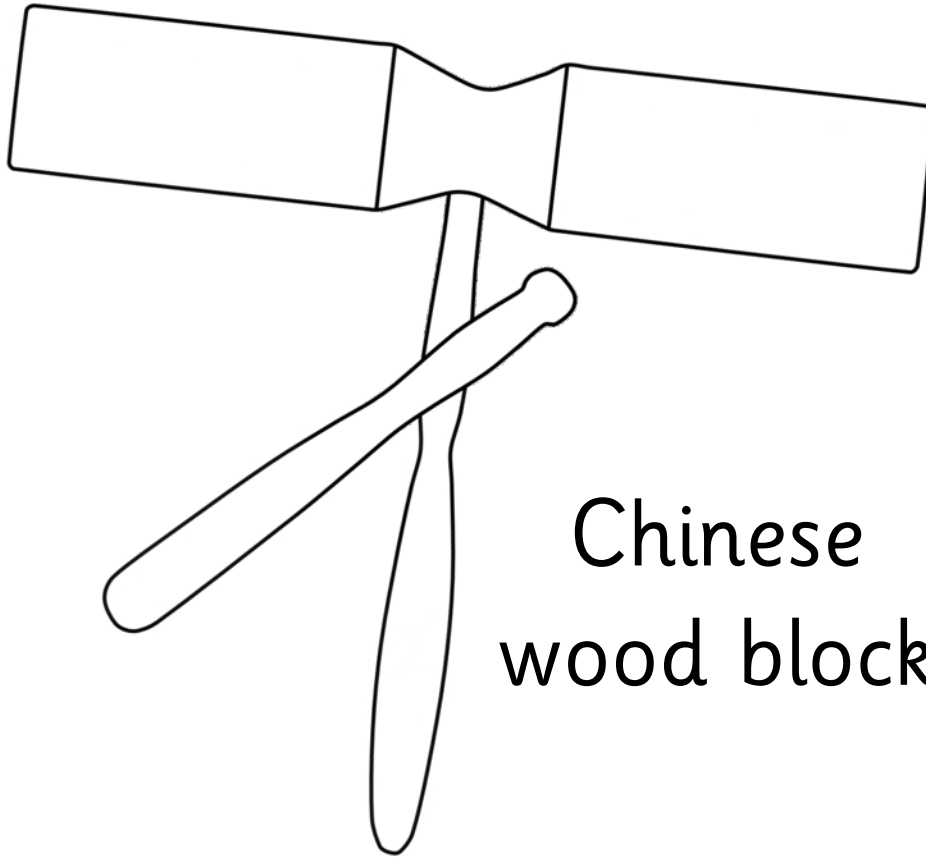

Chinese
wood block

Name: _____

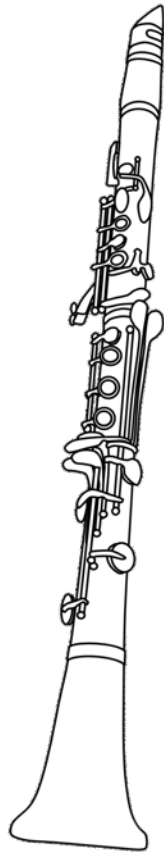

clarinet

Name: _____

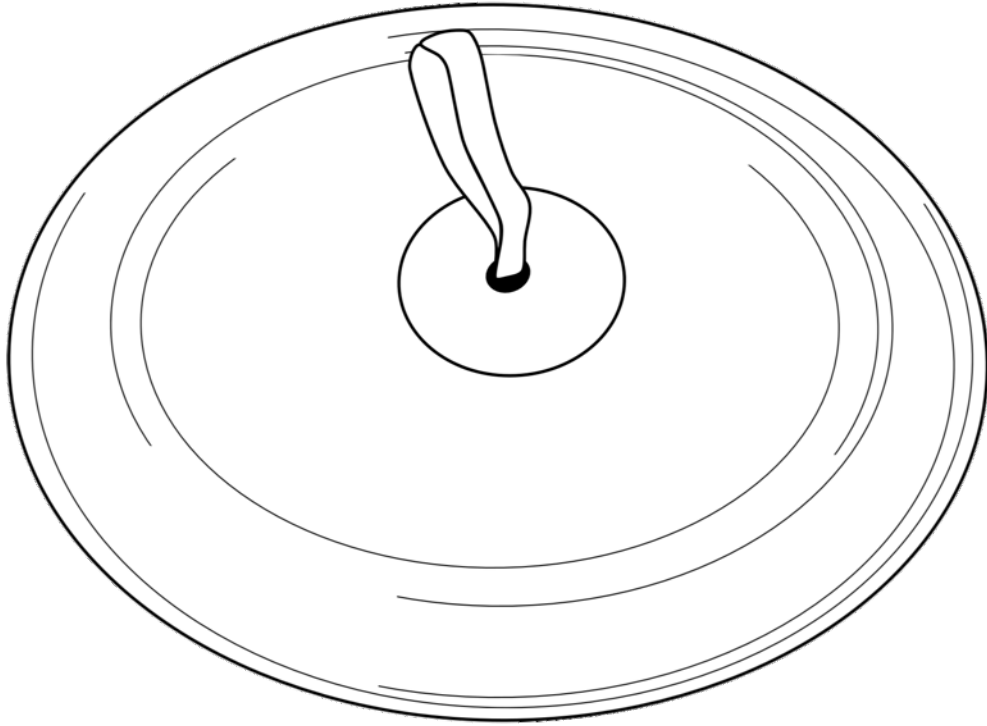

cymbal

Name: _____

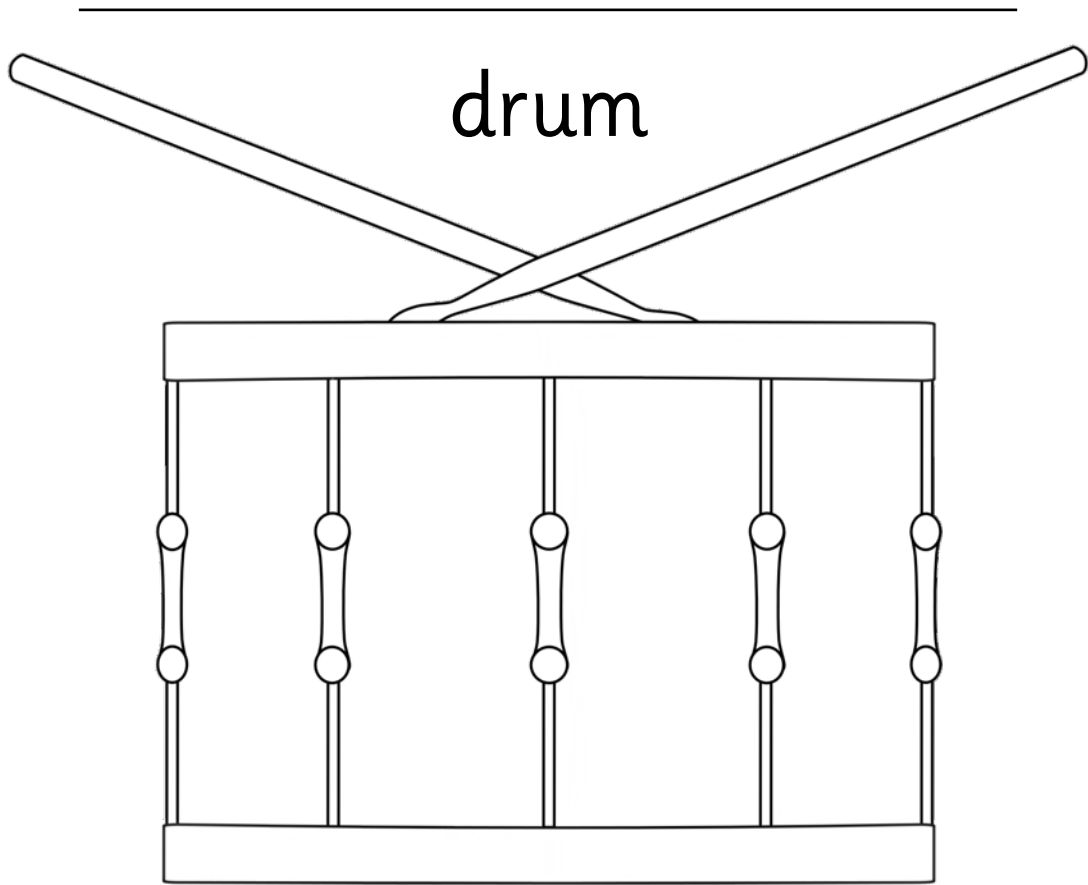

Name: _____

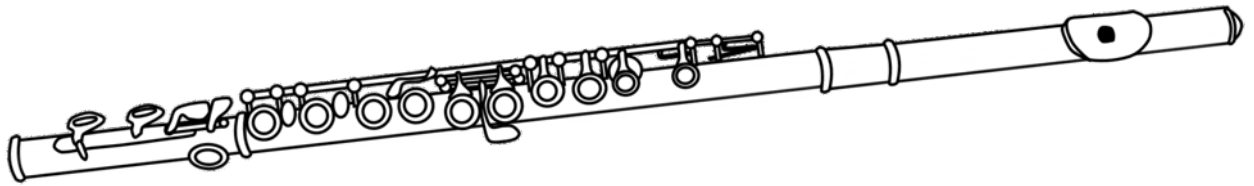

flute

Name: _____

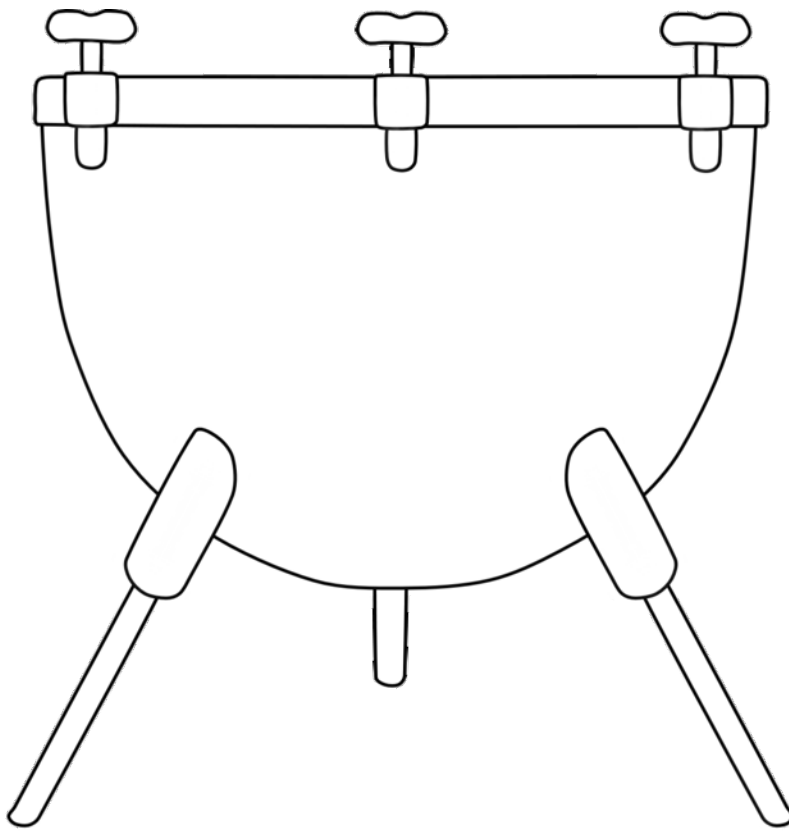

kettle
drum

Name: _____

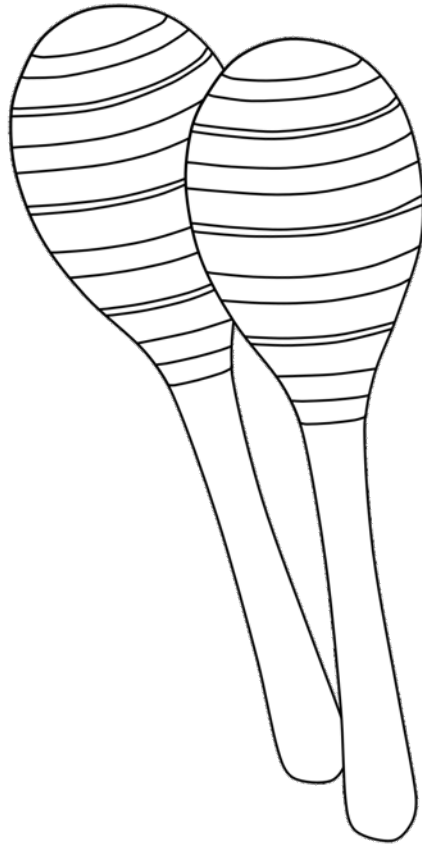

maracas

Name: _____



oboe

Name: _____

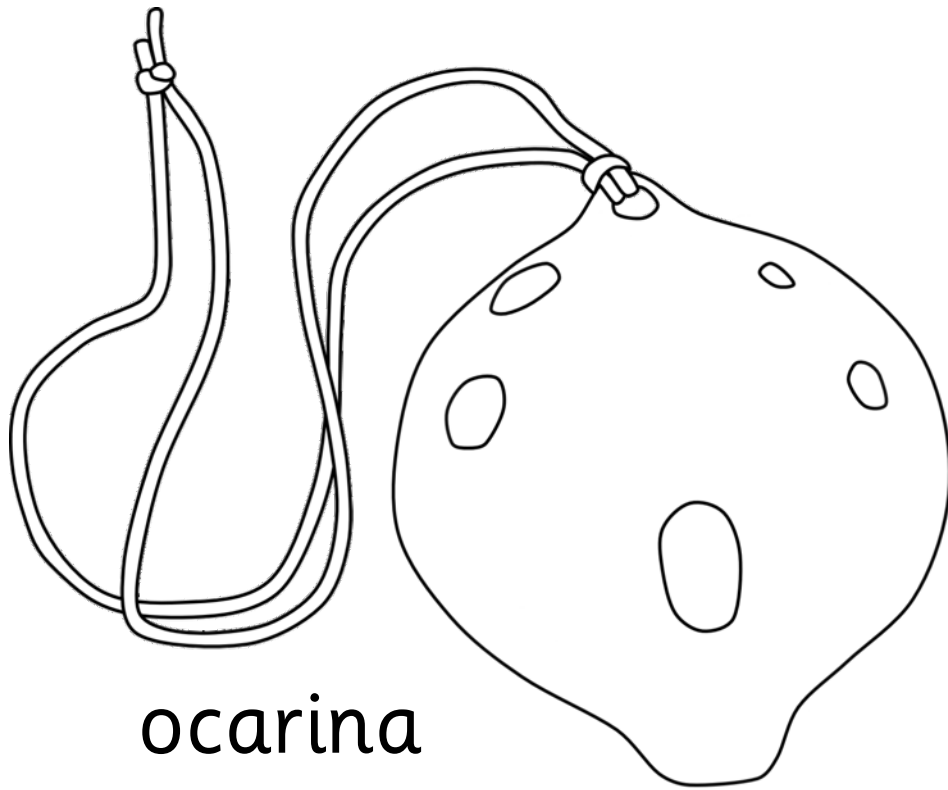

ocarina

Name: _____

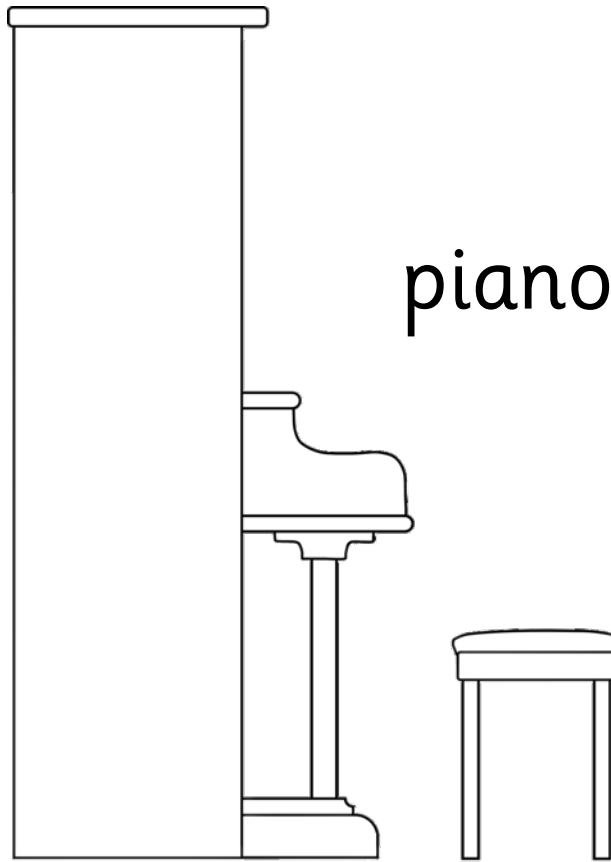

Name: _____

saxophone



Name: _____

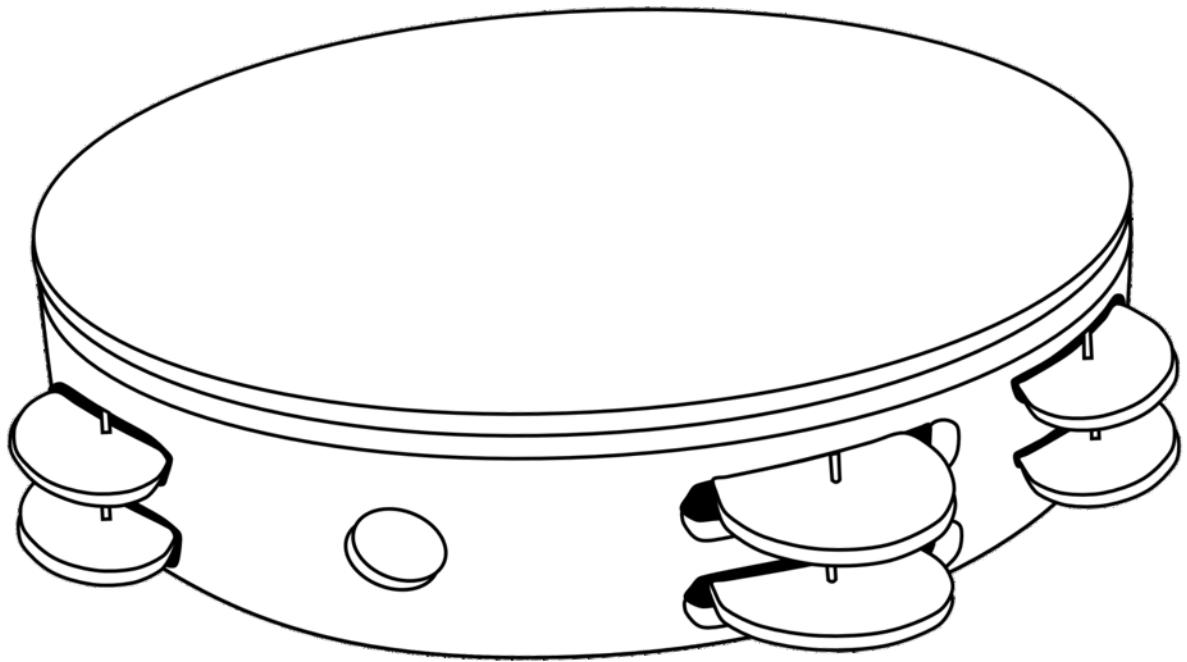

tambourine

Name: _____

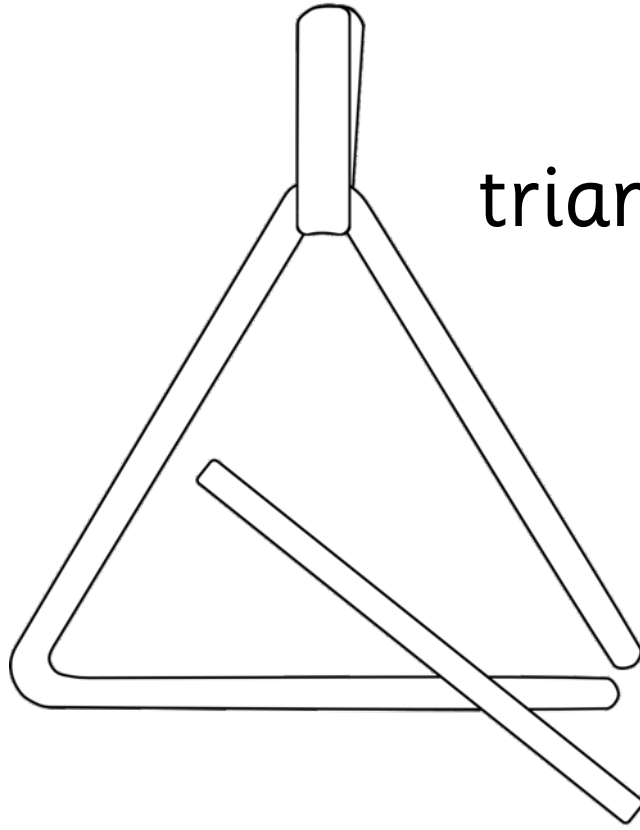

triangle

Name: _____

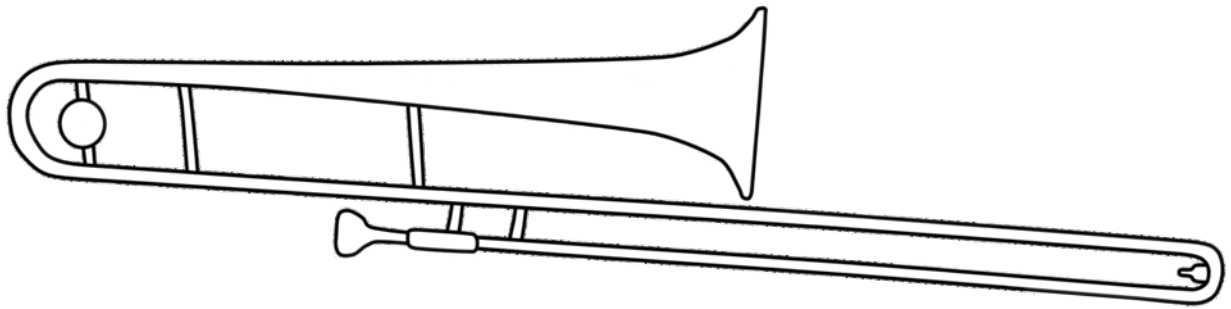

trombone

Name: _____

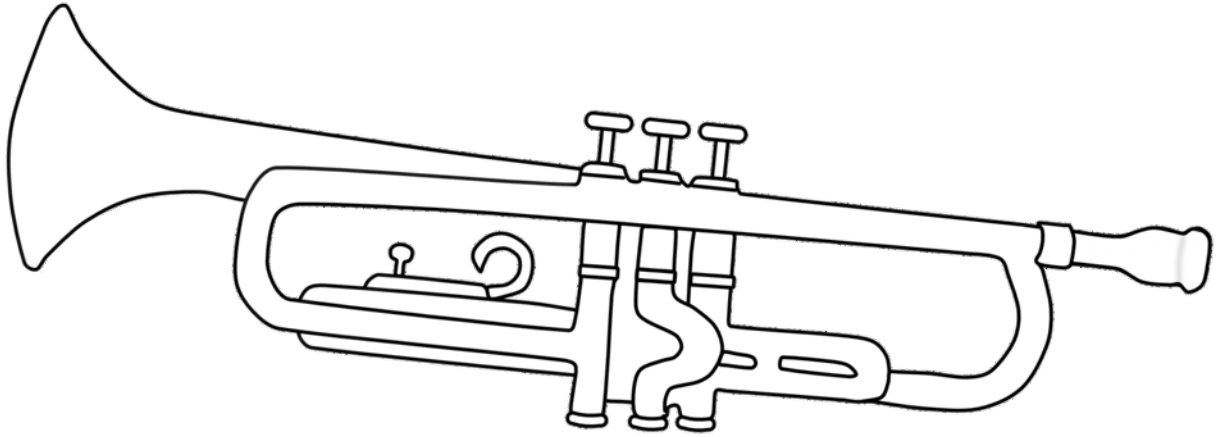

trumpet

Name: _____

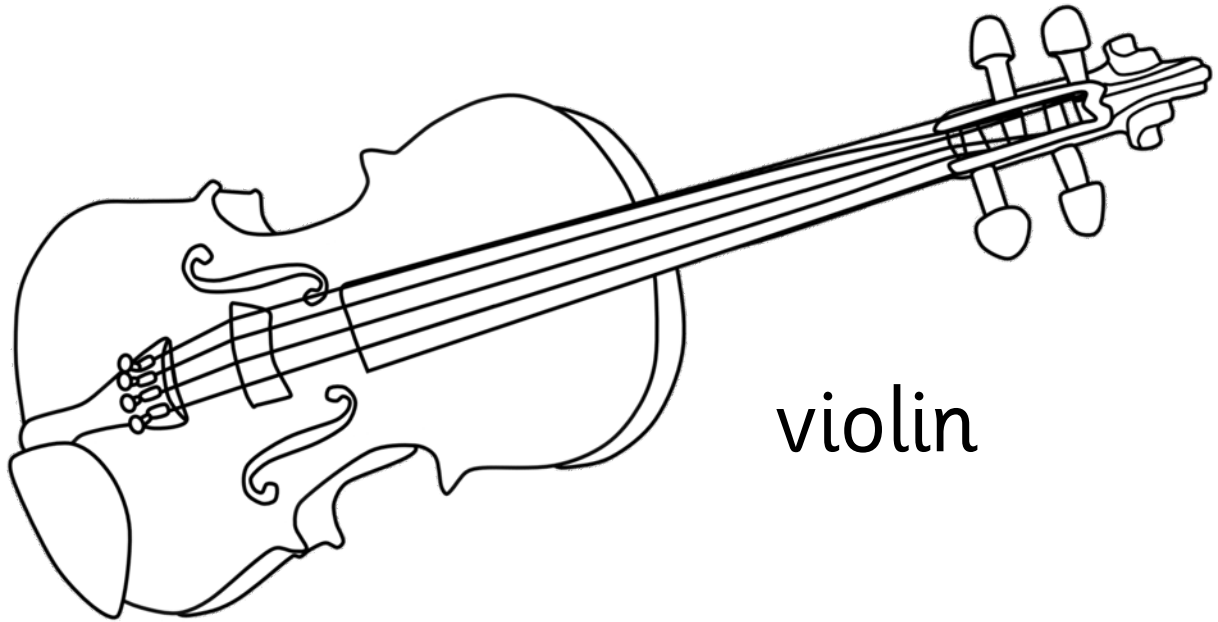

Name: _____

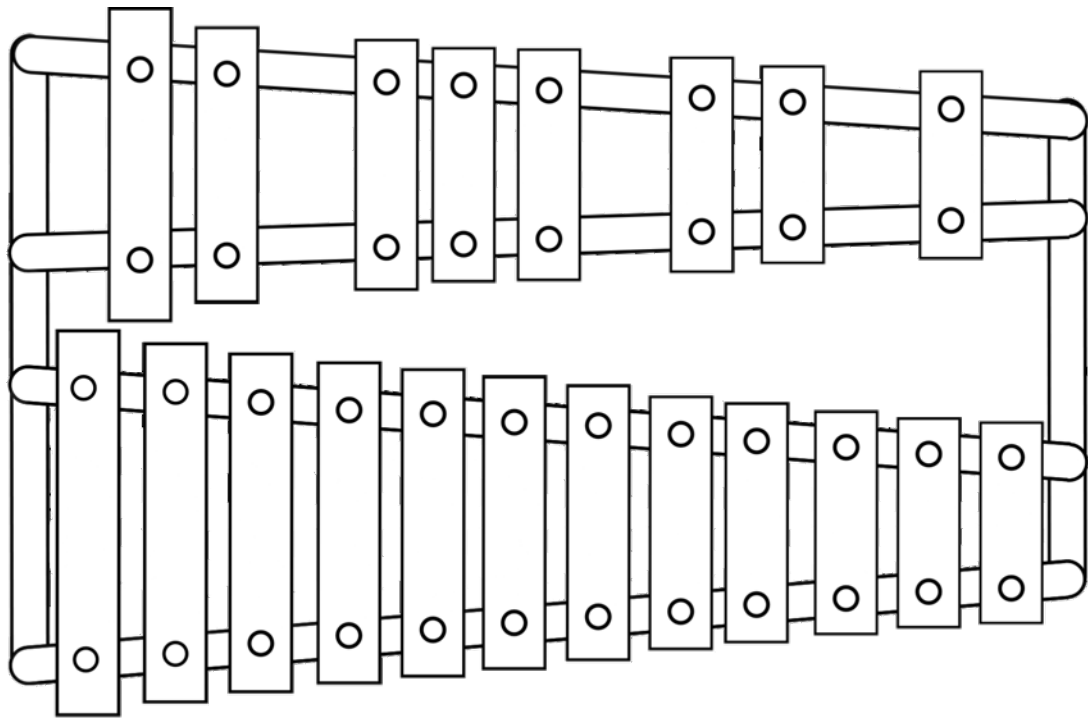

xylophone
