

Words with oi and oy

toys

boy

join

royal

coins

soil

Words with oi and oy

cowboy

oil

boil

oyster

foil

coil

Words with oi and oy

coil

toys

coins

soil

oil

cowboy

Words with oi and oy

royal

boil

boy

join

oyster

foil

Words with oi and oy

cowboy

oyster

oil

toys

soil

join

Words with oi and oy

boil

coins

royal

boy

foil

coil

Words with **oi** and **oy** bingo

Print several copies of the picture cards for children to match to their boards.

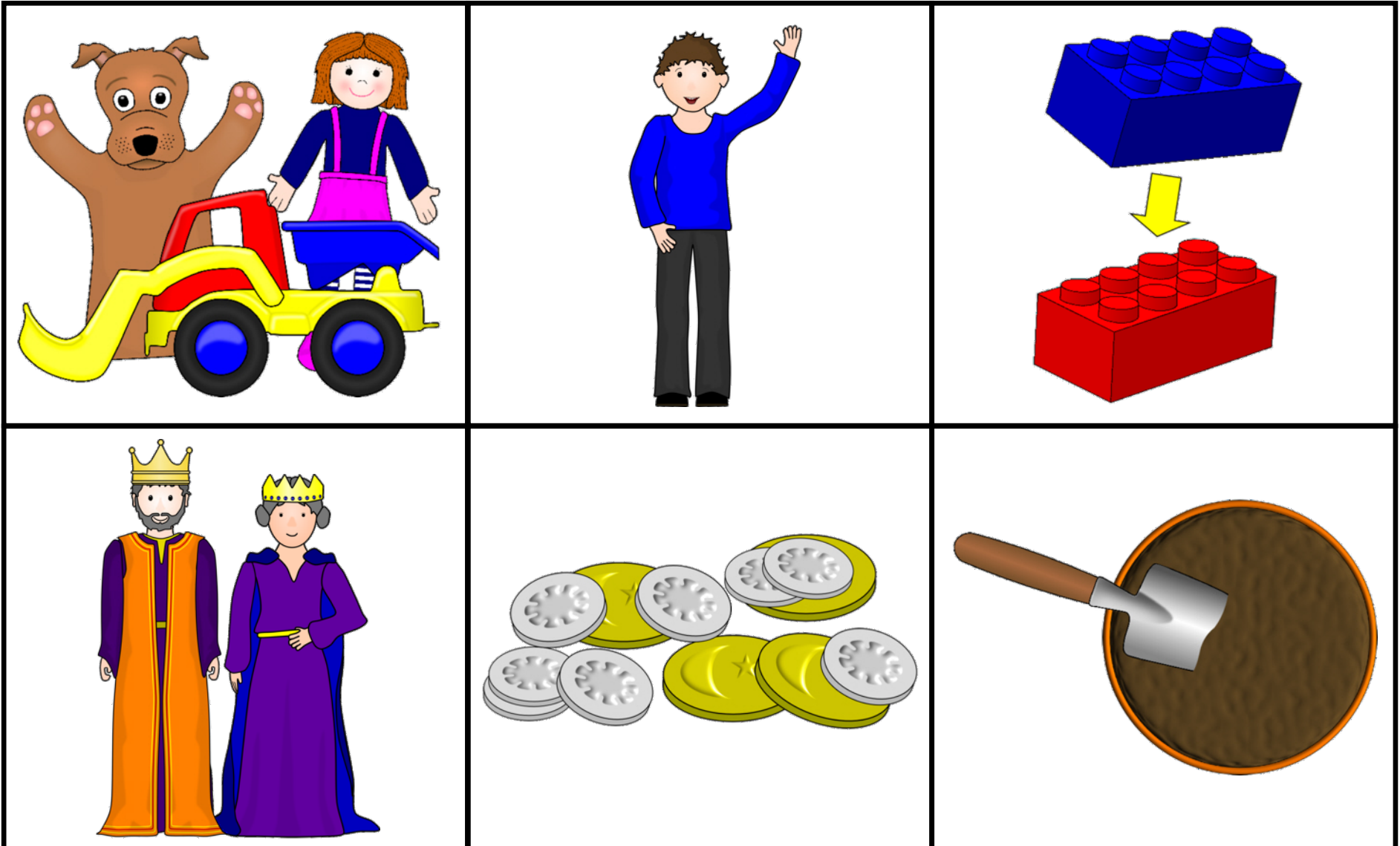

Words with **oi** and **oy** bingo

Print several copies of the picture cards for children to match to their boards.

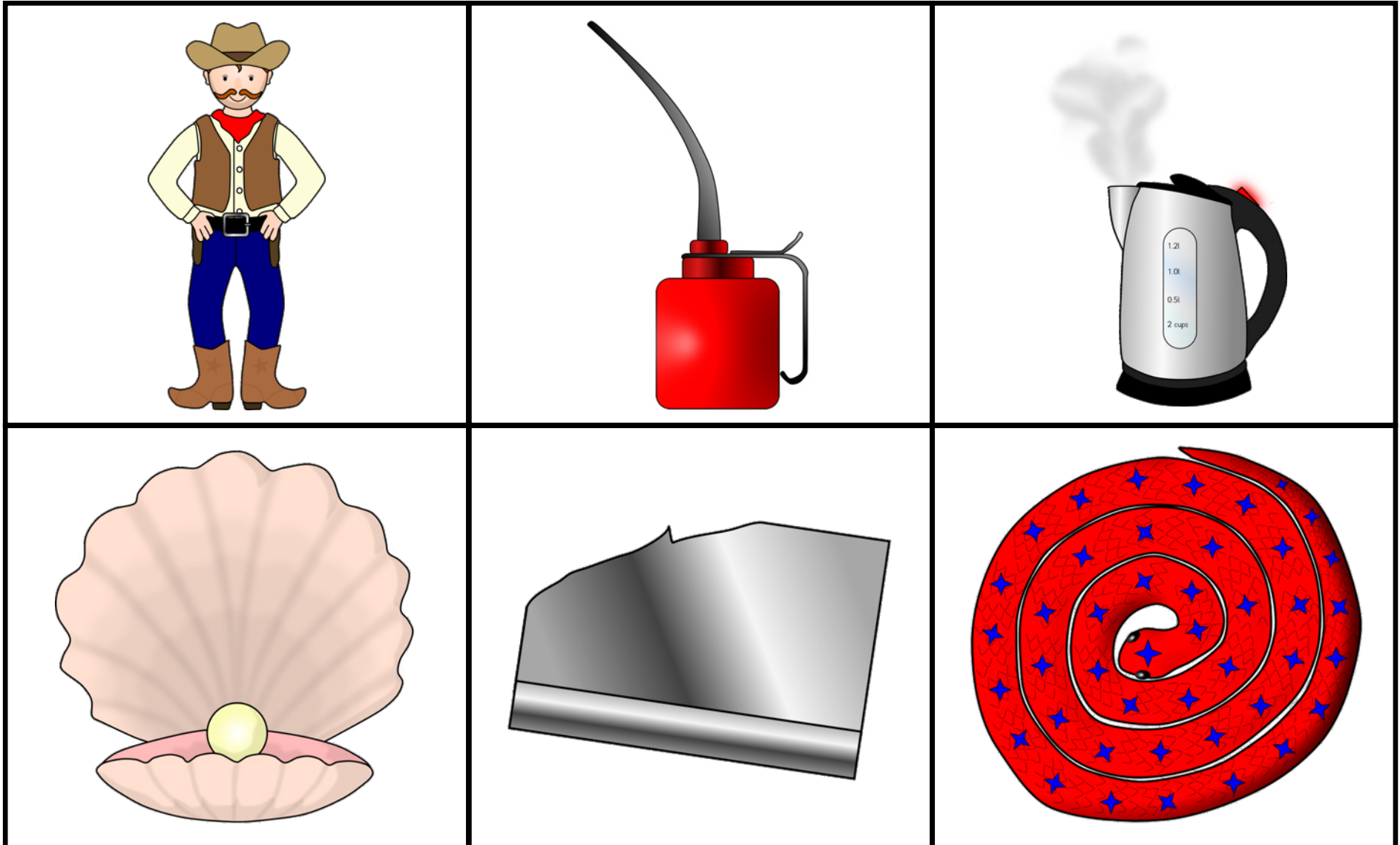

Words with oi and oy

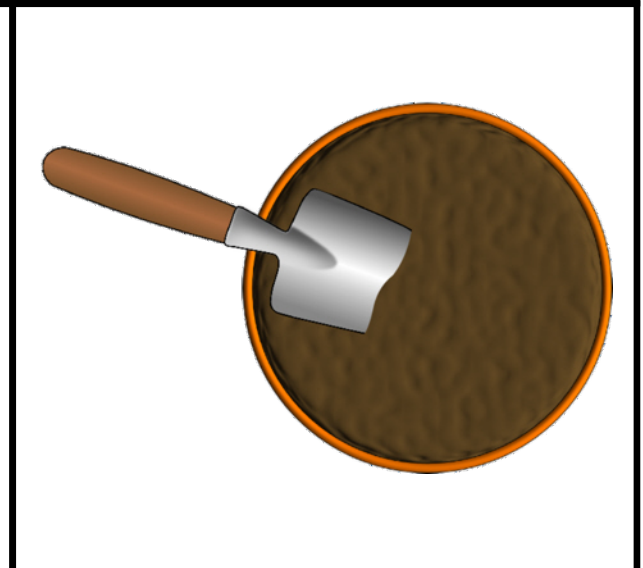
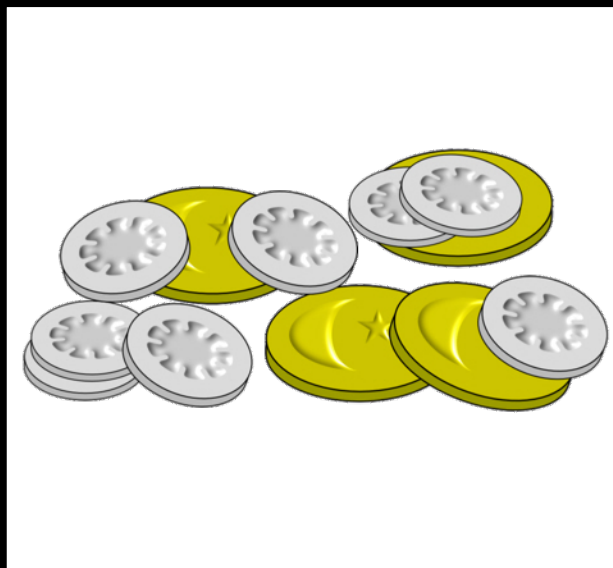
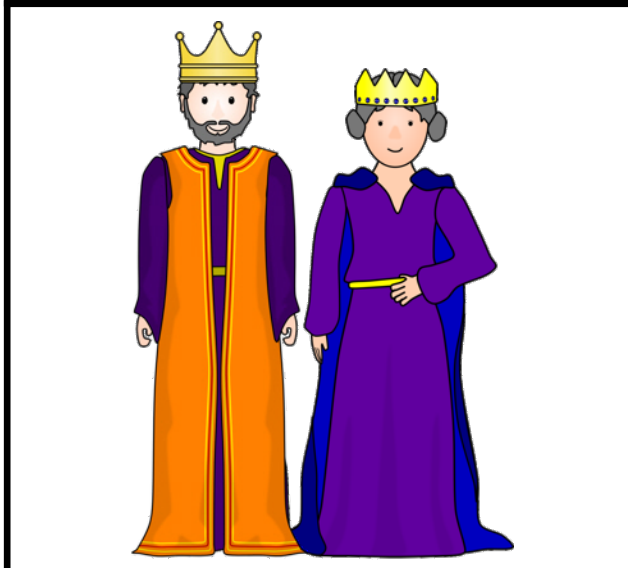
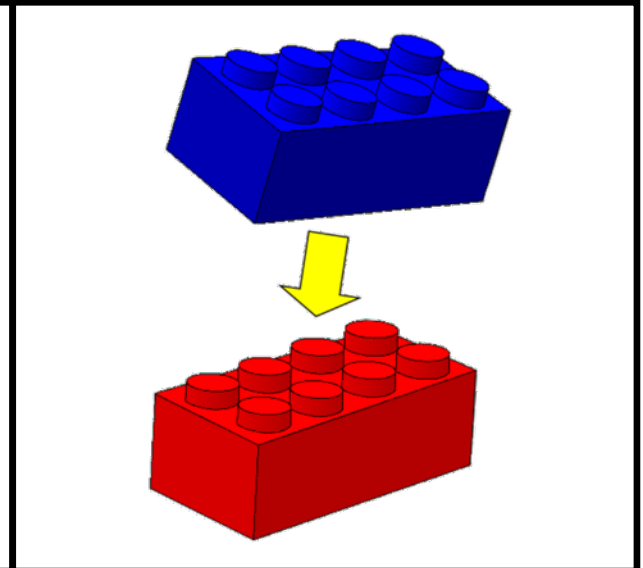

Words with oi and oy

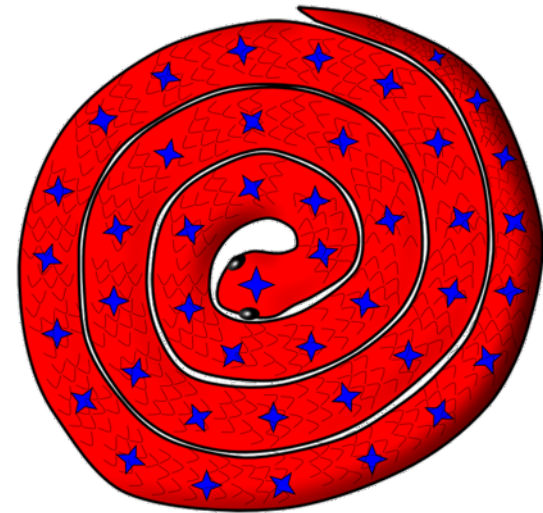
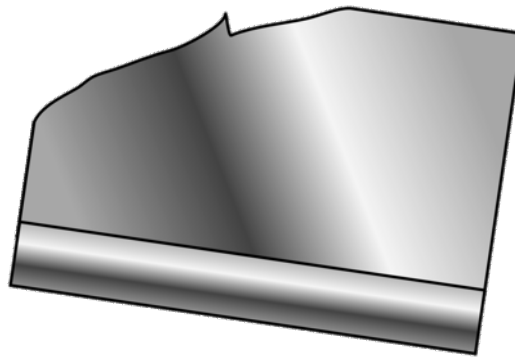
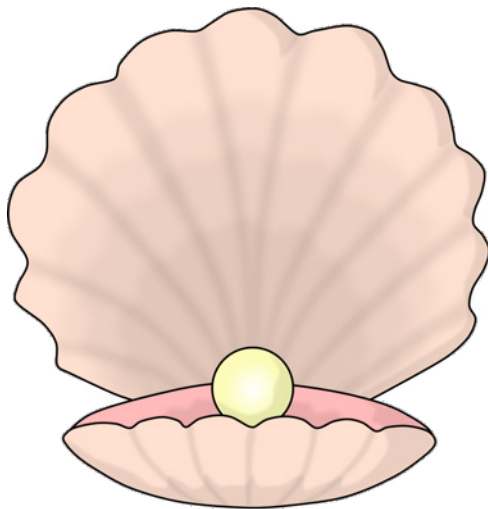
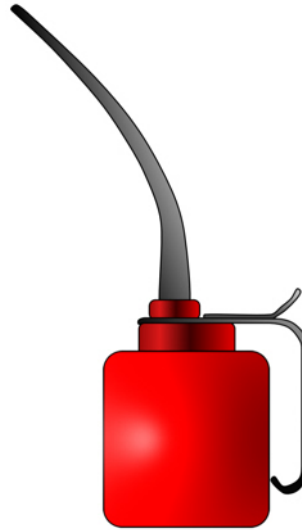
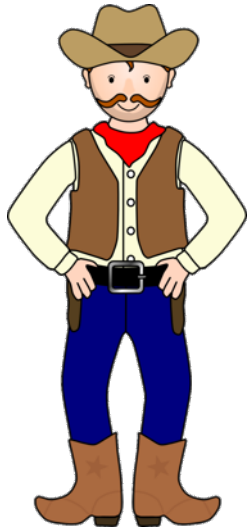

Words with oi and oy

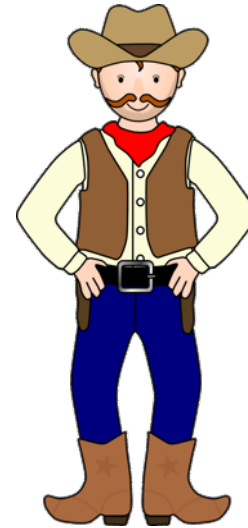
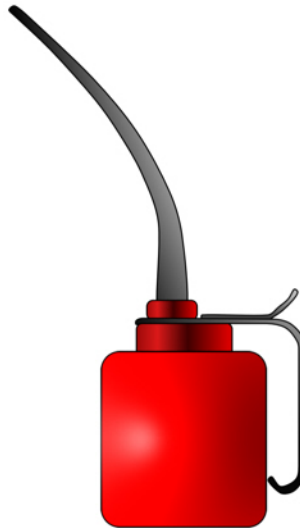
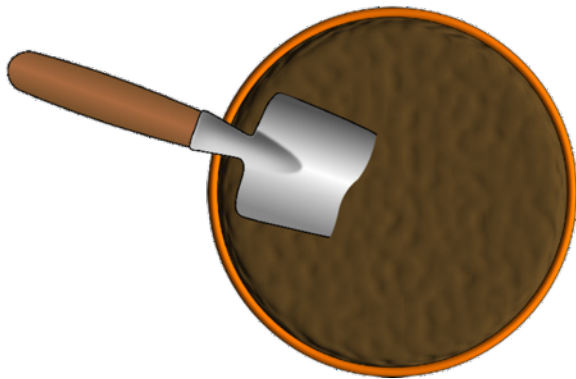
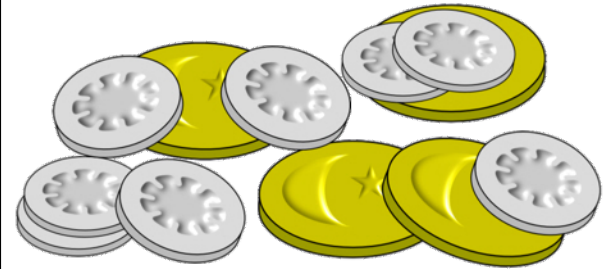
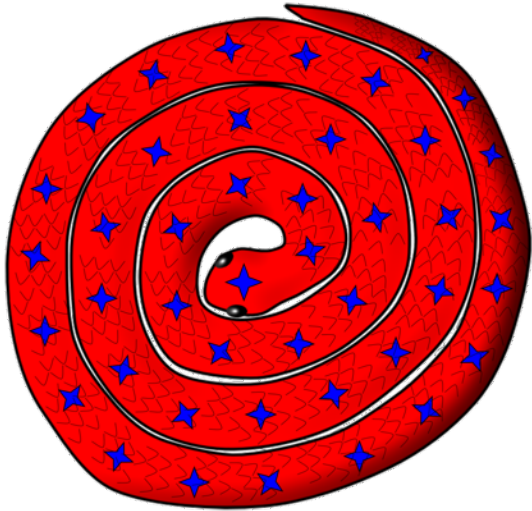

Words with oi and oy

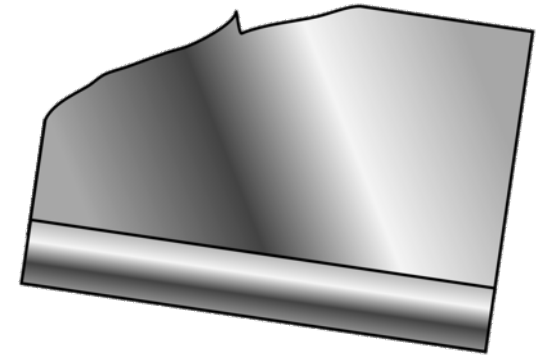
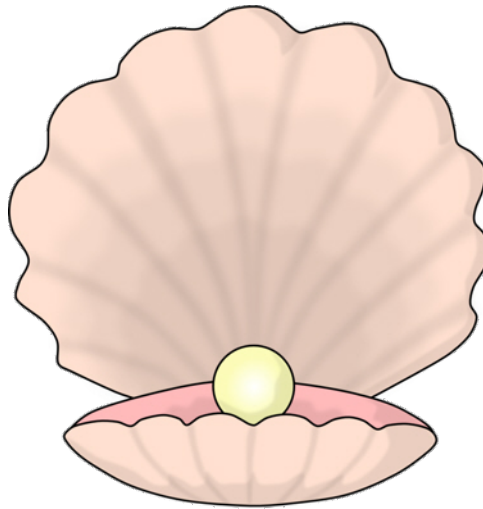
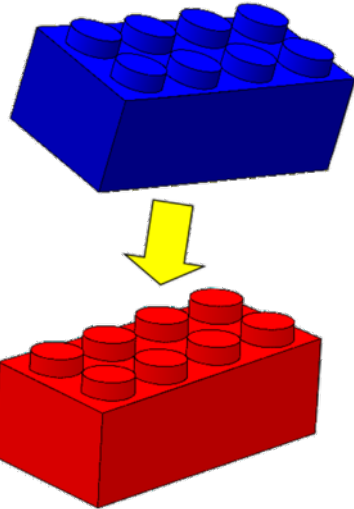

Words with oi and oy

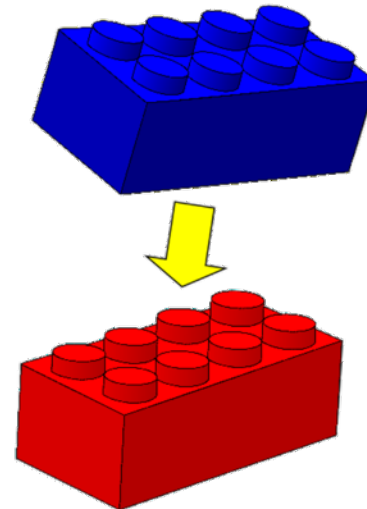
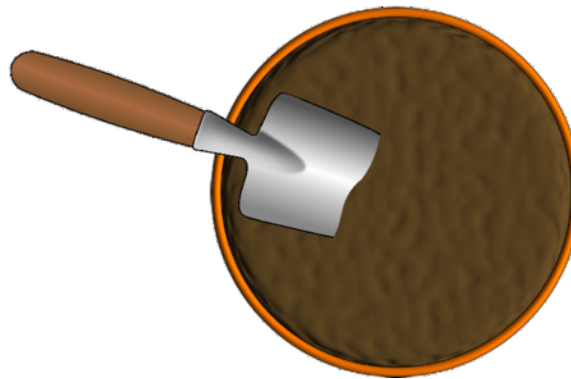
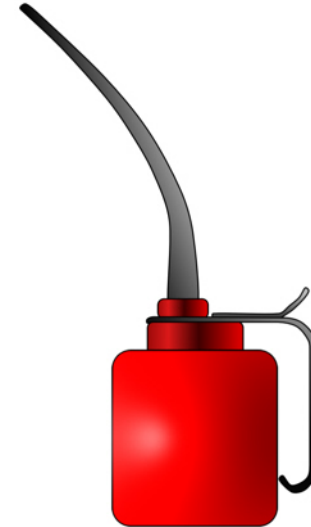
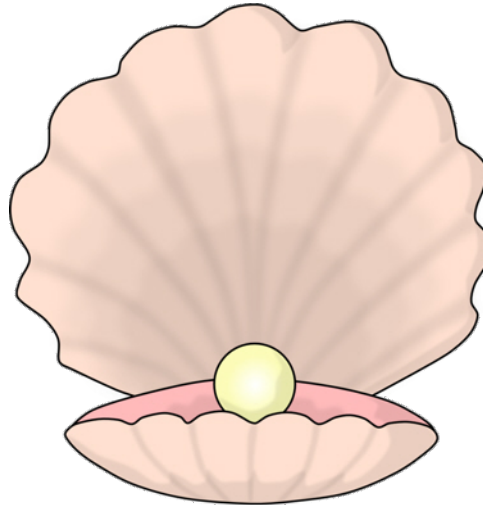
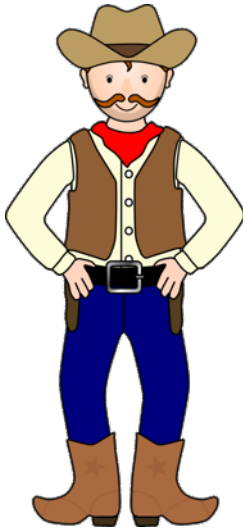

Words with oi and oy

