

Capital Projects
& Construction

TECHNICAL DESIGN STANDARDS

Revision 0 - May 30th, 2014

INTRODUCTION

Revision 0, May 30th, 2014

Dear User,

Portland State University strives to create a quality environment for all students and users of its facilities. The Capital Projects and Construction Department (CPC), as part of PSU's Office of Planning, Construction & Real Estate, manages all renovation and construction projects on the PSU Campus. We take this responsibility with an enthusiastic approach, reflected in our department's mission: "To design and build a modern, sustainable campus that enhances our student learning experience and reinforces the academic mission".

With the intention of clearly and concisely communicating our standards, including preferences and recommendations, to the team of Consultants and Contractors who work on our projects, we composed these Technical Design Standards. The work involved in the creation of this document comprised obtaining information from important stakeholders on campus, including the professionals who manage PSU's daily campus and maintenance activities, as well as the leaders who define PSU's strategic approach and future vision. Their expertise, experience, ideas, and recommendations, in addition to our own knowledge of best design and construction practices, were incorporated into this document to guide and assist Campus design efforts.

The PSU CPC Technical Design Standards are divided into sections that follow the Construction Specifications Institute (CSI) standards. This format facilitates the use and familiarity by the design and construction professionals. In addition, the guidelines in this document focus on PSU's vision to create facilities having the following characteristics:

- **Adaptability**

PSU buildings may, over the course of their lifetime, be re-purposed for uses that were likely not considered at the time of their design. As such, all buildings must be designed in such a way as to allow for changes in purpose and occupancy.

- **Durability**

PSU buildings need to be resilient. As some of the most heavily and intensely used public buildings in the state, they must be designed to meet dense use, which means all materials and systems must be durable, repairable, and easily maintainable. In addition, State funding for deferred maintenance is scarce, making durability especially important.

- **Maintainability**

PSU has very limited funds for on-going preventative maintenance of its facilities. Therefore, its buildings and their components must be designed for the application of limited maintenance resources. For example, inaccessible fixtures and equipment requiring constant servicing should not be included in designs.

- **Timeless Design**

PSU buildings must be designed with the highest sense of aesthetics. The University's status as a premier educational institution in the heart of Portland requires that its facilities reflect this philosophy.

- **Sustainability**

PSU intends that its buildings not only meet the highest level of current sustainable design, but also reflect innovation in this regard. Therefore, targeting highest degrees of efficiency in resources and simplicity of processes are requirements for all campus design and construction activities.

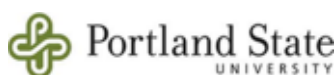

- **Energy Efficiency**

PSU's energy costs comprise a major portion of its operating budget. All new buildings and major remodels must be engineered to be as energy efficient as possible, while providing the necessary level of comfort for the Campus community.

- **Innovation**

PSU, as a leading community institution, must strive for innovation in all construction projects. It must be in the forefront of advocating for the use of innovative design, construction techniques, and building systems.

- **Environmental Health & Safety**

Toxic and hazardous materials should be eliminated from construction materials and components, if possible. Preventing the exposure of building occupants to unhealthy materials is very important to the University.

At CPC we learn from every new project. We believe that the collaboration and input of the in-house team of professionals from various Departments is extremely valuable and we attempt to constantly encourage their participation. Hence, our Technical Design Standards is not a finished and timeless document; it is intended to be reviewed and re-issued every 6 months by our Department as a result of lessons learned from our projects and industry practices, as well as new technologies in construction. In striving for constant improvement, we welcome your feedback.

We are excited about our Department's role in shaping the PSU-of-the-future, while preserving the good things we have today. We are pleased to share this document with our partners and hope it can be used to fulfill our Department's mission.

Sincerely,

The Staff of the Capital Projects & Construction Department

PORTLAND STATE UNIVERSITY
DESIGN AND CONSTRUCTION STANDARDS

TABLE OF CONTENTS

01. GENERAL REQUIREMENTS

- A. SUMMARY REQUIREMENTS
- B. REGULATORY REQUIREMENTS
- C. SUSTAINABLE DESIGN
- D. EXISTING CONDITIONS AND ENVIRONMENTAL ASSESSMENT
- E. FACILITY SHELL PERFORMANCE REQUIREMENTS
- F. CUSTODIAL REQUIREMENTS

03. CONCRETE

- A. CONCRETE

04. MASONRY

- A. MASONRY

05. METALS

- A. STRUCTURAL METALS
- B. ARCHITECTURAL METALS

06. GENERAL CARPENTRY

- A. ARCHITECTURAL WOOD CASEWORK
- B. FINISH CARPENTRY
- C. METAL STUD WALLS.

07. THERMAL AND MOISTURE PROTECTION

- A. ROOFING
- B. TRAFFIC COATINGS

08. OPENINGS

- A. DOORS, RELITES, AND FRAMES
- B. DOOR HARDWARE

09. FINISHES

- A. FLOORING
- B. OTHER SURFACES

PORTLAND STATE UNIVERSITY
DESIGN AND CONSTRUCTION STANDARDS

C. PAINT

10. SIGNAGE, SPECIALTIES, AND FURNITURE

- A. EXTERIOR SIGNAGE
- B. INTERIOR SIGNAGE
- C. FLAGS AND BANNERS
- D. RESTROOM ACCESSORIES
- E. MISCELLANEOUS SPECIALTY ITEMS
- F. FURNITURE

11. EQUIPMENT

- A. APPLIANCES

12. SITE FURNISHING

- A. BICYCLE RACKS and SKATE DETERENTS
- B. TRASH and RECYCLING CONTAINERS
- C. FOUNTAINS

14. CONVEYING SYSTEMS

- A. ELEVATOR

21. FIRE SUPPRESSION

- A. FIRE SUPPRESSION SYSTEMS

22. PLUMBING

- A. PLUMBING PIPING SYSTEMS
- B. PLUMBING EQUIPMENT
- C. PLUMBING FIXTURES

23. HEATING, VENTILATING, AND AIR CONDITIONING

- A. MECHANICAL SYSTEMS
- B. HVAC SYSTEMS
- C. MECHANICAL EQUIPMENT
- D. MECHANICAL INSTRUMENTATION AND CONTROLS

26. ELECTRICAL

- A. COMMON WORK RESULTS FOR ELECTRICAL

PORTLAND STATE UNIVERSITY
DESIGN AND CONSTRUCTION STANDARDS

B. LIGHTING

27. COMMUNICATIONS AND AUDIO VISUAL

- A. PHONE AND DATA
- B. AUDIO VISUAL

28. ELECTRONIC SAFETY AND SECURITY

- A. ACCESS CONTROL
- B. SECURITY CAMERAS

32. EXTERIOR IMPROVEMENTS

- A. IRRIGATION
- B. PLANTING
- C. LANDSCAPING MAINTENANCE
- D. PAVING

33. PARKING

- A. EQUIPMENT

APPENDICES

- 01.1. Division 01 (work in development)
- 01.2. Exhibit A: City of Portland CPTED Definition and Policy Strategies
<http://www.portlandonline.com/auditor/index.cfm?c=51503&a=272979>
- 01.3. Environmental Health & Safety
<http://www.pdx.edu/environmental-health-safety/maintenance-construction>
- a. PSU Climate Action Plan
<http://www.pdx.edu/planning-sustainability/climate-action>
- 01.5. Custodial and Storage Closet
- 01.6. Restroom Preferences
- 01.7. Office Standards
<http://www.pdx.edu/planning-sustainability/sites/www.pdx.edu.planning-sustainability/files/Office%20Space%20Standards.pdf>
- 01.8. Classroom Standards (work in development)
<http://www.pdx.edu/planning-sustainability/standards-committee>
- 01.9. Furniture Standards (work in development)
<http://www.pdx.edu/planning-sustainability/standards-committee>
- 08.1. Door Hardware
- 10.1. Interior Signage
- 10.2. PSU Identity Standards
http://www.pdx.edu/sites/www.pdx.edu.ucomm/files/psu_identity_standards.pdf

PORTLAND STATE UNIVERSITY
DESIGN AND CONSTRUCTION STANDARDS

- 26.1 Energy Conservation Guidelines for Portland State
<http://www.pdx.edu/planning-sustainability/energy>
- 27.1. Structured Cabling Standards
- 27.2. AV Standards (work in development)
- 28.1 Access Control
- 32.1 Tree Care Plan (work in development)

END OF TABLE OF CONTENTS

PORTLAND STATE UNIVERSITY
DESIGN AND CONSTRUCTION STANDARDS

SECTION 01 - **GENERAL REQUIREMENTS**

A. SUMMARY REQUIREMENTS

1. STANDARDS OF PERFORMANCE

Capital Projects & Construction (CPC) strives to provide and improve access to all for a quality education, including students, faculty, staff and the general campus community. As such, these standards are to be used as follows:

- a. These standards are intended for use as guidelines for construction, materials, and installations on campus. Product installations and other related work shall match existing materials, unless approved otherwise by PSU Project Manager.
- b. While these standards are approved as department standard, exceptions may be made by PSU Project Manager as necessary.
- c. **Integrated Design Process**
Design Lead (e.g. Architect) to engage interested parties for programming, coordination and review processes. Implement Integrated Design Process from early pre-design stage through the entire design process. Identify opportunities for innovative design through synergies across disciplines and building systems to improve building performance, occupant well-being, and environmental benefits.
- d. **Codes**
These standards are in coordination with, and are subject to all latest applicable rules, regulations, and codes. Refer to section 1.B. Regulatory Requirements.
- e. **General Conditions for Public Improvement Contracts**
Contractor shall conform to the applicable OUS General Conditions for Public Improvement Contracts.
- f. **Submittals**
Prior to ordering, Contractor to submit to PSU-CPC and Design Lead for review and approval all products / equipment / furnishings samples colors, paint colors and shop drawings.
- g. **Dimensions**
All drawing dimensions shall have preference over scaled dimensions.
- h. **Structural Engineer Approvals**
Penetrations of Structure by Contractor: Any Penetration of Structure, including anchoring, coring, scraping, cutting or removal is not permitted unless approved by a Structural Engineer that is licensed in the State of Oregon. Upon the Structural Engineer's determination, work shall be subject to special inspection and/or certified location services and reports to determine location of steel reinforcing. Any existing irregularities, flaws, or wear of structure that is uncovered or discovered by Contractor during the process of the work shall be immediately reported to Structural Engineer and subject to the Structural Engineer's review and recommendations.
- i. **Substitutions**
Submit all product substitutions for review within the invitation to bid time line. Refer to Appendix 01.1 – Division 01.
- j. **Close-out**
Provide PSU-Capital Projects & Construction at Closeout with complete approved permit drawings, including fire sprinklers and alarms. Prior to close out of project, provide PSU-CPC with a "redlined set" of as-built drawings and electronic copies, with (3) Operation and Maintenance Manuals. Refer to Appendix 01.1 – Division 01.

PORTLAND STATE UNIVERSITY
DESIGN AND CONSTRUCTION STANDARDS

- k. Construction Impact Schedule and Coordination
Notify PSU-CPC Project Manager any activities that will create noise, cause utility shut down, or impact parking, waste disposal, access and security a minimum of 2 weeks before the anticipated activity. Refer to Appendix 01.1 – Division 01.
 - l. Parking
All parking is to be arranged and paid for by the Contractor. Refer to Appendix 01.1 – Division 01.
 - m. Keys-Locks
Contractor to order keys for spaces that he or she needs to access. Contractor to provide payment, deposit and processing of PSU key request forms.
 - n. Contractor Etiquette
Refer to Appendix 01.1 – Division 01.
 - o. Design Strategies
Security: Design of new buildings and major renovations shall consider safety and visibility in order to limit the need for security cameras. Consider principles from Crime Prevention Through Environmental Design - Refer to Appendix 01.2 - Exhibit A: City of Portland CPTED Definition and Policy Strategies
2. EXECUTION
- a. Coordination
Contractor to review all documents and coordinate all work with subcontractors including other PSU contractors and consultants and PSU crews involved in the project.
 - b. Existing Conditions
Field-verify all existing conditions including, but not limited to, dimensions prior to fabrication and installation.
 - c. Verify/Protect Existing
Prior to starting field work, contractor to verify and document all existing conditions including compiling digital photographs. Contractor to protect existing building, property, structure and utilities from damage, and replace to existing condition if damaged during construction.
 -  d. Recycling Plan
Complete and submit the Pre-construction recycling plan/applications as required by the City of Portland. For additional requirements refer to Section 01.C.2 of the Technical Design Standards
 - e. Safety During Construction
Provide building safety for tenants and pedestrians to include complete fire, fume, dust, noise control, protection and temporary signage as required during construction. For additional information, please refer to Appendix 01.3 - Environmental Health & Safety.
 - f. Noise/Quiet Hours
Conform to all quiet hours required for tenants by project manager and noise requirements for the City of Portland.
 - g. Installation
All equipment, appliances, furnishings, cabinets, and product items to be installed according to manufacturer's specifications and recommendations for installation, and to meet all codes for a finished workable product assembly which includes ADA, structural, fire, and safety regulations.
 - h. Clean-up
Contractor to provide for complete cleanup of work site at regular intervals. For additional requirements, please refer to Appendix 01.1 – Division 01.

PORTLAND STATE UNIVERSITY
DESIGN AND CONSTRUCTION STANDARDS

- i. Project Completion Quality
All work shall be completed to provide a new, clean, patched, repaired, painted or finished, working and watertight installation per industry standard for Institutional facilities. Include finishing /cleaning of carpet, walls, ceilings, equipment, exposed mechanical/electrical items, fixtures and furnishing, and final treatment of floors.
- j. Final Working Installation
Reconfigure and reconnect existing and new items including utilities, controls, detectors, alarms, exit lighting, strobes, electrical lights, power, switches, mechanical diffusers, ducting, sprinklers, data, plumbing, water, sewer, and venting for a complete working installation.

B. REGULATORY REQUIREMENTS

1. DESCRIPTION

All Design and Construction shall conform to the most recent adopted laws, codes, rules, ordinances, amendments, requirements, as well as Environmental and Waste Management regulations for all pertaining Government jurisdictions, University authorities and documents including but not restricted to the following:

- 2. 2010 Oregon Structural Specialty Code and all updates
- 3. City of Portland Codes and Ordinances
- 4. State of Oregon Codes and Ordinances
- 5. 2010 ADA Standards for Accessible Design
- 6. EPA (Environmental Protection Agency)
- 7. Oregon Department of Environmental Quality
- 8. Oregon University System, and The General Conditions for Public Improvement Contracts
- 9. SHPO State Historical Preservation Office.
- 10. Technical Design Standards, Portland State University
- 11. Portland State University Environmental Health and Safety (EH&S) Standards
- 12. PSU Physical Facilities Space Planning and Inventory Manual – PSU Office of Campus Planning and Design.
- 13. Contract Documents.



C. SUSTAINABLE DESIGN

1. STANDARDS OF PERFORMANCE

Portland State University (PSU) is committed to economic, social, and environmental sustainability. That commitment is acknowledged through our preference for sustainable products including those that are made from rapidly renewable resources, durable, non-toxic, manufactured and sourced locally, harvested sustainably, contain a high percentage of post-consumer recycled content, are comprised of recyclable components, and verified as a sustainable option through industry guidelines or third party organizations such as: Carpet and Rug Institute's Green Label program, Forest Stewardship Council (FSC), Energy Star, or Green Guard.

Portland State University requires all major new construction and renovation projects to achieve LEED Gold minimum certification through U.S. Green Building Council under the

PORTLAND STATE UNIVERSITY
DESIGN AND CONSTRUCTION STANDARDS

most current version of LEED. All other new construction and renovation work shall incorporate LEED and other sustainable design philosophies to the greatest extent possible.

In accordance with PSU's Climate Action Plan (Appendix 01.4), materials with low "embodied emissions", the emissions associated with the extraction, production, transport and use of a given product, are strongly encouraged. Where possible, PSU seeks Environmental Product Declarations for materials which outline life cycle impacts and sustainable attributes.

2. WASTE MANAGEMENT

- a. Recycle construction materials per City of Portland standards and in accordance with a LEED certified waste management plan for major remodel and construction projects. Complete and submit the Pre-construction recycling plan/applications as required by the City of Portland. All landfill and recycling weight tickets and/or hauler invoices should be copied and routed to PSU's Waste Management Coordinator to verify waste management methods and include totals in PSU's diversion rate.
- b. Minimize waste as much as possible by using the four preferred strategies to waste reduction, in this order: source reduction, reuse, recycling, and waste-to-energy.
- c. Provide approved waste and recycling containers for common areas on each floor. Contact and coordinate with PSU's Waste Management Coordinator.
- d. Provide approved compost containers for departmental break rooms and kitchens areas. Contact and coordinate with PSU's Waste Management Coordinator.
- e. Ensure inclusion of approved outdoor infrastructure or containment bay for all waste management activities. Contact and coordinate with PSU's Waste Management Coordinator.

3. SUSTAINABLE PRODUCTS / MATERIAL HANDLING / SUSTAINABLE DESIGN

- a. All new light fixtures/ lamps to be energy efficient and contain low levels of mercury (refer to Electrical Section 26.B.1.c). Life-cycle cost analysis and the use of LED fixtures shall be encouraged.
- b. Lighting installations must meet or exceed Oregon Energy Code.
- c. No urea-formaldehyde resins or adhesives permitted.
- d. To every extent possible, materials and adhesives to avoid the "Red List of Chemicals and Materials" as designated by the International Living Building Institute. <https://ilbi.org/lbc/LBC%20Documents/LBC2-0.pdf>
- e. All fixtures and appliances should be as water efficient as possible, be WaterSense certified, and should assist in achieving Water Efficiency credits in the LEED rating system
- f. Include bottle refill stations in new construction and major renovations and in conjunction with other remodels where feasible. Bottle refill stations may include hydrations stations, retrofitted kits for water fountains, or other solutions that allow users to easily refill water bottles. Install at least one refilling station on each floor of new construction projects and at least one station per building in existing buildings.
- g. All electronics and appliances should be Energy Star rated and EPEAT certified as applicable.
- h. All materials and finishes should contain the highest percentage of recycled content wherever possible, including concrete, carpet, tiles, flooring, paint, etc.
- i. Carpet tiles are to be used wherever carpet is necessary or requested.
- j. Locally and Regionally sourced finishes and materials within 500 miles are encouraged.

PORTLAND STATE UNIVERSITY
DESIGN AND CONSTRUCTION STANDARDS

- k. Coordinate all work including discovery, demolition, removal, or storage of hazardous or environmentally sensitive materials with PSU Environmental Health and Safety Dept.
- l. Use materials from salvaged sources, where feasible and appropriate.
- m. Use finishes such as flooring or millwork materials from rapidly renewable sources whenever possible.
- n. Use certified wood, wood finishes, or wood products that are considered to have environmental qualities that meet or exceed those of FSC certification whenever possible.
- o. Select paints, coatings, sealant, adhesives, composite wood, carpet and agrifiber products that have low or zero VOC content.
- p. Use a natural linoleum over vinyl composite tile or other sustainable flooring options (recycled rubber flooring, etc.) whenever possible.
- q. In cases of renovation, consider salvage and reuse of existing hardware and structures wherever possible. Work with community partners to salvage architectural materials that are usable but not able to be reused on site.
- r. Consider maintaining-in-place existing products in lieu of replacing with new if in good condition.
- s. Choose high-speed energy efficient hand dryers over paper towel dispensers in all restroom facilities.
- t. Design for daylight harvesting in as much of the building footprint as possible.
- u. Preserve and/or integrate green space and tree canopy wherever possible. Refer to City of Portland Parks and Recreation's Urban Forestry Division's list of recommended species and The Campus Tree Care Plan (Appendix 32.1).
- v. Develop and implement a tree protection plan during construction phase.
- w. Implement storm water controls during the construction phase and include storm water management infrastructure in design of campus spaces.
- x. Choose drought tolerant and regionally appropriate landscaping that is suited for existing climate and future climate changes. Choose landscaping that is biologically diverse and provides habitat for natural pollinators.
- y. Incorporate metering and sub-metering standards set by PSU.
- z. Where applicable, the use of permeable pavers is encouraged.
- aa. In new construction, the incorporation of visible, usable, accessible to occupants, and maintainable green roofs must be pursued and implemented when operationally and financially feasible. In major renovations, this design strategy should also be considered. Green roofs shall meet ecosystem services such as habitat promotion, filtration capabilities, limited irrigation requirements.

D. EXISTING CONDITIONS AND ENVIRONMENTAL ASSESSMENTS



1. TOPOGRAPHICAL SURVEYS

- a. Match all new work to existing survey maps to provide topographic continuity.
- b. Represent all 1-foot ground surfaces on the drawings by means of contours and spot elevations. Show spot elevations at all tie-in locations.
- c. Note all ground floor elevations of existing buildings and slab structures on the drawings to the nearest hundredth of a foot.

PORTLAND STATE UNIVERSITY
DESIGN AND CONSTRUCTION STANDARDS

- d. Verify and show all storm and sanitary sewer inlet and outlet invert elevations at manholes by field measurement as well as grated elevations. Show underground storm, water and sanitary pipes.
- e. Identify all buildings shown wholly or partially on the finished drawings by name and accented by shading or crosshatching. In tabular form show all major building corner coordinates.
- f. Field-locate, record the location, and identify on map, all surface improvements and natural conditions.
- g. Field-locate all trees and major vegetation and record location on the map. Identify tree size and type on the map. (Protect existing shrubs, trees and lawn areas during the progress of fieldwork; under no circumstances will their removal be permitted.)
- h. Locate all tunnels and manholes, and show floor elevation of tunnels and tunnel coordinates.
- i. Include a general vicinity map, small scale, on the finished drawings. The University will furnish appropriate background.
- j. Provide to the University an electronic copy of each file in Autocad as well as one physical copy of the drawing. Provide typed labels completely identifying the contents of each disc.

2. DEMOLITION

-  a. Where feasible, coordinate and practice “deconstruction” instead of demolition. Deconstruction refers to the dismantling a building where reuse, recycling, and salvage are maximized instead of clearing a site by the most expedient means.
- b. Remove existing walls, doors, frames, finishes, electrical, mechanical, and other building items as required to accommodate new construction.
- c. Remove all abandoned mechanical, electrical, and plumbing lines.
- d. Verify and protect all existing structure. Protect existing lobby areas, restrooms, and elevators. Protect gardens and soils
- e. Generally, the abandonment of existing equipment and material in place is not acceptable. Abandoned systems become a liability since it becomes difficult to determine what is active and what is not. The correction of existing civil problems and removal of abandoned civil equipment, while maintaining the operation of the building, all need to be addressed in the contract documents. Disposal of materials can be a problem with limited on-site areas for temporary storage.
-  f. Salvaged materials – Identify items which may be reusable by PSU with PSU’s project manager and arrange to have them moved to a location to be identified by PSU’s project manager.
-  g. At the beginning of any remodeling work, cover all return air grilles with filtering material to prevent accumulation of dust in existing duct system.

 **3. AIR ASSESSMENT**

- a. Installation of equipment that produces air emissions, such as paint spray booths and bag filters, may require a "Notice of Intent to Construct" from Oregon Department of Environmental Quality. For further information, contact PSU Environmental Health & Safety (EH&S) at 503.725.3738.
- b. Take precautions to prevent visible dust emissions; water trucks and street sweepers, for example, may be required. For further information, contact PSU EH&S at 503.725.3738.

PORTLAND STATE UNIVERSITY
DESIGN AND CONSTRUCTION STANDARDS

- c. Prevent odor emissions that could result in complaints and compromise indoor air quality. When odor is unavoidable, communicate in advance the cause and timeline to those potentially affected.

4. ASBESTOS AND LEAD – ASSESSMENT AND REMEDIATION

Refer to provisions in the Environmental Health and Safety Specifications and Documents (Appendix 01.3).



5. MOLD ASSESSMENT, REMEDIATION AND RESTORATION

a. Assessment - Discovery and Analysis:

- i. Upon discovery or question of possible mold material, notify the Project Manager and EH&S immediately. Areas of the suspect material shall be posted, isolated, and avoided. Safety and containment procedures shall be initiated.
- ii. EH&S will initiate preliminary observation and testing as required to determine nature of the material.
- iii. In coordination with the Project Manager, EH&S will contact an approved and certified testing lab to observe, test, and provide a prompt analysis report of sample materials from site.
- iv. Results of Lab report with analysis and recommendations will be reviewed by PSU. EH&S will provide recommendations to the Project Manager, including safety precautions for all project personnel, visitors, and surrounding public.
- v. A separate consultant and report may be required to determine the cause of the mold for purposes of incorporating into final restoration.

b. Remediation and Restoration

Process of Notification, Removal, Treatment, Cleaning and Build-back.

- i. Upon instructions to provide remediation by EH&S, the Project Manager shall notify the Contractor appropriately with regards to possible changes to the Contract due to mold remediation requirements.
- ii. The Project Manager may elect to retain a remediation contractor outside the project Contract or retain the project Contractor to provide services including remediation specifications, demolition work, remediation work, build-back restoration work, and coordination with existing and on-going project contract work and timeline.
- iii. Required safety and containment precautions shall be initiated, including personal protective equipment.
- iv. Contractor shall isolate remediation area from remainder of project and remove mold material.
- v. Air handling, drying, and monitoring shall be scheduled and contained.
- vi. Areas of remediation shall be cleaned and treated with EH&S approved materials and methods.
- vii. The Testing Lab shall review the remediation areas in a timely manner and provide analysis to determine schedule of build-back restoration. Recommendations shall be given to PSU and EH&S and issued to the Project Manager to safely start the Contractor's build back restoration of the remediated areas.
- viii. Required time-lines for wearing personal protective equipment shall be clearly delineated to the Project Manager and the Contractor by EH&S.
- ix. Build- back restoration of remediation area shall include correction of cause of mold.



6. WATER REMEDIATION

PORTLAND STATE UNIVERSITY
DESIGN AND CONSTRUCTION STANDARDS

Construction projects sometimes generate wastewater, which must be disposed of properly and in consultation with EH&S. Two common activities that generate wastewater are Masonry Cleaning and Potable Water Flushing. For more information about wastewater disposal, call EH&S at 503.725.3738.

a. Masonry Cleaning

- i. Only wastewater from water-only washing of surfaces that do not contaminate the wash water may be discharged to storm drains. Contact EH&S for more information before planning to discharge to a storm drain.
- ii. Do not allow wastewater or rinse water to soak into the landscaping unless prior arrangements have been made with PSU's grounds maintenance staff. Some landscaped areas are under a strict watering schedule to minimize plant diseases.
- iii. When using cleaning products or washing contaminated surfaces, waste water must be collected for discharge to sanitary sewer. At the job site, berms must be set up to prevent wash water from reaching storm drains. Sweep the area to minimize the rinsing of dirt and other solids into the storm sewer.
- iv. Wastewater may have to be collected and treated to meet the pH limit of 5.5-12. Agricultural lime has limited effectiveness as a neutralizer. Test the pH of the waste water after treatment and adjust treatment or disposal methods accordingly.
- v. Lead, asbestos and other hazardous materials cause the wash water to violate sewer discharge limits. If hazardous materials could be in the wash water, samples must be collected and analyzed for the concentrations of those materials. If the water violates local sewer discharge limits, it must be disposed of as hazardous waste.
- vi. Avoid the use of strong cleaners and solvents, which can cause the waste water to be hazardous waste even after use and dilution with rinse water.

b. Potable Water Flushing

Potable water may be discharged to the storm drainage system. However, because potable water contains residual chlorine, select a storm drain at least 100 feet away from the point of use to allow chlorine to dissipate into the air before the water enters the storm drain.



7. REMOVAL AND DISPOSAL OF CONTAMINATED SOILS

- a. Many locations on University property have the potential for soil and/or ground water contamination. Sources of contamination include industrial activities such as fuel storage or dispensing or hazardous material spills prior to University acquisition of the property. It is not uncommon to find soil and groundwater contamination where fuel stations, fuel storage tanks, heating oil tanks, emergency generator tanks, industrial activities and landfills are located. EH&S will assist with the compliance of Federal and State requirements.
- b. Contact EH&S immediately at 503.725.3738 if environmental contamination is discovered or disturbed.
- c. Develop a Work Plan during the design phase to address site contamination issues. Allow enough time for EH&S and regulatory agencies to review the work plan.
- d. Disposal of Contaminated Soil and Water
 - i. Pre-plan for site contamination: Contact EH&S at 503.725.3738 to discuss environmental assessments and historical information about the site.
 - ii. Hire an environmental consultant familiar with site assessment and cleanup issues. Pre-characterize soils and water for cost estimates; collect enough samples to adequately define the extent of the contamination. Address costs to sample, analyze,

PORTLAND STATE UNIVERSITY
DESIGN AND CONSTRUCTION STANDARDS

manage and dispose of contaminated soil, groundwater and storm water in the contract documents. Additional costs may include worker protection and environmental consulting.

- iii. All excavated materials must be contained or stockpiled on Visqueen and covered with Visqueen. Representative samples must be taken for waste designation and disposal at PSU authorized disposal sites. Analytical test results must be transmitted to EH&S for waste determinations prior to disposal. If any of the wastes designate as hazardous waste, EH&S will manage the containment, transport and disposal of that waste through the state hazardous waste contract. Petroleum-contaminated soils are not Hazardous Waste but must be disposed at solid waste handling facilities. Solid Waste Handling Facilities classify and manage petroleum-contaminated soils by the concentration of gas, diesel, or heavy oil-hydrocarbons present in the waste. Petroleum contaminated soils above certain hydrocarbon concentrations must be thermally-treated.
- iv. Contain water that has been in contact with contaminated soils in Baker tanks. Contact EH&S for assistance with the proper treatment and disposal of potentially contaminated water. EH&S will assist with obtaining sanitary sewer discharge permits if appropriate.
- e. Cleanup Requirements
EH&S will assist project managers in determining the extent of cleanup requirements, based on pre- and post-assessment data. Cleanup requirements vary from site to site and depend on the extent and location of the contamination. In some cases, removal and offsite disposal of contaminated soils is necessary, while in other cases, the installation of groundwater treatment systems may be required. In some instances, there is no choice but to leave environmental contamination behind. When environmental contamination remains at a site, the University implements institutional controls to protect human health and the environment
- f. Institutional Controls
Contact EH&S for guidance on protecting institutional controls that may already be in place at a known contaminated site. Institutional controls limit or prohibit activities that may result in human exposure to contamination. They may include protective asphalt or a concrete cap over a contaminated site, a restrictive deed or covenant on the property, a vapor barrier, a vapor collection system, groundwater monitoring wells, or a groundwater treatment system.
- g. List of Contaminated Sites
Provide a list that addresses type of contamination and location



8. HANDLING OF LIGHTING BALLASTS AND LAMPS CONTAINING POLYCHLORINATED BIPHENYL AND MERCURY; HANDLING OF HAZARDOUS WASTE DRUM



Refer to provisions in the Environmental Health and Safety (EH&S) Specifications and Documents.

E. FACILITY SHELL PERFORMANCE REQUIREMENTS

1. DESCRIPTION

Portland State University has a wide variety of buildings of differing architectural styles, age and material construction. Because of this PSU does not have a single material specified for exterior treatment. When selecting materials for the exterior of all new projects the design team must, however, consider the following when selecting these materials:

PORTLAND STATE UNIVERSITY
DESIGN AND CONSTRUCTION STANDARDS

- a. Materials must be durable and must be able to withstand weather and pollution with minimal maintenance. Cleaning of the surfaces once every decade with power washing is the norm. Acceptable materials include brick, concrete, and some metals.
- b. Materials must be aesthetically compatible with adjacent buildings.
- c. Metal elements such as trim, exposed structural elements, door and window frames must be designed so as not to need refinishing for at least 50 years. Such metals may include aluminum, copper, and galvanized metals.
-  d. Materials requiring significant and constant upkeep must be avoided and are to be approved by the PSU Project Manager prior to specifying. These include items such as wood, painted metals, EIFS, and plastics.
- e. Locally sourced materials will be given preference over materials manufactured at locations distant from the PSU campus.
-  f. Materials with low embodied emissions are preferred. Where possible, PSU seeks Environmental Product Declarations for materials.
- g. All designs must make use of good architectural practices for shedding water and protecting against weather. Flashings and other design features must be the primary source of weather protection. Sealants, while important elements in good design, must not be used as the primary source of weather and water protection.
- h. All flat roof areas shall be designed to provide parapet and handrail for safety.
- i. For all new buildings and major renovation, layout shall consider secured interior bike storage area. Providing secure storage within one block of project may be considered - verify and coordinate with PSU campus' shared bike shelters plan.
- j. In new buildings that include secured interior storage area, shower facilities shall also be considered.

F. CUSTODIAL REQUIREMENTS

1. STANDARDS OF PERFORMANCE

Portland State University aims to provide its facilities users with a clean, safe and healthy environment. As such, all building design, space design, and construction shall consider the following:

a. Design Strategies

Consider design strategies that minimize building cleaning and maintenance.

- i. When possible and on a case-by-case basis, consider segregating office areas from classroom areas. Ideally, from a cleaning and security standpoint, offices should be designated to upper floors and classroom to lower floors. This allows custodial services to securely clean offices during off hours and restrict general public access.
- ii. Avoid open grid ceilings where mechanical ducts, pipes and structural members can collect dust.
- iii. If designing multi-story curtain walls, design a means for periodic structure and window maintenance and cleaning. Avoid high curtain walls where dust can collect on top of horizontal mullions and access for cleaning is restricted, or else coordinate and assure that the facility has budgeted for specialized cleaning services.
- iv. Doorless entries to restrooms are encouraged. This type of access is less prone to vandalism and other criminal activity. If restroom is located near quiet areas, discuss this strategy with PSU Project Manager and building committee.

PORTLAND STATE UNIVERSITY
DESIGN AND CONSTRUCTION STANDARDS

- v. In restrooms, design hand wash area to avoid accumulation of water on floor and sink counter.
 - vi. Avoid locating bulletin boards behind trash and recycling containers. Residues from trash and recycling materials may stain bulletin boards.
 - vii. Provide custodial closets according to design guidelines in Custodial and Storage Closets standards (Appendix 01.5). Provide electrical outlets, constant forced ventilation, and chemical dispensers.
 - viii. New buildings and major renovations are required to incorporate a waste collection facility for the building. Design space to fit trash and recycling compactors. Provide a waste collection corral for recyclable and compostable materials. Contact and coordinate with PSU's Waste Management Coordinator.
- b. Materials, products and surfaces selection
- Minimize cleaning by selecting materials, products and surface finishes that are easy to maintain. In addition, vandalism is a concern at PSU. Select materials, products and surface finishes that are resistant to damage.
- i. Minimize finishes (e.g. ceramic tile) that require joints in areas where sanitation is a high concern (e.g. restrooms). Joints (e.g. grout) can stain and grow bacteria. Continuous surfaces are preferred.
 - ii. Select surfaces that do not stain, especially in wet areas. Avoid dark colors on surface finishes. Prefer neutral colors.
 - iii. Prefer flooring products that are seamless and stain resistant. Prefer dark colors.
 -  iv. PSU uses "green" surface cleaners with no solvents. When selecting materials, products and surface finishes, consider ones that are easily cleanable with these types of cleaners.
 - v. For restroom fixtures, stalls, specialties and special preferences, refer to Appendix 01.6 - Restroom Preferences and coordinate with PSU Project Manager.

END OF SECTION

PORTLAND STATE UNIVERSITY
DESIGN AND CONSTRUCTION STANDARDS

SECTION 03 - **CONCRETE**

A. CONCRETE

1. GENERAL

-  a. The manufacturing process of concrete creates up to 5% of worldwide CO₂ emissions and needs to be considered when planning for the use of concrete in building design. For this reason and others, the use of recycled concrete aggregate at the highest percent possible is encouraged where appropriate and structurally allowed.

2. DOCUMENTATION

- a. Due to concrete's use as a structural component, all calculations used in the development of structural drawings shall be submitted to PSU and archived with project submittals.
- b. As-built documents, including photographs, will show accurate actual locations of embedded utilities, mechanical, electrical and plumbing chases, and other components concealed from view in finished construction
- c. As-built documents will accurately reflect the location of footings and all subsurface concrete.

3. PRODUCTS

- a. ASTM C150, Type II concrete shall be used in all subsurface and exterior applications.
- b. Unless otherwise specified in structural calculations and structural drawings, the 28 day compressive strength of exterior concrete shall be a minimum 4000 psi for sidewalks and other flatwork. Verify City of Portland requirements for public sidewalks.
-  c. All sealers and coatings for concrete slabs shall be water based low VOC LEED/Green Building Certified and compatible with future treatments.
- d. Edges of low concrete such as planter boxes and benches shall have skate-board deterrents either integral to the form of concrete or metal deterrents installed on the edge surface.

4. EXECUTION

- a. All Steel columns shall be supported on a level grout filled base and not directly supported on concrete slabs or footings
- b. Mechanical areas and areas susceptible to flooding shall have floor drains installed.
- c. Housekeeping pads shall have shrinkage and temperature steel reinforcement conforming to ACI 318 Section 7.12.2.1 at a minimum and be appropriately anchored to the underlying slab with steel doweling.
- d. The use of wire mesh is discouraged in sidewalks and other exterior flat work. Preference is for well compacted ¾" - 0" gravel base and the appropriate use of crack control scoring or saw-cuts.
- e. Exposed concrete in dust-sensitive areas such as labs shall be sealed.

END OF SECTION

PORTLAND STATE UNIVERSITY
DESIGN AND CONSTRUCTION STANDARDS

SECTION 04 – **MASONRY**

A. MASONRY

1. DESCRIPTION

- a. The structural engineer is required to design all structural masonry. Fabricator or contractor designed details are not allowed without approval of the structural engineer of record.
- b. The structural engineer is required to design all the structural masonry anchors.
- c. Detail non-bearing walls to allow for vertical deflection of members above. Provide positive connection at top of wall at 4'-0" on center maximum spacing.
- d. Detail non-bearing/shear walls to allow for seismic inter-story drift at both top and each end of walls where adjacent to structural members.
- e. Extend vertical reinforcing up to top of parapet walls. Provide horizontal reinforcing at the top of the wall.
- f. Provide vertical and horizontal reinforcing in CMU walls.
- g. Provide control joints in CMU walls and expansion and contraction joints in brick walls where masonry abuts other surface materials. Joints shall be sealed to prevent penetration of water or moisture in the interior of the wall cavity.
- h. Provide weep holes at all exterior walls or masonry cladding near the wall base every 3'-0".
- i. All masonry shall be above grade.
- j. Masonry units shall be obtained from a single source and/or manufacturer in order to guarantee uniform texture and color or uniform blend.
- k. Use of stack bond is discouraged. If used for architectural reasons, provide a minimum of one vertical reinforcing bar in each stack of block, and horizontal reinforcement throughout.
- l. Provide stainless steel thru-flashing at wall caps, window heads, ledger angles, base bearing, etc.
- m. Provide efflorescence tests with brick submittals for approval. Contractor shall be responsible for removal of all efflorescence that appears on surfaces within 3 years of project completion.

2. PRODUCTS

- a. Masonry
 - i. Submit samples of surface finish textures and color to be approved by PSU Project Manager.
 - ii. In remodel and addition projects, masonry color shall match existing.
- b. Grout and mortar
 - i. Submit samples and colors for approval by PSU Project Manager.
 - ii. In remodels and additions, color shall match existing.
 - iii. No calcium chloride allowed.

PORTLAND STATE UNIVERSITY
DESIGN AND CONSTRUCTION STANDARDS

- c. Reinforcing Steel
Consider specifying reinforcing steel with a high recycled content
 - d. Sealer
Provide sealer on all exterior masonry.
 - e. Weather Repellent
Provide water repellent coating on all exterior masonry.
 - f. Anti- graffiti coating
Provide anti-graffiti coating on all exterior masonry.
3. INSTALLATION
- a. Prior to installation, provide a 48" x 48" vertical mock-up to verify selection made on submittals, design and execution of wall panel.
 - b. Storage of masonry units shall be such to avoid staining and damage of surface. Provide storage in a dry location. If units are not stored in an enclosed location, cover top and sides of stacks with waterproof sheeting, securely tied. The contractor shall be responsible for any damages that occur to the product.

END OF SECTION

PORTLAND STATE UNIVERSITY
DESIGN AND CONSTRUCTION STANDARDS

SECTION 05 – **METALS**

A. STRUCTURAL METALS

1. GENERAL

- a. A structural engineer is required for the design of all structural steel framing for remodels and new construction and for all metals and fasteners used in the seismic bracing of equipment.
- b. Fabricator/contractor designed details are not allowed unless approved and stamped by an engineer or structural engineer of record on larger projects.
- c. The use of deformed steel reinforcing bars is preferred over the use of welded wire mesh in exterior concrete flatwork if steel is used at all in this application. (See Concrete Standard)
- d. All structural or ornamental exterior steel exposed to weather shall be hot dipped galvanized or stainless steel.
-  e. Consider specifying structural steel with a high recycled content.
- f. Structural steel shall be delivered to any construction site with a factory applied coat of primer and be protected from weather until installation.
- g. Metal covered walkways shall not be used.

2. INSTALLATION

- a. All Steel columns shall be supported on a level base of non-shrinking, non-metallic grout and not directly supported on concrete slabs or footings
- b. Housekeeping pads shall have shrinkage and temperature steel reinforcement conforming to ACI 318 Section 7.12.2.1 at a minimum and be appropriately anchored to the underlying slab with steel doweling.

B. ARCHITECTURAL METALS

1. GENERAL

- a. Contractor shall conform with and provide the following:
 - i. Conformance to all current standards including ASTM, AAMA, AWA, and SSPC.
 - ii. Conformance to paint or coating manufacturer's recommendations and specifications for all finish products including priming, galvanizing, painting, and coatings. All materials to be factory-primed by manufacturer, unless specified otherwise.
 - iii. Submittal of LEED documentation for recycled content, distance, and VOC coating content.
- b. Structural Engineer to review all shop drawings and welding certificates

1. PRODUCTS

Architectural metals include exposed steel, aluminum, or other metal for shapes or manufactured units or products including screens, mesh, grille-work, ship ladders, railings, platforms, catwalks, and connectors.

END OF SECTION

PORTLAND STATE UNIVERSITY
DESIGN AND CONSTRUCTION STANDARDS

SECTION 06 - **GENERAL CARPENTRY**

A. ARCHITECTURAL WOOD CASEWORK

1. DESCRIPTION

-  Prefer Institutional quality to meet American Woodworkers Institute specifications and standards for AWI custom grade or better, all plywood construction. Encourage use of certified wood, wood finishes, or wood products that are considered to have environmental qualities that meet or exceed those of FSC certification whenever possible.

B. FINISH CARPENTRY

1. DESCRIPTION

Similar to Architectural Wood Casework.

C. METAL STUD WALLS & PARTITIONS

1. DESCRIPTION

- a. Prefer min. 20 gauge x 3- 1/2" wide metal studs at 16" on with 5/8" Type X gypsum board on each side.
- b. It is standard PSU practice to acoustically insulate all new walls and partitions with a minimum of R-15 batt insulation or acoustic batt. Verify acoustical insulation requirements according to room use (e.g. offices, classrooms, bedrooms) and consult with project architect or engineer for additional sound attenuation measures. Follow guidelines in ANSI S12.60-2002, "Acoustical Performance Criteria, Design Requirements and Guidelines for Schools" and LEED.
-  c. Incorporate a niche in walls for campus standard trash and recycling containers. Dimensions shall consider flexibility to accommodate current use and additional future load, as well as usage patterns according to building functions. Provide one niche per 200 lineal feet of corridor. Contact and coordinate with PSU's Waste Management Coordinator and PSU Project Manager.
- d. The use of modular wall systems such as DIRTT is allowed and must be discussed with PSU Project Manager before specification.

2. LOCATION

Standard Common Walls.

END OF SECTION

PORTLAND STATE UNIVERSITY
DESIGN AND CONSTRUCTION STANDARDS

SECTION 07 – THERMAL AND MOISTURE PROTECTION

A. ROOFING

1. DESCRIPTION

- a. Adhere to standards and details of latest editions of National Roofing Contractors Association (NRCA) handbook and the Sheet Metal & Air Conditioning Contractors Association (SMACNA) manual.
- b. Provide a minimum ¼” per foot slope to drain.
- c. Provide overflow scuppers and overflow drains per code requirements.
- d. Fall protection systems for working on mechanical, electrical and other rooftop items. All fall protection devices to be engineered by Oregon licensed structural engineer and must meet all code and OSHA requirements.
- e. PSU requires that the roof perimeter of all new construction projects have railings or parapets that are at least 42” high at their lowest point.
- f. All Skylights shall meet the OSHA requirements for fall protection.
- g. Prior to any construction the contractor is to provide complete Material Safety and Data Sheets for all roofing components.
- h. The Contractor shall provide an Installer’s Warranty of at least 5 years and a Manufacturer’s Warranty of 20 years. On a project by project basis, CPC Director, FPM Assistant Director of Operations and Maintenance, and Executive Director for Planning, Construction, and Real Estate will meet to determine any additional extended warranty requirements for roofing duration, building life, and major mechanical equipment (e.g. chillers and cooling towers).
- i. When designing a roof consider that PSU staff, faculty and students may be allowed access to the roof for the performance of maintenance and/or experiments. Work closely with PSU staff to design the roof to accommodate anticipated traffic and use.
- j. PSU has limited resources to maintain its roofs. Select roofing material that is durable, has built-in redundancy, and requires minimal maintenance. 5-ply built-up roofing and 2 ply - SBS Modified Bituminous Membrane Roofing are good examples of durable roofing systems. Single ply roofing membranes will be considered on a project by project basis.
- k. For roofs with flat substructure provide tapered insulation to slope for drains. Minimum ¼” per 1’-0” slope

2. INSTALLATION

- a. All roofing and repair work to be done by Manufacturer approved roofing contractor.
- b. All existing material and labor warranties must be maintained when doing repair or modifications to existing roofing installations.

B. TRAFFIC COATINGS

1. PRODUCT

- a. Iso-Flex coating system is preferred with integral silica sand.
- b. Provide 5-year warranty.

PORTLAND STATE UNIVERSITY
DESIGN AND CONSTRUCTION STANDARDS

2. INSTALLATION

- a. Applicator must be certified to install coating system selected.

END OF SECTION

PORTLAND STATE UNIVERSITY
DESIGN AND CONSTRUCTION STANDARDS

SECTION 08 - **OPENINGS**

A. DOORS, RELITES & FRAMES

1. DESCRIPTION

- a. Metal doors shall be a minimum 1 3/4" thick, insulated, pre-painted, 16 gauge metal.
- b. Wood doors shall be a minimum 1 3/4" thick solid core with wood veneer to match adjacent.
- c. All door frames and relite frames shall be 16 gauge, pre-painted, welded steel frames. All weld joints shall be ground smooth.
- d. Exterior door frames shall be galvanized.
- e. Interior door frames shall be reinforced with a basecoat plaster such as Structo-lite for additional strength and durability. Interior door frames such as Knock down door frames are to be avoided and used only upon the approval of the PSU Project Manager.
- f. Fire rated doors and frames shall have appropriate labeling when delivered to the job site.
- g. All rooms with windows, including offices, located along the perimeter of a building shall have doors, relites, and other treatments that allow the penetration of natural light into inner spaces (e.g. corridors and inner rooms).
- h. The design of door lites and relites shall follow specifications in PSU Office Standards (Appendix 01.7) and PSU Classroom Standards (Appendix 01.8).
- i. Door lites and relites shall have a minimum 1/4" thick tempered glass.
- j. Door lites and relites coverings (e.g. blinds) shall be specified according to PSU Office Standards (Appendix 01.7) and PSU Classroom Standards (Appendix 01.8).
- k. Prefer wood stops at exposed wood unrated doors.

2. INSTALLATION

Provide blocking at door interior for closers and panic hardware locations.

B. DOOR HARDWARE

1. DESCRIPTION

- a. Refer to the PSU Facilities Locksmith specifications as described in Appendix 08.1 – Door Hardware.
- b. In new and major renovations, door frames shall easily accommodate current or future addition of access control and/or ADA opener.
- c. In renovation projects, a full inventory of the retrofitted floor must be made to determine if hardware upgrades to improve accessibility are required.
- d. Locking hardware must be mounted at a height that meets ADA requirements. For example, hardware at floor level is prohibited.





END OF SECTION

PORTLAND STATE UNIVERSITY
DESIGN AND CONSTRUCTION STANDARDS

SECTION 09 – **FINISHES**

STANDARDS OF PERFORMANCE

PSU has several key goals when approving and specifying flooring materials. These goals are:

- a. Finish products must be easy to maintain & clean. No special cleaning or proprietary maintenance products must be required. It is preferred that installed materials not need to be waxed or sealed or otherwise treated to maintain a clean look.
- b. Durability is of prime importance. All finish products must be appropriate to the use of the space.
-  c. All materials and finishes should contain the greatest percentage of post-consumer recycled content as possible, including concrete, carpet, tiles, flooring, paint, etc. Use finishes such as flooring or millwork materials from rapidly renewable sources whenever possible. In addition, specified finish products (e.g. flooring) should be recyclable at the end of their life.
-  d. Where possible, locally manufactured products should be used.
-  e. Paints, coatings, sealant, adhesives, composite wood, carpet and agrifiber products must have low or zero VOC content.
- f. PSU will consider the installation of new products on the market if they meet the above criteria. If new products on the market are proposed, the benefits of using these products must be fully documented and may be installed only if approved by PSU Project Manager.
-  g. To every extent possible, materials and adhesives to avoid the “Red List of Chemicals and Materials” as designated by the International Living Building Institute.
<https://ilbi.org/lbc/LBC%20Documents/LBC2-0.pdf>

A. FLOORING

 1. DESCRIPTION

- a. Flooring products must be easy to repair or replace. Modular tile products are preferred where possible.
- b. Integral walk-off carpet mats are preferred at main building entries from exterior.



2. PRODUCTS

a. Carpet

- i. Carpet is to be kept to an absolute minimum.
-  ii. Carpet and adhesives should be certified by the Carpet and Rug Institute's Green Label program.
- iii. Carpet should never be used in the following locations:
 - o Laboratories
 - o Cafeterias and break rooms.
 - o Restrooms and kitchens
- iv. Carpet may be used upon approval of PSU Project Manager and Director of CPC prior to installation or specification in locations such as:
 - o Corridors and hallways
 - o Elevators, entryways or vestibules
 - o Classrooms
 - o Administrative offices
 - o Conference rooms

PORTLAND STATE UNIVERSITY
DESIGN AND CONSTRUCTION STANDARDS

- o Special event spaces
 - o Spaces requiring special sound deadening characteristics
 - o Areas where food and drink are served or allowed
 - v. In all locations where carpet is approved the carpet must be modular tiles.
 -  b. Vinyl and other tile products
 - i. Natural linoleum, cork and other sustainable flexible tile products (e.g. recycled rubber) are preferred in the following locations:
 - o Corridors and hallways
 - o Areas where food and drink are served or allowed
 - o Elevators, entryways or vestibules
 - o Dry lab locations
 - o Classrooms
 - ii. Avoid vinyl composite products
 - c. Epoxy products

Prefer epoxy flooring, cove bases and wall systems in restrooms. Manufacturers include Stonhard or approved equal.
 - d. Sheet products
 -  i. Natural Linoleum and other sustainable sheet products are preferred in the following locations:
 - o Areas where food and drink are served or allowed
 - o Elevators, entryways or vestibules
 - o Wet lab locations
 - o Kitchens and kitchenettes
 - ii. Do not use linoleum in restrooms, unless approved by PSU project manager
 -  iii. Avoid vinyl composite products
- B. Rubber products
 -  Rubber flooring is acceptable throughout facilities with exception of restrooms. Prefer rubber product with recycled content. Prefer dark color. Manufacturers include Nora Flooring or as approved by PSU Project Manager.
- C. Tiles and other refractory materials
 - i. Tiles and other refractory materials are preferred the following locations
 - o Kitchens
 - o Entryways and vestibules
 - ii. Do not use ceramic and clay tiles in restrooms, unless approved by PSU Project Manager.
- D. Stone and terrazzo flooring
 - i. Stone and terrazzo flooring may be used only if approved by PSU Project Manager.
- E. Wood
 - i. Wood should only be used in areas where wood is required by specific needs such as:
 - o Sports, dance or other recreational spaces
 - o Where matching adjacent spaces such as residential units

PORTLAND STATE UNIVERSITY
DESIGN AND CONSTRUCTION STANDARDS

ii. Wood flooring is to be used only when specifically approved by the PSU Project Manager.

 iii. In all locations where wood is used, FSC certified wood shall be specified, unless approved by PSU project manager.

F. Concrete

i. Concrete flooring (regular or colored) are acceptable in high traffic areas (e.g. hallways).

ii. Concrete flooring shall be avoided in wet areas since they absorb stains.

iii. Where concrete flooring is used, provide anti-stain coating and epoxy seams.

 iv. The use of recycled concrete aggregate is encouraged.

v. If concrete flooring is used, it needs to be burnished or polished

G. Base

i. 4" rubber base is preferred in all locations except as noted below. Vinyl base is not permitted.

ii. 6" rubber base is allowed in locations where existing base has been removed and 6" base is required to cover wall damage.

iii. 6" rubber base is to be used in kitchen, restroom and other wet areas or areas that receive frequent wet mopping.

iv. Ceramic base is to be used in conjunction with ceramic tile flooring installations.

v. Wood base is to be used only when matching existing wood base or upon approval of the project manager.

vi. When sheet products are used it is preferred that the base be formed by turning up the flooring product onto the wall surface.

vii. When flooring products such as Stonhard or epoxy coatings are used, flooring and wall base must be continuous.

H. Exceptions

Exceptions to the above flooring installations must be approved by the PSU Project Manager. Some examples of possible exceptions are:

i. When matching an existing installation.

ii. Special uses such as areas requiring non-static flooring, clean labs, machine rooms, etc.

iii. Unavailability of alternate product options

B. OTHER SURFACES

1. PRODUCTS

a. Solid Surfaces

The use of solid surfaces, including composite, concrete, and stone for counters is encouraged.

b. Plastic Laminate

 Plastic laminate is acceptable for countertop applications. FSC and Greengard certification preferred.

PORTLAND STATE UNIVERSITY
DESIGN AND CONSTRUCTION STANDARDS

- c. Stainless Steel
If using stainless steel surfaces, specify satin or brushed finish. High polished finishes can stain and require increased cleaning.
- d. Wood
Wood finish doors tend to get dirty around handles and locks areas. When wood finish doors are specified, specify protective coating to facilitate cleaning.

C. PAINT

1. DESCRIPTION

-  a. All paint must be low or no VOC products. VOC level to be 50 grams/lit or less.
- b. Interior paint to be satin, eggshell or semi-gloss finish in high traffic common areas such as restrooms and hallways.
- c. Satin finish for offices or low traffic areas as requested. Exterior paint to be Satin finish.
- d. Gloss may be used as approved by PSU Project Manager.
- e. First Coat or Zinser 123 primer for new gypsum wallboard (sealer).
- f. Label surplus paint: Contractor must clearly label all surplus paint containers with, at the minimum, the location where the paint was used, brand name, color, type and formula.
- g. Provide washable paint in classrooms near areas that have a possibility of getting dirty with dry markers.
- h. The use of intumescent paint shall be avoided.

2. PRODUCTS / LOCATION

- a. Manufacturer: Miller Paint or approved by PSU Project Manager
- b. The following paint colors are approved PSU colors. Wall and ceiling colors must be limited to these, unless approved by PSU Project Manager.
 - i. Light Topaz 7731W
 - ii. September Leaf 7744M
 - iii. Gobi Beige 8203M
 - iv. Fenland 8174M
 - v. Wild Grasses 8175D
 - vi. Millet 8212W
 - vii. Tobacco Road 8214M
 - viii. Scrimshaw 8150W
 - ix. Almond White 8180W
 - x. Angelica Blossom 7711W
 - xi. Winestain 8386N
 - xii. ComposedCW048W
 - xiii. Apple Peel CW030W
 - xiv. Plum Black White CW050W
 - xv. Pottery Blue 8491W
 - xvi. Impressive Ivory 8190W (wall field color)
 - xvii. Spiced Rum AC113N

PORTLAND STATE UNIVERSITY
DESIGN AND CONSTRUCTION STANDARDS

- xviii. Roasted Red Pepper AC 116N
 - xix. Devine Thunder
 - xx. Devine Sangria
 - xxi. Devine Feather (flat - for building entry facades)
 - xxii. Devine Twilight (wall accent paint)
 - xxiii. PSU Green (get paint number)
 - xxiv. Shoji White (SW convert to Miller)
 - xxv. Softer Tan (SW convert to Miller)
 - xxvi. Macadamia (SW convert to Miller)
 - c. Clear Finish -- Wood
Miller Nu-Wave or as approved by PSU Project Manager, water based, satin sheen, clear natural coating for wood; (4) coats.
 - d. Painted Metal Doors with Window and Door Frames
100% Acrylic for use on metal, PPG Pitt Tech. or as approved by PSU Project Manager, water base, satin sheen. Primer and (2) finish coats.
 - e. Door Trim
100% acrylic, satin finish for use on metal-- PPG Break-Through or as approved by PSU Project Manager at Doors and Frames. Must be cleanable. VOC level spec 50 grams/lit.
 - f. Interior Wood Stain
Woodtone Series Tint by Vermont Natural Coatings or as approved by PSU Project Manager.
 - g. Linseed Oil
Valspar or as approved by PSU Project Manager min (2) coats rubbed after clean existing surface.
 - h. Interior Joint Sealers
Silicone GE, Dow, DAP or as approved by PSU Project Manager. Use sanitary type in bathrooms.
 - i. Interior Hardwood Doors -- Existing Doors ---Oil rubbed.
Clear Finish : Color -- Natural wood -- Clean existing wood prior to application. Putty sign holes compatible color and material to door finish. New Doors stain to match existing.
 - j. Parking Stripes and painted signage -- Parking deck
Sherwin Williams, Setfast Waterborne pavement marking paint, or as approved by PSU Project Manager. Comply with Manufacturer's product data, technical bulletins, and catalog and container application instructions.
 - k. Wood floor coatings
Impax epoxy floor coatings, Bona, "Mega Seal WB" polymer , "Varathane" , and "Deft" finish Brush-on: Natural color matching stain on existing hardwood with water-based poly-varnish product.
 - l. Hardwood items
Clear Finish: Color -- Natural wood -- to MATCH EXISTING Use multi-layer UV cured alum oxide finish.
3. INSTALLATION
- a. In all cases paint to be applied with primer and minimum two finish coats of the paint color.
 - b. Paint all areas/surfaces that are part of demolition or new work. At Existing and New Wall Blocking, Patching/Painting -- Paint as required at new and existing gypsum board walls

PORTLAND STATE UNIVERSITY
DESIGN AND CONSTRUCTION STANDARDS

at all new or re-installed installations of electrical, mechanical, plumbing, or other new product or reinstalled items, including grab bars, recessed medicine cabinets, bathroom specialty items, trash chute doors, elect. wall heaters, outlets, lights, switches, and mechanical grilles in wall surfaces.

END OF SECTION

PORTLAND STATE UNIVERSITY
DESIGN AND CONSTRUCTION STANDARDS

SECTION 10 – **SIGNAGE, SPECIALTIES, AND FURNITURE**

A. EXTERIOR SIGNAGE

1. DESCRIPTION

Conform to PSU Communications Department and Campus Planning Office requirements and PSU Identity Standards (Appendix 10.2).

2. LOCATION

All campus property.

3. INSTALLATION

Conform to latest City of Portland codes and standards and latest ADA standards for installation locations.

B. INTERIOR SIGNAGE

1. DESCRIPTION

Conform to PSU Communications Department and Campus Planning Office requirements, PSU Identity Standards (Appendix 10.2), and Interior Signage standards (Appendix 10.1).

2. LOCATION

All interior locations in all PSU buildings

3. INSTALLATION

Conform to latest City of Portland codes and standards and latest ADA standards for installation locations.

C. FLAGS AND BANNERS

1. DESCRIPTION

Conform to PSU Communications Department and Campus Planning Office requirements and PSU Identity Standards (Appendix 10.2). Submit PSU Banner and Sign Installation Request Form.

2. LOCATION

All campus property.

3. INSTALLATION

Conform to latest City of Portland codes and standards and latest ADA standards for installation locations.

D. RESTROOM ACCESSORIES

1. DESCRIPTION

Some accessories shall be Owner furnished, Contractor installed. Their locations, dimensions, and clearance shall be clearly indicated on the plans. These items may include toilet seats, grab bars, shower curtains and hooks, toilet tissue dispensers, shower bath curtain rods, mirrors, medicine cabinets, towel bars and hooks, soap dispensers, paper towel dispensers, and coat hooks. PSU uses certain vendor provided paper products. These

PORTLAND STATE UNIVERSITY
DESIGN AND CONSTRUCTION STANDARDS

products may require the installation of vendor provided dispensers that are unique to that product. Confirm with the PSU project Manager prior to specifying restroom specialties to confirm that the specified dispenser is compatible with the vendor provided products. Refer to Appendix 01.6 – Restroom Preferences.

2. PRODUCTS

-  a. Choose energy efficient hand dryers over paper towel dispensers in all restroom facilities
- b. Restroom partitions shall be made of scratch and vandal resistant material. Choose materials that can be easily cleaned, easy to remove graffiti from, and can be sanded and refinished (for example, see composite partitions in second floor restroom in Smith Memorial Student Union).
- c. Choose automatic soap dispenser with light-activated batteries

3. LOCATION

- a. Shop drawings must include heights and locations of all specialty items and must be reviewed and approved by PSU Project Manager.
- b. Consider locating soap dispensers and hand dryers above sink to avoid wetting the floor.

4. INSTALLATION

- a. Conform to ADA standards, Universal Design standards, and City of Portland Codes, Standards and Requirements. If there is a question about the location, please confirm with PSU Project Manager prior to installation.
- b. Contractor to install fire retardant or incombustible metal blocking and backing as required at specialty items.

E. MISCELLANEOUS SPECIALTY ITEMS

1. CLOCKS

- a. All new surface-mounted clock installations must be equipped to the wireless synchronized clock system. Old surface-mounted clocks will continue to work as they do now and will be replaced as needed by the synchronized clock.
- b. AC-powered clocks (plug-in)
The standard clock that has been used in Campus is: American Time and Signal, PSU Stockroom #80003, SiteSync 110 Volts AC Surface-Mounted Clock, pre-programmed to synchronize with master controller
- c. DC-powered clocks (battery)
The standard clock that has been used in Campus is: American Time and Signal, PSU Stockroom #80005, SiteSync Battery Powered Surface-Mounted Clock, pre-programmed to synchronize with master controller
- d. PSU prefers and encourages AC-powered clocks that automatically update for daylight savings time without being integrated with a master controller.
- e. PSU Project Manager to coordinate synchronization of clocks with PSU wireless system.
- f. Clocks should be installed in all classrooms, general university conference rooms, public spaces (e.g. student lounges, library, recreation centers, etc.) on a case-by-case basis. Contact PSU Project Manager for additional location needs.

2. WHITEBOARDS OR WRITEABLE WALL SURFACES

PORTLAND STATE UNIVERSITY
DESIGN AND CONSTRUCTION STANDARDS

- a. Whiteboards shall be used in lieu of chalkboards where required (classrooms and conferences, may be considered in other locations. Refer to PSU Classroom Standards – Appendix 01.8
- b. In public areas, especially student lounges, consider selection of writeable wall surfaces in lieu of whiteboards. Provide signage and/or frames that clearly communicate to users the surfaces where writing is allowed in order to avoid writing on non-writable surfaces. Discuss locations and applications methods with PSU Project Manager.
- a. The use of modular partition systems with writable surfaces such as DIRTT is allowed and must be discussed with PSU Project Manager before specification.

F. FURNITURE

Refer to Campus Planning Office for classroom, office, systems furniture and fixed audience seating standards (Appendix 01.7, 01.8, and 01.9).

END OF SECTION

PORTLAND STATE UNIVERSITY
DESIGN AND CONSTRUCTION STANDARDS

SECTION 11 - **EQUIPMENT**

A. APPLIANCES

1. DESCRIPTION

- a. PSU discourages the purchases and installation of dishwashers and garbage disposals. Purchase and installation of these products must be approved by PSU Project Manager.
-  b. All appliances to be Energy Star rated and/or EPEAT certified as applicable. Refer to Energy Conservation Guidelines (Appendix 26.1).

END OF SECTION

PORTLAND STATE UNIVERSITY
DESIGN AND CONSTRUCTION STANDARDS

SECTION 12 – **SITE FURNISHING**

A. BYCICLE RACKS AND SKATE DETERRENTS

1. DESCRIPTION

- a. General
Provide reinforcing, backing and sleeves in surfaces to receive site items.
- b. Skate Deterrents
Barco Products F1 Series Skate Deterrent or as approved by PSU Project Manager for new construction, FA-FR Series.
- c. Bike Racks
 - i. Standard steel tubing type as specified by PSU Transportation and Parking Services (TAPS). Dero or as approved by PSU Project Manager.
 - ii. Bike racks placement and installation shall be coordinated with PSU Capital Projects & Construction (CPC) Project Manager.

B. TRASH and RECYCLING CONTAINERS



1. DESCRIPTION

- a. Provide approved waste and recycling containers for common areas on each floor. Contact and coordinate with PSU's Waste Management Coordinator. Refer to Section 06.C.1.c for description of wall niches.
- b. Provide approved compost containers for departmental break rooms and kitchens areas. Provide approved centrally located compost containers in public areas such as study lounges. Contact and coordinate with PSU's Waste Management Coordinator.

C. FOUNTAINS

1. DESCRIPTION

- a. Installation of new fountains on campus is not allowed.
- b. If fountains are approved, product and materials shall be as specified by architect or project manager in consultation with PSU Plumbing and Maintenance staff. Pumping system for fountains must be solar operated. A separate waterproofing plan with details must be provided and approved by PSU Project Manager.

END OF SECTION

PORTLAND STATE UNIVERSITY
DESIGN AND CONSTRUCTION STANDARDS

SECTION 14 – **CONVEYING SYSTEMS**

A. ELEVATORS

1. GENERAL

- a. For new construction, provide traffic analysis showing projected capacity and elevator speed requirements.
- b. Provide traction elevators for all lifts and hoist-ways over 50 feet.
- c. For buildings with two or more elevators, size and outfit one elevator as a freight and passenger dual purpose elevator. (e.g. PSU Engineering Building)
- d. Acoustical treatment for elevator machine rooms shall be provided as necessary to be compatible to the surrounding building usages.

2. PRODUCTS

- a. All elevators to be composed of non-proprietary equipment. Examples of non-proprietary manufacturers include:
 - i. MCE and EC – Elevator Controllers.
 - ii. Hollister-Whitney – Elevator Machinery, Cabs, and Rails.
 - iii. (NOT RECCOMENDED) Proprietary Manufacturers include: Otis, Schindler, Kone, and ThyssenKrupp.
- b. “Bruiser Elevator Accessories” by Innovation Industries Inc. is the preferred manufacturer of hall fixtures and call buttons.
- c. Due to high levels of elevator traffic causing overheating issues, the installation of hydraulic elevators is discouraged.
- d. Wall finishes shall consider maintenance and cleanability. Avoid surfaces that can scratch easily.

3. EXECUTION

- a. Provide stops at all floors with substantial mechanical equipment including rooftops and subbasements.
- b. Provide a dedicated temperature controlled machine room for all elevators to house elevator equipment, controller, and electrical disconnects.
- c. Provide a shunt trip breaker to protect elevator equipment in the event of sprinkler system activation.

END OF SECTION

PORTLAND STATE UNIVERSITY
DESIGN AND CONSTRUCTION STANDARDS

SECTION 21 – FIRE SUPPRESSION

A. FIRE SUPPRESSION SYSTEMS

1. STANDARDS OF PERFORMANCE

- a. Compliance with the design standards listed in this section is required unless otherwise noted by the PSU Project Manager.
- b. All work to conform to NFPA and Oregon fire Code for a complete code compliant installation.
- c. Ease of accessibility to systems/equipment for repair, maintenance, or replacement must be considered in design and construction.
- d. PSU prefers non-proprietary equipment.
- e. At the end of the project, submit to PSU all CAD files and calculations (ex. Battery, current draw, etc.). Provide all equipment start up reports, testing reports, and approvals from AHJ (Authority Having Jurisdiction).
- f. Contractor shall manage all design, permitting, and inspections.
- g. When feasible, fire systems shall be commissioned by 3rd party after installation on systems valued over \$100,000.
- h. Fire systems to be tied into PSU BAS on systems when economically feasible.
- i. Fire sprinkler systems must be installed on major remodels, new construction, or per code.
- j. All fire alarm system wiring shall be installed per code. All wiring shall be secured using UL listed systems designed for fire systems.
- k. Notify and obtain permit from Fire Marshall for any fire alarm/sprinkler installation, alteration, or removal.
- l. Observe all code and regulations for Fire Watch procedures including notifications to the Fire Marshal.
- m. All construction shall meet PSU Environmental Health & Safety (EH&S) Hot Work Program.
- n. PSU's insurance carrier FM Global is to be consulted on all major and/or high risk fire system modifications.
- o. For modifications to the system or to put systems into bypass, obtain FM Global Impairment Permit through PSU EH&S.

2. FIRE ALARMS

- a. Annunciation system must have capability of voice audibility for future implementation of mass notification system.
- b. Fire alarm systems shall be provided with at least one audible circuit per floor. Circuits shall not control devices on multiple floors.

3. FIRE ALARM CONTROL PANELS

- a. Manufacturer: Silent Night or as approved by PSU Project Manager.
- b. All fire alarm infrastructure to be integrated into PSU campus-wide fire alarm network and applicable fire panels and systems.

PORTLAND STATE UNIVERSITY
DESIGN AND CONSTRUCTION STANDARDS

- c. Fire alarm control panels must be addressable, have capacity for voice audibility, and be able to network to the graphical user interface.
 - d. Panels must be installed on fire-rated plywood that ensures adequate clearance on all sides. Install panels in an area that allows room for future/replacement panels to be installed.
 - e. Install one data drop and two phone lines to each fire panel.
 - f. Panels shall be located in a secured room on the ground floor of building so that it is easily accessible by Fire Department and PSU personnel.
4. BEAM DETECTORS
- a. Manufacturer: Silent Night, System Sensor, or as approved by PSU Project Manager.
 - b. Beam detectors must seamlessly communicate with existing system.
 - c. Detectors must be easily accessible or provide remote test station.
 - d. If possible, do not install beam detectors with less than 12' ceiling height, or in public corridors, or any place where a regular detector can be used.
5. DUCT DETECTORS
- a. Manufacturer: Silent Night, System Sensor, or as approved by PSU Project Manager.
 - b. Duct Detectors shall be installed per code, must be relay-based, and tied into fire alarm panel.
 - c. Detectors must be easily accessible or provided with remote test station.
6. SMOKE DETECTORS
- a. All smoke detectors shall be photoelectric only. Ion detection systems are not allowed.
 - b. Tie smoke detectors into fire alarm panel.
 - c. Smoke detectors shall be installed in each residential unit.
7. CARBON MONOXIDE DETECTORS
- a. When feasible, provide carbon monoxide detector in areas such as tunnels, parking garages, confined spaces, emergency generator rooms and other hazardous locations.
 - b. Tie carbon monoxide detectors into fire alarm panel.
 - c. Carbon monoxide sensors shall be installed in each residential application or as approved by AHJ.
8. FIRE SMOKE DAMPERS (FSDs)
- a. Manufacturer: Ruskin or as approved by PSU Project Manager.
 - b. Actuator and damper must be accessible.
 - c. Actuators preferred to have 5-year warranty.
 - d. Provide test switch for all FSDs.
 - e. FSDs shall be tested per NFPA standards.
 - f. Status of FSDs shall be monitored by BAS and controlled through the fire panel.
 - g. HVAC system shall be equipped with pressure sensor in order to prevent damage to duct work in the event that a FSD(s) shut unexpectedly.
 - h. When applicable, an electrical disconnect shall be located within eye sight of FSD.

PORTLAND STATE UNIVERSITY
DESIGN AND CONSTRUCTION STANDARDS

- i. After a fire, event dampers shall be reset to the open position once fire system is back in normal operation.

9. FIRE SUPPRESSION MATERIALS AND METHODS

- a. Black steel pipe is preferred. Piping shall be 2-inch in diameter or smaller, or piping exposed at 8' or less above finished floor shall be schedule 40. Piping 2-1/2 inch in diameter or larger shall be schedule 10. Provide factory applied anti-microbial coating.
- b. Threaded, flanged, welded, and mechanical fittings are approved.
- c. System shall be drainable; drains shall be equipped with a locking mechanism. When feasible, locate drain ports to the exterior of the building. When draining system inside the building, all drains shall be able to accept the demands of fire-systems testing.
- d. All piping shall be cleaned, capped, and flushed prior to install.
- e. Test headers for wet, dry, and combination systems shall be located per code. Provide means to test, drain, and monitor for flow. Provide locking plate, lock and keys.
- f. Piping shall be seismically braced per code and/or by the structural engineer recommendations.
- g. Test headers and stand pipes shall be installed and located per code. Test headers need to be monitored for flow.
- h. Risers are preferred to be concealed in shafts with applicable access panels. Provide a shut off valve on every floor with pressure gauges. Provide tamper proof devices.
- i. Provide back flow prevention that is UL listed and FM global approved. Provide OS&Y gate valves on inlet and outlet with indentation for monitoring switch and strainer on inlet.
- j. Contact AHJ for heat tracing and insulation requirements for fire protection piping.
-  k. The manufacturing and on-site fabrication and disposal of construction materials shall be sustainable.
- l. Verify and protect existing Sprinkler System at existing ceilings and walls.
- m. When routing wet system piping through electrical and server rooms, containment system must be provided underneath wet pipe (e.g. sheet metal gutter). Provide leak detection.

10. FIRE PUMPS

- a. Manufacturer: Peerless (Fire Pump); Firetrol (Fire Pump Controller's); Grundfos (Jockey Pump); or as approved by PSU Project Manager.
- b. Fire pumps must have automatic weekly exercise capability.
- c. A dedicated fire pump room is preferred.
 - i. The room shall be restricted to authorized personal only
 - ii. The room shall be kept between 40 F – 104 F.
 - iii. All lighting serving the room shall be on emergency power
 - iv. The room shall be rated for 2-hour protection
 - v. Suction piping shall have city water bypass.
- d. Floor drain shall be provided in fire pump room. Drain piping shall not cross the path of travel. Slope floor to drain.
- e. Fire pumps must have data storage capability at panel and soft start on the motor.
- f. Provide 100% shut off valves on both ends of test loops.

PORTLAND STATE UNIVERSITY
DESIGN AND CONSTRUCTION STANDARDS

- g. Provide pressure gauges on suction and discharge of pump.
- h. New fire pumps shall be installed on inertia base.
- i. Fire pump and jockey pump shall be wired into emergency generator with a dedicated transfer switch.
- j. Fire pump shall be tested in accordance with NFPA and (AHJ).
- k. Fire Pump and panel shall be tied into building's main fire panel.
- l. All power and controls associated with fire pump shall be a 2-hour rated assembly approved by AHJ.

11. PRE-ACTION SYSTEMS

- a. Manufacturer: Silent Night, Potter, or as approved by PSU Project Manager.
- b. Dry systems shall be used when system is exposed to freezing conditions or in sensitive areas (e.g. server rooms, research labs, etc).
- c. Install pre-action control panel located within sight of the pre-action valve. Panel must be accessible and have the code required clearances.
- d. Compressor shall be heavy duty or commercial rated. Compressor will be sized to fill the appropriate system within half an hour. Provide an auxiliary tank. Systems must have auto-bleed.

12. RAIN WATER COLLECTION TANKS FOR FIRE SUPPRESSION SYSTEMS

- a. Tank must be located in basement.
- b. Provide adequate access and clearance for cleaning.
- c. All tank penetrations shall be sealed water tight.
- d. Tank shall be lined. Upon completion of curing time of liner, tank shall be filled and tested for seven consecutive calendar days demonstrating compliance with NFPA 22.
- e. Rain/tank water shall be chemically treated and/or filtered.
- f. The filling of the tank shall be automatic with redundant shut-offs and supplies.
- g. Provide low/high level alarms and low-low/high-high level alarms.
- h. Provide secondary containment and leak detection system tied into BAS.
- i. Install room drain that can handle the tank capacity.
- j. When required, provide an OSHA-approved ladder system in order to access tank.

13. FIRE SUPPRESSION STAND PIPES

- a. Fire suppression hose valves shall be located on floor level landings of stairwells. Provide additional drains as required to achieve proper drainage.
- b. For roof hydrant connections, provide control valve that is freeze proof and connected to building alarm system.
- c. Fire department connections shall be located to ensure proper clearance from walls, free of obstructions, to allow full swing of fire department wrench handle. Provide method for pipe draining.

14. TEST HEADERS / FIRE DEPARTMENT CONNECTIONS

- a. When planning for system testing, take precautions to avoid creation of exposed low points in the system or areas which may later freeze creating hazards.

PORTLAND STATE UNIVERSITY
DESIGN AND CONSTRUCTION STANDARDS

- b. Appropriate clearances must be maintained (e.g. clear path to test header, circulation space, not creating trip hazard, etc) in accordance with relevant regulations.
- c. Coordinate placement of test headers with the Fire Department. Test headers must have proper clearance around the header, and avoid being placed in front of landscaping.

15. AUTO-FILL VALVES

- a. Auto-fill valves must have mechanical and electrical redundancies to cut off systems when needed.
- b. Auto-fill valves must have the ability to manually shut off and manually fill.
- c. Auto-fill valves must have bypass installed on the auto-fill assembly.
- d. Auto-fill valves must be alarmed/monitored via PSU Building Automation System.

16. FLOW SWITCHES

Provide where required. Consult PSU operation staff for approved locations.

17. SPRINKLER HEADS

- a. Minimum 20 pounds water pressure to be maintained at top floor in sprinkler heads.
- b. All new heads shall be UL listed, quick-response type, with chrome finish or easily identifiable and recessed.
- c. Sprinkler heads older than 20 years must be replaced or as required by AHJ.
- d. Verify and remove existing fire sprinkler heads in area of work. Install new heads and adjust locations for new construction.
- e. Concealed sprinkler heads shall be used in gymnasiums, residence units, public corridors, and in any place where the ceiling is exposed to impact.
- f. Sprinkler heads shall be caged in mechanical and electrical rooms, janitorial closets, and/or similar spaces.

18. FIRE HOSE CABINETS

- a. Fire hose cabinets shall be monitored via the fire alarm panel.
- b. Existing fire hose cabinets shall be removed per AHJ.

19. FIRE EXTINGUISHERS

- a. Fire extinguishers must be tied into the fire control panel when feasible.
- b. Provide a local audible sounder in order to prevent theft.

END OF SECTION

PORTLAND STATE UNIVERSITY
DESIGN AND CONSTRUCTION STANDARDS

SECTION 22 – **PLUMBING**

A. PLUMBING PIPING SYSTEMS

1. GENERAL

- a. Ensure as much as possible adequate clearance for ease of accessibility to systems/equipment for repair, maintenance or replacement.
- b. All items in this section shall comply with code and industry standards, unless otherwise noted.

2. EXPANSION FITTINGS AND LOOPS

- a. For copper, steel, and gas piping, stainless steel braided hose shall be used for flexible pipe connections.
- b. Install expansion joints in accordance with EJMA (Expansion Joint Manufacturer's Association) Standards.
- c. Attach pipe bends and loops to anchors.
- d. Install guides on piping adjoining expansion fittings and loops. Attach guides to pipe and secure to building structure.
- e. Install anchors at locations to prevent stresses from exceeding those permitted by ASME B31.9 and to prevent transfer of loading and stresses to connected equipment.
- f. Clean field welds and abraded areas of shop paint. Paint exposed areas immediately after erecting hangers and supports. Use same materials as used for shop painting.

3. HANGERS AND SUPPORTS FOR PLUMBING PIPING AND EQUIPMENT

- a. Loop hangers are preferred with the exception of no hub pipe. For no hub pipe, clevis hangers are preferred.
- b. Metal insulation shield shall be installed with hangers in order to protect insulation.
- c. For horizontally hung piping, provide a minimum of 2 hangers per pipe section.
- d. Provide steel backing, including pre-manufactured carriers, in walls to support fixtures and piping hung from steel stud walls.
- e. Do not support piping from other piping.
- f. Group parallel runs of horizontal piping shall be supported together on trapeze-type hangers.
- g. When dissimilar metals come in contact with each other, select materials which are compatible to prevent electrolysis, or provide means of isolation between the materials.
- h. Provide prefabricated pipe curb assemblies for roof membrane and insulation penetrations related to equipment.
- i. Piping above roof to be supported with freestanding roof pipe supports.
- j. Install escutcheon plates around horizontal and vertical piping at visible locations through walls, partitions, floors or ceilings.
- k. Wall and floor sleeves below grade or subject to moisture shall have neoprene gasket links bolted together around an interior sleeve forming a watertight seal.
- l. Wall and floor sleeves shall be UL rated assemblies when needing to maintain fire rating of pipe penetrations through fire-rated assemblies.

PORTLAND STATE UNIVERSITY
DESIGN AND CONSTRUCTION STANDARDS

- m. Provide riser clamps at floor penetrations. Install foam pad between clamp and piping. Floor penetrations must be sleeved and sleeve must extend a minimum of 1" above finished floor.
4. METERS, DEVICES AND GAUGES FOR PLUMBING SYSTEMS
- a. Manufacturers:
 - i. Gauges: Precision Plumbing Products or as approved by PSU Project Manager;
 - ii. Digital Domestic Water Meters: Cadillac CMAG or as approved by PSU Project Manager
 - iii. Turbine Domestic Water Meter: Carlon (lead free) or as approved by PSU Project Manager.
 - b. Place at inlet & outlet in each piece of equipment (boiler, expansion tank, storage tank, etc.).
 - c. Positive displacement (liquid) meters and gauges are preferred.
 - d. For pressure reducing valves, provide manual temp. and pressure gauges directly downstream and upstream of valve.
 - e. Digital meter to be installed on incoming water main from City. Turbine meters are considered for City make up and process water metering (e.g. cooling towers).
 - f. Shut-off valves are required on all gauges.
 - g. Provide instruments with scale ranges selected according to service with largest appropriate scale.
 - h. Provide water hammer arrester when applicable and per the recommendations of Plumbing and Drainage Institute PDI-WH201.
 - i. Hammer arrester shall be installed with ball valve for maintenance purpose.
 - j. Install gauges and meters in locations where they are easily read from normal operating level. Install vertical to 45 degrees off vertical.
 - k. Where adequate space is not available, use meters specifically designed for short pipe lengths.
 - l. Install meters per manufacturer's instruction. Provide recommended upstream and downstream strait pipe length for accurate reading.
 - m. Locate test plugs adjacent to thermometers and thermometer sockets, adjacent to pressure gauges and pressure gauge taps, adjacent to control device sockets, or where indicated.
 - n. Install trap primers per code. Tie into DDC controls if feasible.
5. GENERAL DUTY VALVES
- a. Manufacturer: Powers, Apollo, Nibco, Zwick or as approved by PSU Project Manager.
 - b. For isolation, ball valves are preferred over gate valves and butterfly valves.
 - c. Mechanical domestic water mixing valves are preferred over digital.
 - d. Use Outside Stem & Yoke (OSY) shut-off valves for pipes 4" and larger.
 - e. For pressure regulating valves, provide inlet, outlet, and bypass isolation valves.
 - f. When possible, provide one set of isolation valves in order to completely isolate all fixtures per space (e.g. classroom, dormitory, bathroom, etc.).

PORTLAND STATE UNIVERSITY
DESIGN AND CONSTRUCTION STANDARDS

- g. Install valves where required for proper operation of piping and equipment, including valves in branch lines where necessary to isolate sections of piping.
 - h. Locate valves so as to be accessible; install with chain operators as required. Extend chains to 5-feet above floor and hook to clips to clear aisle passage.
 - i. Provide hand wheels fastened to valve stem for valves other than quarter-turn. Provide lever handle for quarter-turn valves 6-inches and smaller.
 - j. Provide freeze-proof hydrants at various locations on exterior building walls.
 - k. Manufacturer's name and pressure rating to be clearly marked on valve body.
6. BALANCING VALVES
- a. Manufacturer: Bell & Gossett, Griswold or as approved by PSU Project Manager.
 - b. Balancing valves shall be installed on all pumping systems downstream of pump. This applies only when a VFD is not installed.
 - c. Balancing valves shall be installed on all branch loops that serve fixtures/equipment (e.g. hot water recirculation loops, hot water heating loops, etc).
 - d. Install balancing valves with flow in the direction of the arrow on the valve body. Allow enough distance away from any fitting, as recommended by manufacturer.
7. CLEANOUTS
- a. Provide cleanouts under every kitchen sink and at the base of all waste and drain stacks.
 - b. Provide brass cleanout for no hub piping.
 - c. Provide ABS cleanout when installing ABS piping, do not provide brass cap.
 - d. Cleanout must be accessible. Install floor and wall covers for concealed piping. Select type to match adjacent building finish.
 - e. Cleanouts in underground sanitary or acid waste systems shall be line size for mains up to 4" Ø. For mains having a diameter greater than 4", cleanouts shall be 4" Ø.
8. BACK FLOW PREVENTION / CHECK VALVES
- a. Manufacturer:
 - i. For line sizes less than or equal to 2", use Conbraco or as approved by PSU Project Manager.
 - ii. For line sizes greater than 2", use Wilkins or as approved by PSU Project Manager.
 - b. For main building backflow assembly, install bypass. Bypass shall be equipped with means for backflow.
 - c. Install Y strainer at main building backflow device and ensure clearances.
 - d. Avoid locating valve(s) in vaults or confined spaces.
 - e. For 2" and larger, provide OS&Y shut off valves on each side of valve.
 - f. Spring check valves, Wafer check valves, and Lift check valves are acceptable for low hazard applications (e.g. pump discharge).
 - g. Vacuum breakers are acceptable for lab sinks and low hazard applications.
 - h. Where practical, locate valve in the same room as equipment being protected.
 - i. Chemical/soap dispensers for janitorial closets or kitchen must have a backflow device.

PORTLAND STATE UNIVERSITY
DESIGN AND CONSTRUCTION STANDARDS

- j. Seek review and approval of exact location and type of valve with Authority Having Jurisdiction (AHJ) prior to purchase and installation. Provide all required testing after installation per AHJ requirements and provide appropriate documentation to PSU.
9. ELECTRICAL HEAT TRACING
- a. Install electrical heating tracing system when piping is exposed to freezing conditions.
 - b. Piping shall be labeled accordingly. Label piping indicating circuit and panel locations.
 - c. Electrical heat tracing system shall be 120 VAC.
10. VIBRATION AND SEISMIC CONTROL FOR PLUMBING
- a. Consider installing vibration control when equipment is above, below, or near noise sensitive area.
 - b. Steel equipment bases shall have the lowest possible mounting height with not less than 1" clearance above floor.
 - c. Set floor-mounted equipment with steel base rails on 4" high concrete housekeeping pads. Extend pad 6" beyond footprint of equipment in each direction.
 - d. Provide mounts for equipment installed outdoors for wind loads of 30 lbs. psf applied to any exposed surface of isolated equipment.
 - e. Do not install equipment or pipe that makes rigid contact with building slab, beams, studs, walls, etc.
 - f. Support water and gas piping, connected to rotating equipment within equipment rooms, on spring and neoprene hangers.
 - g. Fill pump inertia bases with concrete. Support heels of suction and discharge elbows from base.
11. IDENTIFICATION FOR PLUMBING PIPING
- a. Comply with ANSI A13.1 for lettering size, length of color field, colors, and viewing angles of identification devices.
 - b. Provide stickers for identification rather than stenciling. Mechanic fastening is also acceptable.
 - c. Include flow direction for both air and water systems.
 - d. Notify if polypipe or plastic pipe is being used.
 - e. Provide a valve schedule as part of a submittal package. Upon approval from owner, valve shall be framed and installed appropriately in building mechanical spaces by completion of project. Valves shall be tagged in the field per schedule.
 - f. Provide ceiling tile labels for Plumbing equipment (labeled orange) and plumbing valves (labeled Green). Labels shall be machine generated, with adhesive backed with black letters and clear tape.
 - g. Coordinate with PSU facility maintenance personnel to ensure consistency with the existing piping identification system.
 - h. Tag balancing valves with GPM or CFM. Valve position after balancing is completed.
 - i. Identify plumbing equipment and control panels with plastic nameplates riveted to equipment body.
 - j. Provide stenciled signs on each access door and housing, indicating purpose of access.
12. INSULATION

PORTLAND STATE UNIVERSITY
DESIGN AND CONSTRUCTION STANDARDS

- a. Manufacturer: Copper/Steel Piping, Fiber Lock; Polypipe, Armaflex
 - b. Do not apply insulation until pressure testing, heat tracing, and general inspections have been completed and approved:
 - c. Insulation shall be continuous through walls, floors and partitions except where otherwise noted.
 - d. For piping and equipment, install insulation over clean, dry surfaces with adjoining sections firmly butted together and covering surfaces. Repair all voids and tears. Lap seal insulation with water proof adhesive. Do not use staples or other methods of attachment which may penetrate vapor barrier. Provide blankets over valves or components that require access.
 - e. For ADA lavatories/sinks provide insulation kit.
 - f. For piping that is exposed to weather, cover insulation with aluminum or stainless steel jacket. Seal water tight jacket and provide heat tracing where piping is exposed to freezing.
 - g. Provide full size diameter hangers and shields (18 gauge minimum).
 - h. For roof and/or overflow Drains above grade, cover horizontal storm drains and overflow drain piping with sectional pipe covering. Cover underside of drain body with insulation, attached with adhesive and supported by structure with strapping anchor.
13. PLUMBING PIPING
- a. Manufacturers:
 - i. Polypipe: WIRSBO
 - ii. Flexible gas piping: WARDFLEX
 - b. For all applications, copper piping shall be Type L minimum and shall be solder or brazed.
 - c. Condensate piping for drainage of condensate from combustion. Fuel sources shall be polypropylene pipe with fusion weld fittings.
 - d. The use of Polypipe is allowed for piping 2" or less. Use manufacturer provided fittings. The fitting manufacturer shall match the piping manufacturer.
 - e. Gas piping shall be carbon steel schedule 40. Flexible piping is acceptable for smaller diameter applications of 1" or less.
 - f. Install pipes and pipe fittings in accordance with recognized industry practices.
 - g. Locate piping runs as indicated, vertically and horizontally insulated (pitched to drain). Avoid diagonal runs whenever possible. Allow space for insulation and jackets.
 - h. Whenever possible in finished and occupied spaces, conceal piping from view.
 - i. Do not run piping through transformer vaults, telephone, elevator, electrical or electronic equipment spaces or enclosures.
 - j. Sleeves are required through all penetrations with Fire caulking. Provide nickel or chrome finished escutcheon rings as specified in order to completely cover pipe penetrations.
 - k. Provide vents and drains for piping, coils, and equipment/vessels which contain water. Provide isolation valves. Provide hose connections and caps on drain lines.
 - l. Piping connections to equipment shall be made up with unions.
 - m. Piping shall be cut squarely, free of rough edges, and reamed to full bore. Piping shall be fully inserted into fittings. Press fittings are not accepted.

PORTLAND STATE UNIVERSITY
DESIGN AND CONSTRUCTION STANDARDS

- n. Keep pipe openings closed by means of plugs or caps to prevent entrance of foreign matter. Cap all abandoned pipes.
- o. Welders performing work shall be certified and qualified in accordance with tests prescribed by the National Certified Welding Bureau.
- p. Provide flanges for steel and copper piping at valves and equipment, unless specified otherwise.
- q. In order to prevent electrolysis, provide dielectric unions/flanges as required. Avoid contact with dissimilar metals, including contact with Architectural framing. Provide rubber pads in order to isolate piping from floor penetrations, hangers, clamps, and other potential sources of electrolysis.
- r. For sanitary and storm sewer, use cast iron, ABS, or as approved by PSU Project Manager. Fittings to be no hub, use 4-band fittings.
- s. For sanitary and storm sewer, piping shall be graded per drawings. Extend piping to discharge. For indirect waste, maintain minimum air gap and provide traps as required.
- t. Backwater Valves: For residential applications valve shall be ABS. Provide access two times the lid size.
- u. Pressure-test all piping per code or per engineer's recommendations. Testing shall be witnessed by PSU Project Manager of PSU facility maintenance staff whenever possible. Provide report to PSU and architect.
- v. Sterilization of domestic water system: Upon completion of tests and necessary replacements, thoroughly flush and disinfect domestic water piping per method outlined by engineer. Provide final certification and reports to owner.
- w. For major remodels, all waste piping shall be snaked/unclogged by applicable contractor in order to remove sediment that hardens over time due to non-use.

14. FLOOR DRAINS

- a. Manufacturer: Zurn or as approved by PSU Project Manager.
- b. Install drains to suit floor finish. Arrange for flooring to be sloped to floor drain or sink. P-traps shall match material of piping and be provided with a trap primer assembly. Heat trace and insulate p-traps exposed to freezing conditions.
- c. Floor drains are recommended in restrooms, janitor's closets, near safety showers, commercial kitchens, laundry facilities, and mechanical rooms. Body of drain shall be cast iron and epoxy coated, plastic may be considered for retrofit applications.
- d. Unless function of a particular laboratory necessitates inclusion of dedicated floor drain, include a floor drain or floor sink to be located in the adjacent corridor, no further than 25 feet from the laboratory entrance. This allows for a single drain to serve multiple laboratories.
- e. Strainer shall be stainless steel, brass or cast iron. Plastic will not be accepted.
- f. Floor drains shall be equipped with trap primer per code if drain is rarely active.
- g. Drains in parking structure shall be manufactured for this application. Strainer shall be selected to avoid debris build-up and tripping hazard.
- h. Area drains in parking structure shall be of steel grate style.
- i. All drainage from parking structure shall be connected to sanitary system or other, per the direction of the City of Portland.
- j. All floor drains shall be vented.

PORTLAND STATE UNIVERSITY
DESIGN AND CONSTRUCTION STANDARDS

- k. Design and provide roof drains per City of Portland's Plumbing code.
- l. Provide overflow requirements per the City of Portland Plumbing code.
- m. Provide collar and dome for all roof top drains.
- n. Roof drains shall be cast iron body and epoxy coated.
- o. All drainage from roof shall be connected to sanitary system or other, per the direction of the City of Portland

15. LABORATORY PIPING SYSTEMS

- a. Manufacturers:
 - i. Emergency Showers: HAWS or as approved by PSU Project Manager.
 - ii. Mechanical Fitting's/Piping: ORION or as approved by PSU Project Manager.
 - iii. Laboratory Faucets: Chicago or as approved by PSU Project Manager.
- b. Domestic Potable and Non-Potable, Hot and Re-Circulation Water:
Provide polypropylene pipe or copper tubing.
- c. Laboratory Natural Gas
Schedule 40 and 80 black or hot dipped zinc coated galvanized copper. Provide welding and seamless pipe. Piping installed in plenums or shafts shall have welded joints.
- d. Laboratory Gas Piping
Anaerobic Oxygen, Nitrogen, Carbon Dioxide, Compressed Air, and Vacuum shall be type "K" hard drawn seamless copper. Do not use soft drawn copper tubing.
- e. DI Water
Piping, fittings, and valves shall be schedule 80 Type 1 homopolymer polypropylene. Use socket fusion heat method. Clean PVC is allowed as an alternate material.
- f. Laboratory Sinks
Provide stainless steel single compartment with ledge, 18 gauge type 316 drop in type. Provide type 316 strainer with tail piece.
- g. Laboratory Faucets
Provide deck mount with mixing valve and gooseneck with vacuum breaker. Provide four arm color coded handles, serrated nozzle, and single hole punch.
- h. Emergency Showers/Eyewash
Provide emergency shower at door, barrier free emergency shower unit, and eye wash at laboratory sink when applicable. Mixing valve shall mount under sink or recessed in cabinet. Drains are required near locations; consider installation away from equipment.
- i. Acid Waste
Use PVC Schedule 80. Acid waste floor drain shall have sediment basket, acid resistant, polypropylene with heavy duty strainer and weep holes. Provide heat fusion joint.

B. PLUMBING EQUIPMENT

1. GENERAL

- a. Ensure adequate clearance for ease of accessibility to systems/equipment for repair, maintenance or replacement
- c. All items in this section shall comply with code and industry standards, unless otherwise noted

PORTLAND STATE UNIVERSITY
DESIGN AND CONSTRUCTION STANDARDS

- b. Provide valves and flanges at appropriate locations to accommodate maintenance and future replacement.
 - c. Provide concrete housekeeping pads when applicable.
 - d. Contractor to provide required equipment data for PSU deferred maintenance software.
 - e. Ensure that replacement parts and components are available locally.
 - f. All equipment shall be started up by factory representative. Documentation shall be provided to owner.
 -  g. All equipment shall be as water efficient as possible, be WaterSense and EnergyStar certified where applicable, and shall assist in achieving Water Efficiency credits in the LEED rating system.
2. IDENTIFICATION OF PLUMBING EQUIPMENT
- For identification purposes, stickers shall be used in lieu of stenciling.
3. DOMESTIC EXPANSION TANKS
- a. Domestic expansion tanks shall be tested and stamped in accordance with ASME boiler and pressure vessel code. Pressure shall match the maximum pressure the system is designed for.
 - b. Provide support floor mounted tanks with steel legs. Diaphragm shall be removable and inline. Provide pressure gauge and air-charging fitting and drain-fitting.
4. DOMESTIC CIRCULATION PUMPS
- a. Manufacturer shall be GrundFoss or as approved by PSU Project Manager.
 - b. Pressure rating shall match maximum working pressure of system.
 - c. Body shall be bronze or stainless steel construction. Shaft shall be stainless, ground, and polished.
 - d. Motor shall be non-overloading at any point on pump curve, be open, drip-proof, and quiet operating. Motor shall have sleeve bearings, rubber mounted construction, and built-in thermal overload protection.
 - e. Pump may be controlled off of aquastat or via the building automation system.
5. SUMP PUMP/SEWAGE EJECTOR PUMP
- a. Provide grinder on the impeller.
 - b. Provide check valve and shut off valve on discharge of the pump.
 - c. Provide perforated 24" x 24" steel basin cover and frame.
6. PACKAGED DOMESTIC BOOSTER PUMP SYSTEM
- a. Manufacturer: GrundFos or as approved by PSU Project Manager.
 - b. Minimum pressure setting shall be 4 feet above top of highest roof level
 - c. Skid to be furnished with VFD and pump controller located in same panel. Control panel shall accommodate seamless connection to PSU building automation system.
 - d. System shall be factory assembled and tested, and shall be delivered with complete operating controls.
 - e. Common discharge header shall be equipped with purge valve which will divert water to drain in the event of pump failure.

PORTLAND STATE UNIVERSITY
DESIGN AND CONSTRUCTION STANDARDS

- f. Pump controller, at a minimum, shall provide low suction cut out, high system pressure cut out, and a no-flow shut down when the hydro pneumatic tank can handle demand.
- g. System shall be equipped with separate hydro-pneumatic tank to provide low flow demands to the building. Tank shall be equipped with replaceable bladder.

C. PLUMBING FIXTURES

1. GENERAL

- a. Ensure adequate clearance for ease of accessibility to systems/equipment for repair, maintenance or replacement.
- b. Fixture Connections: Provide ¼ turn angle stop's, escutcheon rings and stainless steel braided hose for hot water and cold water connections to fixtures; Chrome p-trap for lavatories, ABS acceptable when p-trap is not exposed.
- c. Hot water knob shall be on the left hand side and cold water knob shall be on the right hand side unless otherwise noted.
- d. Accessible fixtures shall be provided per code; meet all barrier free requirements.
-  e. All new fixtures shall be as water efficient as possible, be WaterSense certified where applicable, and should assist in achieving Water Efficiency credits in the LEED rating system.



2. HIDRATION LOCATIONS / BOTTLE REFILL STATIONS

- a. Bottle refill stations may include hydrations stations, retrofitted kits for water fountains, or other solutions that allow users to easily refill water bottles. Install at least one refilling station on each floor of new construction projects and at least one station per building in existing buildings.
- a. Manufacturer: HAWS, Elkay, or as approved by PSU Project Manager.
- b. Pentek filters with quick disconnect, or as approved by PSU Project Manager, are preferred for hydration stations and combo drinking fountain / hydration stations. Provide adequate access for cleaning.
- c. Provide combination drinking fountain and hydration station for all new buildings and major remodels. These shall be recessed in walls and splash-proof.

3. DRINKING FOUNTAINS



- a. If drinking fountains are approved and installed, fountains shall include "fillneck" infrastructure for filling water bottles.
- b. Manufacturer: HAWS or as approved by PSU Project Manager.
- c. Do not specify refrigerated drinking fountains.
- d. New installations shall be recessed in wall and be bi-level.

4. MOP SINKS

- a. Provide cold water stub out for chemical feed stations with back flow preventer.
- b. Mop sinks shall be flush to the ground and installed with stainless steel backing. Rounded base is preferred.

5. COMMERCIAL/PUBLIC KITCHEN SINKS

- a. Manufacturer: Stainless steel Kohler or InSinkErator or as approved by PSU Project Manager.

PORTLAND STATE UNIVERSITY
DESIGN AND CONSTRUCTION STANDARDS

- b. Faucet shall have means to prevent HW and CW cross-over (e.g. check valve).
6. COMMERCIAL/PUBLIC LAVATORIES
- a. Manufacturer: Kohler, Lavatories; Chicago, Faucets; or as approved by PSU Project Manager.
 - b. Wall hung and countertop installs are acceptable.
 - c. Single handle faucets not allowed; provide two handle wrist blades.
 - d. Vandal proof faucets not allowed.
 - e. Metered faucets for lavatories are encouraged
7. COMMERCIAL/PUBLIC WATER CLOSETS AND URINALS
- a. Manufacturers:
 - i. Water Closets and Urinals: Kohler or as approved by PSU Project Manager.
 - ii. Manual Flushometers: Sloan Upper Cut or as approved by PSU Project Manager.
 - iii. Auto Flush: Technical Concepts or as approved by PSU Project Manager.
 - b. For new construction waterless urinals are preferred and should be selected to allow future conversion to wet urinals in case necessary.
 - c. Provide additional backing for wall hung water closets and urinals in order to support additional load.
 - d. Solid flow flushometer is preferred versus liquid. Motion detection is also acceptable. Confirm plumbing flushometer design with PSU Project Manager prior to specifying.
 - e. Water closet seat shall be commercial grade, open front, anti-microbial, solid white.
 - f. Water closets shall be as water efficient as possible and use 1.28 gallons per flush or less
 - g. For each major bathroom group (3 stalls or more), provide one bariatric water closet and carrier.
8. COMMERCIAL SINK GARBAGE DISPOSERS
- a. Garbage disposers are discouraged. Garbage disposers should only be used if approved by PSU Project Manager.
 - b. Manufacturer: InSinkErator or as approved by PSU Project Manager.
 - c. Provide switches, controls, solenoid and flow control valves, vacuum breakers and appropriate sink or cone attachments.
9. NON-RESIDENTIAL INDIVIDUAL SHOWER UNITS (work in development)
10. RECREATION SHOWER UNITS (work in development)
11. RESIDENTIAL LAUNDRY SINKS
- a. Manufacturer: Mustee or as approved by PSU Project Manager.
 - b. Two bowls are preferred.
12. RESIDENTIAL LAVATORIES
- a. Manufacturer: Kohler, Lavatories; Faucets - Symmons S-20-2, Chicago, Moen; or as approved by PSU Project Manager.
 - b. Faucet shall have means to prevent HW and CW cross over, i.e. check valve.

PORTLAND STATE UNIVERSITY
DESIGN AND CONSTRUCTION STANDARDS

- c. Provide InSinkErator, stainless steel

13. RESIDENTIAL TUB-SHOWER UNITS

- a. Manufacturers:
 - i. Tub and shower: Fiber-Fab or as approved by PSU Project Manager.
 - ii. Drain and overflow: Watco or as approved by PSU Project Manager.
 - iii. Shower drains: JackRabbit or as approved by PSU Project Manager.
 - iv. Mixing valve: Delta Universal R10000 or as approved by PSU Project Manager.
 - v. Trim: Delta T3020 or as approved by PSU Project Manager.
 - vi. Tub spout: Delta RP5834 or as approved by PSU Project Manager.
- b. Mixing valve shall have integral service stops.

14. RESIDENTIAL ACCESSIBLE TUB-SHOWER UNITS

- a. Manufacturers:
 - i. Shower system: Symmons Temptrol II or as approved by PSU Project Manager.
 - ii. Roll-in and Transfer shower: Fiber Fab or as approved by PSU Project Manager.
- b. Shower system shall include mixing valve, shower head with arm and flange, lever diverter, wall/hand shower with flexible metal hose, and slide bar.
- c. Mixing valve shall have integral service stops

11. RESIDENTIAL ACCESSIBLE TUB-SHOWER UNITS

- a. Manufacturers:
 - i. Water Closet (Tank Type): Niagara Stealth, American Standard Pressure Assist or as approved by PSU Project Manager.
 - ii. Water Closet (Non-tank) and Urinals: Kohler or as approved by PSU Project Manager.
 - iii. Flushometer Valve for Non-tank toilets: Gerber Top Spud or as approved by PSU Project Manager.
 - iv. Flushometer Valve for Urinals: Sloan or as approved by PSU Project Manager.
 - v. Toilet Seat: Church 100ec and 585ec or as approved by PSU Project Manager.
- b. Provide Solid vs liquid type flushometer

15. RESIDENTIAL SINK GARBAGE DISPOSERS

Residential sink garbage disposers are discouraged. Residential disposers should only be used if approved by PSU Project Manager.

16. RESIDENTIAL WASHER BOXES

- a. Manufacturer: Wirsbo, Sioux Chief or as approved by PSU Project Manager.
- b. 1/4 turn valves, angle stops, and lead free.

17. RESIDENTIAL ICE MAKERS

- a. From wall to fridge, use stainless steel braided or copper hose.
- b. Aqua pure filters are preferred.

END OF SECTION

PORTLAND STATE UNIVERSITY
DESIGN AND CONSTRUCTION STANDARDS

SECTION 23 – **HEATING, VENTILATING, AND AIR CONDITIONING**

A. MECHANICAL SYSTEMS

1. GENERAL

- a. Ensure code required and adequate clearance for ease of accessibility to systems/equipment for repair, maintenance, or replacement
- b. Select equipment and supplies are locally available when possible.
- c. Vibration and noise must be considered in design. Install systems where it causes the least disturbance. Otherwise use noise and/or vibration dampening. If duct boots between spaces are necessary, include adequate offset and insulation.
- d. Install ample valves and unions to isolate equipment, main lines, and branch lines for unobtrusive maintenance operations. Bypasses shall also be provided at incoming water service entry and at items requiring maintenance.
- e. Testing and Balancing of air and water systems shall be performed prior to the conclusion of each project. All filters shall be replaced, strainers cleared, and equipment started up prior to balancing.
-  f. All systems shall be designed to optimize energy efficiency, improve indoor environmental quality, and assist in achieving credits in the LEED rating system. Refer to Energy Conservation Guidelines (Appendix 26.1).

2. VALVES

- a. Manufacturer: Zwick or as approved by PSU Project Manager.
- b. If Mueller butterfly valves are installed, a three-year parts and labor warranty needs to be provided.
- c. Valve tags are required for all valves.

3. METERS AND GAUGES

- a. Manufacturers:
 - i. Steam Meter: Cadillac Vortex Shedding Meter or as approved by PSU Project Manager.
 - ii. Chilled Water Flow Meter: Onicon (non-turbine type) or as approved by PSU Project Manager.
 - iii. Gas Meter: Sensus or as approved by PSU Project Manager.
 - iv. Digital Electrical Sub-Meter: Siemens DEM or as approved by PSU Project Manager.
- b. All piping components shall be rated for the service, pressure, and temperature as called out by design engineer.
- c. Provide manual temperature and pressure gauges directly in the piping on the inlet and outlet of hydronic equipment. Provide additional gauges as required.
- d. All gauges to have shut-off valve in order to remove/replace/test.

4. HANGER SUPPORTS AND HANGERS

- a. All hangers, rods, clamps, protective shields, components, and hanger accessories shall be hot dipped galvanized.
- b. Seismic restraints, anchorage and reinforcements shall be provided for all piping and designed to withstand forces generated by earthquake movements.

PORTLAND STATE UNIVERSITY
DESIGN AND CONSTRUCTION STANDARDS

- c. Support all vertical risers/piping per floor. Support all horizontal piping per code and schedule. Floor penetrations must be sleeved and sleeve must extend a minimum of 1" above finished floor.
 - d. Provide roller guides, anchors, and expansion joints as specified by structural/mechanical engineer.
5. INSULATION
- a. For steam, condensate return, and boiler, feed water piping insulation shall be molded glass fiber with aluminum jacket. For chilled water, provide polyisocyanurate foam insulation with PVC jacket. Provide blue jacket color for chilled water systems.
 - b. Provide reusable insulation blanket around valves, pumps, and piping specialties.
 - c. Pre-manufactured insulation elbow shall be used for piping insulation. Foam fill of elbow is unacceptable.
6. ELECTRIC HEAT TRACING
- a. Electric heat tracing shall be installed on exterior piping that is subject to freezing.
 - b. Label pipe indicating heat tracing as well as which circuit and panel it is fed from.
 - c. For large systems provide a front end controller.
 - d. Use 120VAC system.
7. LIQUID FUELING SYSTEMS
- a. If using an automated fueling system, the system must have a fuel return system that is capable of handling all of the feed fuel. Additionally, it must have secondary containment, automatic shut-off and alarm devices, manual re-set, and a gravity fuel return system.
 - b. Intertie automated fueling system with building automation system.
 - c. The liquid fueling system must be tested prior to start up with applicable medium (e.g. diesel).
 - d. Place sight glass on outside of all fuel storage tanks in order to confirm fuel levels.
 - e. Leak detection system on any underground storage tanks is required.
8. FACILITY NATURAL GAS SYSTEMS
- a. Natural gas pressure reducing valve (PRV) shall have test ports on each side of valve. Provide a dedicated PRV for each piece of equipment. Design flows shall be in the middle of the PRV spring range.
 - b. If piping is exterior to building, it shall be finished with a weather resistant finish.
 - c. Natural gas piping greater than 1" in diameter is required to be rigid piping and painted bright yellow.
 - d. A seismic shut-off valve is required at the building's main gas feed. The seismic shut-off valve must have a 3-valve bypass.
 - e. Gas meters must have a bypass.
 - f. Piping must be tested and approved by City of Portland prior to start up.
 - g. Yellow armaflex can be used for the last two feet length of gas connections less than 1".
 - h. Steel pipe needs to be seamless.
9. HYDRONIC PIPING
- a. Hydronic piping shall be copper or black iron. Plastic piping is not allowed.

PORTLAND STATE UNIVERSITY
DESIGN AND CONSTRUCTION STANDARDS

- b. Hydronic piping must have isolation valves and unions at all pieces of equipment. Unions shall be placed at applicable locations for equipment replacement.
 - c. For radiant heating panels, use manufacturer's factory rated hose with swivel end (factory assembled). Field quick connects are not allowed.
 - d. Provide dielectric connections as required.
 - e. Prep, clean, and store piping per the design engineer's direction and to ensure no unneeded chemical/bacterial contamination.
 - f. Grooved systems, except for steam piping, are allowed.
 - g. Where pipes penetrate floors, sleeves around pipes shall extend a minimum of 4" above floor level to act as containment around the penetration.
 - h. Provide drains at low points. Slope piping toward drains as required.
 - i. Ports for corporation stops need to be located as close to the top of pipe as possible and not beyond 22.5 degrees in either direction.
 - j. Provide vents at all high points of the system.
10. STEAM AND CONDENSATE PIPING
- a. Steam piping and gravity condensate return piping shall be schedule 40 steel pipe. Pumped condensate return piping shall be scheduled 80 minimum.
 - b. Contractor to adhere to preparation and storage methods as specified by mechanical engineer.
 - c. Contractor to adhere to flushing and cleaning methods as specified by mechanical engineer.
 - d. Neutralize and chemically treat steam piping as specified by Portland State University chemical treatment vendor.
 - e. All new installed steam header piping is designed for future conversion to 150 psig system operating at 125 psig.
11. CHLORINATION SYSTEM FOR POOLS
- a. Manufacturer:
Chlorine Feed System: Pulsar One or as approved by PSU Project Manager.
 - b. All Seals must be Teflon. Rubber is not allowed.
 - c. Use liquid chlorine for pools.
12. AIR AND DIRT SEPARATOR'S
- a. Manufacturer: Spirotech or as approved by PSU Project Manager.
 - b. Consider chilled water loops, condenser water loops (closed and open), and steam condensate return systems. Required for chilled water and boiler plants.
13. STEAM TRAPS
- a. F&T Traps are preferred.
 - b. Provide union or flanged connections at both ends.
 - c. Provide gate valve and strainer at inlet and gate valve. Check valve at discharge.
14. CHEMICAL TREATMENT
- a. Contractor shall maintain chemicals in system for 3-months after installation.

PORTLAND STATE UNIVERSITY
DESIGN AND CONSTRUCTION STANDARDS

- b. When possible, do not mix vendors and products on the same piece of equipment/station.
 - c. Mount information at chemical stations shall include products is being used, chemical levels, system served, etc. O&M manuals need to be available at station.
 - d. Provide adequate space for corporate stops in piping systems.
 - e. Water treatment systems for boiler water systems shall be included in the Contract Documents. Systems controlled by metering pumps feeding chemical from barrels are preferred. Prefer Milton Roy metering pumps or as approved by PSU Project Manager.
 - f. Boiler water steam must have a de-oxygenator (de-aerator) on the system for both large and small boilers.
 - g. For new equipment the Contractor is responsible for proper passivation and chemical treatment for the first three months after start up.
 - h. Before tying into PSU system loops, contractor must collect before and after samples at different points and provide documentation to owner.
 - i. Each closed loop must have a sampling port placed before and after a major piece of equipment.
 - j. When sampling, first allow water run clear and then take the sample.
 - k. For chemical delivery provide PEX or schedule 40 PVC piping with heat fusion connections.
 - l. Chemical treatment must be considered during design. Training must be included in the bid.
 - m. Preferred liquid feed for cooling towers, closed loops, boilers, fountains and pool chlorinators.
 - n. Pot feeders are good for immediate adjustments and should be kept in the design.
15. IDENTIFICATION
- a. Comply with ANSI A13.1 for lettering size, length of color field, colors, and viewing angles of identification devices.
 - b. Mechanical piping shall be labeled with flexible, vinyl film tape with pressure sensitive extra strength adhesive backing. Mechanically fastened piping is acceptable as well. Provide manufacturer label for direct bury applications when required.
 - c. Include flow direction for both air and water systems
 - d. If pipe is insulated, note if polypipe or plastic pipe is being used on insulation jacket.
 - e. Provide a valve schedule as a part of the submittal package. Upon approval from owner, these shall be framed and installed appropriately in building mechanical spaces upon completion of project. Valves shall be tagged in the field per schedule.
 - f. Provide ceiling tile labels for equipment (labeled orange) and hydronic valves (labeled Green). Labels shall be machine generated, adhesive backed with black letters, clear tape.
 - g. Coordinate with facility maintenance personnel to ensure consistency with the existing system.
 - h. Tag balancing valves with GPM or CFM and valve position after balancing is completed.
 - i. Identify equipment and control panels with plastic nameplates riveted to equipment body.
 - j. Provide stenciled signs on each access door and housing, indicating purpose of access.

PORTLAND STATE UNIVERSITY
DESIGN AND CONSTRUCTION STANDARDS

16. COMMISSIONING

- a. A commissioning plan and report must be submitted.
- b. Contractor shall submit one electronic and five (5) hard copies of commissioning documents to Project Manager.
- c. Commissioning agent needs to review submittals and O&M's.
- d. Commissioning agent shall coordinate training of PSU personnel.
- e. There must be a mandatory review of system/equipment within one year of building turn over.
-  f. For projects seeking LEED certification, compliance with LEED definition of "Enhanced Commissioning" must be required.

B. HVAC SYSTEMS

1. GENERAL

- a. Ensure code required and adequate clearance for ease of accessibility to systems/equipment for repair, maintenance, or replacement.
- b. All HVAC systems shall be installed per code, ASHRAE, SMACNA, and industry standards.
- c. Identify all HVAC piping and equipment with stamp tag and flow direction. Color of label shall follow Code.
- d. Ensure as much as possible adequate clearance for ease of accessibility to systems/equipment for repair, maintenance, or replacement.
- e. Commissioning, testing, and balancing of air systems shall be performed prior to the conclusion of each project.
-  f. All systems shall be designed to optimize energy efficiency, improve indoor environmental quality, and assist in achieving credits in the LEED rating system. Refer to Energy Conservation Guidelines (Appendix 26.1).

2. HANGERS, SUPPORTS AND ANCHORS

- a. Hanger rod shall be steel, galvanized, threaded on both ends, or continuously threaded. Hanger spacing shall follow guidelines per the Oregon Mechanical Specialty Code and SMACNA standards.
- b. Duct stiffeners are preferred over additional supports in the appropriate locations. Stiffeners shall be installed outside of the airstream.
- c. Seismic bracing and vibration isolation requirements shall be analyzed by a specialized design professional.

3. TESTING, ADJUSTING AND BALANCING

- a. Coordinate testing and balancing (TAB) work with other trades when applicable (e.g. fire life safety, BAS controls, commissioning agent, etc).
- b. TAB provider shall be NEBB or AABC certified.
- c. TAB shall be performed under simulated normal building operating conditions with doors and windows closed, ceiling's installed, etc.
- d. New filters shall be installed before balancing.

PORTLAND STATE UNIVERSITY
DESIGN AND CONSTRUCTION STANDARDS

- e. Prior to TAB, examine systems and system components and verify their operation and accessibility.
- f. Systems shall be flushed of debris prior to balancing. Pete's plugs are required across major water balancing components.
- g. Provide one electronic copy, and 3 hard copies of the balancing report. Include equipment calibration reports.
- h. Mark on volume balancing dampers the final balancing settings/position.

4. INSULATION

- a. Provide flexible glass fiber, commercial grade insulation with factory applied reinforced aluminum foil jacket. Provide ductwork insulation accessories for complete installation.
- b. All ductwork installed outside shall be internally insulated.
- c. Contractor shall make shop available for owner review of duct fabrication and duct liner installation.
- d. All fan enclosures shall be insulated.
- e. All supply, return, and outside air ductwork shall be insulated.

5. DUCTWORK

- a. All ductwork shall be manufactured and installed per SMACNA standards.
- b. Seal joints and reinforce ducts to prevent buckling, vibrations, and unnecessary noises. Fabricate ductwork in order to eliminate all sharp corners.
- c. Fabricate and install ductwork fittings with the least amount of pressure drop.
- d. Duct systems constructed using duct board will not be accepted.
- e. Use Pittsburg clamping system or as approved by PSU Project Manager.
- f. Flex duct longest lengths shall be 5 feet prior to termination at diffuser.
- g. Ductwork used to exhaust chemical fume hoods and special exhaust systems must be welded and stainless steel or PVC coated.
- h. Supply air and general exhaust ductwork shall be galvanized steel.
- i. The Contract Documents shall require that new duct systems are cleaned and inspected for cleanliness prior to energizing air-handling equipment.
- j. Label all ductwork based on its service (e.g. supply air, return air, hazardous exhaust, general exhaust, etc).
-  k. At the beginning of any remodeling work, cover all return air grilles with filtering material to prevent accumulation of dust in existing duct system.

6. AIR DUCT ACCESSORIES

- a. Manufacturer: Ruskin, Greenheck, or as approved by PSU Project Manager.
- b. Volume dampers shall be no lighter than 18 gauge and reinforced to prevent vibration.
- c. Control dampers shall be opposed blade and air foil type. For exhaust and outside air dampers, blade edges must be sealed to prevent leakage. Leakage testing shall be required to ensure compliance with manufacturer's performance criteria.
- d. Dampers that are greater than 25 ft sq. in area shall be installed in two or more sections.
- e. Install safety screen where fan inlet/outlet or moving parts are exposed.

PORTLAND STATE UNIVERSITY
DESIGN AND CONSTRUCTION STANDARDS



- f. Install flexible duct connectors to air handling units. Provide weather guard when installed outside.
7. AIR OUTLETS AND INLETS
- a. Manufacturer: Titus, Price, or as approved by PSU Project Manager.
 - b. Provide gooseneck or rain cap to prevent water intrusion for outdoor installation.
 - c. In moist environments (e.g. locker rooms), provide aluminum construction and stainless steel mounting hardware.
 - d. Provide integral balancing dampers where balancing dampers are not already specified.
 - e. For door louvers, minimum steel thickness is 20 gauges.
8. FUME HOODS
- a. When there is more than one fume hood in a room, perform backflow verification test (i.e. if one fan shuts off ensure no backdraft).
 - b. New fume hoods shall be standard products from a manufacturer, acceptable to laboratory use, and specifically approved by the PSU Environmental Safety Office. All fume hood designs should demonstrate containment of tracer gas less than 4.0 AM 0.05 according to ASHRAE Test Standard 110-1995. *AIHA Z9.5-1995*.
 - c. All hoods shall be equipped with sash stops on vertical rising sashes allowing the sash height to be set at 18 inches during routine use, unless otherwise advisable.
 - d. High performance fume hoods shall be used, unless otherwise advisable. High performance hoods shall have a 60 FPM face velocity at 18" sash height.
 - e. In those cases where high performance fume hoods cannot be used, constant air volume hoods with bypass air openings shall be used. The bypass air opening shall progressively uncover as the sash is lowered to its lowest point.
 - f. New hoods should be mounted on a chemical storage cabinet.
 - g. Interior fume hood surfaces shall be rigid, safe, and constructed of corrosion resistant, non-porous, non-combustible materials, appropriate for the intended use.
 - h. The interiors of hoods shall have smooth and impermeable interior surfaces with rounded corners. Interior surfaces shall be free of cracks and crevices to allow easy cleaning.
 - i. Laboratory hoods shall be provided with a means of containing spills.
 - j. A horizontal bottom airfoil inlet at the front of the hood shall be provided.
 - k. The rear and top interior of the hood shall be furnished with baffles to provide at least two, preferably three, slots. Baffles should be continuous.
 - l. A quantitative airflow sensor and an audible and visual alarm shall be permanently installed and located so that the display is visible to the user from the front of the fume hood.
 - m. Light fixtures shall be of the fluorescent type and replaceable from outside the hood. Light fixtures shall be displaced or covered by a transparent, impact resistant, vapor tight shield to prevent vapor contact. Hood lighting shall be provided by UL listed fixtures. If located within the hood interior, the fixtures shall meet the requirements of NFPA 70 (National Electrical Code) sections appropriate to hazardous atmospheres.
 - n. The valves, electrical outlets, and switches for utilities serving hoods shall be placed at readily accessible locations outside the hood. All shut-off valves shall be clearly labeled.
 - o. Plumbing (e.g., vacuum lines) should exit the sides of the fume hood and not the bench top.

PORTLAND STATE UNIVERSITY
DESIGN AND CONSTRUCTION STANDARDS

- p. Post instructions on how to use the hood per chemical requirements for enclosed spaces and fume hood manufacturer recommendations.
- q. When cup sinks are provided they are to be integral to the fume hood and provided with backflow prevention. Cup sinks to drain to acid waste system.

C. MECHANICAL EQUIPMENT

1. GENERAL

- a. Ensure code required and adequate clearance for ease of accessibility to systems/equipment for repair, maintenance or replacement.
- b. All equipment to be installed per code and industry standard.
- c. All equipment to be commissioned upon completion of project.
-  d. Vibration and noise must be considered in design. Install systems where it causes the least disturbance. Otherwise use noise and/or vibration dampening.
- e. For mechanical equipment located outdoors, the design shall provide features to facilitate winterization of such equipment.
- f. If equipment is elevated off of roof, provide platform in order to meet code required access and clearances.
-  g. Mechanical room floors shall be protective, water resistant, and coated and sealed with a sustainable product.
- h. Contractor shall provide required equipment data for PSU deferred maintenance software.
- i. Provide DDC controls and program into PSU building automation system (BAS) for all mechanical equipment.
- j. Provide concrete housekeeping pads when applicable.
- k. Ensure that replacement parts and components are available locally.
-  l. All systems shall be designed to optimize energy efficiency, improve indoor environmental quality, and assist in achieving credits in the LEED rating system. Refer to Energy Conservation Guidelines (Appendix 26.1).

2. PACKAGED ROOF TOP / SPLIT SYSTEM - HVAC UNITS

- a. Manufacturer: Trane, Carrier, Reznor, Mcquay/Daikon, or as approved by PSU Project Manager.
- b. Split system and stand-alone condensers shall be tube and fin type.
- c. Gas heat is preferred over electric strip heat.
- d. Provide NEMA 4R enclosure for VFD's, electrical/controls components, control panels, etc.
- e. Contractor shall provide required structural anchorage per structural engineer requirements. Provide vibration isolation in order to meet specified structural and/or noise/vibration criteria.
- f. Provide electrical receptacle at or near equipment.
- g. Provide walk-off pads around equipment on roof.
- h. Roof curbs shall be pre-manufactured and provided by HVAC unit manufacturer.
- i. Ensure that roof warranty will be maintained/adhered to.

PORTLAND STATE UNIVERSITY
DESIGN AND CONSTRUCTION STANDARDS

- j. Outside air intakes need to be provided with water guard and bird screen.
 - k. City of Portland design review requirements shall be considered during design.
3. VARIABLE FREQUENCY DRIVES (VFD) AND MOTORS
- a. Manufacturers:
 - i. VFDs: ABB or as approved by PSU Project Manager.
 - ii. Motors: Baldor or as approved by PSU Project Manager.
 - b. VFDs shall have no bypass and be enclosed in NEMA 4R rated waterproof enclosure if installed outside.
 - c. Motors shall be high efficiency, inverter duty rated, and must have a shaft grounding ring when a VFD is installed. VFD and motor shall be grounded per manufacturer recommendation.
 - d. Perform an AMP draw after installation, results shall be included in start-up report and reported to owner.
 - e. Install disconnect within line of sight of VFD.
 - f. Design equipment so that load does not cause motor to run in its service factor. Maximize amperage of motor.
 - g. If replacing a motor, stay within engineering limits of the equipment.
 - h. Motor must be high efficiency and waterproof if in an exterior location.
 -  i. Bearings to be serviceable, accessible, and grease-able. Grease shall be a sustainable product.
 - j. If VFD is not provided, motor shall be multi-speed.
4. CUSTOM AIR HANDLING UNITS
- a. Manufacturer: Hunt Air, Mcquay/Daikon, Trane, York, or as approved by PSU Project Manager.
 - b. Require close coordination between air handling unit manufacturer, structural engineer, mechanical engineer, electrical engineer, acoustical engineer, and architect to ensure that unit structural support and mechanical and electrical connections are fully covered and responsibilities are fully defined.
 - c. Units having arrays of multiple small fans are encouraged.
 - d. HVAC fans shall be high efficiency when applicable.
 - e. Allow clearances to pull shaft, motor, and other fan components.
 - f. A light and receptacle shall be provided in enclosure. For outdoor units, provide adequate lighting and access for service and maintenance needs.
 - g. Roof off of enclosure to shed water. Provide floor drain in enclosure and route to roof drain.
 - h. If AHU is shipped in multiple sections, provide water proof joints between sections.
 - i. For HVAC fans, provide pressure safety switch on discharge side of fan in order to protect equipment.
 - j. Provide heat recovery when viable.
 - k. Provide two position valves at all coils for shut-off. Control valves shall not be used for shut-off.

PORTLAND STATE UNIVERSITY
DESIGN AND CONSTRUCTION STANDARDS

- l. Provide signage at each access door into air handler that notifies personnel of potential safety hazard. Access door shall be lockable.
 - m. Provide filter bank. All filters shall be bag type at a minimum.
5. SPECIALIZED EXHAUST SYSTEMS
- a. Manufacturer:
Lab Exhaust: Greenheck, Strobic Air, or as approved by PSU Project Manager.
 - b. Fans exhausting laboratory fumes shall be designed as such and shall provide high velocity discharge that sends plume into atmosphere.
 - c. Exhaust fans shall be designed to exhaust the required media (e.g. kitchen/grease fumes, paint fumes, etc). Fan material and components shall be spark proof when applicable.
 - d. All laundry exhaust systems shall be installed with lint filter and constructed per Oregon Mechanical code.
 - e. All painting application shall be installed with industry standard paint booth and specialized HVAC system.
 - f. Wood shops shall be equipped with appropriate dust collection system, specialized exhaust system, and fire suppression requirements.
 - g. All specialized exhaust fans shall be controlled, monitored, and alarmed via building automation systems.
6. AIR TERMINAL UNITS
- a. Manufacturer: Titus, Trane, Siemens (lab applications only) or as approved by PSU Project Manager.
 - b. Heavy duty bearings shall be specified for fan terminal units.
 - c. No flex on the inlet of a terminal box.
 - d. Provide working clearances around terminal unit and piping components.
 - e. Terminal Unit shall only be supported from building structure.
 - f. All air terminal units must have disconnect for fan powered units within line of sight of control panel.
 - g. Provide pipe kits and flexible connections to re-heat coil.
 - h. Terminal units shall be labeled at drop ceiling.
 - i. Provide fume hood exhaust, general exhaust, and supply air when air terminal units are installed in a lab environment.
 - j. All entering and leaving ductwork shall meet manufacturer's requirement to reduce turbulence and allow accurate measurement and control.
7. CONDENSING AND HEATING BOILERS
- a. Manufacturer: RayPak, Cleaver-Brooks, Aerco, AO Smith, or as approved by PSU Project Manager.
 - b. When applicable, review design with boiler inspector. Contractor is required to provide final boiler permit and inspections from boiler inspector.
 - c. For domestic water heating, install separate back up electric hot water heater system when steam domestic hot water heater is the existing source.
 - d. For condensing boilers, a condensate neutralization station to be provided.

PORTLAND STATE UNIVERSITY
DESIGN AND CONSTRUCTION STANDARDS

- e. Provide isolation pad between concrete and boiler to prevent electrolysis.
 - f. Condensing boilers shall be piped reverse return for multi-unit installations.
 - g. Boilers need to be UL listed and stamped accordingly.
 - h. Boilers shall be equipped with a dedicated city water make-up with gate valve in order to fill up boilers quickly.
 - i. Boilers shall be installed with hose bib in order to drain down.
 - j. Provide seismic restraint/anchorage per structural engineer requirements.
 - k. Burners shall be high efficiency (85%-98% depending on application) and linkage-less when available.
 - l. Flues shall terminate above roof line and be provided with rain cap.
 - m. Operating pressure of all system components shall be consistent throughout (e.g. storage tanks, condensate tanks, expansion tanks, T&P valves, etc).
 - n. Emergency electrical shut-off to be clearly labeled, red, and installed at the main point of egress. Provide cover.
8. CENTRAL PLANT BOILERS
- a. Manufacturer: Cleaver Brooks, Hurst, Johnston, Burnham, Miura, or as approved by PSU Project Manager.
 - b. Boilers shall be UL listed and stamped accordingly. Boilers shall be constructed for 150 psi operation; actual operation shall be 15 psi.
 - c. Boiler shall be provided with economizer.
 - d. Boilers shall run off of natural gas and No. 2 oil.
 - e. Tubes shall be cleanable from either front or back of boiler.
 - f. OSHA-approved platforms and ladders shall be provided to access boiler.
 - g. Burners shall have a minimum standard efficiency of 85%. When available, burners shall be linkage-less and have a parallel positioning system.
 - h. Emergency electrical shut-off shall be clearly labeled red and installed at the main point of egress. Provide cover.
 - i. Boiler(s) to be provided with control panel which can be controlled via PSU BAS system.
 - j. Boiler shall be equipped with low NOx control, O₂ trim system, and VFD on blower.
 - k. Central plant boilers shall operate in conjunction with a spray type de-aerator system. De-aerator tank shall be installed with magnesium rod to prevent corrosion.
 - l. Dirt separator shall be installed on central plant condensate return systems.
 - m. Wet-back design is preferred.
 - n. Boiler shall be seismically anchored per structural engineer's design.
 - o. In multiple boiler installations provide means to prevent carry over via the main steam header.
 - p. Chemical treatment equipment and program to meet PSU standards.
9. HEAT EXCHANGERS
- a. Heat exchangers shall be properly rated for the flow and the media.
 - b. Shut-off valves shall be directly up/downstream of all inlets and outlets.

PORTLAND STATE UNIVERSITY
DESIGN AND CONSTRUCTION STANDARDS

- c. Provide isolation drain down valves.
- d. Where possible, provide a hose bib and floor drain near plate and frame heat exchangers in order to clean and service.

10. PACKAGED WATER CHILLER

- a. Provide Glycol or heat trace and low ambient control for outdoor installations.
- b. When viable, provide extended warranty on compressor.
- c. Chemical treatment equipment and program shall meet PSU standards.
- d. Packaged water chiller shall be provided for specialized purpose (e.g. academic research, server room cooling, etc). Campus chilled water shall be used in all other cases and when available.
- e. Authority having jurisdiction shall review and approve the use of domestic city water for cooling needs. If approved, this water shall be metered.

11. CENTRAL PLANT CHILLER

- a. Manufacturer: Trane, Mcquay/Daikon, Carrier, or as approved by PSU Project Manager.
- b. Provide 10-year extended warranty on compressor.
- c. Chemical treatment equipment and program to meet PSU standards
- d. For large chillers, provide a jib crane, rail system, or other in order to provide maintenance to chiller.
- e. A refrigerant Leak Detection System shall be required.
-  f. Refrigerant shall be specified to assist in achieving Energy and Atmosphere credits in the LEED rating system.
- g. Provide adequate clearances in order to clean tubes on both ends of chiller.
- h. Provide dirt/air separator.

12. COOLING TOWERS

- a. Manufacturer: Evapco or as approved by PSU Project Manager.
- b. Provide stainless steel basin construction. Supply sump heater for basin if tower is in year round operation.
- c. Cooling tower to be provided with VFD and a vibration limit switch. Provide ultra-quiet fan operation accessory when noise is a consideration.
- d. Provide side stream filter.
- e. Provide fan guard, safety railings, and ladder from grade to fan deck.
- f. Design access to the basin and means to pull the motor.
- g. Prior to specifying chemical treatment systems, consult with PSU Project Manager. See Section 23.A.14 for additional information.
- h. Provide jib arm to pull the motor.
- i. Cooling tower and cooling loop shall be designed to match chiller capacity.
- j. Open towers shall be located external to buildings. Roof-mounted units are preferred.

13. PUMPS

- a. Manufacturer: Paco, Bell and Gossett, BFS Industries (Condensate Pumping Stations), or as approved by PSU Project Manager.

PORTLAND STATE UNIVERSITY
DESIGN AND CONSTRUCTION STANDARDS

- b. For chilled and condenser water pumps, pump seals shall be Unitized EPR/SiC/SiC. Rated for 1000 ppm undissolved solids.
- c. Impeller shall be silicon bronze, fully enclosed, keyed to shaft. Trim impeller to maximum flow rate without overloading the motor.
- d. Shaft shall be stainless steel.
- e. Condensate pumping stations shall come equipped with a welded steel tank. Motors are not required to have a VFD. Ensure means to fully drain tank.
- f. Sump pumps shall be equipped with a mechanical float and alarmed for high levels.
- g. Sewage injection pumps shall have a grinder on the impeller.
- h. Submit documentation that pumps are in proper alignment.
- i. Piping needs shall be independently supported prior to pump installation; the pump should not bear any of the weight.
- j. Provide isolation valves, check valves, and unions or flanges for maintenance and replacement purposes.

14. IDENTIFICATION FOR MECHANICAL EQUIPMENT

- a. Provide stickers for identification rather than stenciling.
- b. All above ceiling equipment shall be marked using label tape markers affixed to the ceiling grid, or similar methods.

D. MECHANICAL INSTRUMENTATION AND CONTROLS

1. GENERAL



- a. PSU's centralized control system is Siemens Apogee. All new control systems shall interface accordingly.
- b. Contractor shall participate and provide a 50% and a 90% review of control drawing's and devices. As-builts shall be delivered in PDF and AutoCAD format.
- c. All new work shall comply with NEC and all local codes.
- d. Throughout the creation of the instrumentation and controls construction specifications, contact PSU controls team for review.
-  e. All systems shall be designed to optimize energy efficiency, improve indoor air quality, and assist in achieving credits in the LEED rating system. Refer to Energy Conservation Guidelines (Appendix 26.1).

2. COMMUNICATION

- a. Wireless devices are not preferred but shall be approved by PSU Project Manager on a case by case basis.
- b. Communication to 3rd party devices shall be BACNET. A third party device that is P1 or FLN compatible is acceptable.(e.g. Onicon BTU meters, ABB VFD's)
- c. The design of the BAS shall support networking of operator workstations and building controllers. The network architecture shall consist of three levels: Management Level Network (MLN) for all operator workstations and servers, Building Level Network (BLN) for primary DDC controllers, and Automation Level Network (ALN, aka FLN) for terminal equipment application specific controllers.

3. PROGRAMMING

PORTLAND STATE UNIVERSITY
DESIGN AND CONSTRUCTION STANDARDS

- a. In lead/lag scenarios when a start command is issued and the equipment fails to run, do not remove the start command from the failed equipment.
 - b. Limit the use of the resident point, "\$loc's". When they are used, create a virtual point that corresponds to the value of the "\$loc".
4. GRAPHICS
- a. All points shall be shown on graphics.
 - b. On graphics of major/critical equipment, provide a direct link to the sequence of operations and IOM. For terminal equipment and application specific controllers, provide a link to the application manual.
 -  c. Wherever feasible, online dashboard applications must be considered in new buildings, renovations, and remodels. If these applications are used, the system shall be web based and not directly tied into PSU's network.
 - d. All PC monitors shall be of flat panel type and shall support a minimum display resolution of no less than 1280 x 1024 pixels. The display shall have a minimum of 19" visible area in diagonal measurement. Separate controls shall be provided for color, contrasts and brightness. The screen shall be non-reflective.
5. DEVICES
- a. All actuators shall be electronic. Pneumatic devices must be pre-approved.
 - b. For chilled water and condenser water flow sensing, no turbine type meters are allowed. Provide Onicon Model F(B)-3500 or as approved by PSU Project Manager.
 - c. All enclosures shall be labeled with a minimum of node name, system name, and power source.
6. LOW VOLTAGE WIRING
- a. Provide color coded wiring per PSU Standard. Wiring shall be labeled at each end with point name and address.
 - b. Contractor shall provide all supports for wiring. Wiring can't be supported from existing conditions (e.g. Ceiling grid hangers, sprinkler pipe hangers).
 - c. Communication wiring shall be 24 AWG, twisted pair, shielded, and low capacitance.
 - d. Power for BAS shall have dedicated circuits.
 - e. All systems requiring interlock wiring shall be hardwired interlocked and shall not rely on the BAS programming to operate (e.g. emergency generator to fuel oil pump interlock, emergency generator damper interlock, etc).
 - f. All safeties shall be hardwired. Safeties shall not rely on the BAS to act and shutdown systems upon detection of a failure, safety limit, or alarm.
-  7. COMMISSIONING
- a. Provide point to point check out sheets prior to commissioning activities verifying functionality of each device.
 - b. The contractor's technical support team (including programmer) personnel shall be consistent throughout the project including commissioning.
 - c. After commissioning remove all unnecessary trending.

END OF SECTION

PORTLAND STATE UNIVERSITY
DESIGN AND CONSTRUCTION STANDARDS

SECTION 26 - **ELECTRICAL**

A. COMMON WORK RESULTS FOR ELECTRICAL

1. GENERAL

- a. All work shall be performed per the National Electric Code (NEC).
- b. Conduits feeding any branch shall have maximum of 40% fill.
- c. Each device box shall have grounding pigtails.
- d. All junction boxes shall be readily accessible per NEC definition and labeled with circuits and origin.
- e. Service disconnects shall be placed at all mechanical equipment locations.
- f. Maximum length of any flexible conduit shall be 6 feet.
- g. All devices shall be affixed with permanent label identifying panel of origin and circuit number.
- h. Occupancy sensors for lighting are recommended in all areas where appropriate according to use patterns.
- i. All panel boards and power distributions shall have copper bussing.
- j. All circuit breakers shall be bolt-on type.
- k. All Electrical Metallic Tubing connectors shall have insulated throat.
-  l. All EMT fittings of set screw types shall be steel with recycled-content.
- m. Provide expansion capability built in at the start of projects and not to be value-engineered.
- n. Provide metal clad cable in the wall with at least a conduit trunk line run into the suite with J boxes that we can allow for future for expansion.
- o. MC Cable is allowed for lighting fixtures.
- p. Conduit shall be installed from panels to junction boxes in individual rooms. MC Cable is allowed in room walls. The maximum run of any individual MC cable is 25 feet.
- q. For new buildings and major remodels, install full size panel with 42 circuit breaker spaces at minimum.
- r. All low voltage wiring shall be independently supported using appropriate pre-manufactured supports.
- s. Provide oversized raceways and boxes for future remodels. Provide metal boxes for floor installations. Plastic is not allowed.
- t. Underground ducts and raceways shall be rated for the type of installation.
- u. An overcurrent protective device coordination study is required for all new construction.

2. IDENTIFICATION



- a. Provide label trim plates.
- b. Color-code for different systems and by voltage:
 - i. Black, Red, Blue - 120/208
 - ii. Brown, Orange, Yellow - 277/480

PORTLAND STATE UNIVERSITY
DESIGN AND CONSTRUCTION STANDARDS







- iii. Gray - Neutral
 - c. Where a color system is in place, continue the same pattern as is.
 - d. Label main panels and switch gears to match plans.
 - e. Provide panel schedules in each panel.
3. SWITCH BOARDS AND PANEL BOARDS
- a. Manufacturer: Cutler-Hammer, Square D, or as approved by PSU Project Manager.
 -  a. Sub-metering of main building switchgear is required. Provide connection to PSU building automation system. Sub-metering shall be considered for other pieces of electrical gear in which it provides coverage for large portions of the building. On a project by project basis, CPC Director, FPM Assistant Director of Operations and Maintenance, CPO Utilities Management Director, Director for Housing and Residence Life, and Executive Director for Planning, Construction, and Real Estate will meet to determine sub-metering requirements.
 - b. For any transformer and switch enclosures, provide window to be located in the cabinet to allow for performance of infrared testing.
 - c. Provide double ended switch gear for the building's main 120V, 208/230V, 460V/480V electrical infrastructure. Enable maintenance to perform without building electrical shut down.
4. WIRING DEVICES – RECEPTACLES, SWITCHES
- a. Provide 20 Amp commercial grade receptacles.
 - b. Provide commercial grade switches.
 - c. Provide stainless steel for new construction. Otherwise, match existing.
 - d. For all 12.47 kV, cabling partial discharge sensors shall be installed. At the conclusion of installation, a partial discharge report shall be provided.
5. AUTOMATIC TRANSFER SWITCHES
- a. For emergency systems, design to match generator load.
 - b. For 12.47 kV infrastructure, design to meet building load(s). Transfer shall be seamless, with no power bumps.
 - c. All transfer switch status shall be wired into PSU building automation system.

B. LIGHTING

1. GENERAL

-  a. All lighting installations must meet or exceed Oregon Energy Code.
-  b. All light bulbs and fixtures shall be ENERGY STAR-rated whenever possible. Prefer high-efficiency florescent lights and fixtures. Refer to Energy Conservation Guidelines (Appendix 26.1).
-  c. Electrical and Lighting: Provide and install all code required minimum electrical and lighting items including, ADA door bells, occupancy sensors, GFI outlets, emergency lighting, illuminated exit signs, alarms, and strobes. Refer to Energy Conservation Guidelines (Appendix 26.1). All mounting heights shall be per ADA standards

PORTLAND STATE UNIVERSITY
DESIGN AND CONSTRUCTION STANDARDS

-  d. All purchased fluorescent lighting shall meet the LEED credit for Reduced Mercury in Lamps. The maximum target for the overall average of mercury content in lamps is 70 picograms per lumen-hour or less.
 - e. All mounting heights shall be per ADA standards.
 - f. Provide and install metallic conduit and boxes for all electrical, AV, and low voltage cabling. Conduit for Telco may be omitted above ceiling. All conduits shall be hidden in walls, floors, or ceilings.
 - g. For electrical box acoustics, provide sound insulation and gasketing at switch and outlet box locations at conference rooms and executive offices. Boxes in walls shall be staggered and not back to back.
 - h. Core drill and coordinate as required, including Telco and AV at large conference rooms, offices, and entry desks.
 - i. For Telco /AV, electrical installations shall provide power, conduit, and pathway for all cabling, including all wall boxes, conduit in walls, and core drilling. Coordinate as required for complete installation. All cable and conduit shall be concealed.
 - j. MC Cable is acceptable for lighting fixtures subject to the same limitations outlined in Section 26.A.1.p.
-  2. INTERIOR LIGHTING FIXTURES
- a. Prefer indirect type LED, unless another solution is determined appropriate for the space and does not exceed the energy use of LED fixtures.
 - b. Chose the most energy and cost efficient option for individual applications.
3. LIGHTING CONTROL DEVICES
- a. Manufacturer: Siemens or as approved by PSU Project Manager.
 -  b. Local occupancy sensors are required. They should be located adjacent to doors.
 - c. Segregate zones areas as small as suites or rooms.
 -  d. Individual light control systems (task lighting) shall be evaluated in an open office setting. Consider integrated and performance-based approach for evaluation.
4. NETWORKING LIGHTING CONTROLS
- a. Manufacturer: Siemens or as approved by PSU Project Manager.
 -  b. Design for daylight harvesting.
 - c. For public space, install step dimming.
 -  d. A system that is controlled at the individual fixture is preferred as opposed to a master lighting control panel.
5. LIGHTING, LIGHT POLES, AND STANDARDS
- a. Manufacturer: Hadco light pole with finial, fixture #S6014, Post SP6014; metal halide or as approved by PSU Project Manager.
 - b. Provide LED lights only. QL lighting is not allowed.
 - c. Provide timeless design with PSU green color for campus Park Blocks. Use true color rendition for visibility and safety - required for parking lots and walkways.
 - d. See attached drawing for park block lighting.

**PORTLAND STATE UNIVERSITY
DESIGN AND CONSTRUCTION STANDARDS**

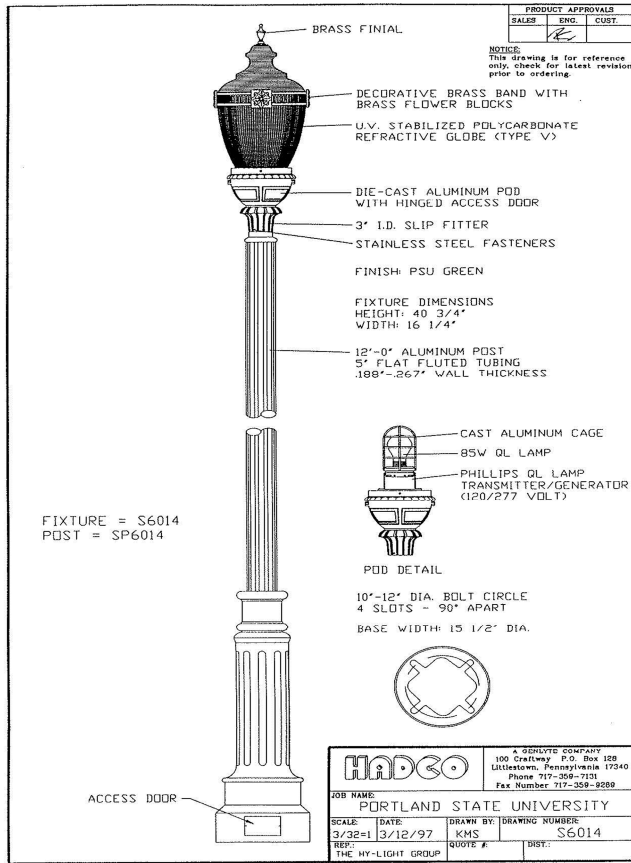

6. INSTALLATION

- a. No lighting, including street lighting, should be on a 480V system.
- b. Exterior lighting fixtures shall be watertight and shall have vandal-proof bases. For poles up to 15-20' high, hinged poles are preferred. Exterior lighting fixtures shall have heavy-duty guards.
- c. Fixture covers shall be UL-approved and regularly manufactured.
- d. Select consistent fixtures and lamps for use throughout buildings. Minimize models, types and systems.
- e. Electronic ballasts should be provided. Select items that are not going to become obsolete or difficult to obtain shortly after turnover to PSU.
- f. Interior High Output Fixtures must have accessible ballasts.
- g. When high light fixtures in auditoriums and gyms are used, consideration must be given to access, maintenance, and serviceability.
- h. Accessibility to ballasts must be provided when using compact fluorescent fixtures.
- i. Place power packs for switching in maintenance-friendly locations. These items are best located directly above banks of light switches, or in electrical rooms.

END OF SECTION

PORTLAND STATE UNIVERSITY
DESIGN AND CONSTRUCTION STANDARDS

SECTION 27 – **COMMUNICATIONS AND AUDIO VISUAL**

A. PHONE AND DATA

1. DESCRIPTION

- a. Refer to Appendix 27.1 – Structured Cabling Standards - for all phone and data installations
- b. Telephone and Computer Network Cabling -- by PSU Office of Information Technology (OIT). Coordinate as required for complete installation. All cable and conduit to be concealed where possible.

B. AUDIO VISUAL

2. DESCRIPTION

- a. Protect existing AV Equipment and Cabling.
- b. New AV Equipment and Cabling -- by PSU OIT. Coordinate as required for complete installation. All cable and conduit to be concealed where possible. Refer to OIT Structured Cabling Standards (Appendix 27.1) for additional information and requirements.
- c. Provide electrical installations as required.

3. LOCATION / INSTALLATION

- a. Equipment locations are to be on a case-by-case basis. Consult with OIT prior to all installations or purchase of equipment.

END OF SECTION

PORTLAND STATE UNIVERSITY
DESIGN AND CONSTRUCTION STANDARDS

SECTION 28 – **ELECTRONIC SAFETY AND SECURITY**

A. ACCESS CONTROL

- a. PSU currently has an exclusive contract for Lenel Security Management Software System for electronic access control in campus buildings. The system is managed by PSU Office of Information Technology (OIT), with the central station being monitored by Campus Public Safety Office staff. Installations, repairs or other work done on system must be performed by certified Lenel personnel and coordinated by OIT for Capital Projects & Construction design and construction projects. For further description, refer to Access Control standards (Appendix 28.1).
- b. Access control is required in all exterior doors (except ones that are exit only) and entry doors to office suites. Access control shall be considered and discussed with PSU Project Manager in conference rooms, break rooms, and study lounges.

B. SECURITY CAMERAS

- a. Design of new buildings and major renovations shall consider safety and visibility in order to limit the need for security cameras. However, safety standards and needs related to identification of individuals must be discussed on a case by case basis with PSU Project Manager.

END OF SECTION

PORTLAND STATE UNIVERSITY
DESIGN AND CONSTRUCTION STANDARDS

SECTION 32 – **EXTERIOR IMPROVEMENTS**

A. IRRIGATION

1. The Contractor shall meet with the PSU Landscape Manager to review/evaluate final irrigation system prior to final acceptance and installation.
2. Provide and maintain temporary irrigation of species for two years. Refer to Section 32.B.1.a
3. Provide a manual shutoff valve to isolate the irrigation system from the water supply main.
4. Provide sprinkler heads and nozzle types of the same manufacturer and pressure rating within the same irrigation zone.
5. Drip irrigation should be used in all planters and parking lot islands.
6. Color code Type U.F. control wiring as follows: ground/common wire – white; lead-in signal wire – red; spare signal wire – orange; moisture sensor wire – green; master valve wire – yellow; master valve dedicated common wire – white; future expansion signal spares – black; future expansion common – white.
7. Provide quick coupler valves (e.g. Buckner QB44RC-10) every 100 feet or less. These quick coupler valves are used to hand water landscaped areas. Locate quick coupler valves to limit water hoses crossing walkways and roads.

B. PLANTING

1. GENERAL

- a. Selection of plants shall require plant varieties that are drought-tolerant and require minimum to no irrigation beyond first years of establishment. Irrigation systems should be limited to what is operationally and cost-effective during maturing years.
- b. Prefer selection of native species. Consider maintainable, adaptable, low-maintenance, and non-invasive species

2. TREES

-  a. The use of native species is encouraged.
- b. The following species are forbidden in designs: poplars, female ginkgo, pin oaks, and locusts. Refer to City of Portland Parks and Recreation's Urban Forestry Division's list of recommended species and The Campus Tree Care Plan – Appendix 32.1. Unless included in contained and designated areas for food production and wild life habitat, trees that produce berries, fruits or nuts shall be prohibited.
- c. Aspens are prohibited in bioswales.
- d. Tree planting to occur only during October through December, and March through May.
- e. Pruning of newly planted trees, except limbs that are dead or broken, is prohibited.
- f. Species and placement of trees by approval of PSU's Landscape Manager.
- g. All trees to be planted by approved Landscaping Contractor or PSU Landscape Staff.

3. TURF AND GRASSES

-  a. The use of drought-tolerant species is preferred
- b. Areas to be grassed shall be seeded. Use of sod is discouraged. All grass seed used shall be 'certified'.
- c. Hydro seeding is the preferred method of seeding large areas.

PORTLAND STATE UNIVERSITY
DESIGN AND CONSTRUCTION STANDARDS



- d. Select grass blend to accommodate formal or informal pedestrian traffic patterns.
 - i. Sun locations: 3-way Perennial Ryegrass blend
 - ii. Shade locations: 70% Perennial Rye, 15% Creeping Red Fescue
 - e. Seeding to be done late summer or early fall.
 - f. Newly seeded areas shall be watered for a period of two to three weeks after application of seeds.
4. PANTING BEDS AND PLANTS
- a. Preferred designs shall include raised planting beds with a mix of medium-sized bushes and/or shrubs, colorful perennials for interest and diversity, and grasses not requiring mowing (e.g. bunchgrasses).
 - b. Plants must be grouped in beds with plants of similar needs for sunshine/shade, water or fertilization, soil type, and PH.
 - c. Kinnikinnick ground cover is prohibited.
 - d. Decorative rock is not to be used in planting beds.
 - e. All landscape designs to be reviewed by PSU Landscaping.

C. LANDSCAPING MAINTENANCE

Provide landscape maintenance for two years.

D. PAVING

1. DESCRIPTION

- a. Large areas of exterior concrete flatwork for roads and sidewalks increase surface runoff of rainwater into the City of Portland's storm water drainage system and prevent natural percolation into the subsurface. Designs of large areas of flatwork should include collecting or routing of this runoff into flowerbeds, bioswales, and other planted areas.
-  b. The use of recycled aggregate at the highest percent possible is encouraged where appropriate and structurally allowed. Exposed aggregate sidewalks are discouraged except to match existing, e.g. the Park Blocks and Montgomery Greenway.
- c. When selecting pavers, provide products that have adequate drainage systems.
-  d. Where applicable, the use of permeable pavers is encouraged.

END OF SECTION

PORTLAND STATE UNIVERSITY
DESIGN AND CONSTRUCTION STANDARDS

SECTION 33 - **PARKING**

A. EQUIPMENT

1. PRODUCTS / LOCATION

a. Curb Stops (Parking Bumpers)

Manufacturer: Traffic Safety Supply Company's, model: Recycled Rubber Parking Block or as approved by PSU Project Manager and PSU Transportation and Parking Services.

b. Speed Bumps

Manufacturer: Traffic Safety Supply Company's, model: 100% Recycled Plastic Speed bump or as approved by PSU Project Manager and PSU Transportation and Parking Services.

c. Bollards and Posts

i. 48" magnetic posts, black with white reflective stripping located at UCB Garage.

Manufacturer: Parking Zone, model: "Gorilla Posts" or as approved by PSU Project Manager and PSU Transportation and Parking Services.

ii. Flexible Posts, black with white reflective stripping located at 4th Avenue Garage and Parking Structure 1

Manufacturer: Street Smart Solutions, model: "Self-erecting Flexible Posts 3s-K71" or as approved by PSU Project Manager and PSU Transportation and Parking Services.

END OF SECTION

Appendix 01.5
CUSTODIAL AND STORAGE
CLOSETS

PORTLAND STATE UNIVERSITY
DESIGN AND CONSTRUCTION STANDARDS

APPENDIX 01.2 – CUSTODIAL AND STORAGE CLOSETS

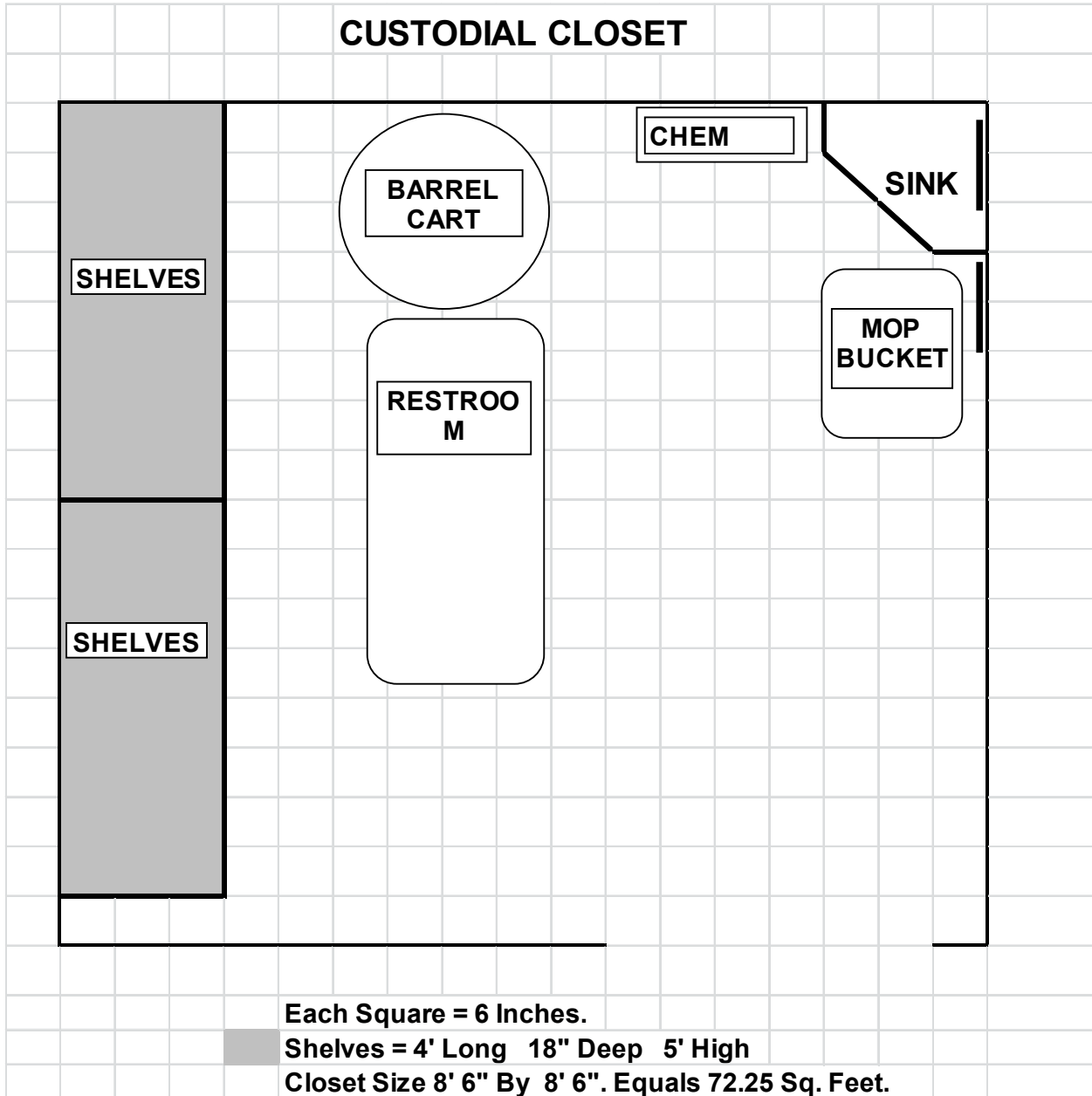

PORTLAND STATE UNIVERSITY
DESIGN AND CONSTRUCTION STANDARDS

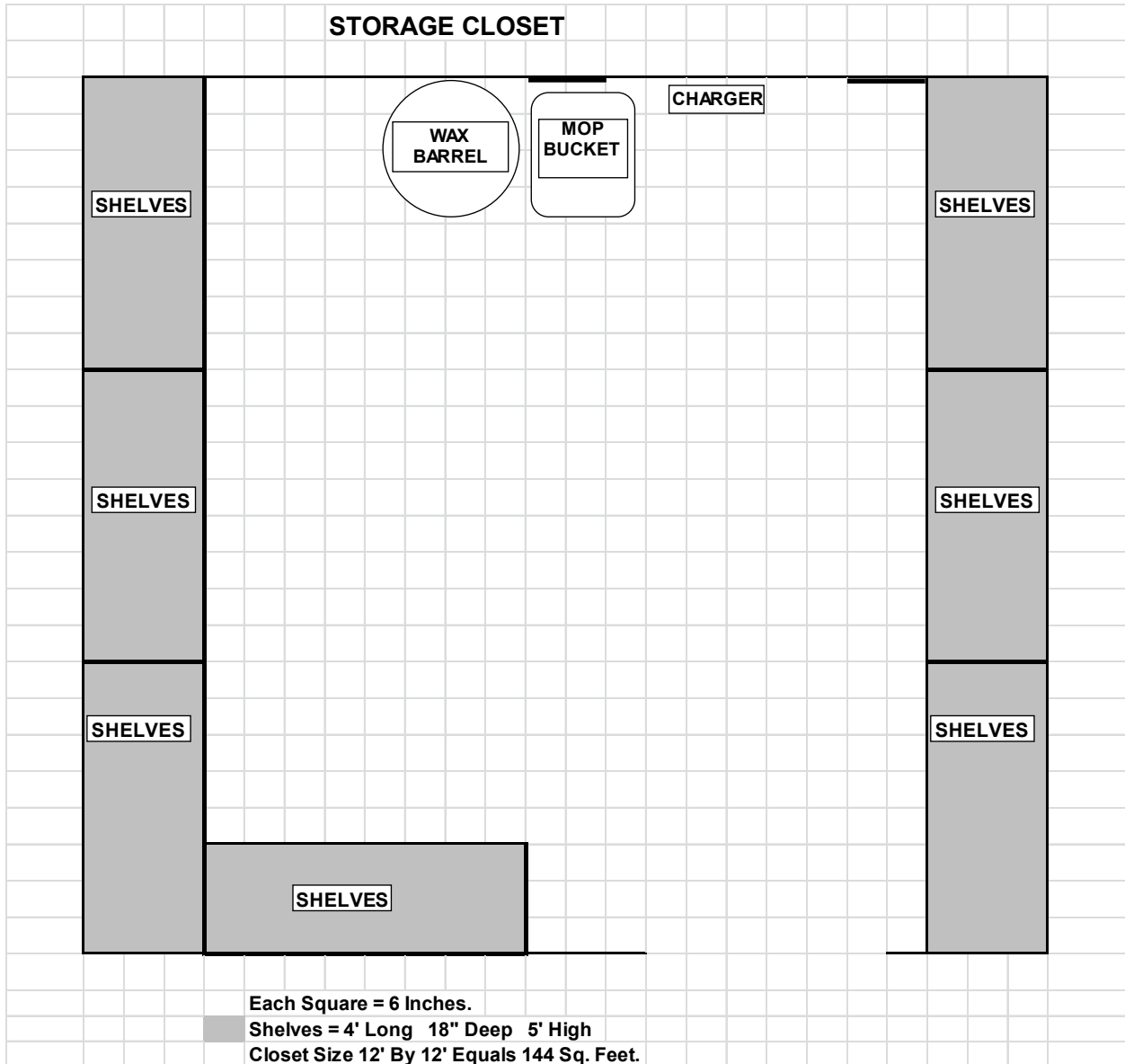

Appendix 01.6
RESTROOM PREFERENCES

PORTLAND STATE UNIVERSITY
DESIGN AND CONSTRUCTION STANDARDS

APPENDIX 01.6 – **RESTROOM PREFERENCES**

Restroom Flooring – Avoid using ceramic tile. Preferred flooring is a seamless floor and cove base.
Example: Epoxy Quartz Seamless Floor.

Restroom Partitions - Recycled plastic is a suitable material for toilet partitions due to the non-structural requirements of the product and the durability and clean-ability of the material. These products use recycled HDPE post-consumer plastic. Depending on the product, the recycled content can vary from 30% to 75%.

All restroom partitions must be made from high recycled content plastic, or reclaimed materials.

High-Recycled Content Plastic Compartment Resources:

- **Santana Plastic Products**
1300 Meylert Ave.

Scranton, PA 18509

800/368-5002

- **Comtec Industries, Inc.**
801 Corey

Moosic, PA 18507

800/445-5148

- **Inteq Corp.**
33010 Lakeland Blvd.

Eastlake, OH 44095

440/953-0550

Water Heaters

All water heater thermostats must be set no higher than 120 degrees. All water heaters shall have at least 1.5 inches of foam insulation. Contractors shall select a water heater with the highest energy factor

PORTLAND STATE UNIVERSITY
DESIGN AND CONSTRUCTION STANDARDS

(EF) and annual fuel utilization efficiency (AFUE) rating. EF is based on recovery efficiency, standby losses, and cycling losses. Electric-resistance water heaters have an EF ranging from 0.7 to 0.95; gas water heaters from 0.5 to 0.6, with a few high-efficiency models at around 0.8; oil water heaters from 0.7 to 0.85; and heat-pump water heaters from 1.5 to 2.0. Product literature from the manufacturers usually give the appliance's EF rating. If it not, literature can be obtained by contacting an appliance manufacturer association. AFUE ratings are shown on product EnergyGuide labels. The higher the EF and AFUE ratings, the more efficient the water heater.

All water heaters must be compared on the basis of EF and AFUE ratings. All other things being equal, heat pump and electric water heaters are preferred and the product with the highest EF and AFUE is recommended.

Water Heater Resources:

- Top-rated gas and oil water heaters: www.aceee.org/consumerguide/topwater.htm
- www.energystar.gov

Water Saving Devices

Devices that lower the quantity of water flow can reduce the operating costs of a building. The U.S. Energy Policy Act of 1992 established water conservation standards for water closets, showerheads, faucets and other uses to save water consumption in the United States. These standards can be met and even exceeded by installing sensors and flow restrictors on water fixtures.

Contractors are required to employ strategies that in aggregate use 20% less water than the water use baseline calculated for the building (not including irrigation) beyond meeting the Energy Policy Act of 1992 fixture performance requirements.

Energy Policy Act of 1992 Flow Requirement	
Water Closets (GPF)	1.6
Urinals (GPF)	1.0
Showerheads (GPM)	2.0
Faucets (GPM)	1.5
Replacement Aerators (GPM)	0.5
Metering Faucets (gal/CY)	0.025

PORTLAND STATE UNIVERSITY
DESIGN AND CONSTRUCTION STANDARDS

Additional interior water saving methods include installing dry fixtures such as composting toilets and waterless urinals. Indoor water efficiency products that meet these requirements are readily available locally.

Faucets – All faucets shall be Chicago. PSU maintains a storage of spare parts manufactured by Chicago.

Water Saving Product Resources:

- How to Buy a Water-Saving Faucet/Showerhead/Toilet: www.eren.doe.gov
- US Department of Energy Federal Emergency Management Program

DIVISION 10 - SPECIALTIES

Section 10810 - Toilet Accessories

Introduction

This section addresses the type of accessories which are to be provided or anticipated for all new and remodeled restrooms.

Below are the requirements for toilets which will be serviced and maintained by Facilities Management.

Part 1 – General:

- Provide at least one paper towel dispenser for every three sinks and install at HC accessible height.
- All dispensing units shall be surface mounted. Recessed elements are to be avoided. Stud walls should receive appropriate blocking to accommodate surface mount attachment.
- For new projects, FM Custodial Services will provide hand soap and toilet tissue dispensers for installation by the contractor. Paper towel dispensers are to be provided and installed by the contractor.
- Trash receptacles are to be located or at least anticipated in every restroom.
- Provide an Accessories Schedule in the specifications or on the drawings listing each room and the quantity of each type of accessory required *as well as who provides what elements and who installs.*
- Consultant should anticipate and prescribe locations of owner furnished elements so as to insure that conflicts with contract work do not exist.

Part 2 – Products:

- Paper towel dispensers shall be surface mount, **Kimberly Clark # KC-09765 (Lever) or KC-09990 (Hands Free) or authorized equal.**
- Soap dispensers are provided by Custodial Services *via their soap vendor* and are surface mounted **GoJo style dispensers** . Avoid attaching to mirror.
- Toilet tissue dispensers shall be surface mount, **Kimberly Clark # KC-09507 or authorized equal.**
- Seat Cover Dispensers shall be surface mounted **Bobrick B-221** or authorized equal.

PORTLAND STATE UNIVERSITY
DESIGN AND CONSTRUCTION STANDARDS

- Toilet/Urinal Partitions – Preferred is **Brobrick “Sierra Series” Solid Color Reinforced Composite**. If limited color selection is an issue then **Brobrick “Duraline Series” Solid Phenolic partitions can be used**. Other manufacturers can be used if partitions are equal to or better than Brobrick.
- Diaper Changing Stations shall be surface mount, **Koala Bear Kare** or authorized equal.
- Sanitary napkin/tampon vendors shall be surface mounted and constructed of stainless steel. Capacity not less than 15 napkins and 20 tampons. Currency cost and coin slot for \$0.25. Brand name advertising not allowed. Provide **Bobrick B-282** or authorized equal.
Including sanitary product vending machine in restroom layout will depend on decision by Facilities Management.

- Sanitary napkin disposal units shall be surface mounted and constructed of stainless steel. **Bobrick B-270** or authorized equal.
- Waste receptacles will be provided by Custodial Services as part of FFE and will be free standing units.
- Grab bars shall be stainless steel, 18 gauge minimum wall thickness, 1.5" minimum outside diameter with concealed mounting devices. Install to provide 1.5" clearance between wall and inside face of handrail.
- Mirrors shall be 1/4" glass with stainless steel frame and concealed fasteners. Locate and size mirror to provide adequate free wall space for soap dispenser.

Part 3 – Execution:

- Provide stud wall backing for all surface mounted accessories.
- Protect all toilet accessories from damage during the course of construction.
- Clean all surfaces in strict accordance with manufacturer's recommendations after removing temporary labels and protective coatings.
- Mount paper towel dispensers with lever at 48" A.F.F. for ADA accessibility.
- Layout all accessories to ensure that surface mount elements do not restrict access to sinks.

Appendix 08.1
DOOR HARDWARE

PORTLAND STATE UNIVERSITY
DESIGN AND CONSTRUCTION STANDARDS

f. Dead Bolt	L series
g. Temporary Lock/cylinder TD	Schlage large format interchangeable core housing
h. Door Closer	LCN 4040 series
i. Door Opener	LCN Senior Swing
j. Hinge, Ballbearing, NRP	Hager, Stanly, Mckinney
k. Hinge, Plainbearing, NRP	Hager, Stanly, Mckinney
l. Hinge, Continuous	Markar
m. Manual Flush Bolts	Ives FB457, FB458
n. Auto Flush Bolts	Ives FB30/40 series
o. Drawer Lock	Olympus 888icp-dw Olympus 920 lm/dm
p. Cabinet Door	Olympus 777icp-dr Olympus 920 lm/dm
q. Access Panels	Olympus 920 lm/dm
r. Cylinders	Schlage
s. Butts	Stanley, Mckinney, Lawrence
t. Electric transfer hinge	Von Duprin
u. Key switch	Von Duprin
v. Exit devices	Von Duprin
w. Locksets and latches	Schlage
x. Stand alone access control	Schlage ND Series
y. Astragal	Pemko
z. Door Stops	Glen Johnson, Ives
aa. Push Pull	Builders Brass
bb. Kickplates	Builders Brass, Trimco
cc. Thresholds and weatherstrip	Pemko
dd. Door operators (ADA)	Keane Monroe
ee. Automatic door sensors (ADA)	B.E.A.
ff. Door actuators (ADA)	Largo
gg. Door position switch	Sentrol

PORTLAND STATE UNIVERSITY
DESIGN AND CONSTRUCTION STANDARDS

hh. Door holders LCN

2. FINISH

Match existing building standard or ANSI 626 or US26D

3. TYPICAL HARDWARE LIST

- a. Reference Door Schedule and details and Specification Sheets
- b. Match existing finishes.

4. LOCKS AND HANDLES

- a. Manufacturer: Schlage or approved equal
- b. Match existing lever style and color
- c. Use Schlage "ND" series
- d. Vandelguard entrance lock
- e. Storeroom lock-- ND96LD
- f. Lever Passage lock -- ND10S,
- g. Lever Privacy lock -- ND40S.
- h. Pocket door latch 990 series.
- i. Exit rim and panic bar devices by Von Duprin 98 series at all assembly areas, doors that out-swing from a room, or other areas specified on drawings

5. CARD ACCESS DOORS

- a. Provide/Install all transformers or other electrical devices and hardware required to support card access for locks and panic bars.
- b. Strikes to be ansitype 10-025, electric as required for card access.
- c. Key card access control at exterior entry point. Retro-fit existing or provide at new doors for electric strike. Coordinate with existing PSU system, door hardware, or power opening device.

6. BUTTS

- a. Manufacturer: Lawrence, Stanley, McKinney or approved equal
- b. (1-1 1/2) pr., to be ball bearing type, use non-removable-pin, on doors with closers.
- c. All other doors, use plain bearings, (1-1 1/2) pr., with non-removable-pin.

7. DOOR STOPS

- a. Manufacturer: Ives, Glen Johnson or approved equal
- b. Wall mount type WS 407 - 2-1 /2" dia.

8. SMOKE GASKETS

- a. Manufacturer: Pemko or as approved approved equal.
- b. AM 88, black, at all doors in fire corridors on all levels.

9. BI-FOLD HARDWARE

- a. Manufacturer: Bi-Fold Hardware, Johnson, or approved equal
- b. Use complete hardware model #200 FD including track , pivots, butts, ball bearing roller guides, and brackets ,

PORTLAND STATE UNIVERSITY
DESIGN AND CONSTRUCTION STANDARDS

- c. Door handles -- 7" wire pulls -- Baldwin or approved equal

10. ADA POWER DOOR OPENER

- a. Manufacturer: LCN Senior Swing or approved equal
- b. Complete electric opener/closer mounted at door head pull side to include (2) wall plate actuators, with key card access at exterior. Retro-fit for ANSI 10- 025 electric strike. Actuators ADA wall mount each side of door. Accommodate lever hardware with and key lock operation. Satin chrome finish.
- c. Activate existing power door opener and install exterior wall plate actuator adjacent to door latch access. Retro-fit for ANSI 10-025 electric strike.

11. DOOR VIEWER

- a. Manufacturer: ADA model by Harney Hardware or approved equal
- b. 180 degree, 1 /2" bore, Oil rubbed bronze, # 31843. Verify ADA height requirements.
- c.

C. EXECUTION

1. INSTALLATION

- a. Install per manufacturer's specification and recommendation.
- b. For installation of locks, use manufacturer's fasteners that come with the hardware.
- c. For installation of door closers, use manufacturer's wood/metal fasteners pack; do not use self-tapping sheet metal screws.
- d. For electric locks, supply a wiring and a schematic diagram, show locations of power supplies and wire runs.
- e. Spring hinges and continuous hinges not allowed.
- f. Prefer that on metal doors that external exit vertical device rods are not used; Ok to use on wood doors.
- g. F. Prefer door assembly installation of welded 16 gauge door frames for break-in deterrent.

END OF SECTION

Appendix 10.1
INTERIOR SIGNAGE

PORTLAND STATE UNIVERSITY
DESIGN AND CONSTRUCTION STANDARDS

APPENDIX 10.2 – **INTERIOR SIGNAGE**

PART 1 GENERAL

1.1 STANDARDS OF PERFORMANCE

- A. Install in compliance with PSU Office of Communications lettering and ADA standards for visibility.
- B. New room and building interior signage per code, ADA, and PSU standard requirements.
- C. First floor rooms to be numbered in the 100's, first classroom to be 101.
- D. Second floor rooms to be numbered in the 200's, first classroom to be 201.
- E. Third floor rooms to be numbered in the 300's, first classroom to be 301.
- F. Where possible, room numbers for first, second and third floor classrooms to be mirrored from one floor to the next.
- G. All rooms within a room should be designated with the main room number followed by an alpha designation (A, B, C...), moving in a general clockwise direction, but jumping across hallways.
- H. All spaces to have a room number, including classrooms, closets, corridors and electrical/mechanical closets.
- I. All fire alarm and security panels to use final designated room numbers.
- J. All drawings, including architectural, electrical and mechanical to use PSU's standard room numbering system.
- K. Indicate requirements for ADA signage on all rooms.
- L. Provide and Install all non-illuminated code required signage.
- M. Labels may be produced in-house in various colors and sized depending on the installation requirements.
- N. Photo-polymer signs will not be acceptable.

1.2 RELATED SECTIONS

- A. 10 06 10.13 Exterior Signage
- B. 10 14 00 Signage

1.3 SUSTAINABILITY

- C. PSU is committed to the use and incorporation of sustainability principles. All interpretations of these specifications must be aligned as closely as possible with PSU's vision of being "...an internationally recognized urban university known for excellence in student learning, innovative research, and community engagement that contributes to the economic vitality, environmental sustainability, and quality of life in the Portland region and beyond."

1.4 LEGAL NOTES

- A. This specification is intended for use within PSU Planning, Construction & Real Estate as a guidepost for product and vendor selection, and for distribution to PSU contractors and vendors as needed. This document is not intended to supersede manufacturer's

PORTLAND STATE UNIVERSITY
DESIGN AND CONSTRUCTION STANDARDS

restrictions, specifications completed by hired architects, or legal requirements governing work.

1.5 STANDARD GUIDELINES

- A. Purpose
 - 1. To make the PSU campus visible, understandable, safe and welcoming for students, faculty, staff, and visitors
- B. Scope
 - 1. This policy applies to all interior signage on the PSU campus.
- C. Background
 - 1. Interior and exterior signage for the PSU campus has evolved over time with guidance or controls often resulting in visual clutter: poorly located signs; and mismatched letter sizes, colors, shapes, and mounting techniques. Therefore, a comprehensive interior/exterior way-finding sign program has been developed to provide an important community service and to help make a favorable public impression.
- D. Policy
 - 1. It is the policy of PSU that all campus signage must be in compliance with University approved standards.
- E. Interior Building Signs
 - 1. A modular, flexible, recyclable system of standardized signs will be used in all new buildings. This system will be implemented gradually in existing buildings as funds become available or as replacement is required. The system consists of a series of directories, maps, way-finding, and room identity signs to guide people to building destinations.
- F. Benefits
 - 1. The benefits of this comprehensive approach are that it:
 - a. Communicates useful information quickly to first-time users
 - b. Reduces both cost of signs and time required to obtain them
 - c. Reduces clutter
 - d. Ensures a unified graphic element throughout the campus
 - e. Complies with existing state and federal laws.
- G. Responsibilities for Interior Sign System
 - 1. In New Buildings
 - a. For new construction, the cost of signs is a capital expense that should be funded by the project budget.
 - 2. In Existing Buildings
 - a. After installation, the user groups will be responsible for funding any component or name changes.
- H. Implementation

PORTLAND STATE UNIVERSITY
DESIGN AND CONSTRUCTION STANDARDS

1. Purpose
 - a. To ensure interior and exterior signage conforms to the accepted PSU design standards.
2. Applicability
 - a. These procedures apply to all university departments.
3. Procedure
 - a. Whenever a university department requires signage to be placed on any University vehicle, facility or grounds, the department must:
 - i. Submit a request to the Office of Facilities and Planning indicating the need for the sign, the location, text and the account number to be charged.
 - ii. Office of Facilities and Planning reviews the request to ensure it complies with PSU design standards.
 - iii. If the request does not meet the design standards the department will be notified.
 - iv. If the request does meet the design standards, the Office of Capital Projects & Construction will coordinate the purchase of the sign and installation with appropriate requesting department funding identified.
 - v. The Signage Shop is responsible for the repair, installation and replacement of existing building and room signage on campus. The University does not replace nameplates or naming titles.

PART 2 PRODUCTS

2.1 LIST OF INTERIOR SIGNAGE

- A. See Section 2.3 for Typical Sign Drawings.
 1. Building Directories
 2. Floor Plan Maps
 3. Fire Exit Signage
 4. Way finding Signage
 5. Departmental Signage
 6. Restroom Signage
 7. Hanging Signs
 8. Flag Signs
 9. Wall Signs
 10. ADA Approved Signage
 11. Room Signage
 12. Stairwell Signage
 13. Metallic Letters

PORTLAND STATE UNIVERSITY
DESIGN AND CONSTRUCTION STANDARDS

14. Acrylic Letters
15. PVC Letters
16. Display Signage
17. Desk Nameplates
18. Wall Nameplates
19. Display Frame Signage and Inserts
20. Door Signage

2.2 INTERIOR SIGNAGE

- A. Manufacturer
 1. As Approved
- B. Description
 1. See Section 2.3 for Typical Sign Drawings
 2. Standard Entry door and window signage is White Vinyl, and generally applied on the exterior of the glass.
 3. Door jamb numbers are required above doorways, 1" tall, white or black depending on color of the door jamb. Old font is Optima Semi-bold and new font is Frutiger 55, Frobisher.
 4. FDC – Fire marshal exterior signage is generally Red Alupalite with white lettering.
 5. Back Painted Acrylic Signage is best painted with Lacryl Paint from pacific Coast Sign Supply. Needs 5 coats of fine sprayed paint.
 6. Grade 2 Braille and raised lettering.
 7. Entry doors – (NO SMOKING) symbol and text to say "Within 20' of Entry".
 8. Room ID Signs can be within 2" of door jambs
 9. All room signs are to include the following:
 - a. Room number
 - b. Room name, (Classroom, Conference Room, Electrical Closet, etc. ...),
 - c. Slot for interchangeable nameplate if room can be occupied

PORTLAND STATE UNIVERSITY
 DESIGN AND CONSTRUCTION STANDARDS

2.3 TYPICAL SIGN DRAWINGS

A. See graphical descriptions in subsequent sections

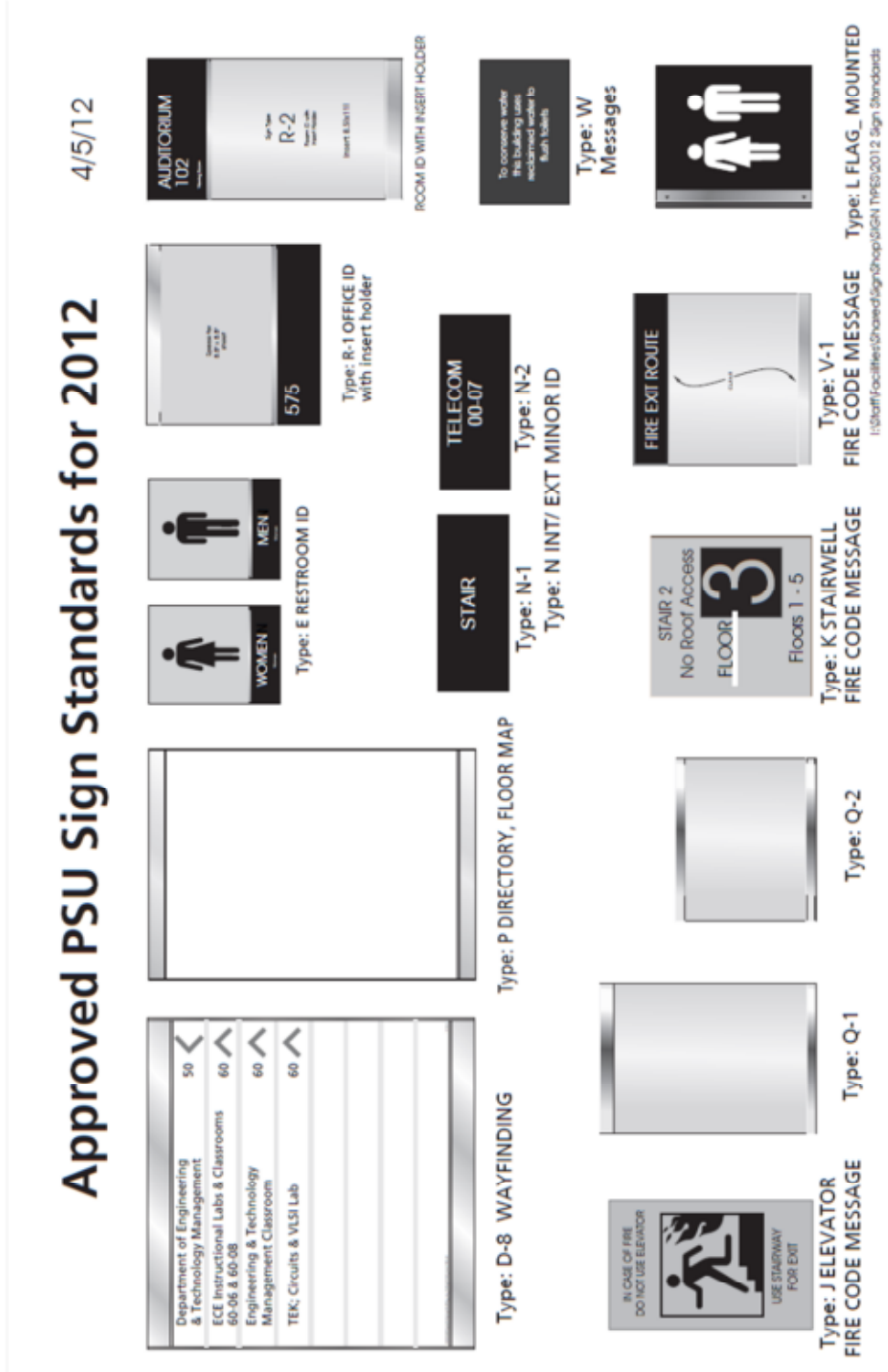

Figure a: Summary of Approved Signs

PORTLAND STATE UNIVERSITY
DESIGN AND CONSTRUCTION STANDARDS

Type D

1. Signs are designed to accept paper inserts for display of directional information
2. Type D-6 Sign accommodates 6 lines of information, Figure b
3. Type D-8 Sign accommodates 8 lines of information, Figure c
4. Construction details are shown in Figure d through g
5. Both sides are removable

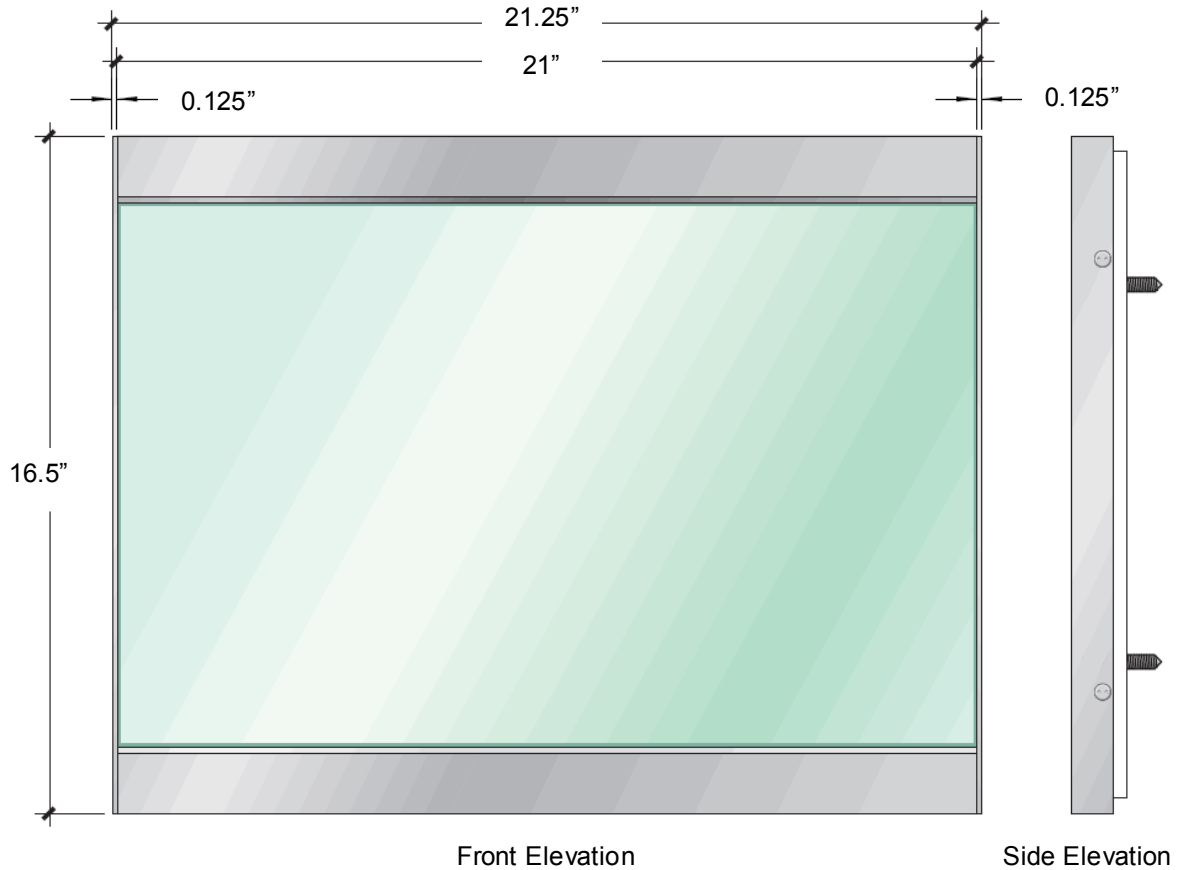

Figure b: Type D-6

PORTLAND STATE UNIVERSITY
DESIGN AND CONSTRUCTION STANDARDS

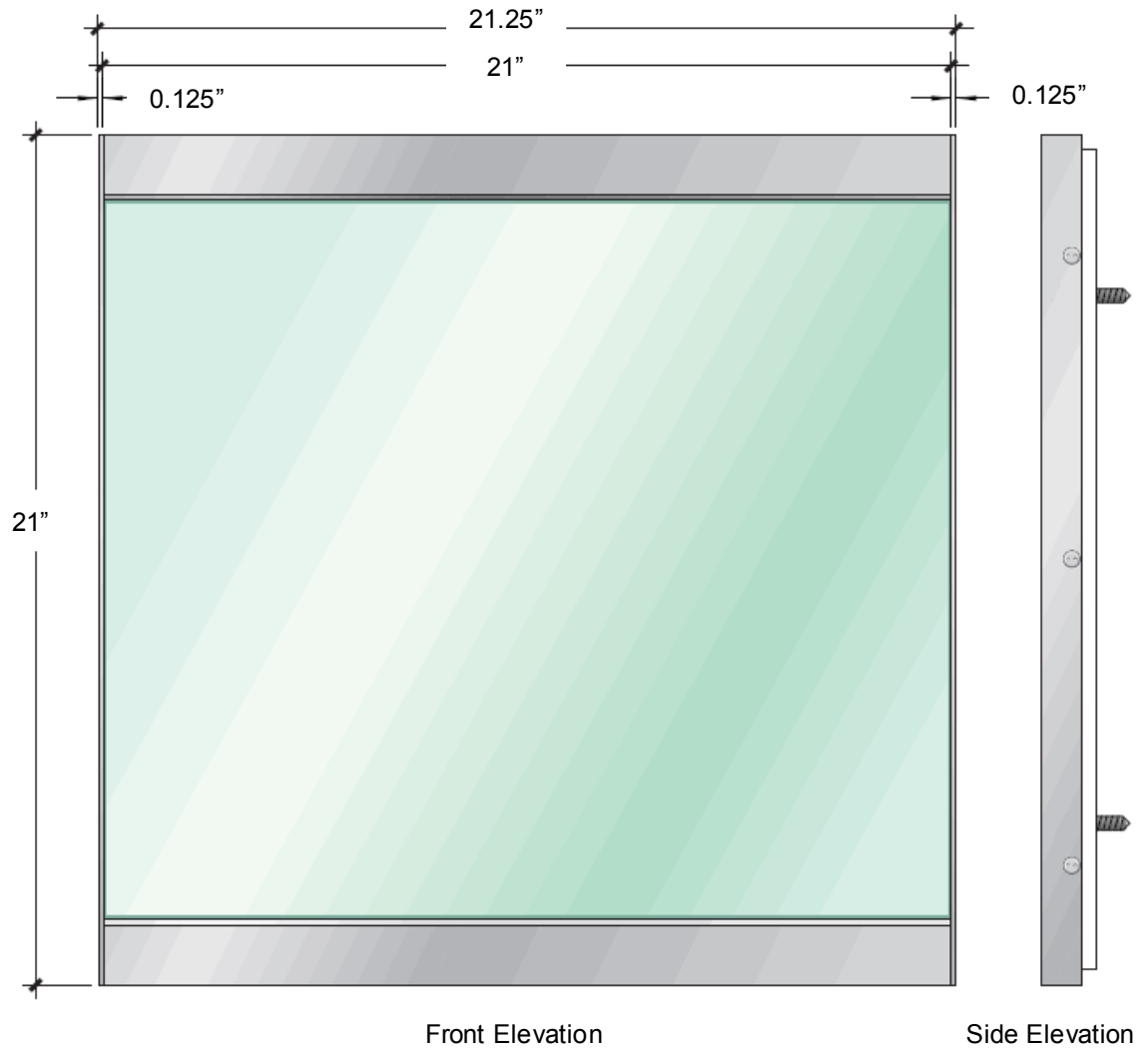

Figure c: Type D-8

PORTLAND STATE UNIVERSITY
DESIGN AND CONSTRUCTION STANDARDS

☒ These Phillips Drew screws secure the vertical “sides” to the sign structure and allow for insertion and removal of changeable information—accessible from either side

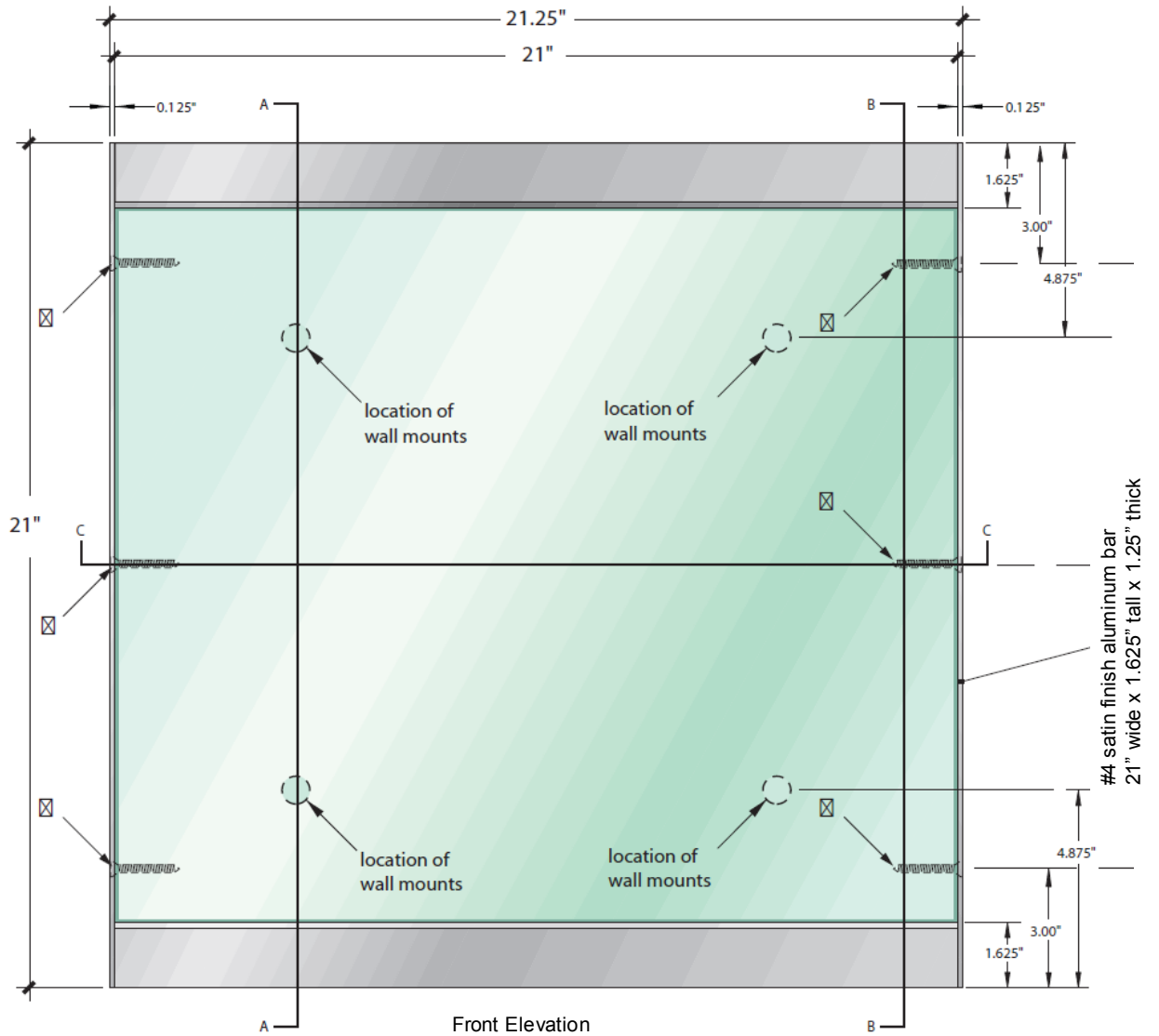

Figure d: Type D Direction Front View

PORTLAND STATE UNIVERSITY
DESIGN AND CONSTRUCTION STANDARDS

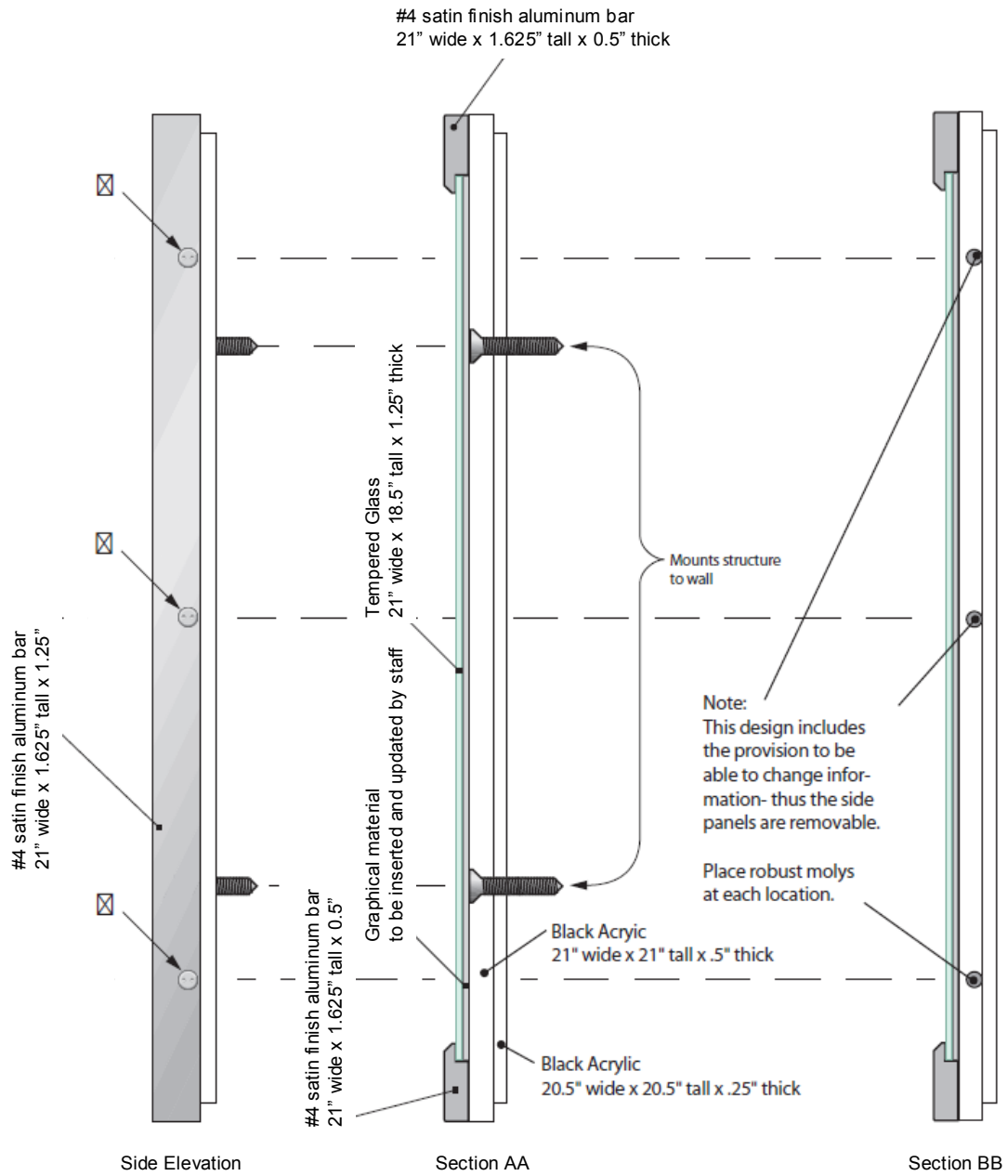

Figure e: Type D Side View and Section Cuts

PORTLAND STATE UNIVERSITY
DESIGN AND CONSTRUCTION STANDARDS

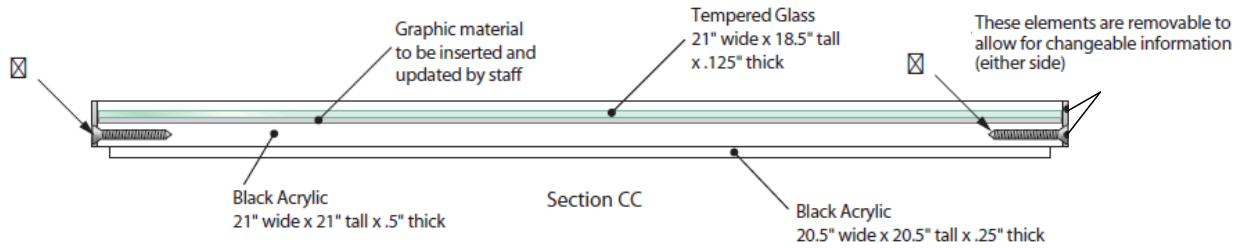

Figure f: Type D Horizontal Section CC

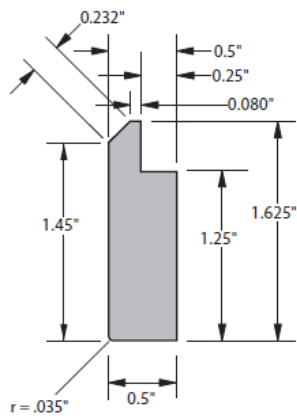

Figure g: Type D Bar Detail

- B. Type E
1. Sign type E is designed as restroom identification
 2. Type E-1 is for women, Figure h
 3. Type E-2 is for men, Figure i
 4. Section details are shown in Figure j

PORTLAND STATE UNIVERSITY
DESIGN AND CONSTRUCTION STANDARDS

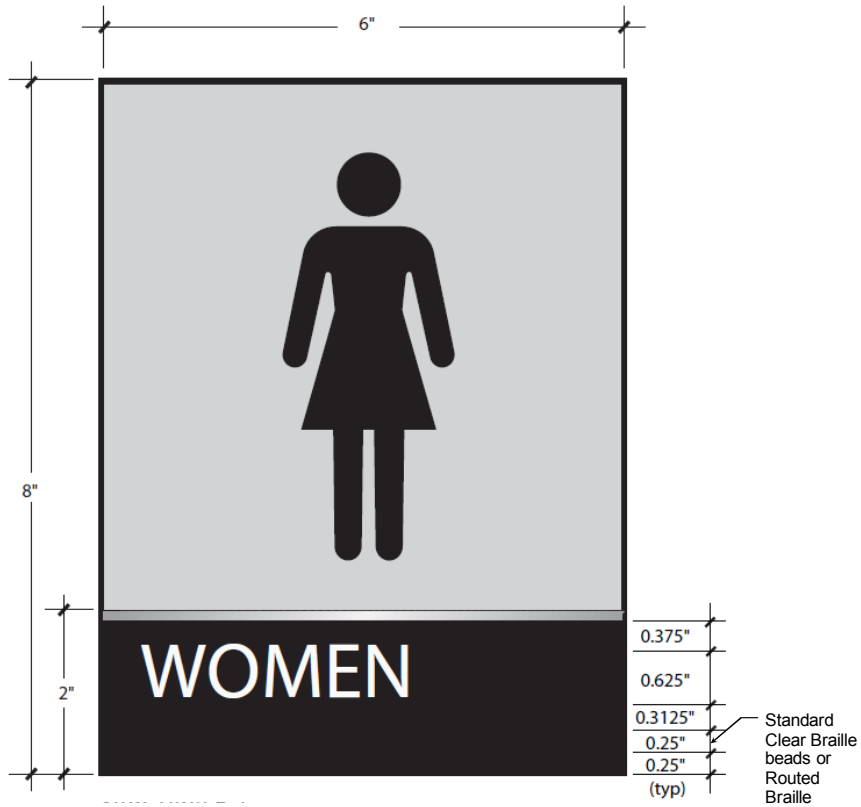

Figure h: Type E-1



Figure i: Type E-2

PORTLAND STATE UNIVERSITY
DESIGN AND CONSTRUCTION STANDARDS

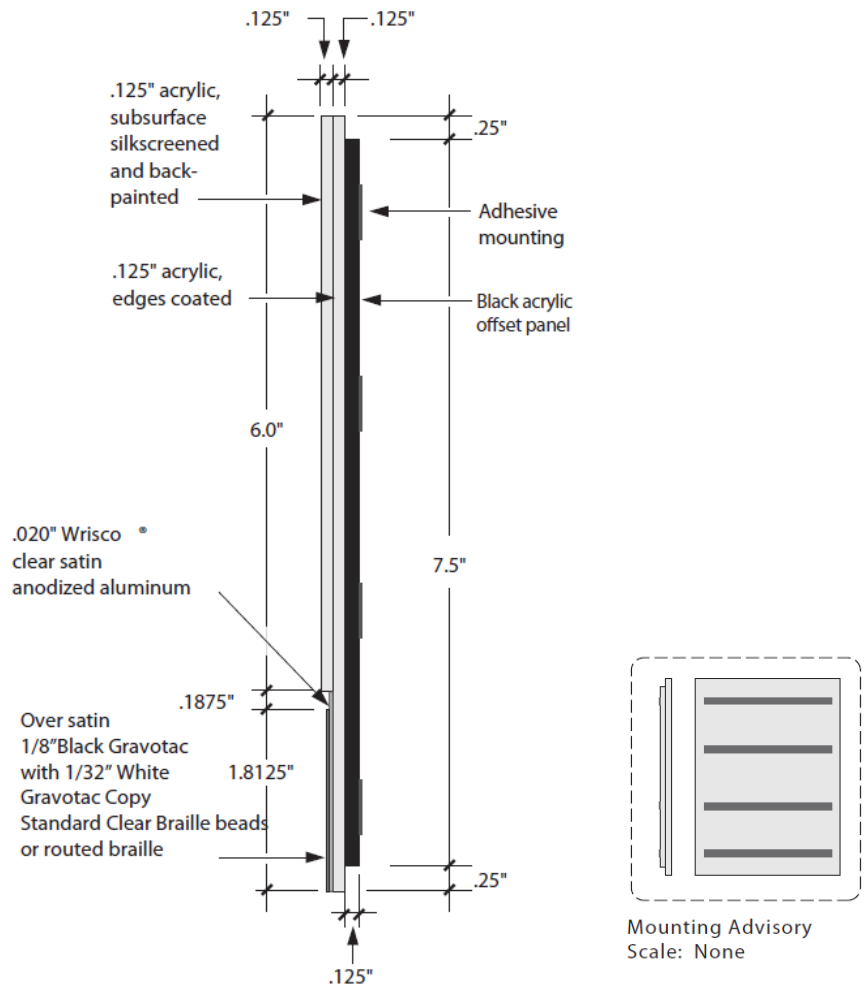

Figure j: Type E Section Details and Mounting Advisory

PORTLAND STATE UNIVERSITY
DESIGN AND CONSTRUCTION STANDARDS

C. Type J

1. Sign Type J is designed a Elevator Fire Code message, Figure k



Sign panel is 5" wide x 8" high x .125" satin finish "stainless steel", vertical grain.
Graphics are etched and filled with black enamel.

Figure k: Type J

PORTLAND STATE UNIVERSITY
DESIGN AND CONSTRUCTION STANDARDS

D. Type K

1. Sign Type K is a designed Stairwell Fire Code message, Figure I

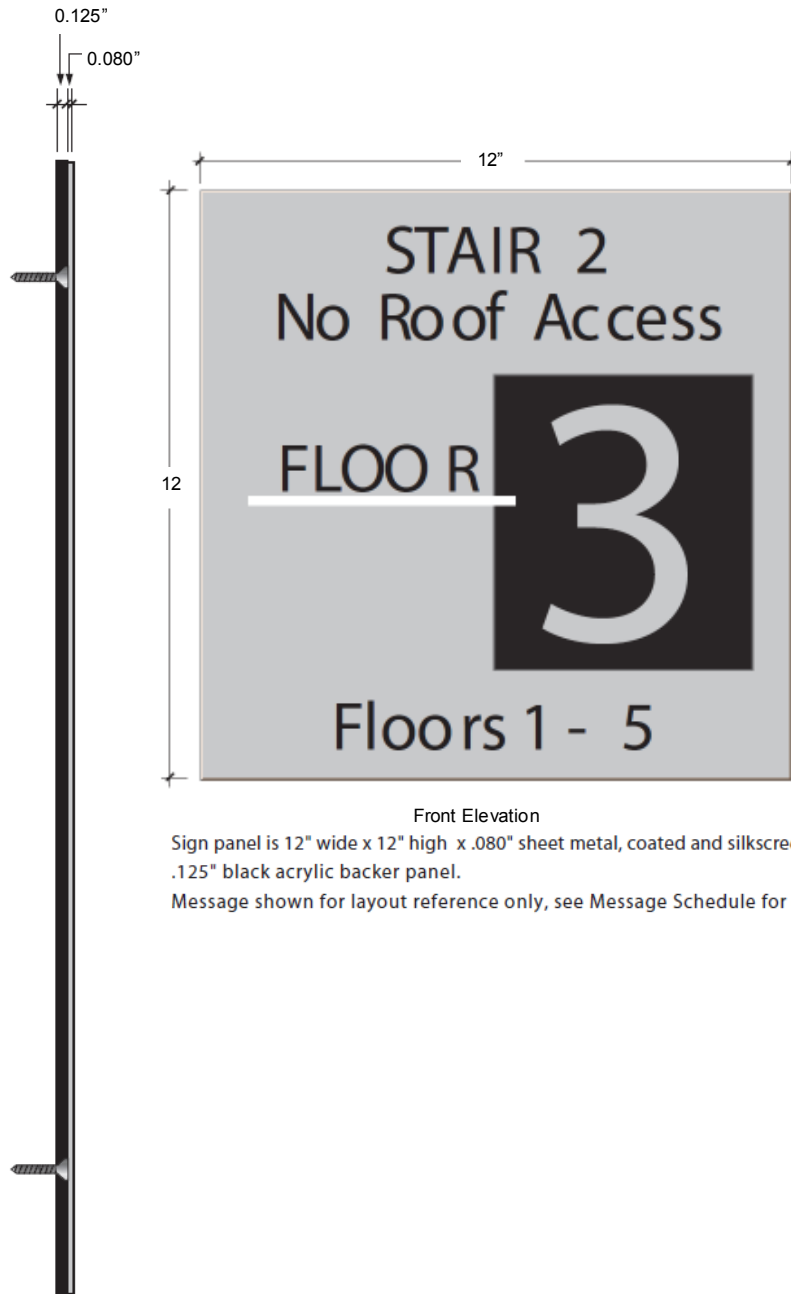

Front Elevation

Sign panel is 12" wide x 12" high x .080" sheet metal, coated and silkscreened.
.125" black acrylic backer panel.

Message shown for layout reference only, see Message Schedule for exact text.

Section View

Figure I: Type K

PORTLAND STATE UNIVERSITY
DESIGN AND CONSTRUCTION STANDARDS

E. Type L

1. Sign Type L is designed a Flag-Mounted Sign, Figure m

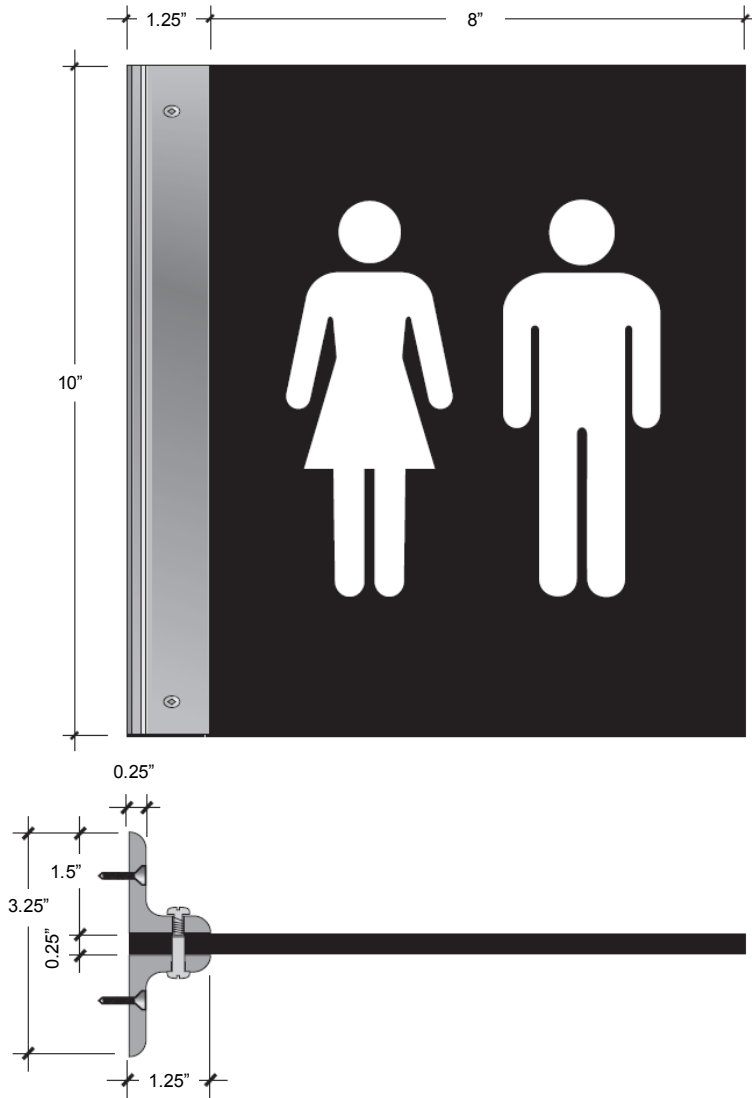

Mounting brackets are extruded or fabricated aluminum angles; clear satin anodized finish.
Sign panel is .25" Sintra, coated. Applied vinyl graphics are Gerber 220 Premium of equivalent.
Apply to both sides of sign panel.

Figure m: Type L

F. Type N

1. Sign Type N is designed as Minor Room Identification
2. Type N-1 accommodates a 1-line message, Figure n
3. Type N-2 accommodates a 2-line message, Figure n
4. Type N-3 accommodates a 3-line message, Figure n
5. Message appear in raised letters and Braille

PORTLAND STATE UNIVERSITY
DESIGN AND CONSTRUCTION STANDARDS

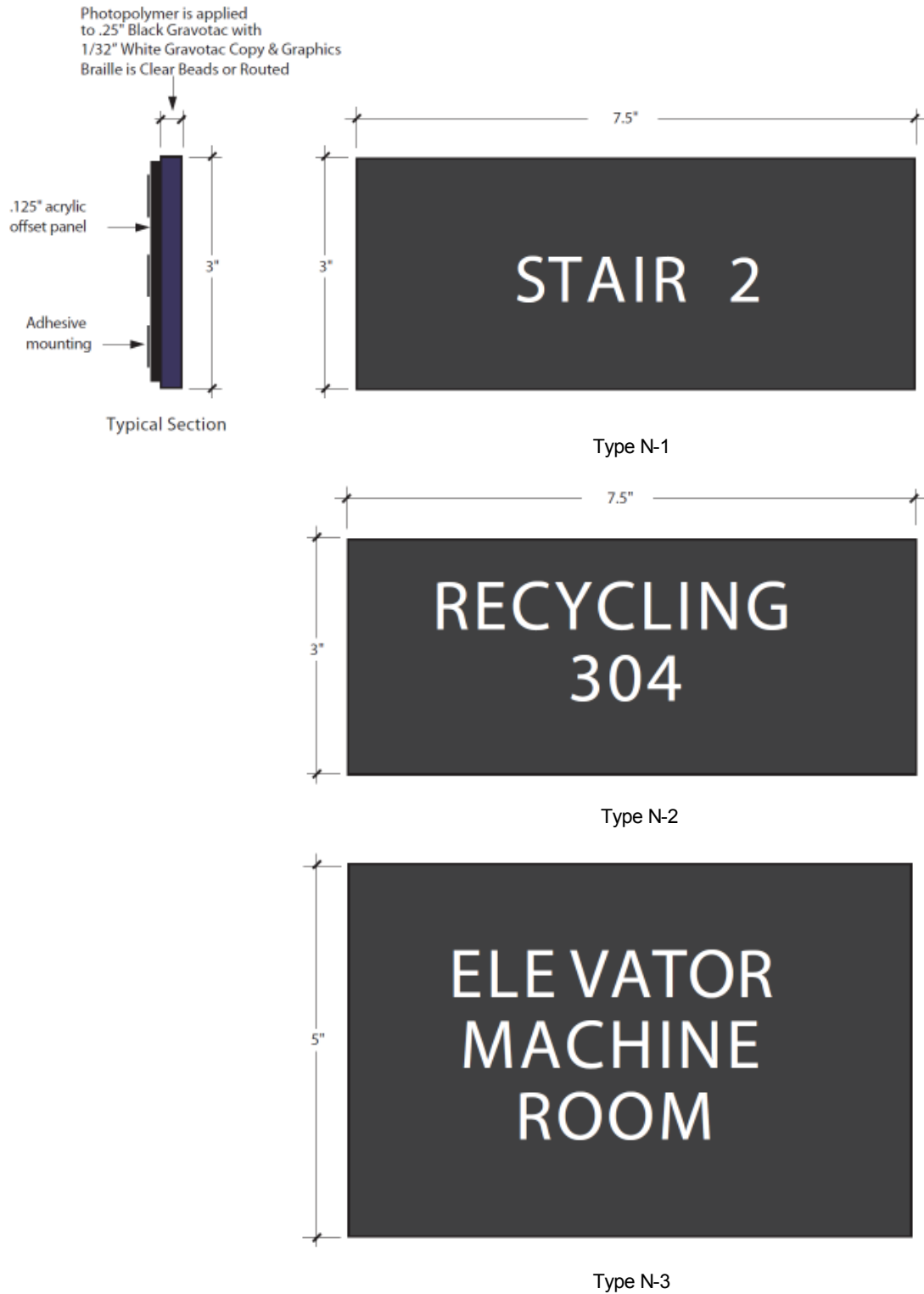

Figure n: Type N-1, N-2, and N-3

PORTLAND STATE UNIVERSITY
DESIGN AND CONSTRUCTION STANDARDS

G. Type P

1. Signs are designed to accept poster inserts for display, Figures o, p, q, and r

☒ These Phillips Drew screws secure the vertical "sides" to the sign structure and allow for insertion and removal of changeable information—accessible from either side

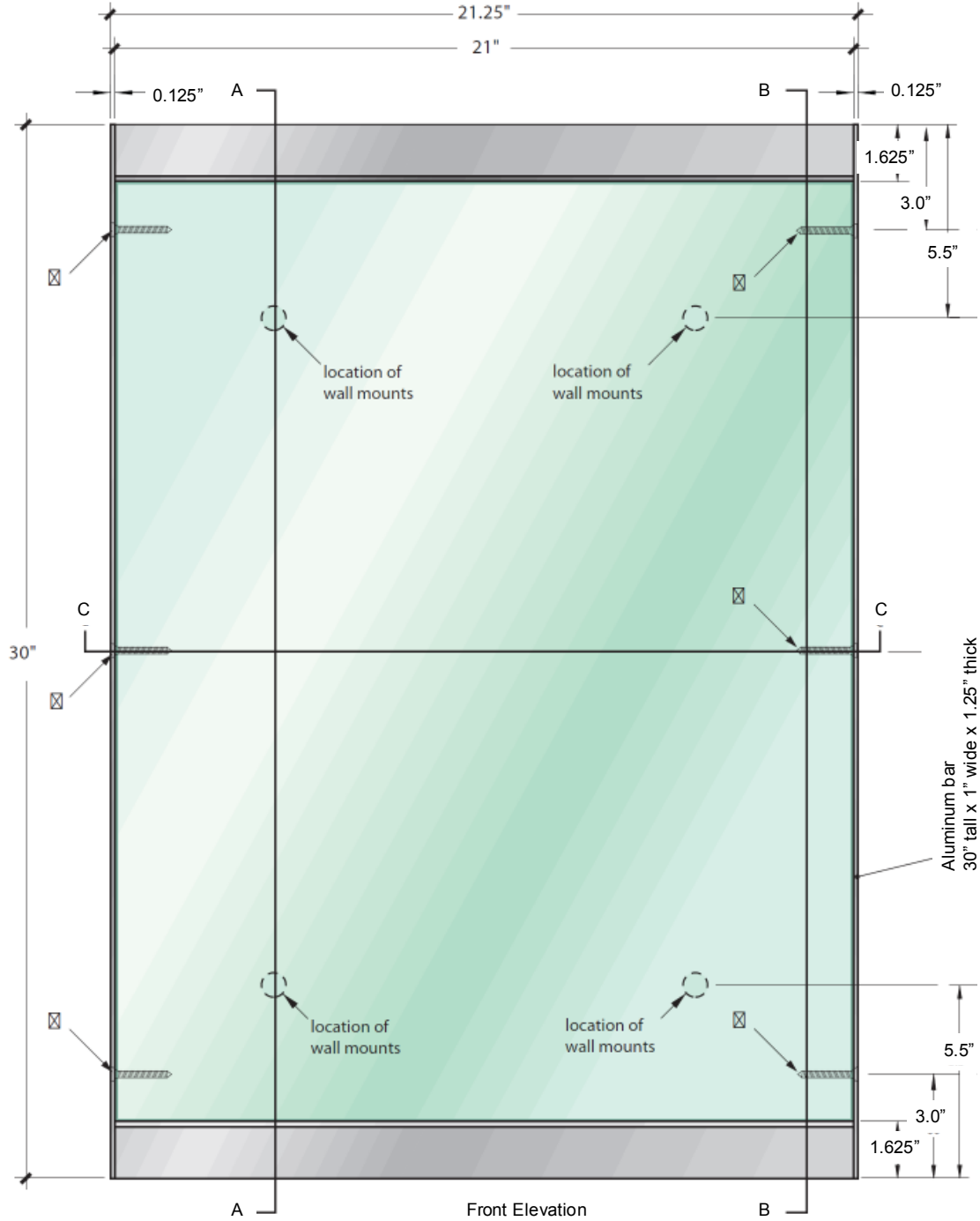

Figure o: Type P Front View

PORTLAND STATE UNIVERSITY
DESIGN AND CONSTRUCTION STANDARDS

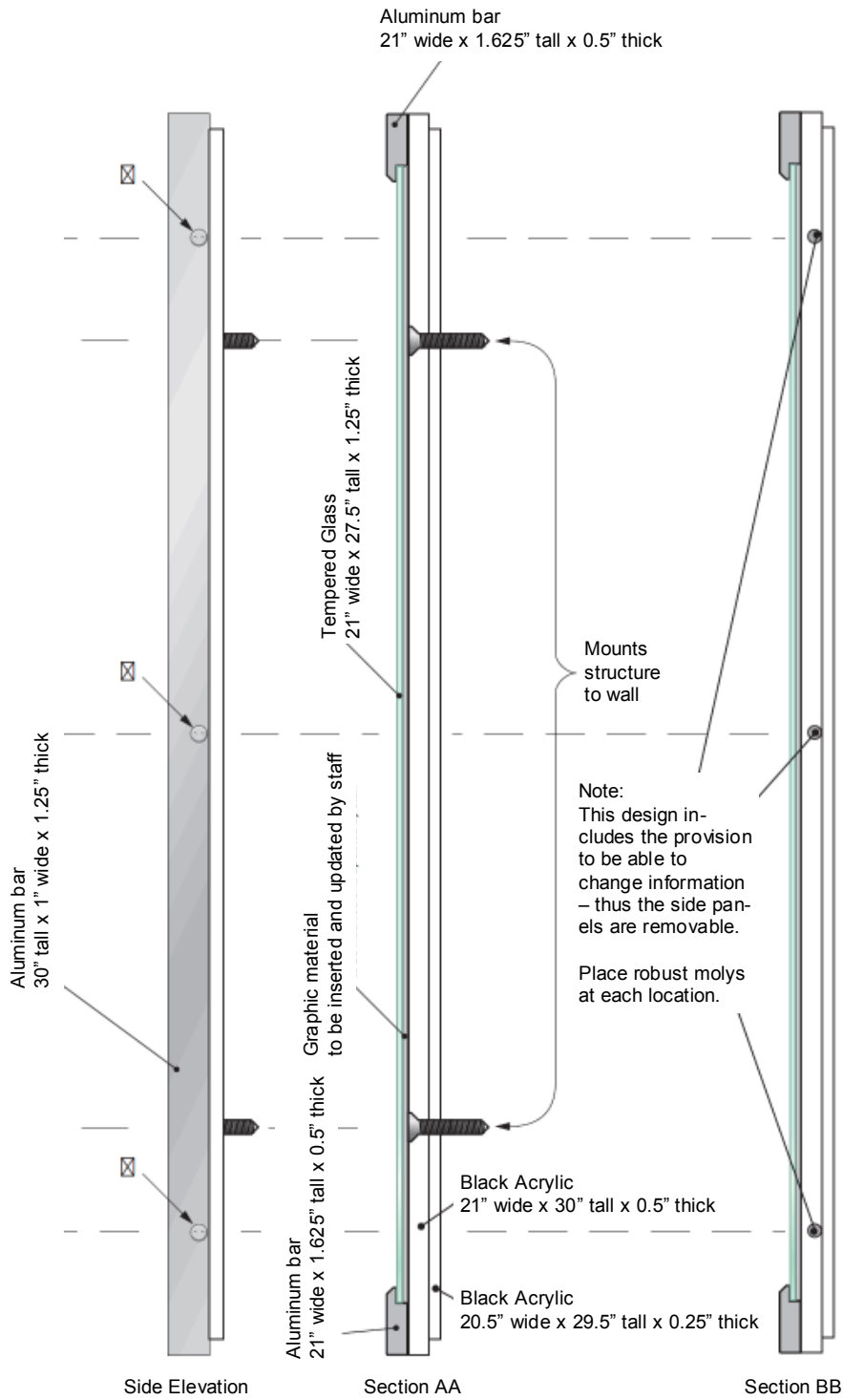

Figure p: Type P Side View and Section Cuts

PORTLAND STATE UNIVERSITY
DESIGN AND CONSTRUCTION STANDARDS

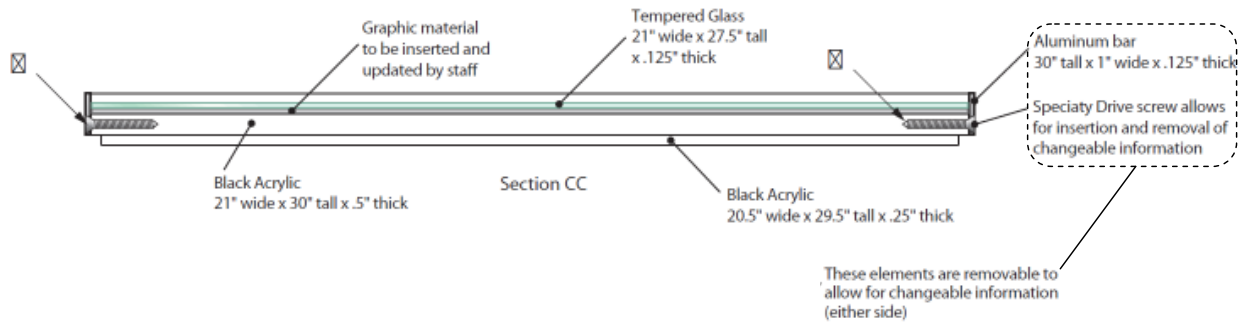

Figure q: Type P Horizontal Section CC

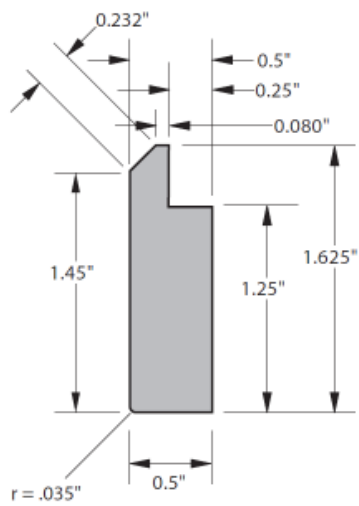

Figure r: Type P Bar Detail

PORTLAND STATE UNIVERSITY
DESIGN AND CONSTRUCTION STANDARDS

H. Type Q

1. Sign Type Q accepts a standard 8.5"x11" sheet for display
2. Type Q-1 accommodates a vertical format, Figure s
3. Type Q-2 accommodates a horizontal format, Figure t

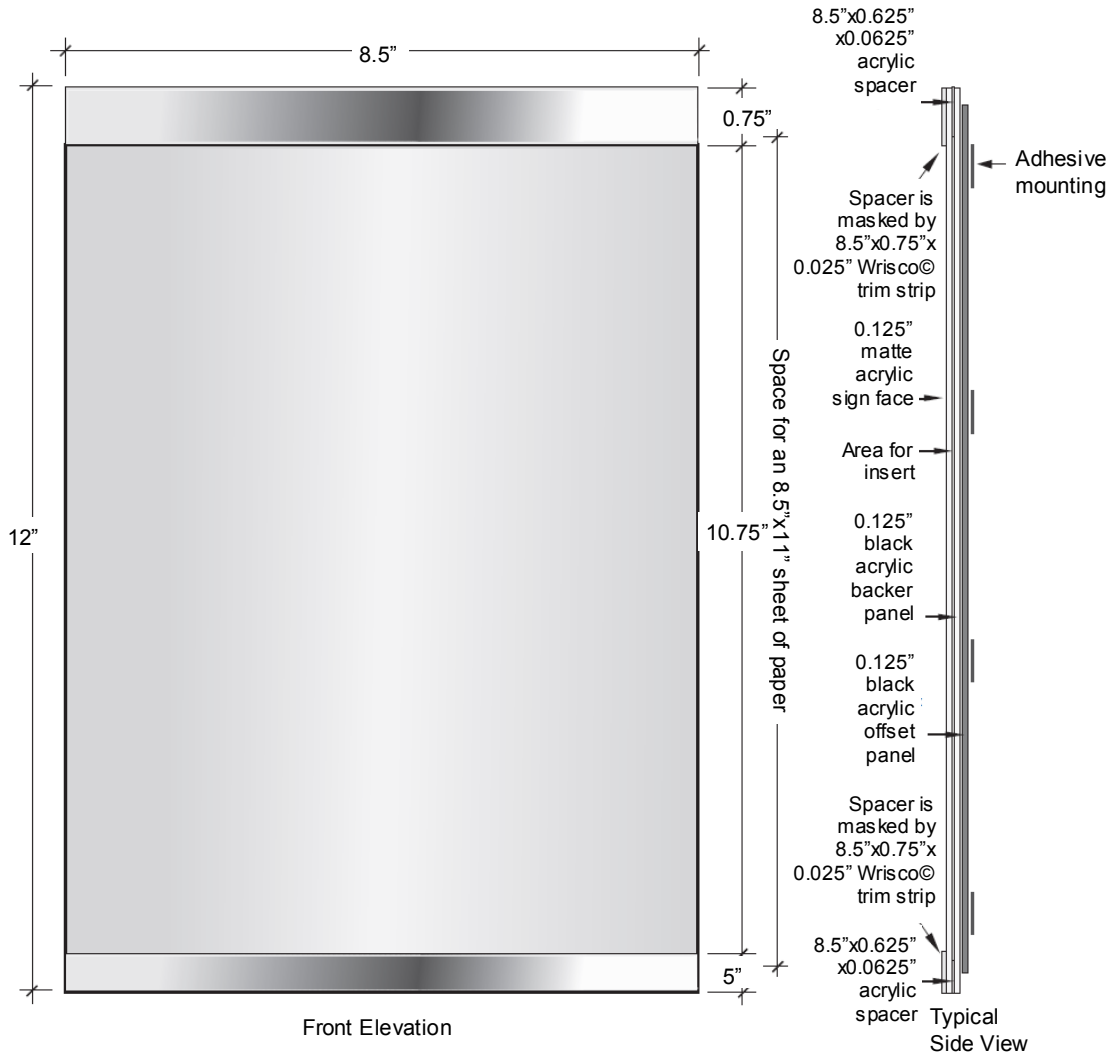

Figure s: Type Q-1 Vertical Format

PORTLAND STATE UNIVERSITY
DESIGN AND CONSTRUCTION STANDARDS

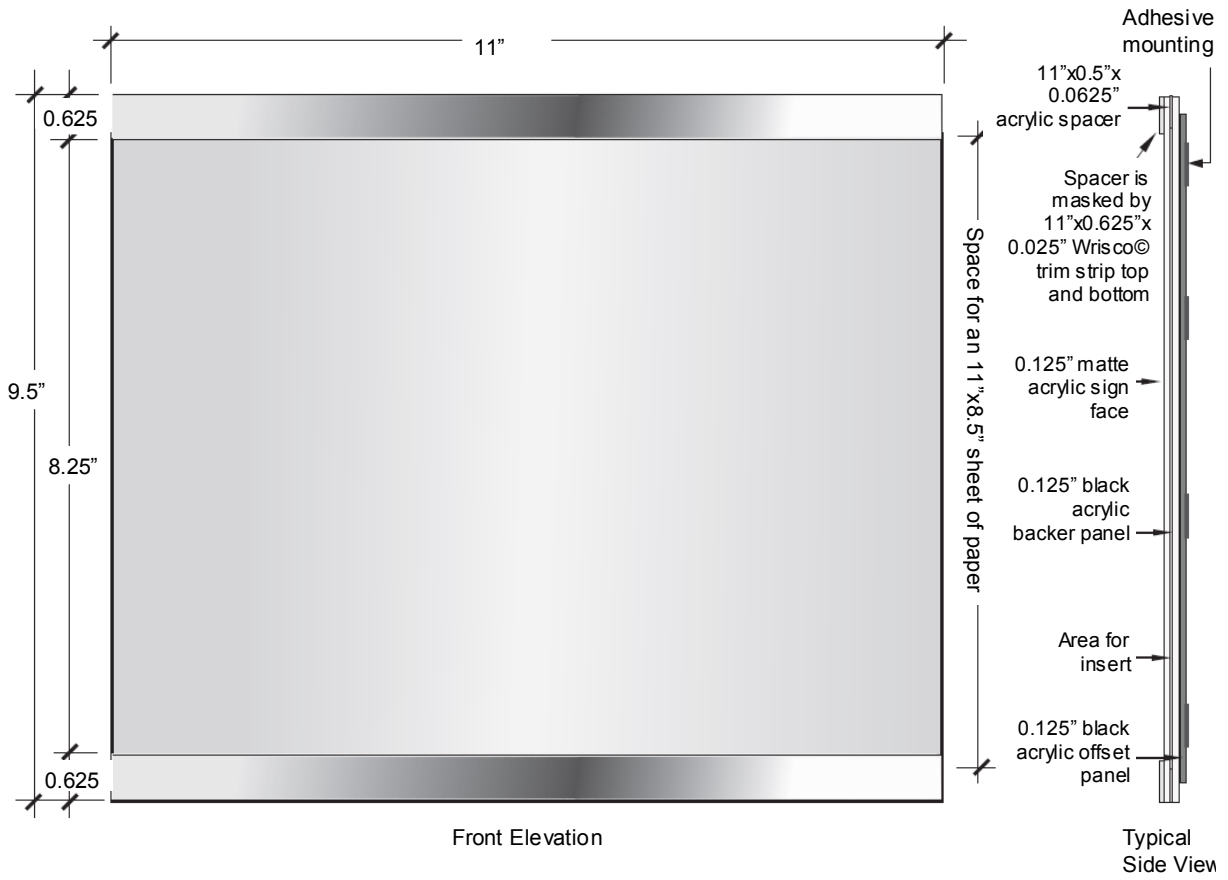

Figure t: Type Q-2 Horizontal Format

PORTLAND STATE UNIVERSITY
DESIGN AND CONSTRUCTION STANDARDS

I. Type R-1

1. Sign Type R-1 provides a single-line permanent Room Number and accepts a half sheet of standard 8.5"x11" paper, Figure u
2. For relight mounting: Sign sandwich is adhered to glass, Figure v
3. Satin aluminum Wrisco© panel is applied to back side of glass "in place: over design, Figure v

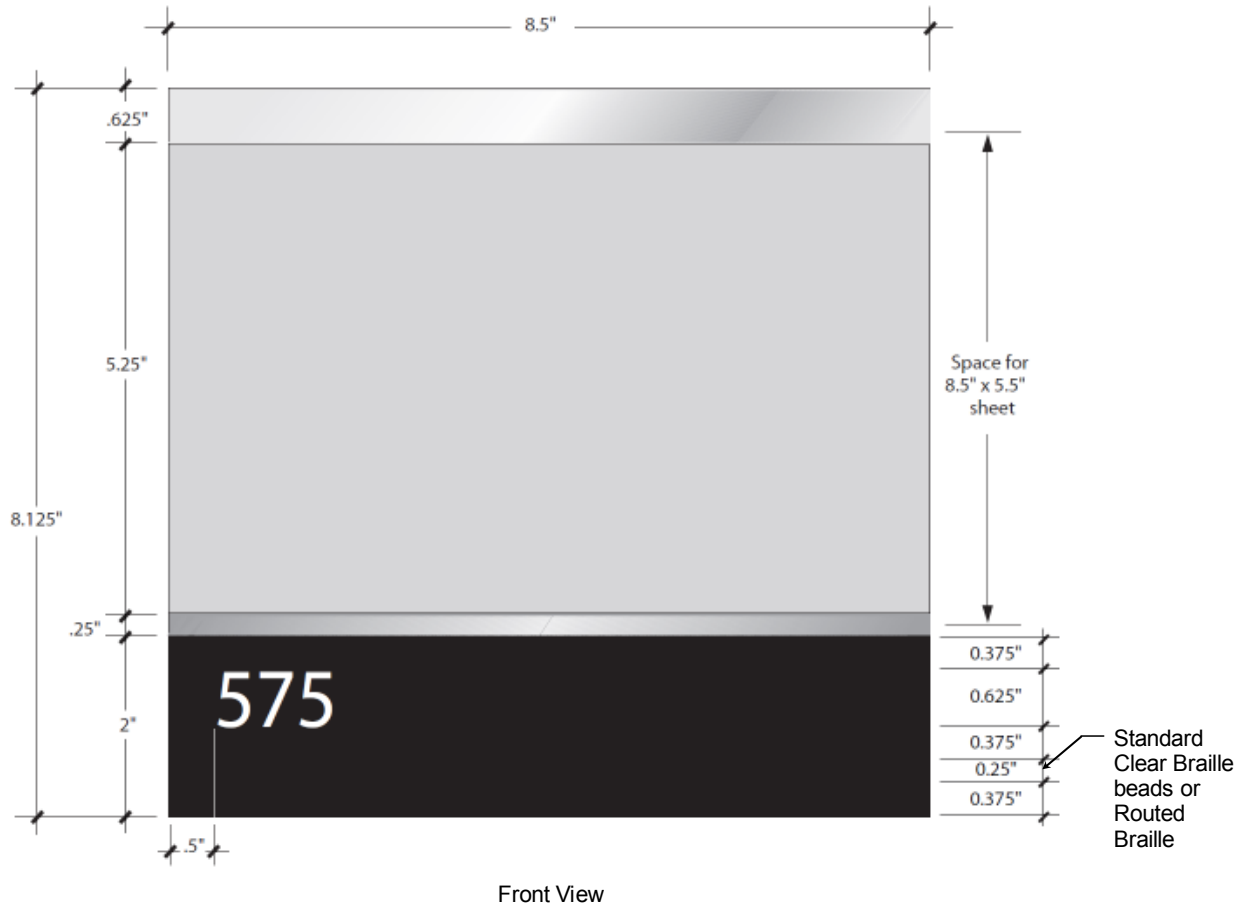

Figure u: Type R-1 Front View

PORTLAND STATE UNIVERSITY
DESIGN AND CONSTRUCTION STANDARDS

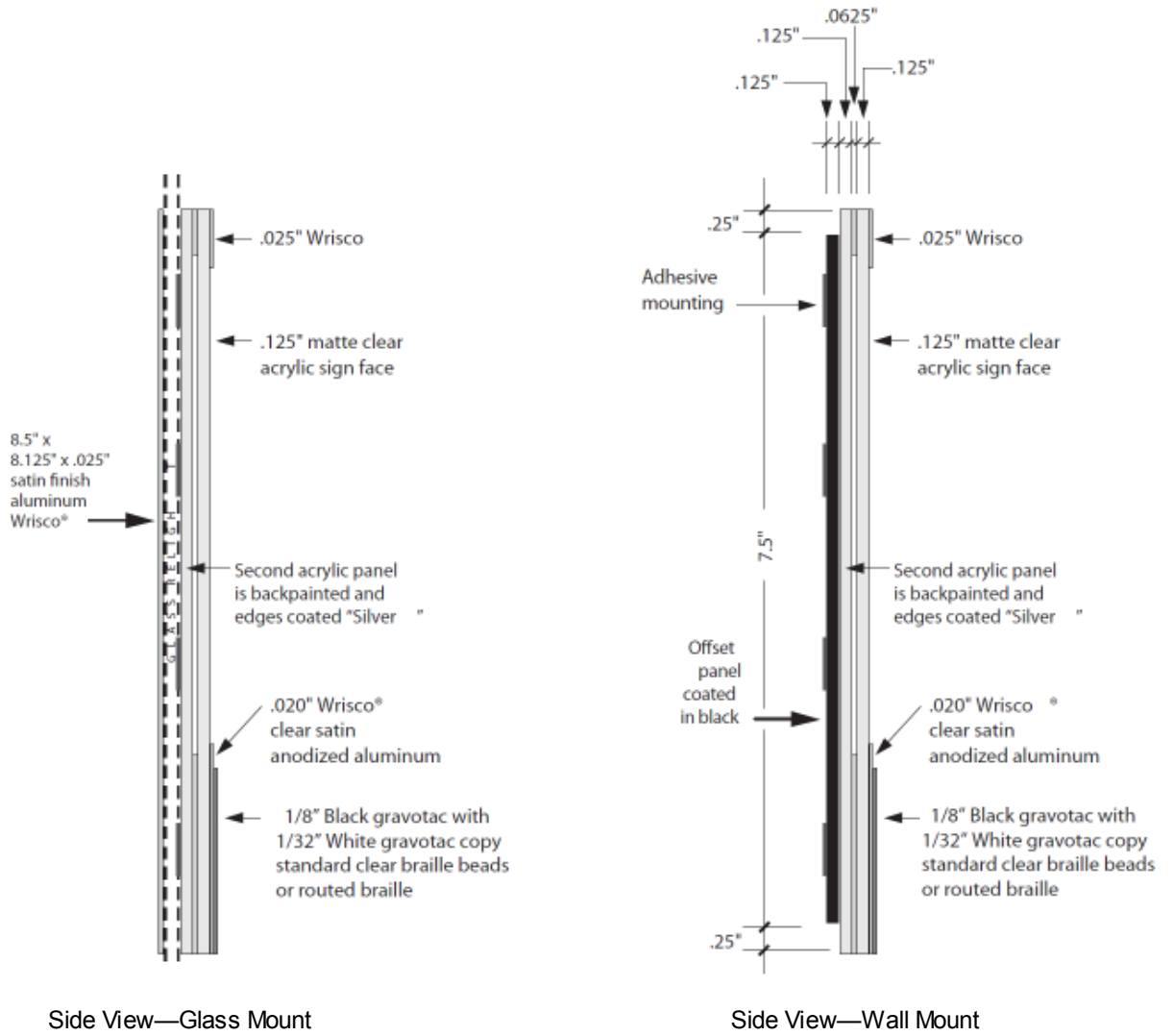

Figure v: Type R-1 Side Views

PORTLAND STATE UNIVERSITY
DESIGN AND CONSTRUCTION STANDARDS

J. Type S

1. Sign Type S provides a Regulatory Message of any text.
2. Message is subsurface silkscreened; panel is back-painted, Figure w
3. Sign centered $\frac{1}{2}$ " below message (Sign Type N-3) or stand alone sign, Figure x

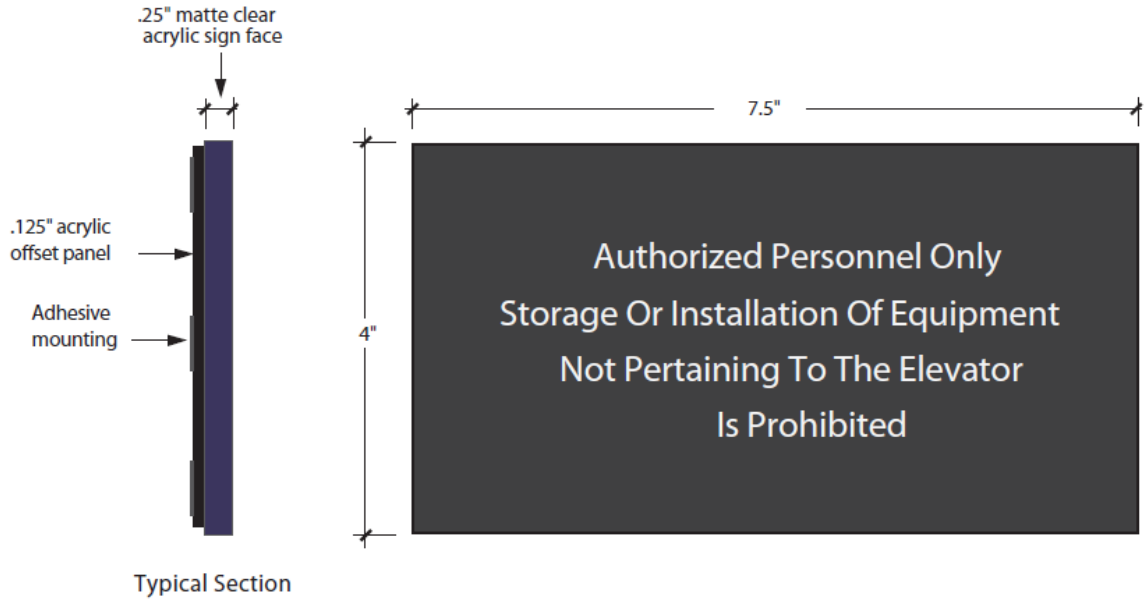

Figure w: Type S

PORTLAND STATE UNIVERSITY
DESIGN AND CONSTRUCTION STANDARDS

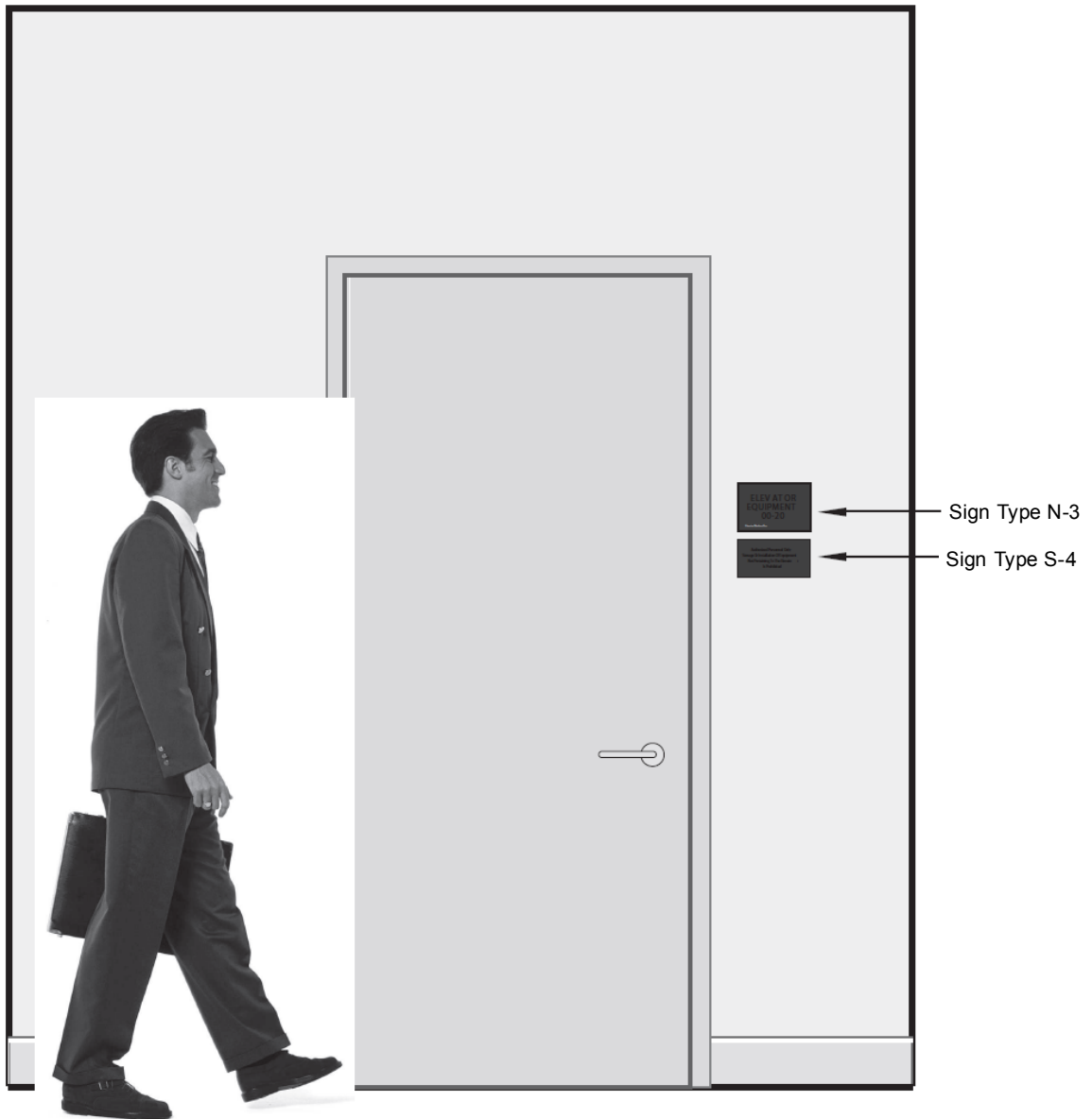

Figure x: Sign Type S Shown with Type N-3

PORTLAND STATE UNIVERSITY
DESIGN AND CONSTRUCTION STANDARDS

K. Type V

1. Sign Type V accepts a standard 11"x8.5" sheet and displays FIRE EXIT ROUTE in raised letters, Figure y

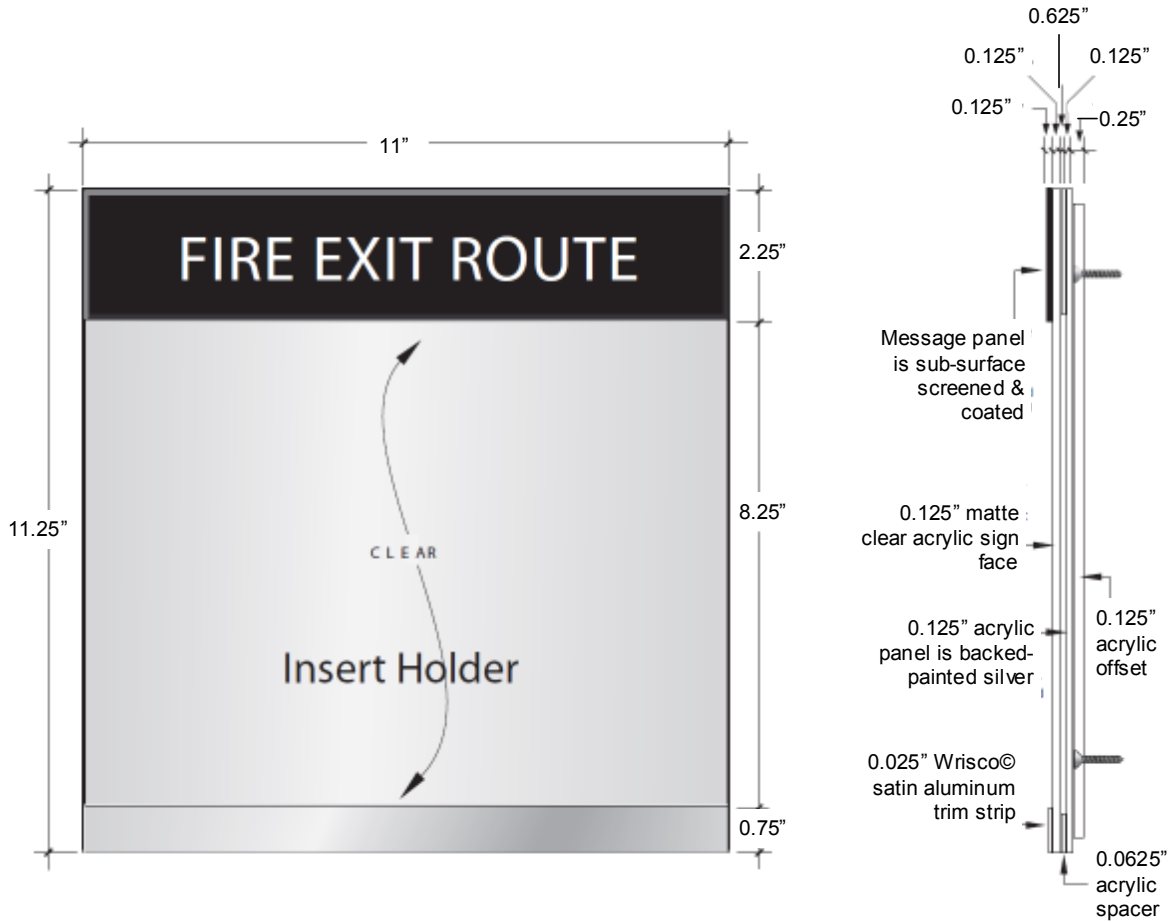

Figure y: Type V

L. Type W

1. Sign Type W displays Minor Regulatory and Informational messages
2. Type W-1, W-2, and W-3 are "black" sign panels with "white" text, Figure z

PORTLAND STATE UNIVERSITY
DESIGN AND CONSTRUCTION STANDARDS

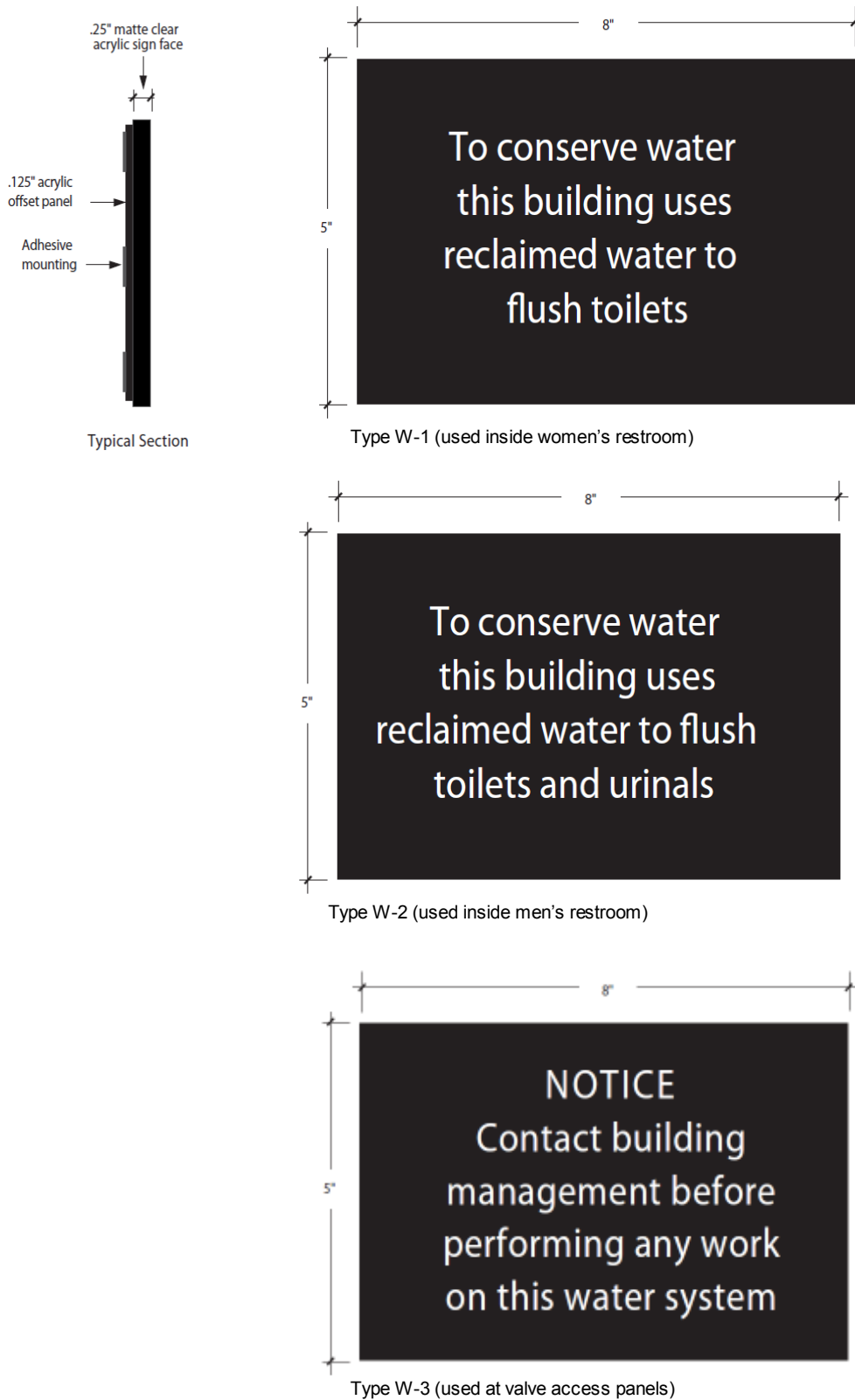

Figure z: Type V

PORTLAND STATE UNIVERSITY
DESIGN AND CONSTRUCTION STANDARDS

2.4 VINYL FILMS (15" ROLLS)

- A. Manufacturer
 - 1. 3M Scotchcal Series 220 Premium film by Gerber
 - 2. Arlon
 - 3. Oracal
 - 4. or Approved Equal
- B. Description
 - 1. Vinyl films used to cut vinyl lettering and signs.

2.5 TRANSFER TAPE

- A. Manufacturer
 - 1. TransferRite
 - 2. R-Tape
 - 3. or Approved Equal
- B. Description
 - 1. Used to transfer vinyl letters to another surface, sign or material.

2.6 VENDOR LIST

- A. Company
 - 1. Architectural Metalcrafters
 - a. 10000 SE Elon St
Clackamas, OR , 97015
Phone: 503.557.7686
Fax: 503.557.7609
 - 2. Think Signs
 - a. 15125 SW Koll Parkway, Ste. C
Beaverton, OR 97006
Phone: 503.644.8305
Fax: 503.644.830
 - 3. Sign Wizards
 - a. Phone: 503.235.6967
Fax: 503.233.2711
 - 4. Pacific Coast Sign Supply
 - a. 940 S.E. 7th Avenue
Portland, OR 97214
Toll-Free: 1.800.752.0028
Phone: 503.232.8535
Fax: 503.239.4206
 - 5. Schonman Signs

PORTLAND STATE UNIVERSITY
DESIGN AND CONSTRUCTION STANDARDS

- a. 4228 SE Mitchell St
Portland, OR 97206
Phone: 503.775.8300
6. Pictoform Inc.
 - a. 414 SE Grand Avenue
Portland, OR 97214
Phone: 503.234.1400
7. Traffic Safety Supply Co.
 - a. 2324 SE Umatilla ST
Portland, OR 97202
Phone: 503-235-8531
Fax: 503.235.5112
8. Multi-Craft Plastics
 - a. 240 N Broadway St
Portland, OR 97227
Phone: 503.281.5157
9. Northwest Sign Supply
 - a. 602 SE Salmon St
Portland, OR 97214
Phone: 503.233.0111
10. Arakawa Hanging Systems
 - a. 2505 SE 11th Avenue Suite 122
Portland, Oregon 97202
Phone: 503.236.0440
Fax: 503.236.0427
11. Sun Supply
 - a. 2310 NW 24th Ave
Portland, OR 97210
Phone: 503.222.5080
12. Denco Sales
 - a. 2119 SE 11th Ave
Portland, OR 97214
Phone: 503.235.0460
13. BYE Engraving
 - a. 7914 SW Barbur Blvd
Portland, OR 97219
Phone: 503.246.4653
14. Laird Plastics
 - a. 2718 SE Raymond
Portland, OR 97202
Toll Free: 1.800.610.1016

PORTLAND STATE UNIVERSITY
DESIGN AND CONSTRUCTION STANDARDS

Phone: 503.233.4861
Fax: 503.236.7658

15. W.C. Winks hardware
 - a. 200 SE Stark St.
P.O. Box 6055
Portland, OR 97228
Phone: 503.227.5536
Fax: 503.227.8457
16. Electro-Chem metal Finishing
 - a. 4849 SE 26th Ave
Portland, OR 97202
Phone: 503.234.2003
FAX: 503.233.8626
17. Beaver metal
 - a. 3019 SW Park Ave.
Milwaukie, OR 97222
Phone: 503.659.2436
18. Benson Industries
 - a. 1650 NW Naito Parkway Suite 250
Portland, OR 97209
Phone: 503.226.7611
Fax: 503.226.0070
19. Gerber Scientific Products
 - a. 83 Gerber Road
South Windsor, CT 06074
Phone: 800.222.7446 (SIGN) or 860.643.1515
Fax: 860.648.8595 (Sales & Marketing)
20. New Hermes Co.
21. Security Signs
 - a. 2424 SE Holgate
Portland, OR, 97202
Phone: 503.232.4172
Fax: 503.433.2321
22. Elite Signs
 - a. 8723 SE Division
Portland, OR, 97266
Phone: 503.775.1638
Fax: 503.775.1663

2.7 CATALOGUE RESOURCES

- A. Company
 1. Victory Corps

PORTLAND STATE UNIVERSITY
DESIGN AND CONSTRUCTION STANDARDS

2. Creative Banner
3. Signs and Banners
4. Emedco
5. Seton
6. Brady
7. Traffic Safety Supply
8. Shiffler
9. Outwater Plastics

PART 3 EXECUTION

3.1 INSTALLATION

- A. All sign installation is governed by the Oregon Fire Code, Chapter 10 Means of Egress.
 1. Exits Signs, Section 1011.1. Where Required. Exits and exit access doors shall be marked by an approved exit sign readily visible from any direction of egress travel. Access to exits shall be marked by readily visible exit signs in cases where the exit or the path of egress travel is not immediately visible to occupants. Exit sign placement shall be such that no point in a corridor is more than 100 feet or the listed viewing distance for the sign, whichever is less, from the nearest visible exit sign.
- B. All Signs that are covered by ADA rules must be ADA compliant.
- C. Sign Font shall be Frutiger Medium, Frobisher, or Equivalent.
- D. The following types of signs shall be mounted at a height of 60 inches to the "center" of the sign.
 1. Sign Type R-1
 2. Sign Type N-1, N-2, and N-3
 3. Sign Type E
 4. Sign Type K-1
 5. Sign Type Q-1
 6. Sign Type P
 7. Sign Type D-8
 8. Sign Type Q-1
 9. Sign Type J-1
 10. Sign Type V-1
- E. Sign Type (L-1, etc) Wall Mounted Flag Signs shall be placed with their lower edge no lower than 87 inches.
- F. Hanging Ceiling Mounted Signs must have 3 inch lettering (White Vinyl over black ½ inch Sintra, or equivalent) and at a minimum of 80 inches above finished floor.

PORTLAND STATE UNIVERSITY
DESIGN AND CONSTRUCTION STANDARDS

- G. Sing Type (R-1) Room ID Signage shall be mounted a minimum of 2 inches and a maximum of 4 inches from the door jamb, and centered at 60 inches to the center of the sign above finished floor.
- H. Any signs mounted on a glass surface must also have a brushed Aluminum backer plate.
- I. Dorm Unit Number on Wall -- ADA mount with Braille at dorm room entry.
- J. Dorm Unit Entry Door -- Remove existing numbers on door patch and paint existing sign anchorage holes.

END OF SECTION

Appendix 27.1
STRUCTURED CABLING
STANDARDS

Structured Cabling Standards

OIT Telecommunication Systems | Fiscal Year 14

The **PSU Structured Cabling System** includes:

- vertical and horizontal copper and fiber optic wiring
- the associated termination hardware on both ends (e.g. jacks, patch panels)
- pathways and conduit
- equipment racks, frames, wire management systems
- telecom closets and voice/data core rooms
- system documentation including database records, maps, inventory and tracking labels

The below specifications are intended to allow OIT-TS to economically meet the voice and data communications requirements of the University over the lifetime of the buildings. It is essential that OIT-TS is consulted prior to and throughout the planning and design process for additions or modifications to campus structured cabling systems to ensure that present and future service requirements can be met and that every effort is made to contain costs to the University.

General Standards

Construction specifications are crucial for a quality Information Technology system. Information Technology systems shall adhere to these specifications in order to be functional in a wide variety of communications applications. This document does not allow or condone the avoidance of following any of the Laws, Standards, or Procedures of any of, but not limited to, the following:

- National Electrical Code (NEC)
- Uniform Building Code (UBC)
- Uniform Fire Code (UFC)
- State of Oregon Low Voltage Laws
- Building Industry Consulting Services International (BICSI)
- ANSI/TIA/EIA Standards

Related Documents

Materials and equipment shall be manufactured, installed and tested as specified in the latest editions of applicable publications, standards rulings and determinations of:

- ANSI – American National Standards Institute
- TIA/EIA – Telecommunications Industry Association/Electronic Industry Alliance
- FCC – Federal Communications Commission

- BICSI – Telecommunications Distribution Method Manual
- NEC – National Electrical Code
- NFPA-70 – National Fire Protection Association
- ANSI/TIA/EIA-568 Commercial Building Telecommunications Cabling Standard
- TIA/EIA-568-B-2.1, Transmission performance specification for 4 pair 100 Ohm Category 5e and Category 6 cabling.
- ANSI/TIA/EIA-569A Commercial Building Standard for Telecommunications Pathway and Spaces
- ANSI/TIA/EIA-606 Commercial Building Standards for the Telecommunications Infrastructure and Spaces
- ANSI/TIA/EIA- 607 Commercial Building Grounding and Bonding Requirements for Telecommunications
- ANSI/TIA/EIA-TSB-67 Telecommunications System Bulletin Technical Systems Bulletin, Transmission Performance Specifications for Field Testing of Unshielded Twisted Pair Cabling Systems

General Wiring Installation Standards

Based on the standards, practices and procedures contained in the references listed above, the wiring of ***new buildings and major remodels of existing buildings*** shall use outlets, jacks, terminal blocks and horizontal wiring that are Category 6 compliant, all other installation shall be Category 5e compliant unless otherwise noted in the scope of work. Major remodels are classified as the total remodel of an existing building or floor within a building which requires the removal of all communications cabling and installation of new communications infrastructure.

For all PSU voice and data communications installations, PSU uses an open architecture design. Communications outlets at workstation and other jack locations shall minimally consist of two gang wall plates equipped with two 8-pin modular (RJ-45) jacks. ***The preferred standard for communications outlets in new construction is four gang wall plates equipped with four 8-pin modular (RJ-45) jacks.*** The number of modular jacks per face plate shall be decided by the use of the area and with the approval of OIT-TS. PSU has standardized on the TE Connectivity SL type workstation components. These components may be substituted with equivalent product only with the prior approval of OIT-TS. Horizontal station wire shall be plenum rated and extend from communications outlets to associated terminal closets and shall be terminated on Intermediate Distribution Frames (IDF's) using TE Connectivity modular patch panels. **All terminated station wiring shall be properly labeled at the outlet faceplate and the IDF per OIT-TS labeling standards.** A copy of the current labeling standard for a campus location will be provided by the OIT-TS Project Coordinator at the time of project commencement.

Terminal closet material standards include the following: 7' x 19" Chatsworth racking system including wire management and tray, TE Connectivity patch panels & Corning fiber optic connectivity housings and panels. TE Connectivity patch panel may be substituted with equivalent product only with prior approval of OIT-TS.

The riser system shall consist of multi-mode & single-mode fiber and Category 3 copper riser cable. The recommended fiber cable is multi-mode, graded-index optical fiber with a nominal 62.5/125 micron core/cladding diameter and single-mode fiber. The copper riser shall be solid copper, 24 AWG, twisted-pair Category 3 backbone cable. The cable jacket shall comply with Article 800 NEC for use as plenum or non-plenum wire, and all cabling and wiring installation shall comply with appropriate code for plenum or non-plenum requirements.

Certification

A BICSI-certified Registered Communications Distribution Designer (RCDD) shall design, engineer and sign off on all projects and will provide oversight during the project. A PSU OIT-TS staff member may meet the BICSI certified requirement if the Contractor does not have this resource available.

All technicians performing horizontal and riser cabling or wiring work must be certified or otherwise qualified in the installation of Category 6/5e wire, jacks, patch panels and terminal blocks. While contractors may choose to use less qualified personnel or workers who are not Category 6/5e certified for "wire pulling or rough in" work, all wire termination work must be performed by technicians who are certified Category 6/5e installers and testers. Contractors may be asked to provide documentation or similar evidence that technicians are qualified Category 6/5e installers and are current with ANSI/EIA/TIA standards. Failure to provide such evidence or documentation could result in the disqualification of the contractor and termination of the work order, service order, or installation agreement or contract.

The above standards describe the general cabling and wiring guidelines to be adhered to by all contractors performing structured cabling and wiring work at PSU. Any exceptions to these standards will be duly noted in the specific Scope of Work for each project. Any deviation from these standards that is not specifically allowed by OIT Telecommunication Systems (OIT-TS) or otherwise delineated in the Scope of Work could be grounds for disqualification of Contractor and termination of the installation agreement/contract.

Quality Control & Assurance Requirements

Testing and Documentation

Contractor shall test all cabling and wiring installed with an approved Category 6/5e tester performing a link test to at least 250 MHz to support a minimum of 1000Mbps Ethernet for Category 6 and a link test of 100 Mhz Ethernet for Category 5e following ANSI/TIA/EIA 568-B standards. Contractors shall test all installed fiber strands for cable integrity using a bi-directional Power Meter with a controlled light source at a wavelength of 850nm & 1300nm for multimode and 1310nm & 1550nm for single mode. Contractor shall record all test results. Any installations that fail the testing shall be corrected and retested. **All recorded results and related testing documentation, including those showing test failures, shall be provided to OIT-TS in electronic format.** OIT-TS reserves the right to randomly test the Category 6/5e throughput at various installation locations to ensure the accuracy and completeness of contractor testing. Should any of these tests fail, OIT-TS may withhold all, or some portion, of the payment due Contractor for wiring installation work.

Upon completion of the project a full set of as-builts shall be provided showing faceplate locations and jack numbers. Jack numbers on the as-builts MUST EXACTLY match physical labels at the installation site. The complete set of as-builts need to be delivered in both hardcopy and electronic format. *****a note about e911***** Oregon Senate Bill 598, implemented January 1 of 2014, requires organizations to report the physical street address of a 911 call to a Public Safety Answering Point (PSAP). PSU OIT-TS must have accurate information on jack locations and labels in order to enter this physical information in our database to report for e911.

Housekeeping and General Clean-up

Contractor shall ensure that all work areas are left in a clean, safe condition at the end of each workday or shift as well as at the end or completion of the entire project. Contractor is responsible only for that work they perform and resulting cleanliness or safety issues. Prior existing conditions are the responsibility of PSU.

Qualifications, Professionalism and Behavior of Contractor Employees

All technicians and other contractor employees performing work on PSU premises shall be highly qualified, skilled professionals who behave in a professional and courteous manner at all times. Contractor employees must have the ability to plan and organize their work efficiently and communicate effectively with OIT-TS staff and other customer contacts in the field.

OIT-TS places a strong emphasis on good customer service and fully expects all contractors and vendors to endorse this service ethic when deploying technicians and other employees on

the PSU campus. All contractor technicians and employees shall wear appropriate work attire on the job and shall present themselves in a professional manner in terms of attire and overall appearance. At least one technician or employee per work group shall wear attire that includes the contractor or vendor logo, business name, etc.

Warranty of Work and Materials

Contractor must guarantee installation work, must warranty the fiber materials, if provided by the Contractor, and is required to describe the nature of Contractor's guarantee in the Bid Response or Quote submitted for this solicitation. The warranty shall cover manufacturing defects in material, if provided by the Contractor, and workmanship under normal and proper use, application assurance, and the installation of all materials.

The minimum warranty period for the installation of horizontal station wiring work shall be 5 years if PSU provides the materials and a minimum of ten years for labor and material if the Contractor provides the materials. Fiber installation warranty shall be a minimum of 5 years if PSU provides the fiber materials and 10 years for labor and materials if Contractor provides the materials.

Protection of Existing Equipment

All existing and active networking and telecommunications hardware installed in PSU campus buildings shall be protected prior to the start of any construction. ***It shall be Contractor's responsibility to effectively protect the owner's network and telecommunications facilities, equipment, and materials from dust, dirt and any other damage during construction.*** Contractor shall take no action that will interfere with, or interrupt, existing building network and telecommunications services unless previous arrangements have been made with OIT-TS or the appropriate building owner's representative. If any shutdown of network or telecommunications services or systems is required for Contractor to perform work, Owner's personnel will perform shutdown of affected systems. Contractor must provide Owner with a minimum of three (3) days' advance notice for such system shutdowns. ***Should Contractor cause network or telecommunications services or systems to be interrupted in any way, Contractor shall be solely responsible for all costs associated with satisfactorily restoring or replacing services or systems to include all labor and materials required to restore or replace services or systems.*** All service or system restoration or replacement by Contractor must be approved by OIT-TS.

Communications Facilities Requirements

Cramer Hall Telecom and Data Core

The main telephone equipment switchroom typically houses the telephone system (PBX) cabinets and servers; equipment racks for data networking equipment; UPS equipment; the wall field for cross-connecting the equipment cables, riser cables, intra-campus BET cables, and ILEC/CLEC entrance cables; a workstation; and storage space for maintenance spares, tools and test equipment.

At PSU, there are typically two types of switchrooms: 1) the main switchroom which houses the central PBX cabinetry that serves the entire campus; and 2) satellite switchrooms for remote PBX cabinets or voice gateways that are connected via leased or PSU owned outside plant facilities back to the main campus switchroom. Since the main switchroom for the campus is in place and rather permanent in nature, this facilities requirement addresses ***satellite switchrooms which typically are required for new off campus buildings or similar major facilities construction projects*** where it's more efficient and effective to install remote PBX cabinets or voice gateways versus extending additional cable plant facilities to serve extensions directly off the main PBX.

The minimum size requirement for a satellite switchroom is 10' x 15'. Minimum clear height in the room shall be 8 feet without obstructions. The access door to the room shall be at least 36 inches wide and 80 inches high, with doorsill, and shall be fitted with a lock. A minimum of two walls should be covered with rigidly fixed (3/4 trade size) A-C plywood preferably void free, 8ft. high, capable of supporting attached equipment. Plywood should be either fire rated or covered with two coats of fire retardant paint.

A separate power supply circuit serving the switchroom shall be provided and terminated in its own electrical panel. Power supply (including lights) in the switchroom shall be on emergency power. Power shall be sufficient to support the equipment load and supporting facilities for the switchroom. A 1-½ trade-size conduit shall be provided from the switchroom to the building grounding electrode.

The preferred location for the switchroom is the first floor (or ground floor) or a basement or sub-basement. It is desirable to locate the switchroom close to the main backbone network and building outside telephone company cable entrance site for ease of connectivity to these network and distribution facilities.

When selecting the room site, avoid locations that are restricted by building components that limit expansion such as elevators, core, outside walls or other fixed building walls. Ease of accessibility to the space is important for the delivery of large equipment. The switchroom shall be located away from sources of electromagnetic interference at a distance that will reduce the

interference to 3.0 V/m throughout the electromagnetic frequency spectrum. Special attention shall be given to electrical power supply transformers; motors and generators; x-ray equipment; radio, cell phone or radar transmitters; and induction sealing devices. The switchroom shall be located with ready access to the main HVAC delivery system to ensure sufficient airflow and cooling.

HVAC shall be provided on a 24 hours-a-day, 365 days-per-year basis. The temperature and humidity shall be controlled to provide continuous operating ranges of 64° F to 72° F with 30% to 55% relative humidity. The ambient temperature and humidity shall be measured at a distance of 5 feet above the floor level, after the equipment is in operation, at any point along the equipment aisle. A positive pressure differential with respect to surrounding area should be provided.

The switchroom shall be provided with the proper fire suppression system. Appropriate portable fire extinguishers shall be provided and maintained within the switchroom. They should be located as close as practicable to the switchroom entry or exit. Additionally, some form of temperature alarm system should be installed to provide an early warning to a remote monitoring site of temperatures exceeding 75° F.

The interior finishes of the switchroom shall be light in color to enhance room lighting. The floors, walls and ceiling shall be sealed to reduce dust. Flooring materials having antistatic properties shall be used. Lighting shall be a minimum of 540 lx (50 candles) measured 3 feet above the finished floor in the middle of equipment aisles between cabinets. One or more switches located near the entrance door to the room shall control the lighting. **Lighting fixtures shall not be powered from the same electrical distribution panel as the telecommunications equipment in the room.** Emergency lighting and signs should be properly placed in the room where absence of light would hamper emergency exit.

Terminal Closets for Phone System and Data Networking Equipment

There shall be at least one terminal closet per floor. Additional closets should be provided when the floor area exceeds 10,000 sq. ft. or the horizontal distribution distance to the workstation exceeds 90 meter (300 ft). There are typically two size scenarios for terminal closets: 1) the ideal situation where there is ample space to provide a minimum closet size of 10 ft. by 8 ft. with a single door at least 30 inches wide and 80 inches tall, opening out; and 2) the limited space scenario where the closet size should be a minimum of 7 ft. wide and 30 inches deep, both of which are inside dimensions, provided the closet is accessed via double doors which swing out away from the closet. **In either scenario, the closet should be at least 8 feet high.**

Each closet shall have sufficient power and lighting. PSU's minimum power requirements are two dedicated 20 amp duplex power outlet per closet. Power supply (including lights) in the closet shall be on emergency power. Additionally, **each closet shall have adequate airflow to ensure that operating temperatures do not drop below 50° F or exceed 80° F.**

Closets shall be “centrally located” on each floor, or located so that horizontal station wires runs to user work stations and phones do not exceed 200 feet. The preferred standard for station wire is 150 feet.

Each closet shall have sufficient sleeves, slots, conduits, or similar floor penetrations necessary to allow for ease of installation of telecommunications cabling and wiring. Such penetrations shall be properly firestopped per the applicable building codes. A minimum of two walls should be covered with rigidly fixed (3/4 trade size) A-C plywood preferably void free, 8ft. high, capable of supporting attached equipment. Plywood should be either fire rated or covered with two coats of fire retardant paint.

Horizontal Pathways

Horizontal pathways and spaces consist of structure that conceal, protect and support horizontal cables between the workstation outlet and the telecommunications terminal closet. When designing a building, the layout and capacity of the horizontal distribution systems must be thoroughly documented in the floor plans and other building specifications.

Every ceiling distribution system must provide proper support for cables from the telecommunications terminal closet to the work areas it serves. ***Ceiling panels, support channels (T-bars), and vertical supports are NOT proper supports.*** Ceiling conduits, raceways, cable trays, and cabling must be suspended from or attached to the structural ceiling or walls with hardware or other installation aids specifically designed to support their weight. The pathways must have adequate support to withstand pulling the cables and be installed with at least 3 inches of clear vertical space above the ceiling tiles and support channels (T-bar) to ensure accessibility.

Conduit

Conduit types include electrical metallic tubing, rigid metal conduit, and rigid PVC. Conduits shall be of the type permitted under the appropriate electrical codes. **Metal flex conduit is not recommended due to cable abrasion problems and is not covered in this standard.** Fish tape or pull cord/string shall be installed in all conduits.

Any single conduit run extending from a telecommunications terminal closet shall not serve more than three communications outlets. Conduit shall be sized per Table 1.1, below, and be incrementally increased in size from the furthest outlet toward the telecommunications closet. No section of conduit shall be longer than 30 m (100 ft) or contain more than two 90° bends between pull boxes. A third bend may be acceptable in a pull section without derating the conduit’s capacity if the run is not longer than 10 m (33 ft) or the conduit size is increased to the next trade size.

TABLE 1.1

CONDUIT			NUMBER OF CABLES									
INTERNAL DIAMETER		TRADE SIZE	3.3	4.6	5.6	6.1	mm (in)		7.9			
9.4	13.5	15.8					7.4					
Mm	(in)		(.13)			(.18)	(.22)	(.24)	(.29)	(.31)	(.37)	
(.53)	(.62)											
15.8	0.62	½	1	1	0	0	0	0	0	0	0	0
20.9	0.82	¾	6	5	4	3	2	2	1	0	0	0
26.6	1.05	1	8	8	7	6	3	3	2	1	0	0
35.1	1.38	1 ¼	16	14	12	10	6	4	3	1	1	1
40.9	1.61	1 ½	20	18	16	15	7	6	4	2	1	1
52.5	2.07	2	30	26	22	20	14	12	7	4	3	3
62.7	2.47	2 ½	45	40	36	30	17	14	12	6	3	3
77.9	3.07	3	70	60	50	40	20	20	17	7	6	6

Pull Boxes

Pull boxes shall be used for the following purposes:

- a) Fishing the conduit run.
- b) Pulling the cable to the box and then looping the cable to be pulled into the next length of conduit.

Pull boxes shall be placed in an exposed manner and location, and readily accessible. Pull boxes shall not be placed in a fixed, false ceiling space unless immediately above a suitably marked, hinged panel.

A pull box shall be placed in a conduit run where:

- 1) the length is over 30 mm (100 ft);
- 2) there are more than two 90° bends; or,
- 3) if there is a reverse bend in the run.

Boxes shall be placed in a straight section of conduit and not used in lieu of a bend. The corresponding conduit ends should be aligned with each other.

Surface Raceway

Surface raceway, consisting of base, cover, couplings, elbows, and similar fittings, mounts directly on wall surfaces at appropriate work levels to provide a continuous perimeter pathway. Telecommunications outlets are located in cover fittings along the raceway. The electrical contractor shall provide faceplates for the surface raceway.

The practical capacity for telecommunications wiring in perimeter raceways ranges from 30% to 60% fill depending on cable-bend radius. The pathway size shall be calculated as follows: the summation of the cross-sectional area of all cables divided by the percent (expressed as a decimal fraction) of fill.

Grounding and Bonding

Grounding shall meet the requirements of the NEC and additionally grounding bonding shall conform to ANSI/TIA/EIA-607. When applicable, horizontal cabling and connecting hardware must be grounded and bonded in compliance with ANSI/NFPA 70 requirements and practices. When grounding telecommunications cabling, ensure that the installation conforms with proper practices and codes (ANSI/TIA/EIA-607, ANSI/NFPA 70, and local building codes).

An approved ground is available at the telecommunications terminal closet for:

- Cross-connect frames
- Patch panel racks
- Active telecommunications equipment
- Test apparatus used for maintenance and testing

**Any questions about these standards should be directed to
PSU OIT Telecommunication Systems**

Phone: 503-725-4434 | Email: OIT-TS-Group@pdx.edu

ACCEPTANCE OF CONTRACTOR WORK

PROJECT _____ DATE _____

YES NO

_____ Approved material used.

_____ Labeling of horizontal wire per standards.

_____ Installation of all equipment per standards.

_____ ANSI/EIA/TIA and local codes followed.

_____ Documentation of test results provided for horizontal wire.

_____ Documentation of test results provided for fiber work.

_____ As-builts provided per bid document.

_____ Housekeeping and general clean up.

NOTES:

Appendix 28.1
ACCESS CONTROL

PORTLAND STATE UNIVERSITY
DESIGN AND CONSTRUCTION STANDARDS

APPENDIX 28.1 – **ACCESS CONTROL**

PART 1 GENERAL

1.1 STANDARDS OF PERFORMANCE

- A. PSU currently has an exclusive contract for Lenel Security Management Software System for electronic access control in campus buildings. The system is managed by PSU Office of Information Technology (OIT), with the central station being monitored by Campus Public Safety Office staff. Installations, repairs or other work done on system must be performed by certified Lenel personnel, coordinated by OIT for Capital Projects & Construction design and construction projects.
- B. New construction or remodels must include Access Control features on exterior doors. Interior doorways will be included only as determined by FAP project manager and client based on security requirements.
- C. PSU to provide, install, and activate access control low voltage cabling and devices.
- D. Contractor to provide complete installation in walls include conduit and boxes for card readers. Do not penetrate structure or existing fire walls.
- E. The (6) major access control devices at doors are following:
 - 1. Magnetic swipe or proximity card reader
 - 2. Door contact
 - 3. REX (request to exit motion detector)
 - 4. Sounder
 - 5. Electric lock or electric exit device
 - 6. Power Transfer hinge.
- F. The (4) types of access doors
 - 1. Card Reader Door (items 1-6)
 - 2. Auto lock Door (items 1, 3-6)
 - 3. Exit only Door (items 2,3,4)
 - 4. Emergency Exit only Door (items 2,4)

1.2 RELATED SECTIONS

- A. 08 31 00 Access Doors and Panels

PART 2 PRODUCTS

2.1 CONTROL PANEL

- A. Manufacturer
 - 1. Lenel
- B. Description
 - 1. Lenel components:

PORTLAND STATE UNIVERSITY
DESIGN AND CONSTRUCTION STANDARDS

- a. (1) LNL-2000 Intelligent System Controller, for which a LAN drop will be provided by PSU. LNL-2000 ISC shall have 7Mb memory expansion, unless otherwise directed.
 - b. (1) LNL-8000 8-port RS485 Bus Expander
 - c. (1) or more LNL-1300 single reader interface module(s)
 - d. (1) or more LNL-1320 dual reader interface module(s)
 - e. (1) or more LNL-1100 16-input module(s)
 - f. (1) or more LNL-1200 16-output module(s)
2. Strike output relays shall be isolated from the electric locking devices they control.

2.2 LOW VOLTAGE CABELING

- A. Manufacturer
 1. Approved Equals
- B. Description
 1. Provide and coordinate all low voltage cabeling to all components for a complete working system including for the following door items as required to occur : HID Proximity card reader, Magnetic door contact, Infrared Request-to-exit sensor, Electric strike or Electric lock, and Electrified panic hardware.

2.3 ENCLOSURES

- A. Manufacturer
 1. Hoffman
- B. Description
 1. Primary central panel enclosures shall be 36x30 steel, with cabinet tamper switches.

2.4 POWER SUPPLIES

- A. Manufacturer
 1. Altronix or Alarm-Saf
- B. Description
 1. None Specified

2.5 DOOR ITEMS

- A. Manufacturer
 1. As Noted
- B. Description/Location
 1. Door: wood or metal door, in wood or metal door frame, gyp brd with stud wall construction
 - a. (1) HID Thinline proximity card reader, black, wall mounted adjacent to door at 40" AFF on centerline.
 - b. (1) Sentrol 1078 Series 1" magnetic door contact

PORTLAND STATE UNIVERSITY
DESIGN AND CONSTRUCTION STANDARDS

- c. (1) DS160 series infrared request-to-exit sensor*
 - d. (1) Von Duprin 6211 Series electric strike with Donjo latch guard
 - e. (1) Electrified Schlage D-Lock and 4-wire Hagar Transfer Hinge at concrete or masonry walls.
2. Door: single aluminum storefront door, sheetrock or curtain wall construction
- a. (1) HID Thinline proximity card reader, black, wall mounted adjacent to door at 40" AFF on centerline OR
 - b. (1) HID Miniprox mullion proximity card reader, charcoal, mullion mounted at 40" AFF on centerline
 - c. (1) Sentrol 1078 Series 1" magnetic door contact w/ rare earth magnet
 - d. (1) DS160 series infrared request-to-exit sensor*
 - e. (1) Von Duprin 6111 Series electric rim strike OR
 - f. Electrified panic hardware
3. Double Doors
- a. As for single doors above, except for locking Double door w/existing vertical rods: Vertical rod panic hardware shall be converted to solenoid operated vertical rods with associated booster power supply.

PART 3 EXECUTION

3.1 INSTALLATION

- A. Install per manufacturer's specifications and recommendations.

END OF SECTION