

cattelan
italia

10

COLLECTION 2020



COLLECTION 2020

INDEX

BOOK 10

TAVOLI

Dining Tables_Tables_Mesas_Tische_Столы_桌子

Page	
12	Butterfly
18	Butterfly Keramik
66	Mad Max CrystalArt
58	Mad Max Keramik
62	Mad Max Keramik Premium
64	Mad Max Wood
70	Marathon
20	Skorpio
24	Skorpio Wood
50	Tyron CrystalArt
28	Tyron Keramik
38	Tyron Keramik Premium
42	Tyron Wood

TAVOLI ALLUNGABILI

Extendible Dining Tables_Tables à rallonges
Mesas Extensibles_Verlängbare Tische
Столы с раскладкой_可延展桌子

Page	
54	Tyron CrystalArt Drive
34	Tyron Keramik Drive

CONSOLLE

Consoles_Consoles_Consolas
Konsolen_Консоли_边几

Page	
94	Etoile
98	Terminal Keramik Premium
102	Westin

CONSOLLE DA TRUCCO

Dressing table_Coiffeuse_Escritorio para maquillaje
Toilettentisch_Консоль для макияжа_梳妆台

Page	
88	Cocoon Trousse Keramik
92	Cocoon Trousse Leather

SCRIVANIE / SCRITTOI

Desk_Bureaux_Escritorio_Schreibtische
Письменные Столы_书桌

Page	
82	Cocoon Keramik
86	Cocoon Leather
74	Nasdaq Keramik

SEDIE

Chairs_Chaises_Sillas_Stühle_Стулья_椅子

Page	
132	Bombè
136	Bombè X
140	Chris
142	Chrishell
144	Chris ML
146	Chrishell ML
108	Italia
112	Italia Couture
122	Magda ML
126	Magda ML Couture
148	Norma B
104	Penelope
120	Rhonda
130	Wilma
116	Zuleika

SGABELLI

Stools_Tabourets_Taburetes
Barhocker_Барные Стулья_吧椅

Page	
150	Norma Sgabello
150	Norma Couture Sgabello
152	Norma ML Sgabello
152	Norma ML Couture Sgabello
158	Pancho Sgabello
154	Sofia Sgabello
156	Wanda Sgabello

MADIE

Sideboards_Crédences
Aparadores_Sideboards_Буфеты_边柜

Page	
176	Boutique Alta
168	Focus CrystalArt
166	Kayak
160	Lavander
164	Spiga
172	Tudor

VETRINE

Showcases_Vitrines_Vitrinas
Vitrinen_Витрины_展示架

Page	
180	Atelier

LIBRERIE

Bookcases_Bibliothèques
Estererías_Bücherregale_Библиотеки_书架

Page	
204	Latitude
196	Freeway
208	Spinnaker
212	Trap

TAVOLINI

Coffee Tables_Tables Basses_Mesitas
Couchtische_Журнальные Столики_茶几

Page	
182	Arena
182	Arena Bond
190	Pancho
194	Sinai
186	Spillo

LETTI

Beds_Lits_Camas_Betten_Кровати_展示架

Page	
214	Ayrton

TAPPETI

Rugs_Tapis_Alfombras_Teppiche
Ковры_地毯

Page	
218	Marek

LAMPADE A SOSPENSIONE

Ceiling Lamp_Suspension
Lámpara de techo_lampada da soffitto
Hängelampe_Потолочная люстра_吊灯

Page	
220	Heaven
224	Katana
226	Magellano
230	Zanziball





Tavoli
Tables



Butterfly page 12



Butterfly Keramik page 18



Mad Max CrystalArt page 66



Skorpio page 20



Skorpio Wood page 24



Tyron CrystalArt page 50

Tavoli Allungabili
Extendable Tables



Tyron CrystalArt Drive page 54



Tyron Keramik Drive page 34

Consolle
Consoles



Etoile page 94



Terminal Keramik Premium page 98



Westin page 102



Mad Max Keramik page 58



Mad Max Keramik Premium page 62



Mad Max Wood page 64



Marathon page 70



Tyron Keramik page 28



Tyron Keramik Premium page 38



Tyron Wood page 42

Scrivanie / Scrittoi
Writing Desks / Desks



Nasdaq Keramik page 74



Cocoon Keramik page 82



Cocoon Leather page 86

Consolle da Trucco
Trousse Console



Cocoon Trousse Keramik page 88



Cocoon Trousse Leather page 92

Sedie
Chairs



Bombè page 132



Bombè X page 136



Chris page 140



Italia Couture page 112



Magda ML (A-B) page 122



Magda ML Couture (A-B) page 126



Norma B page 148

Sgabelli
Stools



Norma sgabello page 150



Norma Couture Sgabello page 150



Norma ML Sgabello page 152

Madie
Sideboards



Focus CrystalArt page 168



Kayak page 166

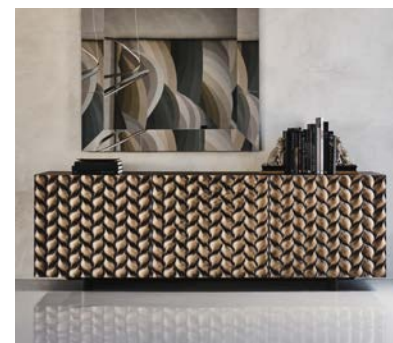

Lavander page 160



Chrishell page 142



Chris ML page 144



Chrishell ML page 146



Italia page 108



Penelope page 104



Rhonda page 120



Wilma page 130



Zuleika page 116



Norma ML Couture Sgabello page 152



Pancho Sgabello page 158



Sofia Sgabello page 154



Wanda Sgabello page 156



Boutique Alta page 176



Spiga page 164



Tudor page 172

Librerie
Bookcases



Latitude page 204

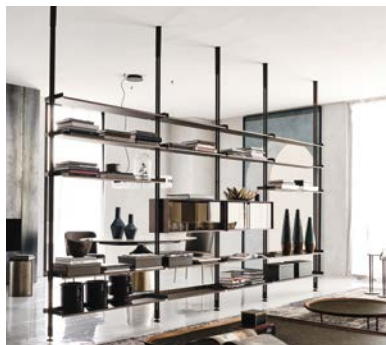

Freeway page 196



Freeway page 196

Tavolini
Coffee Tables



Arena page 182



Arena Bond page 182



Pancho page 190

Lampade
Lamps



Heaven page 220



Katana page 224



Magellano page 226

Letto
Bed



Ayrton page 214

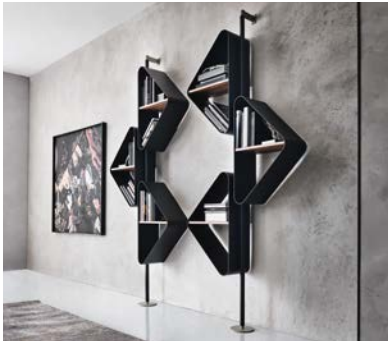

Spinnaker page 208



Trap page 212

Vetrina
Showcase



Atelier page 180



Sinai page 194



Spillo page 186

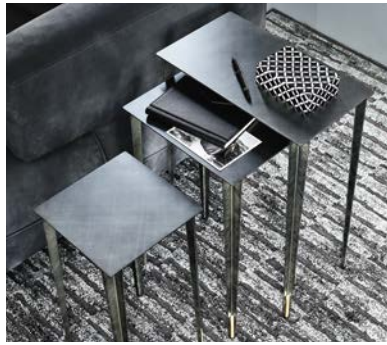

Spillo page 189



Zanziball page 230

Tappeto
Carpet

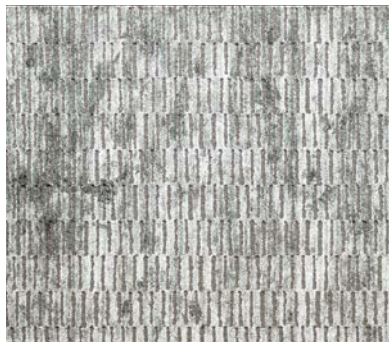

Marek page 218





Butterfly

Nucleo+ | 2020

Tavolo con base in acciaio verniciato gofrato titanio o bronzo, Brushed Bronze o Brushed Grey. Piano in cristallo 15mm trasparente, trasparente extrachiaro o trasparente extrachiaro con bordi bisellati inversi. Piano in appoggio.

Table with base in titanium or bronze embossed lacquered steel, Brushed Bronze or Brushed Grey lacquered steel. Top in 15mm clear, extra clear or extra clear glass with reversed bevelled edges. The top is laid on the base.

Table avec base en acier laqué gaufré titane ou bronze, Brushed Bronze ou Brushed Grey. Plateau en verre clair 15 mm, extra-clair ou extra-clair avec bords biseautés inversés. Plateau en appui.

Mesa con base en acero barnizado gofrado titanio o bronzo, Brushed Bronze o Brushed Grey. Sobre en cristal 15mm transparente, transparente extraclaro o transparente extraclaro con bordes biselados inversos. Sobre en apoyo.

Esstisch mit Basis aus Metall lackiert titan oder bronze gaufriert, Brushed Bronze oder Brushed Grey. Platte in 15mm Glas transparent, extra hell transparent, oder extra hell mit Kanten umgekehrt facettiert. Die Platte ist auf der Basis aufgelegt.

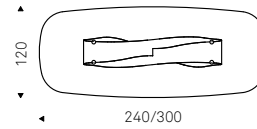
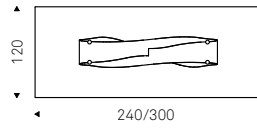
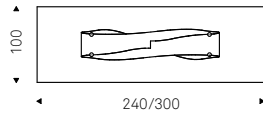
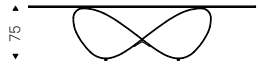



BUTTERFLY table with brushed grey base and extra clear glass top - ZULEIKA chairs in leather 51 castoro - PLANETA S lamp - WISH MAGNUM mirror with titanium frame









BUTTERFLY table with brushed grey base and extra clear glass top - ZULEIKA chairs in leather 51 castoro - PLANETA S lamp - WISH MAGNUM mirror with titanium frame

Butterfly Keramik

Nucleo+ | 2020

Tavolo con base in acciaio verniciato gofrato titanio o bronzo, Brushed Bronze o Brushed Grey. Piano in ceramica Marmi nei colori Calacatta, Alabastro, Ardesia, Golden Calacatta opaco, Golden Calacatta lucido, Portoro opaco, Portoro lucido, Sahara Noir lucido, Emperador, Makalu, Breccia o Arenal.

Table with base in titanium or bronze embossed lacquered steel, Brushed Bronze or Brushed Grey lacquered steel. Top in ceramic Marmi Calacatta, Alabastro, Ardesia, matt Golden Calacatta, glossy Golden Calacatta, matt Portoro, glossy Portoro, glossy Sahara Noir, Emperador, Makalu, Breccia or Arenal.

Table avec base en acier laqué gaufré titane ou bronze, Brushed Bronze ou Brushed Grey. Plateau en céramique Marmi dans les couleurs Calacatta, Alabastro, Ardesia, Golden Calacatta opaque, Golden Calacatta brillant, Portoro opaque, Portoro brillant, Sahara Noir brillant, Emperador, Makalu, Breccia ou Arenal.

Mesa con base en acero barnizado gofrado titanio o bronzo, Brushed Bronze o Brushed Grey. Sobre en cerámica Marmi colores Calacatta, Alabastro, Ardesia, Golden Calacatta mate, Golden Calacatta brillo, Portoro mate, Portoro brillo, Sahara Noir brillo, Emperador, Makalu, Breccia o Arenal.

Esstisch mit Basis aus Metall lackiert titan oder bronze gaufriert, Brushed Bronze oder Brushed Grey. Platte in Keramik Marmi in den Farben Calacatta, Alabastro, Ardesia, matt Golden Calacatta, glänzend Golden Calacatta, matt Portoro, glänzend Portoro, glänzend Sahara Noir, Emperador, Makalu, Breccia oder Arenal.

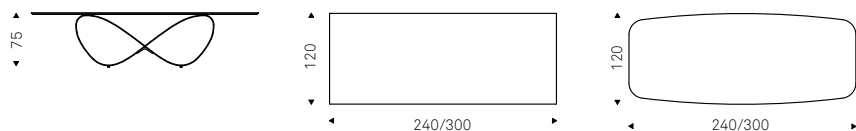

BUTTERFLY KERAMIK table with titanium base and makalu ceramic top



BUTTERFLY KERAMIK table with bronze base and breccia ceramic top



BUTTERFLY KERAMIK table with titanium base and glossy sahara noir ceramic top

Skorpio

Andrea Lucatello | 2014

Tavolo con base in acciaio verniciato goffrato titanio, bronzo, graphite, bianco o nero, Brushed Bronze o Brushed Grey. Piano in cristallo 15mm trasparente, trasparente extrachiario o trasparente extrachiario con bordi bisellati inversi. I piani 160x90, 182x90 e 200x106 hanno spessore 12mm. Piano in appoggio.

Table with base in titanium, bronze, graphite, white, or black embossed lacquered steel, Brushed Bronze or Brushed Grey lacquered steel. Top in 15mm clear, extra clear or extra clear glass with reversed bevelled edges. Glass top 12mm on 160x90, 182x90 and 200x106 versions. The top is laid on the base.

Table avec base en acier laqué gaufré titane, bronze, graphite, blanc ou noir, Brushed Bronze ou Brushed Grey. Plateau en verre clair 15 mm, extra-clair ou extra-clair avec bords biseautés inversés. Les plateaux 160x90, 182x90 et 200x106 sont de 12mm. Plateau en appui.

Mesa con base en acero barnizado gofrado titanio, bronzo, graphite, blanco o negro, Brushed Bronze o Brushed Grey. Sobre en cristal 15mm transparente, transparente extraclaro o transparente extraclaro con bordes biselados inversos. Los sobros 160x90cm, 182x90cm y 200x106cm son de 12mm. Sobre en apoyo.

Esstisch mit Basis aus Metall lackiert titan, bronzo, graphite, weiß oder schwarz gaufriert, Brushed Bronze oder Brushed Grey. Platte in 15mm Glas transparent, extra hell transparent, oder extra hell mit Kanten umgekehrt facettiert. Platten in 160x90, 182x90 und 200x106 haben 12 mm Dicke. Die Platte ist auf der Basis aufgelegt.

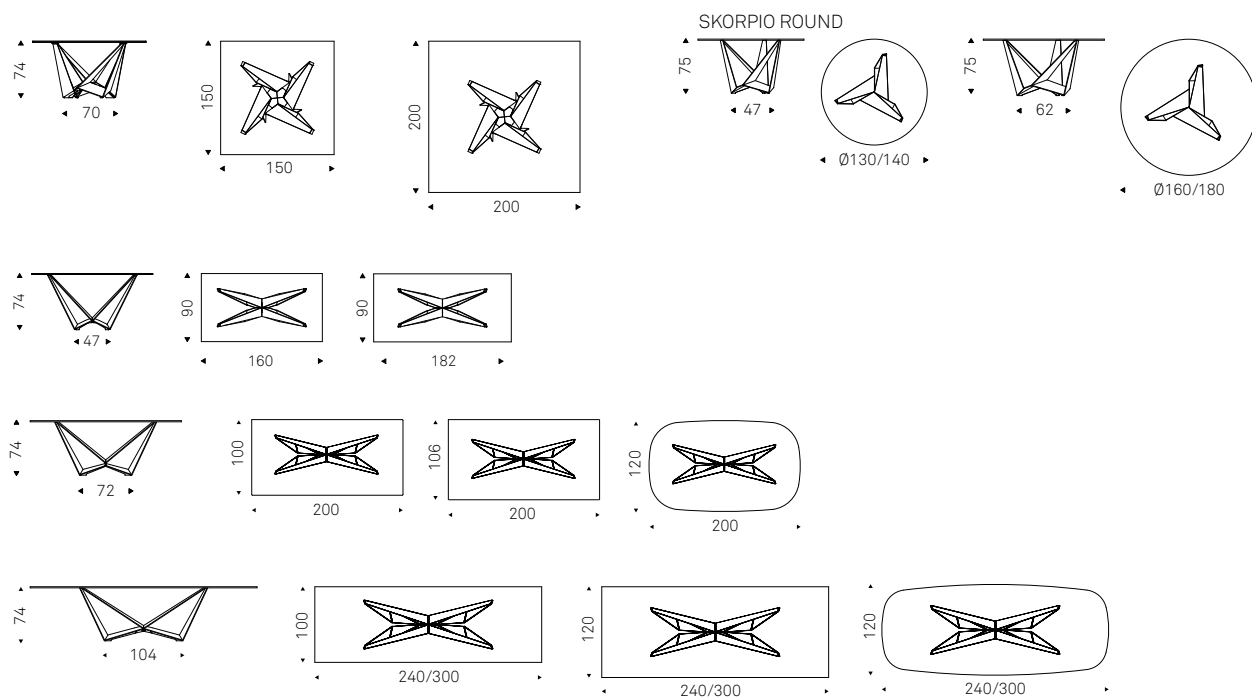

SKORPIO table with titanium base and extra clear glass top - RITA chairs in soft leather 953 ardesia and titanium frame



SKORPIO table with brushed grey base and extra clear glass top - ITALIA COUTURE chairs in soft leather 951 castoro - MAGELLANO Shaped lamps in titanium - METROPOL sideboard with black structure and doors in areal ceramic - LATITUDE bookcases





SKORPIO table with brushed grey base and extra clear glass top - ITALIA COUTURE chairs in soft leather 951 castoro - MAGELLANO Shaped lamps in titanium - METROPOL sideboard with black structure and doors in arenal ceramic - LATITUDE bookcases

Skorpio Wood

A. Lucatello & P. Cattelan | 2014

Tavolo con base in acciaio verniciato goffrato titanio, bronzo, graphite, bianco o nero, Brushed Bronze o Brushed Grey.

Versione "A": piano con bordi obliqui in noce Canaletto, rovere Heritage, rovere bruciato o rovere naturale, il piano 160x160 e 200x100 hanno lo spessore di 4cm, il 240x120 e il 300x120 di 5cm. Misure speciali a richiesta.

Versione "S": piano con bordi irregolari in massello di noce Canaletto, rovere bruciato o rovere naturale, spessore 4cm.

Versione "B": piano a botte con bordi bisellati in noce Canaletto o rovere bruciato.

Versione "C": piano in noce Canaletto con profilo inferiore arrotondato e verniciato Brushed Grey o Olmo tinto poro aperto nero opaco con profilo inferiore arrotondato verniciato Brushed Bronze.

Versione "Masterwood": Piano sagomato in noce Canaletto o rovere bruciato realizzato con listelli, diversi tra loro, posizionati in diagonale. Bordi obliqui e arrotondati.

Table with base in titanium, bronze, graphite, white or black embossed lacquered steel, Brushed Bronze or Brushed Grey lacquered steel. **Version "A":** top with angled edges in Canaletto walnut, Heritage oak, burned oak or natural oak. 4cm thick wooden top on 160x160 and 200x100 versions and 5cm on 240x120 and 300x120 versions.

Version "S": top with irregular solid wood edges in Canaletto walnut, burned oak or natural oak, 4cm thickness.

Version "B": barrel top with angled edges in Canaletto walnut or burned oak.

Version "C": top in Canaletto walnut with Brushed Grey lacquered and rounded lower profile or Elm open pore matt black with Brushed Bronze lacquered and rounded lower profile.

"Masterwood" version: boat shaped in Canaletto walnut or Burned Oak made of diagonal wood planks of different sizes. Oblique and rounded edges.

Table avec base en acier laqué gaufré titane, bronze, graphite, blanc ou noir, Brushed Bronze ou Brushed Grey.

Version "A": plateau en noyer Canaletto, rovere Heritage, rovere brûlé ou rovere naturel avec bords biseautés. Les plateaux 160x160 et 200x100 ont une épaisseur de 4cm, les plateaux 240x120 et 300x120 de 5cm. Sur demande, dimensions spéciaux pour le plateau. **Version "S":** plateau en noyer Canaletto, rovere brûlé ou rovere naturel avec bords irréguliers en bois massif. Épaisseur 4 cm.

Version "B": plateau avec bords biseauté en noyer Canaletto ou rovere brûlé.

Version "C": plateau en noyer Canaletto avec profil inférieur arrondi laqué Brushed Grey ou Orme laqué noir opaque pore ouvert avec profil inférieur arrondi laqué Brushed Bronze.

Version "Masterwood" plateau en forme de bateau en noyer Canaletto ou rovere brûlé réalisé avec des planches de bois de différentes dimensions placées en diagonale. Bords obliques et arrondis.

Mesa con base en acero barnizado gofrado titanio, bronzo, graphite, blanco o negro, Brushed Bronze o Brushed Grey.

Versión "A": sobre en nogal Canaletto, roble Heritage, roble ahumado o roble natural con bordes oblicuos. Grosor sobre de 4 cm en las medidas 160x160cm y 200x100cm y de 5 cm en las medidas 240x120 cm y 300x120 cm. Medidas especiales disponibles sobre pedido. **Versión "S":** sobre en nogal Canaletto, roble ahumado o roble natural con bordes irregulares en macizo. Grosor 4 cm.

Versión "B": sobre con bordes biselados en nogal Canaletto o roble ahumado.

Versión "C": sobre en nogal Canaletto y perfil inferior redondeado barnizado Brushed Grey o Olmo barnizado negro mate a poro abierto y perfil inferior redondeado barnizado Brushed Bronze.

Versión "Masterwood": sobre en forma de barco en Nogal Canaletto o roble ahumado realizado con láminas de madera en posición diagonal. Cantos oblicuos y redondeados hacia abajo.

Esstisch mit Basis aus Metall lackiert titan, bronze, graphit, weiß, schwarz gaufriert, Brushed Bronze oder Brushed Grey.

Version "A": Platte in Nussbaum Canaletto, Eiche Heritage, "verbrannte Eiche" oder Natur Eiche mit schräge Kanten. Die Platten 160x160 und 200x100 sind 4 cm dick, die Platten in 240x120 und 300x120 sind 5 cm dick. Sondermasse auf Anfrage.

Version "S": Platte in Nussbaum Canaletto, "verbrannte Eiche" oder Natur Eiche mit massiven und unregelmäßigen Kanten. 4 cm Dicke.

Version "B": Platte mit schräge Kanten aus Nussbaum Canaletto oder "verbrannte Eiche".

Version "C": Platte aus Nussbaum Canaletto mit Brushed Grey lackierten abgerundeten Profil oder Ulme offenporig lackiert matt schwarz mit Brushed Bronze lackierten abgerundeten Profil.

Version "Masterwood": bootsförmige Platte aus Nussbaum Canaletto oder verbrannte Eiche hergestellt aus verschiedenen, diagonal eingeordneten Leisten. Schräge und abgerundete Kanten.

version A

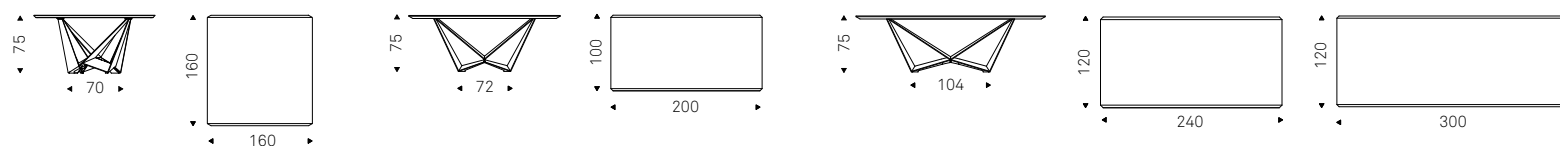

version B



version C

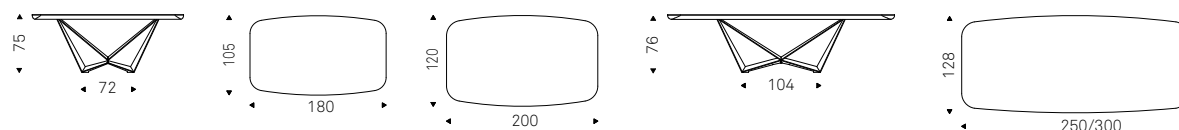

version S



version MASTERWOOD

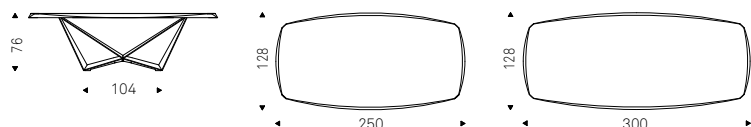



SKORPIO WOOD table with brushed grey base and burned oak Masterwood top - CHRISHELL chairs in soft leather 948 lino and matt black frame -
MAGELLANO Shaped lamps in titanium - ROYALTON sideboard in titanium





SKORPIO WOOD table with brushed grey base and burned oak Masterwood top - CHRISHELL chairs in soft leather 948 lino and matt black frame

Tyron Keramik

Paolo Cattelan | 2020

Tavolo con base in acciaio verniciato goffrato titanio, bronzo, graphite o nero, Brushed Bronze o Brushed Grey. Piano in ceramica Marmi nei colori Calacatta, Alabastro, Ardesia, Golden Calacatta opaco, Golden Calacatta lucido, Portoro opaco, Portoro lucido, Sahara Noir lucido, Emperador, Makalu, Breccia o Arenal.

Table with base in titanium, bronze, graphite or black embossed lacquered steel, Brushed Bronze or Brushed Grey. Marmi Calacatta, Alabastro, Ardesia, matt Golden Calacatta, glossy Golden Calacatta, matt Portoro, glossy Portoro, glossy Sahara Noir, Emperador, Makalu, Breccia or Arenal ceramic top.

Table avec base en acier gaufré titane, bronze, graphite, noir, Brushed Bronze ou Brushed Grey. Plateau en céramique dans les couleurs Marmi Calacatta, Alabastro, Ardesia, Golden Calacatta opaque, Golden Calacatta brillant, Portoro opaque, Portoro brillant, Sahara Noir brillant, Emperador, Makalu, Breccia ou Arenal.

Mesa con base en acero barnizado gofrado titanio, bronzo, graphite o negro, Brushed Bronze o Brushed Grey. Sobre en cerámica Marmi colores Calacatta, Alabastro, Ardesia, Golden Calacatta mate, Golden Calacatta brillo, Portoro mate, Portoro brillo, Sahara Noir brillo, Emperador, Makalu, Breccia o Arenal.

Esstisch mit Basis in Edelstahl lackiert titan, bronze, graphit oder schwarz gaufriert, Brushed Bronze oder Brushed Grey. Platte in Keramik Marmi in den Farben Calacatta, Alabastro, Ardesia, matt Golden Calacatta, glänzend Golden Calacatta, matt Portoro, glänzend Portoro, glänzend Sahara Noir, Emperador, Makalu, Breccia oder Arenal.

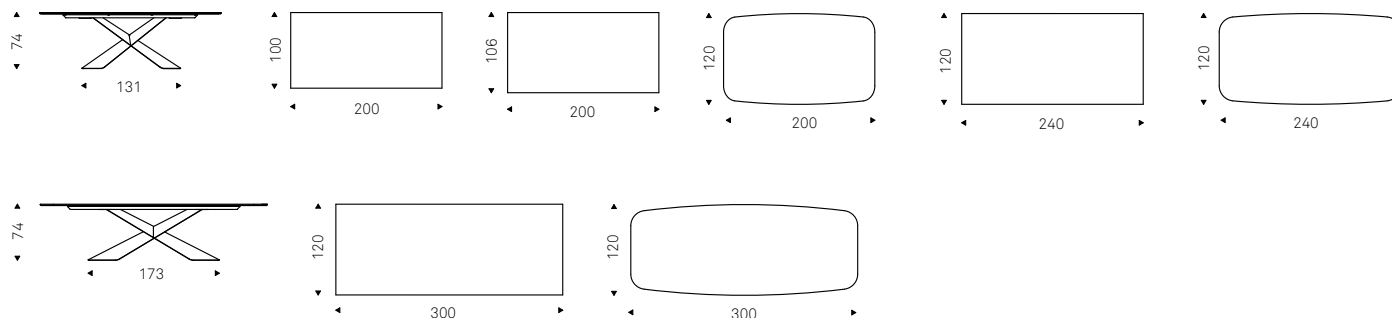

TYRON KERAMIK table with black base and glossy sahara noir ceramic top



TYRON KERAMIK table with titanium base and breccia ceramic top - PENELOPE chairs in soft leather 948 lino - SPIGA sideboards in brushed bronze - ZANZIBALL lamps



TYRON KERAMIK table with breccia ceramic top - PENELOPE chairs in soft leather 948 lino



TYRON KERAMIK table with titanium base and breccia ceramic top - PENELOPE chairs in soft leather 948 lino - SPIGA sideboard in brushed bronze - ZANZIBALL lamps





TYRON KERAMIK table with breccia ceramic top - PENELOPE chairs in soft leather 948 lino

Tyron Keramik Drive

Paolo Cattelan | 2020

Tavolo allungabile con base in acciaio verniciato goffrato titanio, bronzo, graphite o nero, Brushed Bronze o Brushed Grey. Piano e prolunghe in ceramica Marmi nei colori Calacatta, Alabastro, Ardesia, Golden Calacatta opaco, Golden Calacatta lucido, Portoro opaco, Portoro lucido, Sahara Noir lucido, Emperador, Makalu, Breccia o Arenal.

Extendible table with base in titanium, bronze, graphite or black embossed lacquered steel, Brushed Bronze or Brushed Grey. Marmi ceramic in Calacatta, Alabastro, Ardesia, matt Golden Calacatta, glossy Golden Calacatta, matt Portoro, glossy Portoro, glossy Sahara Noir, Emperador, Makalu, Breccia or Arenal ceramic top.

Table à rallonges avec base en acier gaufré titane, bronze, graphite ou noir, Brushed Bronze ou Brushed Grey. Plateau et rallonges en céramique Marmi dans les couleurs Calacatta, Alabastro, Ardesia, Golden Calacatta opaque, Golden Calacatta brillant, Portoro opaque, Portoro brillant, Sahara Noir brillant, Emperador, Makalu, Breccia ou Arenal.

Mesa extensible con base en acero barnizado gofrado titanio, bronzo, graphite o negro, Brushed Bronze o Brushed Grey. Sobre y extensiones en cerámica Marmi colores Calacatta, Alabastro, Ardesia, Golden Calacatta mate, Golden Calacatta brillo, Portoro mate, Portoro brillo, Sahara Noir brillo, Emperador, Makalu, Breccia o Arenal.

Ausziehbarer Esstisch mit Basis in Edelstahl lackiert titan, bronzo, graphite oder schwarz gaufriert, Brushed Bronze oder Brushed Grey. Platte und Verlängerungen in Keramik Marmi in den Farben Calacatta, Alabastro, Ardesia, matt Golden Calacatta, glänzend Golden Calacatta, matt Portoro, glänzend Portoro, glänzend Sahara Noir, Emperador, Makalu, Breccia oder Arenal.

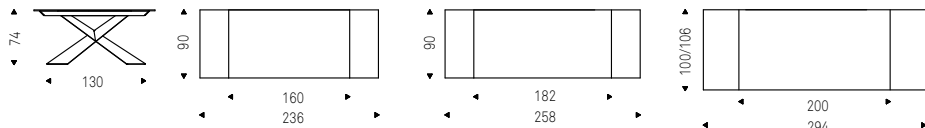

TYRON KERAMIK DRIVE with bronze base and arenal ceramic top - ITALIA chairs in soft leather 977 piombo - PLANETA S lamp LAVANDER sideboard in titanium - EMERALD mirror in fumé mirrored glass



TYRON KERAMIK DRIVE with bronze base and arenal ceramic top - ITALIA chairs in soft leather 977 piombo - PLANETA S lamp





TYRON KERAMIK DRIVE with bronze base and matt golden calacatta ceramic top - MAGDA ML COUTURE B chairs in soft leather 948 lino and titanium frame - PLANETA S lamp - RADJA rugs - LATITUDE sideboards in titanium - EMERALD mirror in fumé mirrored glass - MAMBA table lamp in titanium

Tyron Keramik Premium

Paolo Cattelan | 2020

Tavolo con base in acciaio verniciato goffrato titanio, bronzo, graphite o nero, Brushed Bronze o Brushed Grey. Piano in ceramica Marmi nei colori Calacatta, Alabastro, Ardesia, Golden Calacatta opaco, Golden Calacatta lucido, Portoro opaco, Portoro lucido, Sahara Noir lucido, Emperador, Makalu, Breccia o Arenal con profilo inferiore arrotondato e verniciato Brushed Bronze o Brushed Grey. Il piano 300x128 ha lo spessore di 6cm, il 200x120 e il 240x120 di 5cm.

Table with base in titanium, bronze, graphite or black embossed lacquered steel, Brushed Bronze or Brushed Grey. Top in ceramic Marmi Calacatta, Alabastro, Ardesia, matt Golden Calacatta, glossy Golden Calacatta, matt Portoro, glossy Portoro, glossy Sahara Noir, Emperador, Makalu, Breccia or Arenal with Brushed Bronze or Brushed Grey lacquered and rounded lower profile. 6cm thick wooden top on 300x128 version and 5cm on 200x120 and 240x120 versions.

Table avec base en acier gaufré titane, bronze, graphite, noir, Brushed Bronze ou Brushed Grey. Plateau en céramique Marmi dans les couleurs Calacatta, Alabastro, Ardesia, Golden Calacatta opaque, Golden Calacatta brillant, Portoro opaque, Portoro brillant, Sahara Noir brillant, Emperador, Makalu, Breccia ou Arenal avec profil inférieur arrondi laqué Brushed Bronze ou Brushed Grey. Le plateau 300x128 a une épaisseur de 6cm, les plateaux 200x120 et 240x120 de 5cm.

Mesa con base en acero barnizado gofrado titanio, bronzo, graphite o negro, Brushed Bronze o Brushed Grey. Sobre en cerámica Marmi colores Calacatta, Alabastro, Ardesia, Golden Calacatta mate, Golden Calacatta brillo, Portoro mate, Portoro brillo, Sahara Noir brillo, Emperador, Makalu, Breccia o Arenal y perfil inferior redondeado barnizado Brushed Bronze o Brushed Grey. Grosor sobre de 6 cm en la medida 300x128 cm y de 5 cm en las medidas 200x120 cm y 240x120 cm.

Esstisch mit Basis in Edelstahl lackiert titan, bronze, graphit oder schwarz gaufriert, Brushed Bronze oder Brushed Grey. Platte aus Keramik Marmi in den Farben Calacatta, Alabastro, Ardesia, matt Golden Calacatta, glänzend Golden Calacatta, matt Portoro, glänzend Portoro, glänzend Sahara Noir, Emperador, Makalu, Breccia oder Arenal mit Brushed Bronze oder Brushed Grey lackierten abgerundeten Profil. Die Platte 300x128 ist 6 cm dick, die Platten in 200x120 und 240x120 sind 5 cm dick.

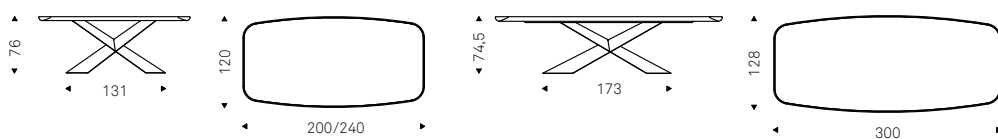

TYRON KERAMIK PREMIUM table with titanium base, matt portoro ceramic top and brushed bronze profile - PENELOPE chairs in soft leather 948 lino - MUMBAI rugs - KAYAK sideboard in brushed grey



TYRON KERAMIK PREMIUM table with bronze base, arenal ceramic top and brushed grey profile - BOMBÈ chairs in soft leather 948 lino, graphite and burned oak frame - KATANA lamps in titanium - MUMBAI rugs





TYRON KERAMIK PREMIUM table with bronze base, arenal ceramic top and brushed grey profile - ITALIA COUTURE chairs in soft leather 951 castoro - KATANA lamps in titanium - MUMBAI rugs

Tyron Wood

Paolo Cattelan | 2020

Tavolo con base in acciaio verniciato goffrato titanio, bronzo, graphite o nero, Brushed Bronze o Brushed Grey.

Versione "A": piano con bordi obliqui in noce Canaletto, rovere Heritage, rovere bruciato o rovere naturale.

Versione "B": piano a botte con bordi bisellati in noce Canaletto o rovere bruciato.

Versione "C": piano in noce Canaletto con profilo inferiore arrotondato e verniciato Brushed Grey o Olmo tinto poro aperto nero opaco con profilo inferiore arrotondato verniciato Brushed Bronze.

Versione "S": piano con bordi irregolari in massello di noce Canaletto, rovere bruciato o rovere naturale.

Versione "Masterwood": Piano sagomato in noce Canaletto o rovere bruciato realizzato con listelli, diversi tra loro, posizionati in diagonale. Bordi obliqui e arrotondati.

Table with base in titanium, bronze, graphite or black embossed lacquered steel, Brushed Bronze or Brushed Grey.

Version "A": top with angled edges in Canaletto walnut, Heritage oak, burned oak or natural oak.

Version "B": barrel top with angled edges in Canaletto walnut or burned oak.

Version "C": top in Canaletto walnut with Brushed Grey lacquered and rounded lower profile or Elm open pore matt black with Brushed Bronze lacquered and rounded lower profile.

Version "S": top with irregular solid wood edges in Canaletto walnut, burned oak or natural oak.

"Masterwood" version: boat shaped in Canaletto walnut or Burned Oak made of diagonal wood planks of different sizes. Oblique and rounded edges.

Table avec base en acier gaufré titane, bronze, graphite ou noir, Brushed Bronze ou Brushed Grey.

Version "A": plateau en noyer Canaletto, rovere Heritage, rovere brulé ou rovere naturel avec bords biseautés.

Version "B": plateau avec bords biseauté en noyer Canaletto ou rovere brulé.

Version "C": plateau en noyer Canaletto avec profil inférieur arrondi laqué Brushed Grey ou Orme laqué noir opaque pore ouvert avec profil inférieur arrondi laqué Brushed Bronze.

Version "S": plateau en noyer Canaletto, rovere brulé ou rovere naturel avec bords irréguliers en bois massif.

Version "Masterwood" plateau en forme de bateau en noyer Canaletto ou rovere brulé réalisé avec des planches de bois de différentes dimensions placées en diagonale. Bords obliques et arrondis.

Mesa con base en acero barnizado gofrado titanio, bronzo, graphite o negro, Brushed Bronze o Brushed Grey.

Versión "A": sobre en nogal Canaletto, roble Heritage, roble ahumado o roble natural con bordes oblicuos.

Versión "B": sobre con bordes biselados en nogal Canaletto o roble ahumado.

Versión "C": sobre en nogal Canaletto y perfil inferior redondeado barnizado Brushed Grey o Olmo barnizado negro mate a poro abierto y perfil inferior redondeado barnizado Brushed Bronze.

Versión "S": sobre en nogal Canaletto, roble ahumado o roble natural con bordes irregulares en macizo.

Versión "Masterwood": sobre en forma de barco en Nogal Canaletto o roble ahumado realizado con láminas de madera en posición diagonal. Cantos oblicuos y redondeados hacia abajo.

Esstisch mit Basis in Edelstahl lackiert titan, bronze, graphite oder schwarz gaufriert, Brushed Bronze oder Brushed Grey.

Version "A": Platte in Nussbaum Canaletto, Eiche Heritage, "verbrannte Eiche" oder Natur Eiche mit schräge Kanten.

Version "B": Platte mit schräge Kanten aus Nussbaum Canaletto oder "verbrannte Eiche".

Version "C": Platte aus Nussbaum Canaletto mit Brushed Grey lackierten abgerundeten Profil oder Ulme offenporig lackiert matt schwarz mit Brushed Bronze lackierten abgerundeten Profil.

Version "S": Platte in Nussbaum Canaletto, "verbrannte Eiche" oder Natur Eiche mit massiven und unregelmäßigen Kanten.

Version "Masterwood": bootsförmige Platte aus Nussbaum Canaletto oder verbrannte Eiche hergestellt aus verschiedenen, diagonal eingeordneten Leisten. Schräge und abgerundete Kanten.

version A

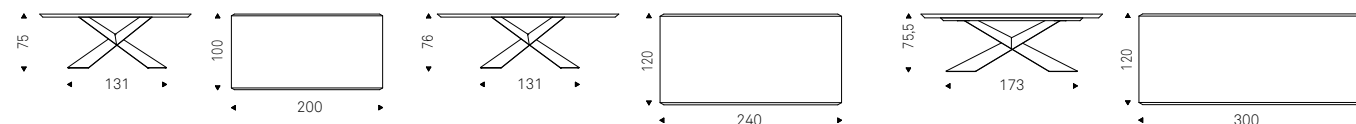

version B



version C

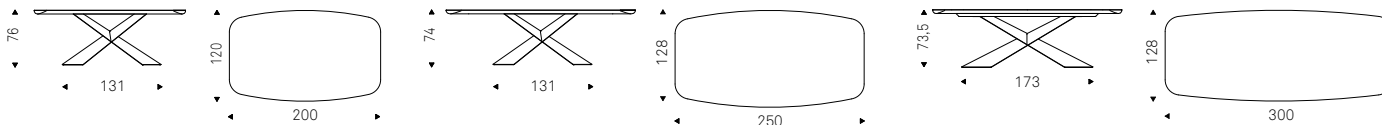

version S



version MASTERWOOD

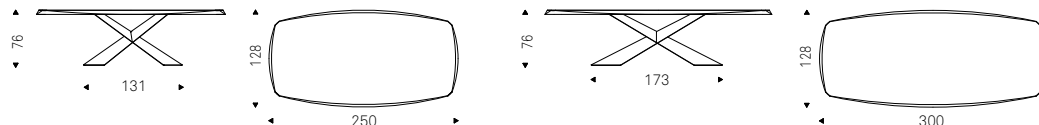

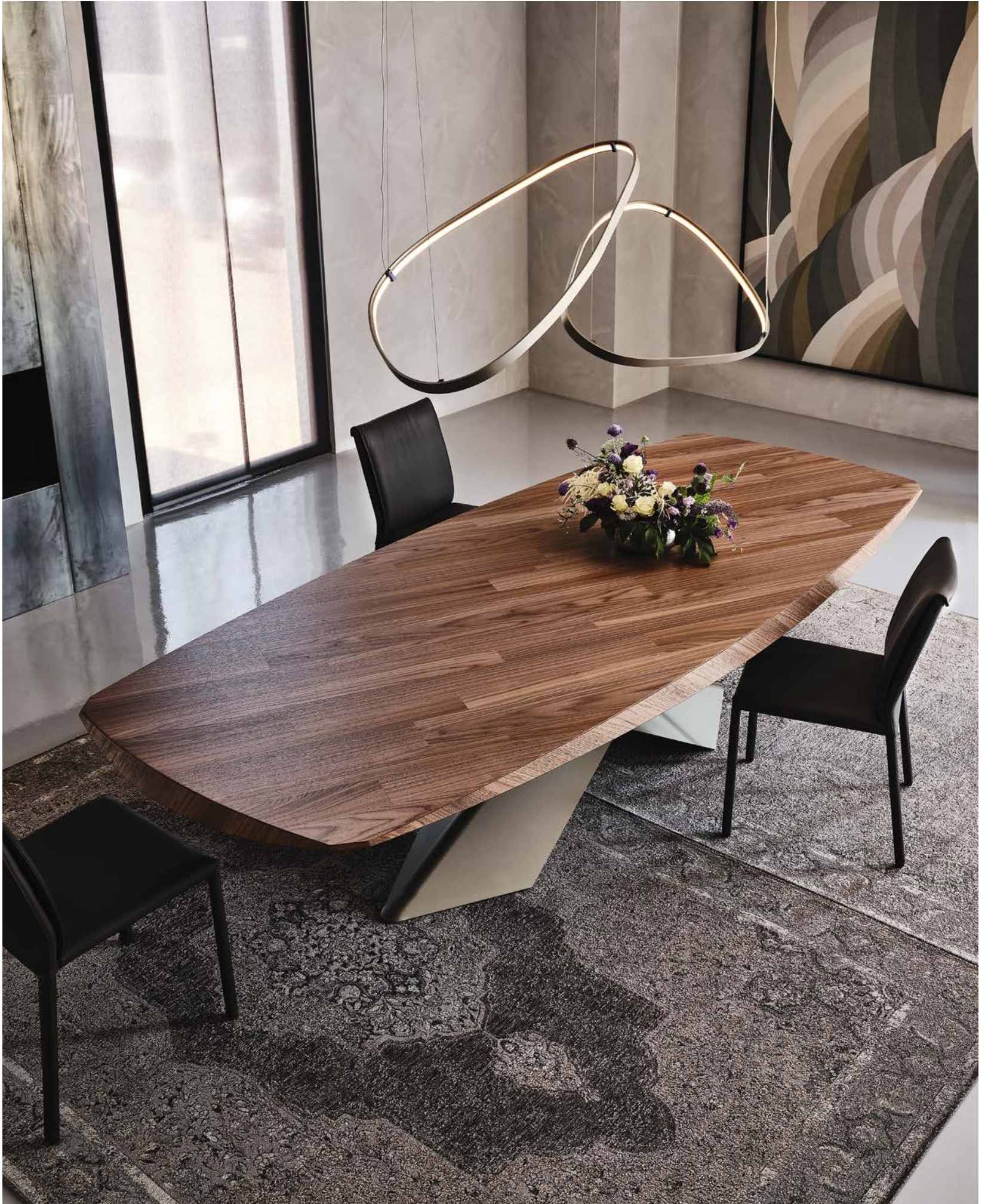

TYRON WOOD table with titanium base and Canaletto walnut Masterwood top - ITALIA chairs in soft leather 973 nero - MAGELLANO lamps in titanium - CHENNAI rugs





TYRON WOOD table with titanium base and Canaletto walnut Masterwood top - ITALIA chairs in soft leather 973 nero - MAGELLANO lamps in titanium - CHENNAI rugs - LAVANDER sideboard in brushed bronze - REGAL mirror in fumé mirrored glass



TYRON WOOD table with graphite base and burned oak Masterwood top - WILMA chairs in soft leather 952 smoke - PHOENIX S2 lamp - DARWIN rugs



TYRON WOOD table with titanium base and Canaletto walnut Masterwood top - WILMA chair in soft leather 951 castoro - CHENNAI rugs





TYRON WOOD table with graphite base and burned oak Masterwood top - WILMA chairs in soft leather 952 smoke - PHOENIX S2 lamp - DARWIN rugs

Tyron CrystalArt

Paolo Cattelan | 2020

Tavolo con base in acciaio verniciato goffrato titanio, bronzo, graphite o nero, Brushed Bronze o Brushed Grey. Piano in cristallo 12mm extrachiaro bisellato con stampa artistica decorativa in due varianti colore.

Table with base in titanium, bronze, graphite or black embossed lacquered steel, Brushed Bronze or Brushed Grey. Top 12mm thick in extra clear bevelled glass with artistic decorative printing in two different colours.

Table avec base en acier gaufré titane, bronze, graphite ou noir, Brushed Bronze ou Brushed Grey. Plateau en verre 12mm extra-clair avec bords biseautés et impression artistique décorative en deux couleurs différentes.

Mesa con base en acero barnizado gofrado titanio, bronzo, graphite o negro, Brushed Bronze o Brushed Grey. Sobre en cristal 12mm extraclaro biselado con impresión artística decorativa en dos variantes de color.

Esstisch mit Basis in Edelstahl lackiert titan, bronze, graphite oder schwarz gaufriert, Brushed Bronze oder Brushed Grey. 12 mm Glasplatte extra hell facettiert mit schmückendem Kunstdruck in zwei Farbvarianten.

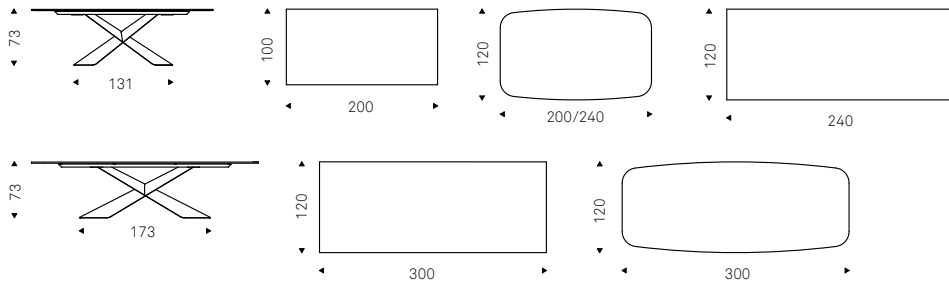

TYRON CRYSTALART table with black base and decorative printed CY01 extra clear glass top



TYRON CRYSTALART table with bronze base and decorative printed CY02 extra clear glass top - CHRIS ML chairs in soft leather 952 smoke and bronze frame - PHOENIX S4 lamp - MAPOON rugs - ETOILE consoles in brushed grey





TYRON CRYSTALART table with bronze base and decorative printed CY02 extra clear glass top - CHRIS ML chairs in soft leather 952 smoke and bronze frame - PHOENIX S4 lamp - MAPOON rugs - ETOILE consoles in brushed grey

Tyron CrystalArt Drive

Paolo Cattelan | 2020

Tavolo allungabile con base in acciaio verniciato gofrato titanio, bronzo, graphite, nero, Brushed Bronze o Brushed Grey. Piano e prolunghe in cristallo 12mm extrachiaro con stampa artistica decorativa in due varianti colore.

Extendible table with base in titanium, bronze, graphite, black embossed lacquered steel, Brushed Bronze or Brushed Grey. Top and extensions in 12mm extra clear glass with artistic decorative printing in two different colours.

Table à rallonges avec base en acier gaufré titane, bronze, graphite ou noir, Brushed Bronze ou Brushed Grey. Plateau et rallonges en verre 12mm extra-clair avec impression artistique décorative en deux couleurs différentes.

Mesa extensible con base en acero barnizado gofrado titanio, bronce, graphite o negro, Brushed Bronze o Brushed Grey. Sobre y extensiones en cristal 12mm extraclaro con impresión artística decorativa en dos variantes de color.

Ausziehbarer Esstisch mit Basis in Edelstahl lackiert titan, bronze, graphite oder schwarz gaufriert, Brushed Bronze oder Brushed Grey. Platte und Verlängerungen in extra-hell Glas facettiert mit schmückendem Kunstdruck in zwei Farbvarianten.

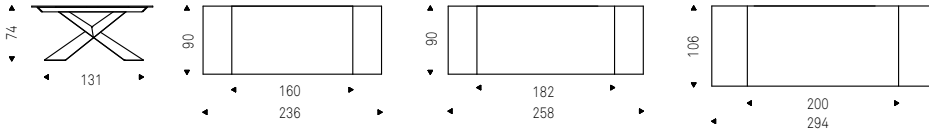



TYRON CRYSTALART DRIVE table with bronze base and decorative printed CY02 extra clear glass top - RHONDA chairs in soft leather 942 fango and bronze frame - ZANZIBALL lamps - RADJA rugs





TYRON CRYSTALART DRIVE table with bronze base and decorative printed CY02 extra clear glass top - RHONDA chairs in soft leather 942 fango and bronze frame - ZANZIBALL lamps - RADJA rugs - KAYAK sideboard in brushed grey - HAWAII E mirrors in bronze mirrored glass

Mad Max Keramik

Paolo Cattelan | 2020

Tavolo con base in acciaio verniciato goffrato titanio, bronzo, graphite o nero, Brushed Bronze o Brushed Grey. Piano in ceramica Marmi nei colori Calacatta, Alabastro, Ardesia, Golden Calacatta opaco, Golden Calacatta lucido, Portoro opaco, Portoro lucido, Sahara Noir lucido, Emperador, Makalu, Breccia o Arenal.

Table with base in titanium, bronze, graphite or black embossed lacquered steel, Brushed Bronze or Brushed Grey lacquered steel. Top in ceramic Marmi Calacatta, Alabastro, Ardesia, matt Golden Calacatta, glossy Golden Calacatta, matt Portoro, glossy Portoro, glossy Sahara Noir, Emperador, Makalu, Breccia or Arenal.

Table avec base en acier gaufré titane, bronze, graphite ou noir, Brushed Bronze ou Brushed Grey. Plateau en céramique Marmi dans les couleurs Calacatta, Alabastro, Ardesia, Golden Calacatta opaque, Golden Calacatta brillant, Portoro opaque, Portoro brillant, Sahara Noir brillant, Emperador, Makalu, Breccia ou Arenal.

Mesa con base en acero barnizado gofrado titanio, bronzo, graphite o negro, Brushed Bronze o Brushed Grey. Sobre en cerámica Marmi colores Calacatta, Alabastro, Ardesia, Golden Calacatta mate, Golden Calacatta brillo, Portoro mate, Portoro brillo, Sahara Noir brillo, Emperador, Makalu, Breccia o Arenal.

Esstisch mit Basis aus Metall lackiert titan, bronze, graphite oder schwarz gaufriert, Brushed Bronze oder Brushed Grey. Platte in Keramik Marmi in den Farben Calacatta, Alabastro, Ardesia, matt Golden Calacatta, glänzend Golden Calacatta, matt Portoro, glänzend Portoro, glänzend Sahara Noir, Emperador, Makalu, Breccia oder Arenal.

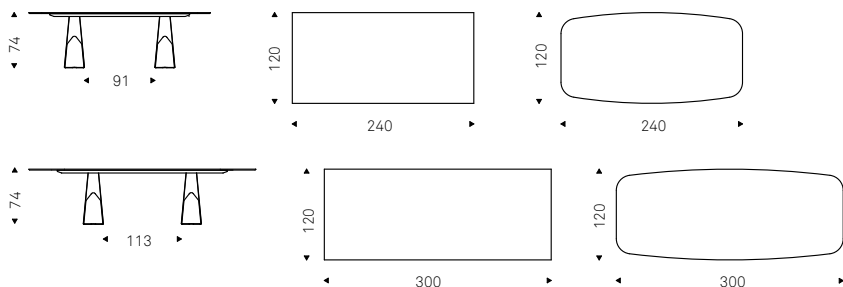

MAD MAX KERAMIK table with titanium base and alabastro ceramic top - APOLLO lamps - CHENNAI rugs
WILMA chairs in soft leather glove GLV15 carbon - TUDOR sideboard in brushed bronze



MAD MAX KERAMIK table with brushed bronze base and glossy sahara noir ceramic top - MAGDA B chairs in soft leather glove GLV12 oliva and burned oak frame - PHOENIX S4 lamp





MAD MAX KERAMIK table with titanium base and alabastro ceramic top - WILMA chairs in soft leather glove GLV15 carbon - APOLLO lamps - CHENNAI rugs - TUDOR sideboard in brushed bronze

Mad Max Keramik Premium

Paolo Cattelan | 2020

Tavolo con base in acciaio verniciato goffrato titanio, bronzo, graphite o nero, Brushed Bronze o Brushed Grey. Piano in ceramica Marmi nei colori Calacatta, Alabastro, Ardesia, Golden Calacatta opaco, Golden Calacatta lucido, Portoro opaco, Portoro lucido, Sahara Noir lucido, Emperador, Makalu, Breccia o Arenal con profilo inferiore arrotondato e verniciato Brushed Bronze o Brushed Grey. Il piano 300x128 ha lo spessore di 6cm, il 240x120 di 5cm.

Table with base in titanium, bronze, graphite or black embossed lacquered steel, Brushed Bronze or Brushed Grey. Top in ceramic Marmi Calacatta, Alabastro, Ardesia, matt Golden Calacatta, glossy Golden Calacatta, matt Portoro, glossy Portoro, glossy Sahara Noir, Emperador, Makalu, Breccia or Arenal with Brushed Bronze or Brushed Grey lacquered and rounded lower profile. 6cm thick wooden top on 300x128 version and 5cm on 240x120 version.

Table avec base en acier gaufré titane, bronze, graphite, blanc ou noir, Brushed Bronze ou Brushed Grey. Plateau en céramique Marmi dans les couleurs Calacatta, Alabastro, Ardesia, Golden Calacatta opaque, Golden Calacatta brillant, Portoro opaque, Portoro brillant, Sahara Noir brillant, Emperador, Makalu, Breccia ou Arenal avec profil inférieur arrondi laqué Brushed Bronze ou Brushed Grey. Le plateau 300x128 a une épaisseur de 6cm, le plateau 240x120 de 5cm.

Mesa con base en acero barnizado gofrado titanio, bronzo, graphite o negro, Brushed Bronze o Brushed Grey. Sobre en cerámica Marmi colores Calacatta, Alabastro, Ardesia, Golden Calacatta mate, Golden Calacatta brillo, Portoro mate, Portoro brillo, Sahara Noir brillo, Emperador, Makalu, Breccia o Arenal y perfil inferior redondeado barnizado Brushed Bronze o Brushed Grey. Grosor sobre de 6cm en la medida 300 x 128 cm y de 5cm en la medida 240 x 120 cm.

Esstisch mit Basis aus Stahl lackiert titan, bronze, graphite oder schwarz gaufriert, Brushed Bronze oder Brushed Grey. Platte aus Keramik Marmi in den Farben Calacatta, Alabastro, Ardesia, matt Golden Calacatta, glänzend Golden Calacatta, matt Portoro, glänzend Portoro, glänzend Sahara Noir, Emperador, Makalu, Breccia oder Arenal mit Brushed Bronze oder Brushed Grey lackierten abgerundeten Profil. Die Platte 300x128 ist 6 cm dick, die Platte 240x120 ist 5 cm dick.

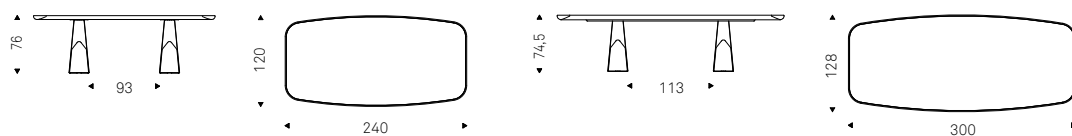



MAD MAX KERAMIK PREMIUM table with brushed grey base, arenal ceramic top and brushed grey profile - BOMBÈ X chairs in soft leather 951 castoro and black frame - HEAVEN lamps in titanium - DARWIN rugs - FREEWAY bookcase in bronze

Mad Max Wood

Paolo Cattelan | 2020

Tavolo con base in acciaio verniciato goffrato titanio, bronzo, graphite o nero, Brushed Bronze o Brushed Grey.

Versione "A": piano con bordi obliqui in noce Canaletto, rovere Heritage, rovere bruciato o rovere naturale.

Versione "B": piano a botte con bordi bisellati in noce Canaletto o rovere bruciato.

Versione "C": piano in noce Canaletto con profilo inferiore arrotondato e verniciato Brushed Grey o Olmo tinto poro aperto nero opaco con profilo inferiore arrotondato verniciato Brushed Bronze.

Versione "S": piano con bordi irregolari in massello di noce Canaletto, rovere bruciato o rovere naturale.

Versione "Masterwood": Piano sagomato in noce Canaletto o rovere bruciato realizzato con listelli, diversi tra loro, posizionati in diagonale. Bordi obliqui e arrotondati.

Table with base in titanium, bronze, graphite or black embossed lacquered steel, Brushed Bronze or Brushed Grey lacquered steel.

Version "A": top with angled edges in Canaletto walnut, Heritage oak, burned oak or natural oak.

Version "B": barrel top with angled edges in Canaletto walnut or burned oak.

Version "C": top in Canaletto walnut with Brushed Grey lacquered and rounded lower profile or Elm open pore matt black with Brushed Bronze lacquered and rounded lower profile.

Version "S": top with irregular solid wood edges in Canaletto walnut, burned oak or natural oak.

"Masterwood" version: boat shaped in Canaletto walnut or Burned Oak made of diagonal wood planks of different sizes. Oblique and rounded edges.

Table avec base en acier laqué gaufré titane, bronze, graphite ou noir, Brushed Bronze ou Brushed Grey.

Version "A": plateau en noyer Canaletto, rovere Heritage, rovere brulé ou rovere naturel avec bords biseautés.

Version "B": plateau avec bords biseauté en noyer Canaletto ou rovere brulé.

Version "C": plateau en noyer Canaletto avec profil inférieur arrondi laqué Brushed Grey ou Orme laqué noir opaque pore ouvert avec profil inférieur arrondi laqué Brushed Bronze.

Version "S": plateau en noyer Canaletto, rovere brulé ou rovere naturel avec bords irréguliers en bois massif.

Version "Masterwood" plateau en forme de bateau en noyer Canaletto ou rovere brulé réalisé avec des planches de bois de différentes dimensions placées en diagonale. Bords obliques et arrondis.

Mesa con base en acero barnizado gofrado titanio, bronzo, graphite o negro, Brushed Bronze o Brushed Grey.

Versión "A": sobre en nogal Canaletto, roble Heritage, roble ahumado o roble natural con bordes oblicuos.

Versión "B": sobre con bordes biselados en nogal Canaletto o roble ahumado.

Versión "C": sobre en nogal Canaletto y perfil inferior redondeado barnizado Brushed Grey o Olmo barnizado negro mate a poro abierto y perfil inferior redondeado barnizado Brushed Bronze.

Versión "S": sobre en nogal Canaletto, roble ahumado o roble natural con bordes irregulares en macizo.

Versión "Masterwood": sobre en forma de barco en Nogal Canaletto o roble ahumado realizado con láminas de madera en posición diagonal. Cantos oblicuos y redondeados hacia abajo.

Esstisch mit Basis aus Metall lackiert titan, bronze, graphit oder schwarz gaufriert, Brushed Bronze oder Brushed Grey.

Versión "A": Platte in Nussbaum Canaletto, Eiche Heritage, "verbrannte Eiche" oder Natur Eiche mit schräge Kanten.

Versión "B": Platte mit schräge Kanten aus Nussbaum Canaletto oder "verbrannte Eiche".

Versión "C": Platte aus Nussbaum Canaletto mit Brushed Grey lackierten abgerundeten Profil oder Ulme offenporig lackiert matt schwarz mit Brushed Bronze lackierten abgerundeten Profil.

Versión "S": Platte in Nussbaum Canaletto, "verbrannte Eiche" oder Natur Eiche mit massiven und unregelmäßigen Kanten.

Versión "Masterwood": bootsförmige Platte aus Nussbaum Canaletto oder verbrannte Eiche hergestellt aus verschiedenen, diagonal eingeordneten Leisten. Schräge und abgerundete Kanten.

version A



version B

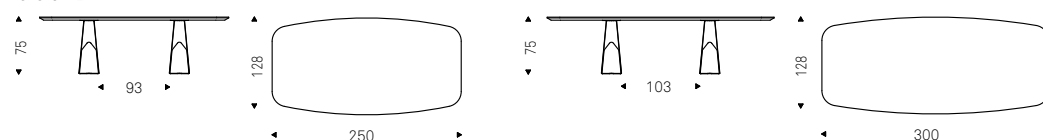

version C

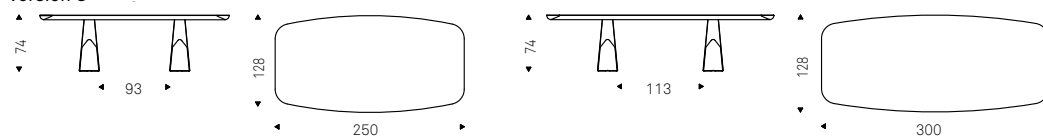

version S

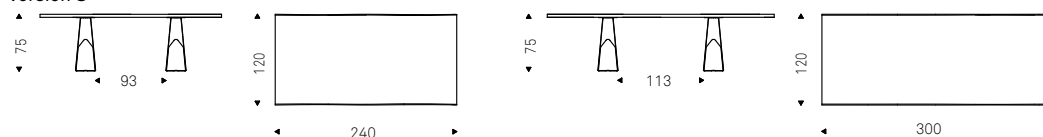

version MASTERWOOD

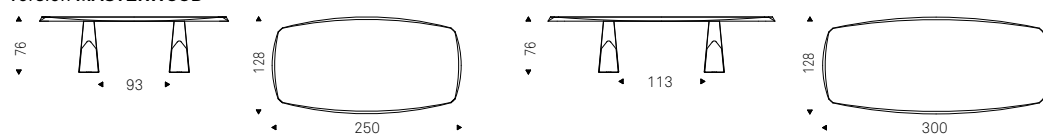



MAD MAX WOOD S table with brushed bronze base and Canaletto walnut top - CHRIS ML chairs in soft leather 952 smoke and bronze frame - MELODY lamps - ARIZONA sideboard in brushed bronze

Mad Max CrystalArt

Paolo Cattelan | 2020

Tavolo con base in acciaio verniciato goffrato titanio, bronzo, graphite o nero, Brushed Bronze o Brushed Grey. Piano in cristallo 12mm extrachiaro bisellato con stampa artistica decorativa in due varianti colore.

Table with base in titanium, bronze, graphite or black embossed lacquered steel, Brushed Bronze or Brushed Grey lacquered steel. Top 12mm thick in extra clear bevelled glass with artistic decorative printing in two different colours.

Table avec base en acier laqué gaufré titane, bronze, graphite ou noir, Brushed Bronze ou Brushed Grey. Plateau en verre 12mm extra-clair avec bords biseautés et impression artistique décorative en deux couleurs différentes.

Mesa con base en acero barnizado gofrado titanio, bronzo, graphite o negro, Brushed Bronze o Brushed Grey. Sobre en cristal 12mm extraclaro biselado con impresión artística decorativa en dos variantes de color.

Esstisch mit Basis aus Metall lackiert titan, bronze, graphite oder schwarz gaufriert, Brushed Bronze oder Brushed Grey. 12 mm Glasplatte extra hell facettiert mit schmückendem Kunstdruck in zwei Farbvarianten.

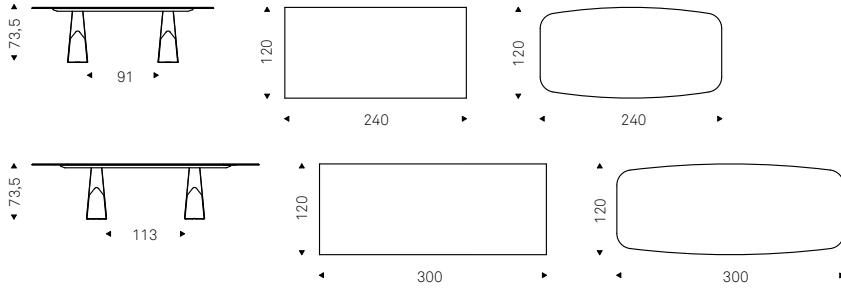

MAD MAX CRYSTALART table with black base and decorative printed CY01 extra clear glass top



MAD MAX CRYSTALART table with brushed bronze base and decorative printed CY02 extra clear glass top - MAGDA MLA chair in soft leather 948 lino and bronze frame





MAD MAX CRYSTALART table with brushed bronze base and decorative printed CY02 extra clear glass top - MAGDA ML A chair in soft leather 948 lino and bronze frame - ZANZIBALL lamps

Marathon

Andrea Lucatello | 2019

Tavolo con base in massello di noce Canaletto, frassino tinto rovere bruciato o frassino laccato poro aperto nero e acciaio verniciato goffrato titanio, bronzo o nero, Brushed Bronze o Brushed Grey. Piano in cristallo 15mm trasparente, trasparente extrachiaro, o trasparente extrachiaro con bordo bisellato. I piani 182x90 e 200x106 hanno spessore 12mm. Piano in appoggio.

Table with base in solid Canaletto walnut, burned oak stained ashwood or open pore matt black painted ashwood and titanium, bronze or black embossed lacquered steel, Brushed Bronze or Brushed grey. Top 15mm thick in clear glass, extra clear glass or extra clear with bevelled edges. Glass top 12mm on 182x90 and 200x106 versions. The top is laid on the base.

Table avec base en massif en noyer Canaletto, frêne teinté rouvre brulé ou laqué noir opaque pore ouvert et acier gaufré titan, bronze ou noir, Brushed Bronze ou Brushed grey. Plateau de 15 mm en verre clair, verre extra-clair ou verre extra-clair avec bords biseautés. Les plateaux 182x90 et 200x106 sont de 12mm. Plateau en appui.

Mesa con base en macizo de nogal Canaletto, fresno pintado roble ahumado o fresno lacado a poro abierto negro y acero barnizado gofrado titanio, bronce o negro, Brushed Bronze o Brushed Grey. Sobre en cristal 15mm transparente, transparente extraclaro o transparente extraclaro con canto biselado. Los sobros 182x90cm y 200x106cm son de 12mm. Sobre en apoyo.

Tisch mit Basis aus Massivholz Nussbaum Canaletto, Esche "verbrannte Eiche" lackiert oder Esche offenporig matt schwarz lackiert und Stahl lackiert titan, bronce oder schwarz gaufriert, Brushed Bronze oder Brushed Grey. 15 mm Platte in Klarglas, Glas extra hell oder Glas extra hell mit Kanten facettiert. Platten in 182x90 und 200x106 haben 12 mm Dicke. Die Platte ist auf der Basis aufgelegt.

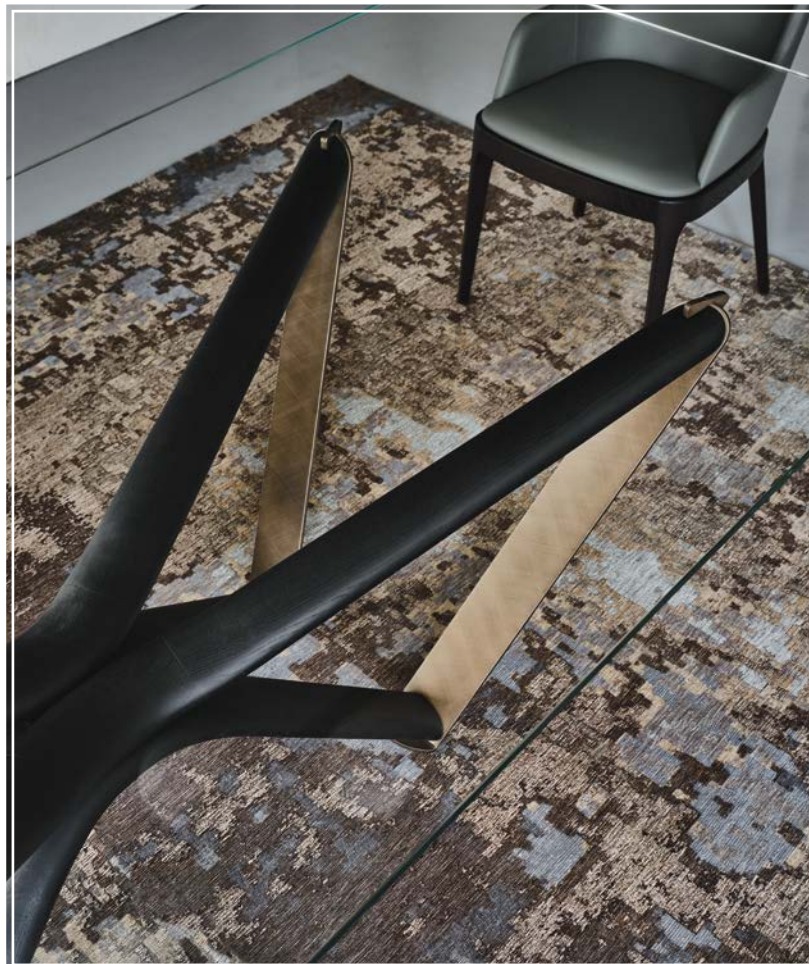
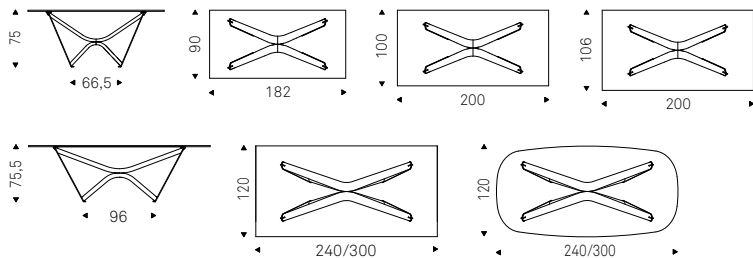

MARATHON table with matt black/brushed bronze base and extra clear glass top -
MAGDA B chair in soft leather 952 smoke and burned oak frame - RADJA rug



MARATHON table with burned oak/titanium base and extra clear glass top - ANNA chairs in soft leather 948 lino and titanium frame -
CLOUD lamps with iride glass lampshades - MAREK rug



MARATHON table with Canaletto walnut/black base and extra clear glass top - NORMA COUTURE chairs in soft leather 952 smoke - MELODY lamps - MAREK rugs



MARATHON table with matt black /titanium base and extra clear glass top - GINEVRA chairs in soft leather 950 tortora and matt black frame

Nasdaq Keramik

Paolo Cattelan | 2020

Scrivania in ceramica Marmi nei colori Calacatta, Alabastro, Ardesia, Golden Calacatta opaco, Golden Calacatta lucido, Portoro opaco, Portoro lucido, Sahara Noir lucido, Emperador, Makalu, Breccia o Arenal con inserto in cromo nero. Gamba in acciaio verniciato goffrato graphite, titanio e bronzo, struttura e cassettera in legno verniciati in tinta con la gamba.

Desk in Marmi ceramic Calacatta, Alabastro, Ardesia, matt Golden Calacatta, glossy Golden Calacatta, matt Portoro, glossy Portoro, glossy Sahara Noir, Emperador, Makalu, Breccia or Arenal with insert in black chrome. Leg in graphite, titanium or bronze embossed lacquered steel, structure and drawer unit embossed lacquered wood matching the color of the leg.

Bureau en céramique Marmi dans les couleurs Calacatta, Alabastro, Ardesia, Golden Calacatta opaque, Golden Calacatta brillant, Portoro opaque, Portoro brillant, Sahara Noir brillant, Emperador, Makalu, Breccia ou Arenal avec insert en chrome noir. Pied en acier gaufré graphite, titane et bronze, structure et tiroirs en bois laqué assortis au pied.

Escritorio en cerámica Marmi colores Calacatta, Alabastro, Ardesia, Golden Calacatta mate, Golden Calacatta brillo, Portoro mate, Portoro brillo, Sahara Noir brillo, Emperador, Makalu, Breccia o Arenal con detalle cromo negro. Pata en acero barnizado gofrado graphite, titanio, bronce, estructura y cajón en madera barnizados del mismo color de la pata.

Schreibtisch in Keramik Marmi in den Farben Calacatta, Alabastro, Ardesia, matt Golden Calacatta, glänzend Golden Calacatta, matt Portoro, glänzend Portoro, glänzend Sahara Noir, Emperador, Makalu, Breccia oder Arenal Detail in schwarz Chrome. Bein aus Metall lackiert graphit, titan bronze gaufriert, Struktur und Schubladenelement aus Holz lackiert sind mit dem Bein gleichfarbig.

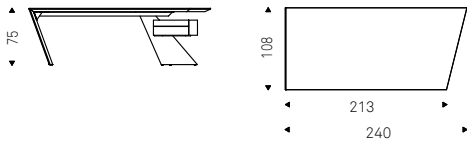

NASDAQ KERAMIK desk with bronze structure and glossy sahara noir ceramic - RADJA rug



NASDAQ KERAMIK desk with bronze structure and glossy sahara noir ceramic - NORMA COUTURE B chair in soft leather 973 nero - RADJA rugs - TIMES mirror/clock in mirrored glass



NASDAQ KERAMIK desk with titanium structure and glossy golden calacatta ceramic



NASDAQ KERAMIK desk with titanium structure and glossy golden calacatta ceramic - KELLY chairs in soft leather 950 tortora and black frame - MAMBA table lamp in titanium - LATITUDE bookcases in titanium





NASDAQ KERAMIK desk with titanium structure and glossy golden calacatta ceramic - KELLY chairs in soft leather 950 tortora and black frame - MAMBA table lamp in titanium - LATITUDE bookcases in titanium - ETOILE consoles in brushed grey - TIMES mirror/clock in mirrored glass





NASDAQ KERAMIK desk with bronze structure and breccia ceramic - BOMBÈ X chairs in soft leather 951 castoro and black frame

Cocoon Keramik

Paolo Cattelan | 2020

Scrivitoio con base in acciaio verniciato goffrato titanio, bronzo o nero. Piano in ceramica Marmi nei colori Calacatta, Alabastro, Ardesia, Golden Calacatta opaco, Golden Calacatta lucido, Portoro opaco, Portoro lucido, Sahara Noir lucido, Emperador, Makalu, Breccia, Arenal o Zefiro con profilo inferiore arrotondato e verniciato Brushed Bronze o Brushed Grey e gola portaoggetti in metallo verniciato Brushed Bronze o Brushed Grey.

Desk with base in titanium, bronze or black embossed lacquered steel. Top in ceramic Marmi Calacatta, Alabastro, Ardesia, matt Golden Calacatta, glossy Golden Calacatta, matt Portoro, glossy Portoro, glossy Sahara Noir, Emperador, Makalu, Breccia, Arenal or Zefiro with Brushed Bronze or Brushed Grey lacquered and rounded lower profile and grooved tray in Brushed Bronze or Brushed Grey lacquered steel.

Bureau avec base en acier gaufré titane, bronze ou noir. Plateau en céramique Marmi dans les couleurs Calacatta, Alabastro, Ardesia, Golden Calacatta opaque, Golden Calacatta brillant, Portoro opaque, Portoro brillant, Sahara Noir brillant, Emperador, Makalu, Breccia, Arenal ou Zefiro avec profil inférieur arrondi laqué Brushed Bronze ou Brushed Grey et plateau rainuré laqué Brushed Bronze ou Brushed Grey.

Escritorio con base en acero barnizado gofrado titanio, bronzo o negro. Sobre en cerámica Marmi colores Calacatta, Alabastro, Ardesia, Golden Calacatta mate, Golden Calacatta brillo, Portoro mate, Portoro brillo, Sahara Noir brillo, Emperador, Makalu, Breccia, Arenal o Zefiro con perfil inferior redondeado barnizado Brushed Bronze o Brushed Grey y bandeja portaobjetos en metal barnizado Brushed Bronze o Brushed Grey.

Schreibtisch mit Basis in Stahl lackiert titan, bronze oder schwarz gaufriert. Platte aus Keramik Marmi in den Farben Calacatta, Alabastro, Ardesia, matt Golden Calacatta, glänzend Golden Calacatta, matt Portoro, glänzend Portoro, glänzend Sahara Noir, Emperador, Makalu, Breccia, Arenal oder Zefiro mit Brushed Bronze oder Brushed Grey lackierten abgerundeten Profil mit gerilltem Objekthalter aus Metall lackiert Brushed Bronze oder Brushed Grey.



COCOON KERAMIK desk with black base, matt golden calacatta ceramic top and brushed grey profile



COCOON KERAMIK desk with black base, arenal ceramic top and brushed grey profile - PANCHO coffee table in brushed grey - MAREK rug



COCOON KERAMIK desk with black base, arenal ceramic top and brushed grey profile - ZULEIKA chair in leather 50 tortora - MAREK rug - FREEWAY bookcase in bronze



COCOON KERAMIK desk with black base, matt portoro ceramic top and brushed grey profile



COCOON KERAMIK desk with black base, makalu ceramic top and brushed bronze profile



COCOON KERAMIK desk with black base, zefiro ceramic top and brushed bronze profile

Cocoon Leather

Paolo Cattelan | 2020

Scrivania con base in acciaio verniciato goffrato titanio, bronzo o nero. Piano in cuoio come da campionario con profilo inferiore arrotondato e verniciato Brushed Bronze o Brushed Grey e gola portaoggetti in metallo verniciato Brushed Bronze o Brushed Grey.

Desk with base in titanium, bronze or black embossed lacquered steel. Top in leather as per sample card with Brushed Bronze or Brushed Grey lacquered and rounded lower profile and grooved tray in Brushed Bronze or Brushed Grey lacquered steel.

Bureau avec base en acier gaufré titane, bronze ou noir. Top en cuir selon les échantillons avec profil inférieur arrondi laqué Brushed Bronze ou Brushed Grey et plateau rainuré laqué Brushed Bronze ou Brushed Grey.

Escritorio con base en acero barnizado gofrado titanio, bronzo o negro. Sobre en cuero según muestrario con perfil inferior redondeado barnizado Brushed Bronze o Brushed Grey y bandeja portaobjetos en metal barnizado Brushed Bronze o Brushed Grey.

Schreibtisch mit Basis in Stahl lackiert titan, bronze oder schwarz gaufriert. Lederplatte laut Musterkarte mit Brushed Bronze oder Brushed Grey lackierten abgerundeten Profil mit gerilltem Objekthalter aus Metall lackiert Brushed Bronze oder Brushed Grey.

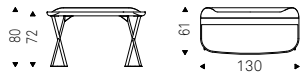

COCOON LEATHER desk with black base, leather 42 fango top and brushed grey profile



COCOON LEATHER desk with black base, leather 49 cenere top and brushed grey profile - MAREK rug

Cocoon Trousse Keramik

Paolo Cattelan | 2020

Console da trucco con base in acciaio verniciato gofrato titanio, bronzo o nero. Piano in ceramica Marmi nei colori Calacatta, Alabastro, Ardesia, Golden Calacatta opaco, Golden Calacatta lucido, Portoro opaco, Portoro lucido, Sahara Noir lucido, Emperador, Makalu, Breccia, Arenal o Zefiro con profilo inferiore arrotondato e verniciato Brushed Bronze o Brushed Grey e gola portaoggetti in metallo verniciato Brushed Bronze o Brushed Grey. Specchiera in acciaio verniciato gofrato titanio, bronzo, nero, Brushed Bronze o Brushed Grey con supporti laterali e ripiani in acciaio verniciato gofrato titanio, bronzo o nero. Illuminazione a led.

Dressing desk with base in titanium, bronze or black embossed lacquered steel. Top in ceramic Marmi Calacatta, Alabastro, Ardesia, matt Golden Calacatta, glossy Golden Calacatta, matt Portoro, glossy Portoro, glossy Sahara Noir, Emperador, Makalu, Breccia, Arenal or Zefiro with Brushed Bronze or Brushed Grey lacquered and rounded lower profile and grooved tray in Brushed Bronze or Brushed Grey lacquered steel. Mirror with frame in titanium, bronze, black, Brushed bronze or Brushed Grey embossed lacquered steel with lateral supports and shelves in titanium, bronze or black embossed lacquered steel. LED light.

Coiffeuse avec base en acier gaufré titane, bronze ou noir. Plateau en céramique Marmi dans les couleurs Calacatta, Alabastro, Ardesia, Golden Calacatta opaque, Golden Calacatta brillant, Portoro opaque, Portoro brillant, Sahara Noir brillant, Emperador, Makalu, Breccia, Arenal ou Zefiro avec profil inférieur arrondi laqué Brushed Bronze ou Brushed Grey et plateau rainuré laqué Brushed Bronze ou Brushed Grey. Miroir avec structure en acier lacqué gaufré titane, bronze ou noir, Brushed Bronze ou Brushed Grey avec supports latéraux et étagères en acier lacqué gaufré titane, bronze ou noir et éclairage à led.

Tocador de maquillaje con base en acero barnizado gofrado titanio, bronzo o negro. Sobre en cerámica Marmi colores Calacatta, Alabastro, Ardesia, Golden Calacatta mate, Golden Calacatta brillo, Portoro mate, Portoro brillo, Sahara Noir brillo, Emperador, Makalu, Breccia, Arenal o Zefiro con perfil inferior redondeado barnizado Brushed Bronze o Brushed Grey y bandeja portaobjetos en metal barnizado Brushed Bronze o Brushed Grey. Espejo con marco en acero barnizado gofrado titanio, bronzo o negro, Brushed Bronze o Brushed Grey con soportes laterales y estantes en acero barnizado gofrado titanio, bronzo o negro. Iluminación LED.

Toilettentisch mit Basis in Stahl lackiert titan, bronze oder schwarz gaufriert. Platte aus Keramik Marmi in den Farben Calacatta, Alabastro, Ardesia, matt Golden Calacatta, glänzend Golden Calacatta, glänzend Portoro, glänzend Sahara Noir, Emperador, Makalu, Breccia, Arenal oder Zefiro mit Brushed Bronze oder Brushed Grey lackierten abgerundeten Profil. Spiegel mit Gestell in Stahl lackiert titan, bronze oder schwarz und LED-Beleuchtung.

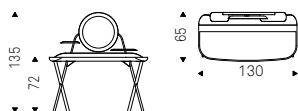



COCOON TROUSSE KERAMIK desk with bronze base, breccia ceramic top and brushed bronze profile - WILMA chair in soft leather 951 castoro - CHENNAI rug



COCOON TROUSSE KERAMIK desk with bronze base, zefiro ceramic top and brushed bronze profile - MAGDA MLA chair in soft leather 948 lino and bronze frame - MAREK rug



COCOON TROUSSE KERAMIK desk with bronze base, breccia ceramic top and brushed bronze profile

Cocoon Trousse Leather

Paolo Cattelan | 2020

Console da trucco con base in acciaio verniciato gofrato titanio, bronzo o nero. Piano in cuoio come da campionario con profilo inferiore arrotondato e verniciato Brushed Bronze o Brushed Grey e gola portaoggetti in metallo verniciato Brushed Bronze o Brushed Grey. Specchiera in acciaio verniciato gofrato titanio, bronzo, nero, Brushed Bronze o Brushed Grey con supporti laterali e ripiani in acciaio verniciato gofrato titanio, bronzo o nero. Illuminazione a led.

Dressing desk with base in titanium, bronze or black embossed lacquered steel. Top in leather as per sample card with Brushed Bronze or Brushed Grey lacquered and rounded lower profile and grooved tray in Brushed Bronze or Brushed Grey lacquered steel. Mirror with frame in titanium, bronze, black, Brushed bronze or Brushed Grey embossed lacquered steel with lateral supports and shelves in titanium, bronze or black embossed lacquered steel. LED light.

Coiffeuse avec base en acier gaufré titane, bronze ou noir. Top en cuir selon les échantillons avec profil inférieur arrondi laqué Brushed Bronze ou Brushed Grey. Miroir avec structure en acier lacqué gaufré titane, bronze ou noir, Brushed Bronze ou Brushed Grey avec supports latéraux et étagères en acier lacqué gaufré titane, bronze ou noir et éclairage à led.

Tocador de maquillaje con base en acero barnizado gofrado titanio, bronzo o negro. Sobre en cuero según muestrario con perfil inferior redondeado barnizado Brushed Bronze o Brushed Grey y bandeja portaobjetos en metal barnizado Brushed Bronze o Brushed Grey. Espejo con marco en acero barnizado gofrado titanio, bronzo o negro, Brushed Bronze o Brushed Grey con soportes laterales y estantes en acero barnizado gofrado titanio, bronzo o negro. Iluminación LED.

Toilettentisch mit Basis in Stahl lackiert titan, bronze oder schwarz gaufriert. Lederplatte laut Musterkarte mit Brushed Bronze oder Brushed Grey lackierten abgerundeten Profil mit gerilltem Objekthalter aus Metall lackiert Brushed Bronze oder Brushed Grey. Spiegel mit Gestell in Stahl lackiert titan, bronze oder schwarz gaufriert, Brushed Bronze oder Brushed Grey mit Seiten-trägern und Böden aus Stahl lackiert titan, bronze oder schwarz gaufriert. LED-Beleuchtung.

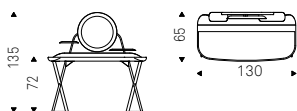



COCOON TROUSSE LEATHER desk with bronze base, leather 88 tabacco top and brushed bronze profile - PANCHO coffee table in brushed bronze - MAREK rug

Etoile

Giorgio Cattelan | 2020

Coppia di consolle con due altezze, struttura in acciaio verniciato Brushed Brass, Brushed Bronze o Brushed Grey e particolari in ottone.

Pair of consoles in two heights, structure in Brushed Brass, Brushed Bronze or Brushed Grey lacquered steel and brass details.

Pair de consoles en deux hauteurs, structure en acier laqué Brushed Brass, Brushed Bronze ou Brushed Grey et détails en laiton.

Pareja de consolas de dos alturas, estructura en acero barnizado Brushed Brass, Brushed Bronze o Brushed Grey y detalles color latón.

Konsolen-Paar in zwei Höhen, Struktur aus Stahl lackiert Brushed Brass, Brushed Bronze oder Brushed Grey und Details in Messing.

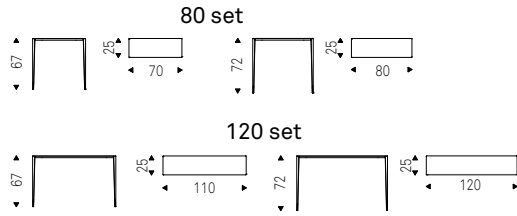



ETOILE consoles in brushed brass - WISH mirror with brushed bronze frame





ETOILE consoles in brushed grey

Terminal Keramik Premium

Paolo Cattelan | 2019

Consolle con base in acciaio verniciato goffrato titanio, bronzo, graphite, nero, Brushed Bronze o Brushed Grey. Piano in ceramica Marmi nei colori Calacatta, Alabastro, Ardesia, Golden Calacatta opaco, Golden Calacatta lucido, Portoro opaco, Portoro lucido, Sahara Noir lucido, Emperador, Makalu, Breccia, Arenal o Zefiro con profilo inferiore arrotondato e verniciato Brushed Bronze o Brushed Grey. Fissaggio a parete necessario. Il piano ha lo spessore di 5cm.

Console with base in titanium, bronze, graphite or black embossed lacquered steel, Brushed Bronze or Brushed Grey. Top in ceramic Marmi Calacatta, Alabastro, Ardesia, matt Golden Calacatta, glossy Golden Calacatta, matt Portoro, glossy Portoro, glossy Sahara Noir, Emperador, Makalu, Breccia, Arenal or Zefiro with Brushed Bronze or Brushed Grey lacquered and rounded lower profile. Wall anchorage is necessary. 5cm thick wooden top.

Console avec base en acier gaufré, laqué titane, bronze, graphite, noir, Brushed Bronze ou Brushed Grey. Plateau en céramique Marmi dans les couleurs Calacatta, Alabastro, Ardesia, Golden Calacatta opaque, Golden Calacatta brillant, Portoro opaque, Portoro brillant, Sahara Noir brillant, Emperador, Makalu, Breccia, Arenal ou Zefiro avec profil inférieur arrondi laqué Brushed Bronze ou Brushed Grey. Fixation au mur nécessaire. Le plateau a une épaisseur de 5cm.

Consola con base en acero barnizado gofrado titanio, bronzo, graphite, negro, Brushed Bronze o Brushed Grey. Sobre en cerámica Marmi colores Calacatta, Alabastro, Ardesia, Golden Calacatta mate, Golden Calacatta brillo, Portoro mate, Portoro brillo, Sahara Noir brillo, Emperador, Makalu, Breccia, Arenal o Zefiro y perfil inferior redondeado barnizado Brushed Bronze o Brushed Grey. Ajuste a la pared necesario. Grosor sobre de 5 cm.

Konsole mit Basis in Stahl lackiert titan, bronze, graphite, schwarz gaufriert, Brushed Bronze oder Brushed Grey. Platte aus Keramik Marmi in den Farben Calacatta, Alabastro, Ardesia, matt Golden Calacatta, glänzend Golden Calacatta, matt Portoro, glänzend Portoro, glänzend Sahara Noir, Emperador, Makalu, Breccia, Arenal oder Zefiro mit Brushed Bronze oder Brushed Grey lackierten abgerundeten Profil. Wandbefestigung ist notwendig. Die Platte ist 5 cm dick.

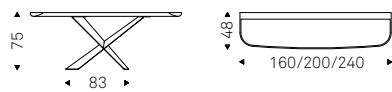
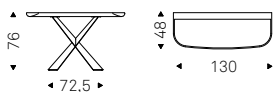

TERMINAL KERAMIK PREMIUM consolle with brushed bronze base, makalu ceramic top and brushed bronze profile - WISH mirror with titanium frame



TERMINAL KERAMIK PREMIUM consolle with brushed grey base, arenal ceramic top and brushed grey profile - MAREK rug





TERMINAL KERAMIK PREMIUM consolle with brushed bronze base, zefiro ceramic top and brushed bronze profile -
SABLIER table lamp with mixed glass (iride-fumé) lamphade - WISH mirror with titanium frame

Westin

Giorgio Cattelan | 2013

Consolle con base in acciaio verniciato goffrato titanio, bronzo, graphite, bianco, nero, mix, Brushed Bronze o Brushed Grey. Piano in cristallo 12mm trasparente, trasparente extrachiaro o in legno noce Canaletto, rovere bruciato o rovere naturale con bordo irregolare in massello. Fissaggio a parete necessario.

Console with base in titanium, bronze, graphite, white, black or mix embossed lacquered steel, Brushed Bronze or Brushed Grey steel. 12mm top in clear, extra clear glass or Canaletto walnut, burned oak or natural oak with solid wood irregular edges. Wall anchorage is necessary.

Console avec base en acier gaufré, laqué titane, bronze, graphite, blanc, noir, mix, Brushed Bronze ou Brushed Grey. Top en verre clair, transparent extra-clair 12mm ou en bois de noyer Canaletto, rouvre brûlé ou rouvre naturel avec bord irrégulier en massif. Fixation au mur nécessaire.

Consola con base en acero barnizado gofrado titanio, bronzo, graphite, blanco, negro, mix, Brushed Bronze o Brushed Grey. Sobre en cristal 12mm transparente, transparente extraclaro o de madera nogal Canaletto, roble ahumado o roble natural con borde irregular en macizo. Ajuste a la pared necesario.

Konsole mit Basis in Stahl lackiert titan, bronze, graphite, weiß, schwarz gaufriert oder mix, Brushed Bronze oder Brushed Grey. Platte in transparentem oder extra hell transparentem Glas in 12mm oder aus Holz Nussbaum Canaletto, "verbrannte Eiche" oder Natur Eiche mit massiven Kanten. Wandbefestigung ist notwendig.

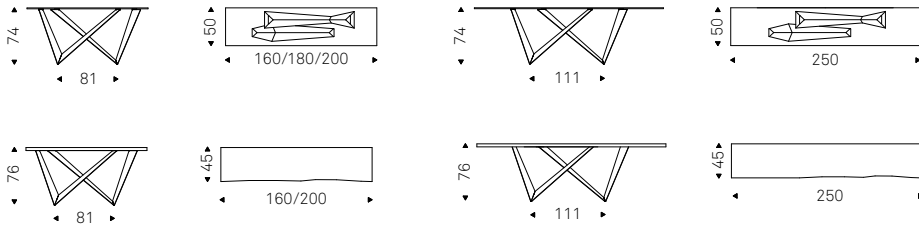



WESTIN consolle with brushed grey base and extra clear glass top - WISH S mirror with black frame - PLANETA wall lamps

Penelope

Paolo Cattelan | 2020

Sedia imbottita con struttura in acciaio interamente rivestita in ecopelle, tessuto, synthetic nubuck, micro nubuck o pelle come da campionario. Decoro colore canna di fucile. Non sfoderabile.

Upholstered chair with steel frame and covered in synthetic leather, fabric, synthetic nubuck, micro nubuck or soft leather as per sample card. Piping gun metal grey color. The cover is not removable.

Chaise avec structure en acier, rembourrée et complètement revêtue en simili cuir, tissu, synthetic nubuck, micro nubuck ou cuir mince selon échantillons. Passepoil en couleur métallique gris. Le revêtement n'est pas déhoussable.

Silla con estructura en acero tapizada y completamente revestida en ecopiel, tejido, synthetic nubuck, micro nubuck o piel según muestrario. Detalle de color gris oscuro con efecto metálico. El tapizado no es desenfundable.

Stuhl mit gepolstertem Stahlgestell mit Bezug aus Kunstleder, Stoff, synthetic nubuck, micro nubuck oder Softleder laut Musterkarte. Rand in der Farbe Metallgrau. Nicht abziehbar.

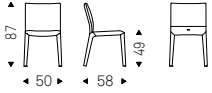



PENELOPE chairs in soft leather 961 latte - TYRON KERAMIK PREMIUM table with titanium base, matt portoro ceramic top and brushed bronze profile- MUMBAI rug - KAYAK sideboard in brushed grey - STRIPES mirror



PENELOPE chair in soft leather glove GLV17 hornet - RADJA rug



PENELOPE chairs in soft leather 948 lino - MUMBAI rug

Italia

Paolo Cattelan | 2020

Sedia con o senza braccioli con struttura in acciaio e rivestimento in tessuto, synthetic nubuck, micro nubuck, ecopelle o pelle come da campionario. Non sfoderabile.

Chair with or without arms with steel frame completely covered in fabric, synthetic nubuck, micro nubuck, synthetic leather or soft leather as per sample card. The cover is not removable.

Chaise avec structure en acier, revetue en tissu, synthetic nubuck, micro nubuck, simili cuir ou cuir mince selon échantillons, avec ou sans accoudoirs. Non déhoussable.

Silla con o sin brazos con estructura en acero tapizada en tejido, synthetic nubuck, micro nubuck, ecopiel o piel según muestrario. No desenfundable.

Stuhl mit oder ohne Armlehnen mit Stahlgestell. Gepolsterte Kissen und Bezug aus Softleder, Stoff, synthetic nubuck, micro nubuck oder Kunstleder laut Musterkarte. Nicht abziehbar.

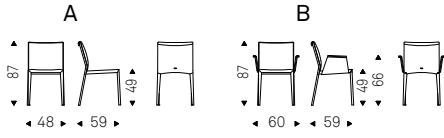



ITALIA chair in soft leather 952 smoke



ITALIA chair in soft leather 977 piombo - TYRON WOOD MASTERWOOD table with titanium base and Canaletto walnut Masterwood top - CHENNAI rugs - LAVANDER sideboard in brushed bronze - REGAL mirror in mirrored glass



Italia Couture

Paolo Cattelan | 2020

Sedia con o senza braccioli con struttura in acciaio e rivestimento in tessuto, synthetic nubuck, micro nubuck, ecopelle o pelle come da campionario. Retro schienale trapuntato. Non sfoderabile.

Chair with or without arms with steel frame completely covered in fabric, synthetic nubuck, micro nubuck, synthetic leather or soft leather as per sample card. Quilted seatback cover. The cover is not removable.

Chaise avec structure en acier, revetue en tissu, synthetic nubuck, micro nubuck, simili cuir ou cuir mince selon échantillons, avec ou sans accoudoirs. Dos de siège matelassé. Le revêtement n'est pas déhoussable.

Silla con o sin brazos con estructura en acero tapizada en tejido, synthetic nubuck, micro nubuck, ecopiel o piel según muestrario. Respaldo exterior acolchado. El tapizado no es desenfundable.

Stuhl mit oder ohne Armlehnen mit Stahlgestell. Gepolsterte Kissen und Bezug aus Softleder, Stoff, synthetic nubuck, micro nubuck oder Kunstleder laut Musterkarte. Rückseite gesteppt. Nicht abziehbar.

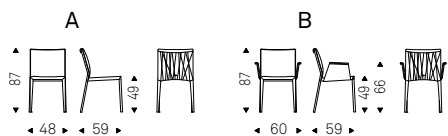



ITALIA COUTURE chairs in soft leather 942 fango





ITALIA COUTURE chair in soft leather 951 castoro - SKORPIO table with brushed grey base and extra clear glass top - METROPOL sideboard with black structure and doors in arenal ceramic - MAGELLANO lamp in titanium

Zuleika

Archirivolto | 2020

Sedia con struttura in acciaio completamente rivestita in cuoio come da campionario. Cuciture standard o in contrasto.

Chair with metal structure. Cover in leather as per sample card. Standard or in contrast stitching.

Chaise avec structure en acier. Revêtement en cuir selon échantillons. Coutures standard ou en contrast.

Silla con estructura en acero. Revestimiento en cuero según muestrario. Cosido de serie o en contraste.

Stuhl mit Gestell aus Edelstahl. Bezug aus Kernleder laut Musterkarte. Nähte Standard oder Kontrast.

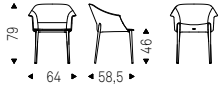



ZULEIKA chairs in leather 50 tortora - FOCUS CRYSTALART sideboard with doors in decorative printed CY02 extra clear glass



ZULEIKA chairs in leather 50 tortora



ZULEIKA chair in leather 73 nero

Rhonda

Luca Signoretti | 2020

Sedia con struttura in acciaio verniciato goffrato titanio, bronzo, graphite o nero. Rivestimento in tessuto, synthetic nubuck, micro nubuck, ecopelle o pelle come da campionario. Non sfoderabile.

Chair with frame in titanium, bronze, graphite or black embossed lacquered steel. Cover in fabric, synthetic nubuck, micro nubuck, soft leather or synthetic leather as per sample card. The cover is not removable.

Chaise avec structure en acier laqué gaufré titane, bronze, graphite ou noir. Revêtement en tissu, synthetic nubuck, micro nubuck, cuir mince ou simili cuir selon échantillons. Le revêtement n'est pas déhoussable.

Silla con estructura en acero barnizado gofrado titanio, bronzo, graphite o negro. Tapizada en tejido, synthetic nubuck, micro nubuck, piel o ecopiel según muestrario. El tapizado no es desenfundable.

Stuhl mit Gestell aus Stahl lackiert titan, bronze, graphite oder schwarz gaufriert. Bezug aus Stoff, synthetic nubuck, micro nubuck, Softleder oder Kunstleder laut Musterkarte. Nicht abziehbar.

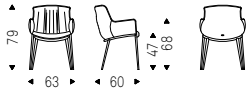



RHONDA chair in soft leather 950 tortora and bronze frame - RADJA rug - KAYAK sideboard in brushed grey - HAWAII E mirrors in bronze mirrored glass

Magda ML

Studio Kronos | 2020

Sedia con o senza braccioli con struttura in acciaio verniciato gofrato titanio, bronzo, graphite, bianco o nero. Rivestimento in tessuto, synthetic nubuck, micro nubuck, ecopelle o pelle come da campionario. Retro schienale trapuntato. Non sfoderabile.

Chair with or without arms with frame in titanium, bronze, graphite, white or black embossed lacquered steel. Cover in fabric, synthetic nubuck, micro nubuck, soft leather or synthetic leather as per sample card. Quilted seatback cover. The cover is not removable.

Chaise avec ou sans accoudoirs, structure en acier laqué gaufré titane, bronze, graphite, blanc ou noir. Revêtement en tissu, synthetic nubuck, micro nubuck, cuir mince ou simili cuir selon échantillons. Dos de siège matelassé. Le revêtement n'est pas déhoussable.

Silla con o sin brazos con estructura en acero barnizado gofrado titanio, bronzo, graphite, blanco o negro. Tapizada en tejido, synthetic nubuck, micro nubuck, piel o ecopiel según muestrario. Respaldo exterior acolchado. El tapizado no es desenfundable.

Stuhl mit oder ohne Armlehnen, Gestell aus Stahl lackiert titan, bronze, graphite, weiß oder schwarz gaufriert. Bezug aus Stoff, synthetic nubuck, micro nubuck, Softleder oder Kunstleder laut Musterkarte. Rückseite gesteppt. Nicht abziehbar.

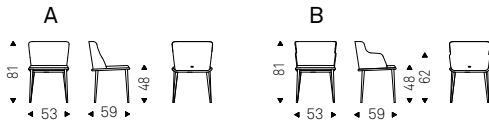

MAGDA ML B chair in soft leather 951 castoro and titanium frame



MAGDA MLA chair in soft leather 948 lino and bronze frame



MAGDA ML B chair in soft leather 953 ardesia and bronze frame - COCOON KERAMIK desk with black base, arenal ceramic top and brushed grey profile - MAREK rug



Magda ML Couture

Studio Kronos | 2020

Sedia con o senza braccioli con struttura in acciaio verniciato gofrato titanio, bronzo, graphite o nero. Rivestimento in tessuto, synthetic nubuck, micro nubuck, ecopelle o pelle come da campionario. Retro schienale trapuntato. Non sfoderabile.

Chair with or without arms with frame in titanium, bronze, graphite or black embossed lacquered steel. Cover in fabric, synthetic nubuck, micro nubuck, soft leather or synthetic leather as per sample card. Quilted seatback cover. The cover is not removable.

Chaise avec ou sans accoudoirs, structure en acier laqué gaufré titane, bronze, graphite ou noir. Revêtement en tissu, synthetic nubuck, micro nubuck, cuir mince ou simili cuir selon échantillons. Dos de siège matelassé. Le revêtement n'est pas déhoussable.

Silla con o sin brazos con estructura en acero barnizado gofrado titanio, bronzo, graphite o negro. Tapizada en tejido, synthetic nubuck, micro nubuck, piel o ecopiel según muestrario. Respaldo exterior acolchado. El tapizado no es desfundable.

Stuhl mit oder ohne Armlehnen, Gestell aus Stahl lackiert titan, bronze, graphite oder schwarz gaufriert. Bezug aus Stoff, synthetic nubuck, micro nubuck, Softleder oder Kunstleder laut Musterkarte. Rückseite gesteppt. Nicht abziehbar.

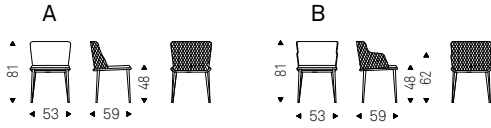



MAGDA ML COUTURE A chairs in soft leather 977 piombo and titanium frame





MAGDA ML COUTURE B chairs in soft leather 951 castoro and titanium frame -
TYRON KERAMIK DRIVE table with titanium base and glossy golden calacatta ceramic top - PLANETA lamp - RADJA rug

Wilma

Paolo Cattelan | 2020

Sedia imbottita con struttura in acciaio interamente rivestita in tessuto, ecopelle, synthetic nubuck o pelle come da campionario. Non sfoderabile.

Chair with steel frame and covered in fabric, synthetic leather, synthetic nubuck or soft leather as per sample card. The cover is not removable.

Chaise avec structure en acier, rembourrée et complètement revêtue en tissu, simili cuir, synthetic nubuck ou cuir mince selon échantillons. Le revêtement n'est pas déhoussable.

Silla con estructura en acero tapizada y completamente revestida en tejido, ecopiel, synthetic nubuck o piel según muestrario. El tapizado no es desenfundable.

Stuhl mit gepolstertem Stahlgestell mit Bezug aus Stoff, Kunstleder, synthetic nubuck oder Softleder laut Musterkarte. Nicht abziehbar.

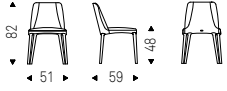

WILMA chair in soft leather 973 nero



WILMA chair in soft leather 952 smoke - DARWIN rug

Bombè

Paolo Cattelan | 2020

Sedia girevole con struttura in acciaio verniciato gofrato graphite o bianco. Piedi in frassino tinto noce Canaletto, frassino tinto rovere bruciato, laccato poro aperto nero opaco. Seduta e schienale rivestiti in tessuto, synthetic nubuck, micro nubuck, ecopelle o pelle come da campionario.

Swiveling chair with graphite or white embossed lacquered steel frame. Feet in Canaletto walnut stained ashwood, burned oak stained ashwood or open pore matt black painted. Seat and back upholstered in fabric, synthetic nubuck, micro nubuck, synthetic leather or soft leather as per sample card.

Chaise pivotante avec structure en acier gaufré graphite ou blanc. Pieds en frêne teinté noyer Canaletto, frêne teinté rouvre brulé ou laqué pore ouvert noir opaque. Assise et dossier revêtus en tissu, synthetic nubuck, micro nubuck, simili cuir ou cuir mince selon échantillons.

Silla giratoria con estructura en acero gofrado barnizado graphite o blanco. Patas en fresno barnizado nogal Canaletto, fresno barnizado roble ahumado, fresno barnizado negro mate a poro abierto. Asiento y respaldo tapizados en tejido, synthetic nubuck, micro nubuck, ecopiel o piel según muestrario.

Stuhl drehbar mit Gestell in Edelstahl lackiert graphite oder weiß gaufriert. Füße in Esche gebeizt Nussbaum Canaletto, "verbrannte Eiche", oder offenporig lackiert schwarz matt. Sitz und Rücken mit Stoff, synthetic nubuck, micro nubuck, Kunstleder oder Softlederbezug, laut Musterkarte.

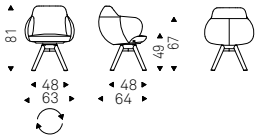



BOMBÈ chairs in soft leather 948 lino, graphite and burned oak frame - TYRON KERAMIK PREMIUM table with bronze base, arenal ceramic top and brushed grey profile - MUMBAI rugs





BOMBÈ chairs in soft leather 948 lino, graphite and burned oak frame - TYRON KERAMIK PREMIUM table with bronze base, arenal ceramic top and brushed grey profile - MUMBAI rugs

Bombè X

Paolo Cattelan | 2020

Sedia girevole con base a 4 razze in acciaio verniciato goffrato titanio, bronzo, graphite o nero. Seduta e schienale rivestiti in tessuto, synthetic nubuck, micro nubuck, ecopelle o pelle come da campionario.

Swiveling chair with 4 spokes base in titanium, bronze, graphite or black embossed lacquered steel. Seat and back upholstered in fabric, synthetic nubuck, micro nubuck, synthetic leather or soft leather as per sample card.

Chaise pivotante avec base avec 4 rayons en acier gaufré titane, bronze, graphite ou noir. Assise et dossier revêtus en tissu, synthetic nubuck, micro nubuck, simili cuir ou cuir mince selon échantillons.

Silla giratoria con base con 4 radios en acero gofrado barnizado titanio, bronzo, graphite o negro. Asiento y respaldo tapizados en tejido, synthetic nubuck, micro nubuck, ecopiel o piel según muestrario.

Drehstuhl mit 4-Sterne-Basis aus Stahl lackiert titan, bronze, graphite oder schwarz gaufriert. Sitz und Rücken mit Stoff, synthetic nubuck, micro nubuck, Kunstleder oder Softlederbezug, laut Musterkarte.

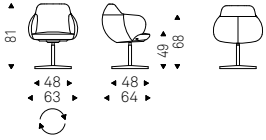



BOMBÈ X chair in soft leather 951 castoro and black frame



BOMBÈ X chair in soft leather 951 castoro and black frame



Chris

Paolo Cattelan | 2020

Sedia con struttura in frassino naturale, frassino tinto noce Canaletto, frassino tinto rovere bruciato o frassino laccato poro aperto nero opaco. Rivestimento in tessuto, synthetic nubuck, micro nubuck, ecopelle o pelle come da campionario. Il rivestimento non è sfoderabile.

Chair in natural ashwood, Canaletto walnut stained ashwood, burned oak stained ashwood or open pore matt black ashwood. Cover in fabric, synthetic nubuck, micro nubuck, synthetic leather or soft leather as per sample card. The cover is not removable.

Chaise avec structure en frêne naturel, frêne teinté noyer Canaletto, frêne teinté rouvre brulé ou frêne laqué noir opaque pore ouvert. Revêtement en tissu, synthetic nubuck, micro nubuck, simili cuir ou cuir mince selon échantillons. Non déhoussable.

Silla con estructura en fresno natural, fresno barnizado nogal Canaletto, fresno barnizado roble ahumado o fresno barnizado negro mate a poro abierto. Revestimiento en tejido, synthetic nubuck, micro nubuck, ecopiel o piel según muestrario. No desenfundable.

Stuhl mit Gestell in Esche gebeizt Esche Natur, Nussbaum Canaletto, "verbrannte Eiche" oder offenporig lackiert in den Farben matt schwarz. Bezug aus Stoff, synthetic nubuck, micro nubuck, Kunstleder oder Softleder, laut Musterkarte. Bezug nicht abziehbar.

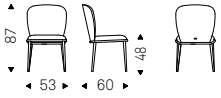



CHRIS chair in soft leather 952 smoke and burned oak frame

Chrishell

Paolo Cattelan | 2020

Sedia con struttura in frassino naturale, frassino tinto noce Canaletto, frassino tinto rovere bruciato o frassino laccato poro aperto nero opaco. Rivestimento in tessuto, synthetic nubuck, micro nubuck, ecopelle o pelle come da campionario. Retro schienale trapuntato. Non sfoderabile.

Chair in natural ashwood, Canaletto walnut stained ashwood, burned oak stained ashwood or open pore matt black ashwood. Cover in fabric, synthetic nubuck, micro nubuck, synthetic leather or soft leather as per sample card. Quilted seatback cover. The cover is not removable.

Chaise avec structure en frêne naturel, frêne teinté noyer Canaletto, frêne teinté rouvre brulé ou frêne laqué noir opaque pore ouvert. Revêtement en tissu, synthetic nubuck, micro nubuck, simili cuir ou cuir mince selon échantillons. Dos de siège matelassé. Le revêtement n'est pas déhoussable.

Silla con estructura en fresno natural, fresno barnizado nogal Canaletto, fresno barnizado roble ahumado o fresno barnizado negro mate a poro abierto. Revestimiento en tejido, synthetic nubuck, micro nubuck, ecopiel o piel según muestrario. Respaldo exterior acolchado. El tapizado no es desenfundable.

Stuhl mit Gestell in Esche gebeizt Esche Natur, Nussbaum Canaletto, "verbrannte Eiche" oder offenporig lackiert in den Farben matt schwarz. Bezug aus Stoff, synthetic nubuck, micro nubuck, Kunstleder oder Softleder, laut Musterkarte. Rückseite gesteppt. Nicht abziehbar.

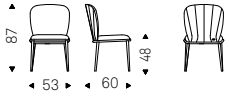



CHRISHELL chair in soft leather 948 lino and burned oak frame

Chris ML

Paolo Cattelan | 2020

Sedia con struttura in acciaio verniciato goffrato titanio, bronzo, graphite, bianco o nero. Rivestimento in tessuto, synthetic nubuck, micro nubuck, ecopelle o pelle come da campionario. Non sfoderabile.

Chair with frame in titanium, bronze, graphite, white or black embossed lacquered steel. Cover in fabric, synthetic nubuck, micro nubuck, soft leather or synthetic leather as per sample card. The cover is not removable.

Chaise avec structure en acier laqué gaufré titane, bronze, graphite, blanc ou noir. Revêtement en tissu, synthetic nubuck, micro nubuck, cuir mince ou simili cuir selon échantillons. Le revêtement n'est pas déhoussable.

Silla con estructura en acero barnizado gofrado titanio, bronzo, graphite, blanco o negro. Tapizada en tejido, synthetic nubuck, micro nubuck, piel o ecopiel según muestrario. El tapizado no es desenfundable.

Stuhl mit Gestell aus Stahl lackiert titan, bronze, graphite, weiß oder schwarz gaufriert. Bezug aus Stoff, synthetic nubuck, micro nubuck, Softleder oder Kunstleder laut Musterkarte. Nicht abziehbar.

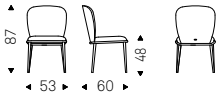



CHRIS ML chair in soft leather 952 smoke and bronze frame - MAPOON rug

Chrishell ML

Paolo Cattelan | 2020

Sedia con struttura in acciaio verniciato gofrato titanio, bronzo, graphite, bianco o nero. Rivestimento in tessuto, synthetic nubuck, micro nubuck, ecopelle o pelle come da campionario. Retro schienale trapuntato. Non sfoderabile.

Chair with frame in titanium, bronze, graphite, white or black embossed lacquered steel. Cover in fabric, synthetic nubuck, micro nubuck, soft leather or synthetic leather as per sample card. Quilted seatback cover. The cover is not removable.

Chaise avec structure en acier laqué gaufré titane, bronze, graphite, blanc ou noir. Revêtement en tissu, synthetic nubuck, micro nubuck, cuir mince ou simili cuir selon échantillons. Dos de siège matelassé. Le revêtement n'est pas déhoussable.

Silla con estructura en acero barnizado gofrado titanio, bronzo, graphite, blanco o negro. Tapizada en tejido, synthetic nubuck, micro nubuck, piel o ecopiel según muestrario. Respaldo exterior acolchado. El tapizado no es desenfundable.

Stuhl mit Gestell aus Stahl lackiert titan, bronze, graphite, weiß oder schwarz gaufriert. Bezug aus Stoff, synthetic nubuck, micro nubuck, Softleder oder Kunstleder laut Musterkarte. Rückseite gesteppt. Nicht abziehbar.

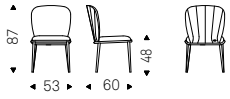

CHRISHELL ML chair in soft leather 948 lino and bronze frame



CHRISHELL ML chair in soft leather 952 smoke and bronze frame - MAD MAX WOOD S table with brushed bronze base and Canaletto walnut top

Norma B / Norma B Couture

Paolo Cattelan | 2017

Sedia imbottita con o senza braccioli con struttura in acciaio interamente rivestita in ecopelle, synthetic nubuck o pelle come da campionario. Retro schienale trapuntato. Non sfoderabile.

Upholstered chair with or without arms with steel frame and covered in synthetic leather, synthetic nubuck or soft leather as per sample card. Quilted seatback cover. The cover is not removable.

Chaise avec ou sans accoudoirs avec structure en acier, rembourrée et complètement revêtue en similicuir, synthetic nubuck ou cuir mince selon échantillons. Dos de siège matelassé. Le revêtement n'est pas déhoussable.

Silla con o sin brazos con estructura en acero tapizada y completamente revestida en ecopiel, synthetic nubuck o piel según muestrario. Respaldo exterior acolchado. El tapizado no es desenfundable.

Stuhl mit oder ohne Armlehnen mit gepolstertem Stahlgestell mit Bezug aus Kunstleder, synthetic nubuck oder Softleder laut Musterkarte. Rückseite gesteppt. Nicht abziehbar.

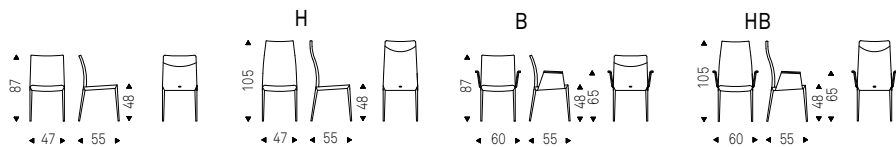

Norma ML B / Norma ML B Couture

Paolo Cattelan | 2018

Sedia imbottita con o senza braccioli con struttura in acciaio cromato, cromo nero, verniciato bianco, graphite, gofrato titanio o bronzo. Rivestita in ecopelle, synthetic nubuck o pelle come da campionario. Retro schienale trapuntato. Non sfoderabile.

Upholstered chair with or without arms with steel structure in chromed or black chrome, white, graphite, titanium or bronze finish and covered in synthetic leather, synthetic nubuck or soft leather as per sample card. Quilted seatback cover. The cover is not removable.

Chaise avec ou sans accoudoirs avec structure en acier chromé, chromé noir, laqué blanc, graphite opaque, gaufré titane ou bronze, rembourrée et revêtue en simili cuir, synthetic nubuck ou cuir mince selon échantillons. Dos de siège matelassé. Le revêtement n'est pas déhoussable.

Silla con o sin brazos con estructura en acero cromado o cromo negro, barnizado blanco, graphite mate, gofrado titanio o bronce. Revestida en ecopiel, synthetic nubuck o piel según muestrario. Respaldo exterior acolchado. El tapizado no es desenfundable.

Stuhl mit oder ohne Armlehnen mit verchromtem oder schwarz chrom, weiß, graphite, titan oder bronze lackiertem Stahlgestell. Bezug aus Kunstleder, synthetic nubuck oder Softleder laut Musterkarte. Rückseite gesteppt. Nicht abziehbar.

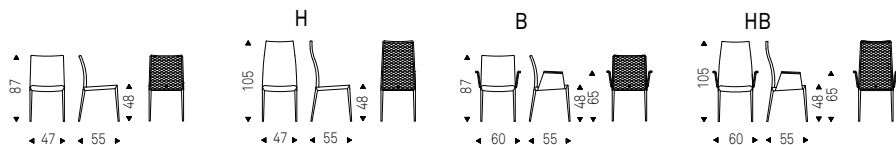



NORMA COUTURE B chairs in soft leather 973 nero - NASDAQ KERAMIK desk with bronze structure and glossy sahara noir ceramic - RADJA rug - SPINNAKER bookcases

Norma Sgabello

Paolo Cattelan | 2020

Sgabello imbottito con struttura in acciaio interamente rivestita in ecopelle, tessuto, synthetic nubuck, micro nubuck o pelle come da campionario. Non sfoderabile.

Stool with steel frame covered in synthetic leather, fabric, synthetic nubuck, micro nubuck or soft leather as per sample card. The cover is not removable.

Tabouret avec structure en acier, rembourrée et complètement revêtue en simili cuir, tissu, synthetic nubuck, micro nubuck ou cuir mince selon échantillons. Le revêtement n'est pas déhoussable.

Taburete con estructura en acero tapizada y completamente revestida en ecopiel, tejido, synthetic nubuck, micro nubuck o piel según muestrario. El tapizado no es desenfundable.

Barhocker mit gepolstertem Stahlgestell mit Bezug aus Kunstleder, Stoff, synthetic nubuck, micro nubuck oder Softleder laut Musterkarte. Nicht abziehbar.

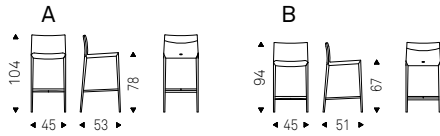

Norma Couture Sgabello

Paolo Cattelan | 2020

Sgabello imbottito con struttura in acciaio interamente rivestita in ecopelle, tessuto, synthetic nubuck, micro nubuck o pelle come da campionario. Retro schienale trapuntato. Non sfoderabile.

Stool with steel frame covered in synthetic leather, fabric, synthetic nubuck, micro nubuck or soft leather as per sample card. Quilted seatback cover. The cover is not removable.

Tabouret avec structure en acier, rembourrée et complètement revêtue en simili cuir, tissu, synthetic nubuck, micro nubuck ou cuir mince selon échantillons. Dos de siège matelassé. Le revêtement n'est pas déhoussable.

Taburete con estructura en acero tapizada y completamente revestida en ecopiel, tejido, synthetic nubuck, micro nubuck o piel según muestrario. Respaldo exterior acolchado. El tapizado no es desenfundable.

Barhocker mit gepolstertem Stahlgestell mit Bezug aus Kunstleder, Stoff, synthetic nubuck, micro nubuck oder Softleder laut Musterkarte. Rückseite gesteppt. Nicht abziehbar.

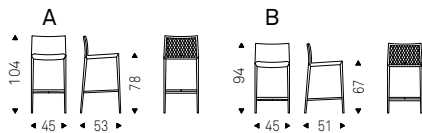



NORMA SGABELLO B stool in soft leather 948 lino - NORMA COUTURE SGABELLO A stool in soft leather 952 smoke

Norma ML Sgabello

Paolo Cattelan | 2020

Sgabello con struttura in acciaio verniciato gofrato titanio, bronzo, graphite, bianco o nero. Rivestimento in tessuto, synthetic nubuck, micro nubuck, ecopelle o pelle come da campionario. Non sfoderabile.

Stool with frame in titanium, bronze, graphite, white or black embossed lacquered steel. Cover in fabric, synthetic nubuck, micro nubuck, soft leather or synthetic leather as per sample card. The cover is not removable.

Tabouret avec structure en acier laqué gaufré titane, bronze, graphite, blanc ou noir. Revêtement en tissu, synthetic nubuck, micro nubuck, cuir mince ou simili cuir selon échantillons. Le revêtement n'est pas déhoussable.

Taburete con estructura en acero barnizado gofrado titanio, bronzo, graphite, blanco o negro. Tapizada en tejido, synthetic nubuck, micro nubuck, piel o ecopiel según muestrario. El tapizado no es desenfundable.

Barhocker mit Gestell aus Stahl lackiert titan, bronze, graphite, weiß oder schwarz gaufriert. Bezug aus Stoff, synthetic nubuck, micro nubuck, Softleder oder Kunstleder laut Musterkarte. Nicht abziehbar.

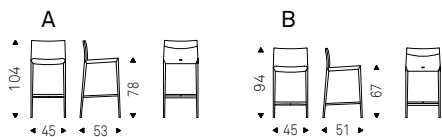

Norma ML Couture Sgabello

Paolo Cattelan | 2020

Sgabello con struttura in acciaio verniciato gofrato titanio, bronzo, graphite, bianco o nero. Rivestimento in ecopelle, tessuto, synthetic nubuck, micro nubuck o pelle come da campionario. Retro schienale trapuntato. Non sfoderabile.

Stool with frame in titanium, bronze, graphite, white or black embossed lacquered steel. Cover in fabric, synthetic nubuck, micro nubuck, soft leather or synthetic leather as per sample card. Quilted seatback cover. The cover is not removable.

Tabouret avec structure en acier laqué gaufré titane, bronze, graphite, blanc ou noir. Revêtement en tissu, synthetic nubuck, micro nubuck, cuir mince ou simili cuir selon échantillons. Dos de siège matelassé. Le revêtement n'est pas déhoussable.

Taburete con estructura en acero barnizado gofrado titanio, bronzo, graphite, blanco o negro. Tapizada en tejido, synthetic nubuck, micro nubuck, piel o ecopiel según muestrario. Respaldo exterior acolchado. El tapizado no es desenfundable.

Barhocker mit Gestell aus Stahl lackiert titan, bronze, graphite, weiß oder schwarz gaufriert. Bezug aus Stoff, synthetic nubuck, micro nubuck, Softleder oder Kunstleder laut Musterkarte. Rückseite gesteppt. Nicht abziehbar.

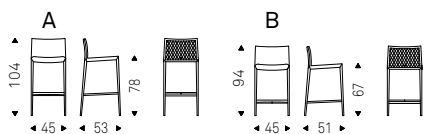

NORMA ML COUTURE SGABELLO B stool in soft leather 951 castoro and titanium frame



NORMA ML SGABELLO A stools in soft leather 953 ardesia and graphite frame - NIDO KERAMIK BISTROT A table with black base and ardesia ceramic top - APOLLO lamps

Sofia Sgabello

Paolo Cattelan | 2020

Sgabello con struttura in faggio naturale, tinto noce Canaletto, wenghè, bianco o nero opaco. Rivestimento in tessuto, synthetic nubuck, micro nubuck, ecopelle o pelle come da campionario. Non sfoderabile.

Stool with frame in natural beech, Canaletto walnut, wenghè, matt white or black stained beech. Cover in fabric, synthetic nubuck, micro nubuck, soft leather or synthetic leather as per sample card. The cover is not removable.

Tabouret avec structure en hêtre naturel, teinté noyer Canaletto, wenghè, ou laqué blanc ou noir opaque. Revêtement en tissu, synthetic nubuck, micro nubuck, simili cuir ou cuir mince selon échantillons. Le revêtement n'est pas déhoussable.

Taburete con patas en haya natural, teñida nogal Canaletto, wenghè, blanco o negro mate. Revestimiento en tejido, synthetic nubuck, micro nubuck, ecopiel o piel según muestrario. El tapizado no es desenfundable.

Barhocker mit gestell in Buche natur, gebeizt Nussbaum Canaletto, wenghè, matt weiß oder schwarz. Bezug in Stoff, synthetic nubuck, micro nubuck, Kunstleder oder Softleder laut Musterkarte. Nicht abziehbar.

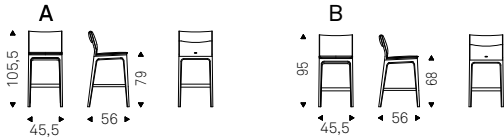

SOFIA A stool in soft leather 953 ardesia and wenghè frame



SOFIA B stool in soft leather 948 lino and Canaletto walnut frame - SOFIA A stool in soft leather 982 cognac and wenghè frame

Wanda Sgabello

Paolo Cattelan | 2020

Sgabello imbottito con struttura in acciaio interamente rivestita in tessuto, ecopelle, synthetic nubuck o pelle come da campionario. Non sfoderabile.

Stool with steel frame and covered in fabric, synthetic leather, synthetic nubuck or soft leather as per sample card. The cover is not removable.

Tabouret avec structure en acier, rembourrée et complètement revêtue en tissu, simili cuir, synthetic nubuck ou cuir mince selon échantillons. Le revêtement n'est pas déhoussable.

Taburete con estructura en acero tapizada y completamente revestida en tejido, ecopiel, synthetic nubuck o piel según muestrario. El tapizado no es desenfundable.

Barhocker mit a Stahlgestell mit Bezug aus Stoff, Kunstleder, synthetic nubuck oder Softleder laut Musterkarte. Nicht abziehbar.

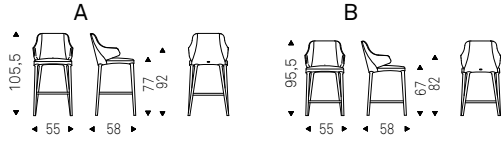

WANDA A stool in soft leather 953 ardesia



WANDA A stools in soft leather 951 castoro - RIBOT KERAMIK BISTROT A table with black base, matt portoro ceramic top and brushed bronze profile -BYBLOS lamp with black fabric lampshade

Pancho Sgabello

Paolo Cattelan | 2020

Sgabello con struttura in acciaio Brushed Bronze o Brushed Grey e poggiapiedi in acciaio verniciato gofrato nero.

Stool with Brushed Bronze or Brushed Grey steel structure and footrests in black embossed lacquered steel.

Tabouret avec structure en acier Brushed Bronze ou Brushed Grey et repose-pieds en acier laqué gaufré noir.

Taburete con estructura en acero Brushed Bronze o Brushed Grey y reposapiés en acero barnizado gofrado negro.

Barhocker mit Basis aus Stahl in Brushed Bronze oder Brushed Grey und Fußraste in Stahl lackiert schwarz gaufriert.

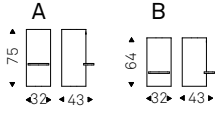

PANCHO A-B stools in brushed bronze



PANCHO A-B stools in brushed bronze

Lavander

Paolo Cattelan | 2020

Madia contenitore a due o tre ante in legno laccato graphite opaco, titanio, Brushed Bronze o Brushed Grey. Piedini in acciaio inox lucido o verniciati graphite opaco. Ripiani interni in cristallo trasparente. Optional: cassetto interno posizionabile su ognuna delle ante.

Sideboard 2 or 3 doors in matt graphite or titanium lacquered wood, Brushed Bronze or Brushed Grey. Polished stainless steel feet or graphite varnished. Internal clear glass shelves. Optional: internal drawer in each door.

Bahut 2 ou 3 portes en bois laqué graphite opaque, titane, Brushed Bronze ou Brushed Grey. Pieds en acier inox brillant ou graphite opaque. Étagère en verre clair. Optionnel: tiroir interne positionnable sur chacune des portes.

Aparador de 2 o 3 puertas en madera lacada graphite mate, titanio, Brushed Bronze o Brushed Grey. Patas en acero inox brillo o barnizado graphite mate. Estantes interiores en cristal transparente. Opcional: el cajón interior se puede posicionar en cada de las puertas.

Anrichte mit zwei oder drei Türen in Holz glänzend lackiert in graphite, titan, Brushed Bronze oder Brushed Grey. Füße aus glänzendem Edelstahl, oder matt graphite lackiert. Innenböden in Klarglas. Optional: Innenschublade hinter jeder Tür positionierbar.

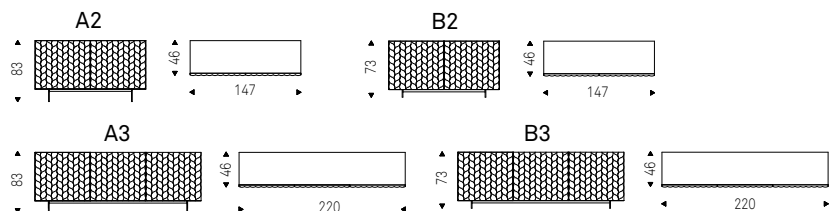



LAVANDER B3 sideboard in brushed bronze - REGAL mirror in fumé mirrored glass



LAVANDER A3 sideboard in titanium - EMERALD mirror in fumé mirrored glass



LAVANDER B3 sideboard in brushed bronze - REGAL mirror in fumé mirrored glass

Spiga

Paolo Cattelan | 2020

Madia contenitore in legno gofrato graphite, titanio, Brushed Bronze o Brushed Grey. Piedini in acciaio verniciato gofrato graphite o nero. Interno parzialmente specchiato e ripiani in cristallo fumé. Optional: kit luce interna a led.

Sideboard in embossed graphite or titanium lacquered wood, Brushed Bronze or Brushed Grey. Feet in graphite or black embossed lacquered steel. Partially mirrored inside and fumé glass shelves. Optional: internal led light kit.

Bahut en bois laqué gaufré graphite, titane, Brushed Bronze ou Brushed Grey. Pieds en acier laqué gaufré graphite ou noir. Interne partiellement miroité et étagères en verre fumé. Optionnel: kit lumière interne à led.

Aparador en madera gofrado graphite, titanio, Brushed Bronze o Brushed Grey. Patas en acero barnizado gofrado graphite o negro. Interior parcialmente espejado y estantes en cristal fumé. Opcional: kit iluminación interior led.

Anrichte in Holz lackiert graphit, titan gaufriert, Brushed Bronze oder Brushed Grey. Füße aus Stahl lackiert graphit oder schwarz gaufriert. Teilweise verspiegelter Innenraum und Innenböden aus fumé Glas. Optional: LED Kit für Innenbeleuchtung.

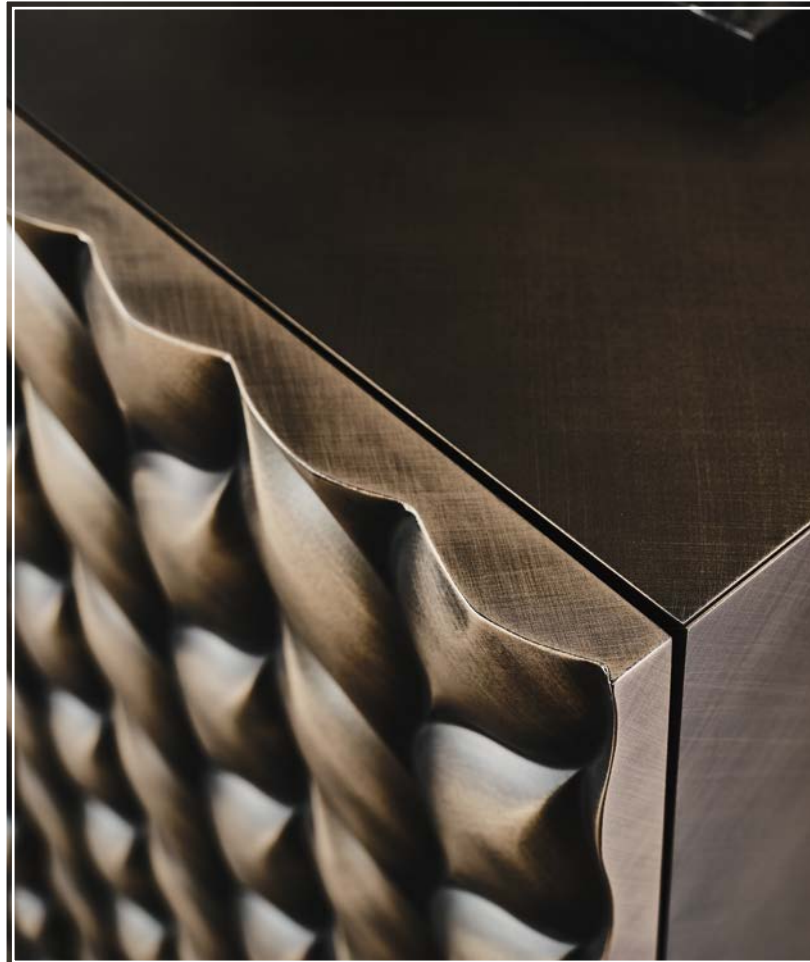
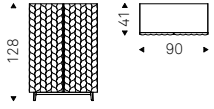



SPIGA sideboards in brushed bronze - PLANETA table lamp

Kayak

Andrea Lucatello | 2009

Madia contenitore a due o tre ante in legno laccato bianco lucido, nero lucido, moka lucido, rosso lucido, graphite opaco, titanio, Brushed Bronze o Brushed Grey. Piedini in acciaio inox lucido, verniciati bianco o graphite opaco. Ripiani interni in cristallo trasparente. Optional: cassetto interno posizionabile su ognuna delle ante.

Sideboard 2 or 3 doors in polished lacquered glossy black, glossy white, glossy moka, glossy red, matt graphite, titanium, Brushed Bronze or Brushed Grey. Polished stainless steel feet, matt white or graphite varnished. Internal clear glass shelves. Optional: internal drawer in each door.

Bahut 2 ou 3 portes bois laqué blanc brillant, noir brillant, moka brillant, rouge brillant, graphite opaque, titane, Brushed Bronze ou Brushed Grey. Pieds en acier inox brillant, laqué blanc ou graphite opaque. Étagère en verre clair. Optionnel: tiroir interne positionnable sur chacune des portes.

Aparador de 2 o 3 puertas en madera lacada blanco brillo, negro brillo, moka brillo, rojo brillo, graphite mate, titanio, Brushed Bronze o Brushed Grey. Patas en acero inox brillo, barnizado blanco o graphite mate. Estantes interiores en cristal transparente. Opcional: el cajón interior se puede posicionar en cada de las puertas.

Anrichte mit zwei oder drei Türen in Holz glänzend lackiert in weiß, schwarz, moka, rot, matt lackiert in graphit, lackiert titan, Brushed Bronze oder Brushed Grey. Füße aus glänzendem Edelstahl, oder matt weiß oder graphit lackiert. Innenböden in Klarglas. Optional: Innenschublade hinter jeder Tür positionierbar.

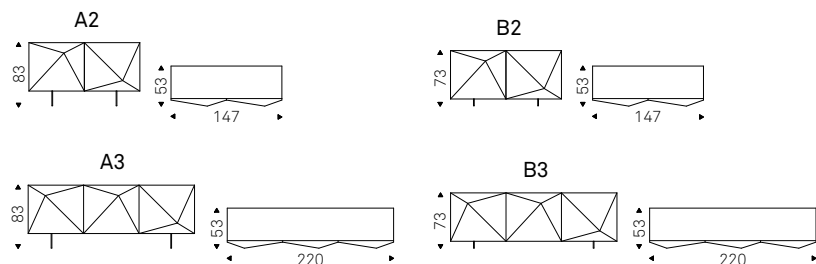



KAYAK A3 sideboard in brushed grey - HAWAII E mirrors in bronze mirrored glass

Focus CrystalArt

Paolo Cattelan | 2020

Madia contenitore a due o tre ante in legno laccato bianco opaco, graphite opaco o titanio. Ante in cristallo extrachiaro con stampa artistica decorativa in due varianti colore e profili in alluminio verniciato titanio goffrato. Piedini in acciaio inox lucido, verniciati bianco o graphite opaco. Ripiani interni in cristallo trasparente. Optional: cassetto interno posizionabile su ognuna delle ante. Optional: top in cristallo extrachiaro con stampa artistica decorativa in due varianti colore in tinta con le ante.

Sideboard 2 or 3 doors in matt white, matt graphite or titanium lacquered wood. Doors in extra clear glass with artistic decorative printing in two different colours and embossed titanium aluminum profiles. Polished stainless steel feet, matt white or graphite varnished. Internal clear glass shelves. Optional: internal drawer in each door. Optional: extra clear glass top with artistic decorative printing in two different colours matching the doors colour.

Bahut 2 ou 3 portes en bois laqué blanc opaque, graphite opaque ou titane. Portes en verre extra-clair avec impression artistique décorative en deux couleurs différentes et profils en aluminium gaufré titane. Pieds en acier inox brillant, laqués blanc ou graphite opaque. Étagères en verre clair. Optionnel: tiroir interne positionnable sur chaque porte. Optionnel: plateau en verre extra-clair avec impression artistique décorative en deux couleurs différentes de la même couleur des portes.

Aparador de 2 o 3 puertas en madera lacada blanco mate, graphite mate o titanio. Puertas en cristal extraclaro con impresión artística decorativa en dos variantes de color y perfil en aluminio gofrado titanio. Patas en acero inox brillo, barnizado blanco o graphite mate. Estantes interiores en cristal transparente. Opcional: el cajón interior se puede posicionar en cada una de las puertas. Opcional: sobre en cristal extraclaro con impresión artística decorativa en dos variantes de color en el mismo color de las puertas.

Anrichte mit zwei oder drei Türen aus Holz lackiert weiß matt, graphit matt oder titan. Türen aus extra hell Glas mit schmückenden Kunstdruck in zwei Farbvarianten mit Aluminium Rahmen in titan gaufriert. Füße aus glänzendem Edelstahl, oder matt weiß oder graphit lackiert. Innenböden aus Klarglas. Optional: Innenschublade hinter jeder Tür positionierbar. Optional: extra hell Glasplatte mit schmückenden Kunstdruck in zwei Farbvarianten mit Türen gleichfarbig.

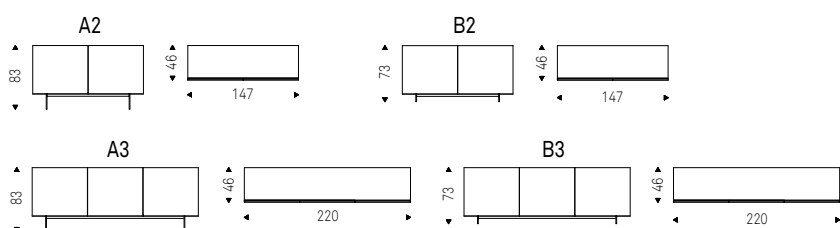



FOCUS CRYSTALART A3 sideboard with doors in decorative printed CY02 extra clear glass





FOCUS CRYSTALART B3 sideboard with doors in decorative printed CY01extra clear glass - EMERALD mirror in mirrored glass

Tudor

Paolo Cattelan | 2020

Madia contenitore in legno gofrato graphite, nero, Brushed Bronze o Brushed Grey, con ante in Brushed Bronze o Brushed Grey. Piedini in acciaio verniciato gofrato graphite o nero. Interno parzialmente specchiato e ripiani in cristallo fumé. Optional: kit luce interna a led.

Sideboard embossed lacquered graphite, black, Brushed Bronze or Brushed Grey wood, with doors in Brushed Bronze or Brushed Grey wood. Feet in graphite or black embossed lacquered steel. Partially mirrored inside and fumé glass shelves. Optional: internal led light kit.

Bahut en bois gaufré graphite, noir, Brushed Bronze ou Brushed Grey, avec portes en Brushed Bronze ou Brushed Grey. Pieds en acier laqué gaufré graphite ou noir. Interne partiellement miroité et étagères en verre fumé. Optionnel: kit lumière interne à led.

Aparador en madera gofrado graphite, negro, Brushed Bronze o Brushed Grey, con puertas en Brushed Bronze o Brushed Grey. Patas en acero barnizado gofrado graphite o negro. Interior parcialmente espejado y estantes en cristal fumé. Opcional: kit iluminación interior led.

Anrichte in Holz gaufriert graphit, schwarz, Brushed Bronze oder Brushed Grey, mit Türen in Brushed Bronze oder Brushed Grey. Füße aus Stahl lackiert graphit oder schwarz gaufriert. Ansatzweise verspiegeltes Innere und Böden aus Glas fumé. Optional: LED Kit für Innenbeleuchtung.

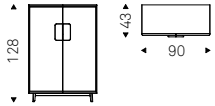



TUDOR sideboards in brushed bronze - CHENNAI rug





TUDOR sideboards in brushed grey - PANCHO coffee tables in brushed grey - PLANETA floor lamp

Boutique Alta

Alberto Danese | 2020

Madia con struttura e piedi in acciaio verniciato goffrato nero, ante e fianchi in cristallo fumè con fasce in cristallo verniciato nero. Top e fondo in cristallo verniciato nero acidato, schienale interno in ecopelle o pelle trapuntata come da campionario. Ripiani interni in cristallo fumè. Illuminazione a led inclusa.

Sideboard with frame and feet in black embossed lacquered steel, doors and sides in fumé glass with stripes in black painted glass. Top and bottom in black painted frosted glass, internal back covered and quilted in soft leather or synthetic leather as per sample card. Internal shelves in fumé glass. LED light.

Bahut avec structure et pieds en acier laqué gaufré noir, portes et côtés en verre fumé avec bandes en verre laqué noir. Plateau et fond en verre dépoli laqué noir, dos interne matelassé en simili cuir ou cuir mince selon échantillons. Étagères internes en verre fumé. Éclairage à led inclus.

Aparador con estructura y patas en acero barnizado gofrado negro, puertas y laterales en cristal fumè con bandas en cristal barnizado negro. Sobre y fondo en cristal barnizado negro. Sobre y fondo en cristal barnizado negro translúcido, respaldo interior en ecopiel o piel acolchada según muestrario. Estantes interiores en cristal fumè. Iluminación led incluida.

Anrichte mit Struktur und Füße in Stahl lackiert schwarz gaufriert, Türen und Seiten in Glas fumè mit Blende in Glas lackiert schwarz. Top und Boden in Glas lackiert schwarz geätzt. Innere Rückwand in Kunstleder oder Softleder gesteppt laut Musterkarte. Innenböden aus Glas fumè. LED-Beleuchtung enthalten.

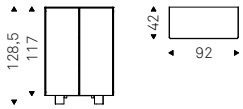



BOUTIQUE ALTA sideboard with internal back in soft leather 951 castoro - ETOILE consoles in brushed grey



BOUTIQUE ALTA sideboards with internal back in soft leather 951 castoro - BUTTERFLY table with brushed grey base and extra clear glass top



Atelier

Alberto Danese | 2020

Vetrina con struttura e piedi in acciaio verniciato gofrato nero, ante e fianchi in cristallo fumè con fasce in cristallo verniciato nero. Top e fondo in cristallo verniciato nero acidato, schienale interno in ecopelle o pelle trapuntata come da campionario. Ripiani interni in cristallo fumè. Illuminazione a led inclusa.

Showcase with frame and feet in black embossed lacquered steel, doors and sides in fumé glass with stripes in black painted glass. Top and bottom in black painted frosted glass, internal back covered and quilted in soft leather or synthetic leather as per sample card. Internal shelves in fumé glass. LED light.

Vitrine avec structure et pieds en acier laqué gaufré noir, portes et côtés en verre fumé avec bandes en verre laqué noir. Plateau et fond en verre dépoli laqué noir, dos interne matelassé en simili cuir ou cuir mince selon échantillons. Étagères internes en verre fumé. Éclairage à led inclus.

Aparador con estructura y patas en acero barnizado gofrado negro, puertas y laterales en cristal fumè con bandas en cristal barnizado negro. Sobre y fondo en cristal barnizado negro translúcido, respaldo interior en ecopiel o piel acolchada según muestrario. Estantes interiores en cristal fumè. Iluminación led incluida.

Anrichte mit Struktur und Füße in Stahl lackiert schwarz gaufriert, Türen und Seiten in Glas fumè mit Blende in Glas lackiert schwarz. Top und Boden in Glas lackiert schwarz geätzt. Innere Rückwand in Kunstleder oder Softleder gesteppt laut Musterkarte. Innenböden aus Glas fumè. LED-Beleuchtung enthalten.

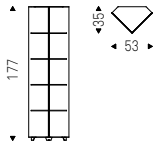



ATELIER showcase with internal back in soft leather 948 lino - BOMBÈ chair in soft leather 948 lino, graphite and matt black frame - MUMBAI rug

Arena

Yasuhiro Shito | 2020

Tavolino con base in acciaio verniciato gofrato nero e piano verniciato Brushed Bronze o Brushed Grey. Nelle versioni BOND e DOUBLE BOND il tavolino principale è affiancato da uno o due tavolini con base in acciaio verniciato gofrato nero, colonna in acciaio verniciato Brushed Bronze o Brushed Grey e piano girevole in cristallo bisellato fumé.

Coffee table with black embossed lacquered steel base and top in Brushed Bronze or Brushed Grey lacquered steel. In BOND and DOUBLE BOND versions, main coffee table is sided by one or two coffee tables with base in black embossed lacquered steel, column in Brushed Bronze or Brushed Grey lacquered steel and swivelling fumé beveled glass top.

Table basse avec base en acier gaufré noir et plateau laqué Brushed Bronze ou Brushed Grey. Dans les versions BOND et DOUBLE BOND la table basse principale s'accompagne d'une ou de deux table basses avec base en en acier lacqué gaufré noir, colonne en acier lacqué Brushed Bronze ou Brushed Grey et plateau pivotante en verre claire biseauté fumé.

Mesita con base en acero barnizado gofrado negro y sobre barnizado Brushed Bronze o Brushed Grey. En las versiones BOND y DOUBLE BOND la mesita principal se acompaña por una o dos mesitas con base en acero barnizado gofrado negro, pata en acero barnizado Brushed Bronze o Brushed Grey y sobre giratorio en cristal biselado fumé.

Couchtisch mit Basis aus Stahl lackiert schwarz gaufriert und Platte in Brushed Bronze oder Brushed Grey lackiert. In der Version BOND und DOUBLE BOND der Hauptcouchtisch wird neben einen oder zwei Couchtischen gestellt mit Gestell aus Stahl lackiert schwarz gaufriert, Säule aus Stahl lackiert Brushed Bronze oder Brushed Grey und Drehoberteil in fumé Glas mit faccettierten Kanten.

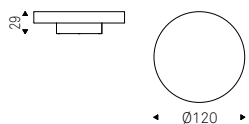

Arena Bond

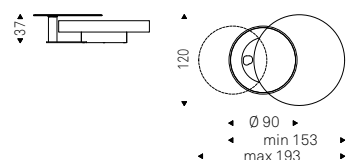

Arena Double Bond

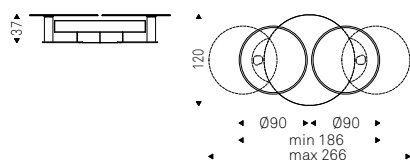



ARENA coffee table in brushed bronze - BOND coffee table with black base, brushed bronze leg and fumè glass top -
BILLY KERAMIK side tables with black base and zefiro ceramic top - HEAVEN lamps in titanium - MUMBAI rugs - LATITUDE bookcases in bronze



ARENA coffee table in brushed bronze - BOND coffee table with black base, brushed bronze leg and fumè glass top - BILLY KERAMIK side tables with black base and zefiro ceramic top - HEAVEN lamps in titanium - MUMBAI rugs



Spillo

Giorgio Cattelan | 2020

Tavolino con struttura in acciaio verniciato Brushed Brass, Brushed Bronze o Brushed Grey e particolari in ottone.

Coffee table with structure in Brushed Brass, Brushed Bronze or Brushed Grey lacquered steel and brass details.

Table basse avec structure en acier laqué Brushed Brass, Brushed Bronze ou Brushed Grey et détails en laiton.

Mesita con estructura en acero barnizado Brushed Brass, Brushed Bronze o Brushed Grey y detalles color latón.

Couchtisch mit Struktur aus Stahl lackiert Brushed Brass, Brushed Bronze oder Brushed Grey und Details in Messing.

tris

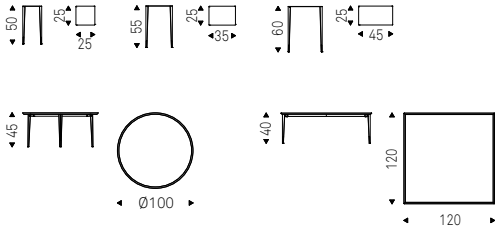

SPILLO coffee tables in brushed grey



SPILLO coffee tables in brushed grey



SPILLO coffee tables in brushed brass - CHENNAI rug - FREEWAY bookcase in titanium



SPIILLO side tables in brushed grey - MAREK rug

Pancho

Paolo Cattelan | 2020

Tavolino con struttura in acciaio Brushed Bronze o Brushed Grey.

Coffee table with Brushed Bronze or Brushed Grey steel structure.

Table basse avec structure en acier Brushed Bronze ou Brushed Grey.

Mesita con estructura en acero Brushed Bronze o Brushed Grey.

Couhtisch mit Basis aus Stahl in Brushed Bronze oder Brushed Grey.



PANCHO coffee tables in brushed grey and brushed bronze



PANCHO coffee tables in brushed grey - TUDOR sideboard in brushed grey



PANCHO coffee tables in brushed bronze - MAD MAX WOOD S table with brushed bronze base and Canaletto walnut top



PANCHO coffee tables in brushed grey

Sinai

Giorgio Cattelan | 2020

Tavolino con struttura in acciaio verniciato gofrato nero. Piano con bordo in massello di noce canaletto e interno in spatolato. La finitura materica in spessore è eseguita a spatola manualmente; ogni pezzo è unico.

Coffee table with structure in black embossed lacquered steel. Top spatulated with solid wood frame in Canaletto walnut. The textured effect is spatulated handmade. Each piece is unique.

Table basse avec structure en acier laqué gaufré noir. Plateau spatulé avec cadre en bois massif noyer Canaletto. La finition est spatulé à la main et chaque produit est unique.

Mesita con estructura en acero barnizado gofrado negro. Sobre de madera espatulada con canto exterior de madera maciza de Nogal Canaletto. El acabado superficial matérico es realizado con espátula a mano; cada pieza es única.

Couchtisch mit Struktur aus Stahl lackiert schwarz gaufriert. Gespachtelte Platte mit Rahmen aus Massivholz in Nussbaum Canaletto. Der strukturierte Effekt wird handgemacht; jedes Stück ist einzigartig.





SINAI coffee tables - MAPOON rugs - FREEWAY bookcase in bronze

Freeway

Giorgio Cattelan | 2020

Libreria componibile con fissaggio a muro o a soffitto. Montanti, reggipiani e ripiani in acciaio verniciato gofrato titanio o bronzo. Contenitori in legno verniciato gofrato titanio o bronzo e vetro fumé.

Modular wall- or ceiling-hanging bookcase. Brackets, pillars and shelves in titanium or bronze embossed lacquered steel. Containers in titanium or bronze embossed lacquered wood and fumé glass.

Bibliothèque à éléments avec fixation au mur ou au plafond. Montants, supports et étagères en acier laqué gaufré titane ou bronze. Conteneurs en bois laqué gaufré titane ou bronze et verre fumé.

Estantería componible con montaje a pared o a techo. Montantes, soportes y estantes en acero barnizado gofrado titanio o bronce. Contenedores en madera gofrado titanio o bronce y cristal fumé.

Modulares Bücherregal mit Wand-oder Deckenbefestigung. Gestell, Bügel und Füße aus Stahl lackiert titan oder bronze gaufriert. Container aus Holz lackiert titan oder bronze und fumé Glas.

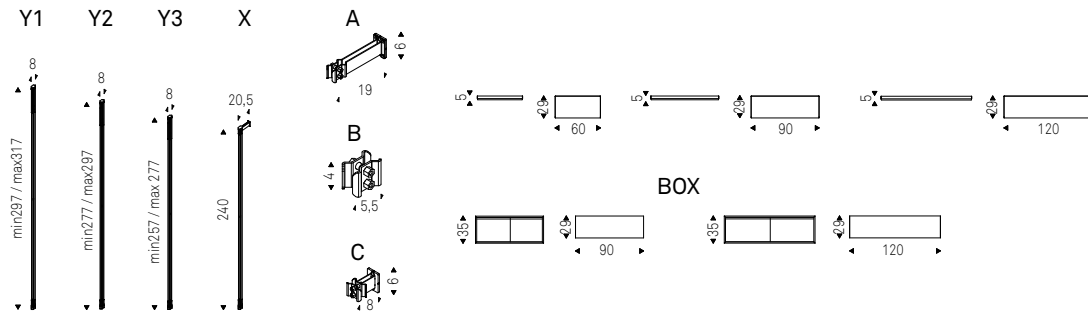



FREEWAY bookcase in bronze - PLANETA floor lamp - MAREK rug



FREEWAY bookcase in bronze - RADJA rug - AMERIGO coffee tables in brushed grey - STING BRUSHED side tables in brushed grey - PLANETA floor lamp





FREEWAY bookcase in titanium - CHENNAI rug - BENNY KERAMIK coffee tables with black base and zefiro ceramic top







FREEWAY bookcase in bronze - TERMINAL KERAMIK PREMIUM consolle with brushed bronze base, zefiro ceramic top and brushed bronze profile - HAWAII A mirror in bronze in bronze mirrored glass - MUMBAI rug

Latitude

Ono Design | 2020

Libreria in acciaio gofrato titanio o bronzo, componibile mediante affiancamento o sovrapposizione del singolo modulo. Fissaggio a parete necessario se non provvisto di zavorra optional.

Bookcase in titanium or bronze embossed lacquered steel, each unit can be set up side by side or stackable. Wall anchorage is necessary if the optional ballast is not fixed.

Bibliothèque en acier gaufré titane ou bronze, modulable avec juxtaposition ou superposition de chaque unité. Fixation au mur obligatoire s'elle n'est pas équipée de ballast optionnel.

Estantería modular en acero barnizado gofrado titanio o bronzo. Se puede componer por solapamiento del módulo individual o poniendo uno al lado del otro. Ajuste a pared necesario sin lastre opcional.

Anbaubuchregal aus Edelstahl lackiert titan oder bronze gaufriert, beidseitig oder überlappend zusammenstellbar. Die Wandbefestigung ist notwendig, wenn kein optionaler Ballast vorhanden ist.

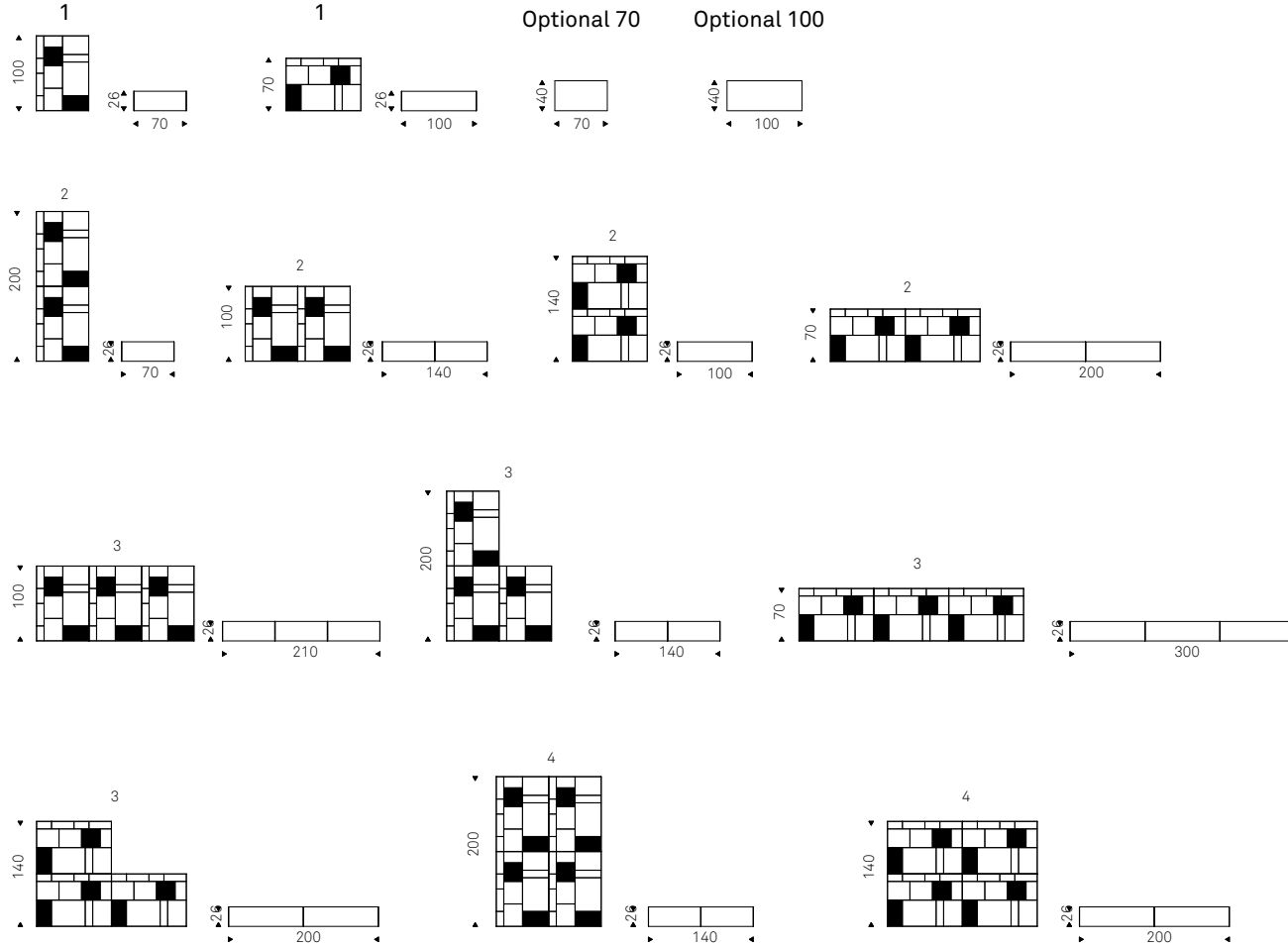



LATITUDE bookcases in titanium



LATITUDE bookcases in titanium - RADJA rug



Spinnaker

Tosca Design | 2020

Libreria con fissaggio a muro o a soffitto. Struttura in acciaio verniciato gofrato nero, ripiani in noce Canaletto e particolari in acciaio verniciato gofrato titanio o struttura in acciaio verniciato gofrato titanio, ripiani in olmo laccato poro aperto nero opaco e particolari in acciaio verniciato gofrato nero.

Wall- or ceiling-hanging bookcase. Structure in black embossed lacquered steel, shelves in Noce Canaletto and details in titanium embossed lacquered steel or structure in titanium embossed lacquered steel or structure in Elm open pore black and details in black embossed lacquered steel.

Bibliothèque à éléments avec fixation au mur ou au plafond. Structure en acier laqué gaufré noir, étagères en noyer Canaletto et détails en acier laqué gaufré titane ou structure en acier laqué gaufré titane, étagères en Orme laqué noir opaque pore ouvert et détails en acier laqué gaufré noir.

Estantería con montaje a pared o a techo. Estructura en acero barnizado gofrado negro, estantes en Nogal Canaletto y detalles en acero barnizado gofrado titanio o estructura en acero barnizado gofrado titanio, estantes en olmo barnizado negro mate a poro abierto y detalles en acero barnizado gofrado negro.

Bücherregal mit Wand-oder Deckebefestigung. Struktur aus Stahl lackiert schwarz gaufriert, Böden in Nussbaum Canaletto und Details in Stahl lackiert titan gaufriert oder Struktur aus Stahl lackiert titan gaufriert, Böden in Ulme offenporig lackiert matt schwarz und Details in Stahl lackiert schwarz gaufriert.

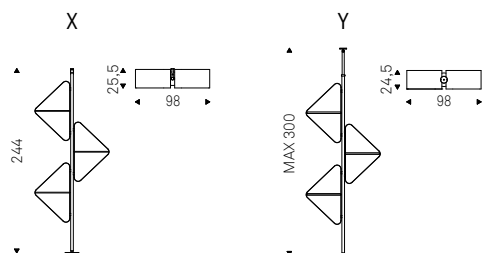

SPINNAKER bookcase with black frame and Canaletto walnut shelves

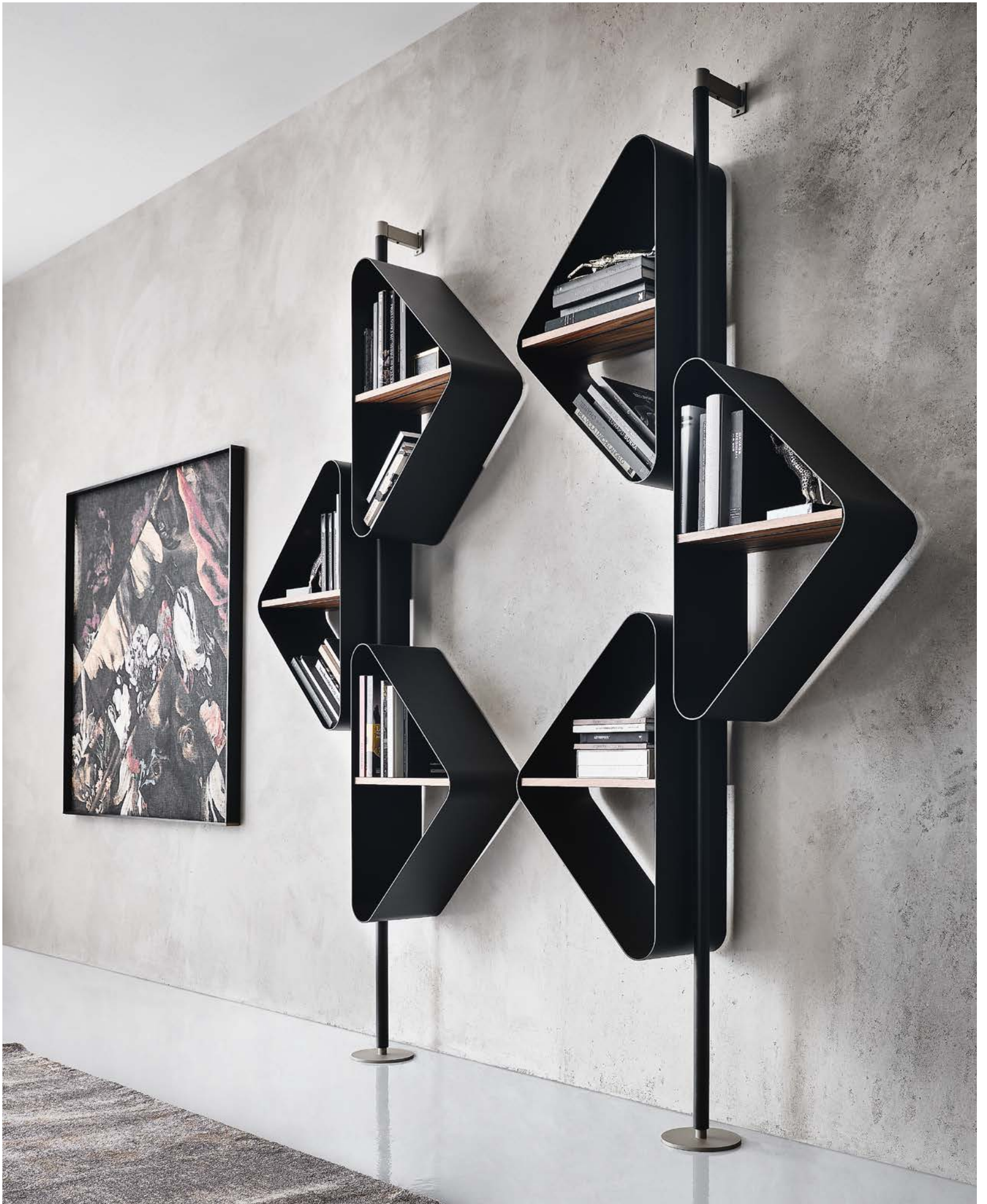

SPINNAKER bookcases with black frame and Canaletto walnut shelves



SPINNAKER bookcases with titanium frame and matt black elm shelves - BILLY KERAMIK coffee tables with titanium base and zefiro ceramic top - STING BRUSHED side tables in brushed grey - YAGO side table in brushed grey - PLANETA floor lamp



Trap

Studio Kronos | 2020

Libreria in acciaio verniciato
gofrato titanio o bronzo.

Bookcase in titanium or
bronze embossed lacquered
steel.

Bibliothèque en acier gaufré
titane ou bronze.

Estantería en acero barnizado
gofrado titanio o bronzo.

Bücherregal aus Edelstahl
lackiert titan oder bronze
gaufriert.

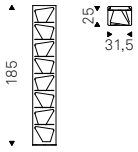

TRAP bookcase in bronze



TRAP bookcases in titanium - STING side tables with titanium base and arenal ceramic top

Ayrton

Andrea Lucatello | 2020

Letto con struttura in acciaio verniciato goffrato titanio o bronzo. Testiera interamente rivestita in tessuto, synthetic nubuck, micro nubuck, ecopelle o pelle nei colori come da campionario. Rete inclusa.

Bed with frame in titanium or bronze embossed lacquered steel. Headboard completely covered in fabric, synthetic nubuck, micro nubuck, synthetic leather or soft leather as per sample card. Slats included.

Lit avec structure en acier gaufré titane ou bronze. Tête de lit complètement revêtue en tissu, synthetic nubuck, micro nubuck, simili-cuir ou cuir mince selon échantillons. Sommier compris.

Cama con estructura en acero barnizado gofrado titanio o bronzo. Cabecera completamente tapizada en tejido, synthetic nubuck, micro nubuck, ecopiel o piel según muestrario. Somier incluido.

Bett mit Gestell in Stahl lackiert titan oder bronze gaufriert. Kopfteil komplett bezogen in Stoff, synthetic nubuck, micro nubuck, Kunstleder oder Softleder laut Musterkarte. Lattenrost inklusive.

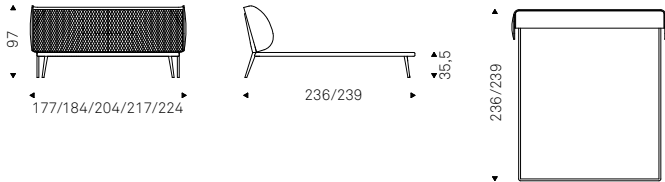



AYRTON bed in soft leather 951 castoro and bronze structure





AYRTON bed in soft leather 951 castoro and bronze structure - CIRO nightstands with burned oak structure and soft leather 951 castoro inserts - PLANETA table lamp - KATANA lamp in titanium - ZULEIKA chair in leather 51 castoro - MAREK rug - GLENN mirror in bronze mirrored glass

Marek

STC Studio | 2020

Tappeto tessuto in lana di base con disegno in rilievo in viscosa.

Rug made in wool with viscose relief design.

Tapis en tissu de laine avec dessin en relief en viscose.

Alfombra de lana con diseños en relieve de viscosa.

Teppich aus Wolle mit Relief in Viskose.

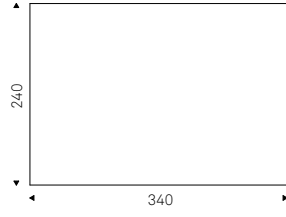
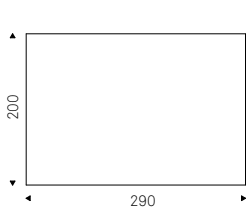



Heaven

Studio Kronos | 2020

Lampada da soffitto con struttura in acciaio verniciato gofrato titanio. Illuminazione a led. Opzionale telecomando e dimmer.

Ceiling lamp in titanium embossed lacquered steel frame. Led lights. Optional: remote control and dimmer.

Lampadaire avec structure en acier gaufré titane. Éclairage à led. Optionnel: télécommande et variateur de lumière (dimmer).

Lámpara de techo con estructura en acero barnizado gofrado titanio. Iluminación led. Opcional: mando a distancia y regulador de luz.

Hängelampe mit Metallgestell lackiert titan gaufriert. LED Beleuchtung. Optional: Fernbedienung und Dimmer.

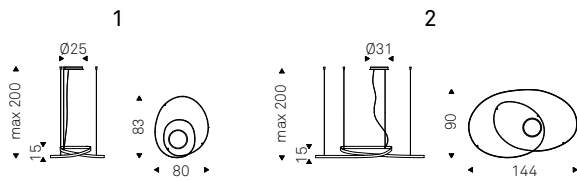



HEAVEN 1 lamps in titanium



HEAVEN 1 lamp in titanium - YODA KERAMIK table with satin titanium base and matt portoro ceramic top - WILMA chairs in soft leather 952 smoke - CHENNAI rug - CHELSEA sideboard in titanium



HEAVEN 2 lamp in titanium

Katana

Studio Kronos | 2020

Lampada da soffitto con struttura in acciaio verniciato gofrato titanio. Illuminazione a led. Opzionale telecomando e dimmer.

Ceiling lamp in titanium embossed lacquered steel frame. Led lights. Optional: remote control and dimmer.

Lampadaire avec structure en acier gaufré titane. Éclairage à led. Optionnel: télécommande et variateur de lumière (dimmer).

Lámpara de techo con estructura en acero barnizado gofrado titanio. Iluminación led. Opcional: mando a distancia y regulador de luz.

Hängelampe mit Metallgestell lackiert titan gaufriert. LED Beleuchtung. Optional: Fernbedienung und Dimmer.

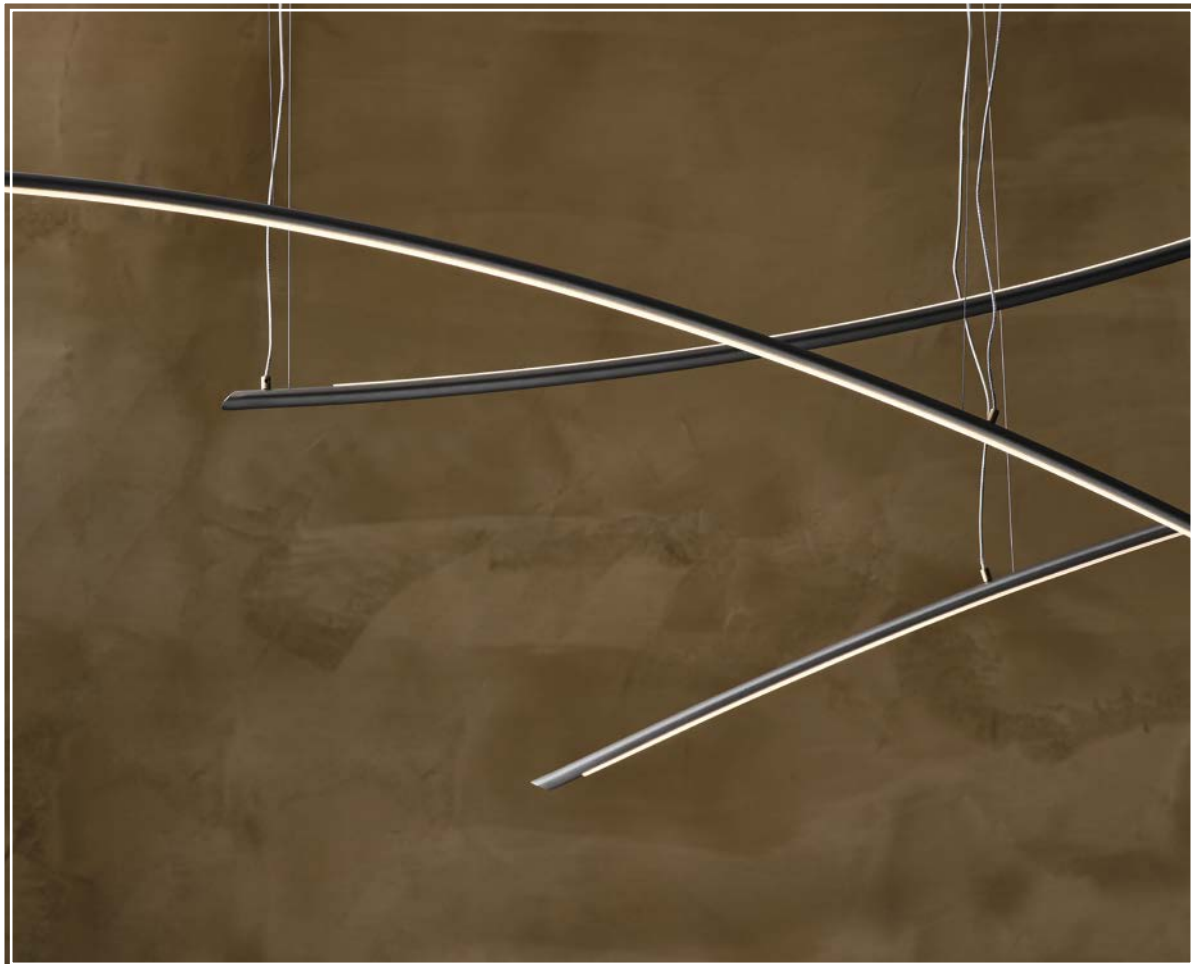
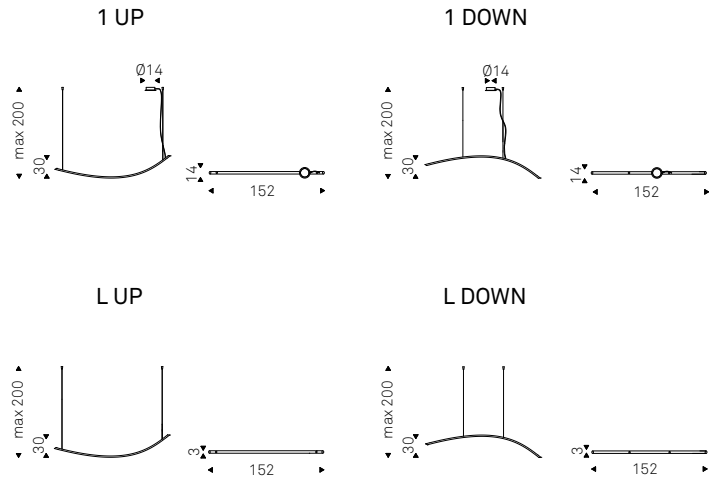



KATANA lamps in titanium - TYRON KERAMIK PREMIUM table with black base, arenal ceramic top and brushed grey profile -
BOMBÈ chairs in soft leather 948 lino, graphite and burned oak frame - MUMBAI rugs

Magellano

Studio Kronos | 2020

Lampada da soffitto con struttura in acciaio verniciato gofrato titanio. Illuminazione a led. Opzionale telecomando e dimmer.

Ceiling lamp in titanium embossed lacquered steel frame. Led lights. Optional: remote control and dimmer.

Lampadaire avec structure en acier gaufré titane. Éclairage à led. Optionnel: télécommande et variateur de lumière (dimmer).

Lámpara de techo con estructura en acero barnizado gofrado titanio. Iluminación led. Opcional: mando a distancia y regulador de luz.

Hängelampe mit Metallgestell lackiert titan gaufriert. LED Beleuchtung. Optional: Fernbedienung und Dimmer.

Shaped

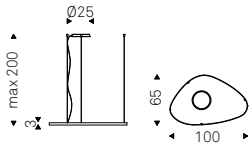

L Shaped

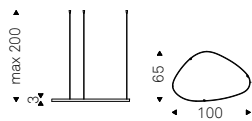

Socket 2/3

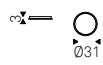



MAGELLANO Shaped lamps in titanium



MAGELLANO Shaped lamps in titanium - TYRON WOOD table with titanium base and Canaletto walnut Masterwood top - CHENNAI rugs

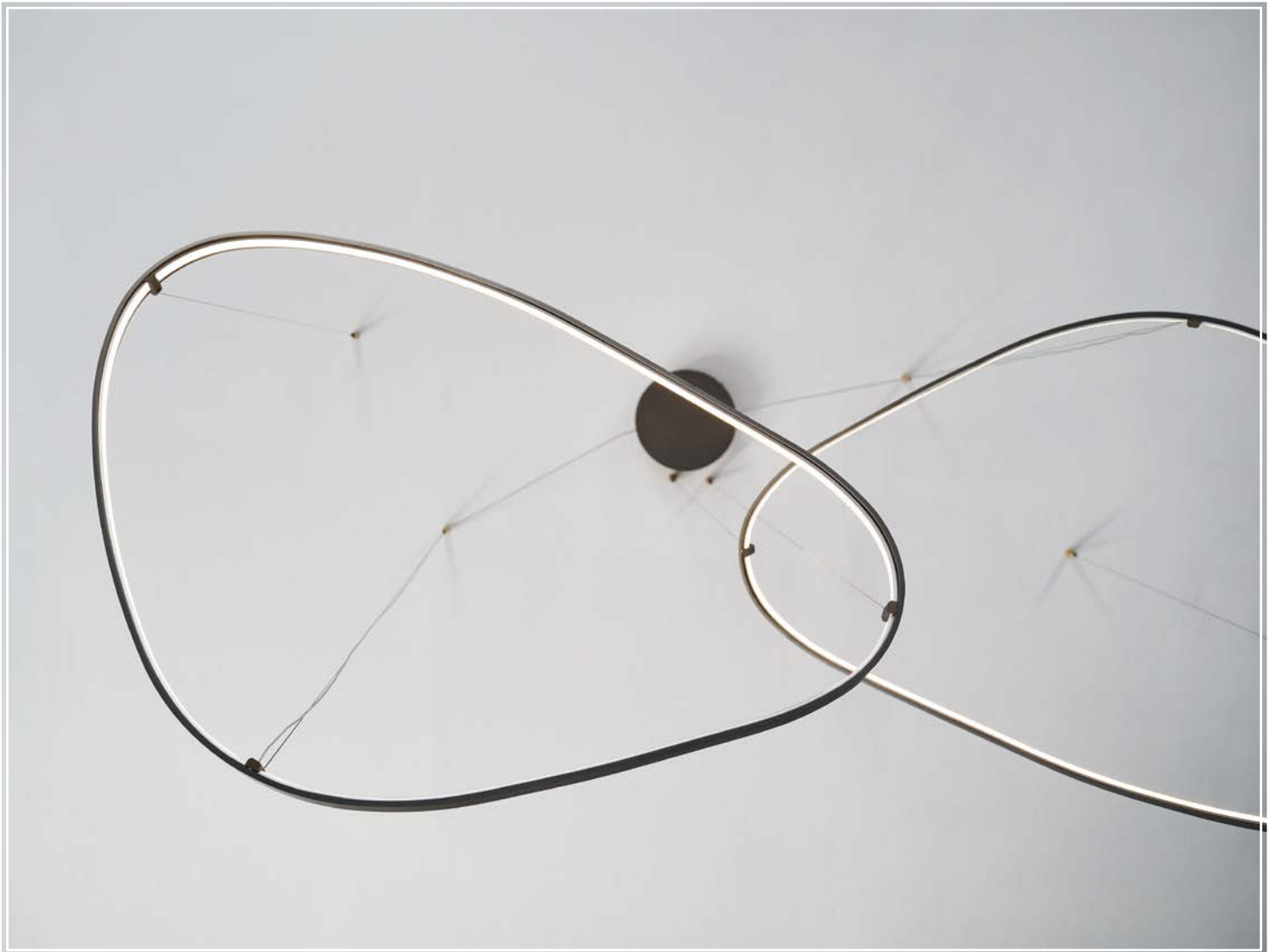

MAGELLANO Shaped lamps in titanium

Zanziball

STC Studio | 2020

Lampada a soffitto con paralume in vetro soffiato e dettagli in ottone spazzolato. Attacco a soffitto in acciaio cromo nero. Lampada a led inclusa.

Ceiling lamp with lampshade in artistic blown glass and brushed brass details. Black chrome steel ceiling plate. Led light.

Lampadaire avec abat-jour en verre borosilicate et détails en brushed brass. Fixation au plafond en acier chromé noir. Led compris.

Lámpara de techo con pantalla en vidrio soplado y detalle en latón espatulado. Soporte de techo en acero cromo negro. Bombilla led incluida.

Hängelampe mit Lampenschirm in Blasenglas und Details in Brushed Brass. Deckenbefestigung aus schwarz verchromtem Stahl. LED Beleuchtung enthalten.

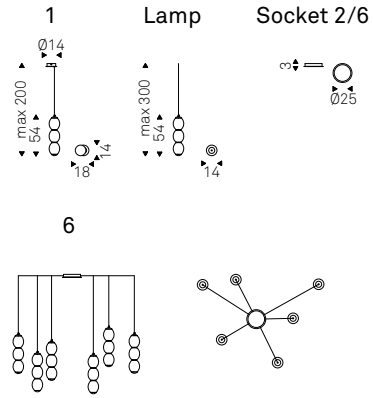



cattelanitalia.com



Photo

Emanuele Tortora

Styling

Barbara Milani

Project

StudioGrafico
Cattelan Italia

Print

Why Blue

Thanks To:

Arketipo
London Art

Cattelan Italia spa si riserva di apportare, senza preavviso, modifiche nei materiali, nei rivestimenti, nelle finiture e nei disegni dei prodotti presentati in questo catalogo. Le texture ed i colori dei materiali e delle finiture hanno valore indicativo in quanto soggetti alle tolleranze dei processi di stampa.

Cattelan Italia spa reserves the right to change, without previous notice, materials, covers, finishes and drawings of the products presented in this catalogue. The textures and colours of materials and finishes are indicative as they are depending on the tolerances of the printing process.

Cattelan Italia spa se réserve le droit d'apporter, sans préavis, des modifications au niveau des matériaux, des revêtements, des finitions et du design des produits présentés dans ce catalogue. Les textures et les couleurs des matériaux et des finitions sont une valeur indicative parce-que ils changent selon la tolérance aux procédés d'imprimerie.

Cattelan Italia spa behält sich vor, ohne Vorankündigung, Veränderungen an den Materialien, Bezügen, Ausführungen und Zeichnungen der in diesem Katalog vorgestellten Produkte vorzunehmen. Die Texturen und Farben der Materialien und Finish haben einen hinweisenden Wert, da sie von den Toleranzen im Druckprozess abhängig sind.

Cattelan Italia spa se reserva el derecho de aportar modificaciones de dibujo, materiales, acabados y tapicerías, sin que esté obligada a dar aviso anticipado. Las texturas y los colores de los materiales y de los acabados tienen solo un valor indicativo porque están sujetos a la tolerancia en los procesos de imprenta.

10

COLLECTION

cattelan
italia

CATTELANITALIA.COM



CATTELAN ITALIA SPA - via pilastri 19 - 36010 Carrè / Vicenza - Italy
phone +39 0445 318711 - fax +39 0445 314289 - email: info@cattelanitalia.com