



KITCHEN ACCESSORIES

KITCHEN BINS



PULLOUT UNDERSINK WASTE BIN SYSTEM

Orion Dark Grey

Code	Description
RCOMP488	<ul style="list-style-type: none"> • 15 Litre • Full extension runners with soft-close system • Total load capacity: 30 kg • Three-dimensional adjustment of the door • Upper shelf in painted steel included • Installation width: 800mm unit • Installation depth: 485mm • Installation height: 316mm

COMPAGNUCCI
HIGH TECH



45 LITRE TILT BIN

Code	Description
R6245	<ul style="list-style-type: none"> • Black • 540 X 380 X 315 • Including 45l Tilt Bin Lid: H = 615
R6244	<ul style="list-style-type: none"> • Steel Bin Bracket 45lt (Black)
R6246	<ul style="list-style-type: none"> • 45 Litre Tilt Bin Lid
RTS220	<ul style="list-style-type: none"> • Flap Door Slide • Suitable for Installation in a 450mm Unit with A bottom hinged door.

32 LITRE TILT BIN

Code	Description
R6243	<ul style="list-style-type: none"> • Black • 530 X 340 X 290
R6242	<ul style="list-style-type: none"> • Steel Bin Bracket 32Lt (Black)
R6243	<ul style="list-style-type: none"> • Tilt Bin 32Lt black Addis
R6247	<ul style="list-style-type: none"> • 32 Litre Tilt Bin Lid
RTS220	<ul style="list-style-type: none"> • Flap Door Slide • Suitable For Installation In A 400mm Unit with A Bottom hinged door.



GRADE 430

Stainless Steel Door Bin 20 Litre

Code	Description
R6200	<ul style="list-style-type: none"> • Grade 430 Stainless Steel • Suitable for installation in a 500mm unit with a hinged door. • Left or right assembly. • The lid is opened by means of an automatic mechanism. • The plastic materials are shock-resistant and durable. • An assembly template is provided with each unit.

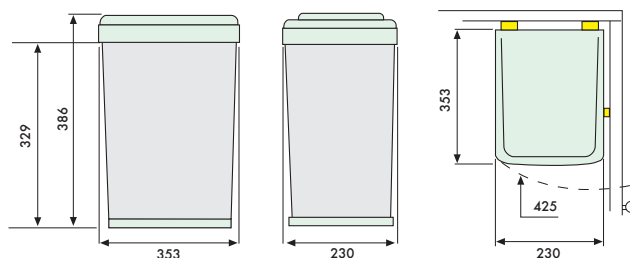

G
GOLLNUCCI

KITCHEN BINS



DOOR BIN STAINLESS STEEL

15 Litre

Code	Description
------	-------------

- | | |
|-------|---|
| R6274 | <ul style="list-style-type: none"> • Suitable for installation in a 400mm unit with a hinged door. • Left or right assembly. • The lid is opened by means of an automatic mechanism. • The plastic materials are shock-resistant and durable. • An assembly template is provided with each unit. |
|-------|---|

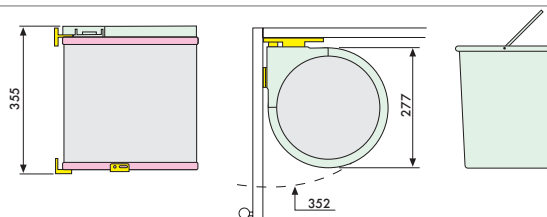

DOOR BIN PLASTIC

15 Litre

Code	Description
------	-------------

- | | |
|---------------------------|--|
| R6270MGS
Metallic Grey | <ul style="list-style-type: none"> • Suitable for installation in a 400mm unit with a hinged door. • Left or right assembly. The lid is opened by means of an automatic mechanism. • The plastic materials are shock-resistant and durable. • An assembly template is provided with each unit. |
| R6270WS
White | |

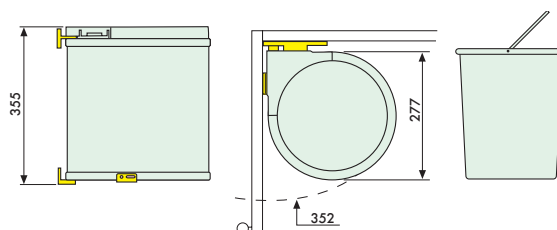

PULLOUT BIN WHITE

15 LITRE

Code	Description
------	-------------

- | | |
|-------|--|
| R6280 | <ul style="list-style-type: none"> • Suitable for installation in a 300mm unit with a hinged door. • The bin is pulled out manually and slides out on a robust slide mechanism. • The lid is raised automatically by means of a vertical stick. • The plastic materials are shock-resistant and durable. |
|-------|--|

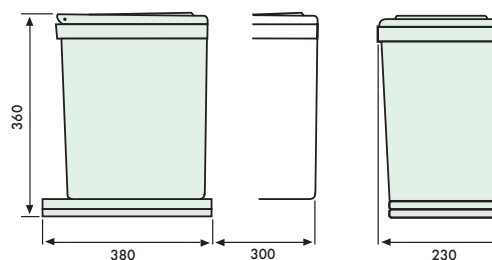

PULLOUT SOFT CLOSING RECYCLING BINS



ORION PULLOUT BIN 300MM EVOLINE	
Code	Description
R6580EVN430A	300 unit - 40 Litre

D. 502
H. 529*



TOT 40 L



10 min



300 mm



ORION PULLOUT BIN 400MM EVOLINE	
Code	Description
R6580EVN440C	400 unit - 58 Litre

D. 502
H. 485*



TOT 58 L



10 min



400 mm



ORION PULLOUT BIN 450MM EVOLINE	
Code	Description
R6580EVN445C	450 unit - 58 Litre

D. 502
H. 485*



TOT 58 L



10 min



450 mm



ORION PULLOUT BIN 500MM EVOLINE	
Code	Description
R6580EVN450C	500 unit - 80 Litre

D. 502
H. 529



TOT 80 L



10 min



500 mm



ORION PULLOUT BIN 600MM EVOLINE	
Code	Description
R6580EVN460C	600 unit - 80 Litre

D. 502
H. 529



TOT 80 L



10 min



600 mm



KICKPLATE & ACCESSORIES



90° CORNER FOR ALUMINIUM KICK PLATE

Code	Size
AADPC100	100mm
AADPC	150mm

FLEXIBLE CORNER FOR ALUMINIUM KICK PLATE

AADPFC100	100mm
AADPFC	150mm



ALUMINIUM KICK PLATE 4.0m Length

Code	Size
AALKPL	150mm
AALKPL100	100mm



ALUMINIUM KICK PLATE 4.0m Length Black

Code	Size
AALKPL100BLK	100mm
AALKPLBLK	150mm

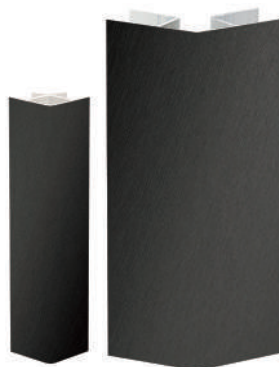

FLEXIBLE CORNER FOR KICK PLATE Black

Code	Size
AADPFC100BLK	100mm
AADPFCBLK	150mm

KITCHEN ACCESSORIES



WHITE SPICE TRAYS

Vacuum Formed High Gloss ABS

Code	Description
RSPICE400L	310 x 476 (Trimnable) - 400mm unit
RSPICE450L	357 x 465 - 450mm unit on 500mm runner
RSPICE500	408 x 465 - 500mm unit
RSPICE600	511 x 465 - 600mm unit



WHITE CUTLERY TRAYS

Vacuum Formed High Gloss ABS

Code	Description
RCUT400L	310 x 476 - 400mm unit - FLAT
RCUT450L	357 x 465 - 450mm unit
RCUT450M	380 x 480 - 450mm unit metabox
RCUT450S	357 x 415 - 450mm unit
RCUT500	408 x 465 - 500mm unit
RCUT600	511 x 465 - 600mm unit



METALLIC GREY CUTLERY TRAYS (Trimnable)

Code	Description
RCUT739	400mm unit
RCUT740	450mm unit
RCUT743	500mm unit
RCUT741	600mm unit
RCUT742	900mm unit



RCUT739

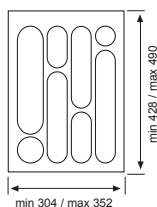

RCUT740

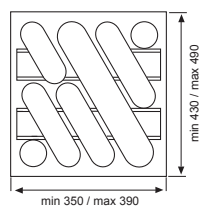

RCUT743

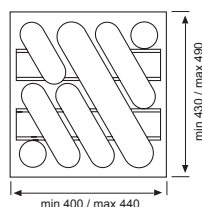

RCUT741

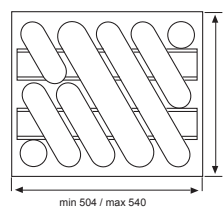

RCUT742

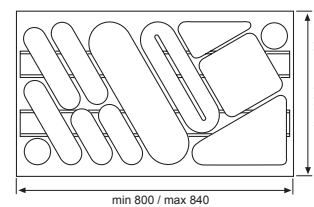

KITCHEN ACCESSORIES



900mm Application with 2 X 450mm Tetrax Cutlery Tray

TETRAX CUTLERY TRAY SILVER TRIMMABLE

Code	Description
RCUTS26280SILV	300/350mm Drawer
RCUTS26400SILV	400/450mm Drawer
RCUTS26500SILV	500/550mm Drawer
RCUTS26600SILV	600mm Drawer



CROCKERY RACK

Code	Description
RC300	White epoxy coated Suitable for installation in 300mm unit Pot Drawer 350mm Unit

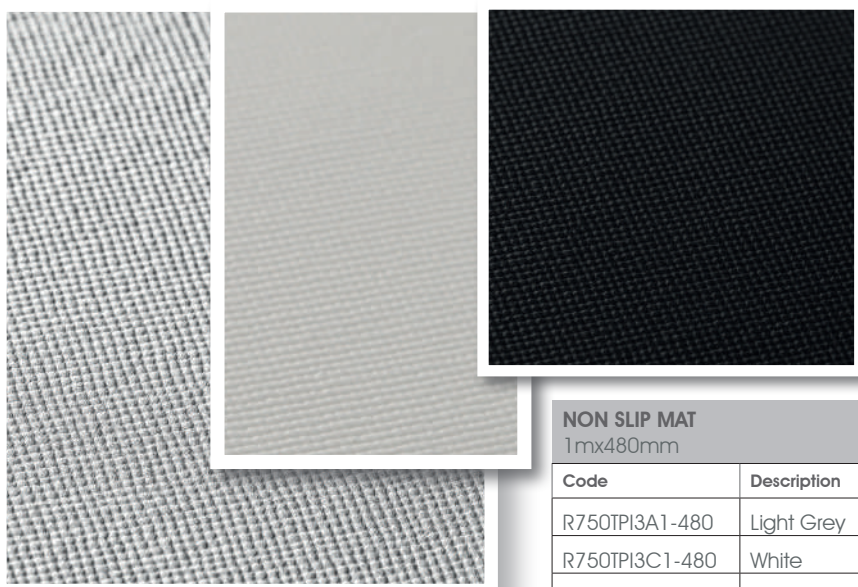
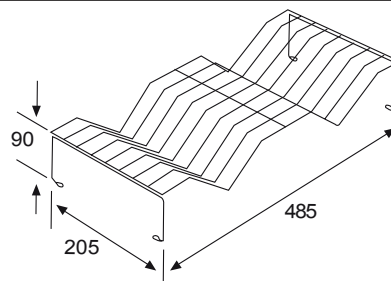

NON SLIP MAT 1mx480mm

Code	Description
R750TPI3A1-480	Light Grey
R750TPI3C1-480	White
R750TPI3F1-480	Dark Grey



unionPLAST
SINCE 1976

KITCHEN ACCESSORIES



WINE GLASS HOLDER - 1 LAYER
Chrome

RPSH1CH	3 Glasses - 107 x 290 x 35
---------	----------------------------



WINE GLASS HOLDER - 4 LAYER
Chrome

RPSH20CH	12 Glasses - 318 x 290 x 35
----------	-----------------------------

Matt Black

RPSH20MB	12 Glasses - 318 x 290 x 35
----------	-----------------------------



WINE GLASS HOLDER - 2 LAYER
Chrome

RPSH2CH	6 Glasses - 202 x 290 x 35
---------	----------------------------

Matt Black

RPSH2MB	6 Glasses - 202 x 290 x 35
---------	----------------------------



SPICE RACK - PLASTIC
530 x 385

RSPICE3	3 Tier
---------	--------



SPICE RACK CHROME
405 x 382

RSPICE2CH	2 Tier
-----------	--------



SPICE RACK CHROME
405 x 355

RSPICE3CH	3 Tier
-----------	--------

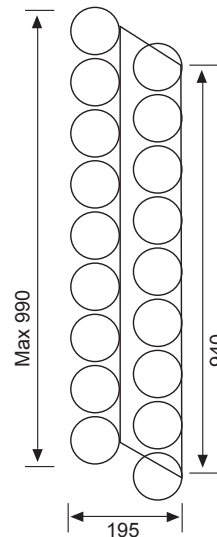
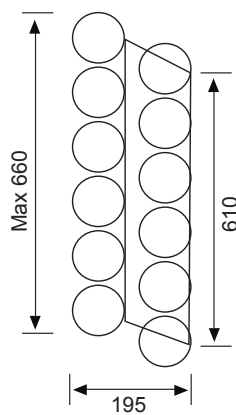
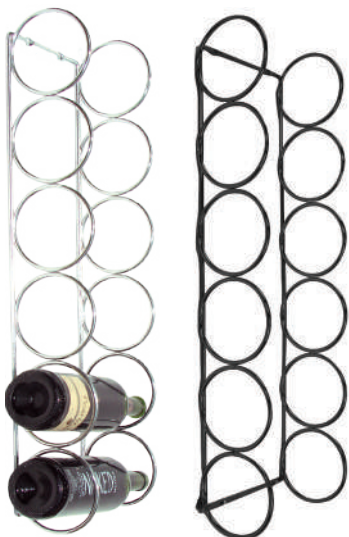

WINE BOTTLE HOLDER
Chrome

RWBH5	5 Ring
RWBH6	6 Ring
RWBH9	9 Ring
Matt Black	
RWBH6MB	6 Ring
RWBH9MB	9 Ring

KITCHEN ACCESSORIES

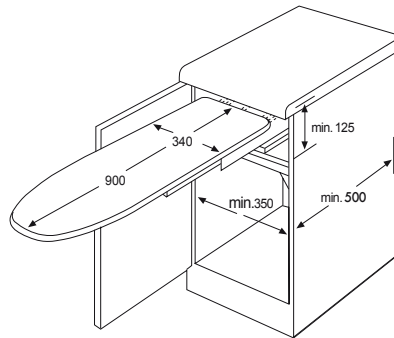
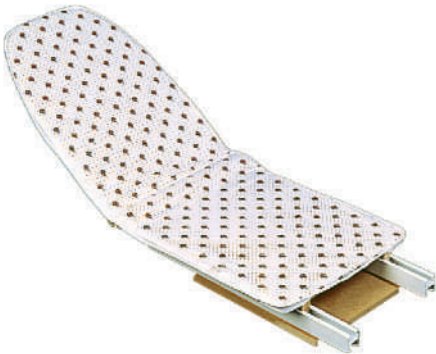

PULLOUT FOLDING IRONING BOARD

RR490	Suitable for installation in 400mm unit Supplied with 100% cotton removable cover
-------	--

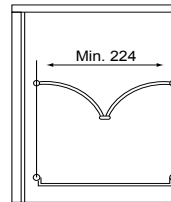
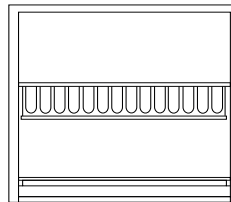

STAINLESS STEEL DISH DRYING RACK

Code	Description
RFG565831005600	For 600mm unit
RFG565831008600	For 900mm unit

DISH RACK

Load capacity	16.8Kg - 600mm unit
	25.2Kg - 900mm unit

GLASS RACK

Load capacity	12Kg - 600mm unit
	18Kg - 900mm unit

DRIP TRAY



Please note: Dish Rack, Glass Rack and Drip Tray are not sold separately



¾ CAROUSEL CHROME

RWCT720CH	<ul style="list-style-type: none"> • Ø 700 • Suitable for installation in 800mm or 900mm corner unit. • Load capacity: 20Kg
-----------	--

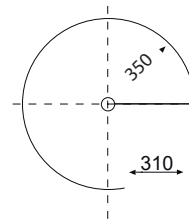

¾ CAROUSEL PLASTIC

RWCT720	<ul style="list-style-type: none"> • Ø 700 - White • Suitable for installation in 800mm or 900mm corner unit. • Load capacity: 20Kg
---------	--

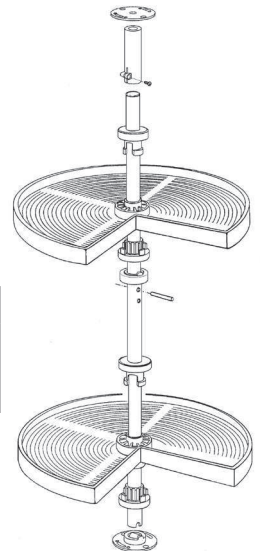
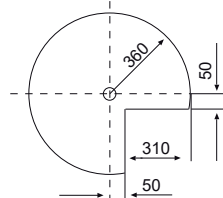

KITCHEN ACCESSORIES



WHITE EPOXY COATED VEG BASKET			
RVB300	300 Unit	500 x 218 x 100	<ul style="list-style-type: none"> All veg baskets 100mm deep All baskets include 500mm runners except VB450S which includes 450mm runners Allow 25mm for runner thickness plus 25mm for spacer block Order spacers separately RVBS required for white baskets
RVB400	400 Unit	500 x 318 x 100	
RVB450	450 Unit	500 x 368 x 100	
RVB450S	450 Unit	450 x 368 x 100	
RVB500	500 Unit	500 x 418 x 100	
RVB600	600 Unit	500 x 518 x 100	



SYNTHETIC WICKER BASKETS	
RVBWS400	400 Unit Natural
RVBWS400M	400 Unit Mahogany
RVBWS400WH	400 Unit White
RVBWS450	450 Unit Natural
RVBWS450M	450 Unit Mahogany
RVBWS450WH	450 Unit White
RVBWS500	500 Unit Natural
RVBWS500M	500 Unit Mahogany
RVBWS500WH	500 Unit White
RVBWS600	600 Unit Natural
RVBWS600WH	600 Unit White
RVBWS600M	600 Unit Mahogany

- The wicker baskets are: a uniform colour and have a smooth finish, easy to clean and made of a fully recyclable plastic, polyprop and polyethylene which is a more environmentally friendly plastic than PVC.
- The colour of the basket will not fade over time.
- All Wicker Baskets are 500mm deep x 185mm high, and exclude runners.
- Sizes can vary due to material used.
- Special sizes may be ordered.

The Design Of These Baskets May Vary.



GRACE VEG BASKET - CHROME			
Full Extention			
RVB400GRCH	400 Unit	430 x 368 x 140	<ul style="list-style-type: none"> Chrome baskets include full extension ball bearing runners All chrome baskets 140mm deep.
RVB450GRCH	450 Unit	430 x 418 x 140	
RVB500GRCH	500 Unit	430 x 468 x 140	
RVB600GRCH	600 Unit	430 x 568 x 140	



ECONOMY STAINLESS STEEL	
Worktop Bin Lid	
RWTBSS	Outside Diameter - 270mm



PLASTIC WORKTOP	
Inset Bin Lid - Diameter - 240mm	
RWTBCHL	Charcoal/ Black
RWTBGRE	Grey
RWTBOAK	Oak
RWTBWH	White

BROOM CLIP	
Steel	
RADBROOMCLIPCH	Black and Chrome



BROOM CLIP	
Plastic	
RADBROOMCLIPBL	Black



KITCHEN ACCESSORIES



ALUMINO ALUMINUM DOOR SYSTEM

- The Alumino Aluminum Door System is a simple, effective method of constructing an aluminium framed glass door.
- The hinge and corner connecting joints are fixed to the aluminium frame by means of a fastening screw.
- The rear of the door is covered by an ABS cover strip to create an aesthetically pleasing finish.

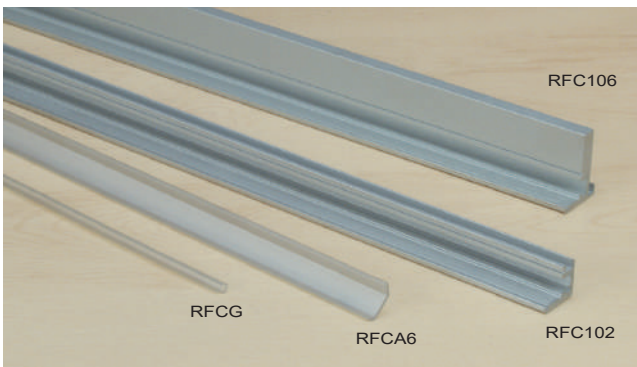

ANODISED ALUMINIUM Door Profile	
RFC106	3 metre lengths

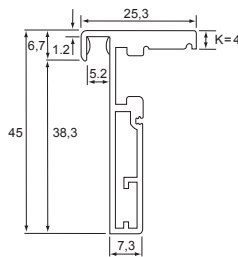

ANODISED ALUMINIUM Door Profile	
RFC102	3 metre lengths

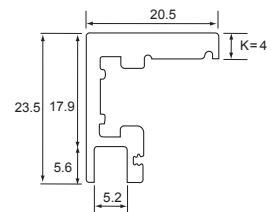

COVER STRIP Neutral Colour	
RFC A6	3 metre lengths



GLASS GASKET Neutral colour	
RFCG	<ul style="list-style-type: none"> • 3 metre lengths • Suitable for 4mm glass



105° SLIDE-ON STRAIGHT HINGE	
R51MS310500000	<ul style="list-style-type: none"> • For Alumino Door. • Order Mounting Plate separately.
$H = (14 + A + K) - S$ H = height of Base Plate K = 4 (see aluminium profile)	



CORNER CONNECTOR	
RFC A4	<ul style="list-style-type: none"> • 4 Connectors required per door • 4 Fastening screws • Minimum starting point for hinge is 78mm from middle line of corner connector.



GAS LIFT 270MM 200N	
RTEC9042	<ul style="list-style-type: none"> • Load Capacity 4.5kg N110 • Extended length 243mm • Includes 2 Snap-on ball fittings for solid and MDF doors

RTEC9042

ROLLER SHUTTER PROFILES & ACCESSORIES

60MM ROLLER SHUTTER SLATS
3 Metre Lengths

RRE770145BLK	Black
RRE770145WH	White
RRE770716AL	Aluminium
RRE770716CHAR	Charcoal
RRE770716ICEWH	Ice-White

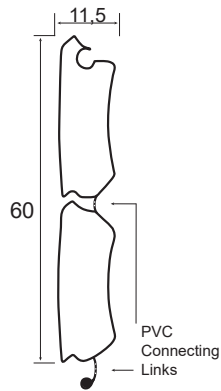
ROLLER SHUTTER 90° CORNER CONNECTOR

RRE264089BLK	Black
RRE264089GRE	Grey
RRE264089CHAR	Charcoal
RRE264089ICEWH	Ice-White

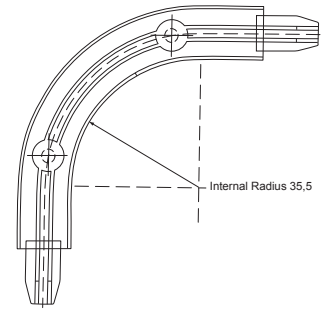
ROLLER SHUTTER FINGER GRIP

RRE249791AL	Aluminium
RRE249791BLK	Black
RRE249791ICEWH	Ice-White

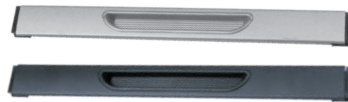
ROLLER SHUTTER TRACK

3 Metre Length

RRE770124CHAR	Charcoal
RRE770124ICEWH	Ice-White
RRE770124BLK	Black
RRE770124GRE	Grey

Track Groove - Width 17mm and Depth 12,5mm

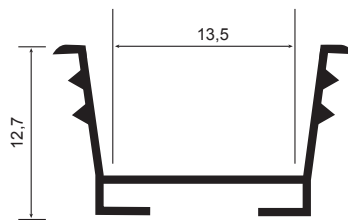

COVER HANDLE

3 Metre Length

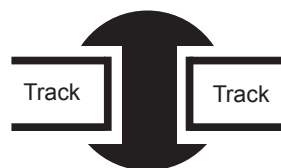
RRE770255	Aluminium
RRE770245	Black
RRE770256	Charcoal
RRE770257	White
RRE770258	Ice-White

CENTRE STOP

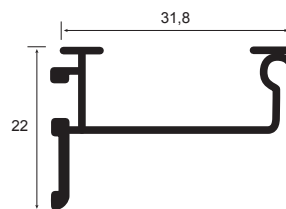
RRE779720

ALUMINIUM HANDLE GRIP SECTION

RRE225247 3 metre lengths

HANDLE GRIP

RRE242902 Section Glide

SURFACE MOUNTED TRACK KIT



Pair of spiral tracks



Extension tracks



Center stopper

No fixing screws supplied.

SURFACE MOUNTED TRACK KIT

RRE299B70999	Surface Mount Spiral Track Kit 12mm	APPLICATION This track set can be used for a cupboard opening horizontally as single door (left/right) or as double door. The use in vertical application is not recommended because there is no counter balance system available.
--------------	-------------------------------------	--



• Roller shutter slats sold separately

ROLLER SHUTTER RETROFIT DOORS



ROLLER SHUTTER FLIP DOOR 900 x 780

RRE707711001	Matt White	<ul style="list-style-type: none"> The Flip Door combines storage space and functionality beyond the ordinary. The material is low maintenance and easy to clean. The Flip Door is flush closing with no visible edges. The Flip Door is supplied fully installed into a matching MDF carcass / unit.
RRE707711014	Matt Black	
RRE707711016	Titanium	



ALUMINIUM ROLLER SHUTTER DOOR

RRE791629	600 x 1080mm	<ul style="list-style-type: none"> Timeless metallic look is an outstanding option for creative interior design. The material is low maintenance and easy to clean. The same applies for the frame profiles in cool aluminium finish, which complete the high quality look.
RRE791639	900 x 1080mm	
RRE774700	600 x 1544mm	
RRE774710	900 x 1544mm	



VETROLINE GLASS CASSETTE ROLLER SHUTTER DOOR 600mm x 1000mm

RRE789640	Clear	<ul style="list-style-type: none"> Using 50mm wide slats of safety glass, the Vetro-line creates a harmonious and two dimensional front. The safety glass withstands high loads, does not scratch and has a distinctive appeal due to its impressive translucent appearance and excellent surface flatness. The material is low maintenance and easy to clean. The same applies for the frame profiles in cool aluminium finish, which complete the high quality look.
RRE70561402	Black	
RRE70561403	White	
900mm x 1000mm		
RRE351023	Clear	
RRE70561602	Black	
RRE70561603	White	

ECONOMY WIRE WARE RANGE



PULLOUT SINGLE PANTRY FOR HINGED DOOR

530 x 385 x (1850 - 2150)

RTSW41005	<ul style="list-style-type: none"> • Suitable for installation in a 450mm unit • Unit includes 12 chrome baskets on height adjustable guides • Left or right hand installation • Height adjustable • Hinge recommendation: <ul style="list-style-type: none"> - use 175° hinges only - 4 hinges per MDF door - 5 hinges per SOLID door • Load Capacity: 65kg
-----------	--



For PULLOUT FRAME
6 per Pantry



CHROME BASKET for DOOR FRAME
6 per Pantry

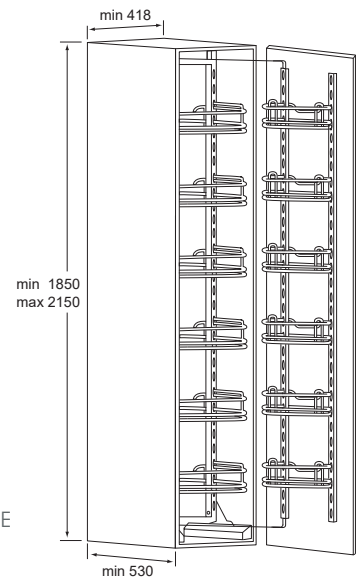

PULLOUT DOUBLE PANTRY FOR HINGED DOORS

530 x 790 x 1850 (1850 - 2200)

Code	Description
RTSW41006	<ul style="list-style-type: none"> • Suitable for installation in a 900mm unit • Unit includes 36 chrome baskets on height adjustable guides • Height - Fixed • Hinge recommendation: <ul style="list-style-type: none"> - use 175° hinges only - 4 hinges per MDF door - 5 hinges per SOLID door • Load Capacity: 85kg



CHROME BASKET for PULLOUT
FRAME
24 per Pantry



CHROME BASKET for DOOR
FRAME
12 per Pantry

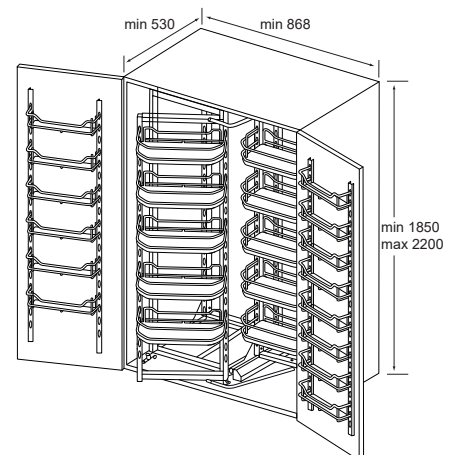

ECONOMY WIRE WARE RANGE



300MM PULLOUT PANTRY

450 x 240 x (1850 - 2200)

RTSW11309	<ul style="list-style-type: none"> • Full extension runner • Height adjustable • Included: 6 chrome baskets • Load capacity: 65kg
-----------	---

450MM PULLOUT PANTRY

500 x 395 x (1850 - 2200)

RTSW11339	<ul style="list-style-type: none"> • Full extension runner • Height adjustable • Included: 6 chrome baskets • Load capacity: 65kg
-----------	---

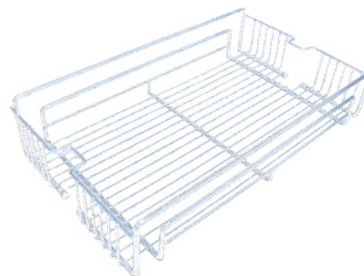

CHROME BASKET for PULLOUT FRAME
6 per Pantry

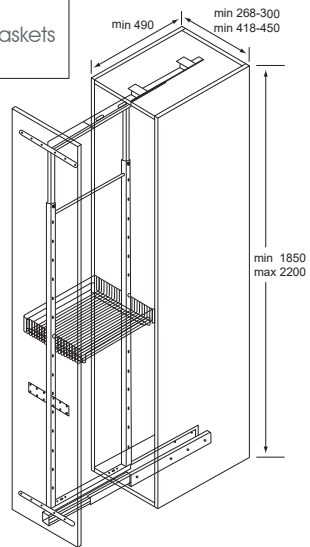

PULLOUT SPICE LARDER

Standard Bearing Runner

RTSW80150	500 x 145 x 580 - 200 Unit
RTSW80300	500 x 245 x 580 - 300 Unit

PULLOUT SPICE LARDER

Soft Closing Bearing Runner

RTSW200SOFT	500X145X580 - 200 Unit
RTSW300SOFT	500X145X580 - 300 Unit

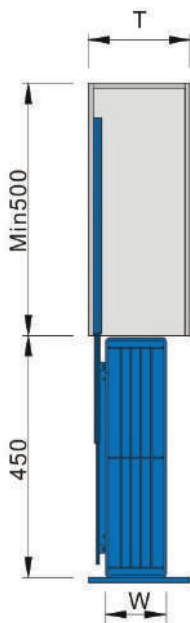

900MM MAGIC CORNER UNIT

Suitable For Installation In A 900mm Reach-In Unit
530 x 860 x 560

RTSW41008L	Left Opening
RTSW41008R	Right Opening

COMPAGNUCCI CHROME SOFT CLOSING RANGE



PULLOUT BASE SPICE LARDER

Chrome - soft closing

RCOMP332001150 150 UNIT - Left Hand	<ul style="list-style-type: none"> • Full extension runners with soft close system • Three-dimensional adjustment of the door • Total load capacity: 30 kg • Fixing position of the runners on the bottom of the cabinet Equipped with bottle holder dividers
RCOMP332S01200 200 UNIT - Left Hand	
RCOMP613005300 300 UNIT - Universal	



MAGIC CORNER

Chrome

RCOMP597D11L 900 Left hand	<ul style="list-style-type: none"> • Mechanism with high load capacity runner with soft-close • Three-dimensional adjustment of the door • Maximum load per basket: 9 kg (inner), 7 kg (outer) • The upper external basket can be adjusted in height • Installation depth: 485 mm • Installation height: 615 mm • Non-reversible product
RCOMP597S11R 900 Right hand	



>□<	W	K* (min-max)
450	380	860-1020

* K = cabinet internal width



PULLOUT PANTRY

Chrome

RCOMP526S05300 - 300 UNIT	<ul style="list-style-type: none"> • Full extension roller runners with soft close system • Three-dimensional adjustment of the door • Total load capacity: 120 kg • Maximum load per basket: 10 kg • Installation depth: 494 mm • Height adjustable 1700-1900
RCOMP526S11450 - 450 UNIT	



>□<	W
300	257
450	407

COMPAGNUCCI ORION DARK GREY SOFT CLOSING RANGE



RCOMP613HT05



RCOMP332HT05

PULLOUT BASE SPICE LARDER - ORION DARK GREY
Flat Wire

RCOMP332HT05	150 UNIT	<ul style="list-style-type: none"> • Full extension runners with soft close system • Three-dimensional adjustment of the door • Total load capacity: 30 kg on the right side or crossed • Installation depth: 480 mm • Installation height: 525 mm
RCOMP613HT05	300 UNIT	



HIGHLINE PULLOUT LARDER - ORION DARK GREY
1700-1900

RCOMP526001D	- 150 UNIT	<ul style="list-style-type: none"> • Full extension runners with soft close system • Three-dimensional adjustment of the door • Total load capacity: 120 kg • Maximum load per basket: 10 kg • Installation depth: 494 mm (504 mm for 520P) • Height adjustable 1700-1900
RCOMP52605D	- 300 UNIT	
RCOMP52611D	- 450 UNIT	



>□<	W
150	107
300	257
450	407

COMPAGNUCCI ORION DARK GREY SOFT CLOSING RANGE



GIRASOLO PULLOUT CORNET SHELVES

Orion Dark Grey

RCOMP721-11DL RCOMP721-11DR	- Left hand opening - Right hand opening	<ul style="list-style-type: none"> • Suitable for installation in a 900mm reach in unit • Mechanism equipped with soft-close and soft-open system as standard • Total load capacity: 40 kg • Maximum load per basket: 20 kg • Shelves can be adjusted in height • Installation height (min-max): 620-780 mm • Non-reversible product
--------------------------------	---	---



>□<	W	K*
450	410	860

* K = cabinet internal width



PULLOUT FULL EXTENSION BASKET

Orion Dark Grey

RCOMP48211DW450	450 UNIT	<ul style="list-style-type: none"> • Full extension runners with soft close system • Total load capacity: 30 kg • Installation depth: 490 mm • Installation height: 120 mm
RCOMP48215DW600	600 UNIT	
RCOMP48221DW900	900 UNIT	



>□<	W
450	414-418
600	564-568
900	864-868



PULLOUT UNDERSINK BASKET

Orion Dark Grey

RCOMP48519	800 UNIT	<ul style="list-style-type: none"> • Full extension runners with soft close system • Total load capacity: 30 kg • Installation depth: 490 mm • Installation height: 120 mm • Door brackets with three-dimensional adjustments available on demand
------------	----------	--



>□<	W
800	764-768

KITCHEN ACCESSORIES

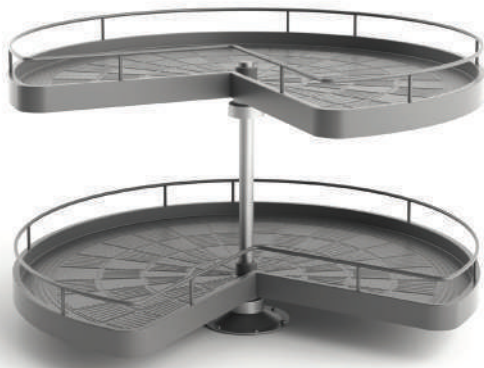

3/4 CAROUSEL
Dark Grey

RCOMP37580
2 Shelf

- Maximum load per shelf: 10 kg
- The product is connected to the bottom of the cabinet
- The shelves can be adjusted in height
- The shelves are equipped with a locking system in the closed position
- Installation height: 495 mm

Art.	W	K*
Ø80	360x360	900x900

* K = cabinet internal dimensions

1/2 MOON CAROUSEL
Dark Grey

RCOMP37875
2 Shelf

- Maximum load per shelf: 10 kg
- The product is connected to the vertical post of the cabinet
- The shelves can be adjusted in height
- The lower shelf can be connected to the door
- Installation height: 130 mm (for each shelf)
- Left/right reversible product

Art.	W	K*	D
Ø75	410	760	390

* K = cabinet internal width



ACCESSORIES - BEDROOM & BATHROOM

ACCESSORIES - BEDROOM & BATHROOM



APPLICATION FOR ALUMINIUM GUIDES

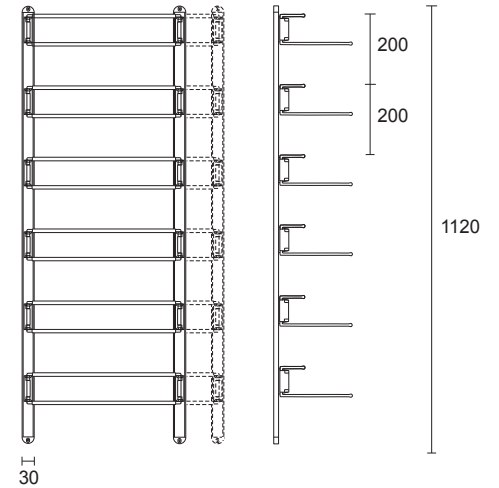

REAR FIXING

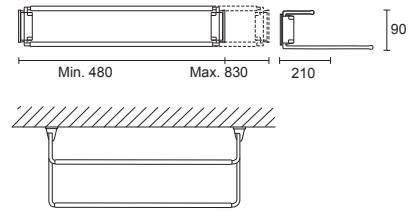

ALUMINIUM SHOE RACK GUIDE PER PAIR

Silver

RA117A (One pair required per rack)

TELESCOPIC SHOE RACK

Silver

RA111A Maximum of Six sets per rack



FIXED TIE AND BELT RACK

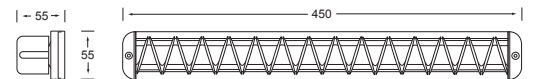

PULLOUT TIE AND BELT RACK

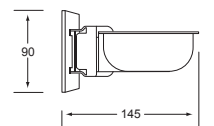
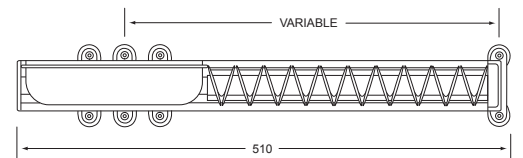

TIE AND BELT RACK - PULLOUT

Silver

RA142A Including Plastic Cuff-link Bowl
Closed Length - 510mm
Open Length - 920mm

TIE AND BELT RACK - FIXED

Silver

RA141A Length - 450mm

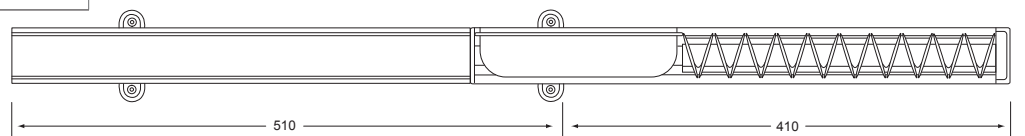

ACCESSORIES - BEDROOM & BATHROOM

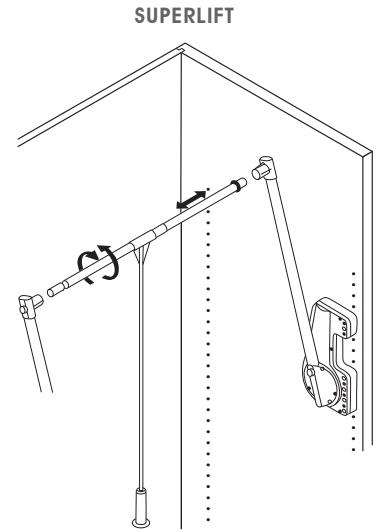

Minimum Cupboard width - 750
Maximum Cupboard width - 1150

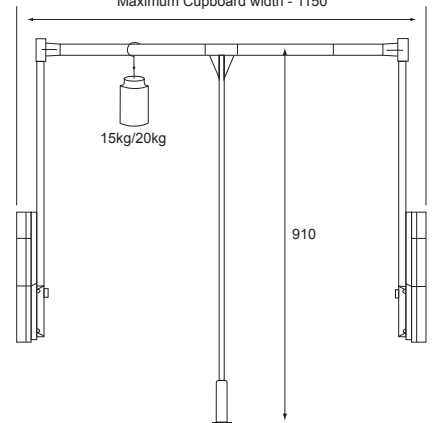

UPRIGHT REGULATING DEVICE

STRENGTH REGULATING DEVICE



20kg Unit



20kg Unit

WARDROBE CLOTHES LIFT

Superlift

RA151A Load capacity - 20kg

Standard Lift

RA700A Load capacity - 15kg
Stops in 90° position

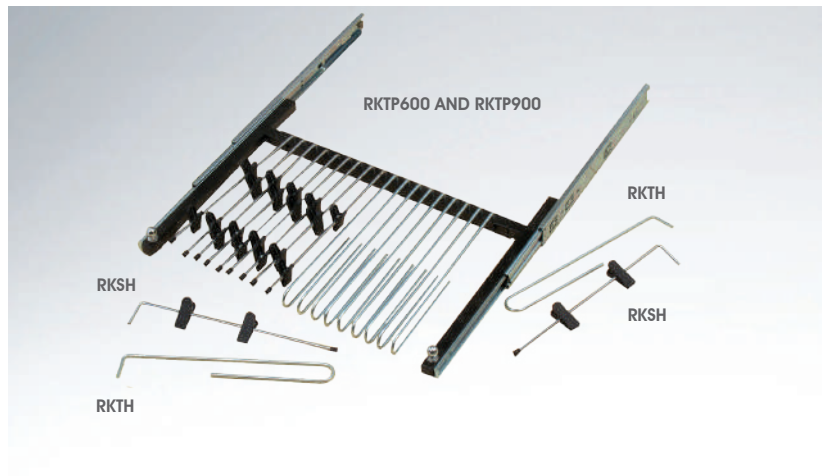

PULLOUT TROUSER/SKIRT RACK

RKTP900	Including Runners No Holders Suitable for 900mm unit Depth - 450mm Width - 868mm Load capacity : Combination of 25 Trouser/ Skirt rails
---------	---

PULLOUT TROUSER/SKIRT RACK

RKTP600	Including Runners No Holders Suitable for 600 unit Depth - 450 Width - 578 Load capacity - Combination of 16 Trouser/Skirt rails
---------	--

RKSH - Skirt Holder
RKTH - Trouser Holder

RKSH and RKTH
must be ordered and invoiced separately.

LAUNDRY AND BATHROOM BINS



PULLOUT LAUNDRY BIN (450)

R6LAB1580PL45 | 50L - White

D. 458
H. 504



TOT 50 L



10 min



450 mm



PULLOUT LAUNDRY BIN (600)

R6LAB1580PL60 | 80L - White

D. 458
H. 504



TOT 80 L



10 min



600 mm

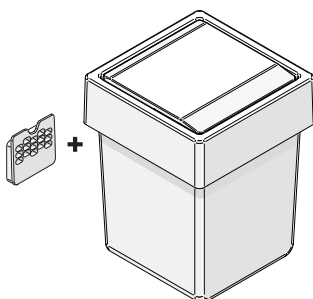

ONDA DOOR MOUNTED BIN 5 Litre

RONDABIN5LT | White

RONDABIN5LTORIO | Orion Grey

W. 174
D. 176
H. 229



TOT 5 L



2 min



ACCESSORIES - BEDROOM & BATHROOM

SINK CHANNEL (SYPH FLEX)

White

RSINKCHANNEL 240X135

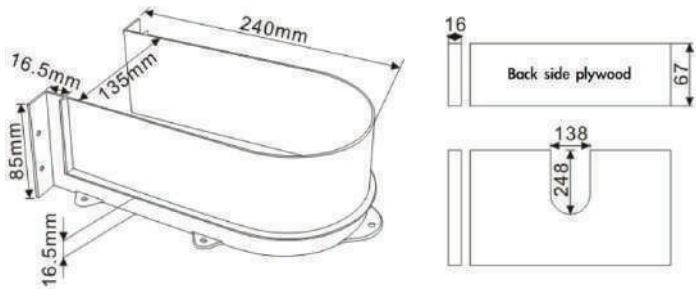

ONDA UNDERSINK VANITY TRAY

RONDAVTRAY

White

RONDAVTRAYORION

Orion Grey

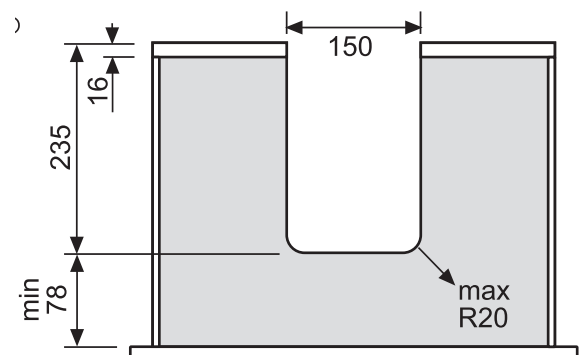
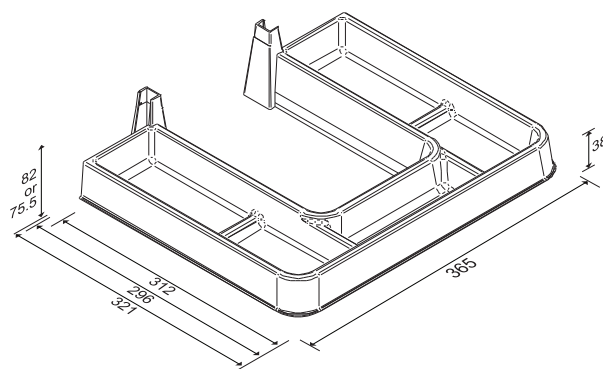

SHOE RACKS



PULLOUT SHOE RACK - CHROME 600mm

- | | |
|-------|---|
| RK600 | <ul style="list-style-type: none"> • Suitable for 600mm unit • Width - 568mm • Depth - 450mm • Height - 160mm • Includes 450mm Drawer Runner |
|-------|---|

PULLOUT SHOE RACK - CHROME 900mm

- | | |
|-------|---|
| RK900 | <ul style="list-style-type: none"> • Suitable for 900mm unit • Width - 868mm • Depth - 450mm • Height - 160mm • Includes 450mm Drawer Runner |
|-------|---|



Bottom and side mountable



ADJUSTABLE SHOE RACK 600 - 900 MM

RSHOESMALLGRY	Storm Grey
RSHOESMALLWHT	White
RSHOESMALLBLK	Black

ADJUSTABLE SHOE RACK 750 - 1100MM

RSHOELARGEGRY	Storm Grey
RSHOELARGEWHT	White
RSHOELARGEBLK	Black

PULL DOWN SHOE RACK

Black

- | | |
|-------|---|
| RK403 | <ul style="list-style-type: none"> • 3 Tier • Suitable for installation in units up to 1 metre in width |
|-------|---|



BARN DOOR SYSTEM

SLIDING BARN DOOR KIT

RHA01180	Single Door 2M - Black
RHA01180DB	Double Door 3M - Black



DOUBLE DOOR SYSTEM



SINGLE DOOR SYSTEM



DOUBLE DOOR SYSTEM



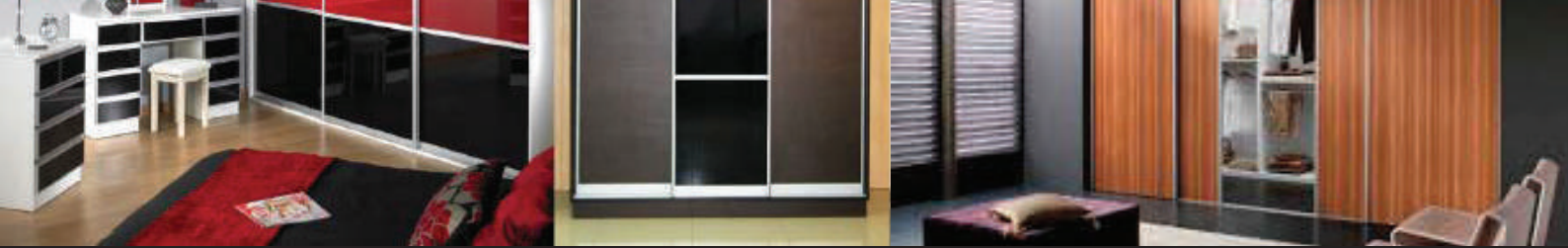

ALUMINIUM SLIDING DOOR SYSTEM



SLIDING DOOR UPPER TRACK

RLSD52689UG31	• 3m Length Natural Anodised		
RLSD52689UG31MB	• 3m Length Matt Black		
RLSD52689UG41	• 4m Length Natural Anodised		

SLIDING DOOR BOTTOM TRACK

RLSD52690BT31	• 3m Length Natural Anodised		
RLSD52690BT31MB	• 3m Length Matt Black		
RLSD52690BT41	• 4m Length Natural Anodised		

SLIDING DOOR TOP & BOTTOM PROFILE

RLSDBP69084	• 4m Length Natural Anodised		
RLSDBP69084MB	• 4m Length Matt Black		

SLIDING DOOR VERTICAL PROFILE

RLSDVPH13011	• 2.7m Length Natural Anodised		
RLSDVPH13011MB	• 2.7m Length Matt Black		

SLIDING DOOR VERTICAL GRIP PROFILE

RLSDVPHGRIP011	• 2.7m Length Natural Anodised	
----------------	-----------------------------------	---

SLIDING DOOR H PROFILE

RFSD603322004	• LXD3022 • 4m Length Natural Anodised	
---------------	--	---

ROLLER WHEEL SET FOR SLIDING DOOR

RFSD603100081	
• 1 Set needed per door	

SLIDING DOOR BRUSH PER METRE (Anti Slam)

RFSD603100250	
---------------	---

SLIDING DOOR GASKET (GLASS DOORS) Clear

RFSD603100027	
• 2.7m Length • Used with 5mm safety Glass	

SOFT CLOSING MECHANISM

For Aluminium Sliding Door System



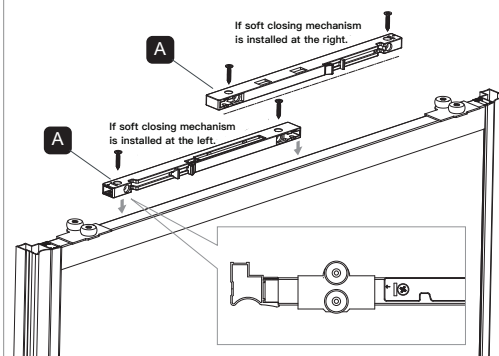
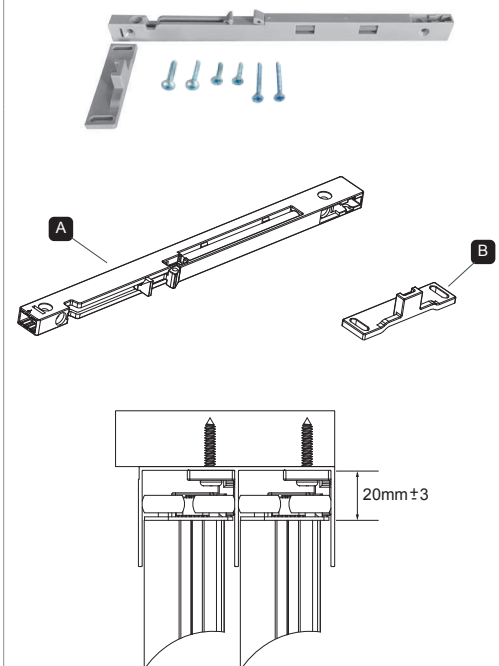

RFSDMECHANISM

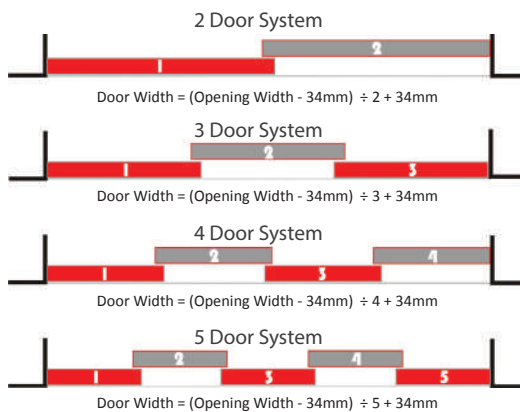

CALCULATING DOOR WIDTH

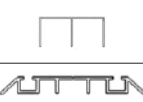

CALCULATING CUTTING SIZES FOR THE PROFILES:

Upper Guide & Bottom Track		Opening Width 1mm
Vertical Profile		Opening Height 33mm
Top & Bottom Profile		Door Width 68mm
H-Profile		Door Width 68mm

DOMINO SLIDING DOOR SYSTEM

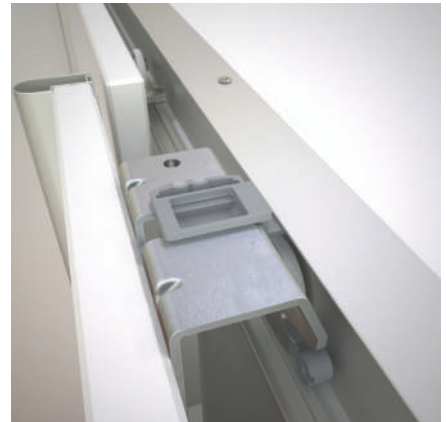
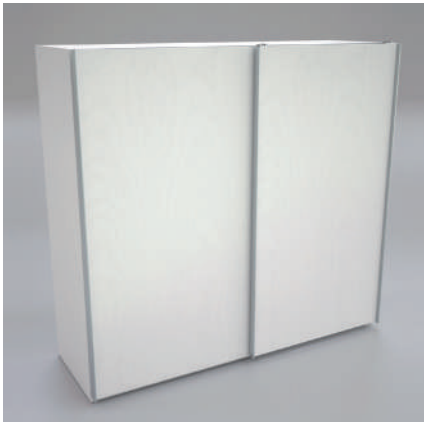

DOMINO SLIDING DOOR SYSTEM

- Top hung system
- Solution for 2 & 3 sliding doors
- Integrated safety stops and anti-lift features
- Door weight up to 50kg
- Easy and rapid assembling with optional EasyFix door brackets

True to their motto, "value for many", FGV have designed a state of the art sliding door solution, The Domino. Both materials and components used are chosen for their ability to deliver perfect functioning at an affordable price. The different components of the system are easy to assemble. Safety stop and anti-lift features are an integral part of the design.

Domino

**BETTER ACCESS
BETTER LIVING**

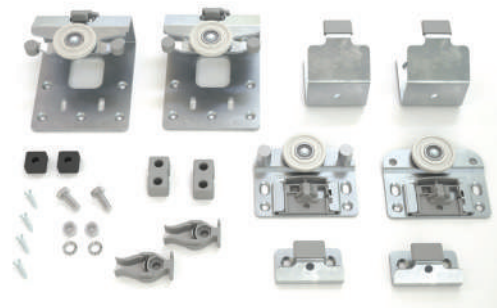
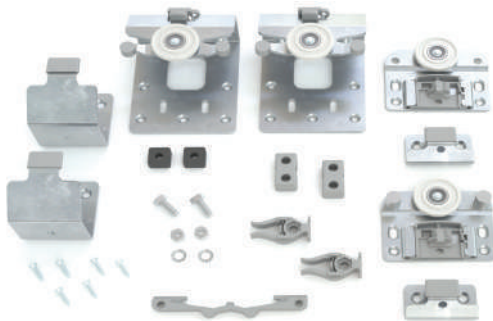

DOMINO SLIDING 3 DOOR KIT

Door Thickness = 16-21mm

RF590DM307000R0

Kit contains:

- 2 top ball bearing rollers for external door (central)
- 4 top ball bearing rollers for internal door, equipped with slowmotion activator
- 2 bottom gliders for external door
- 4 bottom gliders for internal doors
- 2 lateral door stops for application without slowmotion
- 2 lateral door stops for slowmotion solution
- 1 central door stop for application without slowmotion
- 2 stabiliser blocks to straighten the top profile
- 2 bottom stops
- 2 sets of plastic brackets for slowmotion fixing Fittings and slowmotion's fixing screws assembly instruction.

DOMINO SLIDING 2 DOOR KIT

Door Thickness = 16-21mm

RF590DM207000R0

Kit contains:

- 2 top ball bearing rollers for external door, one of which is equipped with slowmotion activator
- 2 top ball bearing rollers for internal door, equipped with slowmotion activator
- 2 bottom gliders for external door
- 2 bottom gliders for internal door
- 2 lateral door stops for application without slowmotion
- 2 lateral door stops for slowmotion solution
- 2 stabiliser blocs to straighten the top profile
- 2 bottom stops
- 2 sets of plastic brackets for slowmotion fixing Fittings and slowmotion's fixing screws assembly instruction.

RF590DMB0AS3000

DOMINO TOP ALUMINIUM RAIL
3M



RF590DMB0AI3000

DOMINO BOTTOM ALUMINIUM RAIL
3M

