

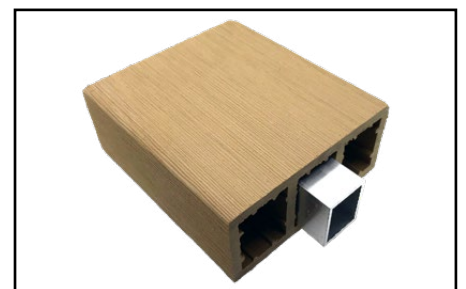

*materia infinita*<sup>®</sup>

# DATASHEET

REV\_04/22



## NOVOWOOD LOUVERS

## TECHNICAL DATA

STANDARD LENGTHS	3000 mm - 4000 mm
THERMAL EXPANSION COEFFICIENT	0,04 mm/m/°C
WATER ABSORPTION (ASTM D1037)	1,2% (unsanded) 3,5% (sanded)

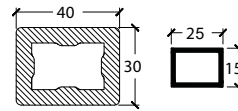

SUNSHADE INFINITY 30 + ALUMINIUM BAR 25x15

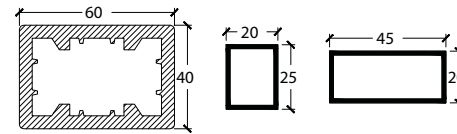

SUNSHADE INFINITY 60 + ALUMINIUM BAR 20x25 AND 45x20

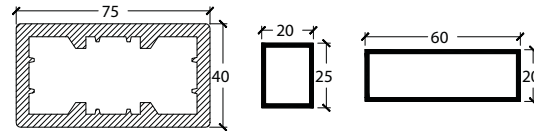

SUNSHADE INFINITY 75 + ALUMINIUM BAR 20x25 AND 60x20

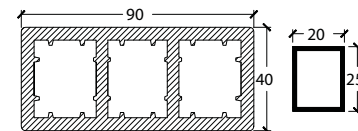

SUNSHADE INFINITY 90 + ALUMINIUM BAR 20x25

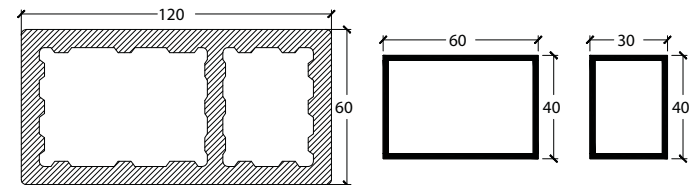

SUNSHADE INFINITY 120 + ALUMINIUM BAR 60x40 AND 30x40

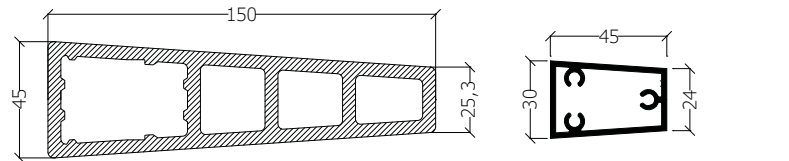

SUNSHADE INFINITY 150 WING + ALUMINIUM BAR 45x30

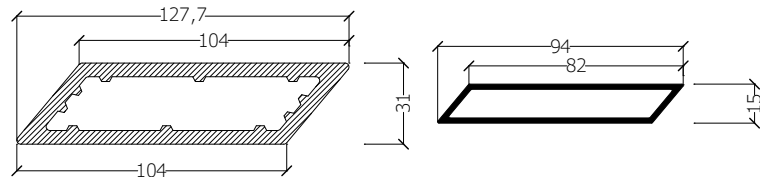

SUNSHADE INFINITY T 100 + ALUMINIUM BAR 82x15

## INSTALLATION AND GENERAL INFORMATION

INSTALLATION METHOD	- Single laths attached with screws or an invisible fastening system eg. Novofix. - Pre-assembled panels
MAXIMUM SUBSTRUCTURE SPACING	- max. 1500 mm with a stiffening core present
MAXIMUM LATERAL OVERHANG OF THE LATH	≤ 250 mm
SUNSHADE/SUBSTRUCTURE INSTALLATION	- Novofix System: see technical specification "Novofix system".  - Through screw: pre-drilled hole in composite 6 mm wider than the screw to allow the material to expand.
LAYING SIDE	either side
CUTTING	YES, with WIDIA cutting blade.
DISTANCE BETWEEN HEAD LATHS	≥ 6 mm (to be checked depending on the temperature).
GLUING	NO
RAINWATER RUNOFF	Position the profiles at a slight angle or drill holes in the bottom of the profile to allow rainwater to drain away.

**N.B. The spacing of the substructure and the distance between the sunshade laths will be evaluated by the designer according to the project specifications.**

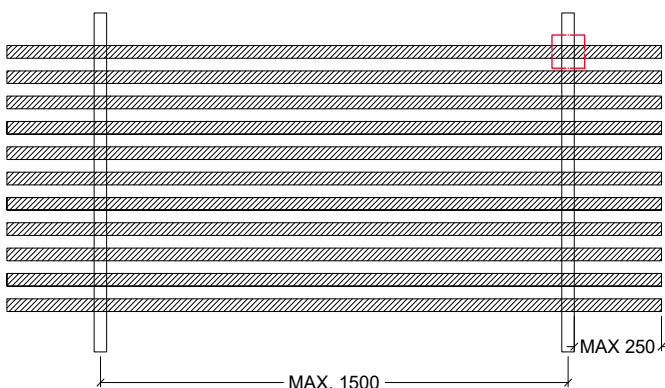

SIDE VIEW  
SUNSHADE LAID ON 40mm SIDE WITH 40+40 GAP

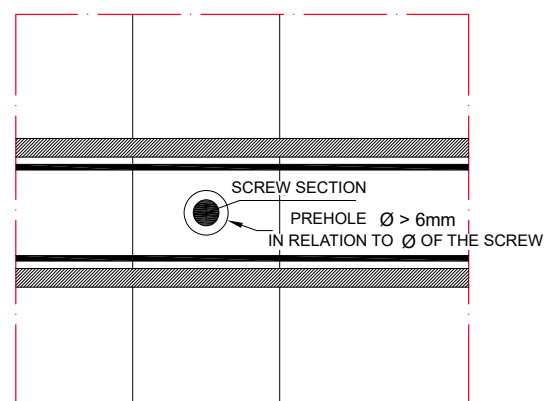

SCREW AND PREHOLE DETAIL

THE AIM OF THIS DOCUMENT IS TO PROVIDE OUR CLIENTS WITH GENERAL RECOMMENDATIONS. IPERWOOD EXPRESSLY RECOMMENDS THAT OUR CLIENTS AND/OR DESIGNERS USE THE CONSULTANCY SERVICES OF AN ENGINEER OR DESIGNER QUALIFIED IN TERMS OF THE SPECIFIC APPLICATION AND INSTALLATION, AS WELL AS IN TERMS OF COMPLIANCE WITH THE PROJECT REQUIREMENTS, APPLICABLE CODES AND CURRENT REGULATIONS AND LEGISLATION, AND TESTING REGULATIONS AND STANDARDS. IN ALL CIRCUMSTANCES PLEASE CHECK CURRENT LOCAL CODES AND PROJECT REQUIREMENTS TO ENSURE THEIR CORRECT APPLICATION

## INSTRUCTIONS FOR CORRECT USE

To ensure durability, it is necessary to follow these instructions on the correct use of sunshade. Novowood wood plastic composite is constituted of approximately 65% wood and approximately 25% high density polyethylene and, therefore, requires special but simple handling to avoid problems related to the improper use of the profiles.

### ALUMINIUM STIFFENING CORE



Each profile, as required, has 1 aluminium alloy stiffening core of a suitable diameter with respect to the cavity of the profile that is supplied in the same length of the sunshade. It is advised to reduce the length of about 50mm less than that of the sunshade, to allow the housing of the sealing plugs (if present). The stiffening core should be placed within the central cavity (laying on the largest side of the profile) or the cavity closest to the substructure (laying on the smaller side) in order to ensure fixing onto the metal profile. In Infinity 60 and 75 profiles it is possible to insert the 20x25 core in the two options shown in Image 1 below, according to the side on which the sunshade is fixed. In special situations, the correct positioning of the stiffening core must be evaluated, see Novofix fixing.

Any changes in size or type must be communicated in writing during the order settlement phase.

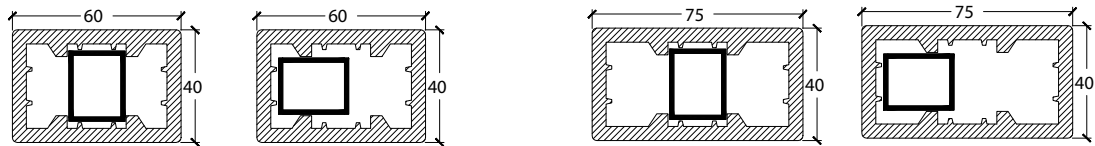

*Image 1 - Options of insertion of the 20x25 aluminium core in Infinity 60 and Infinity 75*

### MAXIMUM SPACING OF THE SUBSTRUCTURE [max. 1500mm]

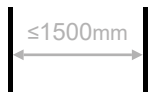

Inflection of the sunshade should be avoided by positioning the substructure struts with a maximum spacing of 1,500 mm.

### MAXIMUM LATERAL OVERHANG OF THE PROFILE [max. 250mm]

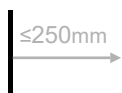

To avoid weakening or excessive inflection in the projecting part, the overhang should not exceed 250 mm.

### FIXING SUNSHADE - SUBSTRUCTURE



To allow the natural expansion of wood plastic composite (expansion index equal to 0.04 mm/m/°C) it is necessary to create a prehole on the sunshade profile, 6mm bigger than the screw size.

### DISTANCE BETWEEN HEAD LATHS [≥ 6 mm]



To allow the natural expansion of wood plastic composite (expansion index equal to 0.04 mm/m/°C) a distance of  $\geq 6$  mm must be left between the head sunshades. This figure is relative and depends on the temperature on the day the sunshade is installed. For installation during warmer months, the distance between the heads will be minimal as the material will be in a position of maximum expansion, on the other hand, in winter, the distance should be greater.

### VENTILATION OF THE SUNSHADE



The intrinsic nature of wood plastic composite means that it requires adequate ventilation. To meet this requirement, the sunshade should be kept in areas that are not in direct contact with wet surfaces nor soaked in water.

### RAINWATER RUNOFF



Water stagnation inside the profiles must be avoided by installing them at a slight angle or by drilling holes in the bottom to drain off any water that may build up inside the profiles. The hole should be drilled in the middle section of two struts (maximum theoretical inflection point). There must always be an airspace between the sunshade and the rear surface.

## SEALING PLUGS



Each plug should be applied to the profile with a special adhesive, if removed it will need to be reapplied. If the sunshade is installed vertically, water drainage holes must be drilled on the lower plug.

## HUE VARIATIONS OF DIFFERENT LOTS



Novowood is a wood plastic composite produced by extrusion, therefore it is possible to have little hue variations between different lots produced. It is advisable to lay the material picking up staves from different pallets.

## MAINTENANCE AND CLEANING

Novowood wood plastic composite does not require special maintenance and it is easy to clean thanks to the studied combination of fibres, polymers and additives. In order to reduce the accumulation of residues on the surface it is advised to monthly wash the Wood Plastic Composite with cleaning products (supplied on request) and in order to maintain the warranty it is necessary to provide at least one annual cleaning with "WPC Cleaner" (supplied on request). If you use the pressure washer, keep the nozzle at a distance of 30 cm from the floor.

The accumulation of organic material on the surface, with the passage of time, may form localised moulds which can be removed using hot water and "WPC Cleaner". If moulds, algae and fungi have settled for a long time, often the material needs further treatment.

However, the inconvenience can be reduced by keeping the decking clean, dry and ensuring good ventilation.

In order to remove localized stains it is advisable to use a special spray "WPC stains remover" (supplied upon request) which may produce a slight hue change in the intervention area.





**NOVOWOOD**  
HEADQUARTER  
Via E. da Rotterdam, 29  
44122 Ferrara (FE)

+39 0532 732737  
info@novowood.it

---

[www.novowood.it](http://www.novowood.it)