

Maxi II eco Egg Incubator
Operating Manual

Brinsea
Incubation Specialists

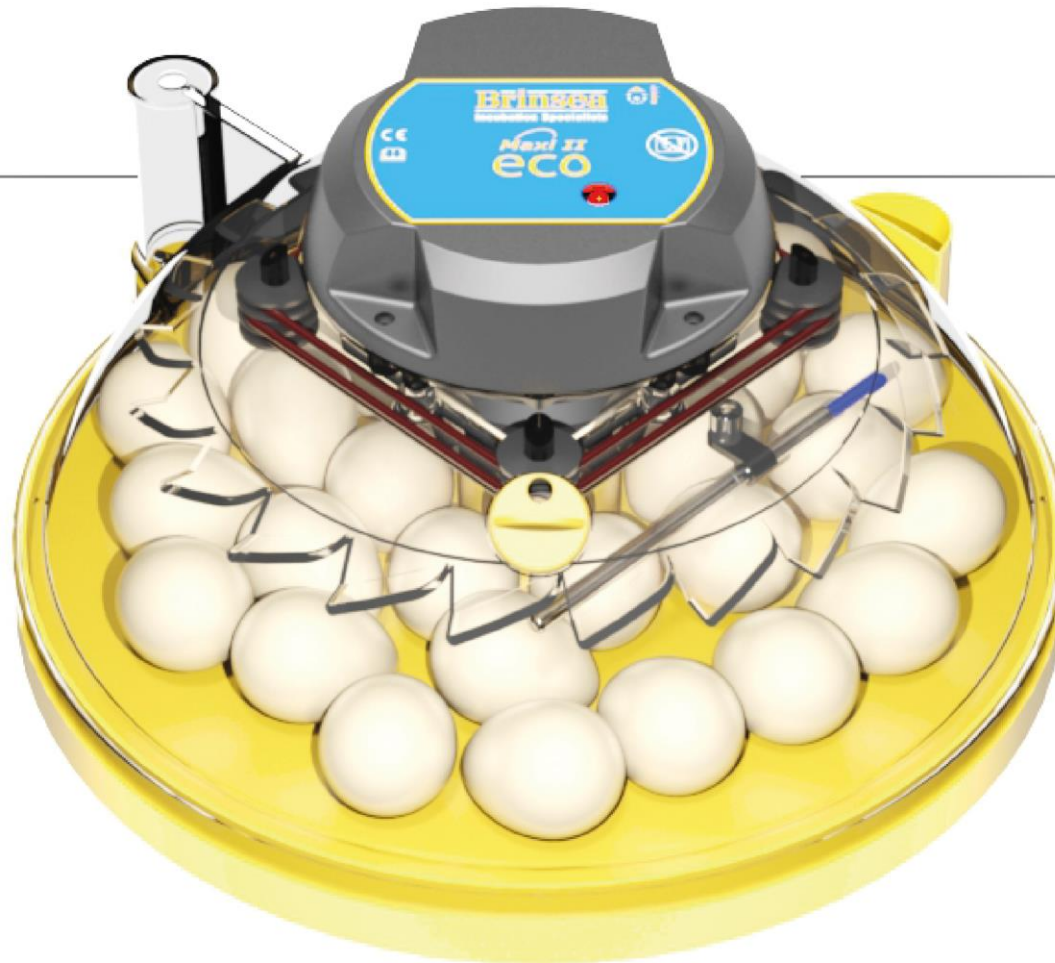



Read the instructions before use!



Do not cover!

This appliance is only to be used with the power supply unit provided with the appliance.

Damaged appliances must not be used.

The appliance, its power supply unit and its supply cord must be placed in an indoor area not subject to splashes of water or wet conditions and protected from or out of reach of animals.

Repairs must be carried out only by a suitably qualified person.

This appliance must not be used, cleaned or maintained by children or persons with reduced physical, sensory or mental capabilities or lack of experience and knowledge without supervision. Children must not play with the appliance.

Disconnect the incubator from the mains power supply during cleaning. Ensure that all electrical parts are kept dry.

Please read these instructions carefully before setting up your incubator to achieve best results and keep these instructions safe for future reference.

This document includes recommended procedures for successful hatching but incubation involves the control and manipulation of a large number of factors and in certain circumstances different procedures may be necessary.

For more detailed information on all aspects of egg incubation including helpful advice on getting best results please visit our website at www.brinsea.co.uk.

Your incubator is designed to allow the user to vary the incubation conditions to suit a wide range of species in different ambient conditions and the specific set-up for every situation is beyond the scope of these instructions.

For more information on incubation and hatching please download our FREE Incubation Handbook: www.brinsea.co.uk/incubationhandbook, for more species specific advice a range of publications can be found at: www.brinsea.co.uk/books.

To register your new Brinsea product please visit www.brinsea.co.uk within 30 days of purchase and follow the link on the home page to qualify for your free 3 year guarantee. Sign up for the Brinsea Newsletter to receive the latest news and information.

Record your appliance serial number here: _____



CONTENTS

- 1 Setting Up Your Incubator** -
- Unpacking & Part Quantities 4
- Assembly 5
- Location & Installation 6

- 2 Product Introduction – Functional Features** 7
- 5 Temperature** 8
- 6 Humidity** 9
- 7 Eggs** 11
- 9 Hatching & Cleaning up** 12
- 10 Specifications** 13



1 SETTING UP YOUR INCUBATOR

UNPACKING & PART QUANTITIES

Your incubator has been supplied in protective packaging. Please remove all tape, strapping and packing from the incubator and parts. Retain the carton and packing materials to enable the unit to be repacked.

Check that your electrical supply matches that marked on the power supply unit.

The diagram shows all the parts that have been supplied to you. Ensure you have the correct quantities of each part. If there are any parts damaged or missing please contact your retailer or Brinsea Products (at the address at the end of the document). **Damaged appliances must not be used.**

- 1: Temperature Adjustment Screwdriver
- 2: Rear Cover
- 3: Top
- 4: Water Pot Guard
- 5: Base
- 6: Hatching Mat
- 7: Power Supply Unit (not shown in diagram)

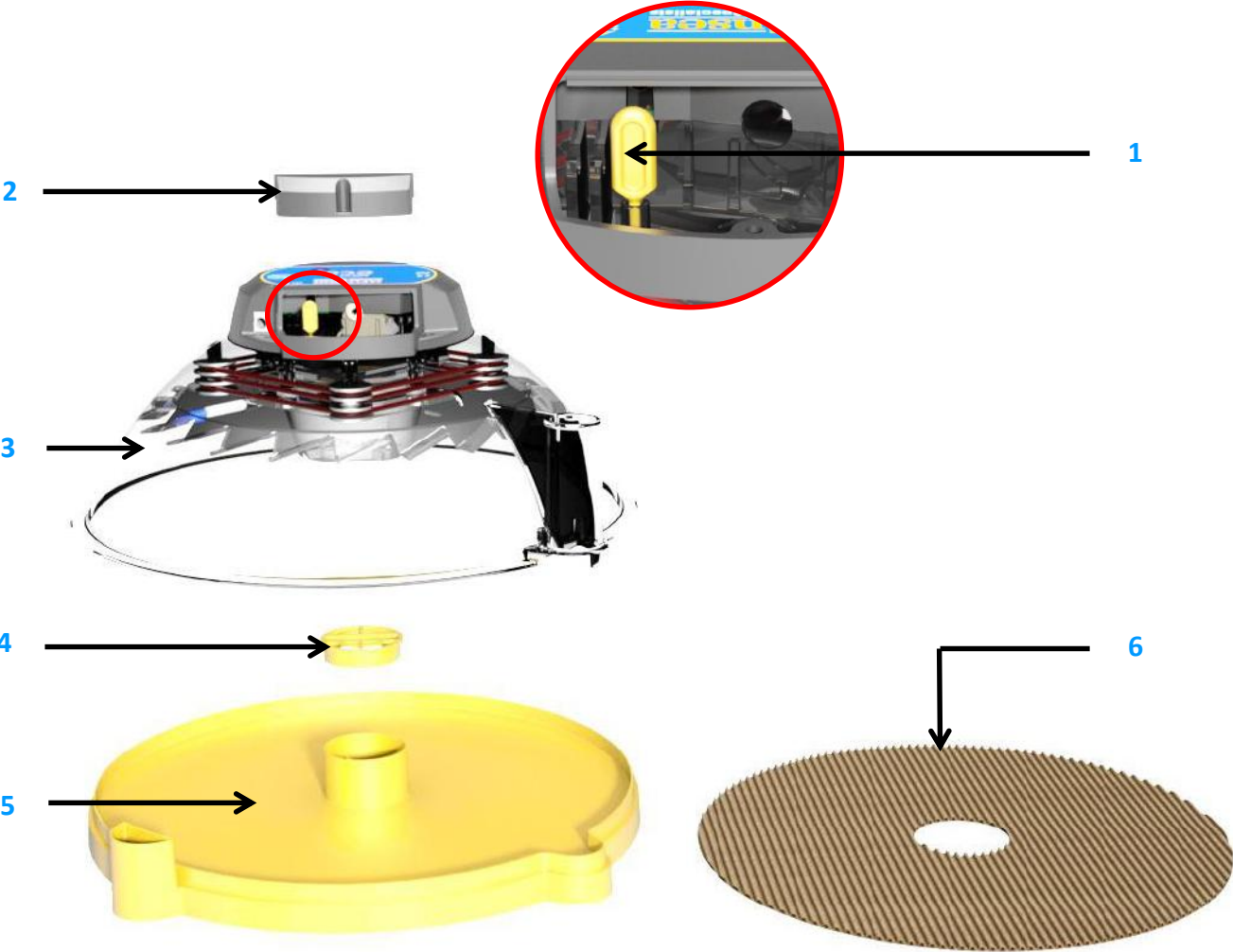

Maxi II eco

1 SETTING UP YOUR INCUBATOR

ASSEMBLY

1: Fit the water pot guard to prevent chicks from drowning.

2: Place the top onto the base. Check the top fits flush all the way around the base edge.

1.

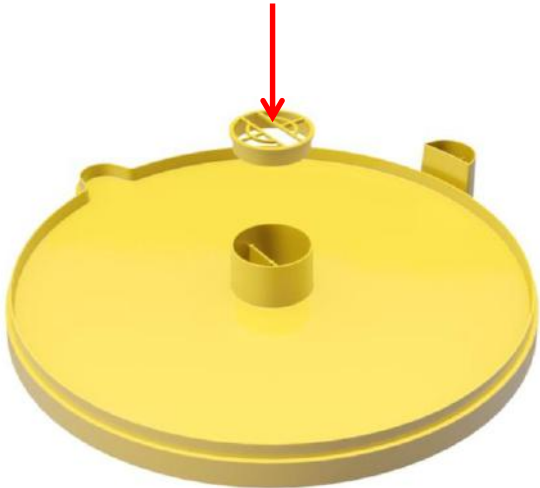

2.

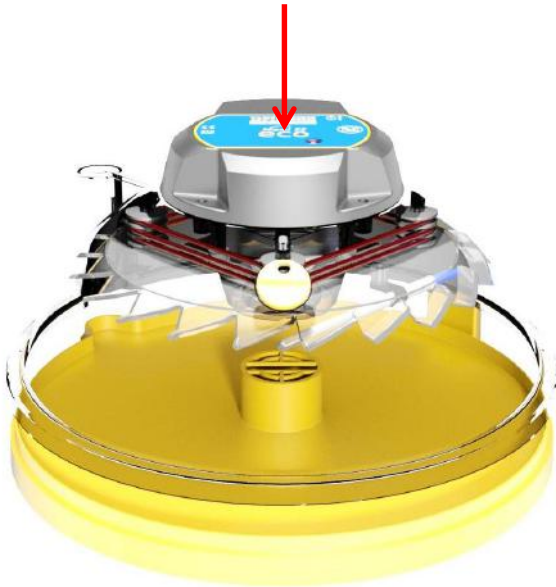

Maxi II eco

1 SETTING UP YOUR INCUBATOR

LOCATION AND INSTALLATION

Your incubator will give best results in a heated room free from wide temperature variations and with generous ventilation – particularly if several incubators are running at the same time.

Ensure that the room temperature cannot drop on a cold night. Ideally thermostatically control the room at between 20 and 25°C (68 and 77°F). Never allow the room temperature to drop below 17°C (63°F).

Make sure that the incubator cannot be exposed to direct sunlight and is used on a flat, level surfaced worktop or table, not on the floor.

Connect the mains power cable to the power supply unit and connect the power supply unit cable to the incubator lid. Ensure each connector is pushed fully home in its socket.

Only use the power supply unit supplied with the product. Use of a different power supply may cause a hazard and will invalidate any guarantee.

1.

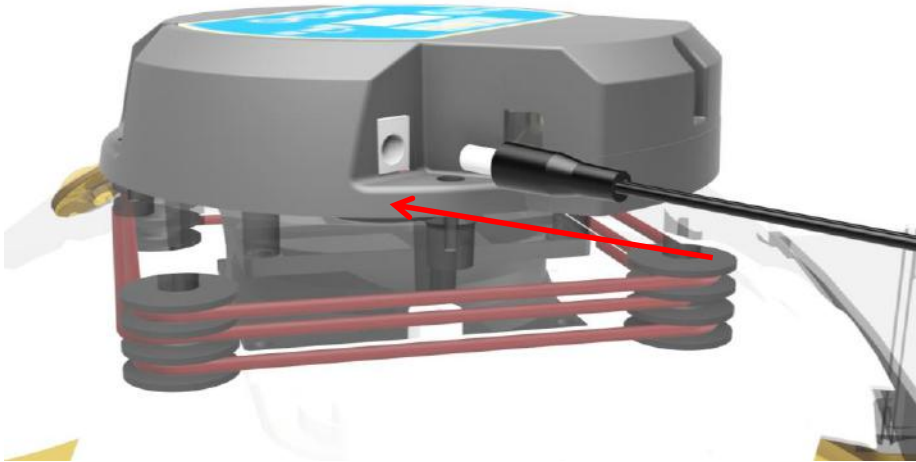

2.

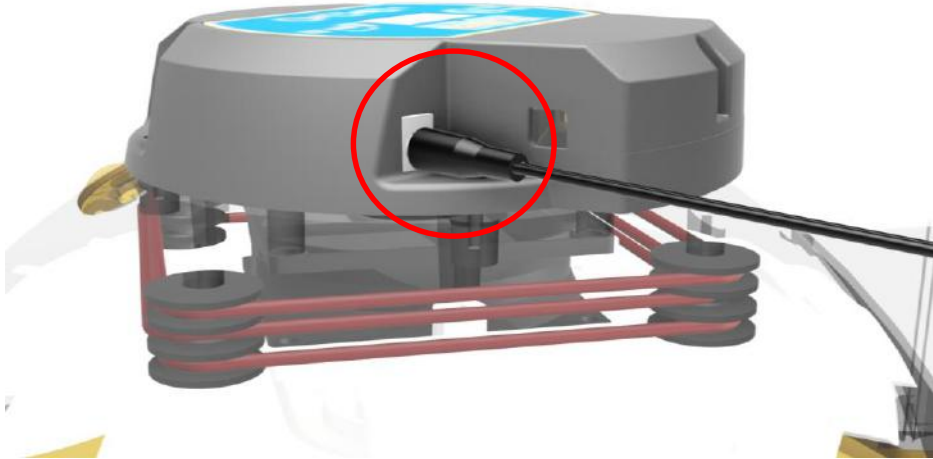

FUNCTIONAL FEATURES

- 1: Heater indicator LED
- 2: Temperature Adjuster (Inside Rear Cover) See section 5.
- 3: Adjustable Air Vent
- 4: Spirit Thermometer
- 5: External Fill Point

Example settings for poultry:

Temperature: 37.5°C

Humidity: Fill one side of the central water pot, set vent to minimum

Turning interval: 3 times per day

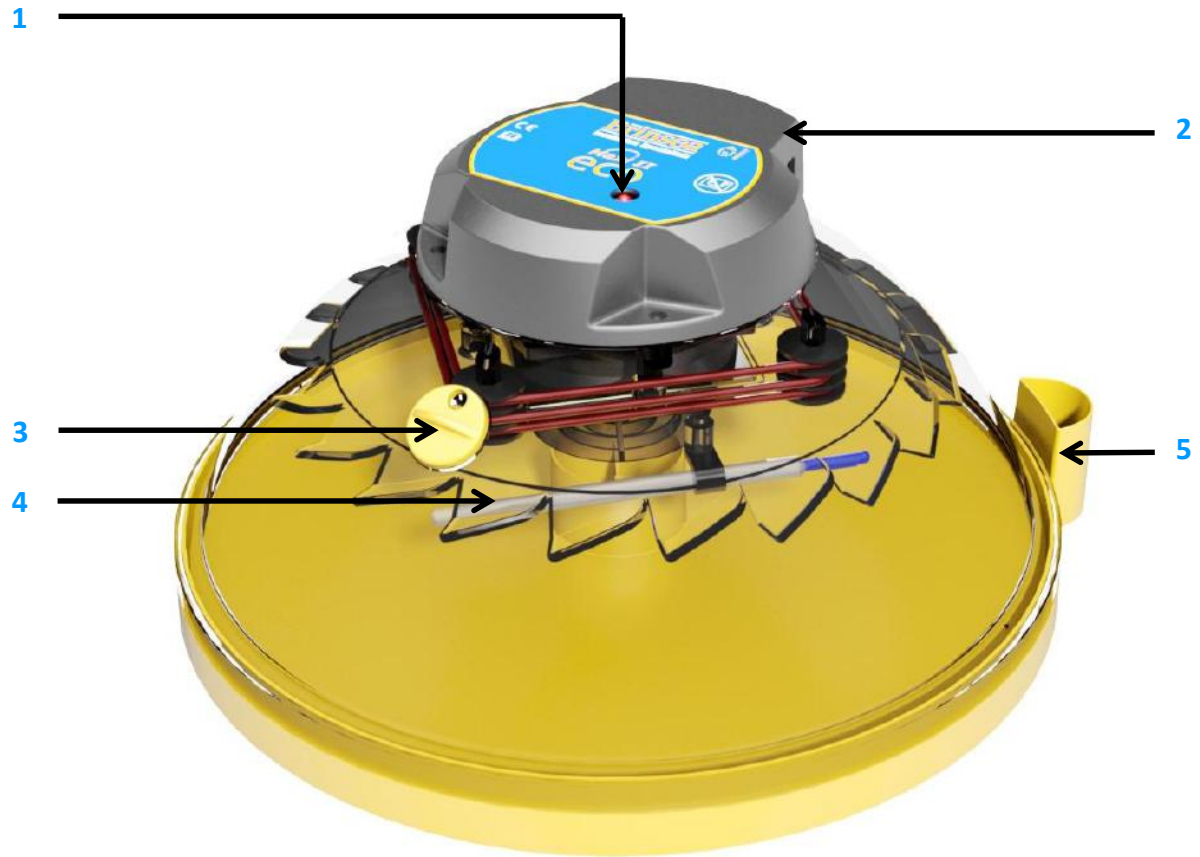

Maxi II eco

5 TEMPERATURE

SETTING THE TEMPERATURE

Stable and correct temperature is essential for good results. Adjust with care.

Your incubator has been factory set to the correct temperature for most species (37.4 – 37.6) but it is advisable to check the temperature and follow this procedure:-

1: As the incubator warms up and approaches its control setting the red LED will change from continuously on to flashing. Allow the incubator to stabilise for at least an hour before adjusting the temperature.

2: Gently insert the temperature adjustment screwdriver into the adjuster screw hole and turn it until it engages in the screw slot. Do not force an inappropriate screwdriver into the housing, it may damage the adjustment unit and invalidate the guarantee.

Turn clockwise to increase temperature, anticlockwise to reduce it. ¼ of a turn is approximately 2 degrees Celsius (4 Fahrenheit). Make very small adjustments and allow time for the temperature to stabilise between adjustments.

Refer to the thermometer to check temperature. Adjust temperature with care – small differences have large effects on hatching performance.

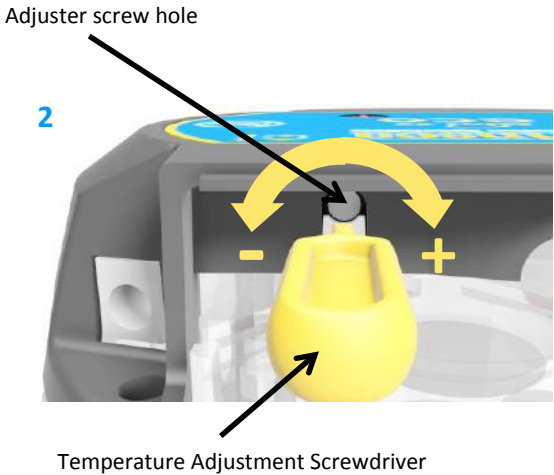
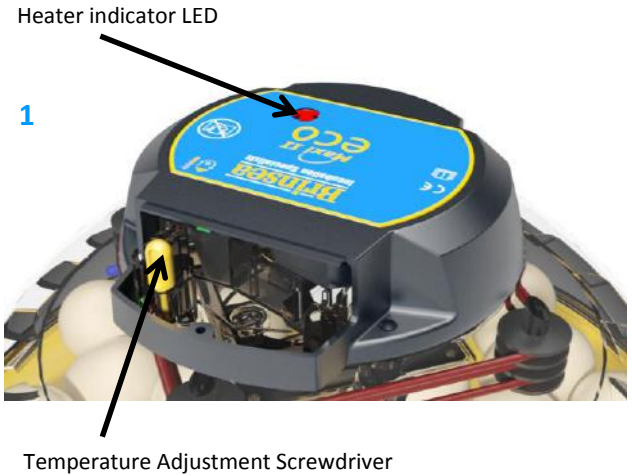

	Recommended temperatures:		Typical incubation period:
Hens	37.4 – 37.6°C	99.3 – 99.6°F	21 days
Pheasant	37.6 – 37.8°C	99.6 – 100.0°F	23-27 days
Quail	37.6 – 37.8°C	99.6 – 100.0°F	16-23 days
Ducks	37.4 – 37.6°C	99.3 – 99.6°F	28 days

- Developing embryos are fairly tolerant of short term temperature drops and the user need not be concerned about cooling that occurs when inspecting eggs. Temperatures above ideal can quickly have a serious detrimental effect on hatch rates and must be avoided.

UNDERSTANDING HUMIDITY

Short term variations in humidity are not important. The average humidity over the incubation period needs to be near optimum to achieve the ideal weight loss.

High humidity for the day or two of hatching is also important. Beware chronic, excessive humidity.

Typical Humidity:

Generally accepted incubation RH levels for species groups:

During incubation: Poultry	40-50% RH
Waterfowl	45-55% RH
Hatching: All species	65% RH or more

Typical Weight Loss:

Typical ideal weight losses for species groups:

Poultry	13%
Waterfowl	14%

For more specific information on particular species' requirements check the relevant literature.

CONTROLLING HUMIDITY

Two factors affect incubation humidity: water evaporation within the cabinet (from eggs as well as from additional water) and levels of ventilation. The water content of the air being drawn through the incubator will also have an effect.

There are two methods available to bird breeders to achieve correct humidity levels:

1: As a general guide for poultry/game/waterfowl, maintain water in one of the two halves of the central water pot from the time eggs are set until 2 days before hatching is due - the depth of water doesn't matter.

For all species fill both halves of the water pot for the last two days of incubation. Higher humidity levels are needed for hatching to prevent membranes drying too quickly. Ensure the water pot guard is fitted to prevent chicks drowning.

The above guidelines make no provision for different ambient conditions and are necessarily rather generalised but they are simple and often effective.

2: Monitor egg weight loss (which varies as a direct result of humidity) and correct them against published weight loss figures for the species. This is the most reliable method and is recommended – particularly where poor hatch rates are experienced or if eggs of high value are being incubated.

Eggs lose moisture through their shells and the rate of evaporation depends on the humidity levels around the eggs and the shell porosity. During incubation eggs need to lose a fixed amount of water which corresponds to a loss in weight of around 13-16% depending on species. By weighing eggs periodically during incubation it is possible to monitor and, if necessary, correct humidity levels to achieve the correct weight loss.

HATCHING

In all cases the humidity for hatching needs to be high. Because of the short duration involved water/weight loss will not be significantly affected. High humidity is necessary to prevent membranes drying and hardening before the hatch fully emerges. Humidity will naturally increase as the first eggs begin to hatch and internal membranes begin to dry. This effect is in addition to the increased area of water evaporation from the water pots. During hatching the high humidity levels will fall dramatically when the lid is opened and will take some time to build up. Resist the temptation to lift the lid frequently – leave for at least 6 hours between inspections.

For more detailed information on all aspects of egg incubation including helpful advice on getting best results please visit our website at www.brinsea.co.uk/incubationhandbook.

Maxi II eco

6 HUMIDITY

SETTING THE RELATIVE HUMIDITY LEVEL: USING THE EXTERNAL FILL POINT

The humidity in the incubator can be adjusted by adding water to one or both halves of the central water pot. (If you want to decrease humidity don't add water).

The Maxi II has an external water fill point allowing the water level to be checked and filled up without removing the top of the incubator.

To fill the first half of the water pot, carefully add water to the external fill point. Keep the water level below the depth mark (see picture). The water will flow through the tube and fill one half of the central pot.

To increase humidity further, fill both halves of the central water pot by continuing to add water to the external fill point to above the level of the depth mark. Water will flow through the tube and over the divider wall to fill the second half of the pot. Maintain the water level above the depth mark.

ADJUSTING THE VENT

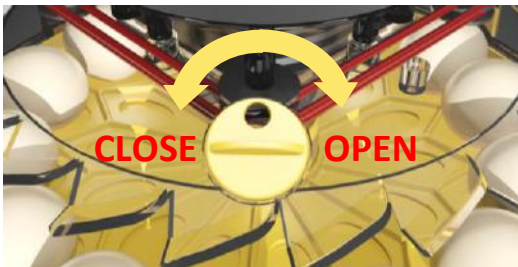

Opening and closing the vent: Close the vent to increase humidity or open the vent to decrease humidity.

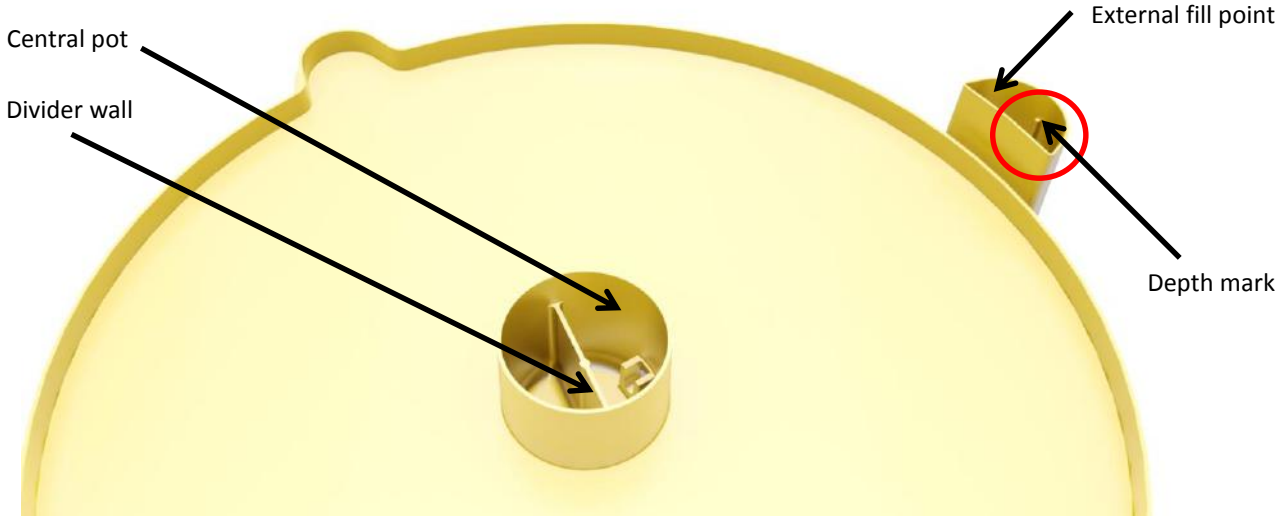

In practice the minimum and maximum levels of humidity achievable in an incubator depend upon several factors including the ambient conditions in the incubation room. You may need to allow 24 hours for humidity to fully stabilise after making changes.

If you cannot achieve the relative humidity level required consider these notes:

Humidity will not go low enough

- Open the vent fully to help.
- A lower limit will be determined by the moisture content of the ambient air, particularly in warm humid conditions. This can only be countered by dehumidification of the room air outside the incubator with a proprietary dehumidifier but is rarely a problem in practice.

Humidity will not go high enough

- Close the vent to its minimum setting to help. Fit evaporating card strips available from Brinsea or your stockist.

Condensation

It is normal for some condensation to occur on the cooler exposed parts of the clear top. This natural phenomenon is not a hazard or a problem for incubation but may indicate the room is cooler than optimum.

Maxi II eco

7 EGGS

EGG TURNING

Mark each egg with a pencil "X" one side and "O" the other. This ensures that you can see which eggs you have turned. Turn three times a day starting on the second day.

Always turn about the pointed end to reduce the chance of damaging the internal structures of the egg.

EGG STORING

Ensure that you store eggs in cool, damp conditions. Most species may be safely stored for up to 14 days before serious reductions in hatch rates are likely. Daily turning of stored eggs also helps maintain hatchability.

Discard cracked, mis-shaped and heavily soiled eggs (if possible). Only wash soiled eggs using a branded egg wash solution such as Brinsea Incubation Disinfectant Concentrate following the manufacturer's instructions. It is essential to wash eggs in solution which is significantly warmer than the egg. Bear in mind that all solutions will remove the outer cuticle from the egg as well as the dirt and may leave the egg at greater risk from bacterial contamination in the future.

EGG SETTING

Before setting eggs ensure that the incubator has been running for several hours and has stabilised at the correct temperature.

The Maxi II Eco is designed to accommodate eggs of different sizes up to duck eggs. Some experimentation may be necessary to maximise capacity.

Set the eggs at least 2cm in from the edge of the incubator base so that they are clear of the "skirt" of the lid when it is fitted.

Once the eggs have been set the temperature must not be adjusted for 24 hours to allow the eggs to warm. Check the water level every 3 days or so and temperature daily. Candle the eggs after 1/3rd of the incubation period has elapsed to reject clear, infertile eggs.

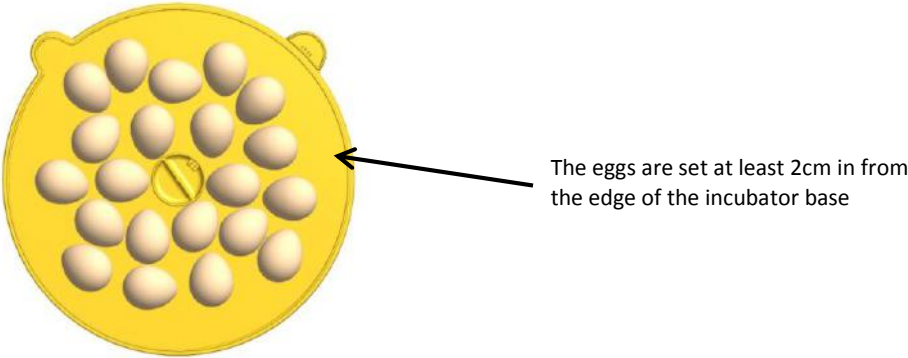

Maxi II eco

9 HATCHING & CLEANING UP

HATCHING

1: If hatching in the Maxi II, remove the top of the incubator.

2: Insert the hatching mat into the base two days before the hatch is due. Lay the eggs directly onto the mat. Don't re-use hatching mats. Replacements are available from brinsea.co.uk, brinsea.com or your local stockist (product code 14.902).

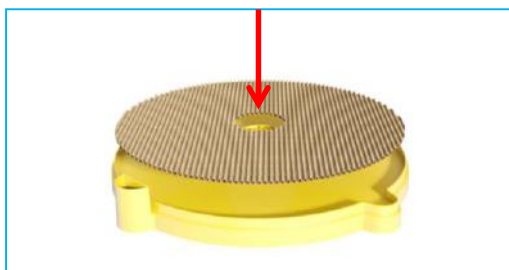

3: Put the top back on.

Hatching humidity levels need to be high (see section 6 above). Fill both halves of the central water pot.

When most eggs have hatched (12 to 48 hours after the first egg hatches) remove the hatchlings to a brooder. The Brinsea EcoGlow 20 and 50 are ideal for poultry and waterfowl etc. The Brinsea TLC-40 and TLC-50 Brooders are recommended for exotics.

During hatching the high humidity levels will fall dramatically when the lid is lifted and will take some time to build up. Resist the temptation to open the incubator frequently – leave for at least 6 hours between inspections.

CLEANING UP

IMPORTANT:

DISCONNECT THE INCUBATOR FROM THE MAINS POWER SUPPLY DURING CLEANING.

ENSURE THAT ALL ELECTRICAL PARTS ARE KEPT DRY. DO NOT IMMERSE THE INCUBATOR TOP.

NEVER WASH THE BASE, COVERS OR CABINET PARTS IN LIQUIDS OVER 50°C (120°F). DO NOT USE A DISHWASHER TO CLEAN ANY PARTS OF THE INCUBATOR.

Following each hatch in the Maxi II Eco wash the base in Brinsea Incubation Disinfectant Solution and then rinse thoroughly. Use a vacuum cleaner and soft brush to remove dust from the fan guard. Wipe all other internal surfaces with a cloth made damp with the solution and then wipe off with a cloth made damp with clean water. Ensure that the instructions supplied with the fluid are followed.

If a separate hatcher is used the procedure above should still be followed every two months.

The exterior of the incubator may be cleaned with a damp cloth. Avoid allowing any moisture to get inside electrical housings.

Periodically unscrew the four screws retaining the fan guard, remove the cover and soak. Dust and fluff may be removed from the fan and heater cord with a soft brush. USE NO LIQUIDS. DO NOT TURN THE LID OVER AS THE FAN IS NOT FIXED ONCE THE FAN COVER IS REMOVED. The fan must be located on the 4 pegs under the lid with its label facing into the lid before the cover is re-fitted. DO NOT OVER-TIGHTEN THE SCREWS.

ALWAYS CLEAN THE INCUBATOR BEFORE STORAGE AND ENSURE THAT THE UNIT IS TOTALLY DRY INSIDE AND OUT. ALLOW IT TO RUN FOR 24 HOURS WITH NO WATER IN TO ENSURE IT IS THOROUGHLY DRY.

TROUBLE-SHOOTING AND CALIBRATION

In case of failure first check that the mains power supply is working and that the cable connector is fully engaged in the socket on the control enclosure.

Please contact Brinsea directly at sales@brinsea.co.uk for further information and advice.

Maxi II eco

10 SPECIFICATIONS

MAXI II MAXIMUM SETTING CAPACITIES:

Egg size	Typical capacity
Quail	90
Pheasant	54
Hen	30
Duck	20

Dimensions:	354mm x 354mm x 165mm
Weight:	1.384 Kg
Power Consumption:	
Incubator maximum (typical average)	40 Watts 24 Watts
Electrical Supply:	100 - 240v, 50/60Hz, 1.3A max.

30 hen eggs

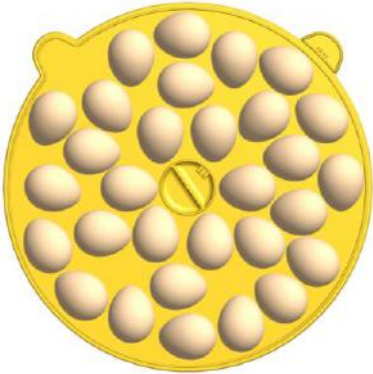

90 quail eggs

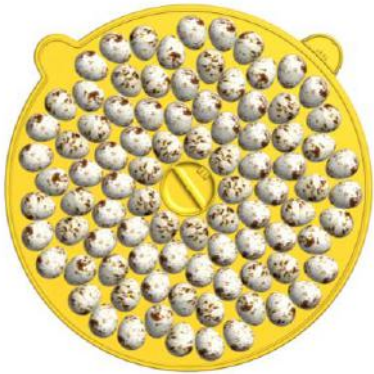

20 duck eggs

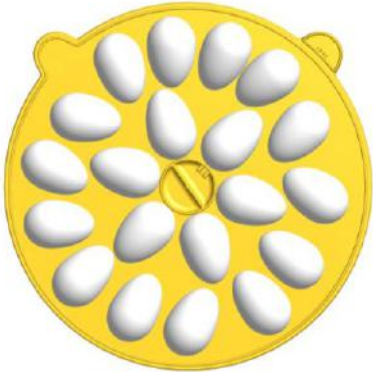

54 pheasant eggs



Used electrical and electronic products should not be mixed with general household waste. For proper treatment, recovery and recycling, please take this product to a designated collection point where it will be accepted free of charge.

Please contact your local authority for further details of your nearest designated collection point.

Disposing of this product correctly will help save valuable resources and prevent any potential negative effects on human health and the environment, which could otherwise arise from inappropriate waste handling.

DECLARATION OF CONFORMITY

We: BRINSEA PRODUCTS LTD.
32-33 Buckingham Road
Weston Industrial Estate
Weston-super-Mare
North Somerset
BS24 9BG

Declare under our sole responsibility the products:

Egg Incubators:

Maxi II Eco (Serial numbers AC25x/xxxxxxxxx)
Maxi II Advance (Serial numbers AC26x/xxxxxxxxx)
Maxi II EX (Serial numbers AC27x/xxxxxxxxx)

to which this declaration relates are in conformity with the following EU Directives:

2006/42/EC Machinery Directive
2014/30/EU Electromagnetic Compatibility Directive
2011/65/EU Restriction on the use of Certain Hazardous Substances in Electrical and Electronic Equipment Regulations

The relevant sections of the following Standards have been used:

EN 60335-1:2012+A11:2014
EN 60335-2-71:2003+A1:2007
EN 55014-1:2006+A2:2011
EN 55014-2:2015
EN 50581:2012

The technical documentation for the products is available from the above address.

Authorised Representative: Ian Pearce, Managing Director

Signature:

Date of Issue: 8th September 2016

Place of Issue: 32-33 Buckingham Road, Weston Industrial Estate, Weston-super-Mare, North Somerset, BS24 9BG, United Kingdom.

Registered Community Design Application No 003007103

Brinsea Products Ltd, 32-33 Buckingham Road, Weston Industrial Estate,
Weston-super-Mare, N. Somerset, BS24 9BG
Tel: +44 (0) 845 226 0120 Fax: +44 (0) 1934 708177
e-mail: sales@brinsea.co.uk, website: www.brinsea.co.uk