

Liquid Freezer III 280 A-RGB

Multikompatibler All-in-One CPU-Wasserkühler mit A-RGB



Allgemeine Spezifikationen

Kompatibilität	Intel® LGA1700 AMD® AM5, AM4
PI NNPI	319 259
Wärmeleitpaste	MX-6 (0,8g)
Garantie	6 Jahre
Betriebsumgebungstemperatur	0-40°C
Gewicht	1765g
LED-Anschluss	3-Pin-A-RGB-Buchse

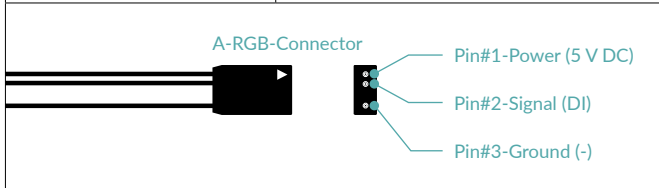

All-In-One-Anschluss	4-Pin-PWM-Buchse
----------------------	------------------

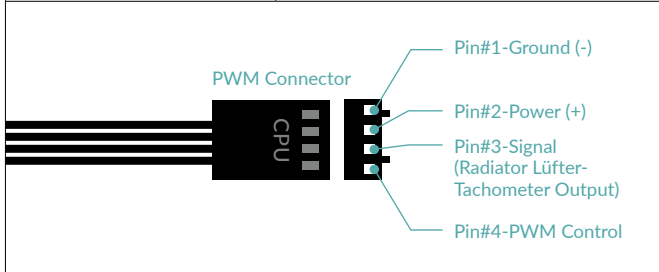

Geteilter Anschluss	3x 4-Pin-PWM-Buchse
---------------------	---------------------

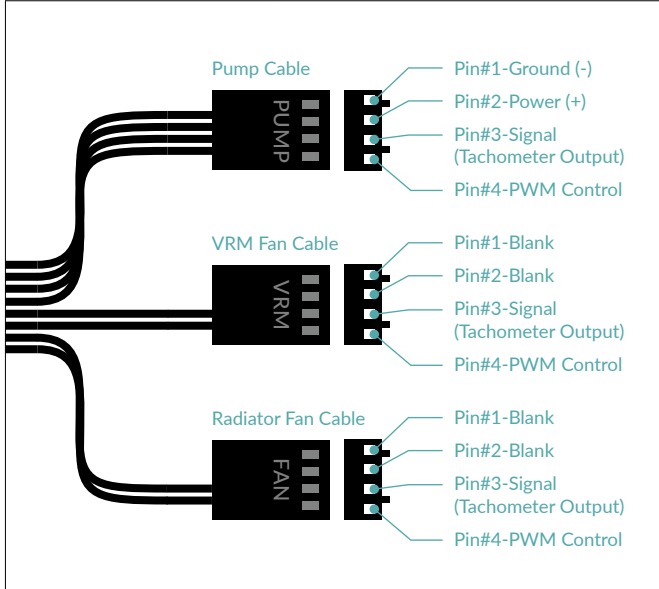

Pumpe	800-2800rpm (PWM-gesteuert)
Strom Spannung	0,35A 12V DC
Cold Plate	Kupfer, Micro-Skived-Fins
Schlauchlänge	450mm
Schlauchdurchmesser	Äußerer: 12,4mm Innerer: 6,0mm
Radiator	
Material	Aluminium
Abmessungen	317 (L) x 138 (B) x 38 (H) mm
VRM-Modul	
VRM-Lüfter	400-2500rpm (PWM-gesteuert)
Strom Spannung	0,05A 12V DC
LEDs	12x A-RGB LEDs
Strom Spannung	0,40A 5VDC

Radiatorlüfter-Spezifikationen

Allgemein	2x P14 PWM A-RGB
Geschwindigkeit	200-1900rpm
Luftstrom	69,90cfm 117,06m³/h
Statischer Druck	2,0mmH₂O
Lager	Hydrodynamisches Gleitlager
Strom Spannung	0,17A 12V DC
Kabellänge	40mm
Anschluss	4-Pin-PWM-Buchse
RGB-Spezifikationen	
LEDs	12x A-RGB LEDs
Strom Spannung	0,40A 5VDC
Kabellänge	40mm + 80mm Splitter-Kabel
Anschluss	3-Pin-A-RGB-Buchse + 3-Pin-Stecker

Versandinformationen - LF III 280 A-RGB (Black)

Box Abmessungen	335 (L) x 170 (B) x 155 (H) mm
Brutto Gewicht	2300g
SKU	ACFRE00143A
EAN	4895213704519
UPC	840033402286

Versandinformationen - LF III 280 A-RGB (White)

Box Abmessungen	335 (L) x 170 (B) x 155 (H) mm
Brutto Gewicht	2300g
SKU	ACFRE00151A
EAN	4895213704557
UPC	840033402323

Liquid Freezer III 280 A-RGB

Multikompatibler All-in-One CPU-Wasserkühler mit A-RGB

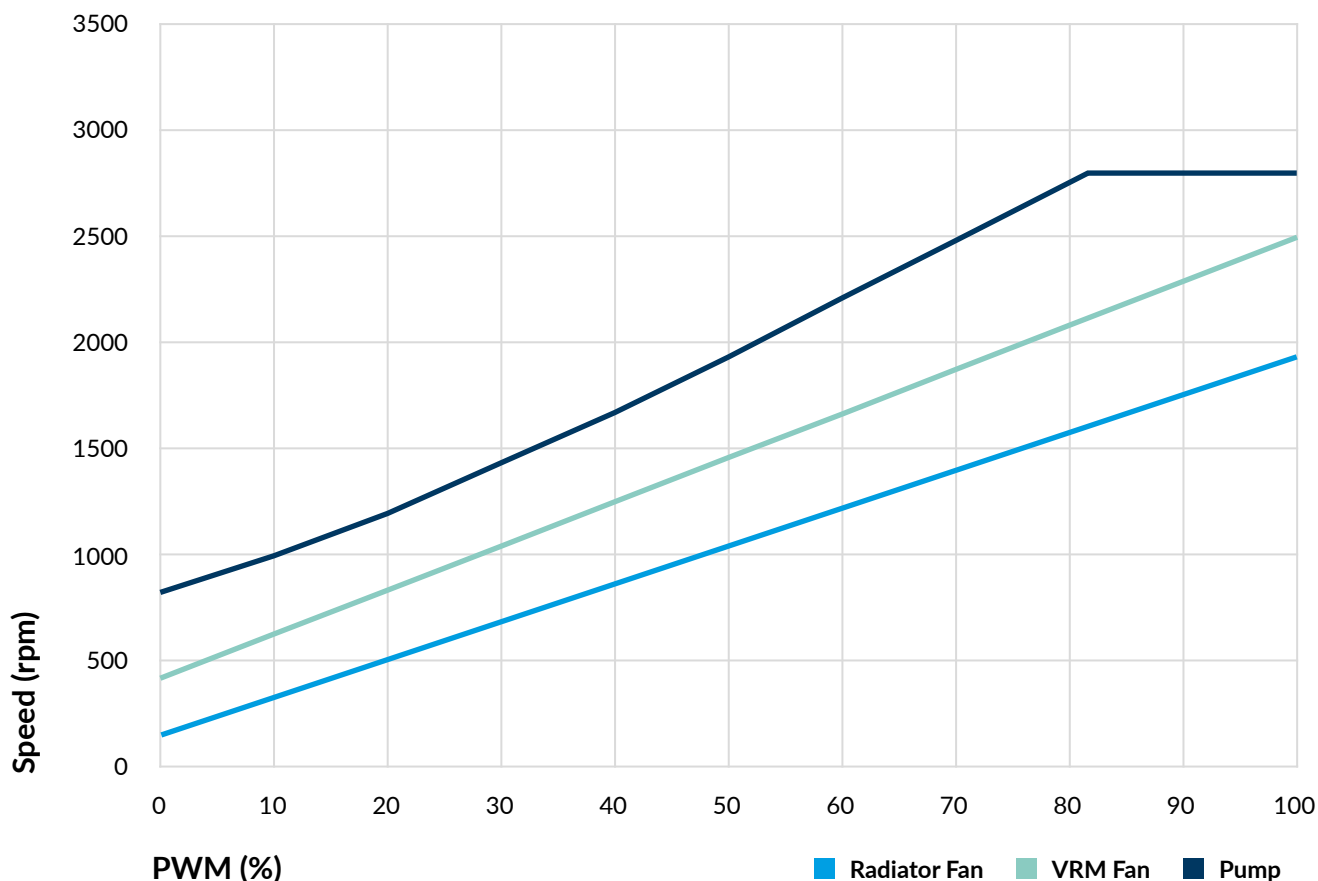

Liquid Freezer III 280 A-RGB

Multikompatibler All-in-One CPU-Wasserkühler mit A-RGB

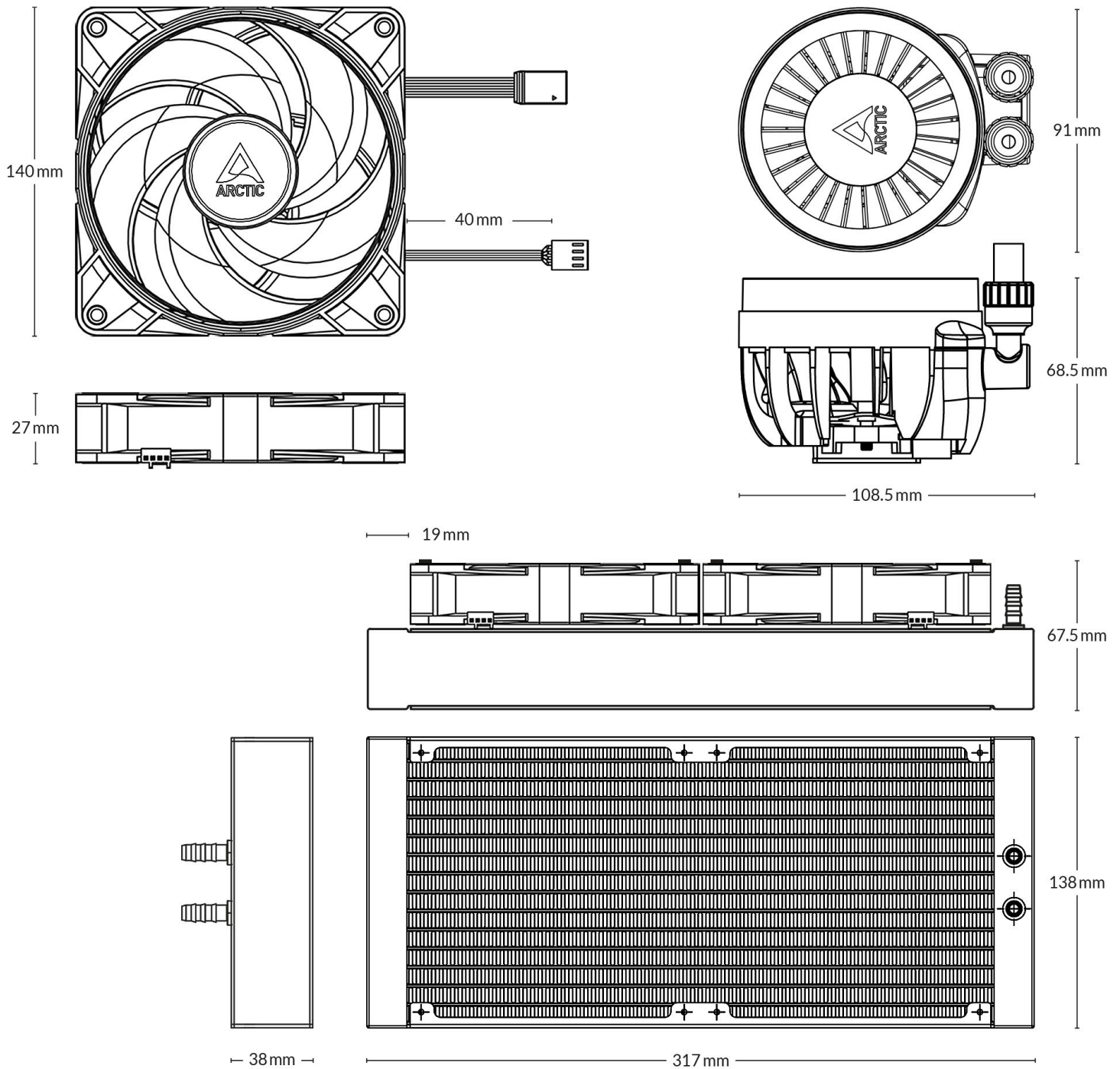

Alle Materialien sind mit den RoHS-Anforderungen kompatibel.

WEITERE INFORMATIONEN



ANLEITUNGEN

